

SIMADYN D Digital Control System

User Manual

EP3/EP3.1 Signal Processor

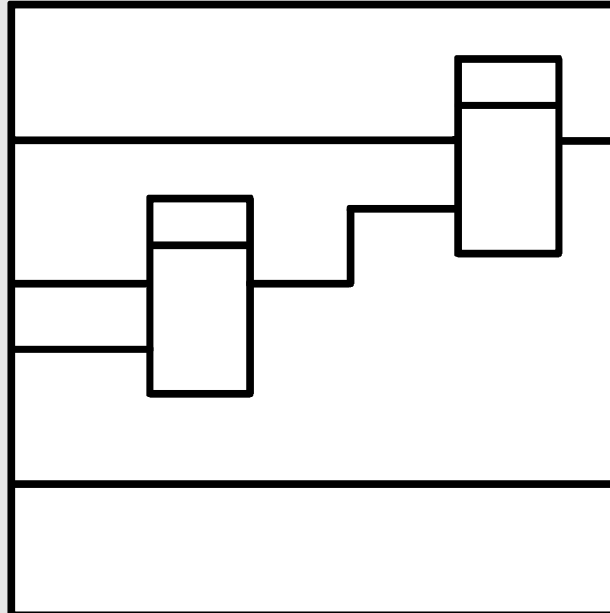

User Manual, EP3/EP3.1 Signal Processor Module

Edition		Status
1	EP3/EP3.1 Signal Processor Module	02.96
2	EP3/EP3.1 Signal Processor Module	03.98

Weitergabe sowie Vervielfältigung dieser Unterlage, Verwertung und Mitteilung ihres Inhalts nicht gestattet, soweit nicht ausdrücklich zugestanden. Zuwiderhandlungen verpflichten zu Schadenersatz. Alle Rechte vorbehalten, insbesondere für den Fall der Patenterteilung oder GM-Eintragung.

Wir haben den Inhalt der Druckschrift auf Übereinstimmung mit der beschriebenen Hard- und Software überprüft. Dennoch können Abweichungen nicht ausgeschlossen werden, so daß wir für die vollständige Übereinstimmung keine Garantie übernehmen. Die Angaben in dieser Druckschrift werden jedoch regelmäßig überprüft und notwendige Korrekturen sind in den nachfolgenden Auflagen enthalten. Für Verbesserungsvorschläge sind wir dankbar.

Copying of this document and giving it to others and the use or communication of the contents thereof is forbidden without express authority. Offenders are liable to the payment of damages. All rights are reserved in the event of the grant of a patent or the registration of a utility model or design.

We have checked the contents of this Manual to ensure that they coincide with the described hardware and software. However, deviations cannot be completely ruled-out, so we cannot guarantee complete conformance. However, the information in this document is regularly checked and the necessary corrections included in subsequent editions. We are thankful for any recommendations or suggestions.

Contents

Warning information.....	1
1. Ordering data.....	3
2. Function description.....	3
3. Board design.....	3
4. Application information.....	4
4.1. Plug-in technology cards.....	4
4.2. Configuring.....	6
4.3. Commissioning.....	6
5. Technical data.....	7
5.1. General information.....	7
5.2. Current drain.....	7
5.3. Binary inputs (connector X6).....	7
5.4. Binary outputs (connector X6).....	7
5.5. Analog outputs (connector X7).....	8
6. Connector assignments.....	8
6.1. Connector X5.....	8
6.2. Connector X6.....	8
6.3. Connector X7.....	8
7. Supplementary components.....	9
8. ESD instructions.....	10

NOTE!

The information in this Manual does not purport to cover all details or variations in equipment, nor to provide for every possible contingency to be met in connection with installation, operation or maintenance.

Should further information be desired or should particular problems arise which are not covered sufficiently for the purchaser's purposes, please contact your local Siemens office.

Further, the contents of this Manual shall not become a part of or modify any prior or existing agreement, commitment or relationship. The sales contract contains the entire obligation of Siemens. The warranty contained in the contract between the parties is the sole warranty of Siemens. Any statements contained herein do not create new warranties nor modify the existing warranty.

Warning information

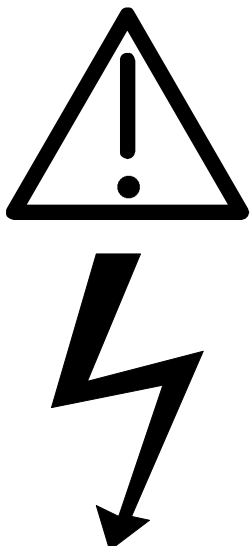
	WARNING!
	<p>Electrical equipment has components which are at dangerous voltage levels.</p> <p>If these instructions are not strictly adhered to, this can result in severe bodily injury and material damage.</p> <p>Only appropriately qualified personnel may work on this equipment or in its vicinity.</p> <p>This personnel must be completely knowledgeable about all the warnings and service measures according to this User Manual.</p> <p>The successful and safe operation of this equipment is dependent on proper handling, installation, operation and maintenance.</p>

Definitions

* **QUALIFIED PERSONNEL**

For the purpose of this User Manual and product labels, a „Qualified person“ is someone who is familiar with the installation, mounting, start-up and operation of the equipment and the hazards involved. He or she must have the following qualifications:

1. Trained and authorized to energize, de-energize, clear, ground and tag circuits and equipment in accordance with established safety procedures.
2. Trained in the proper care and use of protective equipment in accordance with established safety procedures.
3. Trained in rendering first aid.

* **DANGER**

For the purpose of this User Manual and product labels, „Danger“ indicates death, severe personal injury and/or substantial property damage will result if proper precautions are not taken.

* **WARNING**

For the purpose of this User Manual and product labels, „Warning“ indicates death, severe personal injury or property damage can result if proper precautions are not taken.

* **CAUTION**

For the purpose of this User Manual and product labels, „Caution“ indicates that minor personal injury or material damage can result if proper precautions are not taken.

* **NOTE**

For the purpose of this User Manual, „Note“ indicates information about the product or the respective part of the User Manual which is essential to highlight.

	CAUTION!
	This board contains components which can be destroyed by electrostatic discharge. Prior to touching any electronics board, your body must be electrically discharged. This can be simply done by touching a conductive, grounded object immediately beforehand (e.g. bare metal cabinet components, socket protective conductor contact).

	WARNING!
	<p>Hazardous voltages are present in this electrical equipment during operation.</p> <p>Non-observance of the safety instructions can result in severe personal injury or property damage.</p> <p>It is especially important that the warning information in all of the relevant Operating Instructions are strictly observed.</p>

1. Ordering data

EP3: 6DD 1645- 0AE0

EP3.1: 6DD 1645- 0AE1

2. Function description

The SIMADYN D system is especially suitable for especially fast closed-loop control and arithmetic operations, special converter-related functions, including gating unit and for fast analog signal processing (digital filter).

The EP3/3.1 has a DSP56002 signal processor, whose functions can be configured using STRUC, as well as interfaces to plug-in technology cards, with which the peripheral hardware can be optimally adapted to the particular task.

3. Board design

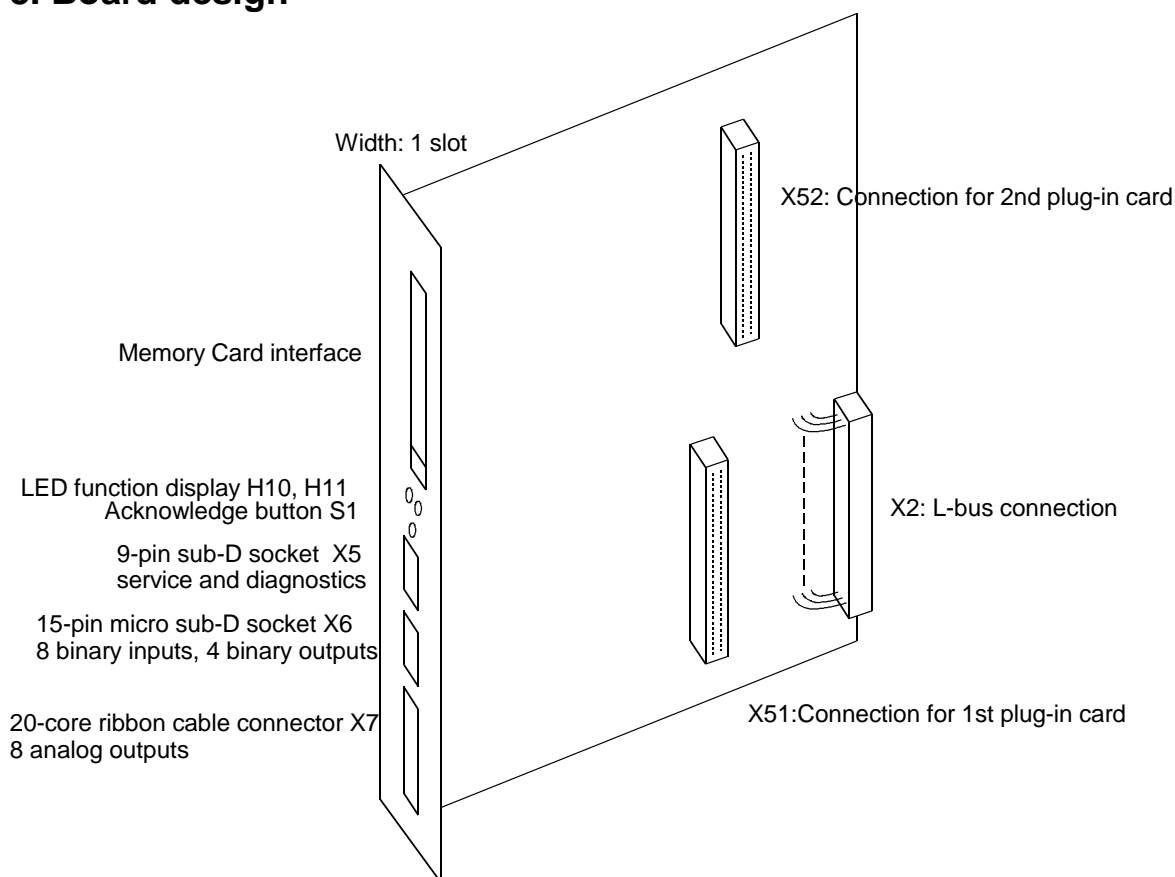

- * DSP56002 signal processor with 54 MHz clock frequency for EP3
- * DSP56002 signal processor with 66 MHz clock frequency for EP3.1
- * 128k x 24 bit working memory
- * 3 LCAs XC4013 for interrupt processing, signal pre-processing and fast logic functions (gating unit or similar)
- * Serial Communication Controller 85C30 for serial communications (2 channels for 2 plug-in cards)
- * Communications via L bus via 4k x 16 bit dual port RAM
- * Watchdog for fault identification and processor monitoring withdraws *RDYIN, if the DSP no longer reads or writes (*RDYIN is accessed at MM3, MM4)

4. Application information

For perfect functioning, the board must be screwed-into the subrack (also during start-up).

4.1. Plug-in technology cards

Plug-in technology cards are required in order to fully-utilize the special characteristics and features of the EP3/3.1. These provide the hardware for the particular application (e.g. fast and accurate analog inputs for digital filters, firing pulse output for the gating unit).

An EP3/3.1 can be equipped with a max. of 2 plug-in cards. They are screwed to one another and to the EP3/3.1 using distance studs, to form a single mechanical unit. An LCA design, tailored to the particular plug-in card belongs to each card, as a plug-in card is connected to the DSP via an LCA on the EP3/3.1. A function block, which runs on the DSP, communicates with the LCA, and the LCA then controls the hardware on the plug-in card. Further, the LCA can be used to implement many logic functions thus relieving the DSP.

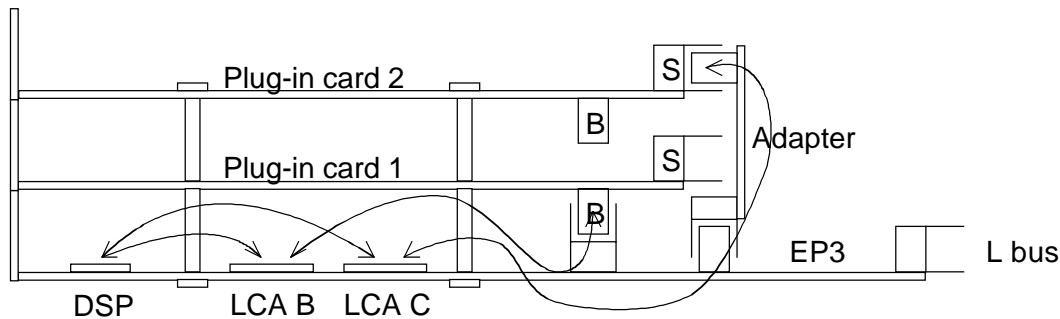

The diagram shows that plug-in card 1 is controlled from LCA-B, and plug-in card 2, which is connected to EP3/3.1 via an adapter, from LCA-C.

The configuration for an LCA is stored in a file, which is linked with it, when the DSP program is generated. The DSP then configures the LCA for the particular application when it runs-up.

Presently, the following plug-in cards and associated LCA designs and function blocks are available:

IM1:

9 analog inputs, manual adjustment, manual setting of the limiting frequency
 16 binary inputs and 16 binary outputs, floating (electrically isolated), no serial interface
 Can only be used as the 1st plug-in card
 Width: 1 slot
 With LCA design and function blocks for analog input and binary I/O

IT1:

9 analog inputs, manual adjustment, manual setting of the limiting frequency
 16 pulse outputs, non-floating (no electrical isolation) with a read-back device for short-circuit identification
 1 analog output for pulse ????
 No serial interface SS
 Can only be used as the 1st plug-in card
 Width: 1 slot
 With LCA designs and function blocks for analog input and for various gating units

IM3:

9 analog inputs, automatic adjustment, software setting of the limiting frequency
 16 binary inputs and 16 binary outputs, floating (with electrical isolation)
 Serial interface V.24 can be used depending on the function block
 Zero crossover sensing for phase- and phase-to-phase voltages
 Width: 1 slot
 With LCA design and function blocks for analog input and binary I/O, extinction angle measurement, HGÜ-DUST

IO3:

For optimal signal transfer
 10 fiber-optic connections with optical/electrical converters
 10 analog outputs
 10 optical channels can be evaluated on which laser-modulated telegrams with measured values can be transferred, output at analog outputs and at EP, only in conjunction with a special laser board and special measured value transducer
 Width: 2 slots
 with LCA design and function block

ID3:

Only in conjunction with IO3, received data is transferred to additional EP3/3.1 without D/A- and A/D conversion.

4.2. Configuring

- * Operation with P16- and/or P32 modules
- * Communications with PM via communication blocks
- * Initialization- and communication FBs included in the standard SIMADYN D library
- * 7 different sampling times, 0.1 ms to 5 s
- * per sampling time, 1 function package
- * 21 interrupt events, 7 special interrupts via interrupt controller and operating system
- * 1 free interrupt input on the DSP for special applications
- * Number of function blocks is dependent on the computation time and sampling time (e.g. computation time for sophisticated closed-loop controls and gating unit with approx. 70 FBs: 100 μ s)
- * Configuring and documentation under STRUC G with special user function block library, which includes the FBs for the EP3/3.1
- * Compilation, linking and sub-module programming using the EP3/3.1 compiler EP3C, additionally required: Motorola DSP Development Software
- * MS5 and MS55 program memory modules for user- and system software

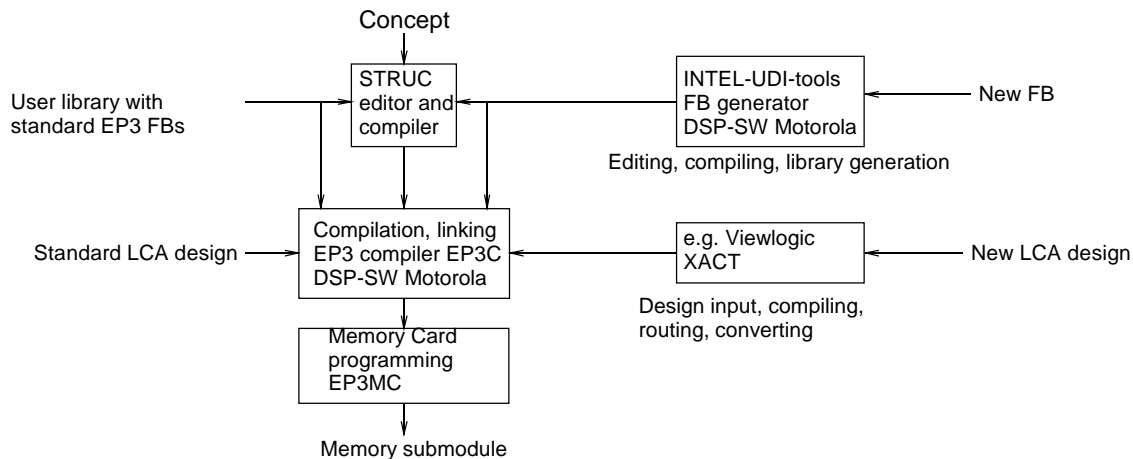

4.3. Commissioning

The EP3 IBS program (start-up program) is available for service and diagnostics. This program can run on PCs or PGs under DOS or under a DOS shell under Windows. Using this program, values and connections can be viewed, and temporarily or permanently modified. Operator control is realized via a dialog window with FP name, FB name, connector. Further, the EP3 IBS program provides a hexadecimal monitor, which can be used to directly access the DSP memory area.

The diagnostics interface of the EP3/3.1 is connector X5, a 9-pin sub-D socket connector.

Connecting cable EP3/3.1 - PC/PG:	EP3/3.1		PC/PG	
	9-pin connector		9-pin socket	25-pin plug connector/socket
	2	at	3	or 2
	3	at	2	or 3
	5	at	5	or 7

5. Technical data

5.1. General information

INSULATION GROUP	acc. to VDE 0110	
	Degree of pollution 2	
	Insulating material class IIIa	
AMBIENT TEMPERATURE	0 to 55 °C	
STORAGE TEMPERATURE	-40 to 70 °C	
HUMIDITY CLASS acc. to DIN 40040	F	
ALTITUDE RATING acc. to DIN 40040 S		
DEGREE OF PROTECTION acc. to DIN 40050	IP00	
MECHANICAL STRESSING	acc. to SN 29010 Class 12	
PACKAGING SYSTEM	ES 902 C	
DIMENSIONS	233:4mm*220mm	
BOARD WIDTH	1 1/3 SPS = 1 slot width = 20.14mm	
WEIGHT	approx. 500g	

5.2. Current drain

CURRENT DRAIN P5	1.0 A	+ plug-in card(s)
CURRENT DRAIN P15	55 mA	+ plug-in card(s) + load at X7
CURRENT DRAIN N15	55 mA	+ plug-in card(s) + load at X7

5.3. Binary inputs (connector X6)

No. type	8, non-floating	
Input voltage, nominal	24 V nominal value	
for 0 signal	-1 V to + 6 V or open-circuit inputs	
for 1 signal	+13 V to +33 V	
Input current		
for 0 signal	0 mA	
for 1 signal	3 mA typ.	
Input time constant	1 µs	

5.4. Binary outputs (connector X6)

No. type	4, non-floating	
Power supply voltage	external	
nominal value	24 V	
ripple	3.6 V	
permissible range	+20 V to +30 V incl. ripple	
briefly	+ 35 V, max. 0.5 s	
Output current for a 1 signal		
nominal value	50 mA	
permissible range	0.2 mA to 50 mA	
Short-circuit protection	Electronic, thermal	
Residual current	20 µA for 0 signal	
Signal level	max. 3 V	
for 0 signal	Pext - 2.5 V	
for 1 signal		
Switching delay	max. 15 µs	

5.5. Analog outputs (connector X7)

No., type	8, non-floating
Output voltage range	-10 V to +10 V
Output current	max. 20 mA
Short-circuit current	max. 60 mA
Resolution	12 bits incl. sign
max. offset error	+/-4 LSB

6. Connector assignments

6.1. Connector X5

9-pin sub-D socket connector, V.24 interface for diagnostics

Pin	Signal
1	Shield
2	RxD
3	TxD
4	GND
5	GND

6.2. Connector X6

15-pin micro-sub-D socket connector (three-row), binary inputs and outputs

Pin	Signal	Pin	Signal	Pin	Signal
1	Input 1	6	Input 5	11	Output 5
2	Input 2	7	Input 6	12	Output 6
3	Input 3	8	Input 7	13	Output 7
4	Input 4	9	Input 8	14	Output 8
5	P24	10	Mext	15	Minput

6.3. Connector X7

20-pin ribbon cable connector, analog outputs

Pin	Signal	Pin	Signal
1	Channel 1	9	Channel 5
2	GND	10	GND
3	Channel 2	11	Channel 6
4	GND	12	GND
5	Channel 3	13	Channel 7
6	GND	14	GND
7	Channel 4	15	Channel 8
8	GND	16	GND

7. Supplementary components

Technology plug-in card IM1	Item No. SE 113004.9101.00	order from PSWE
Technology plug-in card IM3	presently being prepared	
Technology plug-in card IT1	T89120-E3169	
Technology plug-in card IO3	presently being prepared	
Technology plug-in card ID3	presently being prepared	
with retaining screws/bolts		

User libraries for STRUC with FBs for EP3	contact ASI 1 G KT
EP3 compiler EP3C	
EP3 programming tool EP3MC	
Diagnostics program EP3IBS	
Motorola DSP Development Software	

In addition, to generate new function blocks:
INTEL-UDI tools
FB generator for STRUC and DSP

In addition, to generate new LCA designs:
CAD tools, e.g. Viewlogic
XILINX software to generate LCAs

8. ESD instructions

Components which can be destroyed by electrostatic discharge (ESD)

Generally, electronic boards should only be touched when absolutely necessary.

The human body must be electrically discharged before touching an electronics board. This can be simply done by touching a conductive, grounded object directly beforehand (e.g. bare metal cubicle components, socket outlet protective conductor contact).

Boards may not come into contact with highly-insulating materials - e.g. plastic foils, insulated desktops, articles of clothing manufactured from man-made fibers.

Boards may only be placed on conductive surfaces.

When soldering, the soldering iron tip must be grounded.

Boards and components should only be stored and transported in conductive packaging (e.g. metalized plastic boxes, metal containers).

If the packing material is not conductive, the boards must be wrapped with a conductive packing material, e.g. conductive foam rubber or household aluminum foil.

The necessary ESD protective measures are clearly shown in the following diagram.

a = Conductive floor surface
 b = ESD table
 c = ESD shoes

d = ESD overall
 e = ESD chain
 f = Cabinet ground connection

