

SYSMAC CS/CJ-series
CS1W-PRM21
CJ1W-PRM21

PROFIBUS Master Units

OPERATION MANUAL

OMRON



SYSMAC CS/CJ-series
CS1W-PRM21
CJ1W-PRM21
PROFIBUS Master Units
Operation Manual

Revised May 29, 2006

Notice:

OMRON products are manufactured for use by a trained operator and only for the purposes described in this manual.

The following conventions are used to classify and explain the precautions in this manual. Always heed the information provided with them.

-  **DANGER** Indicates information that, if not heeded, is likely to result in serious injury or loss of life.
-  **WARNING** Indicates information that, if not heeded, could possibly result in serious injury or loss of life.
-  **Caution** Indicates information that, if not heeded, could possibly result in minor or relatively serious injury, damage to the product or faulty operation.

OMRON Product References

All OMRON products are capitalized in this manual. The first letter of the word *Unit* is also capitalized when it refers to an OMRON product, regardless of whether it appears in the proper name of the product.

The abbreviation *Ch* appears in some displays and on some OMRON products. It often means *word* and is abbreviated as *Wd* in the documentation.

The abbreviation *PLC* means Programmable Logic Controller.

Visual Aids

The following headings appear in the left column of the manual to help you locate different types of information.

Note Indicates information of particular interest for efficient and convenient operation of the product.

1, 2, 3...Indicates various lists such as procedures, checklists etc.

Trademarks and Copyrights

PROFIBUS, PROFIBUS FMS, PROFIBUS DP, PROFIBUS DP-V1, and PROFIBUS PA are trademarks of PROFIBUS International.

Microsoft, Windows, Windows NT, Windows 2000, Windows XP, Windows Explorer and ActiveX are trademarks of Microsoft Corporation.

Sycon and CIF are trademarks of Hilscher GmbH.

HART® is a registered trademark of HART Communication Foundation.

Other product names and company names in this manual are trademarks or registered trademarks of their respective companies.

The copyright of the PROFIBUS Master Unit belongs to OMRON Corporation.

© OMRON, 2006

All rights reserved. No part of this publication may be reproduced, stored in a retrieval system, or transmitted, in any form, or by any means, mechanical, electronic, photocopying, recording, or otherwise, without the prior written permission of OMRON.

No patent liability is assumed with respect to the use of the information contained herein. Moreover, because OMRON is constantly striving to improve its high-quality products, the information contained in this manual is subject to change without notice. Every precaution has been taken in the preparation of this manual. Nevertheless, OMRON assumes no responsibility for errors or omissions. Neither is any liability assumed for damages resulting from the use of the information contained in this publication.

TABLE OF CONTENTS

About this Manual	ix
PRECAUTIONS	xv
1 Intended Audience	xvi
2 General Precautions	xvi
3 Safety Precautions	xvi
4 Operating Environment Precautions	xvii
5 Application Precautions	xviii
6 Conformance to EC Directives	xx
SECTION 1	
Features and Specifications	1
1-1 Overview of PROFIBUS	2
1-2 Setting up a PROFIBUS DP Network	7
1-3 PROFIBUS Master Unit	10
1-4 CX-Profibus Configurator	19
1-5 Basic Operating Procedure	24
SECTION 2	
Installation and Wiring	27
2-1 Unit Components	28
2-2 Installing the CS1/CJ1W-PRM21 Units	32
2-3 Initial Setup Procedure	35
2-4 Setting up a Network	37
2-5 Defining PROFIBUS DP in the Software	41
SECTION 3	
Configuration Software	43
3-1 Installation	44
3-2 CX-Profibus	53
3-3 CS1/CJ1W-PRM21 PROFIBUS Master DTM	65
3-4 C200HW-PRM21 PROFIBUS DP Master DTM	87
3-5 Generic Slave Device DTM	96
SECTION 4	
Allocated CIO and DM Words	109
4-1 Overview of Word Allocations	110
4-2 Allocated CIO Area Words	112

TABLE OF CONTENTS

SECTION 5

FINS Commands and Responses 125

5-1	FINS Commands and Responses	126
5-2	Command / Response Reference	129

SECTION 6

Operation 147

6-1	Introduction	148
6-2	Setting up a network	148
6-3	Configuring the Slave Devices	155
6-4	Configuring the Master	161
6-5	I/O Communication Characteristics	168
6-6	Operating the Network	182
6-7	Monitoring the Network	190
6-8	PROFIBUS DP-V1 Services	197

SECTION 7

Troubleshooting and Maintenance 201

7-1	Overview	202
7-2	Troubleshooting Using LED Indicators	203
7-3	Troubleshooting Using Error Status	209
7-4	Troubleshooting the Network	212
7-5	Troubleshooting Using the Error Log	222
7-6	Troubleshooting FINS Commands	225
7-7	Maintenance	226
7-8	Replacing the Unit	227

Appendices

A	Bus Parameters	229
B	Slave Diagnostics Message	233
C	I/O Data Conversions	243
D	Configurator Error and Warning Messages	247
E	Memory Card Backup Functions	253
F	Application Notes	255
G	C200HW-PRM21 Notes	257

Index 265

Revision History 271

About this Manual

This manual describes the CS1W-PRM21 and CJ1W-PRM21 PROFIBUS DP and PROFIBUS DP-V1 Master Units. The Unit version number on the side case of the housing indicates supported functionality. If no version number is shown, the version number is 1.0. The following table lists the functions supported per version number.

Unit name	Unit Version	Supporting DTM version	Functions supported
CJ1W-PRM21	1.0	0.1.0.1 and up	PROFIBUS DP (Class 1) Master
CS1W-PRM21	2.0	0.2.0.0 and up	PROFIBUS DP (Class 1) Master PROFIBUS DP-V1 (Class 1) Master Additional PROFIBUS DP acyclic services
	3.0	0.3.0.0	PROFIBUS DP (Class 1) Master PROFIBUS DP-V1 (Class 1 and Class 2) Master Additional PROFIBUS DP acyclic services

Unit version 3.0 includes the same functions as Unit version 1.0 and 2.0, in addition to PROFIBUS DP-V1 Class 2 related functions. Unit version 3.0 will eventually replace Unit version 1.0 and 2.0.

The DTM versions are downward compatible. Newer versions also support features of previous Unit versions.

Note Unless stated otherwise, specifications, descriptions and images in this manual apply to all Unit versions of the CS1W-PRM21 and CJ1W-PRM21 Units. The indication PROFIBUS Master Unit(s) will be used when referring to both unit types.

Note The basic functionality of PROFIBUS DP is sometimes referred to as PROFIBUS DP-V0. In this document the term PROFIBUS DP will be used to indicate the basic functionality.

This manual describes how to install and operate the CS1W-PRM21 and CJ1W-PRM21 Units. Both Units serve the same purpose: enable devices of various manufacturers to intercommunicate without making any special interface adaptations. They are technically the same; they differ only in their physical dimensions and weight and the way they are connected to the backplane.

This manual also describes - to a lesser extent - how to configure the C200HW-PRM21 PROFIBUS DP Master Unit using the CX-Profibus Configurator. For more information on the C200HW-PRM21 PROFIBUS DP Master Unit, refer to the C200H-series PROFIBUS DP Master Units Operation Manual (W349-E2-□).

Please read this manual carefully so that you understand the information provided before installing or using the PROFIBUS Master Unit. Start with the precautions in the following section. They describe the operating environment and application safety measures which must be observed prior to and when using the PROFIBUS Master Unit.

The sections of this manual are as follows:

Section 1 introduces the PROFIBUS Master Units and CX-Profibus.

Section 2 describes the installation and setup of the PROFIBUS Master Units.

Section 3 describes the installation of CX-Profibus and provides a overview.

Section 4 describes how the Units interface to the PLC CPU.

Section 5 describes the FINS commands supported by the PROFIBUS Master Units.

Section 6 describes the operational aspects of the PROFIBUS Master Units.

Section 7 provides procedures for troubleshooting the PROFIBUS network and the Units.

The **Appendices** contain information supplementary to the information in the main body of the manual. They are referred to in the various sections as required.

Manual	Products	Contents	Cat. No.
CS-series Programmable Controllers Operation Manual	SYSMAC CS-series CS1G/H-CPU□□-E	Describes the installation and operation of the CS-series PLCs.	W339-E1-□
CJ-series Programmable controllers operation Manual	SYSMAC CJ-series CJ1G-CPU□□	Describes the installation and operation of the CJ-series PLCs.	W393-E1-□
CS/CJ-series Programmable Controllers Programming Manual	SYSMAC CS/CJ-series CS1G/H-CPU□□-E, CJ1G-CPU□□	Describes the ladder diagram programming instructions supported by CS/CJ-series PLCs.	W394-E1-□
CS/CJ-series Programmable Controllers Instructions Reference Manual	SYSMAC CS/CJ-series CS1G/H-CPU□□-E, CJ1G-CPU□□	Describes the ladder diagram programming instructions supported by CS-series and CJ-series PLCs.	W340-E1-□
CS/CJ Series Communication Commands Reference Manual	SYSMAC CS1G/H-CPU□□-E CPU Units	Describes the C-series (Host Link) and FINS communications commands used with CS/CJ-series PLCs.	W342-E1-□
CX-Programmer Operation Manual	SYSMAC WS02-CXP□□-E CX-Programmer	Provides information on how to use the CX-Programmer, programming software which supports CS1/CJ1-series PLCs.	W414-E1-□
CX-Server Run Time User Manual	CX-Server	Provides information on how to use the CX-Server communication driver software which supports CS1/CJ1-series PLCs.	W391-E2-□
C200H-series PROFIBUS DP Master Units Operation Manual	SYSMAC C200H-series C200HW-PRM21	Describes the Installation and Operation of the C200HW-PRM21 PROFIBUS DP Master Units.	W349-E2-□
CJ-series PROFIBUS DP Slave unit Operation Manual	SYSMAC CJ1-series CJ1W-PRT21	Describes the Installation and Operation of the CJ1W-PRT21 PROFIBUS DP Slave Units.	W408-E2-□
SmartSlice GRT1-Series PROFIBUS Communication Unit Operation Manual	SmartSlice GRT1-Series GRT1-PRT	Describes the Installation and Operation of the SmartSlice GRT1_series GRT1-PRT PROFIBUS Communication Unit.	W04E-EN-□
GT1-series PROFIBUS DP Multiple I/O Terminal Operation Manual	PRT1-COM & GT1-series	Describes the Installation and Operation of the PROFIBUS DP PRT1-COM and GT1-series I/O Units.	W900-E2-□
C200H-series PROFIBUS DP Slave unit Operation Manual	SYSMAC C200H-series C200HW-PRT21 PROFIBUS DP Slave unit	Describes the Installation and Operation of the C200HW-PRT21 PROFIBUS DP Slave Units.	W901-E2-□
F150-series PROFIBUS DP Vision Sensor Operation Manual	F150-C15E-3-PRT21 PROFIBUS DP Vision Sensor	Describes the Installation and Operation of the F150 PROFIBUS Vision Sensor.	Z143-E1-□

⚠ WARNING Failure to read and understand the information provided in this manual may result in personal injury or death, damage to the product, or product failure. Please read each section in its entirety and be sure you understand the information provided in the section and related sections before attempting any of the procedures or operations given.

Read and Understand this Manual

Please read and understand this manual before using the product. Please consult your OMRON representative if you have any questions or comments.

Warranty and Limitations of Liability

WARRANTY

OMRON's exclusive warranty is that the products are free from defects in materials and workmanship for a period of one year (or other period if specified) from date of sale by OMRON.

OMRON MAKES NO WARRANTY OR REPRESENTATION, EXPRESS OR IMPLIED, REGARDING NON-INFRINGEMENT, MERCHANTABILITY, OR FITNESS FOR PARTICULAR PURPOSE OF THE PRODUCTS. ANY BUYER OR USER ACKNOWLEDGES THAT THE BUYER OR USER ALONE HAS DETERMINED THAT THE PRODUCTS WILL SUITABLY MEET THE REQUIREMENTS OF THEIR INTENDED USE. OMRON DISCLAIMS ALL OTHER WARRANTIES, EXPRESS OR IMPLIED.

LIMITATIONS OF LIABILITY

OMRON SHALL NOT BE RESPONSIBLE FOR SPECIAL, INDIRECT, OR CONSEQUENTIAL DAMAGES, LOSS OF PROFITS OR COMMERCIAL LOSS IN ANY WAY CONNECTED WITH THE PRODUCTS, WHETHER SUCH CLAIM IS BASED ON CONTRACT, WARRANTY, NEGLIGENCE, OR STRICT LIABILITY.

In no event shall the responsibility of OMRON for any act exceed the individual price of the product on which liability is asserted.

IN NO EVENT SHALL OMRON BE RESPONSIBLE FOR WARRANTY, REPAIR, OR OTHER CLAIMS REGARDING THE PRODUCTS UNLESS OMRON'S ANALYSIS CONFIRMS THAT THE PRODUCTS WERE PROPERLY HANDLED, STORED, INSTALLED, AND MAINTAINED AND NOT SUBJECT TO CONTAMINATION, ABUSE, MISUSE, OR INAPPROPRIATE MODIFICATION OR REPAIR.

Application Considerations

SUITABILITY FOR USE

OMRON shall not be responsible for conformity with any standards, codes, or regulations that apply to the combination of products in the customer's application or use of the products.

At the customer's request, OMRON will provide applicable third party certification documents identifying ratings and limitations of use that apply to the products. This information by itself is not sufficient for a complete determination of the suitability of the products in combination with the end product, machine, system, or other application or use.

The following are some examples of applications for which particular attention must be given. This is not intended to be an exhaustive list of all possible uses of the products, nor is it intended to imply that the uses listed may be suitable for the products:

- Outdoor use, uses involving potential chemical contamination or electrical interference, or conditions or uses not described in this manual.
- Nuclear energy control systems, combustion systems, railroad systems, aviation systems, medical equipment, amusement machines, vehicles, safety equipment, and installations subject to separate industry or government regulations.
- Systems, machines, and equipment that could present a risk to life or property.

Please know and observe all prohibitions of use applicable to the products.

NEVER USE THE PRODUCTS FOR AN APPLICATION INVOLVING SERIOUS RISK TO LIFE OR PROPERTY WITHOUT ENSURING THAT THE SYSTEM AS A WHOLE HAS BEEN DESIGNED TO ADDRESS THE RISKS, AND THAT THE OMRON PRODUCTS ARE PROPERLY RATED AND INSTALLED FOR THE INTENDED USE WITHIN THE OVERALL EQUIPMENT OR SYSTEM.

PROGRAMMABLE PRODUCTS

OMRON shall not be responsible for the user's programming of a programmable product, or any consequence thereof.

Disclaimers

CHANGE IN SPECIFICATIONS

Product specifications and accessories may be changed at any time based on improvements and other reasons.

It is our practice to change model numbers when published ratings or features are changed, or when significant construction changes are made. However, some specifications of the products may be changed without any notice. When in doubt, special model numbers may be assigned to fix or establish key specifications for your application on your request. Please consult with your OMRON representative at any time to confirm actual specifications of purchased products.

DIMENSIONS AND WEIGHTS

Dimensions and weights are nominal and are not to be used for manufacturing purposes, even when tolerances are shown.

PERFORMANCE DATA

Performance data given in this manual is provided as a guide for the user in determining suitability and does not constitute a warranty. It may represent the result of OMRON's test conditions, and the users must correlate it to actual application requirements. Actual performance is subject to the OMRON Warranty and Limitations of Liability.

ERRORS AND OMISSIONS

The information in this manual has been carefully checked and is believed to be accurate; however, no responsibility is assumed for clerical, typographical, or proofreading errors, or omissions.

PRECAUTIONS

This section provides general precautions for using the PROFIBUS Master Units, Programmable Controllers and related devices.

The information contained in this section is important for the safe and reliable operation of the PROFIBUS Master Units. You must read this section and understand the information contained before attempting to set up or operate a PROFIBUS Master Unit and PLC system.

1	Intended Audience	xvi
2	General Precautions	xvi
3	Safety Precautions	xvi
4	Operating Environment Precautions	xvii
5	Application Precautions	xviii
6	Conformance to EC Directives	xx
6-1	Applicable Directives	xx
6-2	Concepts	xx
6-3	Conformance to EC Directives	xx

1 Intended Audience

This manual is intended for the following personnel, who must also have a knowledge of electrical systems (an electrical engineer or the equivalent).

- Personnel in charge of installing FA systems.
- Personnel in charge of designing FA systems.
- Personnel in charge of managing FA systems and facilities.

2 General Precautions

The user must operate the product according to the performance specifications described in the operation manuals.

Before using the product under conditions which are not described in the manual or applying the product to nuclear control systems, railroad systems, aviation systems, vehicles, combustion systems, medical equipment, amusement machines, safety equipment, and other systems, machines, and equipment that may have a serious influence on lives and property if used improperly, consult your OMRON representative.

Make sure that the ratings and performance characteristics of the product are sufficient for the systems, machines, and equipment, and be sure to provide the systems, machines, and equipment with double safety mechanisms.

This manual provides information for programming and operating OMRON PROFIBUS Master Units. Be sure to read this manual before attempting to use the Unit and keep this manual close at hand for reference during operation.

 **WARNING** It is extremely important that all PLC Units be used for their specified purposes and under the specified conditions, especially in applications that can directly or indirectly affect human life. You must consult your OMRON representative before using a PLC System in the above-mentioned applications.

3 Safety Precautions

 **WARNING** Do not attempt to take any Unit apart while the power is being supplied. Doing so may result in electric shock.

 **WARNING** Never touch any of the terminals while power is being supplied. Doing so may result in serious electrical shock or electrocution.

 **WARNING** Do not attempt to disassemble, repair, or modify any Units. Any attempt to do so may result in malfunction, fire, or electric shock.

 **WARNING** Do not touch the Power Supply Unit while power is being supplied or immediately after power has been turned OFF. Doing so may result in electric shock.

 **Caution** Tighten the screws on the terminal block of the AC Power Supply Unit to the torque specified in the operation manual. Loose screws may result in burning or malfunction.

 **WARNING** The CPU Unit refreshes I/O even when the program is stopped (i.e., even in PROGRAM mode). Confirm safety thoroughly in advance before changing the status of any part of memory allocated to I/O Units, Special I/O Units, or CPU Bus Units. Any changes to the data allocated to any Unit may result in unexpected operation of the loads connected to the Unit. Any of the following operation may result in changes to memory status.

- Transferring I/O memory data to the CPU Unit from a Programming Device.
- Changing present values in memory from a Programming Device.
- Force-setting/-resetting bits from a Programming Device.
- Transferring I/O memory files from a Memory Card or EM file memory to the CPU Unit.
- Transferring I/O memory from a host computer or from another PC on a network.

 **WARNING** Execute online edits only after confirming that no adverse effects will be caused by extending the cycle time. Otherwise, the input signals may not be readable.

4 Operating Environment Precautions

 **Caution** Do not operate the Unit in the following places:

- Locations subject to direct sunlight.
- Locations subject to temperatures or humidities outside the range specified in the specifications.
- Locations subject to condensation as the result of severe changes in temperature.
- Locations subject to corrosive or flammable gases.
- Locations subject to dust (especially iron dust) or salt.
- Locations subject to exposure to water, oil, or chemicals.
- Locations subject to shock or vibration.

Provide proper shielding when installing in the following locations:

- Locations subject to static electricity or other sources of noise.
- Locations subject to strong electromagnetic fields.
- Locations subject to possible exposure to radiation.
- Locations near to power supply lines.

 **Caution** The operating environment of the PLC system can have a large effect on the longevity and reliability of the system. Unsuitable operating environments can lead to malfunction, failure and other unforeseeable problems with the PLC system. Ensure that the operating environment is within the specified conditions at installation time and remains that way during the life of the system. Follow all installation instructions and precautions provided in the operation manuals.

5 Application Precautions

Observe the following precautions when using the PROFIBUS Master Unit.

 **WARNING** Failure to abide by the following precautions could lead to serious or possibly fatal injury. Always heed these precautions.

- Always connect to a class-3 ground (100 Ω or less) when installing the Units.

 **Caution** Failure to abide by the following precautions could lead to faulty operation or the PLC or the system or could damage the PLC or PLC Units. Always heed these precautions.

- Install double safety mechanisms to ensure safety against incorrect signals that may be produced by broken signal lines or momentary power interruptions.
- When adding a new device to the network, make sure that the baud rate is the same as other nodes.
- When adding a new slave device to the network, make sure that the PROFIBUS Master Unit is in the OFFLINE state, to prevent unexpected results when starting up the slave device.
- Use specified communications cables.
- Do not extend connection distances beyond the ranges given in the specifications.
- Always turn OFF the power supply to the personal computer, Slaves, and Communications Units before attempting any of the following.
 - Mounting or dismounting the PROFIBUS Master Unit, Power Supply Units, I/O Units, CPU Units, or any other Units.
 - Assembling a Unit.
 - Setting DIP switches or rotary switches.
 - Connecting or wiring the cables.
 - Connecting or disconnecting connectors.
- Be sure that the terminal blocks, connectors, Memory Units, expansion cables, and other items with locking devices are properly locked into place. Improper locking may result in malfunction.
- Be sure that all the mounting screws, terminal screws, Unit mounting screws, and cable connector screws are tightened to the torque specified in the relevant manuals. Incorrect tightening torque may result in malfunction.
- Leave the label attached to the Unit when wiring. Removing the label may result in malfunction if foreign matter enters the Unit.
- Remove the label after the completion of wiring to ensure proper heat dissipation. Leaving the label attached may result in malfunction.
- Always use the power supply voltage specified in this manual.
- Double-check all the wiring and connection of terminal blocks and connectors before mounting the Units.
- Use crimp terminals for wiring. Do not connect bare stranded wires directly to terminals.

- Observe the following precautions when wiring the communications cable.
 - Separate the communications cables from the power lines or high-tension lines.
 - Do not bend the communications cables.
 - Do not pull on the communications cables.
 - Do not place heavy objects on top of the communications cables.
 - Be sure to wire communications cable inside ducts.
 - Use appropriate communications cables.
- Take appropriate measures to ensure that the specified power with the rated voltage and frequency is supplied in places where the power supply is unstable. An incorrect power supply may result in malfunction.
- Install external breakers and take other safety measures against short-circuits in external wiring. Insufficient safety measures against short-circuits may result in burning.
- Double-check all the wiring and switch settings before turning ON the power supply.
- Check the user program for proper execution before actually running it on the Unit. Not checking the program may result in an unexpected operation.
- When configuring a slave device on the network using PROFIBUS DP-V1 messaging services via the PROFIBUS Master Unit, make sure that the PROFIBUS Master Unit is in the CLEAR state, to prevent unexpected results when.
- Confirm that no adverse effect will occur in the system before attempting any of the following. Not doing so may result in an unexpected operation.
 - Changing the operating mode of the PC.
 - Force-setting/force-resetting any bit in memory.
 - Changing the present value of any word or any set value in memory.
- After replacing Units, resume operation only after transferring to the new CPU Unit and/or Special I/O Units the contents of the DM Area, HR Area, and other data required for resuming operation. Not doing so may result in an unexpected operation.
- When transporting or storing the product, cover the PCBs with electrically conductive materials to prevent LSIs and ICs from being damaged by static electricity, and also keep the product within the specified storage temperature range.
- When transporting the Unit, use special packing boxes and protect it from being exposed to excessive vibration or impacts during transportation.
- Do not attempt to disassemble, repair, or modify any Units.
- Do not attempt to remove the cover over the non-used connector hole on the front of the CS1W-PRM21 Unit.

6 Conformance to EC Directives

6-1 Applicable Directives

- EMC Directives
- Low voltage directive EN 61131-2:1994+A12:2000

6-2 Concepts

EMC Directives

OMRON Units complying with EC Directives also conform to related EMC standards making them easier to incorporate in other Units or machines. The actual products have been checked for conformity to EMC standards. (See the following note.) Whether the products conform to the standards in the system used by the customer, however, must be checked by the customer.

EMC-related performance of OMRON Units complying with EC Directives will vary depending on the configuration, wiring, and other conditions of the equipment or control panel in which OMRON devices are installed. The customer must, therefore, perform final checks to confirm that units and the overall system conforms to EMC standards.

Note Applicable EMS (Electromagnetic Susceptibility) and EMI (Electromagnetic Interference) standards in the EMC (Electromagnetic Compatibility) standards are as follows:

Unit	EMS	EMI
CS1W-PRM21	EN 61000-6-2:2001	EN 61000-6-2:2001
CJ1W-PRM21		

6-3 Conformance to EC Directives

Units that meet EC directives also meet the common emission standard (EN50081-2). The measures necessary to ensure that the standard is met will vary with the overall configuration. You must therefore confirm that EC directives are met for the overall configuration, particularly any radiated emission requirement (10 m).

SECTION 1

Features and Specifications

This section provides an introductory overview of PROFIBUS, its functions and how to setup and configure a network. It also addresses the PROFIBUS Master Units and the configurator, their features and specifications.

1-1	Overview of PROFIBUS	2
1-1-1	Introduction	2
1-1-2	PROFIBUS Communication Protocol	2
1-1-3	Device Types	4
1-1-4	Bus Access Protocol	4
1-1-5	Diagnostic functions	5
1-1-6	Protection Mechanisms	6
1-1-7	Network Operation Modes	6
1-2	Setting up a PROFIBUS DP Network	7
1-2-1	Configuring the PROFIBUS Master	7
1-2-2	FDT/DTM Technology	7
1-2-3	GSD file Technology	8
1-3	PROFIBUS Master Unit	10
1-3-1	PROFIBUS Master Unit Features	10
1-3-2	Specifications	12
1-3-3	Comparison with Previous Model	17
1-4	CX-Profibus Configurator	19
1-4-1	CX-Profibus Features	19
1-4-2	Specifications	22
1-5	Basic Operating Procedure	24
1-5-1	Overview	24
1-5-2	Preparations for Communications	25
1-5-3	Procedures Prior to Starting Communications	25

1-1 Overview of PROFIBUS

1-1-1 Introduction

Standard EN50170



PROFIBUS (PROcess FieldBUS) is an open fieldbus standard for a wide range of applications in manufacturing, processing and building automation. The Standard, EN 50170 (the Euronorm for field communications), to which PROFIBUS adheres, guarantees vendor independence and transparency of operation. It enables devices of various manufacturers to intercommunicate without having to make any special interface adaptations.

The PROFIBUS family comprises three mutually compatible versions: PROFIBUS FMS, PROFIBUS DP and PROFIBUS PA.

PROFIBUS FMS

FMS means Fieldbus Message Specification. This version is the general-purpose solution for high-level extensive and complex communication tasks. Powerful services open up a wide range of applications and provide great flexibility.

PROFIBUS DP

DP means Decentralized Periphery. PROFIBUS DP is optimized for high speed and low-cost interfacing. It is specially designed for communication between automation control systems and distributed I/O at the device level.

PROFIBUS PA

PA means Process Automation. It permits sensors and actuators to be connected to one common bus even in areas where intrinsically safe products are required. It also permits data and power to be supplied over the bus using 2-wire technology according the international standard IEC 1158-2.

Uniform Bus Access Protocol

PROFIBUS DP and PROFIBUS FMS use the same transmission technology and uniform bus access protocol. Consequently, both versions can be operated simultaneously on the same bus. FMS field devices, however, cannot be controlled by DP masters and vice versa.

⚠ Caution It is not possible to exchange one of these family members by another family member. This will cause faulty operation.

The rest of this section describes the PROFIBUS DP Protocol architecture.

1-1-2 PROFIBUS Communication Protocol

OSI reference model

ISO-7498

In general, the PROFIBUS communication protocol is based on the Open System Interconnection (OSI) reference model in accordance with the international standard ISO-7498 (see the following illustration). The model defines 7 layers of communication functions, three of which - layers 1, 2, and 7 - are used in PROFIBUS.

- Layer 1, the Physical Layer of this model, defines the physical transmission characteristics.
- Layer 2, the Data Link Layer of this model, defines the bus access protocol. This protocol also includes data security and the handling of transmission protocols and telegrams.
- Layer 7, the Application Layer of this model, defines the application functions. This Layer is only applicable to PROFIBUS FMS.

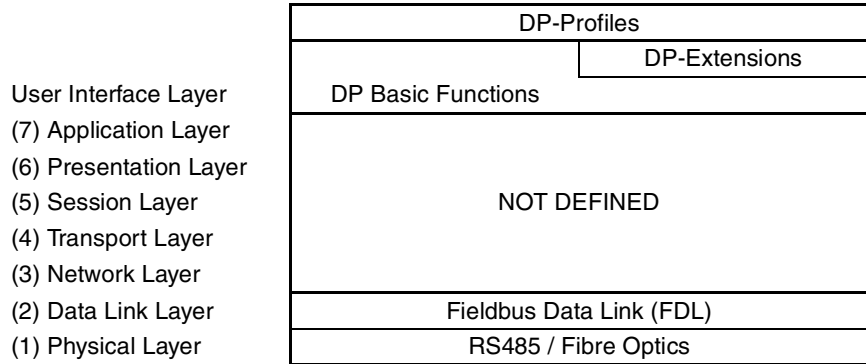

PROFIBUS DP

In the rest of this manual, only PROFIBUS DP is considered.

OSI Layer 1, 2 and User Interface

PROFIBUS DP uses layers 1 and 2, and the user interface. Layers 3 to 7 are not defined for PROFIBUS DP. The user interface Layer defines the interface functions for specific application areas, i.e. the PROFIBUS DP basic functions and communication profiles. This streamlined architecture ensures fast and efficient data transmission. The application functions which are available to the user, as well as the system and device behaviour of the various PROFIBUS DP device types, are specified in the user interface.

OSI Layer 1: Transmission Medium

RS-485 transmission technology or fibre optics are available for transmission. RS-485 transmission is the most frequently used transmission technology. Its application area includes all areas in which high transmission speed and simple inexpensive installation are required. PROFIBUS modules are interconnected by single twisted-pair shielded copper wires.

RS-485 Technology

The RS-485 transmission technology is very easy to handle. Installation of the twisted pair cable does not require expert knowledge. The bus structure permits addition and removal of devices or step-by-step commissioning of the system without influencing the other devices. Later expansions have no effect on devices which are already in operation.

RS-485 Transmission Speed

Transmission speeds between 9.6 kbit/s and 12 Mbit/s can be selected as shown in the table below. One unique transmission speed must be selected for all devices on the bus when the system is commissioned.

Baud rate (kbit/s)	Distance / segment (m)
9.6	1200
19.2	1200
45.45	1200
93.75	1200
187.5	1000
500	400
1500	200
3000	100
6000	100
12000	100

Cable length

The maximum cable length values depend on the transmission speed and are based on type-A cable (see *Cable Type* on page 39). The length can be increased by the use of repeaters. However, it is not recommended to use more than three repeaters in series in a PROFIBUS network.

1-1-3 Device Types

PROFIBUS distinguishes between master devices and slave devices.

Master Devices

Master devices determine the data communication on the bus. A Master can send messages without an external request, as long as it holds the bus access right (the token). Masters are also referred to as active devices in the PROFIBUS standard.

There are two types of master devices:

Class 1 Master (DPM1)

A PROFIBUS DP Class 1 Master (DPM1) device is a central controller, which exchanges information with the decentralized devices (i.e. DP slaves) within a specified message cycle.

Class 2 Master (DPM2)

PROFIBUS DP class 2 Master (DPM2) devices are programmers, configuration devices or operator panels. They are used during commissioning, for configuration of the DP system, or for operation and monitoring purposes.

As of Unit Version 3.0 the CS1W-PRM21 and the CJ1W-PRM21 are PROFIBUS DP Class 1 as well as Class 2 Master devices.

Slave Devices

Slave devices are peripheral devices. Typical slave devices include input/output devices, valves, drives, and measuring transmitters. They do not have bus access rights and they can only acknowledge received messages or send messages to the master when requested to do so. Slave devices are also called passive devices

Device Profile

To enable the exchange of devices from different vendors, the user data has to have the same format. The PROFIBUS DP protocol does not define the format of user data, it is only responsible for the transmission of this data. The format of user data may be defined in so called profiles. Profiles can reduce engineering costs since the meaning of application-related parameters is specified precisely. Profiles have been defined for specific areas like drive technology, encoders, and for sensors / actuators.

PROFIBUS DP-V1

PROFIBUS DP-V1 is an extension to the PROFIBUS DP protocol standard. It defines acyclic message services between a PROFIBUS DP-V1 Master and a PROFIBUS DP-V1 slave device. These acyclic message services allow exchange of extended parameter settings as well as extended diagnostics and alarm information, during regular I/O data exchange. PROFIBUS DP-V1 devices must at least support PROFIBUS DP.

PROFIBUS DP-V1 services are designated as MSAC_n services (Master-Slave Acyctic, Class n), in which n designates the Master Class (i.e. 1 or 2). The CS1W-PRM21 and the CJ1W-PRM21 both support PROFIBUS DP-V1 Class 1 and Class 2 Master functions as of Unit version 3.0.

1-1-4 Bus Access Protocol

OSI Layer 2: Bus Access Protocol

The PROFIBUS bus access protocol is implemented by OSI layer 2. This protocol also includes data security and the handling of the transmission protocols and messages.

Medium Access Control

The Medium Access Control (MAC) specifies the procedures which determine when a device is permitted to transmit data. A token passing procedure is used to handle the bus access between master devices, and a polling procedure is used to handle the communication between a master device and its assigned slave device(s).

Token Passing

The token passing procedure guarantees that the bus access right (the token) is assigned to each master within a precisely defined time frame. The token message, a special message for passing access rights from one master to the next master, must be passed around the logical token ring - once to each master - within a specified target rotation time. Each master executes this procedure automatically.

Polling Procedure

The polling or master-slave procedure permits the master, currently in possession of the token, to access its assigned slaves. The figure below shows a possible configuration. The configuration shows three active devices (masters) and six passive devices (slaves).

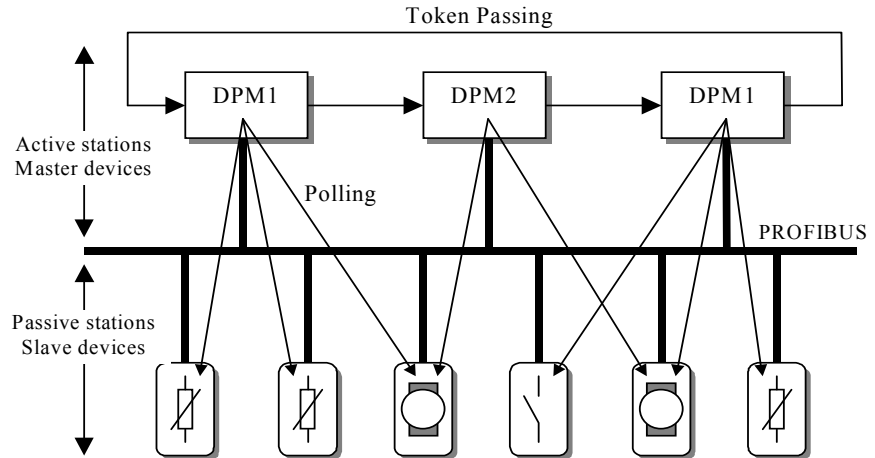

The three masters form a logical token ring. When an active device receives the token message, it can perform its master role for a certain period of time. During this time it can communicate with all assigned slave devices in a master-slave communication relationship, and a DPM2 master can take the initiative to communicate with DPM1 master devices in a master-master communication relationship.

Multi-peer Communication

In addition to logical peer-to-peer data transmission, PROFIBUS DP provides multi-peer communication (broadcast and multicast).

Broadcast Communication

In the case of broadcast communication a master device sends an unacknowledged message to all other devices (masters and slaves).

Multicast Communication

In the case of multicast communication a master device sends an unacknowledged message to a predetermined group of slave devices.

1-1-5 Diagnostic functions

Extended Diagnostics

Extended diagnostic functions defined in PROFIBUS DP enable the fast location of error at slave devices. Diagnostic messages are transmitted over the bus and collected at the master. Three diagnostic message types are defined:

Device Related Diagnostics

- Messages concerning the general operational status of the whole device, e.g. over temperature, low voltage.

Module Related Diagnostics

- Messages indicating that an error is present in a specific I/O range of a device, e.g. an 8-bit output module.

Channel Related Diagnostics

- Messages indicating an error at a given input or output, e.g. short circuit on Output 5.

1-1-6 Protection Mechanisms

Monitoring Time	PROFIBUS DP provides effective protection functions against parameterization errors or failure of the transmission equipment. Time monitoring is provided both at the master and the slave devices. The monitoring interval is specified when the system is configured.
Monitoring at the Master	The PROFIBUS Master monitors data transmission of the slaves with the Data-Control-Timer. A separate control timer is used for each slave. This timer expires if response data is not correctly transmitted by the slave within the monitoring interval. The user is informed when this happens. If the automatic error reaction (Auto-CLEAR) has been enabled, the PROFIBUS Master exits its OPERATE state, switches the outputs of all assigned slaves to the fail-safe status and changes to the CLEAR state.
Monitoring at the Slave	Slave devices use a watchdog to detect failures of the master or the bus. If data communication with the master does not occur within the set watchdog time interval, a slave automatically switches its outputs to the fail-safe mode. Also, access protection is provided for the inputs and outputs of the slaves operating in multi-master systems. Only authorized masters can access their slaves.

1-1-7 Network Operation Modes

PROFIBUS DP distinguishes four different network operation modes:

OFFLINE	<ul style="list-style-type: none"> • Communication with all PROFIBUS DP participants (masters and slaves) is stopped. The Master ceases to access the PROFIBUS network.
STOP	<ul style="list-style-type: none"> • Cyclic communication as well as PROFIBUS DP-V1 Class 1 communication between the master and its slaves is stopped. Only PROFIBUS DP-V1 Class 2 communication and communication between the master and other masters is still possible.
CLEAR	<ul style="list-style-type: none"> • The master tries to set parameters, check the configuration, and perform data exchange with its associated slaves. Data exchange involves reading the inputs of the PROFIBUS DP slaves and writing zeros to the outputs of the slaves.
OPERATE	<ul style="list-style-type: none"> • The master exchanges data with its assigned slaves, inputs are read and outputs are written. Also, the master cyclically sends its local status to all its assigned PROFIBUS DP slaves (using a broadcast message).

The PROFIBUS Master Unit will always be in one of these four modes. Mode transitions from one mode to another will be performed via intermediate modes. For example, a mode transition from OFFLINE to OPERATE, will be performed as OFFLINE →STOP →CLEAR →OPERATE.

Auto-CLEAR	If an error occurs during the data exchange phase of the master, the 'Auto-CLEAR' function determines the subsequent actions. If this function has been disabled, the master remains in the OPERATE mode. If the function has been enabled, the master automatically changes the network to the CLEAR mode, in which the outputs of the assigned PROFIBUS DP slaves are switched to zero, i.e. the 'fail-safe' state. The master continues to read the inputs of the slaves.
Fail-safe State	

1-2 Setting up a PROFIBUS DP Network

1-2-1 Configuring the PROFIBUS Master

In order to operate a PROFIBUS network, each master in the network needs to be configured. This process of configuration involves

- setting up the network topology, i.e. assigning the slave devices with which the master will be exchanging data,
- defining the parameterization data, which the master will send to each of the slave devices, before process data exchange can commence
- defining the configuration data, i.e. defining the process data, which will be exchanged,
- setting up the bus parameters, which define the baud rate and the bus timing parameters.
- downloading the configuration setup to the master device.

Configuration Technology

The configuration process is usually facilitated by a special Computer based program, often referred to as a configurator. The configurator requires special configuration files, defining the configuration options for each device, which is to participate in data exchange. The files must be provided by the manufacturer of the device.

Two types of configuration technology exist:

- Configuration technology based on FDT/DTM technology
- Configuration technology based on GSD-files

1-2-2 FDT/DTM Technology

FDT/DTM Technology

The newer configuration tools are based on FDT/DTM technology.

FDT/DTM Concept

The FDT/DTM concept specifies the interfaces between the engineering systems called Field Device Tools (FDT), and the device-specific software components called Device Type Managers (DTM).

The FDT/DTM concept separates the device dependent functionality (which is in the DTM) from the application. It provides separate interfaces for device configuration, monitoring and maintenance solutions, which before largely depended on the manufacturer of the application. Because of this concept, FDT/DTM technology is not limited to PROFIBUS applications. In concept, any type of network can be configured and accessed, provided the appropriate DTMs are available.

FDT Container Application

A FDT container application facilitates configuration of network devices and parameterizing and/or manipulating their operational modes. All device dependent functionality is concentrated in the DTM.

FDT container applications can be stand-alone tools, or can be part of other engineering tools such web browsers providing FDT interfaces. Since FDT standardizes the interfaces, it allows devices from different manufacturers to be integrated in any automation system, regardless of the fieldbus system.

CX-Profibus is an example of a FDT container application. It is described in detail in the following sections.

Device DTM

DTMs are provided by the manufacturer of the device. A DTM is comparable to a printer driver, which allows interactive configuration and diagnostics.

The DTM provides not only the configuration, manipulation and monitoring functions for a device including the user interface functions, it also provides the connection technology to the device.

DTM Properties

In general, a DTM is a Microsoft COM-component, which can be executed from within a FDT container application. A DTM is not a stand-alone tool, it requires a FDT container application to be executed. The DTM provides a number of interface functions, through which it can be controlled and accessed in order to transfer data to or from the DTM.

A DTM provides all the options for configuration and monitoring of a device, which it can present to the user through its own user interface.

ActiveX User Interface

The user interface for a DTM is provided using ActiveX windows. Control of these windows is done by the DTM, but the FDT container application can request specific user input from the DTM, based on which the DTM will provide the necessary ActiveX windows. In general multi-language user interface windows, including DTM specific Help files are supported by the DTM.

XML based Data Transfer

Data transfer to and from a DTM is provided using XML-documents. The XML-documents are standardized for the communication between the FDT container application and for communication between DTMs.

An additional specification covers the definition of XML-data formats for the transfer of application specific data, such as PROFIBUS data.

Communication DTM

In general, a device configuration DTM is accompanied by a communication DTM. This specific DTM facilitates device specific communication, e.g. for downloading a configuration to a PROFIBUS Master Unit and/or for retrieving monitoring information from PROFIBUS Master Unit. It may incorporate the specific communication protocol, or rely on other available drivers.

CX-Profibus

CX-Profibus is a FDT container application. Together with this container application, OMRON provides five DTMs:

- A DTM to facilitate configuration and operation of the CS1/CJ1W-PRM21 PROFIBUS DP-V1 Master Units (As of Unit version 2.0).
- A DTM to facilitate configuration of the CS1/CJ1W-PRM21 PROFIBUS DP Master Units (Unit version 1.0).
- A DTM to facilitate configuration of the C200HW-PRM21 PROFIBUS DP Master Unit.
- A DTM to facilitate configuration of the SmartSlice GRT1-series GRT1-PRT PROFIBUS Communication Unit.
- A DTM to facilitate integration of GSD file based devices into CX-Profibus (see section 1-2-3 *GSD file Technology* for more information).

1-2-3 GSD file Technology

GSD file Technology

The older and most commonly used configuration technology is the based on GSD files (General Slave Data file). A GSD file is a text file, containing the characteristic features and configuration options of a device. The device data base file of each device is loaded in the configurator and downloaded to the master device.

GSD files are usually supplied with a Unit, or can be downloaded from the Internet, either from the manufacturer's site, or from the GSD library of the PROFIBUS International at <http://www.profibus.com>.

GSD File Language	<p>The language used in the GSD file is indicated by the last letter of the file extension, *.GS?:</p> <table><tr><td>Default</td><td>= GSD</td></tr><tr><td>English</td><td>= GSE</td></tr><tr><td>German</td><td>= GSG</td></tr><tr><td>Italian</td><td>= GSI</td></tr><tr><td>Portuguese</td><td>= GSP</td></tr><tr><td>Spanish</td><td>= GSS</td></tr></table> <p>The GSD files are prepared individually by the vendor for each type of device, according to a fixed format. Some parameters are mandatory, some have a default value and some are optional. The device data base file is divided into three parts:</p>	Default	= GSD	English	= GSE	German	= GSG	Italian	= GSI	Portuguese	= GSP	Spanish	= GSS
Default	= GSD												
English	= GSE												
German	= GSG												
Italian	= GSI												
Portuguese	= GSP												
Spanish	= GSS												
General Section	<ul style="list-style-type: none">• General specifications <p>This section contains the vendor name, the device name, hardware- and software release versions, device type and identification number, protocol specification and supported baud rates.</p>												
DP-master Section	<ul style="list-style-type: none">• DP master-related specifications <p>This section contains all parameters which only apply to DP master devices (e.g. maximum memory size for the master parameter set, maximum number of entries in the list of active devices, or the maximum number of slaves the master can handle).</p>												
DP-slave Section	<ul style="list-style-type: none">• DP slave-related specifications <p>This section contains all specification related to slaves (e.g. minimum time between two slave poll cycles, specification of the inputs and outputs, and consistency of the I/O data).</p> <p>For PROFIBUS DP-V1 devices this section also specifies what services for PROFIBUS DP-V1 are supported.</p>												
DTM versus GSD File	<p>When comparing the two configuration technologies, a GSD file only provides information on the device characteristics and configuration options. It has no GUI of its own, nor can it connect to the device itself. A GSD file always requires a separate configurator program to interpret the data. In the FDT/DTM concept all these device related functions are included in the DTM. The DTM can be executed from any program, which provides FDT interfaces.</p> <p>Sending PROFIBUS DP-V1 commands to a device from the configuration tool is only possible using DTM technology. The GSD file does not provide this means.</p>												

1-3 PROFIBUS Master Unit

1-3-1 PROFIBUS Master Unit Features

PROFIBUS Master Unit	The PROFIBUS Master Unit is a CPU Bus Unit, which can be installed on a CS1/CJ1 PLC System. There are two available models of the PROFIBUS Master Unit: the CS1W-PRM21 for connection to a CS1 PLC System and the CJ1W-PRM21 for connection to a CJ1 PLC System. Both models provide identical functionality.
CPU Bus Unit	A total of up to 16 CPU Bus Units can be mounted on the CPU Rack or an Expansion Rack. The total of 16 must include all PROFIBUS Master Units and all other CPU Bus Units
Unit Control and Status	<p>Up to 25 words of control and status words are exchanged between the PROFIBUS Master Unit and a dedicated CIO memory area, of which the location is related to the Unit Number. Control bits, allow the PLC program to switch the Unit between OFFLINE, STOP, CLEAR and OPERATE mode, which represent the main PROFIBUS DP modes of operation. The control words also allow for user initiated transmission of a Global-Control message over the PROFIBUS network to any group of slave devices.</p> <p>The remaining CIO words provide status and diagnostics information on the Unit itself, the PROFIBUS network and the slave devices.</p>
I/O Data	The total size of I/O data however, must not exceed the maximum I/O size of up to 7168 words, which it can exchange with the PLC memory. The I/O data can be distributed over up to two input areas and two output areas. Each of the input and output areas can be mapped to any location in the DM Area, CIO Area, WR Area, HR Area, or the EM banks.
FINS Messages	<p>The PROFIBUS Master Unit supports FINS message exchange with the PLC CPU to allow the transfer of Slave diagnostics data, the Error log, or to enable or disable communication with specific allocated slave devices, so that they can temporarily be taken out of the network for maintenance, without the PROFIBUS Master Unit reporting an error.</p> <p>As of Unit version 2.0, FINS commands have been implemented to support the transfer of data via acyclic PROFIBUS messages over the network. These messages can be used to change a slave device address, read slave device configuration, or to send and receive extended parameter data information.</p> <p>As of Unit version 3.0, a FINS command containing CIP data can be sent to other OMRON devices on the PROFIBUS network, using PROFIBUS DP-V1 Class 2 services. CIP or Common Industrial Protocol is protocol defined by ODVA, the Open Devicenet Vendor Association. Refer to their website for more information: http://www.odva.org/.</p>
PROFIBUS DP Class 1 Services	<p>The PROFIBUS Master Unit supports all mandatory Class 1 services defined in the PROFIBUS DP standard EN50170, Volume 2 for Master - Slave Communication. These functions includes the following services:</p> <ul style="list-style-type: none">• Set_Prm• Chk_Cfg• Slave_Diag• Data_Exchange• Global-Control (FREEZE, UNFREEZE, SYNC, UNSYNC, CLEAR) <p>The PROFIBUS Master Unit supports cyclic Master - Slave communications for networks with up to 125 slave devices. With each slave device it can exchange up to 244 bytes of input data and up to 244 bytes of output data.</p>

For diagnostics purposes the PROFIBUS Master Unit collects all Slave Diagnostics messages, which it can transfer to the PLC memory, using FINS commands. From every allocated slave device it can receive up to 244 bytes of diagnostics data.

PROFIBUS DP Class 2 Services

The PROFIBUS Master Unit also supports additional PROFIBUS DP Class 2 services defined in the PROFIBUS DP standard EN50170, Volume 2 for Master - Slave Communication. These functions includes the following services:

- Set_Slave_Addr
- Get_Cfg
- Rd_Inp
- Rd_Outp

These services can be invoked from the PLC CPU using FINS message communication.

PROFIBUS DP-V1 Services

The PROFIBUS Master Unit supports PROFIBUS DP-V1 Class 1 and Class 2 services. Additional parameter data can be written/read to and from PROFIBUS DP-V1 compatible slave devices. These services can be initiate either from the PLC CPU or from the associated DTM.

Configuration

Before the PROFIBUS Master Unit can control the PROFIBUS network, it must be configured, using the dedicated configuration program CX-Profibus. Without this configuration, the Unit will not be able to achieve data exchange, neither to send any acyclic messages. The configurator is explained in section 1-4 *CX-Profibus Configurator*.

Troubleshooting Functions

The PROFIBUS Master Unit is provided with a variety of troubleshooting functions for prompt recovery in case of errors:

- Extensive self-diagnostic function at startup
- Data exchange flags, indicating if I/O data is being exchanged with the slave devices
- Diagnostics flags, indicating if new Slave diagnostics data is available
- Extensive status and error flags, indicating the status of the Unit and the PROFIBUS network
- Error log for recording error history data.

1-3-2 Specifications

The CS1W-PRM21 and CJ1W-PRM21 are remote I/O Communication units providing PROFIBUS DP and PROFIBUS DP-V1 Master capabilities. The Unit version number on the side case of the housing indicates supported functionality. If no version number is shown, the version number is 1.0. The following table lists the functions supported per version number.

Alternatively, the PROFIBUS DP Master DTM can be used to obtain the Units version number, refer to section 3-3-1 Configuration User Interface.

PROFIBUS Master Unit Model

Applicable PLC	Model name	Unit classification	Unit Version	Supporting DTM version	Functions supported
CS Series CJ Series	CS1W-PRM21 CJ1W-PRM21	CPU Bus Unit	1.0	0.1.0.1 and up	<ul style="list-style-type: none"> PROFIBUS DP (Class 1) Master
			2.0	0.2.0.0 and up	<ul style="list-style-type: none"> PROFIBUS DP (Class 1) Master PROFIBUS DP (Class 2) Master PROFIBUS DP-V1 (Class 1) Master
			3.0	0.3.0.0	<ul style="list-style-type: none"> PROFIBUS DP (Class 1) Master PROFIBUS DP (Class 2) Master PROFIBUS DP-V1 (Class 1) Master PROFIBUS DP-V1 (Class 2) Master

- Note**
- Unit version 3.0 includes the same functions as Unit version 1.0 and 2.0, in addition to new PROFIBUS DP-V1 Class 2 related functions, and is backward compatible with Unit version 1.0 and 2.0. Unit version 3.0 will eventually replace Unit version 1.0 and 2.0.
 - Unless stated otherwise, specifications, descriptions and images in this manual apply to both Unit versions of the CS1W-PRM21 and CJ1W-PRM21 Units. The indication PROFIBUS Master Unit(s) will be used when referring to both unit types.

General Specifications

General specifications of the CS/CJ-series PROFIBUS Master Units conform to the general specifications for the SYSMAC CS/CJ-series CPU Units.

Functional Specifications

Item		Specification	
Installation	PROFIBUS Master Unit types	CS1W-PRM21	CJ1W-PRM21
	Applicable PLC series	CS-series	CJ-series
	Mounting position	<ul style="list-style-type: none"> CPU Rack, CS Expansion Rack (Excluding a C200H Expansion I/O Rack or SYSMAC BUS Slave Rack.) CS1D Duplex 	<ul style="list-style-type: none"> CPU Rack, CJ1 Expansion Rack
	Unit classification	CPU Bus Unit	
	Applicable unit numbers	0 to F (Hex)	
	Maximum number of Units per PLC	16	
	Current consumption	400 mA max at 5 Vdc	
	Dimensions (W x H x D)	35 x 130 x 101 mm	31 x 90 x 65 mm
	Weight	187g (typical)	100g (typical)

	Item	Specification
Environment	Ambient temperatures	Operating temperature: 0 to 55° C Storage temperature: -20 to 75° C
	Ambient operating humidity	10% to 90% (with no condensation)
	Vibration resistance	Conforms to IEC60068-2-6, test Fc. 10 to 54.8Hz, 0.25-mm amplitude, 54.8 to 300Hz, acceleration: 29.4 m/s ² in X, Y, and Z directions for 120 minutes each. (Total time: 12 linear sweeps x 10 minutes / sweep = 120 minutes)
	Shock resistance	Conforms to IEC60068-2-27, test Ea. 196 m/s ² three times each in X, Y, and Z directions
	Dielectric strength	600 VAC (between isolated circuits)
	Conformance to EMC and Electrical safety standards	EN61000-6-2: 2001 EN61000-6-4: 2001/CISPR11 EN61131-2:1994+a12:2000
Front case	Settings	Unit Number rotary switch, range: 0 ~ F (Hex)
	Indicators	7 LEDs, indicating Unit status and PROFIBUS status: Unit status: RUN (Green LED) ERC (Red LED) Host PLC status: ERH (Red LED) Configuration status: PRM (Green LED) PROFIBUS status: BST (Green LED) COMM (Green LED) BF (Red LED)
	PROFIBUS Connector	9-pin sub-D female connector (#4/40 UNC thread)
Memory area allocation	CIO Area words allocated for the CPU Bus Unit	Fixed allocation of 25 words per Unit. CIO 1500 + (25 x Unit number) CIO words provide: • 2 words for software switches • 1 word for the Global-Control • 21 words for the Unit and Slave statuses
	DM Area words allocated for the CPU Bus Unit.	Fixed allocation of 100 words per Unit. DM 30000 + (100 x Unit number) DM Area allocated to the Unit is reserved for future use.
	I/O Data allocations	Maximum total size: 7168 words I/O Data can be allocated to up to 2 input areas and 2 output areas. Input and output areas can be mapped to CIO, DM, WR, and HR Areas, as well as EM banks. Mapping must be defined through configurator.
	PROFIBUS DP-V1 status flags	DPV1 Connection/Abort status flags: 16 words. The status flags can be mapped to CIO, DM, WR, and HR Areas, as well as EM banks. Mapping must be defined through configurator.
FINS messaging	Reading slave device diagnostics	The MEMORY AREA READ (0101) FINS command can be used to obtain the last received Slave Diagnostics message.
	Reading and controlling the error log	Catalogues the history of error events. The Unit supports the following Error Log related FINS commands: • ERROR LOG READ • ERROR LOG CLEAR
	Device state changes	Allocated slave devices can be disabled and enabled in order to temporarily remove them from data exchange services. The Unit supports the following FINS commands to implement this: • RUN • STOP

	Item	Specification
FINS messaging	PROFIBUS DP messages (See Note 3)	The PROFIBUS MESSAGE SEND (2809) FINS command can be used to send PROFIBUS DP and PROFIBUS DP-V1 messages over the PROFIBUS network from the CS1/CJ1 PLC CPU. The following services can be initiated: PROFIBUS DP services: <ul style="list-style-type: none"> • Get_Cfg • Set_Slave_Add • Rd_Inp • Rd_Outp PROFIBUS DP-V1 Class 1 services (See Note 1): <ul style="list-style-type: none"> • MSAC1 - Read • MSAC1 - Write PROFIBUS DP-V1 Class 2 services (See Note 2): <ul style="list-style-type: none"> • MSAC2 - Initiate • MSAC2 - Read • MSAC2 - Write • MSAC2 - Abort
	Explicit messages (See Note 3)	The EXPLICIT MESSAGE SEND (2801) FINS command can be used to send CIP based messages to OMRON slave devices using PROFIBUS DP-V1 Class 2 messages.
	Error history size and storage	The PROFIBUS Master Unit supports storage of up to 80 error events, including time stamps in volatile memory. 16 error events can be logged in non-volatile memory

Protocol Specification

	Item	Specification
PROFIBUS interface	Applicable standards	EN50170, Volume 2
	Protocol type supported	PROFIBUS DP, PROFIBUS DP-V1
	PROFIBUS Unit types	PROFIBUS DP-V1 Class 1 and Class 2 Master
	PROFIBUS Media type	RS-485, galvanically isolated from the PLC
	PROFIBUS Connector	9-pin sub-D female connector (#4/40 UNC thread) Termination according to EN50170 provided by the cable connector
	Unit device address range	0 ~ 125, set through the configurator (See Note 4)
	Number of slave devices supported	125 max, address range 0 ~ 125
	baud rates supported	Selectable through the configurator: <ul style="list-style-type: none"> • 9.6 kbit/s • 19.2 kbit/s • 45.45 kbit/s • 93.75 kbit/s • 187 kbit/s • 500 kbit/s • 1.5 Mbit/s • 3 Mbit/s • 6 Mbit/s • 12 Mbit/s
	Bus timing definitions	Calculated by the configurator

Item		Specification
PROFIBUS Services	PROFIBUS DP Master Class 1 - Slave cyclic services	<ul style="list-style-type: none"> • Set_Prm • Chk_Cfg • Data_Exchange • Slave_Diag • Global-Control - CLEAR <p>Global-Control, initiated from CIO Word. Can be addressed to all or a specified group of slave devices. Supported commands:</p> <ul style="list-style-type: none"> • SYNC • UNSYNC • FREEZE • UNFREEZE
	PROFIBUS DP Master Class 2 - Slave acyclic services available to the PLC	<p>Acyclic message services, initiated through FINS. Can be addresses to one slave device at a time (See Note 1). Supported PROFIBUS DP services:</p> <ul style="list-style-type: none"> • Get_Cfg • Set_Slave_Add • Rd_Inp • Rd_Outp
	PROFIBUS DP Master - Master services	Not supported
	PROFIBUS DP-V1 Master Class1 - Slave acyclic message services (See Note 1)	<ul style="list-style-type: none"> • MSAC1 - Read • MSAC1 - Write
	PROFIBUS DP-V1 Master Class2 - Slave acyclic message services (See Note 2)	<ul style="list-style-type: none"> • MSAC2 - Initiate • MSAC2 - Read • MSAC2 - Write • MSAC2 - Abort
I/O Data	Number of I/O module definitions	4000 max. over all configured slave devices
	Number of I/O data supported by Master	<p>Up to 244 bytes input and 244 bytes output max. per slave device (defined by slave device) Total sum of all I/O Data must not exceed 7168 words</p>
	Number of diagnostics data supported by Master	<p>Up to 244 bytes of diagnostics max. per slave device Diagnostic data is collected at the Unit, and can be obtained from the Unit using FINS messaging</p>
	Additional status flags	<p>DPV1 Connection/Abort status flags. The status flags - 16 words in total - can be mapped by the user to any PLC CPU memory location.</p>

- Note**
1. These functions are implemented as of Unit version 2.0.
 2. These functions are implemented as of Unit version 3.0.
 3. The maximum data length for FINS messages which are redirected to the PROFIBUS network is 1004 bytes.
 4. Although the Unit device address can be set to address 0, this number should not be used, since this number is reserved in FINS communication.

External Dimensions (mm)

CS1W-PRM21

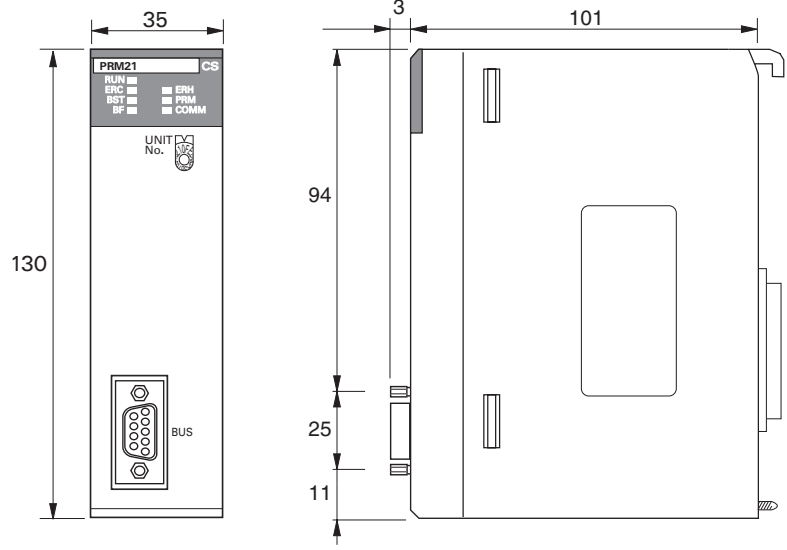

CJ1W-PRM21

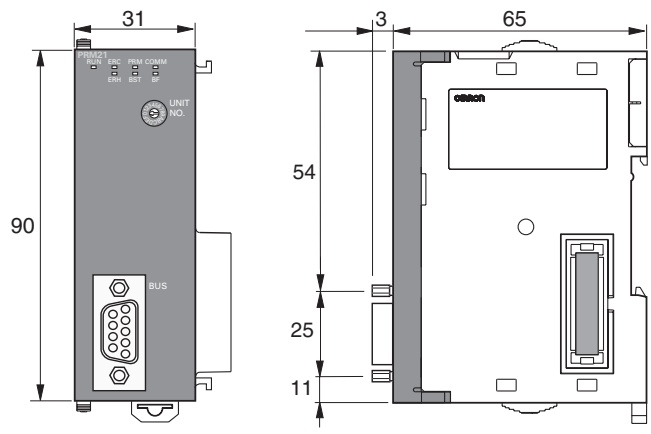

1-3-3 Comparison with Previous Model

The following table provides a comparison between the CS1W-PRM21/CJ1W-PRM21 PROFIBUS DP-V1 Master Units and their predecessor, the PROFIBUS DP Master used in a CS-series PLC

Item	C200HW-PRM21	CS1/CJ1W-PRM21 (Unit version 3.0)
Unit classification	C200H Special I/O Unit	CPU Bus Unit
Mounting position	<ul style="list-style-type: none"> CPU Rack, C200H I/O Expansion Rack, CS-series Expansion Rack Can not be mounted on a CS1D PLC	<ul style="list-style-type: none"> CPU Rack, CS/CJ-series Expansion Rack CS1W-PRM21 can be mounted on CS1D
Applicable Unit numbers	0 to F (Hex)	0 to F (Hex)
Maximum number of Units per PLC	16	16
Allocated CIO Area words	2,000 to 2,004 + (10 x unit number) Up to 4 CIO words contain: <ul style="list-style-type: none"> Command settings Unit Status and error flags Error reporting from the PROFIBUS interface 	1,500 to 1,524 + (25 x unit number) Up to 25 CIO words contain: <ul style="list-style-type: none"> Command settings Unit Status and error flags PROFIBUS status and error flags Slave status flags
Allocated DM Area words	D20000 to D20017 + (100 x unit number) The area contains user defined memory mapping of I/O data. At start up this area is transferred to the Unit	D30000 to D30099 + (100 x unit number) Not used on the Unit. Reserved for future use
I/O Data allocations	Maximum total size: 300 words per Unit I/O Data words can be allocated to up to 2 input areas and 2 output areas I/O size per area: up to 200 words Mapping / area size set in DM words: CIO: CIO 0000 to CIO 0235 CIO: CIO 0300 to CIO 0511 CIO: CIO 1000 to CIO 1063 HR: HR000 to HR099 DM: D00000 to D05999 Default mapping (DM words contain 0000): <ul style="list-style-type: none"> Output area: CIO 0050 to CIO 0099 Input area: CIO 0350 to CIO 0399 Diagnostic flags: CIO 0200 to CIO 0215 	Maximum total size: 7168 words per Unit I/O Data words can be allocated to up to 2 input areas and 2 output areas I/O size per area: up to 7168 words Mapping and area size set by configurator: CIO: CIO 0000 to CIO 6143 WR: W000 to W511 HR: HR000 to HR511 DM: D00000 to D32767 EM: E00000 to E32767 (Banks 0 to C) Default mapping: Not supported Note Diagnostics flags: available in allocated CIO Area words
Message communications	Message communication using IOWR and IORD PLC instructions: <ul style="list-style-type: none"> IOWR to send Global-Control command IORD to read slave diagnostics FINS message communication not supported	FINS message communication. Commands supported: <ul style="list-style-type: none"> MEMORY AREA READ to read slave device diagnostics message ERROR LOG READ, to read the Unit's error log ERROR LOG CLEAR to clear the Unit's error log RUN to enable communication with a slave device STOP to disable communication with a slave device PROFIBUS MESSAGE SEND to send messages over PROFIBUS network (Implemented as of Unit version 2.0). EXPLICIT MESSAGE SEND to send CIP-based messages over the PROFIBUS network to OMRON slave devices (implemented as of Unit version 3.0)

Item	C200HW-PRM21	CS1/CJ1W-PRM21 (Unit version 3.0)
Configuration connection method	Serial connection (RS232) directly to connector on the front of the Unit	Serial connection directly via PLC CPU, or via other I/O Units. No separate connector on the front of the Unit
PROFIBUS Media type	RS-485, galvanically isolated from the PLC	RS-485, galvanically isolated from the PLC
PROFIBUS Connector	9-pin sub-D female connector (#4/40 UNC thread) Termination provided through a switch on the unit according to EN50170	9-pin sub-D female connector (#4/40 UNC thread) Termination must be provided by the cable connector according to EN50170
Unit device address range	0 ~ 125, set through the configurator	0 ~ 125, set through the configurator
Number of slave devices supported on the network	125 max, address range 0 ~ 125	125 max, address range 0 ~ 125
Baud rates supported	Selectable through the configurator: <ul style="list-style-type: none"> • 9.6 kbit/s • 19.2 kbit/s • 93.75 kbit/s • 187 kbit/s • 500 kbit/s • 1.5 Mbit/s • 3 Mbit/s • 6 Mbit/s • 12 Mbit/s 	Selectable through the configurator: <ul style="list-style-type: none"> • 9.6 kbit/s • 19.2 kbit/s • 45.45 kbit/s • 93.75 kbit/s • 187 kbit/s • 500 kbit/s • 1.5 Mbit/s • 3 Mbit/s • 6 Mbit/s • 12 Mbit/s
Bus timing definitions	Calculated by the configurator	Calculated by the configurator
Master Class 1 - Slave cyclic services	<ul style="list-style-type: none"> • Set_Prm • Chk_Cfg • Data_Exchange • Slave_Diag • Global-Control - CLEAR 	<ul style="list-style-type: none"> • Set_Prm • Chk_Cfg • Data_Exchange • Slave_Diag • Global-Control - CLEAR
Master Class 1 - Slave services available to the PLC	Global-Control, initiated from CIO Word: Can be addressed to one or all slave devices or a specified group of slaves devices. Supported commands: <ul style="list-style-type: none"> • SYNC • UNSYNC • FREEZE • UNFREEZE • CLEAR 	Global-Control, initiated from CIO Word: Can be addressed to all slave devices or a specified group of slaves devices. Supported commands: <ul style="list-style-type: none"> • SYNC • UNSYNC • FREEZE • UNFREEZE
Master Class 2 - Slave acyclic services	<ul style="list-style-type: none"> • Get_Cfg • Set_Slave_Add • Rd_Inp • Rd_Outp 	<ul style="list-style-type: none"> • Get_Cfg • Set_Slave_Add • Rd_Inp • Rd_Outp (Implemented as of Unit version 2.0)
Master - Master services	Not supported	Not supported
PROFIBUS DP-V1 Master Class 1 - Slave services	Not supported	<ul style="list-style-type: none"> • MSAC1 - Read • MSAC1 - Write (Implemented as of Unit version 2.0)
PROFIBUS DP-V1 Master Class 2 - Slave services	Not supported	<ul style="list-style-type: none"> • MSAC2 - Initiate • MSAC2 - Write • MSAC2 - Read • MSAC2 - Abort (Implemented as of Unit version 3.0)
Error reporting	Error numbers are transferred to CIO word Internal logging not supported	Error numbers are logged internally and can be retrieved through FINS messages

1-4 CX-Profibus Configurator

1-4-1 CX-Profibus Features

CX-Profibus

The PROFIBUS Master Unit requires a configuration before it can exchange I/O data with the slave devices. For this purpose OMRON provides the CX-Profibus Configuration program, which runs under Microsoft Windows™ NT 4.0, Windows™ 2000 or Windows™ XP

Together with CX-Profibus, OMRON provides five DTM COM Objects:

- A DTM to configure the CS1/CJ1W-PRM21 PROFIBUS DP-V1 Master
- A DTM to configure the CS1/CJ1W-PRM21 PROFIBUS DP Master
- A DTM to configure the C200HW-PRM21 PROFIBUS DP Master
- A DTM to configure the SmartSlice GRT1-series GRT1-PRT.
- A DTM to allow the handling of classic GSD files in CX-Profibus

The following provides a quick overview of the functions.

CX-Profibus FDT Container Application

CX-Profibus provides an FDT environment in which DTMs can be executed. The main function of CX-Profibus is to facilitate the DTMs and the data exchange between them. It provides:

- Network setup functions: A tree view shows the relations between the DTMs, i.e. the relation between the Master and slave devices.
- Device Catalogue functions: A Device Catalogue containing the installed DTMs is maintained, to which the user can add new DTMs or delete them. Device DTMs can be added to the network from this Catalogue.
- Project maintenance functions: CX-Profibus provides the functions to create, save and open project files. It facilitates user access control, which limits of use to authorized personnel only, using password protection.
- Additional functions: CX-Profibus provides additional functions like printing, error logging, FDT Communication logging and help files.

CS1/CJ1W-PRM21 DTM

The two CS1/CJ1W-PRM21 DTMs provided to configure the CS1/CJ1W-PRM21 PROFIBUS DP Master Units and the CS1/CJ1W-PRM21 PROFIBUS DP-V1 Master Units both provide the same basic PROFIBUS DP functions. These DTMs consist of three parts:

- The Settings User Interface, which handles the configuration for the PROFIBUS Master Unit. This includes the bus parameters settings, the I/O data mappings and Master specific settings. The Settings DTM provides its own user interface.
- The Monitoring User Interface, which handles the status monitoring and control over the PROFIBUS Master Unit, when it is on-line and communicating over the PROFIBUS network. It provides its own user interface to read out Master status flags and Error log, as well as Slave status flags and the Slave diagnostics messages received by the Unit. It also allows the user to send Global-Control messages over the network and to change the PROFIBUS Master Unit's mode on the PROFIBUS network.
- The communication interface between the CS1/CJ1W-PRM21 DTMs and CX-Server. CX-Server, provided with the CX-Profibus package, is the driver for communication between the PC and the PLC CPU.

**CS1/CJ1W-PRM21
PROFIBUS DP-V1 DTM**

In addition to the PROFIBUS DP functions, the CS1/CJ1W-PRM21 PROFIBUS DP-V1 DTM provides:

- A communication channel to the user to change a remote slave device address. This channel has its own user interface.
- Communication channels to facilitate data transfer through PROFIBUS DP-V1 MSAC1 acyclic message transfer between a PROFIBUS DP-V1 slave device DTM and the physical slave device.
- Communication channels to facilitate data transfer through PROFIBUS DP-V1 Class 2 acyclic message transfer between a PROFIBUS DP-V1 slave device DTM and the physical slave device. This also allows direct connection to third-party PROFIBUS slave devices supporting PROFIBUS DP-V1 Class 2, e.g. PROFIBUS PA devices.

C200HW-PRM21 DTM

The C200HW-PRM21 DTM allows configuration of the C200HW-PRM21 PROFIBUS DP Master Unit. This predecessor of the CS1/CJ1W-PRM21 can be used on existing C200H PLC CPU Systems as well as CS1 PLC Systems, except for the CS1D.

The C200HW-PRM21 DTM consist of three parts:

- The Settings User Interface, which handles the settings for the C200HW-PRM21 PROFIBUS DP Master Unit, including the bus parameters settings, and the I/O data mappings.
- The Monitoring User Interface, to handle the Unit's status monitoring. The DTM's user interface displays the Master status and Slave status.
- The communication interface between the two DTMs mentioned above and the serial communication driver, to the C200HW-PRM21 PROFIBUS DP Master Unit.

- Note**
1. This Operation Manual does not contain a detailed description of the C200HW-PRM21 Unit, only a description of the DTM. For more details on the C200HW-PRM21 refer to C200H-series PROFIBUS DP Master Units Operation Manual (W349-E2-□).
 2. The C200HW-PRM21 Unit and DTM do not support PROFIBUS DP-V1.

**SmartSlice GRT1-series
GRT1-PRT DTM**

SmartSlice GRT1-series GRT1-PRT DTM allows configuration of the GRT1-PRT PROFIBUS Communication Unit and SmartSlice I/O Units. The DTM provides the following user interfaces:

- The Configuration User interface to define the I/O configuration and parameter setting for I/O data exchange with the PROFIBUS Master Unit.
- Configuration User Interfaces to configure individual SmartSlice I/O Units attached to the GRT1-PRT.
- A monitoring User interface to monitor the status of the GRT1-PRT and individual SmartSlice I/O Units.

Generic Slave DTM

The Generic Slave DTM allows the handling of classic GSD files of up to GSD revision 3 within CX-Profibus. Upon allocating a slave device, for which only a GSD file is available to a Master Unit in the network, this DTM will be invoked. This DTM consists of two parts:

- The Settings User Interface will provide the user interface to display the device's information and the selectable values, as defined in the GSD. After making the necessary configuration settings, and saving them, these will be transferred to the Master DTM.
- The Monitoring User Interface will provide a diagnostics interface to the user, allowing him to check the Slave's status. This DTM obtains the necessary information from the PROFIBUS Master Unit's monitoring DTM.

Note The Generic Slave DTM provides parameter settings related to PROFIBUS DP-V1. However, it does not support PROFIBUS DP-V1 communication.

Downloading the Configuration

After setting up the configuration, it must be downloaded to the PROFIBUS Master Unit. The type of serial connection to use for downloading, depends on the Unit:

- CS1/CJ1W-PRM21: Connection to the Unit is achieved through the serial port of the PLC CPU, using CX-Server. CX-Server also allows routing the download through multiple systems, if supported by these systems. The CS1/CJ1W-PRM21 does not support message routing.
- C200HW-PRM21: Connection to the C200HW-PRM21 is achieved through a serial RS-232c Connection between one of the PC's Serial COM Ports and the dedicated configuration connector at the front of the Unit. For details, refer to the C200HW-PRM21 Manual: W349-E2-2. The figure below shows the connection methods, for both types.

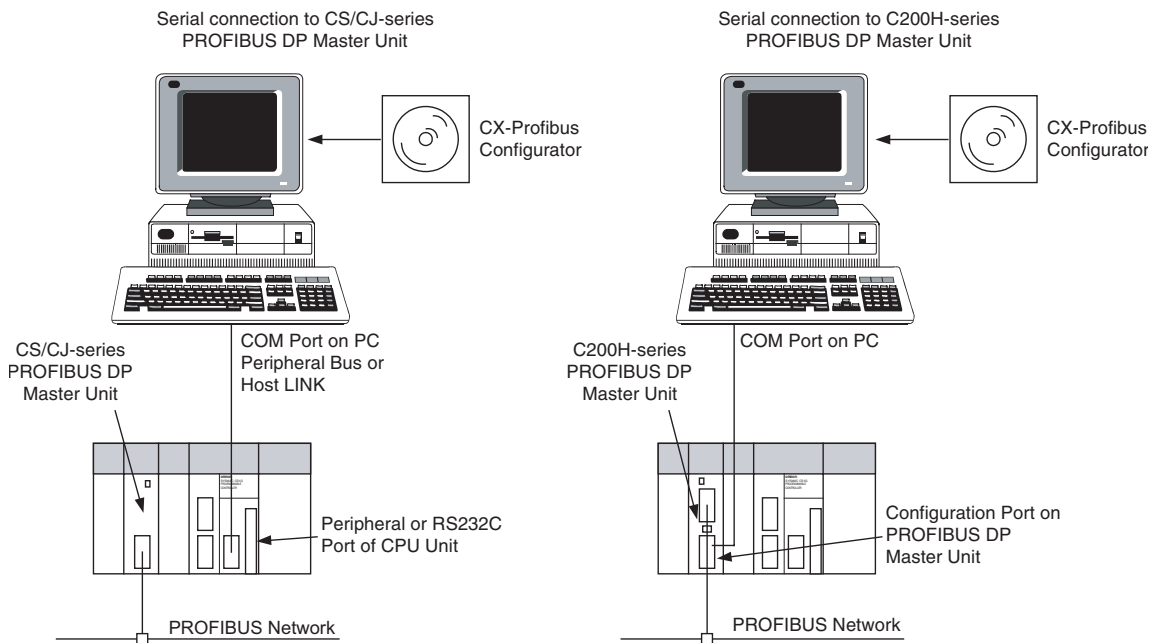

1-4-2 Specifications

Functional Specifications

Item		Specification
Operating environment	Model number	WS02-9094G
	Hardware platform	<ul style="list-style-type: none"> • Personal computer: IBM PC/AT or compatible • Processor: Pentium 500 MHz or higher • Memory: 256 Mbytes • Hard disk: A minimum of 256 Mbytes • CD-ROM drive • Graphics resolution: 800 x 600 pixels minimum • Serial port: RS-232C
	Operating System	<ul style="list-style-type: none"> • MS Windows NT4.0, SP6 • MS Windows 2000, SP2 • MS Windows XP <p>Note Internet Explorer 5.01 is also required.</p>
	Connection to CS1/CJ1W-PRM21	<ul style="list-style-type: none"> • Peripheral or RS-232C port of PC with PLC CPU. Serial communications mode: Peripheral bus, Host Link, Toolbus, supported by CX-Server. • Communication cable: Cable CS1W-CN226 to connect to the peripheral port on the CPU (Not included in package).
	Connection to C200HW-PRM21	<ul style="list-style-type: none"> • RS-232C port of PC with Configuration port on the Unit.
CX-Profibus	General Project functions	<p>File handling: CX-Profibus supports overall handling of project files as well as network data.</p> <ul style="list-style-type: none"> • New: Start a new project. • Open: Open an existing project file. • Save (As): Save a project file. • Export: Export project data to HTML. • Properties: Edit project property information.
		<p>User management: Functionality of CX-Profibus can be limited as defined by several password protected access levels:</p> <ul style="list-style-type: none"> • Administrator • Planning engineer • Maintenance • Operator • Observer
	Network setup functions	<p>CX-Profibus provides network tree view, from which hierarchy between Master and slave devices can clearly be distinguished.</p>
		<p>The following network functions are available:</p> <ul style="list-style-type: none"> • Network DTMs (i.e. devices) can be added or deleted, using drag and drop from the Device Catalogue. • Network DTMs can be copied and moved from one location to another in the network view. • DTM names can be edited by the user. • Any change to the parameters of a DTM is clearly marked in the tree view, until the project is downloaded to the Master Unit.
	Device Catalogue functions	<p>The Device Catalogue maintains the installed device DTMs. After installation of a new DTM, the user must refresh the database. The Device Catalogue provides the following functions:</p> <ul style="list-style-type: none"> • Update Device Catalogue. • Add device DTMs to the network directly. • Install a GSD file. This function allows copying of GSD files to a specific directory, after which they are available for the Generic Slave DTM.
Support functions	<p>CX-Profibus provides the following additional support functions:</p> <ul style="list-style-type: none"> • Context sensitive help functions. • Error logging. • Monitoring of FDT communication between DTMs. • Multi-language support. 	

	Item	Specification
CS1/CJ1W-PRM21 DTM	Device setup	Device setup allows the user to: <ul style="list-style-type: none"> • Select the PROFIBUS Master Unit's unit number. • Configure the communication link between the PC and the Unit. This function invokes the user interface of CX-Server. • Test the Units communication link and read out the Unit's information.
	Master setup	It allows enabling of Auto Addressing, to facilitate I/O data mapping, as well as defining the Unit's behaviour in case of <ul style="list-style-type: none"> • a network malfunction. • PLC mode changes between PROGRAM and RUN/MONITOR mode.
	Bus parameter setup	The bus parameter setup allows the selection of baud rate and calculation and editing of specific bus parameters.
	Slave area setup	The Slave area setup allows the user to define the I/O Data mapping of the I/O Data from each of the slave devices on to PLC memory areas.
	Monitoring functions	<ul style="list-style-type: none"> • Master status read out. • Slave status and slave diagnostics read-out. • Read out of the Unit's error log.
	Additional Master functions	<ul style="list-style-type: none"> • Set remote slave address. • Communication channels for PROFIBUS DP-V1 MSAC1 messages. • Communication channels for PROFIBUS DP-V1 MSAC2 messages. <p>Note These functions are implemented as of Unit version 3.0.</p>
	Support functions	<ul style="list-style-type: none"> • Context sensitive help functions. • Multi-language support.
C200HW-PRM21 DTM	Bus parameter setup	The bus parameter setup allows the selection of baud rate and calculation and editing of specific bus parameters.
	Address mapping setup	The address mapping setup shows an overview of the mapping of the I/O data of each Slave on to the Unit's memory. The mapping can be accomplished automatically, but the function also allows editing of individual address mappings.
	Monitoring functions	<ul style="list-style-type: none"> • Master status read out. • Slave status read-out.
	Support functions	<ul style="list-style-type: none"> • Context sensitive help functions. • Multi-language support.
Generic Slave DTM	Support functions	<ul style="list-style-type: none"> • Context sensitive help functions. • Multi-language support.
	I/O configuration setup	The I/O configuration setup function allows: <ul style="list-style-type: none"> • Selection of device address. • Enable/disable watchdog. • Overview of available I/O modules. • Selection of I/O modules, including Addition, Insertion and Removal of multiple modules.
	Parameter setup	The Parameter setup function: <ul style="list-style-type: none"> • Setting of common as well as module dependent parameters. • Setting of PROFIBUS DP Extension parameters. • Setting of PROFIBUS DP-V1 dependent parameters.
	Group setting	The Group setup function allows definition of the group to which the associated slave device will belong.
	Monitoring functions	The Monitoring functions provides a display of <ul style="list-style-type: none"> • Standard Slave diagnostics flags. • Extended diagnostics messages.
	Support functions	<ul style="list-style-type: none"> • Context sensitive help functions. • Multi-language support.

Note For more information on the GRT1-PRT DTM, refer to the SmartSlice GRT1-series GRT1-PRT PROFIBUS Communication Unit Operation Manual (W04E-EN-□).

1-5 Basic Operating Procedure

1-5-1 Overview

The following diagram provides an overview of the installation procedures. For experienced installation engineers, this may provide sufficient information. For others, cross-references are made to various sections of this manual where more explicit information is given.

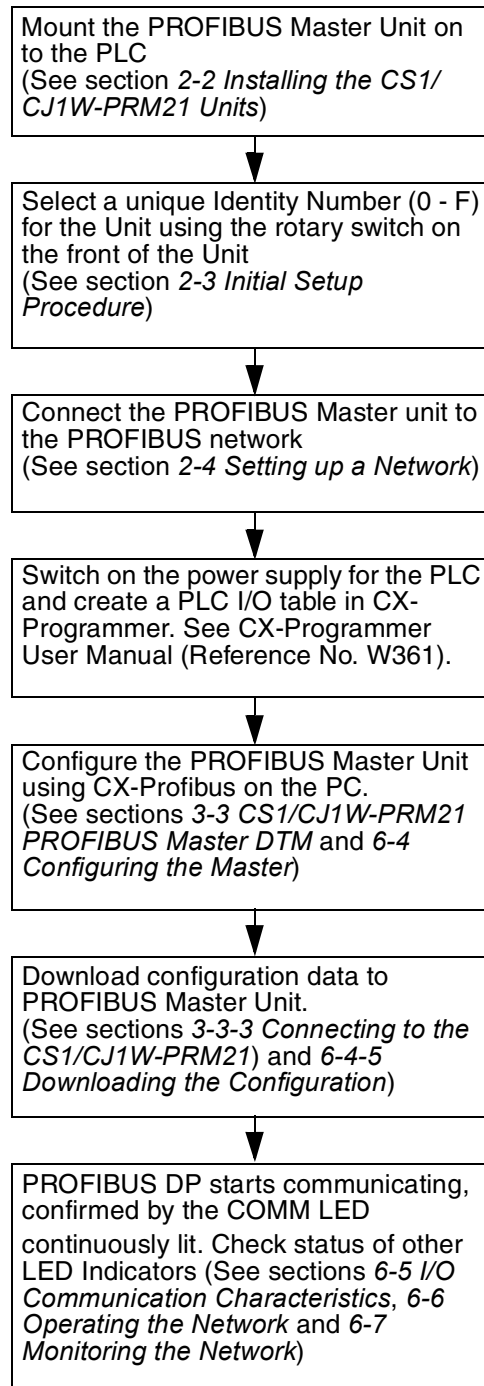

1-5-2 Preparations for Communications

- 1,2,3...**
1. Mount the Master Unit on the PLC system (refer to *2-2 Installing the CS1/CJ1W-PRM21 Units*).
 - Treat the Unit as a CPU Bus Unit.
 - It can be mounted to a CPU Rack or Expansion Rack.
 - Number of Units: 16 (Max).
 2. Set the Unit No. (UNIT No.) for the PROFIBUS Master Unit (refer to *2-3-1 Selecting a unit number*).
 3. Connect a PC or a Programming Device to the PLC and turn ON the power supply to the PLC.
 4. Generate the I/O tables and restart the PLC (refer to *2-3-2 Creating an I/O table*).
 5. Install CX-Profibus, and the DTMs on to the PC.

1-5-3 Procedures Prior to Starting Communications

Use the following procedure to configure the Unit using CX-Profibus:

- 1,2,3...**
1. Wire the network, to connect the PROFIBUS Master Unit to the slave devices.
 2. Turn ON the PLC power supply and the power supplies of the slave device on the network.
 3. In CX-Profibus, create a network and define the parameters and I/O configurations for the PROFIBUS Master Unit settings and the allocated slave devices. Determine the baud rate and the bus parameter setup. Make sure that the "Go to OPERATE mode" option is selected, to force the Unit to OPERATE mode upon a PLC mode change to RUN / MONITOR mode.
 4. Download the network configuration to the PROFIBUS Master Unit. After downloading the configuration, CX-Profibus will restart the PROFIBUS Master Unit.
 5. After restarting the PROFIBUS Master Unit it will automatically start communication.

SECTION 2

Installation and Wiring

This section shows the PROFIBUS device and identifies its controls and indicators. It contains the procedures for installing the CS1/CJ1W-PRM21 PROFIBUS Master Unit on the PLC System and setting up the PROFIBUS network.

2-1	Unit Components	28
2-1-1	Nomenclature	28
2-1-2	Indicators	29
2-1-3	Switch Settings	30
2-1-4	PROFIBUS Connector	31
2-2	Installing the CS1/CJ1W-PRM21 Units	32
2-2-1	Handling Precautions	32
2-2-2	Mounting the CS1W-PRM21	32
2-2-3	Mounting the CJ1W-PRM21	34
2-3	Initial Setup Procedure	35
2-3-1	Selecting a unit number	36
2-3-2	Creating an I/O table.	36
2-4	Setting up a Network.	37
2-4-1	Network Structure.	37
2-4-2	Bus Termination	39
2-4-3	PROFIBUS Cable Connector	40
2-4-4	Shielding Precautions	41
2-5	Defining PROFIBUS DP in the Software.	41

2-1 Unit Components

2-1-1 Nomenclature

The illustration below shows the Status LED indicators, the Unit number selector switch, and a 9-pin female sub-D connector on the front side of the CS1W-PRM21 and the CJ1W-PRM21 Units. Each of these components are explained in the following sections

CS1W-PRM21

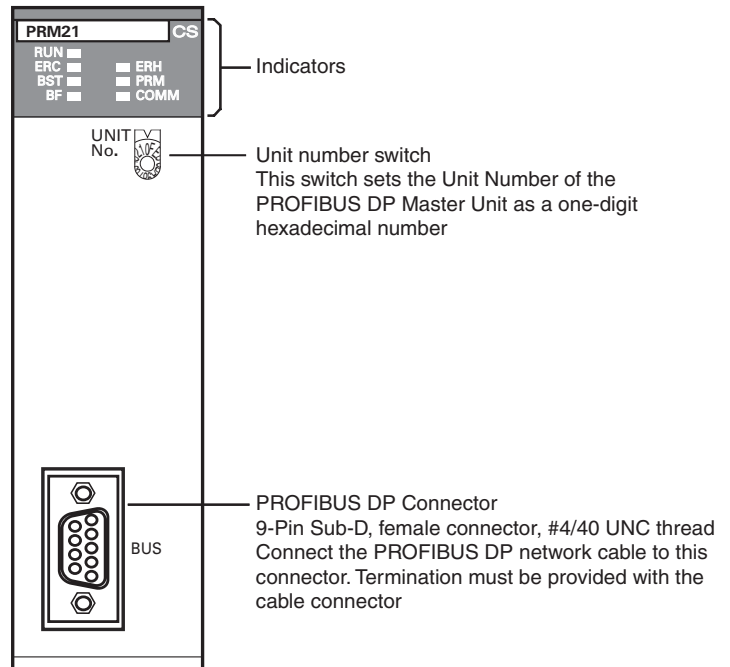

CJ1W-PRM21

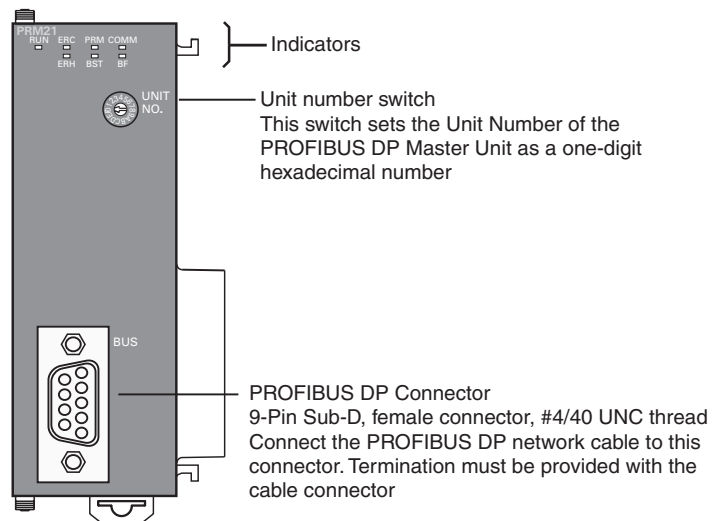

2-1-2 Indicators

The CS1/CJ1W-PRM21 PROFIBUS Master Units are each fitted with seven LEDs to indicate the operational mode and status of the Unit and the PROFIBUS network

CS1W-PRM21

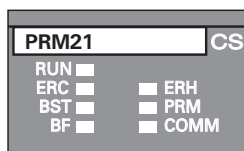

CJ1W-PRM21

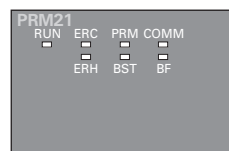

Indicator Specifications

Indicator	Colour	Status	Meaning
RUN	Green	Not lit	<ul style="list-style-type: none"> Startup test failed, Unit not operational. Operation stopped, due to a fatal error.
		Lit	Initialization successful, Unit is in normal operation.
ERC (PROFIBUS Master Unit Error)	Red	Not lit	Unit is in normal operation.
		Lit	One of the following errors occurred: <ul style="list-style-type: none"> Startup error. Non-volatile memory error (checksum failed, write-verify failed). Invalid PROFIBUS parameter configuration setting. Fatal error in program execution.
ERH (PLC Error)	Red	Not lit	PLC CPU in normal operation.
		Lit	One of the following errors occurred: <ul style="list-style-type: none"> PLC CPU Bus error. Cyclic Refresh Monitor Time-out. Routing table error.
PRM (Parameter database)	Green	Not lit	PROFIBUS Parameter configuration is not available or incorrect.
		Flashing	PROFIBUS Parameter configuration is being transferred to the Unit and is not yet available.
		Lit	PROFIBUS Parameter configuration is correct, and operational.
BST (Bus status)	Green	Not lit	The PROFIBUS Master Unit is in OFFLINE or STOP mode.
		Flashing	The PROFIBUS Master Unit is in CLEAR mode.
		Lit	The PROFIBUS Master Unit is in OPERATE mode.
COMM (I/O Data communication)	Green	Not lit	No PROFIBUS data exchange with any of the allocated slaves.
		Flashing	Fatal error occurred (ERC LED is ON). Unit initialization failed.
		Lit	PROFIBUS data exchange ongoing with at least one allocated slave.
BF (Bus Fail)	Red	Not lit	No PROFIBUS communication errors occurred.
		Flashing	At least one allocated slave is not in data exchange with the Unit.
		Lit	An error occurred in the PROFIBUS interface of the Unit (see section 7-2 <i>Troubleshooting Using LED Indicators</i>).

Note Unless otherwise specified, the frequency of a flashing LED is 1 Hz (50% duty cycle).

2-1-3 Switch Settings

Setting the Unit Number

The unit number is used to identify individual CPU Bus Units when more than one CPU Bus Unit is mounted to the same PLC. The unit number must be unique for each CPU Bus Unit. Selecting a non-unique number for a CPU Bus Unit will prevent the PLC System from starting correctly.

CS1W-PRM21

CJ1W-PRM21

Setting range:
0 ~ F (Hexadecimal)



1. Turn OFF the power supply before setting the Unit number.
2. Set the switch to the new Unit number. Use a small screwdriver to make the setting, taking care not to damage the rotary switch. The unit number is factory-set to 0.
3. Turn ON the power again.

Note Always turn OFF the power to the PLC CPU before changing the Unit number setting. The Unit only reads the Unit number setting during the initialization following a power-up, but not following a software reset.

Note If the unit number is being set for the first time or changed, then an I/O table must be created for the PLC.

Unit Number and CPU Bus Unit Word Allocations

With CS/CJ-series PLCs, words are automatically allocated in the CIO Area and the DM Area. The PROFIBUS Master Unit uses these words for receiving control data from the CPU Unit and for notifying the CPU Unit of PROFIBUS Master Unit and communications status. The word addresses in the allocated areas for the CPU Bus Unit are important when creating the user program for using the PROFIBUS Master Unit. This must be considered when setting the unit number.

The CIO and DM Word allocations are discussed in detail in *4-2 Allocated CIO Area Words*. The tables below show the relation between the unit number and the allocated CIO Area and DM Area words.

Unit No. (decimal)	Allocated words	Unit No. (decimal)	Allocated words
0 (0)	CIO1500 to CIO1524	8 (8)	CIO1700 to CIO1724
1 (1)	CIO1525 to CIO1549	9 (9)	CIO1725 to CIO1749
2 (2)	CIO1550 to CIO1574	A (10)	CIO1750 to CIO1774
3 (3)	CIO1575 to CIO1599	B (11)	CIO1775 to CIO1799
4 (4)	CIO1600 to CIO1624	C (12)	CIO1800 to CIO1824
5 (5)	CIO1625 to CIO1649	D (13)	CIO1825 to CIO1849
6 (6)	CIO1650 to CIO1674	E (14)	CIO1850 to CIO1874
7 (7)	CIO1675 to CIO1699	F (15)	CIO1875 to CIO1899

DM Area Allocations

Unit No. (decimal)	Allocated words	Unit No. (decimal)	Allocated words
0 (0)	D30000 to D30099	8 (8)	D30800 to D30899
1 (1)	D30100 to D30199	9 (9)	D30900 to D30999
2 (2)	D30200 to D30299	A (10)	D31000 to D31099
3 (3)	D30300 to D30399	B (11)	D31100 to D31199
4 (4)	D30400 to D30499	C (12)	D31200 to D31299
5 (5)	D30500 to D30599	D (13)	D31300 to D31399
6 (6)	D30600 to D30699	E (14)	D31400 to D31499
7 (7)	D30700 to D30799	F (15)	D31500 to D31599

2-1-4 PROFIBUS Connector

The PROFIBUS connector on the front of the Unit is a 9-pin female sub-D connector, as recommended by the PROFIBUS standard EN 50170.

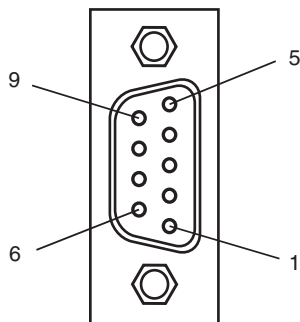

Pin No.	Signal	Description
1	Shield	Shield/protective ground
2	--	
3	RxD/TxD-P	Receive/Transmit data - plus (B wire)
4	RTS	Control signal for repeaters (direction control) (TTL)
5	DGND	Data ground (reference potential for VP)
6	VP	Supply voltage of the terminator resistance (5 Vdc)
7	--	
8	RxD/TxD-N	Receive/Transmit data - minus (A wire)
9	-	-

The signal RTS (TTL signal) is for the direction control of repeaters, which do not have a self-controlling capability.

The signals DGND and VP are used to power the bus terminator located in the cable connector.

Note The orientation of the sub-D connector allows the use of PROFIBUS connectors with a 90° angle cable outlet, e.g ERNI, Delconec and Phoenix.

Note The 9-pin sub-D connector uses #4/40 UNC thread, for mechanical fixation of the cable connector. Make sure that if non-standard PROFIBUS connectors are used, the corresponding thread is used on the cable connector.

2-2 Installing the CS1/CJ1W-PRM21 Units

2-2-1 Handling Precautions

When installing the PROFIBUS Master Unit on the PLC system, observe the following handling precautions

- Always turn OFF the power supply to the PLC before mounting or dismounting a Unit or connecting or disconnecting cables.
- Provide separate conduits or ducts for the I/O lines to prevent noise from high-tension lines or power lines.
- Leave the label on top of the Unit attached when wiring. Removing the label prior to wiring may result in malfunction if foreign matter enters the Unit.
- Remove the label after the completion of wiring to ensure proper heat dissipation. Leaving the label attached may result in malfunction.

2-2-2 Mounting the CS1W-PRM21

The CS1W-PRM21 PROFIBUS Master Unit can be mounted to any slot in either a CS-series CPU Rack, a CS-series Expansion CPU Rack or a CS1 Duplex CPU Rack. The CS-series PLC supports up to 7 Expansion CPU Racks, in addition to the CPU rack.

The number of slots to which PROFIBUS Master Unit can be mounted depends on the Backplane. Up to 16 PROFIBUS Master Units can be mounted to a single PLC system. If it is mounted in combination with other CPU Bus Units (e.g., Ethernet Units), the maximum total number of CPU Bus Units that can be mounted is 16.

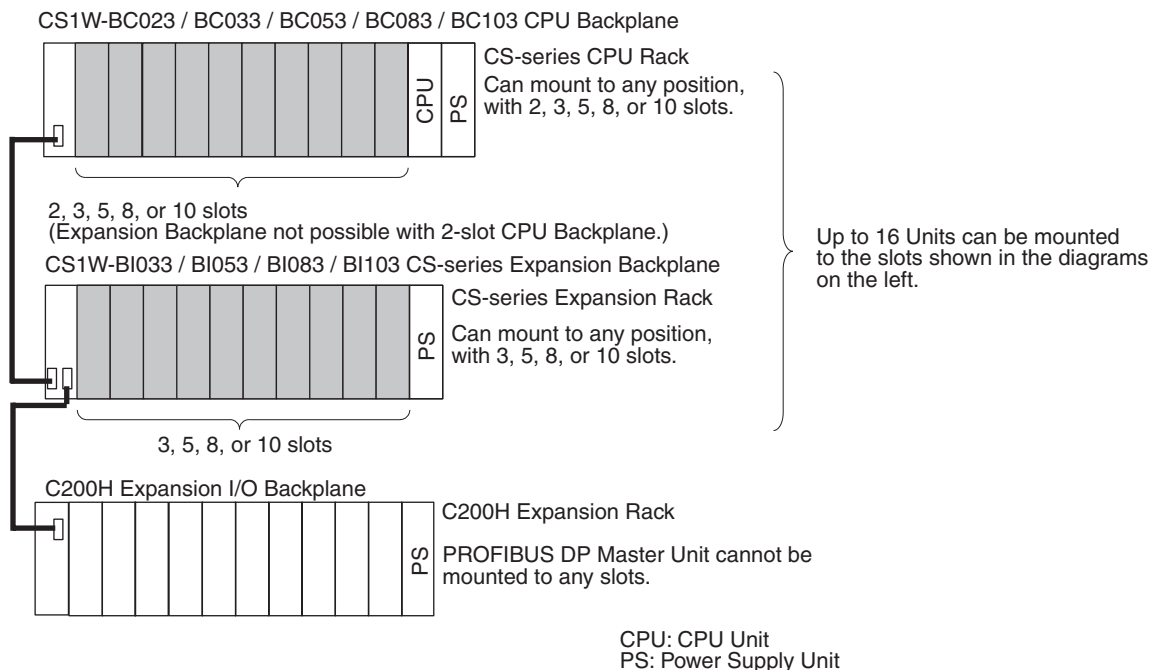

Note The CS1W-PRM21 PROFIBUS Master Unit's maximum current consumption is 400 mA. Make sure that the total current consumption of all the Units connected to the same CPU Backplane or Expansion Backplane does not exceed the output capacity of the Power Supply Unit.

Mounting Procedure

Mount the CS1W-PRM21 PROFIBUS Master Unit to the Backplane using the following procedure.

⚠ Caution Always turn OFF the power supply to the PC before mounting or dismantling a Unit or connecting or disconnecting cables.

- 1,2,3...** 1. Hook the claw on the top of the Unit onto the Backplane.

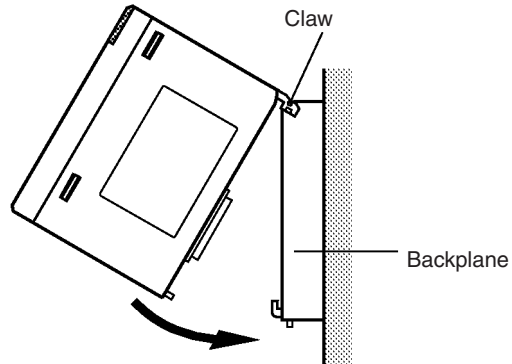

2. Insert the Unit into Backplane connectors and securely tighten the screw at the bottom of the Unit. Tighten the screws to a torque of 0.4 N•m.
 3. When removing the Unit, first loosen the screw at the bottom of the Unit.

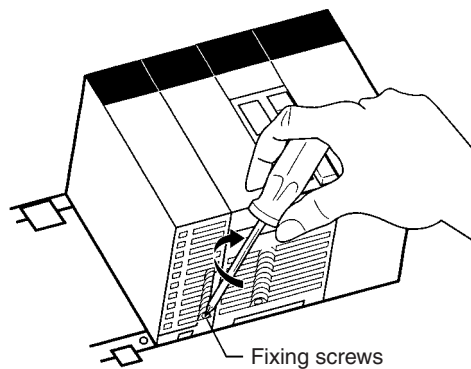

Note When mounting the Unit, provide the clearance shown below to facilitate easy mounting or dismantling.

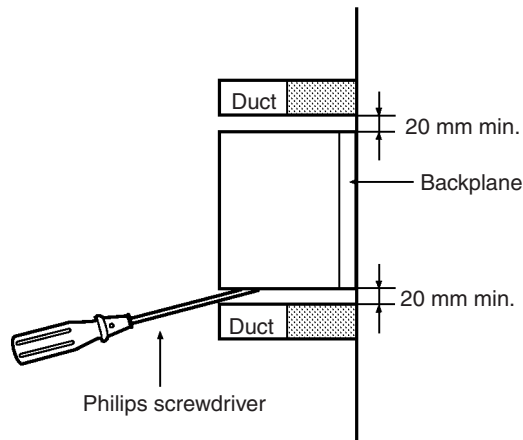

2-2-3 Mounting the CJ1W-PRM21

The PROFIBUS Master Unit can be mounted to any slot in either a CJ-series CPU Rack, or a CJ-series Expansion CPU Rack. The CJ-series PLC supports up to 4 Expansion CPU Racks, in addition to the CPU rack.

The number of slots to which PROFIBUS Master Unit can be mounted in any of the positions shown below using the sliders on the top and bottom of the Unit. Up to 16 PROFIBUS Master Units can be mounted to a single PLC. If it is mounted in combination with other CPU Bus Units (e.g., Ethernet Units), the maximum total number of CPU Bus Units that can be mounted is 16.

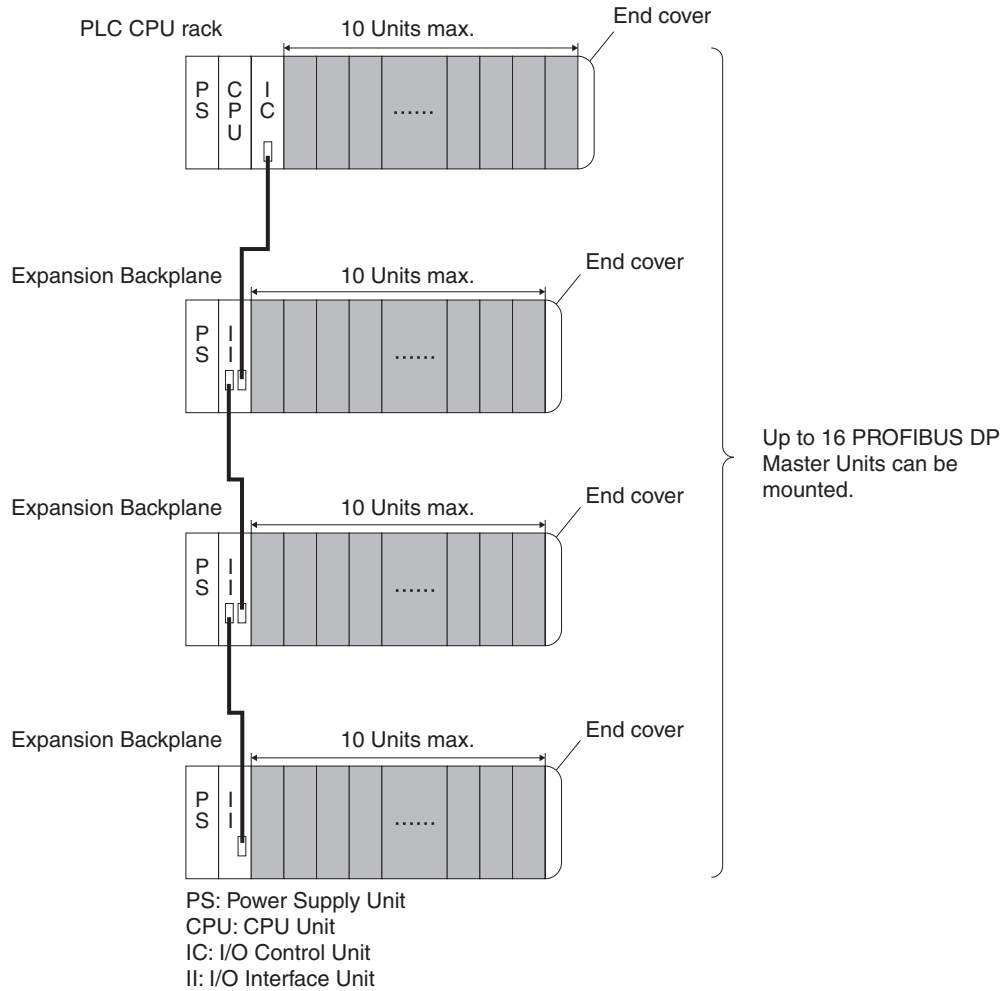

Note The CJ1W-PRM21 PROFIBUS Master Unit's maximum current consumption is 400 mA. Make sure that the total current consumption of all the Units connected to the same CPU Backplane or Expansion Backplane does not exceed the output capacity of the Power Supply Unit.

Mounting Procedure

Mount the CJ1W-PRM21 PROFIBUS Master Unit to the PLC using the following procedure.

1. Carefully align the connectors to mount the PROFIBUS Master Unit.

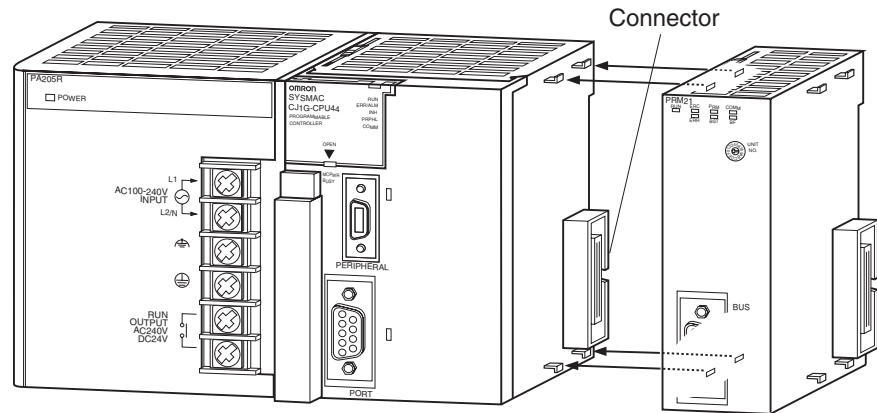

2. Move the yellow sliders on the top and bottom of the Unit until they click into position, to lock.

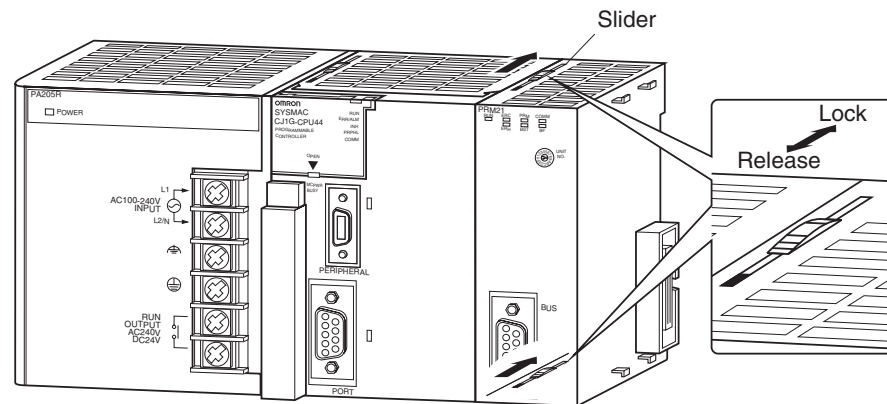

Note If the sliders are not securely locked, the PROFIBUS Master Unit functions may not operate correctly.

To dismantle the Unit, move the sliders to the “Release” direction.

2-3 Initial Setup Procedure

After mounting the PROFIBUS Master Unit to its PLC System, the following Initial Setup Procedure must be applied to allow the Unit to start up properly and to be configured for operation.

- A unique unit number must be selected, before the PLC’s power supply is turned on.
- An I/O table must be created in the PLC, in order to register the Unit on the PLC CPU.

2-3-1 Selecting a unit number

1. Make sure that the PLC Power Supply is turned OFF before setting the Unit number.
2. Set the switch to the desired unit number. Use a small screwdriver to make the setting, taking care not to damage the rotary switch. The unit number is factory-set to 0. Make sure that the unit number is unique on the PLC, i.e. there must be no other CPU Bus Units with the same unit number.
3. Turn ON the PLC Power Supply.

After setting the unit number, the PLC CPU must now register the PROFIBUS Master Unit, by creating an I/O table.

2-3-2 Creating an I/O table

An I/O table is used to identify Units connected to the PLC and to allocate I/O to them. The I/O table is stored within the PLC CPU, and loaded at start up. If any change is made to the Unit configuration of a CS/CJ-series PC, the I/O table must be created again to register the Units to the CPU Unit.

Connecting a Programming Device

To create the I/O table, connect a Programming Device (such as a Programming Console or CX-Programmer) to the PLC.

Applicable Programming Devices

The following Programming Devices can be used with CS/CJ-series PLCs.

Programming Console

Model number	Key Sheet (required)	Recommended cable (required)
C200H-PRO27-E	CS1W-KS001-E	CS1W-CN224 (cable length: 2.0 m) CS1W-CN624 (cable length: 6.0 m)

CX-Programmer and CX-Net

Model number: WS02-CXP□□-EV2

The operations are explained here using a Programming Console. For details regarding the CX-Programmer and the CX-Net, refer to the *CX-Programmer User's Manual*.

CX-Net is software that comes with CX-Programmer and is automatically installed when CX-Programmer is installed.

Connecting Programming Devices

To connect a Programming Console, attach a CS/CJ-series Key Sheet and then connect the Console to the CPU Unit's peripheral port. (It cannot be connected to the RS-232C port.)

Procedure for Creating an I/O Table

The procedure for creating an I/O table is shown here, taking as an example an I/O table that is generated automatically for a PLC connected online. In this example, a Programming Console is used for creating the I/O table. For an explanation of how to create an I/O table using a CX-Programmer, refer to the *CX-Programmer User's Manual*.

Use the following procedure to create the I/O table.

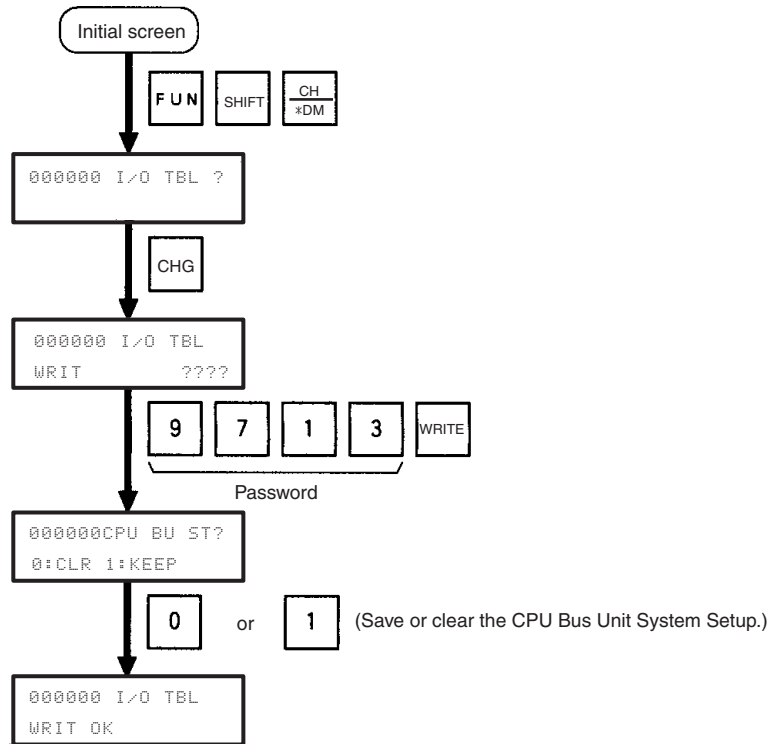

After creating the I/O table, the Unit is ready to be configured for first use on the PROFIBUS network.

Note After mounting the Unit and starting it up for the first time, the Unit's Configuration is empty. This will cause the red ERC LED on the front of the Unit to be switched ON. In this situation, the Unit can still be configured.

2-4 Setting up a Network

2-4-1 Network Structure

Communication Medium The PROFIBUS standard defines the use of EIA RS-485 as the main communication transport medium. The PROFIBUS Master Unit is designed to interface directly to this type of medium. This section will discuss the setup of networks based on this medium.

Note The other communication medium specified for PROFIBUS is optical fibre. The PROFIBUS Master Units does not provide a direct interface to this type of medium. However, by using third party couplers an interface between EIA RS-485 and optical fibre networks can be made.

Linear Bus Topology PROFIBUS DP defines the use of the Linear Bus Network Topology. The Bus must be terminated at both ends, and must not contain network branches. The total cable length of the bus depends on the cable and the selected baud rate. Also, RS-485 specifies a maximum of up to 32 devices - master and slave devices - per line segment. If more than 32 devices are to be connected, or if the total length of the segment must be extended beyond its maximum, repeaters must be used to link the separate segments.

Note Repeaters are devices which connect two segments. They do not have a device address of their own, but they do count in the total number of devices in a segment.

Repeaters

A maximum of up to three repeaters between two devices in a network can be used, i.e. a network can consist of up to 4 segments. The maximum number of PROFIBUS devices in such a network is then 122. The figure below shows an example of a two-segment network.

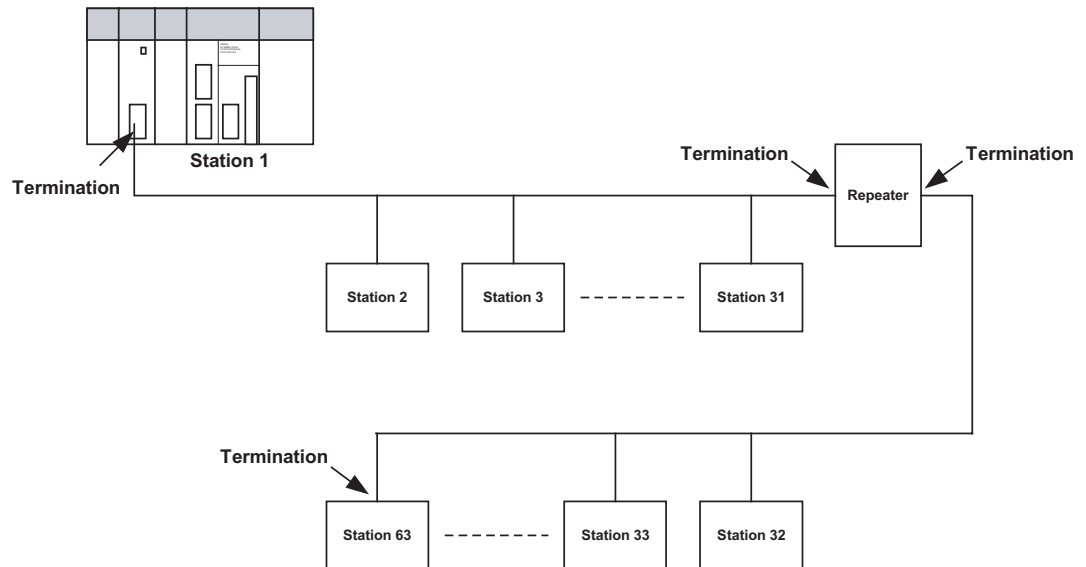

Tree Topology

The use of repeaters allows the extension of three or more Linear Bus segments into a Tree topology. In a tree topology more than three repeaters are allowed, provided that there are no more than three repeaters between any two devices in the network. The following figure presents an example of a network with more than three segments and repeaters.

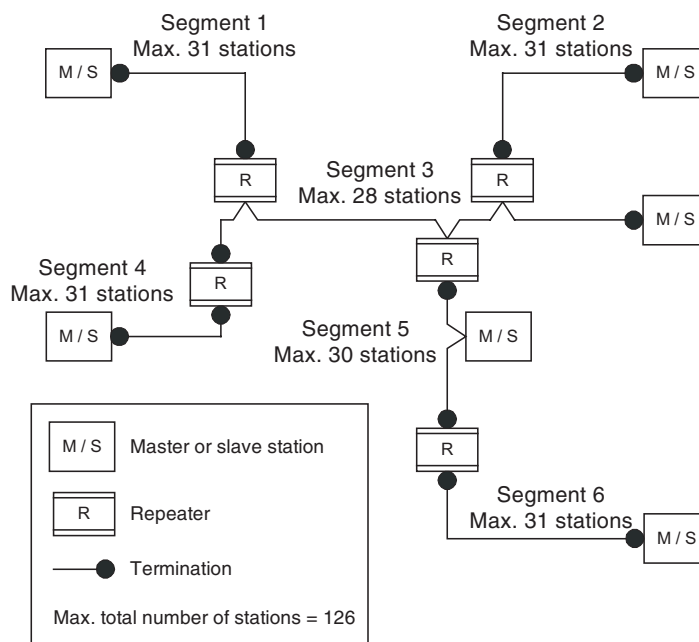

Cable Type

The PROFIBUS standard EN 50170 specifies Type A shielded, twisted- pair cable as the recommended cable type for use in an RS-485 based PROFIBUS network. This cable type has the following characteristics:

Characteristic	Value
Impedance	135 - 165 ohms
Capacitance per unit length	< 30 pF/m
Loop resistance	110 ohms/km
Core diameter	0.64 mm
Core cross section	0.34 mm ²

Note The PROFIBUS standard EN 50170 also specifies a Type B cable with different cable characteristics. Use of Type B cable is no longer recommended.

Maximum PROFIBUS Cable Length

The transmission speed defines the maximum advised cable distance or cable segment in metres before the use of a repeater is recommended. The cable lengths specified in the following table are based on PROFIBUS type A cable.

Baud rate (kbit/s)	Distance/segment (m)	Baud rate (kbit/s)	Distance/segment (m)
9.6	1200	500	400
19.2	1200	1500	200
45.45	1200	3000	100
93.75	1200	6000	100
187.5	1000	12000	100

- Note**
1. If network extension beyond the range of the advised cable length is required, the use of fibre optic cable to cross the larger distance should be considered.
 2. The recommended minimum cable length is 1 m.

Stub Lines

Passive Stub lines (branches from the main line) should be avoided for data transmission speeds of more than 500 kbit/s. Except at end devices with termination, it is recommended to always use plug connectors that permit two data cables to be connected directly to the plug. This method allows the bus connector to be plugged and unplugged at all times without interrupting data communication between other devices.

2-4-2 Bus Termination

Termination Resistors

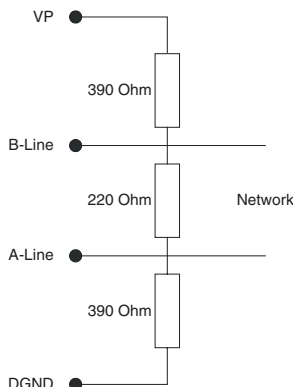

In order to minimize cable reflections and ensure a defined signal level on the data lines, the data transfer cable must be terminated at both ends with a terminating resistor combination. The bus termination diagram is shown on the left.

The bus terminator connects the two data lines via a 220 ohm resistor which, in turn, is connected to VP 5Vdc and DGND via two 390 ohm resistors. Powering the terminator resistor via VP 5V and DGND ensures a defined idle state potential on the data lines.

To ensure the correct functioning up to the highest baud rate, the bus cable must be terminated at both its ends.

A missing bus termination can cause errors during data transfer. Problems can also arise if too many bus terminators are fitted, since each bus terminator represents an electrical load and reduces the signal levels and thus the signal-to-noise ratio. Too many or missing bus terminators can also cause

intermittent data transfer errors, particularly if the bus segment is operated close to the specified limits for maximum numbers of devices, maximum bus segment length and maximum data transfer rate.

Inductors

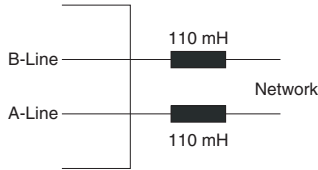

In addition to the bus termination, additional precautions must be taken to ensure proper operation at high baud rates, i.e. baud rates of 500 kbit/s and higher. Due to the capacitive load of the device and the resulting cable reflections, bus connectors must be provided with built-in series inductors, of 110 mH each, as shown in the figure on the left.

Installing the inductors applies to all devices on the network, and not only to the devices at both ends of the bus cable.

2-4-3 PROFIBUS Cable Connector

Bus Cable Connector

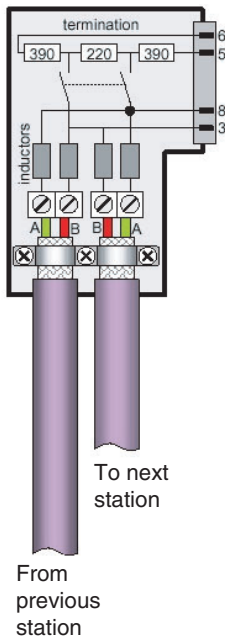

The plug connector to be used on the CS/CJ-series PROFIBUS Master Unit is a 9-pin male sub-D type, preferably encased in metal and having a facility to connect the shield of the cable to the case or to pin 1. The cable should be connected to the receive / transmit lines, pin 3 (B-line) and pin 8 (A-line).

The use of special PROFIBUS DP cable connectors, which are available from several manufacturers, is highly recommended. Various models are widely available, with or without the bus termination and inductors built-in. If provided in the connector, the Bus termination can often be enabled or disabled through a switch on the connector.

The special PROFIBUS DP cable connectors often provide a convenient way of connecting the cables. The figure on the left, provides an example of such a bus cable connector.

A standard 9-pin sub-D plug can only be used if the PROFIBUS Master Unit is not at the start or the end of a bus segment, or on a stub line at a baud rate of 500 kbit/s or less.

The two PROFIBUS data lines are designated A and B. There are no regulations on which cable core colour should be connected to which of the two data terminals on each PROFIBUS device; the sole requirement is to ensure that the same core colour is connected to the same terminal (A or B) for all devices throughout the entire system (across all devices and bus segments). The PROFIBUS Organization recommends the following rule for data line colour codes: PROFIBUS cables in general will use the colours red and green for the data lines, with the following assignment:

- Data cable wire A - green
- Data cable wire B - red

This rule applies to both the incoming and the outgoing data lines.

2-4-4 Shielding Precautions

Cable Shield Connection

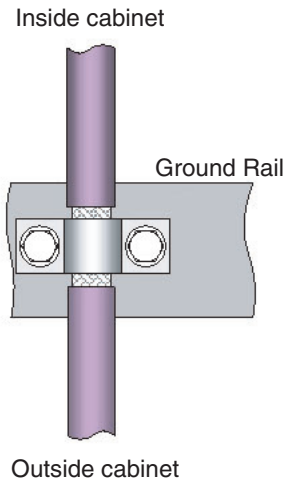

To ensure electro-magnetic compatibility (EMC), the shield of the cable should be connected to the metal case of the plug connector.

If the Unit is installed in a control cabinet, the bus cable shield should be brought into physical contact with a grounding rail using a grounding clamp or similar device. The cable shield should continue in the cabinet right up to the PROFIBUS device.

Ensure that the PLC and the control cabinet in which it is mounted have the same ground potential by providing a large-area metallic contact to ground, e.g. galvanized steel to ensure a good electrical connection. Grounding rails should not be attached to painted surfaces.

For further information regarding PROFIBUS network installation, please refer to "Installation Guideline for PROFIBUS DP/FMS" (PNO Order No. 2.112), which is available at every regional PROFIBUS Organization. The information covers:

- Commissioning of PROFIBUS equipment.
- Testing the PROFIBUS cable and bus connectors.
- Determining loop resistance.
- Testing for correct bus termination.
- Determining the segment length and cable route.
- Other test methods.
- Example of an equipment report in the PROFIBUS guideline.

2-5 Defining PROFIBUS DP in the Software

Defining the Configuration

After making the physical connections of the network, the configuration then has to be defined in the software. OMRON provides a dedicated PC-based configuration program, called CX-Profibus, as well as the required DTMs for this purpose. It can be used to:

- Define the master(s).
- Assign slaves to their respective master(s).
- Define I/O Configuration and parameters of individual slave devices.
- Define bus parameters, e.g. baud rate, target rotation time etc.

Downloading the Configuration

The system must be downloaded to the Master Unit after configuring it at the PC. This is made possible by either connecting the serial COM port of the PC to the CS1/CJ1 PLC with a serial interface cable, or use an ethernet connection between the PC and the CS1/CJ1 PLC via an ethernet unit or Controller Link unit.

SECTION 3

Configuration Software

This section contains the procedures for installing the configuration software. It also presents an overview of the Configuration software and discusses the main aspects of defining a PROFIBUS configuration. A more detailed description of the use of the Configuration software can be found in *SECTION 6 Operation*.

3-1	Installation	44
3-1-1	Installation Requirements	44
3-1-2	Installation Procedure	44
3-1-3	Installing the C200HW-PRM21 DTM	52
3-2	CX-Profibus	53
3-2-1	Starting CX-Profibus	53
3-2-2	CX-Profibus Main Window	54
3-2-3	Device Catalogue	57
3-2-4	Updating the Device Catalogue	59
3-2-5	Adding Devices to the Network	60
3-2-6	Saving and Opening Projects	60
3-2-7	Exporting to HTML	60
3-2-8	Error Logging and FDT Monitoring	61
3-2-9	Access Control and User Management	63
3-3	CS1/CJ1W-PRM21 PROFIBUS Master DTM	65
3-3-1	Configuration User Interface	65
3-3-2	Diagnostics User Interface	78
3-3-3	Connecting to the CS1/CJ1W-PRM21	84
3-4	C200HW-PRM21 PROFIBUS DP Master DTM	87
3-4-1	Configuration User Interface	87
3-4-2	Diagnostics User Interface	92
3-4-3	Connecting to the C200HW-PRM21	95
3-5	Generic Slave Device DTM	96
3-5-1	Configuration User Interface	97
3-5-2	Diagnostics User Interface	105

3-1 Installation

3-1-1 Installation Requirements

CX-Profibus Configuration software is required to configure the PROFIBUS Master Unit before operating the network. Without a valid configuration the PROFIBUS Master Unit will not be able to achieve data communication with the slave devices on the network.

The following are the minimum requirements for a PC to install the CX-Profibus configurator software:

- PC Pentium III or higher, 500 MHz minimum
- Operating System: Windows 2000 SP2 / Windows NT 4.0, SP6 / Windows XP
- RAM: 256 MB minimum
- Hard disk space: 256 MB minimum
- Graphics resolution: 1024 x 768 pixels minimum
- Serial port: RS-232C; COM1 to COM4 supported
- CD-ROM drive
- Communication cable: Cable CS1W-CN226 to connect to the peripheral port on the CPU (Not included with CX-Profibus)

3-1-2 Installation Procedure

This section explains how to install the CX-Profibus Configuration software and its components for the PROFIBUS Master Unit.

CX-Profibus CD-ROM

CX-Profibus is provided on a CD-ROM, which contains the following components:

- Microsoft .NET Framework
- CX-Profibus FDT Container application.
- CS1/CJ1W-PRM21 Configuration DTMs.
- CX-Server, to allow communication between the PC and the PLC.
- C200HW-PRM21 Configuration DTM.
- Generic Slave Device DTM, to allow slave configuration using GSD files.
- Additional GSD files for several OMRON slave devices.

- Note**
1. Any older version of CX-Profibus installed on the system, must be uninstalled, prior to installing the newer version.
 2. Provided with the CD-ROM is a 16-digit installation key, which can be found on a label on the CD-ROM box. The key is unique to the CD-ROM and is required to allow full installation of the software. The key is also used as reference when registering the purchased software with OMRON.
 3. If during installation the 16-digit License code was not entered, the program will run in demo mode, i.e. it provides all functionality, but for a limited period of 30 days. After this period has expired, the License code must be provided to the program, to allow continuation of use.
 4. During the limited period of 30 days, the valid License code, as shown on the CD-ROM case can be entered at anytime when the program is running, by selecting the **License** button in the **About** dialog window.
 5. Administrator rights are required to install CX-Profibus.

6. The operations and displays shown in the following procedure may differ slightly depending on the version of Windows software being used. The displays for Windows 2000 are shown here.

1,2,3...

1. Exit all other Windows-based programs.
2. Insert the setup disk (CD-ROM) into the CD-ROM drive.
3. Double-click **Setup.exe**.

The setup program for CX-Profibus will start. A progress dialog window is displayed, indicating progress of the setup as the program is loaded.

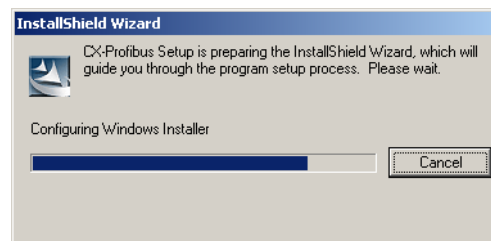

4. During the preparation, the InstallShield wizard will determine if the Microsoft .NET framework needs to be installed. This package is required during installation and for executing CX-Profibus. If already installed, the installation will be skipped, and the process will proceed with step 7. Installation of the Microsoft .NET framework first displays the License statement (shown below) to which the user must agree. Next, press the **Install** button to continue.

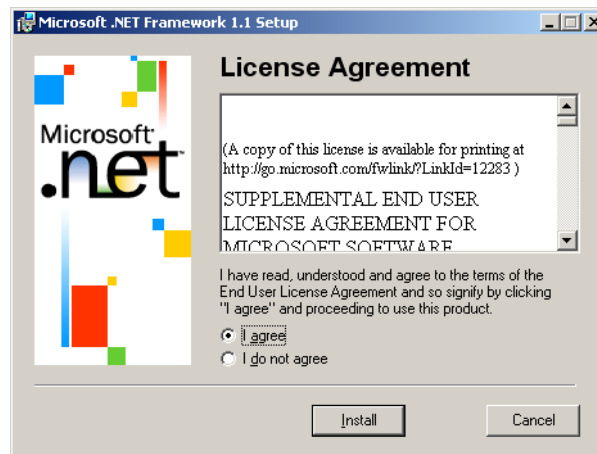

5. After starting the Microsoft .NET framework installation process, a window will be displayed showing the progress of this installation.

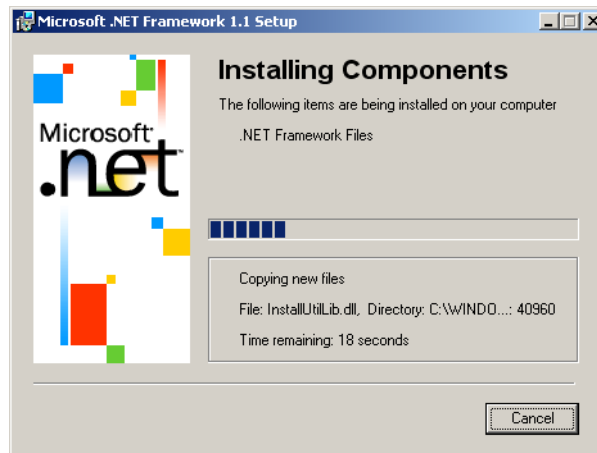

6. Completion of the Microsoft .NET framework installation is indicated by displaying the message window below.

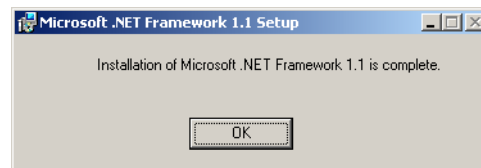

7. After installing the Microsoft .NET framework, CX-Profibus and its components will be installed. The installation welcome window as shown below will be displayed. Click the **Next** button to continue.

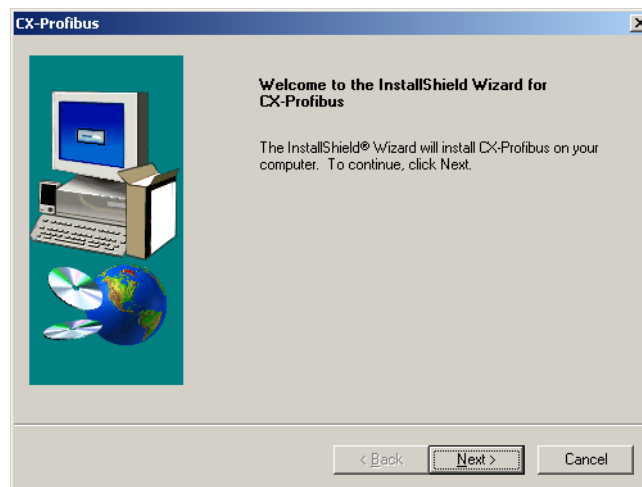

8. After the welcome window the window containing the License statement for CX-Profibus is displayed. The License window is shown below. Please read the License carefully, before selecting the **Yes** button to accept the

License. If the License is not accepted - by selecting the **No** button -, the installation will be terminated.

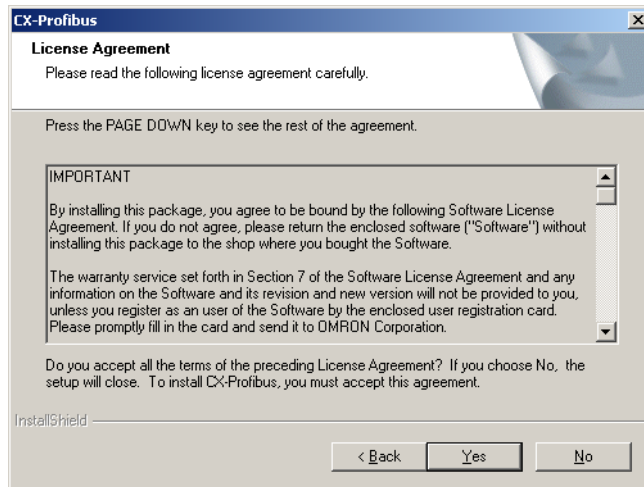

9. After accepting the License statement, the window below is displayed to allow you to enter your name, your Company name and the 16-digit License key provided on the back side of the CD-ROM case.

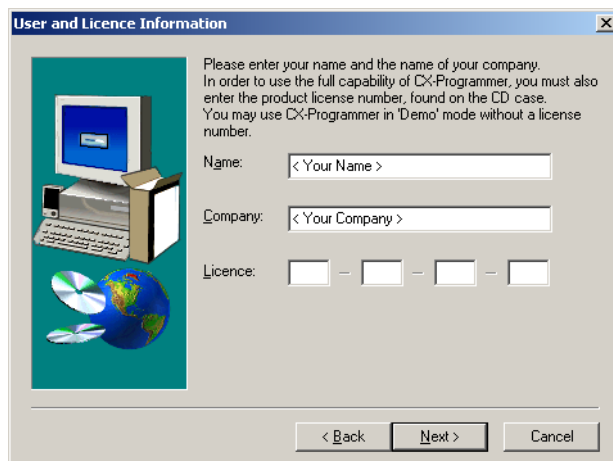

Note 1) If an incorrect 16-digit License code is entered, the program will display an error message, after which it allows you to re-enter the number again.

2) If no License code is entered, the program will still be installed, but it will run only for 30 days after installation. After this 30-day trial period, you will have to enter the required 16-digit License code in order to be able to run the program.

10. After entering the information a window will be displayed, allowing you to verify the entered information before installation commences. If the infor-

mation is correct, select the **Yes** button. Selecting the **No** button will revert you to the previous window.



11. After entering the correct License code, the installation process will first require you to select the language to be installed for CX-Profibus and its components. The windows shown below will be displayed, offering the choice of available languages. Select the desired language package and press the **Next** button.

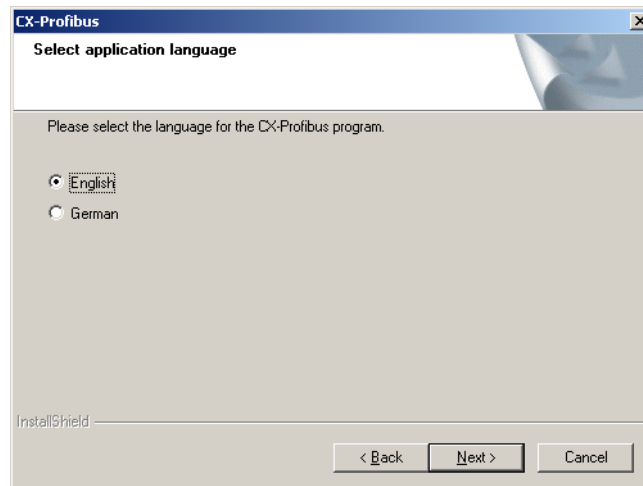

12. You are now required to specify the destination directory for the configurator files. If the default directory shown in the window is acceptable, click the **Next** Button. To specify a different directory, click the **Browse** Button, specify the desired directory, and click the **Next** Button. If a new directory is specified, the software will create it automatically.

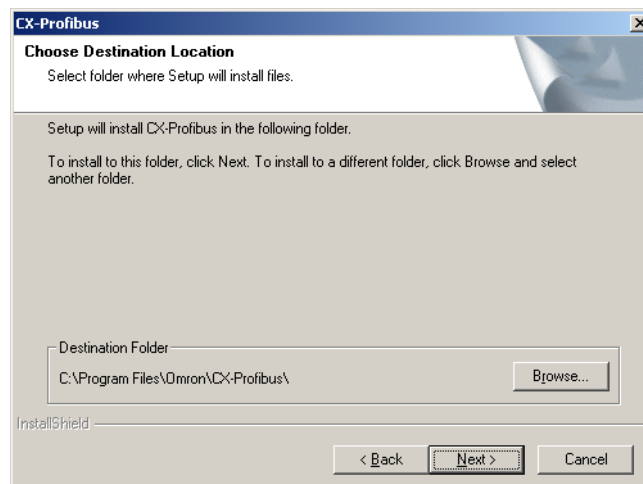

- Specify a Program Folder to which a shortcut to the program will be added. The default Program Folder is OMRON\CX-Profibus. You can specify any one of the other available Program Folders listed in the Existing Folders frame. After making the desired selection, select the **Next** button. The installation will now be performed, the files will be copied to the destination folder and the necessary registry entries will be made...

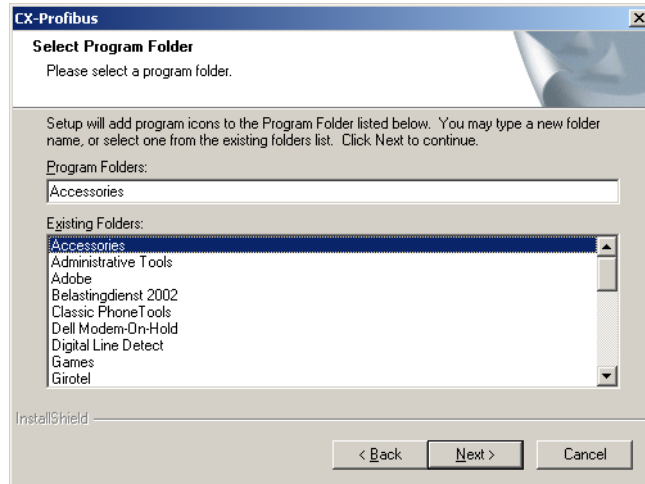

- A window is displayed showing the progress of the installation.,

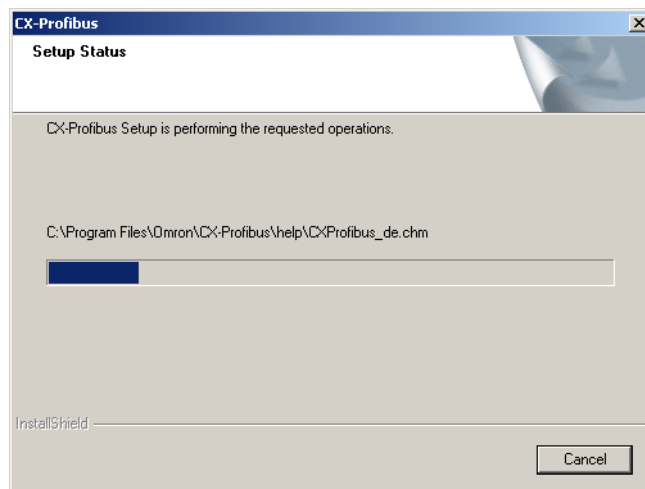

- After completing the CX-Profibus installation, the setup program will launch the CX-Server installation. The window shown below will be displayed. Select the **Yes** button to continue.

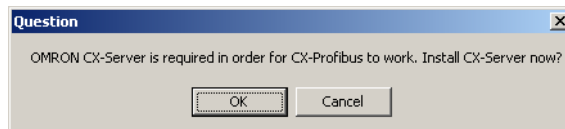

- The CX-Server installation program will detect whether CX-Server has been installed or not on the PC. If a newer version of CX-Server has been installed by another CX-Suite application program, the installation of CX-Server for CX-Profibus will be skipped. If an older CX-Server version has been installed, the installation will be performed. The window shown below

will be displayed, prompting the user for a selection of language to be used with CX-Server.

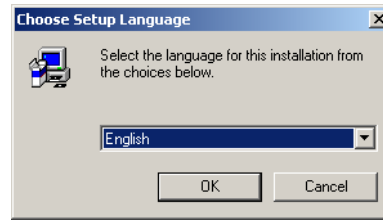

17. After selecting the language and pressing the **OK** button, the welcome window shown below will be displayed. Please take note of the recommendations, and make sure all other windows programs are closed before continuing.

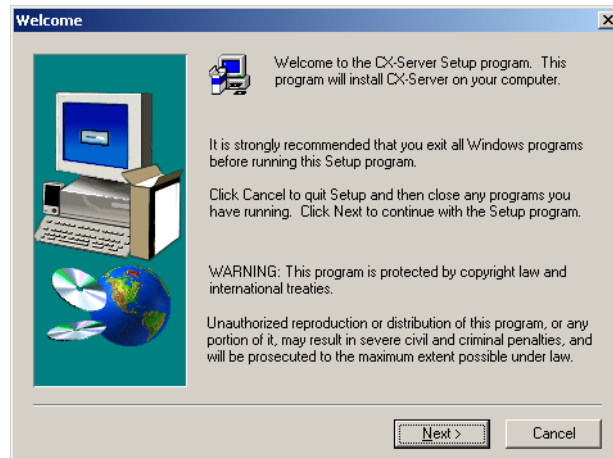

18. After pressing the Next button, the user is prompted for the directory in which to install CX-Server. Press the **Next** button to continue with the default directory, or the **Browse** button to select another directory.

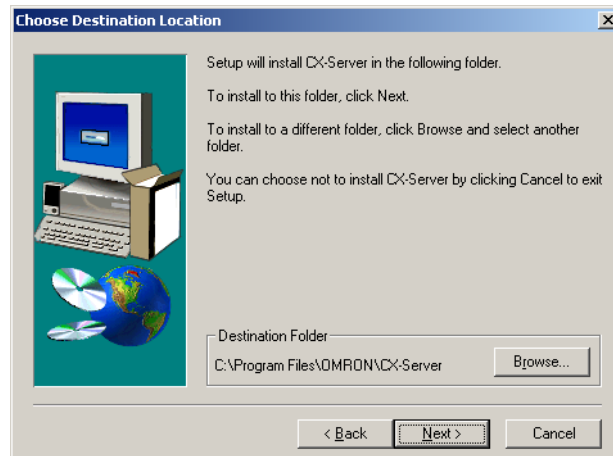

19. Next the user is prompted to select the additional driver software for CX-Server. None of these additional drivers are required to accomplish serial communication between the PC and the PLC CPU. Whether or not to in-

stall additional components, depends on hardware installed on your PC. Press the **Next** button to continue. The installation will now be performed.

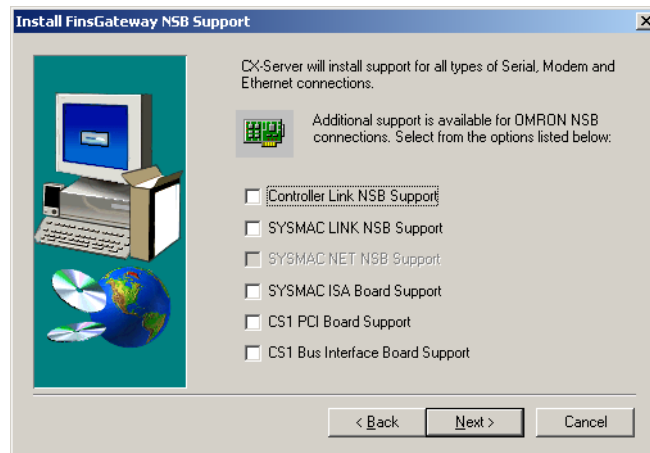

- 20. After completing the installation, a notification will be displayed, providing access to CX-Server release notes. Press the **Finish** button when done.

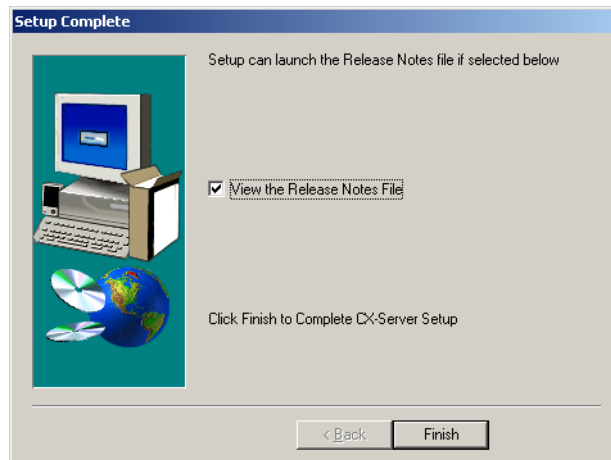

- 21. Finally, CX-Profibus installation is complete. The window shown below is displayed, to notify the user. Click the **Finish** Button to finalize installation and view the readme.txt file for CX-Profibus, containing last minute information on the installed program components

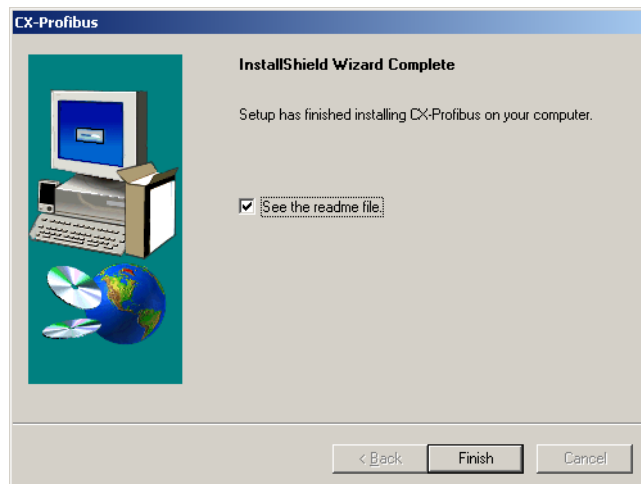

22. In order to be ensured of OMRON support for the program as well as information on updates, please register the program via the OMRON website <http://softwaredownload.europe.omron.com>. Alternatively, fill out the registration card enclosed with the software package and return it to the OMRON regional sales office or to your local OMRON representative.

3-1-3 Installing the C200HW-PRM21 DTM

The first version of CX-Profibus, i.e. CX-Profibus 1.0 did not include the C200HW-PRM21. Instead, this component could be downloaded from the OMRON Internet website. To install the C200HW-PRM21 separately from CX-Profibus perform the following procedure:

- 1,2,3...**
 1. Select from the task bar the Start - Run option and browse for the downloaded setup file, named *OMRON C200HW-PRM21 DTM setup.exe*.
 2. Press the OK button to run the setup and follow the instructions as presented during the installation.

3-2 CX-Profibus

3-2-1 Starting CX-Profibus

Starting CX-Profibus

Select **Program**, **OMRON**, and **CX-Profibus**, from the Start Menu if the default program folder name is used.

At startup, the CX-Profibus splash screen will appear, on top of which a login window as shown below will be displayed.

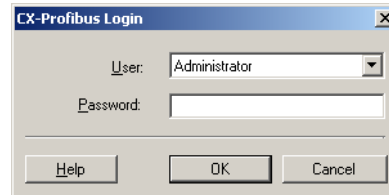

Login Window

The Login window provides the selection of the access level as well as the entry of the password belonging to the access level selected.

Default Password

The default password at the first start up of CX-Profibus is "**password**" and is applicable to all access levels. Type in "password" (without the quotes) at the password entry line and select OK.

 **Caution** If access limitation to CX-Profibus is required by the application, the password should be changed as soon as possible. Changing passwords is only possible on the Administrator level. Refer to *Changing the Passwords* for an explanation on how to change passwords.

Generating the Device Catalogue

After entering the correct password, CX-Profibus will start up and open. The first time CX-Profibus is started, the Device Catalogue will still be empty. Therefore, the following window will be displayed on top of the CX-Profibus application window.

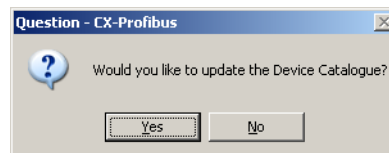

Select **Yes** to generate the Device Catalogue for the first time. This action may take several minutes depending on the number of installed DTMs.

After updating the Device Catalogue, it will open in the CX-Profibus application window.

3-2-2 CX-Profibus Main Window

The main application window of CX-Profibus will open with a New Project. After the first start up, the Device Catalogue will be opened automatically. If not, the Device Catalogue may be opened from the menu.

The figure below shows the opened CX-Profibus application window with a Project already containing a network, and the Device Catalogue window opened.

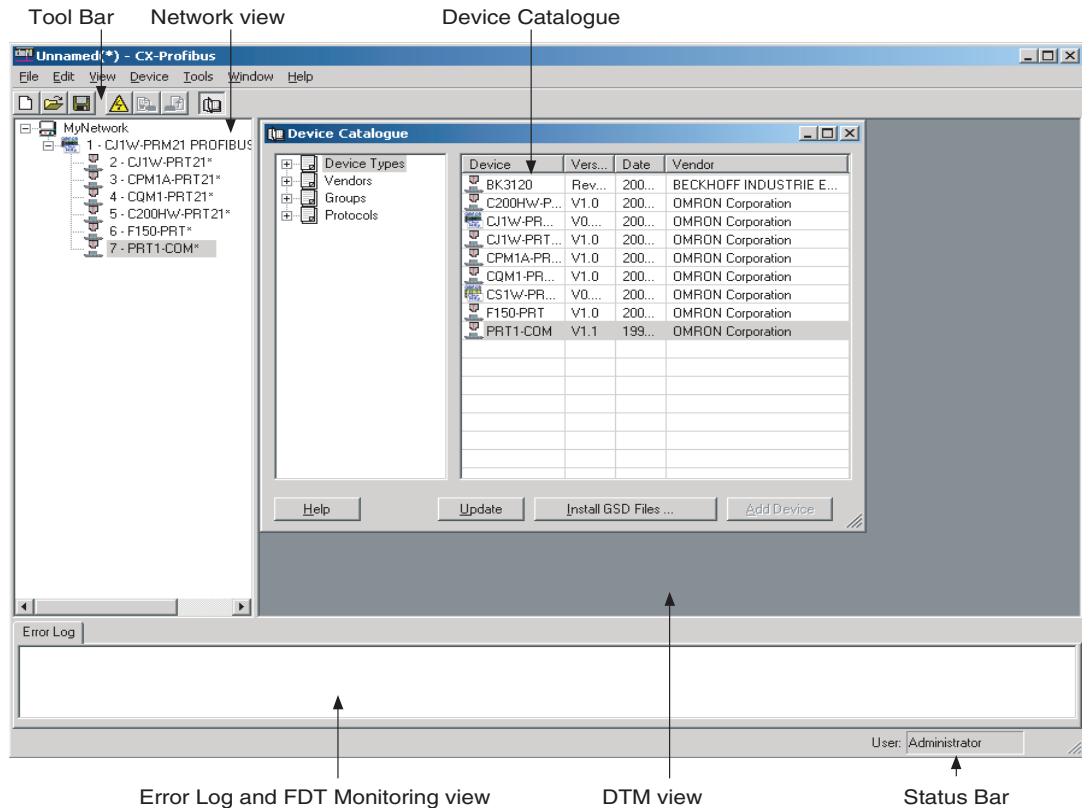

The main components in this window are

- The Network view.
- The DTM / Catalogue view.
- The Error Log view.
- The FDT Monitoring view (not shown in the figure above).
- The Main menu.
- The Tool Bar and the Status Bar.

Network view

The Network view displays the structure of the PROFIBUS network in a tree view format. The tree has at least three levels:

- The Project Level.
- The master level.
- The slave level.

The highest level of the tree is the project. The next level is the PROFIBUS Master level. On this level one or more PROFIBUS Master devices can be allocated. The third level contains the slave DTMs.

The PROFIBUS network must be assembled in the Network view, i.e. the various DTMs are added to the network via this window. From the Network view the individual DTM User Interfaces can be opened, and accessed.

CX-Profibus supports context menu in the Network view, which are made visible when selecting a device DTM and right clicking the mouse. The contents of the menu may depend on the functionality supported by the DTM.

DTM / Device Catalogue Window

The DTM / Device Catalogue window will hold the Device Catalogue as well as every opened DTM User Interface. The window is an MDI type window, or Multiple Document Interface. One or more user interface windows can be opened, re-sized and moved inside this window.

Error Log view

The Error Log view at the bottom of the CX-Profibus application window displays the error messages reported by DTMs to CX-Profibus. A Time stamp, a Date stamp and the DTM name are added to the message.

The contents of the window can be cleared, or copied to the clipboard, to allow pasting it into another document.

The Error Log view is opened by default, when starting CX-Profibus.

FDT Monitoring view

The FDT Monitoring view at the bottom of the CX-Profibus application window displays the FDT-DTM communication function calls between CX-Profibus and the DTMs. A Time stamp, a Date stamp, the type of information and the DTM name are added to the message.

The sequence of messages can be used to troubleshoot problems that may occur when using third party DTMs in CX-Profibus.

The contents of the window can be cleared, or copied to the clipboard, to allow pasting it into another document.

The FDT Monitoring view is not opened by default, when starting CX-Profibus. It can be opened through the **View - FDT Monitoring** menu option.

Main Menu







The main menu of CX-Profibus, provides all the necessary functionality to handle a complete project. The table below lists the main menu and their sub menu items.

Menu	Command	Short Key	Description
File	New	CTRL-N	Creates a new Project.
	Open	CTRL-O	Opens an existing Project.
	Save	CTRL-S	Saves the displayed Project to a file.
	Save As...	---	The Save as command is the same as Save, but the Filename Specification Window is always displayed.
	Export Project to HTML	---	Exports Project data in HTML format and launches the browser.
	Project Properties...	---	Opens an edit window to add or edit Project information.
	Recently used File List	---	Lists the recently used Project files.
	Exit	---	Exits CX-Profibus.
Edit	Cut	CTRL-X	Cuts devices and pastes them to the clipboard.
	Copy	CTRL-C	Copies devices to the clipboard.
	Paste	CTRL-V	Copies devices from the clipboard to the cursor position.

Menu	Command	Short Key	Description
View	Network view	---	Hides or un-hides the Network view.
	Device Catalogue	---	Opens or closes the Device Catalogue.
	Tool Bar	---	Hides or un-hides the Tool Bar.
	Status Bar	---	Hides or un-hides the Status Bar.
	Error Logging	---	Hides or un-hides the Error Logging window.
	FDT Monitoring	---	Hides or un-hides the FDT Monitoring view.
Device	Add Device...	---	Opens up the Device Catalog Add window, from which devices can be added to the selected network tree.
	Upload Parameters	---	Uploads the parameters from a device to its associated DTM.
	Download Parameters	---	Downloads the parameters from DTM to its associated device.
	Export to HTML	---	Exports the properties and parameters of the selected DTM, or the network to a HTML file and opens the default browser.
	Properties	---	Displays the properties of the selected DTM, or the network.
Tools	User Management...	---	Displays the user management (i.e password management) window.
Window	Cascade	---	Cascades all open DTM User Interfaces.
	Tile Horizontally	---	Tiles all open DTM User Interfaces horizontally.
	Tile Vertically	---	Tiles all open DTM User Interfaces vertically.
	Close All	---	Closes all open DTM User Interfaces.
Help	Contents	---	Opens the Help dialog and lists the Help file contents.
	Index	---	Opens the Help dialog and lists the Help Index.
	About CX-Profibus...	---	Opens the About dialog window for CX-Profibus.

Tool Bar

The tool bar provides quick access buttons to the user for frequently used menu commands. The table below lists the toolbar buttons.

Icon	Description	Equivalent menu command
	Creates a new project.	File-New
	Opens an existing project file.	File-Open
	Saves the displayed project to a file.	File-Save
	Connects the configurator to the selected devices.	Device-Go Online
	Downloads the parameters to the device.	Device-Download Parameters
	Uploads the parameters from the device.	Device-Upload Parameters
	Opens the Device Catalogue.	View-Device Catalogue

Status Bar

The status bar displays the current user role, i.e. the login level. In case the Error Log view has been closed, the status bar will additionally display a  symbol to indicate that new errors are available in the Error Log view. Double-clicking the symbol will open the Error Log view.

3-2-3 Device Catalogue

Device Catalogue Main Components

The Device Catalogue is one of the main components in CX-Profibus. Its main functions are

- to maintain a list of installed DTM and GSD files.
- to provide convenient sorting and categorizing of the list.
- to allow updating the list, after installation of new DTMs or GSD files.
- to provide detailed information on selected DTMs

The main layout of the Device Catalogue is shown below.

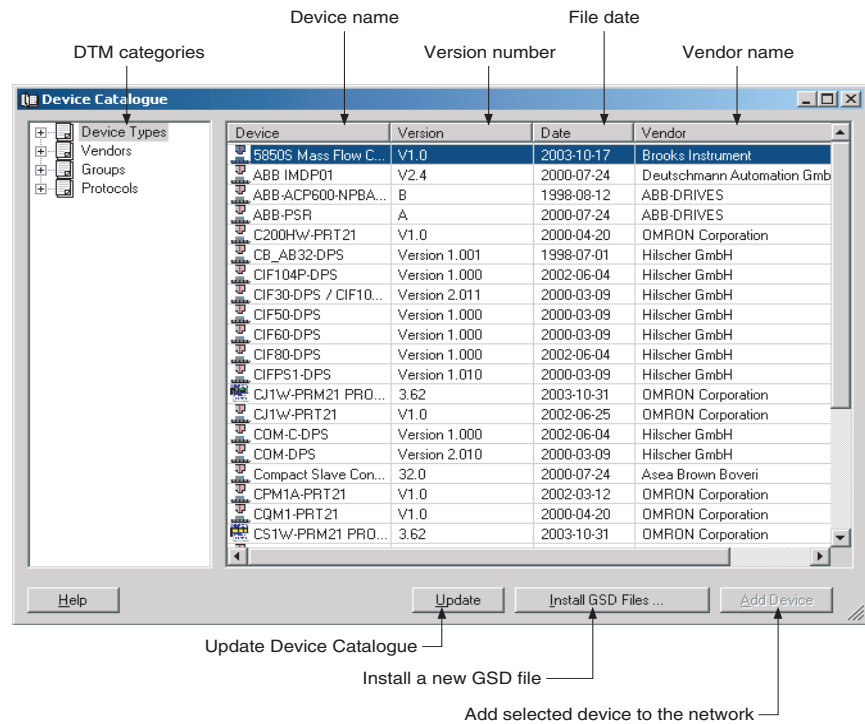

Invoking the Device Catalogue

The Device Catalogue window is opened by either selecting the  icon in the CX-Profibus toolbar or by selecting the **View - Device Catalogue** menu option. Both options have toggle function: selecting one of them again will close the Device Catalogue.

DTM view Layout

The left view allows selection of specific groups of DTMs to be displayed. The right view lists the DTMs, which are installed on the PC and which are available for setting up a network. A selection of DTMs is made by selecting a specific group in the left view.

Note The list makes no distinction between normal DTMs and GSD files which have been loaded through the Generic Slave Device DTM.

DTM List Window

The list items in the right view are described in the following table.

Column	Description
Device	The Device column contains the names of the DTMs, as provided by the DTM or the GSD file. If the device is defined by a GSD file, the Generic Slave Device DTM reads out the GSD file entry "Model Name". The string provided by this variable is the name displayed in the list.
Version	The version number defines the revision number of the device. If the device is defined by a GSD file, the Generic Slave Device DTM reads out the GSD file entry "Revision". The string provided by this variable is the version number displayed in the list.
Date	For DTMs, Date is the date associated with the revision. For GSD file based slaves, the date listed in this column is the date the GSD file was last modified.
Vendor	The Vendor name is provided by the DTM or the GSD files.

DTM Group Selection Window

The left view allows selection of specific groups of device DTMs with common attributes, e.g. Vendor name, Protocol type etc. If a group is selected, all device DTMs which belong to that group will be listed in the right view. The table below lists the possible groups that can be selected.

List item	Description
Device Types	Sub groups, which can be selected are: <ul style="list-style-type: none"> • Communication DTMs, e.g. PROFIBUS Master devices • Gateways, e.g. to another network type • Modular devices • Other devices, e.g. slave devices
Vendors	Sub groups, which can be selected are all available vendors. This information is provided by each DTM. It allows the user to select a group of devices from one vendor.
Groups	Sub groups are the device types, e.g. digital I/O, analog I/O etc.
Protocols	Sub groups which can be selected are all the communication protocols found in the Device Catalogue.

- Note**
1. The sub groups will be displayed by clicking on the + sign next to each main group
 2. Selecting the main group displays all devices in the group.

Additional DTM Information

In order to obtain more information of a specific DTM, right-click the DTM in the list, and from the pop-up menu, select **DTM Information**. This opens a

window with additional DTM information. The figure below provides an example for the CJ1W-PRM21 PROFIBUS Master DTM.

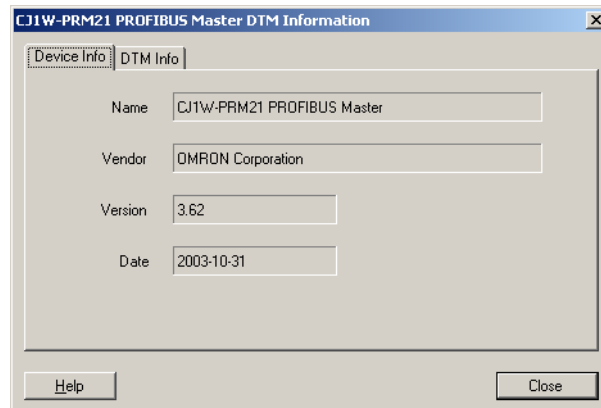

3-2-4 Updating the Device Catalogue

If a new DTM has been installed, it will not automatically be included in the Device Catalogue. In order to add newly installed DTMs to the list, the Device Catalogue must be updated by selecting the **Update** button at the bottom of the window.

Updating the Device Catalogue

Updating the Device Catalogue may take some time, depending on the amount of DTMs installed. A dialogue window with a progress bar will be shown during the update process. After updating the Device Catalogue, it will be stored on hard disk. The next time CX-Profibus is started the updated list will be used.

Installing GSD Files

The Device Catalogue also allows the installation, i.e. copying of new GSD files into the GSD directory for the Generic Slave Device DTM. Selecting the **Install GSD Files...** button displays the standard Windows File selection window. After selecting the GSD file, and selecting the **Open** button in the File selection window, the GSD file will be copied to the GSD file directory under CX-Profibus.

After copying the GSD file, a warning window will be displayed, indicating that the Device Catalogue needs to be updated. This can be accomplished by selecting the **Yes** button in the warning window.

- Note**
1. Updating the Device Catalog after copying GSD file can only be done if there is a new project opened, i.e. with no DTMs allocated to the network. This is to prevent corruption of an existing network in case a GSD file is removed or replaced.
 2. The **Install GSD Files...** option allows installation of more than one file at the same time.

3-2-5 Adding Devices to the Network

Setting up a network in CX-Profibus involves adding and configuring single device DTMs. The device DTMs as listed in the Device Catalogue can be added to the network in three ways:

- Using the context menu
A context menu will pop up when selecting the CS1/CJ1W-PRM21 PROFIBUS Master DTM and right clicking the mouse. By selecting the menu option **Add Device**, a simplified Device Catalogue is displayed, allowing only a selection of DTMs which can be added to the PROFIBUS Master DTM.
- Using the Drag & Drop function
A Device DTM listed in the standard Device Catalogue window can be dragged and dropped from the Device Catalogue to a desired position in the Network view.
- Using the Add Device button
A device DTM selected in the Device Catalogue can be added to a selected Master DTM in the Network view by clicking the **Add Device** button in the Device Catalogue window.

3-2-6 Saving and Opening Projects

A project, containing various DTMs can be saved and opened to and from hard disk. Saving a project file is accomplished by selecting the **File - Save** or **File - Save As...** menu option. This will display the standard Windows File selection window, allowing the user to enter a file name.

The Project File is saved with the extension *.CPR.

Saving the data is initiated from CX-Profibus, but every DTM must support the save function as well. The settings of each DTM are added to the Project file by the DTM itself.

A Project file can be opened using the **File - Open** menu option. This will open the standard Windows File selection window, after which the Project file can be selected and opened.

Note When opening a Project file, the network tree view is constructed. However, for performance reasons, the DTMs are not directly instantiated. The advantage is that the tree view is constructed fast, but opening a DTM from the tree view may take longer, depending on the performance of the PC used.

A Project File can also be opened from Windows Explorer. Double-clicking a file with extension *.CPR will invoke CX-Profibus and open the selected file.

3-2-7 Exporting to HTML

CX-Profibus provides automatic generation of project documentation upon command of the user. The documentation is generated in HTML format, and can cover either single DTMs or the whole project. After generation of the HTML document, it will automatically launch the default Internet browser, to display the result.

Exporting Project to HTML

Exporting the project information to HTML can be achieved in two ways.

- Select the main menu **File - Export Project as HTML** option.
A window will pop up displaying the progress of the export process.

- select **Export to HTML** option from the context menu

First select the project level in the Network view, then right click the mouse to display the context menu. A window will pop up displaying the progress of the export process.

After exporting the information, the default browser is launched, showing the result of the export process. Links are available to open the information pages for the individual DTMs.

The extent of the information made available depends on the individual DTMs. This can range from device type and version information up to all settings and selections made for the device.

Exporting DTM Information to HTML

Exporting single DTM information to HTML is achieved by the following sequence.

- 1,2,3... 1. Select the DTM in the Network view.
2. Right click the mouse to bring up the context menu.
3. Select the **Export to HTML** option from the context menu.

A window will pop up displaying the progress of the export process. When finished, CX-Profibus will launch the default browser to display the result. In this case however, no links will be available to other DTMs in the network.

3-2-8 Error Logging and FDT Monitoring

CX-Profibus provides two logging windows at the bottom of the application window. Both windows are used for displaying events.

Error Log view

The Error Log view displays error messages reported by the DTMs and by the CX-Profibus FDT container application. All messages include the Time and Date of occurrence, as well as the DTM Name, as shown in the Network view.

Purpose of the Error Log

The purpose of the Error Log view is error reporting as well as troubleshooting. The contents of the window can be copied to the clipboard, to allow it to be pasted into another document or into an E-mail. The errors themselves as well as the sequence of errors may hold additional clues in case of problems.

Error Log Format

The format used in the Error Log view is

Time: <Time> Date: <Date> - <DTM name> <message>

The message displayed, originates from the DTM in which the error occurred.

The figure below shows an example of an error message sequence. This example sequence is generated after attempting to change a slave address to that of another slave already assigned to the same Master Unit.

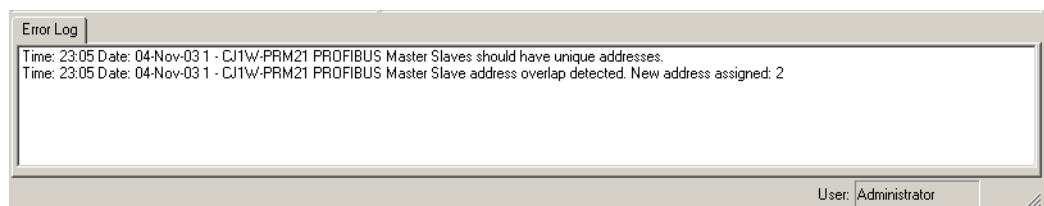

By right-clicking the mouse cursor in the Error Log view, a context menu is displayed. This context menu provides the options listed below.

Error Log view Context Menu

Menu item	Description	Equivalent menu command
Clear all entries	Clears the entire Error Log view.	---
Copy to clipboard	Copies the entire contents of the Error Log view to the clipboard.	---
Hide	Hides the Error Log view.	View - Error Logging

FDT Monitoring view

The FDT Monitoring view displays the communication between the FDT Container application (i.e. CX-Profibus) and any of the DTMs. The communication is listed as a sequence of function calls from the CX-Profibus to a DTM and vice versa.

Note The FDT Monitoring view is hidden by default. After starting CX-Profibus, the window will be displayed, by selecting the **View - FDT Monitoring** option from the main menu.

The purpose of the FDT Monitoring view is troubleshooting in case problems occur with third party DTMs. The contents of the window can be copied to the clipboard, to allow it to be pasted into another document or into an E-mail. The messages themselves as well as the sequence of messages may hold additional clues in case of problems.

The format used in the FDT Monitoring view is

Time: <Time> Date: <Date> - <Information Type> <message>

The message may include the name of the DTM involved in the communication.

The figure below shows an example of an FDT Monitoring message sequence. This example sequence is generated when opening a CJ1W-PRM21 PROFIBUS Master Unit DTM.

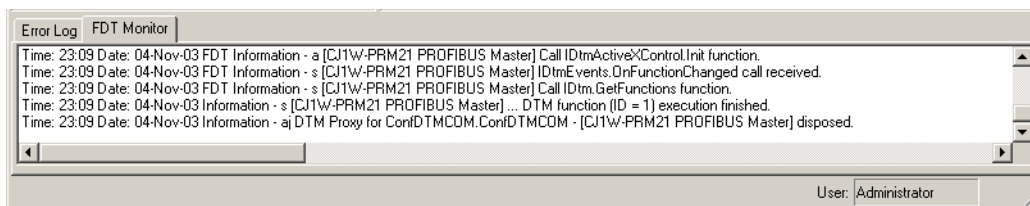

By right-clicking the mouse cursor in the FDT Monitoring view, a context menu is displayed. This context menu provides the options listed below.

FDT Monitoring view Context Menu

Menu item	Description	Equivalent menu command
Clear all entries	Clears the entire FDT Monitoring view.	---
Copy to clipboard	Copies the entire contents of the FDT Monitoring view to the clipboard.	---
Hide	Hides the FDT Monitoring view.	View - FDT Monitoring

3-2-9 Access Control and User Management

The FDT Standard defines four access levels and two attributes for FDT Container applications, which can be used to restrict access to the program or certain features thereof for unauthorized personnel. The actual use of the restrictions also depends on the application.

CX-Profibus implements the four levels as well as one of the attributes. These levels are listed below.

- Observer
- Operator
- Maintenance
- Planning Engineer
- Administrator

The access rights per level are defined in the table below.

Function		Observer	Operator	Maintenance	Planning Engineer	Administrator
Project File access	New file	Allowed	Allowed	Allowed	Allowed	Allowed
	Open file	Allowed	Allowed	Allowed	Allowed	Allowed
	Save File	Not allowed	Not allowed	Not Allowed	Allowed	Allowed
	Save As...	Not allowed	Not allowed	Allowed	Allowed	Allowed
	Properties	View only	View only	Edit	Edit	Edit
	Export to HTML	Allowed	Allowed	Allowed	Allowed	Allowed
Device Catalogue	Open	Allowed	Allowed	Allowed	Allowed	Allowed
	Add GSD files	Not allowed	Not allowed	Not allowed	Allowed	Allowed
	Update	Not allowed	Not allowed	Not allowed	Allowed	Allowed
PROFIBUS Master DTM	Open	Allowed	Allowed	Allowed	Allowed	Allowed
	Master settings	View only	View only	Edit	Edit	Edit
	Communication settings	View only	View only	Edit	Edit	Edit
	Go online	Allowed	Allowed	Allowed	Allowed	Allowed
	Monitoring	Allowed	Allowed	Allowed	Allowed	Allowed
	Change state and send commands	Not allowed	Not allowed	Allowed	Allowed	Allowed
	Export to HTML	Allowed	Allowed	Allowed	Allowed	Allowed
	Properties	View only	View only	Edit	Edit	Edit
Generic Slave DTM	Open	Allowed	Allowed	Allowed	Allowed	Allowed
	Device settings	View only	View only	Edit	Edit	Edit
	Go online	Allowed	Allowed	Allowed	Allowed	Allowed
	Monitoring	Allowed	Allowed	Allowed	Allowed	Allowed
Network	Add DTMs	Not allowed	Not allowed	Not allowed	Allowed	Allowed
	Delete DTMs	Not allowed	Not allowed	Not allowed	Allowed	Allowed
	Properties	View only	View only	Edit	Edit	Edit
	Export to HTML	Allowed	Allowed	Allowed	Allowed	Allowed
User Management	Change password	Not allowed	Not allowed	Not allowed	Not allowed	Allowed

User Management

To change access rights or to change the passwords for the various access levels, first login into the Administrator level. This allows you to select the **Tools - User Management** option from the main menu in CX-Profibus. Other access levels do not have access to this menu option. The selection opens the User Accounts window, as shown below.



Changing Access Rights

By selecting the check box next to a level, the Administrator can grant access rights to CX-Profibus, i.e. the checked levels can start and access CX-Profibus. If a check box is not selected, the corresponding level can not be used to start CX-Profibus, and it will not appear in the drop down list in the login window.

For example, in the window below the Observer and Maintenance levels are unchecked.



The next time CX-Profibus is started, the Observer and Maintenance access levels are not available in the login window, as shown below.

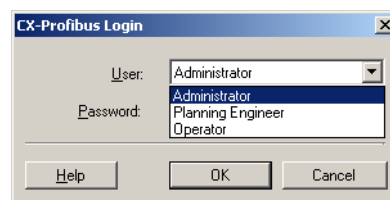

The Administrator level has always access and can not be disabled in the User Accounts window.

Changing the Passwords

In order to change a specific password, select the **Change password** button in the User Account window, next to the related access level. The level must be enabled by selecting the check box to the left of it. Pressing the **Change password** button opens a window allowing the entry of a new password. As an example the window below shows the Change password window for the

Planning Engineer. You can now enter the new password, confirm it by re-typing the password and select the OK button to activate the new password.



Note If access protection is not important for the application, you can define an empty string as a password, i.e. when entering the new password, simply press the return button on your PC. When starting CX-Profibus, the login window can be passed by pressing the return button on your PC, without entering a password.

3-3 CS1/CJ1W-PRM21 PROFIBUS Master DTM

CS1/CJ1W-PRM21 Master DTM

To allow configuration and data monitoring from within CX-Profibus two CS1/CJ1 PROFIBUS Master DTMs are installed, together with CX-Profibus. Each DTM shows up in the Device Catalogue under two different names.

DTM Name	Functions
CS1W-PRM21 PROFIBUS Master	<ul style="list-style-type: none"> I/O Configuration of PROFIBUS DP and PROFIBUS DP-V1 master Units Monitoring of PROFIBUS DP and PROFIBUS DP-V1 master Units
CJ1W-PRM21 PROFIBUS Master	
CS1W-PRM21 PROFIBUS DP-V1 Master	<ul style="list-style-type: none"> I/O Configuration of PROFIBUS DP and PROFIBUS DP-V1 master Units Monitoring of PROFIBUS DP and PROFIBUS DP-V1 master Units Provide an Acyclic communication channel with PROFIBUS DP-V1 slave devices.
CS1W-PRM21 PROFIBUS DP-V1 Master	

The PROFIBUS Master DTM has two main user interface components.

- DTM Configuration User Interface
This user interface facilitates configuration of the Master Unit.
- DTM Diagnostics User Interface
The DTM Diagnostics User Interface facilitates Unit status determination, slave status determination and changing the Unit's PROFIBUS operational mode.

This section provides an overview of the PROFIBUS Master DTM, and discusses both user interfaces.

3-3-1 Configuration User Interface

Opening the Configuration DTM

The configuration DTM is opened by

- Selecting the Master DTM in the Network view, and double-clicking the left mouse button.
- Selecting the Master DTM in the Network view, and right-clicking the mouse. From the context menu, select **Configuration**. The Master DTM Configuration User Interface, which is displayed in the CX-Profibus DTM view is shown below.

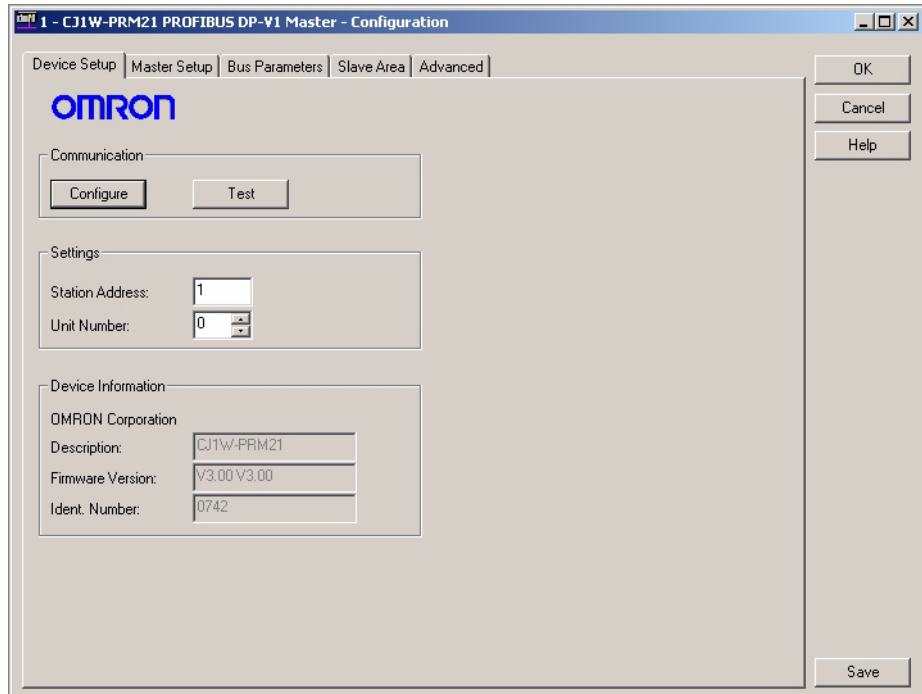

Note The Configuration User Interface for each of the two CS1/CJ1 PROFIBUS Master DTMs contains the same views and setting options.

Master DTM Configuration User Interface

The Master DTM Configuration User Interface contains four tabs:

- Device Setup tab
- Master Setup tab
- Bus Parameters tab
- Slave Area tab

The four tabs are discussed below.

Configuration Interface Buttons

The Master DTM Configuration User Interface contains four general buttons. They are listed in the table below, together with the action taken when pressing them.

Button	Action
OK	Evaluate, and save the changes made (if any) and close the user interface. Note If any invalid settings have been made, a warning message will be displayed, allowing cancellation of the command.
Cancel	Closes the user interface without saving. Note If any changes were made, a warning message is displayed, allowing cancellation of the command.
Help	Launch context sensitive Help for the Active tab.
Save	Evaluate changes and save them.

Caution Save in the context of the buttons means that the changes made by the user are saved in the DTM only, i.e. the changes are not permanently saved in the Project yet. This is indicated by the asterisk next to the DTM in the Network view. The next time in the same session the GUI is opened, the changes will still be there. In order to save the changes permanently, e.g. to hard disk, Click the **File - Save** option from the main menu of CX-Profibus.

Device Setup Tab

The Device setup tab (see figure above) provides the controls to achieve communication between the PC and the PROFIBUS Master Unit. It allows setting of the unit number to identify it on the PLC system and the device address to identify it on the PROFIBUS network. It also will invoke the CX-Server interface to setup and test the communication between the PC and the PLC to which the Unit is attached.

The Device Setup tab has the following components.

Settings Box

The Settings box contains the setting the user must make before setting up the communication and before testing the communication.

Control	Description
Station Address	Address of the Unit in the PROFIBUS network. Default value is 1, but it should be changed if there is already another device with that number.
Unit Number	This number must be the same as the number selected with the Unit Number Selector switch on the front of the Unit (refer to <i>2-3-1 Selecting a unit number</i>). This number is used in the communication between the PC and the PLC to transmit the messages to the targeted PROFIBUS Master Unit

Configure Button

The **Configure** button invokes the CX-Server communications settings dialog. CX-Server is the driver software, providing the communication functionality between a PC and the PLC CPU. It is the basis for the OMRON's CX-One programs.

CX-Server is provided with CX-Profibus, but it may already be installed on the PC, if other programs, for example CX-Programmer have been installed.

Note The CX-Server is designed to manage the communication between the PC and the PLC and also configure the connected PLC. CX-Server currently supports CS1G-H, CS1H, CS1H-H, CJ1G-H, CJ1H-H CJ1M and CS1G/CJ1G PLC types.

Section 3-3-3 *Connecting to the CS1/CJ1W-PRM21* will provide more details on how to configure CX-Server.

Test Button

The purpose of the **Test** button is to test the communication setup, after CX-Server has been configured. If the PC and the PLC are connected, selecting the Test button, will invoke a FINS request message to the PROFIBUS Master Unit via the PLC, to read its name and firmware version. If the request succeeds, both will be displayed in the Device Information Box.

If the FINS request fails (no response), an error message will be displayed in the Error Log view. In this case the Firmware version field will revert back to its default contents, i.e. "---".

Device Information Box

The Device Information Box contains information obtained from the PROFIBUS Master Unit, through the communication.

Item	Description
OMRON Corporation	This is fixed text, indicating the Manufacturer of the PROFIBUS Master Unit.
Description	This string will contain the name of the Unit, i.e. CJ1W-PRM21 or CS1W-PRM21.
Firmware Version	This string displays the firmware version, currently in the PROFIBUS Master Unit.
Ident number	The PROFIBUS Ident number (Hex) for the Unit: <ul style="list-style-type: none"> • CJ1W-PRM21: 07C4 • CS1W-PRM21: 0742

Master Setup Tab

The Master Setup tab contains settings regarding the behaviour of the PROFIBUS Master Unit itself. The Master Setup tab is shown below.

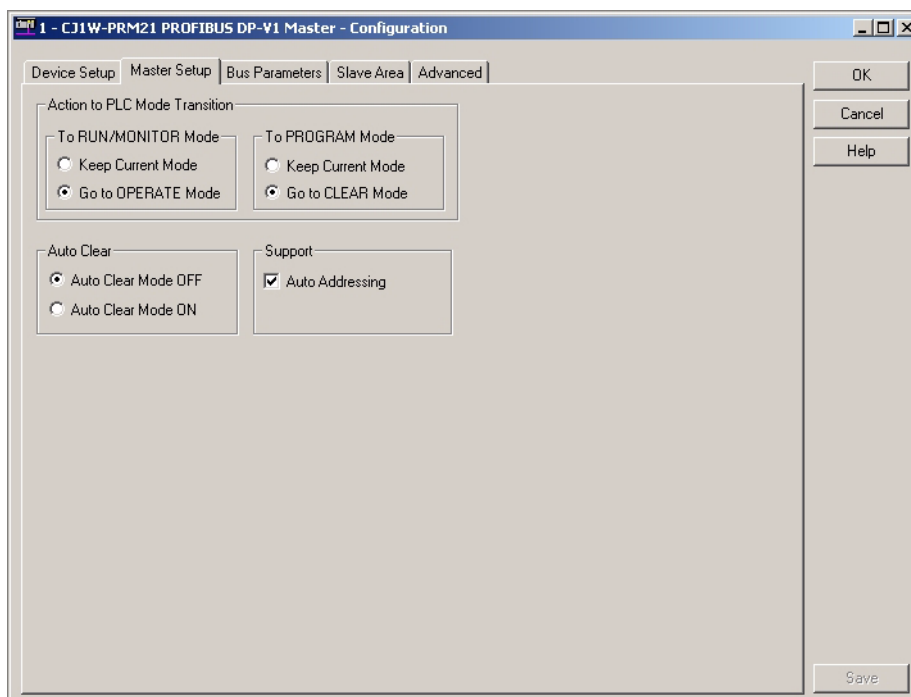

Action to PLC Mode Transition Box

The Action to PLC Mode Transition Box defines the behaviour of the Unit on the PROFIBUS network, in case a PLC mode change occurs. The check boxes define how the Unit should behave in case the PLC mode is changed from RUN / MONITOR mode to PROGRAM mode, or vice versa. Refer to section 1-1-7 Network Operation Modes for more information on PROFIBUS operational modes.

Change PLC to RUN/MONITOR Mode

The table below defines the behaviour in case the PLC changes to RUN / MONITOR mode.

Control	Description
Keep Current Mode	Unit keeps the current mode if the PLC goes to RUN / MONITOR mode (e.g. stay in CLEAR mode).
Go to OPERATE Mode (default setting)	The Unit goes to the OPERATE mode whenever the PLC goes to the RUN / MONITOR mode.

Change PLC to PROGRAM Mode

The table below defines the behaviour in case the PLC changes to PROGRAM mode.

Control	Description
Keep Current Mode	Unit keeps the current mode if the PLC goes to PROGRAM mode (e.g. stay in OPERATE mode).
Go to CLEAR Mode (default setting)	The Unit goes to the CLEAR mode whenever the PLC goes to the PROGRAM mode.

Auto-CLEAR Box

Auto-CLEAR defines the Unit's behaviour in case an error occurs in one of the allocated slave devices, which causes it to stop data exchange with the Master Unit. If Auto-CLEAR is enabled, the Unit will automatically transition to the CLEAR state and force all its allocated slave devices to the 'safe' state, i.e. all outputs are set to 0, using the Global-Control CLEAR command.

Control	Description
Auto-CLEAR Mode ON	Selected Unit transitions to the CLEAR mode in the event of a network error, e.g. because one or more configured slaves are not in the Data Exchange mode.
Auto-CLEAR Mode OFF (default setting)	Selected Unit does not transition to CLEAR mode, but attempts to re-parameterize the slave device.

Support Box

The Auto Addressing in the Support Box defines the I/O Mapping process when adding/removing I/O modules or when editing an existing I/O Mapping. Refer to section 6-5-2 *Mapping I/O Data* for more details on I/O mapping.

Control	Description
Auto Addressing enabled	I/O data mapping will be done by the Master DTM by allocating the I/O data in ascending order of slave device address and selected I/O modules. No memory allocation gaps are left behind.
Auto Addressing disabled	New I/O modules are appended to the existing mapping. Changed I/O modules will be re-allocated to the end of the list. Memory allocation gaps can be left behind.

Bus Parameters Tab

The Bus Parameters tab contains the parameters for the communication on the PROFIBUS network. The Bus Parameters tab is shown below.

The Bus Parameters are a number of settings which define the communication behaviour and timing on the PROFIBUS network. The Bus Parameters depend on the selected baud rate, certain slave communication parameters as well as the number of I/O data bytes exchanged between the Master Unit and each of the slave devices.

The required combination of Bus Parameters is calculated by the program, based on the dependencies mentioned above. However, the user can change selected Bus Parameter manually if the application requires this.

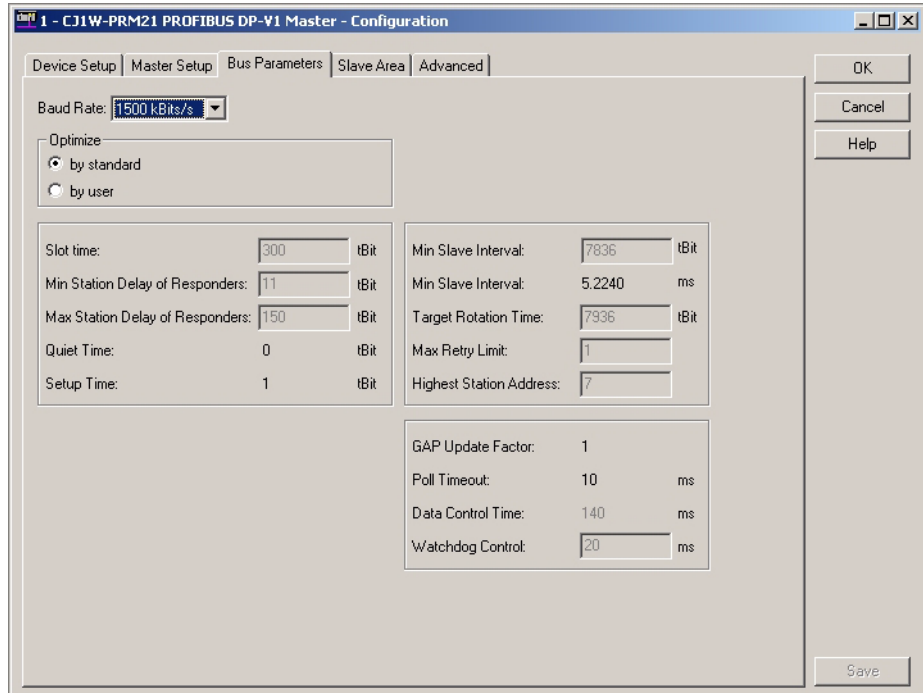

Caution Changing the calculated Bus Parameters manually is not recommended, and should only be performed if this is really necessary. Changing the Bus Parameters to an invalid combination, may result in Unit malfunctioning and unexpected behaviour.

Note When making changes to Bus Parameters, selecting the Optimize buttons, allows toggling between the optimized values and the changed values. Selecting another baud rate after changing parameters, will reset the Bus Parameters to default values for the new baud rate.

The table below lists the parameters, shown in the Bus Parameter tab.

Item	Description	Unit	Editable by User
Baud rate	Defines the transmission rate on the PROFIBUS DP Network. The following baud rate values are defined by the PROFIBUS DP standard: <ul style="list-style-type: none"> • 9.6 kBits/s • 19.2 kBits/s • 45.45 kBits/s • 93.75 kBits/s • 187.5 kBits/s • 500 kBits/s • 1500 kBits/s (default value) • 3000 kBits/s • 6000 kBits/s • 12000 kBits/s 	--	Yes

Item	Description	Unit	Editable by User
Optimize	<p>The Optimize setting defines whether parameters can be changed by the user.</p> <ul style="list-style-type: none"> By Standard Forces the user to use the default (optimized) settings. By User Makes selected fields editable. <p>Note 1. If the By User option is selected and changes have been made, it is still possible to switch between Optimize settings, without the changes being lost.</p> <p>2. If the By User option is selected and the baud rate is changed, the parameters will be optimized to the new baud rate.</p>	--	Yes
Slot Time	The maximum time a Master Unit must wait for a response to a request message.	t _{BIT}	Yes
Min. Station Delay of Responders	The minimum allowed time for a slave device before it will generate a response to a request message.	t _{BIT}	Yes
Max. Station Delay of Responders	The maximum allowed time for a slave device to generate a response to a request message.	t _{BIT}	Yes
Quiet Time	The time a transmitting device must wait after the end of a message frame, before enabling its receiver.	t _{BIT}	No
Setup Time	The time between an event and the necessary reaction.	t _{BIT}	No
Min. Slave Interval	The Minimum Slave Interval defines the poll cycle, i.e. the minimum time between two consecutive Data_Exchange Cycles to the same slave device. The Minimum Slave Interval must be smaller than the Target Rotation Time.	t _{BIT}	Yes
	Calculated Minimum Slave Interval in milliseconds.	ms	No
Target Rotation Time	The anticipated time for one token cycle, including allowances for high and low priority transactions, errors and GAP maintenance. Do not change the value below the calculated value, to avoid bus communication interruptions.	t _{BIT}	Yes
Max Retry Limit	Maximum number of request transmission retries by this master if a device does not reply to a request.	--	Yes
Highest Station Address	<p>The HSA defines the Highest Station Address of Master devices on the network, of which the Master device will request the FDL status, when updating the active device list (See GAP Update Factor).</p> <p>If new slaves are added to the network, this field shows the highest device address. The Master will periodically check whether new active devices have been added between its own address and the Highest Station Address. If any devices are detected, GAP is updated.</p> <p>Permissible values are in the range of 0 to 126.</p>	--	Yes
GAP Update Factor	<p>The GAP update factor defines the amount of updates of the active devices (i.e. Master devices) list times during one token rotation cycle.</p> <p>To update the list, the Master device will transmit FDL_Status_request messages to ascending device addresses until it finds a next Master device, or until it reaches the Highest Station Address (See HSA above).</p> <p>The GAP Update Factor is fixed to 1.</p>	--	No
Poll Timeout	The maximum time interval that this master device may need for the execution of a master-master function.	ms	No
Data Control Time	The cycle time in which the master updates its Data Transfer List, in which it keeps an overview of all slave states. Data Control Time is based on the Watchdog time T _{WD} : Data Control Time = 7*T _{WD} .	ms	No
Watchdog Control	The Watchdog Control Time defines the time for a slave device to set its outputs to a fail-safe state, if during that time no communication between the Master device and that slave device was detected. The Watchdog is automatically set for all configured slaves, based on the value of T _{TR} .	ms	Yes

Slave Area Tab

The Slave Area tab displays the mapping of the I/O data from/to the allocated slave devices on to the PLC memory areas. The mapping can be made automatically, but can also be changed by the user, before downloading.

The Slave Area tab is shown below. Only the Output Allocation tab is shown.

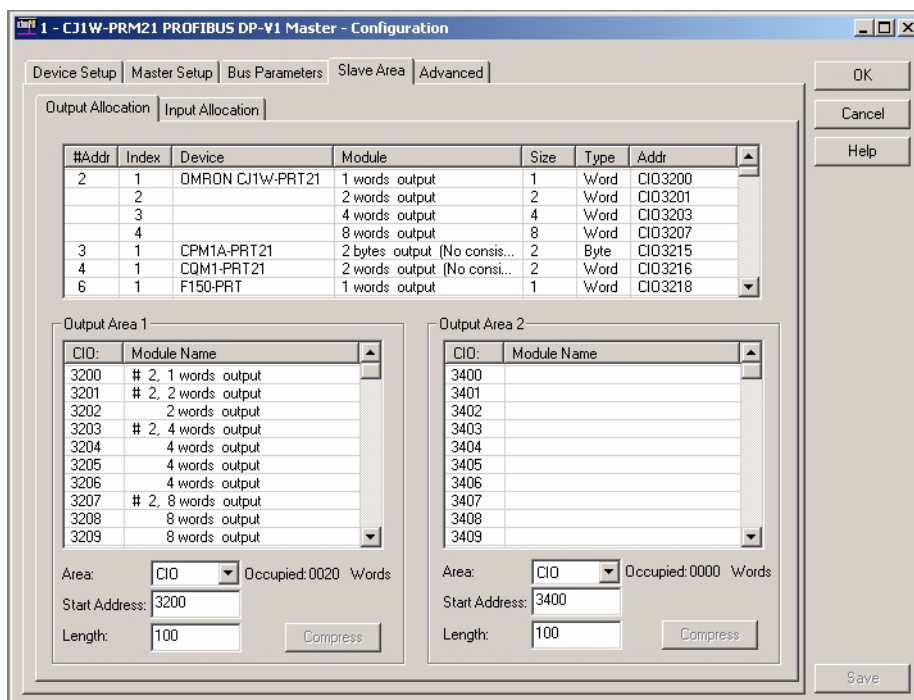

Allocation Areas

The Slave Area allocation tabs define how the I/O data of each of the slave devices is mapped on to the PLC memory. The Slave area tab contains two tabs, one for Output Allocation and one for Input Allocation. Each tab contains an overall module list, showing all the output or input data per slave, along with the Module names, sizes, data types and start addresses. This data has been transferred to the Master DTM by each of the allocated slave DTMs. If no slave devices have been allocated, or configured, the list will be empty.

Module List Box

The Module List Box list contains the following information (refer to figure above, the table applies to the lists in the Input and Output Allocation tabs).

Column	Description
#Addr.	Station address on the network, obtained from the slave DTM.
Index	Index number of the I/O module.
Device	Device name, obtained from DTM.
Module	System generated name.
Size	Module data size, unit of type mentioned in next column.
Type	Module data type, e.g. Byte, Word etc.
Addr	Mapped address area in PLC memory. For example: CIO3200, equals CIO Area, start address 3200.

I/O Mapping Areas

Each Output/Input Allocation tab also contains two areas on to which the I/O data can be mapped. The areas will in turn be mapped to the PLC memory. By default all data is mapped to Area 1, in order of ascending slave device address.

- Note**
1. When mapping, the modules are copied from the module list to the mapping Area and not moved. This means that the module list acts as a resource for the two Mapping Areas, below the module list.

- When adding/removing slaves/modules, and Auto Addressing has been enabled, the modules in the Areas will be remapped. This usually results in I/O data being re-mapped. Therefore it is recommended to select all slaves and modules, before setting up the PLC memory mapping configuration.

 **Caution** The default mapping of areas on to the PLC memory is the same default mapping as used in the CS1/CJ1W-DRM21 Devicenet Master/Slave Unit. Care should be taken to avoid data overlap, if such a Unit is part of the same PLC CPU system as the CS1/CJ1W-PRM21 PROFIBUS Master Unit.

Mapping Area Controls

Each mapping Area in the Allocation tab is equipped with four controls and an information field located below the Area. The controls and information field are listed and explained in the table below.

Control	Description
Area	Selects the PLC memory area to which the associated I/O Area will be mapped. Possible options are: <ul style="list-style-type: none"> Not Used (List must be empty). CIO DM Work HR EM Bank 0 to 12 (Decimal) (See Note 1).
Start Address	In this field the user can enter the start address in the PLC memory of the mapped data block.
Length	The length box allows the user to select the number of visible rows. The minimum and the default value is 100 words. If more than 100 words are configured, the minimum Length value will be that number. The user can set the Length value to up to 7168 words.
Occupied	This field display the actual length of the data block (not necessarily the same as the amount of data in it). This length includes both data and any gaps between modules. Gaps may only be there if Auto-Addressing option in the Master Setup tab is disabled (See also Note 2).
Compress button	Pressing the Compress button will compress the Area list associated with it, i.e. this action will remove all gaps from the mapping list by moving all mapped I/O modules as close to the start of the memory area as possible. (See Notes 3 and 4).

- Note**
- If the selected PLC memory area, on to which the data must be mapped is not supported by the PLC CPU, a warning message will be displayed upon downloading the configuration.
 - If an invalid setting is made the Occupied length value will change its colour to red, indicating an invalid setting. In addition, a warning message will be displayed, upon saving the changes. Invalid settings are for example
 - The start address and length definitions of the data block will cause it to exceed the area in the PLC.
 - The data mapping of two or more I/O Areas (Output and/or Input) will be overlapping each other partly or totally in the PLC memory.
 - The **Compress** button will be disabled, i.e. grayed out, when Auto-Addressing (see *Master Setup Tab* on page 68) has been enabled.
 - Before Compressing, the Master DTM will display a warning message prompting the user for confirmation of the action.

Changing Mapped Data Allocations

By default, the data is mapped to Area 1 in both the Output and Input Allocation tabs. It is however possible to map a part of the data to the second area in the same tab. For example, an application may require to store all byte data in one location and all word data in another.

Moving data mapped in one Area to another Area is done from the module list. The procedure is as follows.

- 1,2,3...**
1. Find the module which must be mapped to a desired Area in the module list, and select it.
 2. Left-click the module and drag it, while holding the Left mouse button, to the desired Area. This can be the end of the list or any empty space in the list in which it will fit (See Note).
 3. Release the mouse button. The module data is copied in the desired Area and appended to the already existing list. The same entry in the other list is now deleted.
 4. Finally, the PLC memory address to which the module is mapped is now updated in the module list.

- Note**
1. If Auto-Addressing is enabled (see *Master Setup tab* in this section), any empty spaces evolving out of moving of modules to another Area will be removed by compressing the list. Modules located to a higher address will be moved to a lower address to fill up the gap.
 2. If Auto-Addressing is disabled, compressing the list can be accomplished by pressing the **Compress** button, after all modifications to the mapping have been made.

Advanced Tab

The Advanced tab displays the settings required for PROFIBUS DP-V1 Class 2 communication with Slave devices. The Advanced tab is shown below.

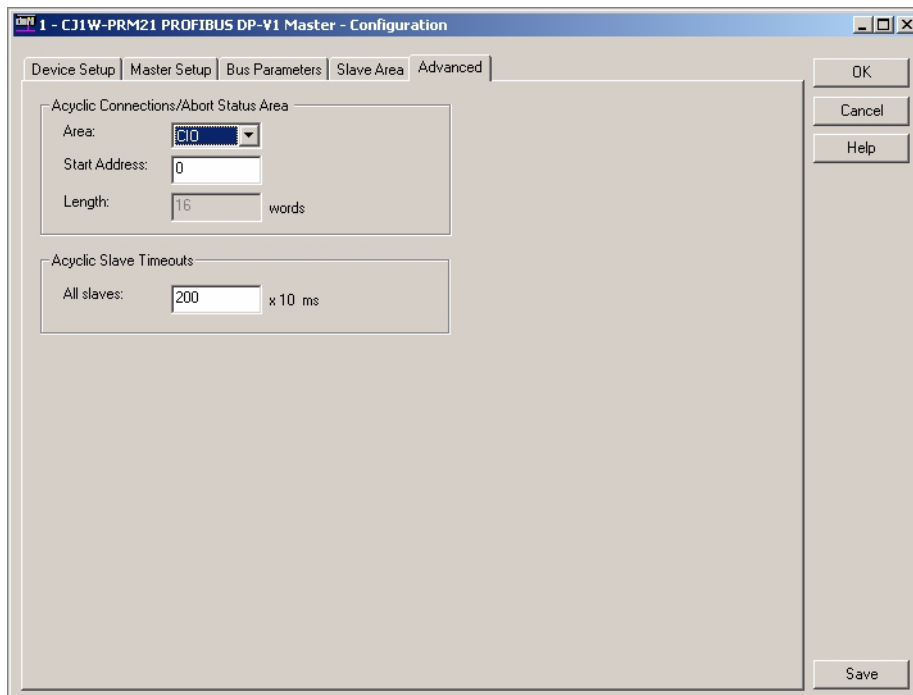

Acyclic Connection/Abort Status Box

The Acyclic Connection/Abort status box contains settings, which allow the user to define where in the PLC CPU memory the Connection/Abort status bit fields must be mapped. These bits indicated the open/closed PROFIBUS DP-V1 Class 2 connections between the Master Unit and individual slave devices.

The Acyclic Connection/Abort status box contains the following information.

Control	Description
Area	Selects the PLC memory area to which the Acyclic Connection/Abort status bits will be mapped. Possible options are (See Note): <ul style="list-style-type: none"> • Not Used (Default setting, Start Address and Length will be set to 0). • CIO • DM • Work • HR • EM Bank 0 to 12 (Decimal)
Start Address	In this field the user can enter the start address in the PLC memory of the mapped data block.
Length	The length value is a fixed number. The total number of words is 16.

- Note**
1. If the selected PLC memory area, on to which the data must be mapped is not supported by the PLC CPU, a warning message will be displayed upon downloading the configuration.
 2. If an invalid setting is made the Length value will change its colour to red, indicating an invalid setting. In addition, a warning message will be displayed, upon saving the changes. Invalid settings are for example
 - The start address and length definitions of the data block will cause it to exceed the area in the PLC.
 - The mapping overlaps with one or more of the I/O Areas (Output and/or Input) mappings.

Acyclic Connection Status Flags

The 8 word Acyclic Connection bit flags are shown below.

	15	14	13	12	11	10	9	8	7	6	5	4	3	2	1	0	
Word n	15	14	13	12	11	10	9	8	7	6	5	4	3	2	1	0	Slave station 00 ~ 15
Word n+1	31	30	29	28	27	26	25	24	23	22	21	20	19	18	17	16	Slave station 16 ~ 31
Word n+2	47	46	45	44	43	42	41	40	39	38	37	36	35	34	33	32	Slave station 32 ~ 47
Word n+3	63	62	61	60	59	58	57	56	55	54	53	52	51	50	49	48	Slave station 48 ~ 63
Word n+4	79	78	77	76	75	74	73	72	71	70	69	68	67	66	65	64	Slave station 64 ~ 79
Word n+5	95	94	93	92	91	90	89	88	87	86	85	84	83	82	81	80	Slave station 80 ~ 95
Word n+6	111	110	109	108	107	106	105	104	103	102	101	100	99	98	97	96	Slave station 96 ~ 111
Word n+7			125	124	123	122	121	120	119	118	117	116	115	114	113	112	Slave station 112 ~ 125

Note In the above figure, n is the start address of the memory locations, defined by the Area and Start Address setting in the Acyclic Connection/Abort Status Box.

Bit	Name	Status	Controlled by	Unit operation
-	Acyclic Connection flags	ON	Unit	If the bit corresponding to a slave device address is ON, it indicates that the PROFIBUS Master Unit has established a PROFIBUS DP-V1 Class 2 type connection.
		OFF	Unit	If the bit corresponding to a slave device address is OFF, it indicates that there is no open PROFIBUS DP-V1 Class 2 type connection with the specific slave device.

Acyclic Connection Abort Status Flags The 8 word Acyclic Abort bit flags are shown below.

	15	14	13	12	11	10	9	8	7	6	5	4	3	2	1	0	
Word n+8	15	14	13	12	11	10	9	8	7	6	5	4	3	2	1	0	Slave station 00 ~ 15
Word n+9	31	30	29	28	27	26	25	24	23	22	21	20	19	18	17	16	Slave station 16 ~ 31
Word n+10	47	46	45	44	43	42	41	40	39	38	37	36	35	34	33	32	Slave station 32 ~ 47
Word n+11	63	62	61	60	59	58	57	56	55	54	53	52	51	50	49	48	Slave station 48 ~ 63
Word n+12	79	78	77	76	75	74	73	72	71	70	69	68	67	66	65	64	Slave station 64 ~ 79
Word n+13	95	94	93	92	91	90	89	88	87	86	85	84	83	82	81	80	Slave station 80 ~ 95
Word n+14	111	110	109	108	107	106	105	104	103	102	101	100	99	98	97	96	Slave station 96 ~ 111
Word n+15			125	124	123	122	121	120	119	118	117	116	115	114	113	112	Slave station 112 ~ 125

Note In the above figure, n is the start address of the memory locations, defined by the Area and Start Address setting in the Acyclic Connection/Abort Status Box.

Bit	Name	Status	Controlled by	Unit operation
-	Acyclic Connection Abort flags	ON	Unit	If the bit corresponding to a slave device address is ON, it indicates that the PROFIBUS Master Unit has aborted a PROFIBUS DP-V1 Class 2 type connection.
		OFF	Unit	If the bit corresponding to a slave device address is OFF, it indicates that no abort action of a PROFIBUS DP-V1 Class 2 type connection has been performed.

Slave Timeouts

The Acyclic Slave Timeout defines the timeout value for PROFIBUS DP-V1 Class 2 connections to slave devices. If a PROFIBUS DP-V1 message is sent to a specific slave device, the timeout is used to monitor the response from the slave device. If a response is not received with the specified timeout interval, the connection will be aborted by the Master unit.

The value can be set in the range of 1 to 32767, and is expressed in units of 10 ms.

Additional functions

Two additional functions are provided to the user, via the DTM context menu:

- Slave DTM Address Assignment.
- Set Device Station Address (only available on DTM version 0.2.0.0 or higher and for CS1/CJ1W-PRM21 Unit versions 2.0 or higher).

To select these options perform the following steps:

- 1,2,3...**
1. Select the Master DTM in the Network view.
 2. Right click the mouse, and select the **Additional functions** entry from the context menu.
 3. Select the desired function.

Slave DTM Address Assignment

Selecting the Slave DTM Address Assignment displays a list of DTMs assigned to the PROFIBUS Master DTM, together with their Station address:

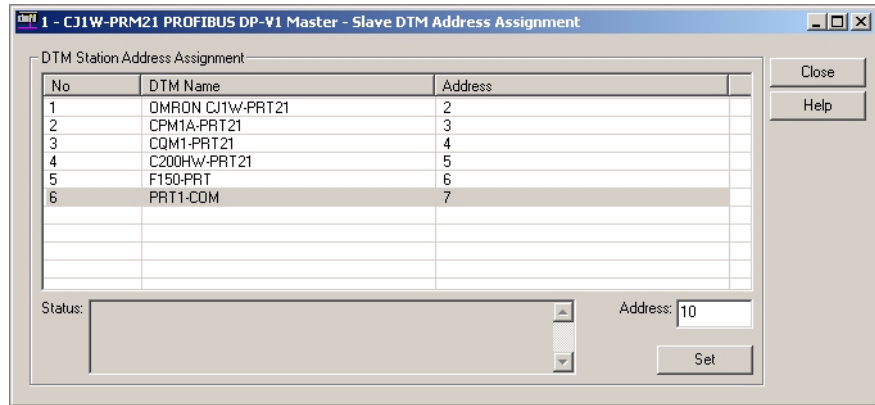

When assembling the network, the PROFIBUS Master DTM will automatically assign a station address to each new slave DTM. The purpose of the Slave DTM Address Assignment function is to allow the user to change the DTM address of one or more devices, to make it the same as the actual physical address of the device on the network.

In order to change an address perform the following steps:

- 1,2,3...**
1. Select the slave device in the list.
 2. Enter the new address in the field Address in the lower right corner of the window.
 3. Press the **Set** button. The Status field will display the status of this service, i.e. whether or not the slave device responded without error.

Set Device Station Address

The Set Device Station Address function is provided for slave devices of which the PROFIBUS address is not set through switches, but by using the PROFIBUS DP Set Slave Address service. Slave devices which support this service also provide a means to store the address in internal non-volatile memory. In case this non-volatile memory does not contain an entry, the slave device will assume the default address 126.

- Note**
1. The PROFIBUS DP Set Slave Address service is supported by the CS1/CJ1W-PRM21 Units as of Unit version 2.0.
 2. In order to be able to change a device's address, the CS1/CJ1W-PRM21 PROFIBUS Master DTM must be on-line.

Selecting the Set Device Station Address displays the window shown below:

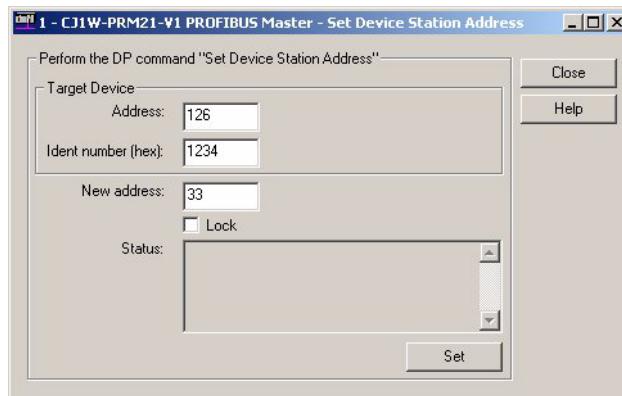

In order to change the address of a slave device perform the following steps (Make sure that the DTM is on-line with the CS1/CJ1W-PRM21 Unit):

- 1,2,3...**
1. Enter the device's current address and its PROFIBUS Ident Number. The PROFIBUS Ident Number can be found in the Generic Slave DTM or through the device's documentation. By default the device's current address will be 126. If necessary, change this to the actual current address.
 2. Enter the new device address in the **New Address** field.
 3. Optionally, select the **Lock** checkbox, if the address change must be made permanent.
 4. Press the Set button to invoke the PROFIBUS DP Set Slave Address service. The Status field will display the status of this service, i.e. whether or not the slave device responded without error.

 **WARNING** Selecting the Lock option makes any future changes of the address impossible, even after power-down/power-up of the slave device.

Note After successful completion of the address change, the device DTM address in the Network view has to be changed as well.

3-3-2 Diagnostics User Interface

Diagnostics User Interface The PROFIBUS Master DTM provides a second user interface, to display the Diagnostics information available in the PROFIBUS Master Unit. This information concerns

- Unit and PROFIBUS DP Interface status flags.
- Slave status flags and common slave diagnostics.
- The Unit's Error Log.

Furthermore, the Diagnostics User Interface allows changing the Master's PROFIBUS operational mode and the transmission of Global-Control messages.

In order to access the Diagnostics User Interface, the DTM has to be on-line, i.e. a communication channel between the DTM and the PROFIBUS Master Unit must have been established.

Opening the DTM Diagnostics User Interface

In order to open the DTM Diagnostics User Interface perform the following sequence.

- 1,2,3...**
1. To go on line, perform one of the following actions.
 - Select the DTM in the Network view.
 - Select the **Device - Go Online** option from the main menu, or from the DTM context menu, or
 - Select the  button from the Tool Bar.
 2. A communication channel will be opened through CX-Server. The name of the DTM in the Network view, will turn to Italic font, to indicate that the Unit is on-line.
 3. Select the **Device - Diagnosis** option from the main menu, or from the DTM context menu. The Diagnostics User Interface will now be displayed.

The figure below shows an example of the DTM Diagnostics User Interface.

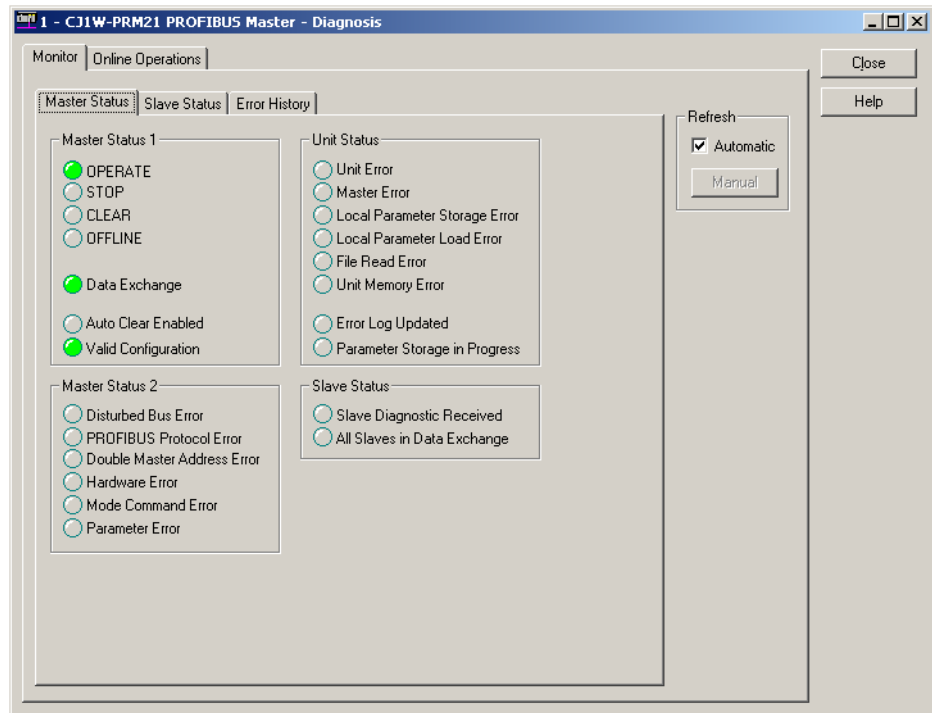

The DTM Diagnostics User Interface contains two tabs:

- The Monitor tab
This tab displays all Master Unit status and error information as well the overall slave status information, which resides in the Master Unit.
- The Online Operations tab
This tab contains controls to initiate state changes in the Master Unit as well as transmit Global-Control messages over the PROFIBUS network.

Monitor Tab

The DTM Diagnostics User Interface - Monitor tab contains three sub-tabs:

- Master Status tab.
- Slave Status tab.
- Error History tab.

Also, the Diagnostics data refreshing mode can be selected.

- Automatic
The Diagnostics data is constantly retrieved from the Unit.
- Manual
The Diagnostics data is retrieved only once from the Unit, when pressing the **Manual** button.

Master Status Tab

The Master Status tab (shown in the figure above) contains Diagnostics information regarding the Master Status. Each of the four status boxes, is related to one of the Unit's status words in the PLC CIO Area Memory (see sections 4-2-3 *Unit Status (Word n+4)* to 4-2-6 *Slave Status (Word n+7)*).

The status is indicated by red or green LED indicators. Red indicates an error situation, green indicates a status indication. The LED indicators are listed in the table below.

	LED Indicator	Description
Master Status 1	OPERATE	Master Unit is in OPERATE mode.
	STOP	Master Unit is in STOP mode.
	CLEAR	Master Unit is in CLEAR mode.
	OFFLINE	Master Unit is in OFFLINE mode.
	Data Exchange	When set to ON, it indicates that the Master Unit is in Data Exchange with all its allocated and enabled slave devices.
	Auto-Clear enabled	Auto-Clear function has been enabled in the downloaded configuration.
	Valid Configuration	The Master Unit contains a valid configuration.
Master Status 2	Disturbed Bus error	When turned ON, the Disturbed Bus error indicates that distorted messages have been received by the Unit. This may occur if the network is not properly terminated or a cable is used, which is too long for the selected baud rate.
	PROFIBUS Protocol Error	When turned ON, the PROFIBUS Protocol Error indicates that an error has occurred in the protocol handling, e.g. a transmitted token frame could not be read back. The Master Unit has switched to OFFLINE.
	Double Master address Error	Indicates that a second Master with the same address has been detected on the Bus. The Master Unit has switched to OFFLINE.
	Hardware error	When turned ON, the Hardware Error indicates that an error has occurred on the bus, e.g. message exceeding 256 bytes, broken messages, faulty bus timing, or devices beyond the HSA have been detected. The Master Unit has switched to OFFLINE.
	Mode Command Error	When set to ON, it indicates that two switches in the CIO switch word (see section 4-2-1 <i>Software Switches 1 (Word n)</i>) were set simultaneously.
	Parameter error	The Parameter set error indicates if an error has been detected in the contents of the Parameters set while configuring the PROFIBUS interface, using these parameters.
Unit Status	Unit Error	A Unit error indicates that a new error has been set in the Unit Status word (see section 4-2-3 <i>Unit Status (Word n+4)</i>).
	Master Error	A Master Error indicates that a new error has been set in the Master Status 2 word (see section 4-2-5 <i>Master Status 2 (Word n+6)</i>).
	Local Parameter Storage Error	An error has occurred when storing the configuration to non-volatile memory.
	Local Parameter Load Error	An error has occurred when loading the configuration from non-volatile memory.
	File Read error	When turned ON, this LED indicates that a transfer from Memory Card to the Unit has failed. The Unit must be re-configured.
	Unit Memory error	When turned ON, it indicates that an error has occurred when writing the Error Log to the Non-volatile memory.
	Error Log Updated	The Error Log contains new entries, since the last time it was read or cleared.
	Parameter Storage in Progress	Configuration Parameters are being transferred to or from the Unit.
Slave Status	Slave Diagnostics Received	When turned ON, it indicates that new slave diagnostics have been received.
	All Slaves in Data Exchange	When turned ON, it indicates that all slaves are in Data exchange with the Master Unit.

Slave Status Tab

The Slave Status tab displays a comprehensive overview of the status of the allocated slaves. An example of the Slave Status tab is shown below.

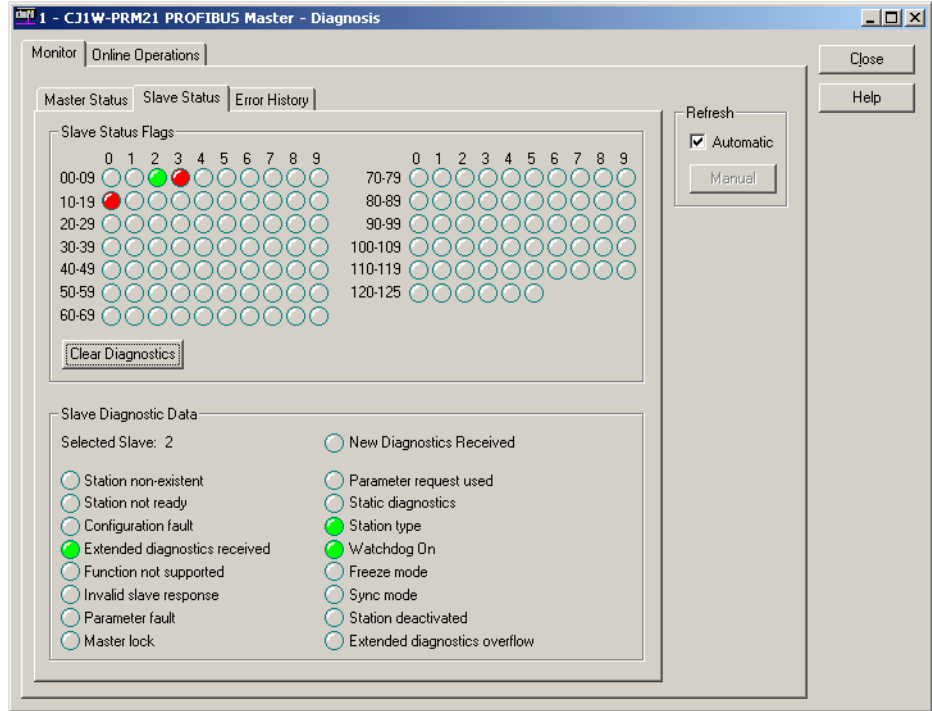

LED Indicator Colours

The LED indicators in the Slave Status Flags box, indicate per slave its status, using colours. Four colours are associated with status conditions. The LED indicator colours are listed below.

Indicator Colour	Slave Status
Grey	Associated device does not exchange Diagnostics with this Master Unit, i.e. <ul style="list-style-type: none"> Slave not allocated to this Master Unit, or Device is this Master Unit, or Device is another master device.
Red	The slave device is not communicating with the Master Unit. It may be disconnected, or the Master is in OFFLINE or STOP mode.
Orange	The slave device is communicating with the PROFIBUS Master Unit, but it is not in Data Exchange, due to incorrect parameter settings. See the slave diagnostics for more information.
Yellow	The slave device is in data exchange with the PROFIBUS Master Unit, but it has reported diagnostics data. See the slave diagnostics for more information.
Green	The slave device is in data exchange with the PROFIBUS Master Unit. No diagnostics reported.

Clear Diagnostics Button

Pressing the **Clear Diagnostics** button will clear all new diagnostics data flags in the Unit. If all slaves are in data exchange, pressing the button will result in all LED indicators turning green.

Retrieving Slave Diagnostics

Provided that the Master Unit is not in OFFLINE or STOP mode, the diagnostics of a specific slave device can be obtained from the LED indicators. Moving the mouse cursor over the LED, will change the cursor from a normal

arrow pointer to a hand. Left clicking the mouse will then transmit FINS messages to retrieve the diagnostics data of the specified slave device.

The retrieved information is displayed in the Slave Diagnostics Data area.

The data displayed is the same as displayed with in the Diagnostics User Interface of the Generic Slave DTM. Refer to section 3-5-2 *Diagnostics User Interface*, for an explanation of the LED indicators.

Error History Tab

The Error History tab lists the contents of the Error Log stored in the PROFIBUS Master Unit. The Error History tab is shown below.

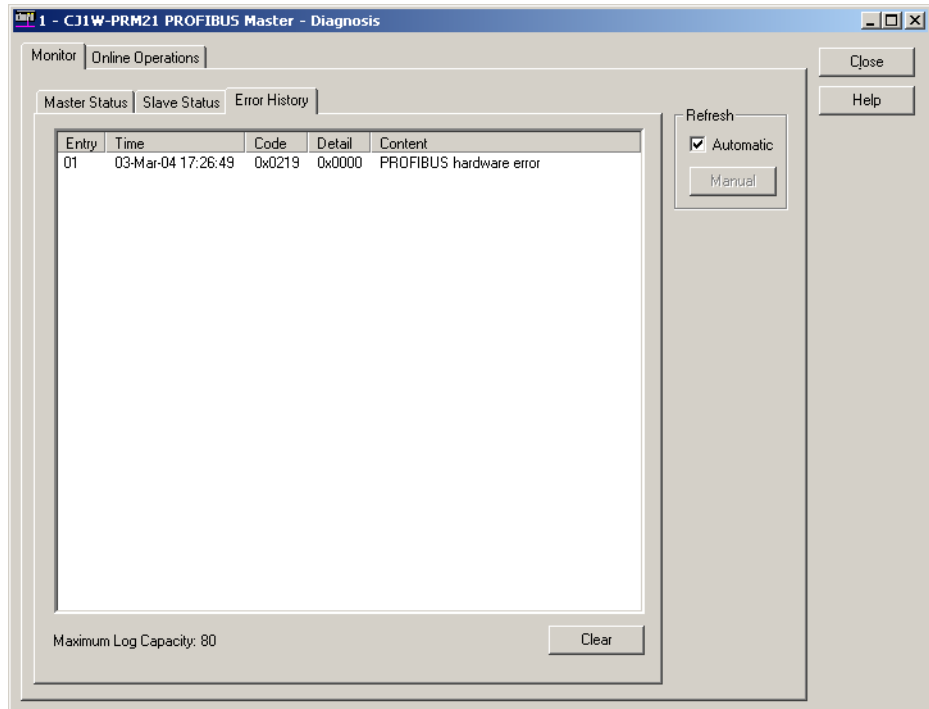

The Error Log entries are described in section 7-5-2 *Error Codes*. Refer to this section for details.

Clear Button

Pressing the **Clear** Button, initiates an ERROR LOG CLEAR FINS command. All error messages in the Unit and the displayed list will be cleared.

Online Operations Tab

The Online Operations tab is the second main tab in the DTM Diagnostics User Interface. It contains the necessary controls to

- Switch the Master Unit to PROFIBUS Operational modes
- Select one or more groups, and Global-Control Commands and transmit Global-Control message over the PROFIBUS network.

The Online Operations tab is shown below.

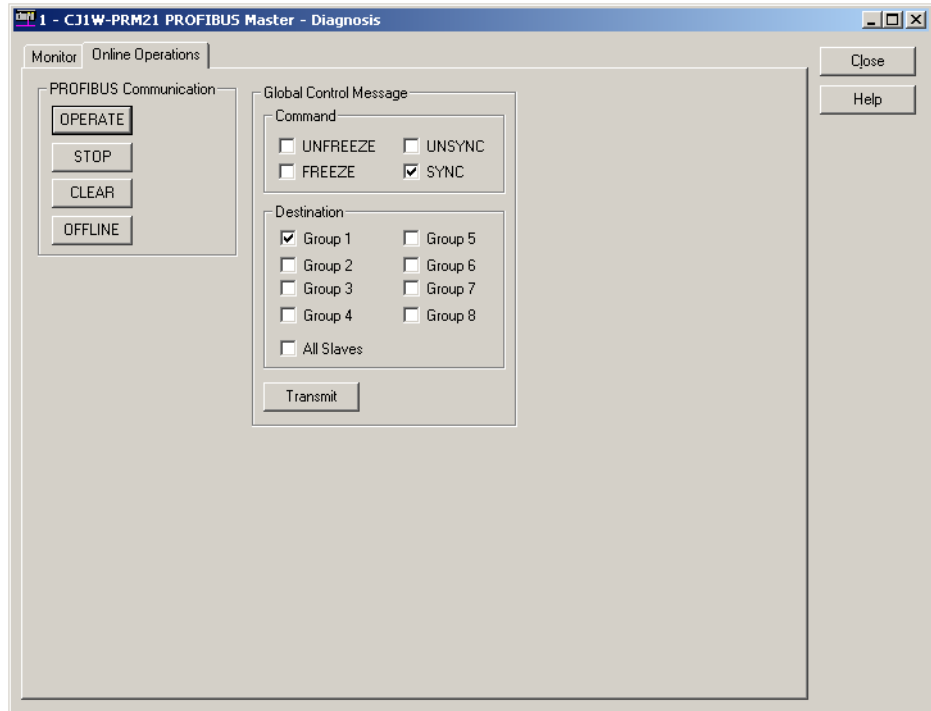

PROFIBUS Communication Group

These buttons can be used to force the Unit to change its operating mode. The four operational modes are

- OFFLINE mode.
- STOP mode.
- CLEAR mode.
- OPERATE mode.

The mode changes are implemented through FINS messages to the Unit's software switches in the CIO Memory Area (see section 4-2-1 *Software Switches 1 (Word n)*).

Caution When initiating a mode change, it may interfere with attempts from the PLC Program to write to the same software switches. Care should be taken to avoid these situations.

Global-Control Messages

Global-Control messages (See section 6-6-3 *Transmitting Global-Control Commands*) can be initiated by the user from the Online Operations tab. The user can select the Global-Control commands.

- Freeze.
- Unfreeze.
- Sync.
- UnSync.

All commands can be transmitted independent from each other, i.e. all can be send at the same time. However, their effects are not independent, as for example sending Freeze and Unfreeze at the same time results in an Unfreeze command at the slaves.

Selecting the Groups

Specific groups to send the Global-Control command to, can be defined by selecting the appropriate checkbox. Selecting the **All Slaves** checkbox will disable the individual checkboxes, and result in a Global-Control command to all slave devices.

Transmit Global-Control Command

In order to transmit the Global-Control, press the **Transmit** button. The command will be transmitted only once. Both the Global-Control command contents, group select and the transmit command are transferred to the Unit through its CIO words (see section 4-2-1 *Software Switches 1 (Word n)* and section 4-2-2 *Global-Control Message (Word n+2)*).

Caution When transmitting a Global-Control command, it may interfere with attempts from the PLC Program to write to the same software switches. Care should be taken to avoid these situations.

3-3-3 Connecting to the CS1/CJ1W-PRM21

Configuring Communication

The PROFIBUS Master DTM uses CX-Server to connect to the Unit for both downloading a configuration as well as monitoring the Master Unit. To setup the communication to the Unit, perform the following procedure.

- 1,2,3...
1. Open the Master DTM Configuration Interface, Device Setup tab (see section 3-3-1 *Configuration User Interface*).
 2. Select the Unit Number. It must match the unit number set on the PROFIBUS Master Unit, through the rotary switch on the front.
 3. Select the **Configure** button to start CX-Server.

CX-Server

Up on pressing the **Configure** button, CX-Server is launched and displays the CX-Server User Interface as shown below.

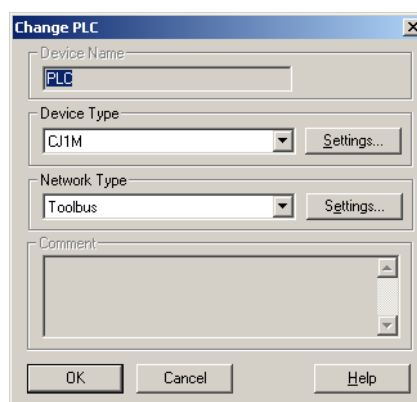

Configuring CX-Server

In order to configure CX-Server for communication with the Unit, perform the following procedure.

- 1,2,3...
1. Select the type of PLC to which the Unit is attached, from the **Device Type** drop down selection box.

2. Press the **Settings** button next to the PLC type selected. The PLC settings window (see figure below) is displayed.

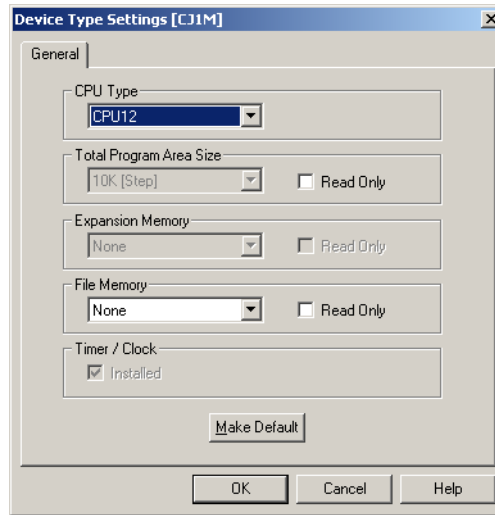

3. In this window make the proper adjustments if necessary. The selections made, must match the physical configuration of the PLC system. When done, press the **OK** button.

4. Select the **Network Type** to be used as connection between the PC and the Unit. The available options may include other PLC systems or Communication Units, which are setup to act as a gateway. Refer to *CX-Server Runtime User Manual (W391)* for details on configuring CX-Server.

Note 1) For further explanation, only the direct connections between the PC and the PLC on which the Unit is attached are considered. These include ToolBus and SYSMAC WAY.

- 2) Select the Settings button next to the Network Type selected, to display the Network settings window, and select the Driver tab (Toolbus is shown as example below).

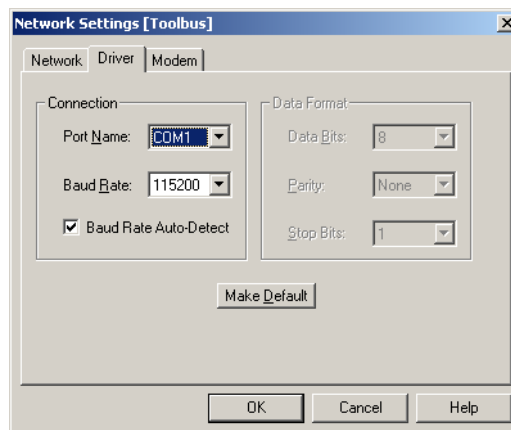

5. Make the necessary selections to facilitate communication between the PC and the PLC CPU to which the PROFIBUS Master Unit is attached, and press the **OK** button.

Testing CX-Server Setup

After making the settings, press the **OK** button to close the CX-Server interface. In order to verify that the communication has been setup correctly, press the Test button in the Device Setup tab of the DTM Configuration User Inter-

face. This will initiate a FINS command to read the Unit's profile, i.e. the name of the Unit and the firmware version.

If the communication has been setup correctly, the response of the FINS command will yield the required information, which will be displayed in the Device Information box, in the **Description** and **Firmware Version** fields. If the communication is not setup correctly, the two fields will contain three dashes, i.e. "---", and an Error message will be displayed in the Error Log view of CX-Profibus. The communication settings must be changed to the correct value first.

When CX-Server has been setup correctly, it can be used for

- Configuration download
- Monitoring purposes

Note Since CX-Server is the common driver software for connection between PC-based CX- programs (e.g. CX-Programmer, CX-Supervisor, etc.) and the CS1/CJ1-series PLC, all these programs can communicate simultaneously with the PLC. However, the settings for CX-Server made through each of these programs have to be exactly the same, to allow simultaneous communication.

Downloading Parameters

In order to download the parameter sets to the PROFIBUS Master Unit, perform the following sequence.

- 1,2,3...**
1. Select the DTM in the Network view and right-click the mouse to display the context menu.
 2. Select **Download Parameters** from the menu, to initiate a download. A communication channel through CX-Server will be opened automatically.

Alternatively, the following can be done.

1. Select the DTM in the Network view and press the Download button in the toolbar to start the download process.

Monitoring

For monitoring, an online connection with the Unit must be made first. To achieve this perform the following sequence.

- 1,2,3...**
1. To go on line, perform one of the following actions.
 - Select the DTM in the Network view.
 - Select the **Device - Go Online** option from the main menu, or the DTM context menu, or
 - Select the  button from the Tool Bar.
 2. A communication channel will be opened through CX-Server. The name of the DTM in the Network view, will turn to Italic font, to indicate that the Unit is on-line.
 3. From the context menu, select the Diagnosis option. The DTM's Diagnostics User Interface will be displayed.

3-4 C200HW-PRM21 PROFIBUS DP Master DTM

C200HW-PRM21 Master DTM

To allow configuration and data monitoring for a C200HW-PRM21 from within CX-Profibus a C200HW-PRM21 PROFIBUS DP Master DTM is available, which can be operated from CX-Profibus.

The C200HW-PRM21 PROFIBUS DP Master DTM has two main user interface components.

- DTM Configuration User Interface
This user interface facilitates configuration of the Master Unit.
- DTM Diagnostics User Interface
The DTM Diagnostics User Interface facilitates Unit status determination, and the slave status determination.

This section provides an overview of the C200HW-PRM21 PROFIBUS DP Master DTM, and discusses both user interfaces.

3-4-1 Configuration User Interface

The configuration DTM is opened by

- Selecting the C200HW-PRM21 Master DTM in the Network view, and double-clicking the left mouse button.
- Selecting the Master DTM in the Network view, and right-clicking the mouse. From the context menu, select **Configuration**.

The Master DTM Configuration User Interface, which is displayed in the CX-Profibus DTM view is shown below.

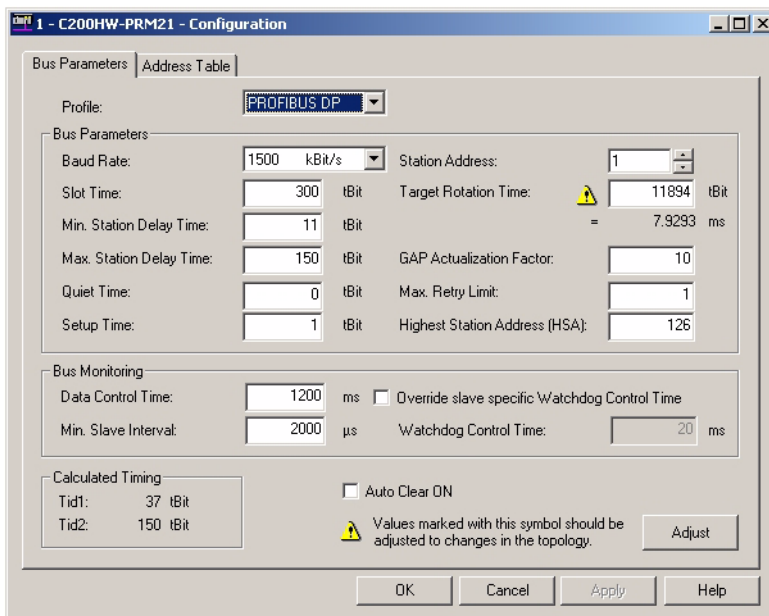

Master DTM Configuration User Interface

The Master DTM Configuration User Interface consist of two tabs:

- Bus Parameters tab
- Address Table tab

The two tabs are discussed below.

Configuration Interface Buttons

The Master DTM Configuration User Interface contains four general buttons. They are listed in the table below, together with the action taken when pressing them.

Button	Action
OK	Evaluate, and save the changes made (if any) and close the user interface. Note If any invalid settings have been made, a warning message will be displayed, allowing cancellation of the command.
Cancel	Closes the user interface without saving. Note If any changes were made, a warning message is displayed, allowing cancellation of the command.
Apply	Evaluate, and save the changes made (if any). Note If any invalid settings have been made, a warning message will be displayed, allowing cancellation of the command.
Help	Launch context sensitive Help for the Active tab.

Caution Saving the changes in the context of the buttons means that the changes made by the user are saved in the DTM only, i.e. the changes are not permanently saved in the Project yet. This is indicated by the asterisk next to the DTM in the Network view. The next time in the same session the GUI is opened, the changes will still be there. In order to save the changes permanently, e.g. to hard disk, Click the **File - Save** option from the main menu of CX-Profibus.

Bus Parameters Tab

The Bus Parameters tab contains the parameters for the communication on the PROFIBUS network. The Bus Parameters tab is shown below.

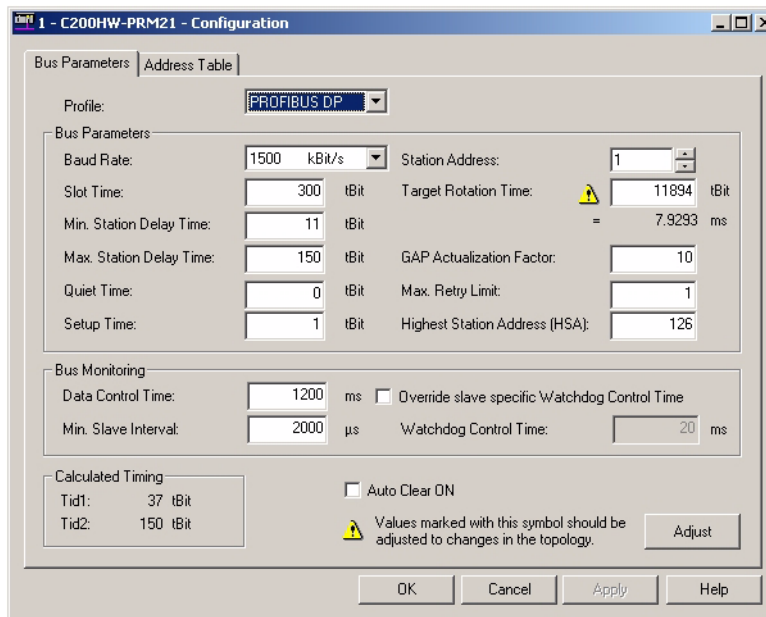

The Bus Parameters are settings, which define the communication behaviour and timing on the PROFIBUS network. The Bus Parameters depend on the selected baud rate, slave communication parameters as well as the number of I/O data bytes exchanged between the Master Unit and each of the slave devices.

The required combination of Bus Parameters is calculated by the program, based on the dependencies mentioned above. However, the user can change selected Bus Parameter manually if the application requires this.

⚠ Caution Changing the calculated Bus Parameters manually is not recommended, and should only be performed if this is really necessary. Changing the Bus Parameters to an invalid combination, may result in Unit malfunctioning and unexpected behaviour.

Note The bus parameter calculations as performed by the C200HW-PRM21 DTM will differ from the calculations performed by the predecessor program SyconDP, due to updated insights in bus calculation algorithms.

The table below lists the parameters, shown in the Bus Parameter tab.

Item	Description	Unit	Editable by User
Profile	Provides pre-selected settings for either a PROFIBUS DP or a PROFIBUS PA network. The following selections are possible from the drop-down list: <ul style="list-style-type: none"> • PROFIBUS DP (Default bit-rate: 1500 kbit/s) • PROFIBUS PA (Default bit-rate: 93.75 kbit/s) 	--	Yes
Baud rate	Defines the transmission rate on the PROFIBUS DP Network. The following baud rate values are defined by the PROFIBUS DP standard: <ul style="list-style-type: none"> • 9.6 kBits/s • 19.2 kBits/s • 93.75 kBits/s • 187.5 kBits/s • 500 kBits/s • 1500 kBits/s (default value) • 3000 kBits/s • 6000 kBits/s • 12000 kBits/s 	--	Yes
Slot Time	The maximum time a Master Unit must wait for a response to a request message.	t _{BIT}	Yes
Min. Station Delay of Responders	The minimum allowed time for a slave device before it will generate a response to a request message.	t _{BIT}	Yes
Max. Station Delay of Responders	The maximum allowed time for a slave device to generate a response to a request message.	t _{BIT}	Yes
Quiet Time	The time a transmitting device must wait after the end of a message frame, before enabling its receiver.	t _{BIT}	Yes
Setup Time	The time between an event and the necessary reaction.	t _{BIT}	Yes
Station Address	This value defines the device address of the C200HW-PRM21 PROFIBUS DP Master unit. Permissible values are in the range of 0 to 125. An attempt to change the address in to a value which is already occupied will result in an error message.		
Target Rotation Time	The anticipated time for one token cycle, including allowances for high and low priority transactions, errors and GAP maintenance.	t _{BIT}	Yes
	Token Rotation Time in ms.	ms	No
GAP Update Factor	The GAP update factor defines the amount of updates of the active devices (i.e. Master devices) list times during one token rotation cycle. To update the list, the Master device will transmit FDL_Status_request messages to ascending device addresses until it finds a next Master device, or until it reaches the Highest Station Address (See HSA below). Permissible values are in the range of 0 to 255.	--	Yes

Item	Description	Unit	Editable by User
Max Retry Limit	Maximum number of request transmission retries by this master if a device does not reply to a request.	--	Yes
Highest Station Address	The HSA defines the Highest Station Address of Master devices on the network, of which the Master device will request the FDL status, when updating the active device list (See GAP Update Factor). If new slaves are added to the network, this field shows the highest device address. The Master will periodically check whether new active devices have been added between its own address and the Highest Station Address. Permissible values are in the range of 0 to 126.	--	Yes
Data Control Time	The cycle time in which the master updates its Data Transfer List, in which it keeps an overview of all slave states. Data Control Time is based on the Watchdog time T_{WD} : Data Control Time = $6 \cdot T_{WD}$.	ms	Yes
Min. Slave Interval	The Minimum Slave Interval defines the poll cycle, i.e. the minimum time between two consecutive Data_Exchange Cycles to the same slave device. The Minimum Slave Interval must be smaller than the Target Rotation Time.	μ s	Yes
Watchdog Control	Override slave specific Watchdog control time. This setting - when selected - allows the user to set one Watchdog Control Time for the whole network and override the Watchdog Control Time provided by the Slave DTM.	--	Yes
	The Watchdog Control Time defines the time for a slave device to set its outputs to a fail-safe state, if during that time no communication between the Master device and that slave device was detected. The Watchdog is automatically set for all configured slaves, based on the value of T_{TR} .	ms	
Calculated Timing	The Calculated Timing is the time that the Sender spends at idle after the receipt of the last Bit of a telegram on the Bus, until the first Bit of a new telegram is sent on the Bus. These values are calculated by the DTM and only displayed for information purposes.	t_{BIT}	No
Auto-Clear ON	When selected, the Unit transitions to the CLEAR mode in the event of a network error, e.g. because one or more configured slaves are not in the Data Exchange mode.	--	Yes

Adjusting Bus Parameters If the bus configuration is changed and these changes have effects on the Bus Parameters, a note symbol  appears next to the concerned parameters of which displayed values are not longer valid. Usually in these cases the displayed values are too small and will eventually lead to communication problems.

The marked parameters need to be recalculated, which can be accomplished by pressing the Adjust button at the bottom right of the Bus Parameter tab. After re-calculation the note symbol will disappear.

Note In case of large networks, it may be required to increase the Watchdog time to allow the network to become fully operational.

Address Table Tab

The Address Table tab displays the mapping of the I/O data from/to the allocated slave devices on to the internal I/O memory of the Unit. The mapping can be made automatically, but can also be changed by the user, before downloading.

The Address Table tab is shown below, containing example data.

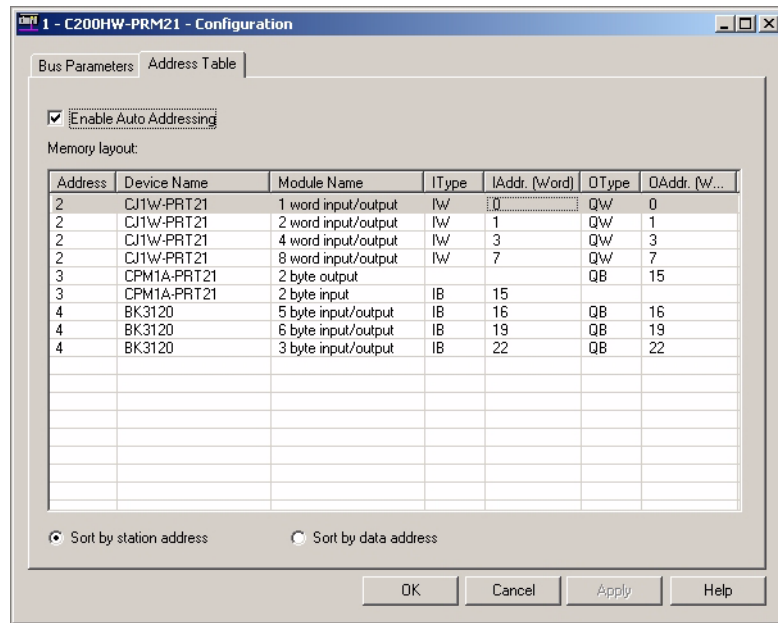

Note The mapping in the Address Table tab does not define the mapping on to the PLC memory areas. This is done by making the appropriate settings in the unit’s DM areas (see Appendix G-2 *Word allocations*).

Address Table Tab

The Address Table tab contains an overall module list, showing all input and output data per slave, along with the Module names, sizes, data types and start addresses. This data has been obtained by the Master DTM by each of the allocated slave DTMs. If no slave devices have been allocated, or configured, the list will be empty.

Memory Layout

The Memory Layout box list contains the following information.

Column	Description
#Addr.	Station address on the network, obtained from the slave DTM.
Device Name	Device name, obtained from DTM.
Module Name	System generated name.
IType	Defines the Type of the Input: <ul style="list-style-type: none"> IB: Input Byte type IW: Input Word type
IAddr	Start Address of the Input data of the Module, relative to the start of the internal memory of the Unit, containing the Input Data block. IAddr is expressed in Words.
OType	Defines the Type of the Output: <ul style="list-style-type: none"> QB: Output Byte type QW: Output Word type
OAddr	Start Address of the Output data of the Module, relative to the start of the internal memory of the Unit, containing the Output Data block. OAddr is expressed in Words.

- Note**
1. Modules consisting of one single byte will occupy a full word address.
 2. A total of up to 512 Input bytes and 512 Output bytes can be mapped on to the Unit’s internal memory. Therefore, the maximum permissible address value is 255 (Words). However, the C200HW-PRM21 to PLC memory mapping is limited to a total of 300 I/O Words.

Address Table Tab Controls	The Address Table Tab contains three controls, related to the I/O mapping. The controls are discussed below.
Enable Auto Addressing	<p>The C200HW-PRM21 DTM provides Auto Addressing to facilitate easy mapping of I/O Modules. When enabled, the I/O Modules are mapped in ascending station address order, while preserving the Module sequence as selected per Slave DTM.</p> <p>This means that when a new module is added for a particular slave device, the new module will be inserted in the already mapped I/O Modules right after the previous module of the same slave device. The consecutive modules, which were already mapped will move to higher addresses.</p>
Changing Mapped Addresses	<p>In case Auto Addressing is not enabled, the user is allowed to change individual mapped addresses by first double-clicking the left mouse button on the mapped address, after which the address can be manually changed. The change will take effect, when selecting either the OK or the Apply button.</p> <p>Note</p> <ol style="list-style-type: none"> 1. In case a changed address overlaps another address in the I/O Mapping, a warning message will be displayed indicating the location of the overlap. The overlap is however not automatically corrected. 2. In case the entered mapping address is located outside the range of internal memory (e.g. an input address of 256 or higher), an error message is displayed and the change is reverted. 3. Enabling Auto-Addressing again will result in all changes being lost. When enabling Auto-Addressing, a Warning message will be displayed, notifying the user of these consequences.
Sorting the Displayed Modules	<p>The I/O Modules list can be sorted for more convenient views. Two options are available:</p> <ul style="list-style-type: none"> • Sort by station address Sorting by station address groups all I/O modules for each slave device together. This view is more convenient in case Auto Addressing is enabled. • Sort by data address Sorting by data address lists the I/O Modules in ascending order, Input data first. This view is more convenient in case Auto Addressing is disabled and addresses have been changed manually.

3-4-2 Diagnostics User Interface

Diagnostics User Interface	<p>The C200HW-PRM21 PROFIBUS DP Master DTM provides a second user interface, to display the Diagnostics information available in the Unit. This information concerns</p> <ul style="list-style-type: none"> • Unit and PROFIBUS DP Interface status flags. • Slave status flags. <p>In order to access the Diagnostics User Interface, the DTM has to be on-line, i.e. a communication channel between the DTM and the PROFIBUS DP Master Unit must have been established.</p>
Opening the DTM Diagnostics User Interface	<p>In order to open the DTM Diagnostics User Interface perform the following sequence.</p> <p>1,2,3...</p> <ol style="list-style-type: none"> 1. To go on line, perform one of the following actions. <ul style="list-style-type: none"> • Select the DTM in the Network view.

- Select the **Device - Go Online** option from the main menu, or from the DTM context menu, or
 - Select the  button from the Tool Bar.
2. A communication channel will be opened through the CIF driver, provided this driver has been assigned to the DTM. Refer to section 3-4-3 *Connecting to the C200HW-PRM21* on how to assign this driver. After going on line The name of the DTM in the Network view, will turn to Italic font, to indicate that the Unit is on-line.
 3. Select the **Device - Diagnosis** option from the main menu, or from the DTM context menu. The Diagnostics User Interface will now be displayed.
- The figure below shows an example of the DTM Diagnostics User Interface.

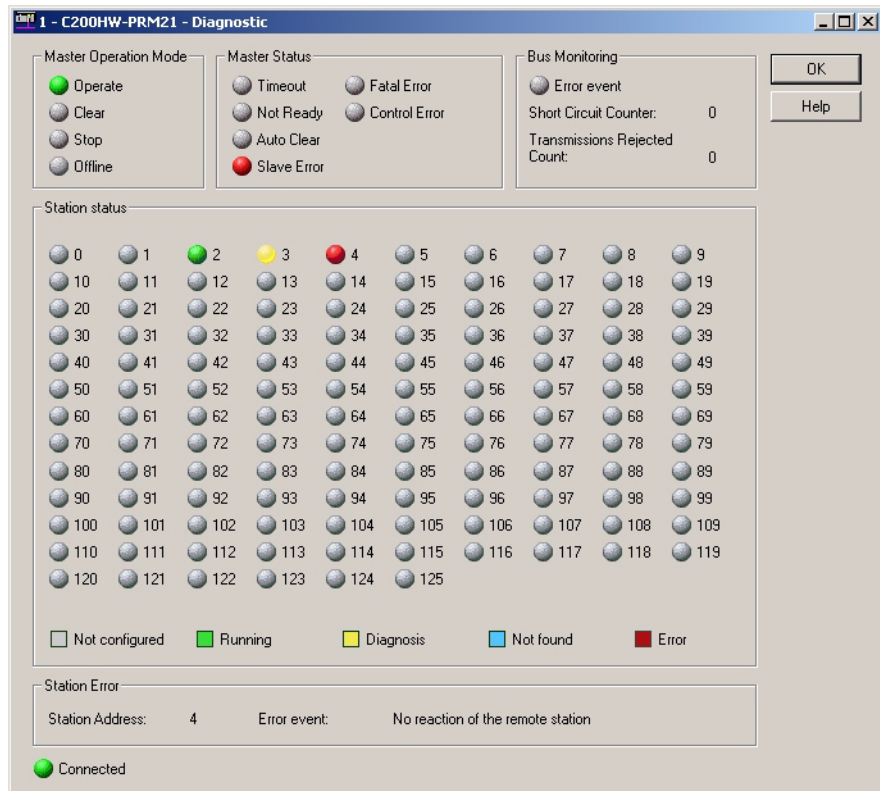

The C200HW-PRM21 DTM Diagnostics User Interface contains five fields of information. These fields are described in the table below.

	LED Indicator / Information Field	Description
Master Operation Mode	Operate	Master Unit is in OPERATE mode, i.e. the Master Unit exchanges I/O data with its slave devices.
	Clear	Master Unit is in CLEAR mode, i.e the Master Unit reads input data from the assigned slave devices, but it sends zeros as output data to the slave devices.
	Stop	Master Unit is in STOP mode, i.e. the Master Unit may only communicate with other Master devices and not with the assigned slave devices.
	Offline	Master Unit is in OFFLINE mode, and not active on the PROFIBUS network.

	LED Indicator / Information Field	Description
Station Status	Timeout	This indicator will be set to ON, when due to the number of rejected PROFIBUS messages, the Master supervisory timeout has expired. This usually indicates a short-circuit in the PROFIBUS network. The amount of timeout events is displayed in the Bus Monitoring field. The indicator will be set to ON upon the first occurrence of the timeout. It will not be reset, until power-down.
	Not Ready	The Not Ready notification indicates that the application program has not started or it has stopped the PROFIBUS DP Master. If this bit is set, the application is not ready to receive data.
	Auto-Clear	Set to ON indicates that an Auto-Clear event has occurred, i.e. data exchange with at least one of the slave devices has stopped. The Master Unit has been switched to CLEAR mode.
	Slave Error	When set to ON, it indicates that at least one of the slaves has encountered an error and is not exchanging I/O data with the Master unit. Refer to the LED indicators in the Station status field to determine which slave devices encountered the error.
	Fatal Error	A Fatal Error has occurred in the PROFIBUS DP Master Unit, due to the large amount of network errors. No further bus communication is possible.
	Control Error	The Control Error indicates that an error has been encountered in the downloaded parameter set. No communication is possible.
Bus Monitoring	Error Event	When set to ON, The Error Event indicates that the device has detected network short circuits. The number of detected events is displayed in the Short Circuit Counter. The bit will be set up on the first detected event and will not be reset, until power-down or reset of the PROFIBUS DP Master Unit.
	Short Circuit Counter	The Short Circuit Counter displays the number of short circuit error events on the PROFIBUS network, which were detected by the Master Unit. Range of Value: 0 to 65535
	Transmission Rejected Count	The Transmissions Rejected Count displays the number of rejected messages. A possible reason for this is, that the Master itself can not receive the token anymore. Range of Value: 0 to 65535
Station status	Any Slave Indicator	The LED indicators in the Station status field display the status of each slave station on the network per address. The colour of the LED indicator indicates the specific status of the slave device: <ul style="list-style-type: none"> • Grey: The slave device is not configured for this Master Unit. • Green: This slave device is exchanging I/O data with the Master Unit. • Yellow: New Diagnostic is available from this slave device. Open the Slave DTM to determine the actual Diagnostics data. Opening this DTM will clear the LED indicator, and turn to another colour until the next Diagnostics message is received from the specified slave device. • Blue: The slave device was configured, but not found on the network. • Red: The slave station has returned a Set_Prm or Chk_Cfg error and is not in data exchange with the Master unit.
Station Error	Station Address	The Station address field displays the address of the first slave device (i.e. with the lowest address) which reported an error. The error is specified in the Error Event field.
	Error Event	The Error Event field displays the error which occurred during communication between the master unit and the slave device as specified in the Station Address field.
--	Connected	When set to ON, this LED indicates that the C200HW-PRM21 DTM is online and exchanging data with the C200HW-PRM21 PROFIBUS DP Master unit.

3-4-3 Connecting to the C200HW-PRM21

Configuring Communication

For the purpose of downloading a configuration as well as monitoring the C200HW-PRM21 PROFIBUS DP Master DTM uses a dedicated serial driver to connect to the Unit through one of the serial ports on the PC. To setup this driver for communication to the Unit, perform the following procedure.

- 1,2,3...
- Open the device's context menu by
 - Selecting the C200HW-PRM21 Master DTM in the Network view, and clicking the right mouse button.
 - Selecting the C200HW-PRM21 Master DTM in the Network view and from the main menu selecting **Device**.
 - From the context menu select **Additional Functions - Device Assignment**. The driver window will open in the DTM view, as shown below.

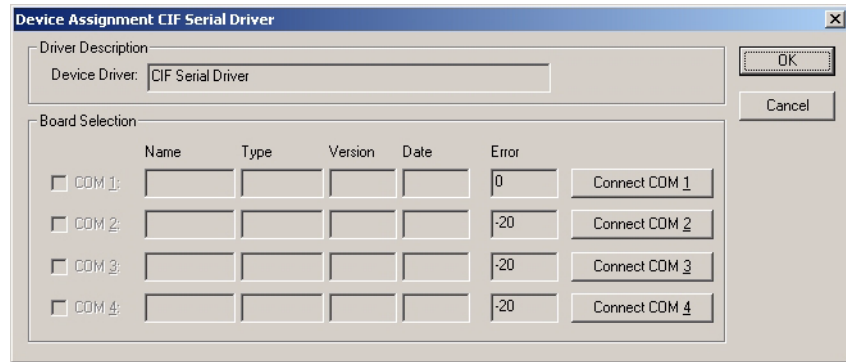

- Make sure that the serial cable is attached between the PC's Serial COM Port, then in the driver window select the **Connect** button, associated with the COM Port to which the C200HW-PRM21 is connected.
- If connection is successful, the Error Field next to the selected button will remain 0. The other fields will contain Name and Version information of the firmware on board the C200HW-PRM21 PROFIBUS DP Master Unit.

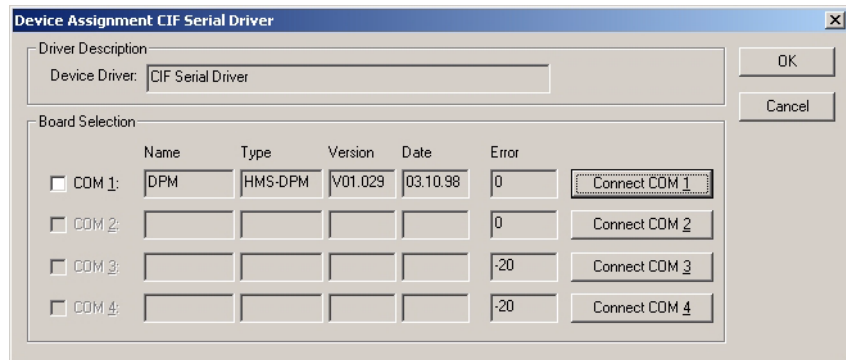

In case of connection error, the Error Field will contain an error code, which can be used to determine the communication problem. Refer to Appendix G-3 *CIF Driver error messages* for descriptions on most common driver error numbers.

- To assign the driver to the selected port and C200HW-PRM21, the checkbox to the left of the COM Port must now be selected, after which the OK button must be pressed to close the window.

Downloading Parameters

In order to download the parameter sets to the C200HW-PRM21 PROFIBUS DP Master Unit, perform the following sequence.

- 1,2,3...**
1. Select the DTM in the Network view and right-click the mouse to display the context menu.
 2. Select **Download Parameters** from the menu, to initiate a download. A communication channel through the CIF driver will be opened.

Alternatively, the following can be done.

Select the DTM in the Network view and press the Download button in the toolbar to start the download process.

Note In case the driver assignment has not been done prior to attempting the download, an error message will be displayed.

Monitoring

For monitoring, an online connection with the Unit must be made first. To achieve this perform the following sequence.

- 1,2,3...**
1. To go on line, perform one of the following actions.
 - Select the DTM in the Network view.
 - Select the **Device - Go Online** option from the main menu, or the DTM context menu, or
 - Select the  button from the Tool Bar.
 2. A communication channel will be opened through the CIF Driver. The name of the DTM in the Network view, will turn to Italic font, to indicate that the Unit is on-line.
 3. From the context menu, select the Diagnosis option. The DTM's Diagnostics User Interface will be displayed.

3-5 Generic Slave Device DTM

Most of the current PROFIBUS DP slave devices are supplied with a GSD file in order to allow a configurator to setup a configuration for that particular slave device. OMRON's Generic Slave Device DTM is provided to allow integration of the GSD file based configuration options into an FDT Container application, like CX-Profibus.

The GSD files are stored in a separate sub-directory under CX-Profibus. Upon updating the Device Catalogue, the Generic Slave Device DTM will scan this sub-directory and present an entry in the Device Catalogue for each of the GSD files found.

Upon adding the GSD based slave device to the network, an instance of the Generic Slave Device DTM will be made in the PC memory, which will read the GSD file contents. The instance of the Generic Slave Device DTM will provide the user interface necessary to make the settings for the associated slave device.

3-5-1 Configuration User Interface

Opening the Configuration DTM

The configuration DTM is opened by

- Selecting the slave DTM entry in the Network view, and double-clicking the left mouse button.
- Selecting the slave DTM in the Network view, and right-clicking the mouse. From the context menu, select **Configuration**.

The slave DTM Configuration User Interface, which is displayed in the CX-Profibus DTM view is shown below. The figure shows the user interface for an OMRON CJ1W-PRT21 PROFIBUS DP Slave Unit. By default the Configuration tab is opened.

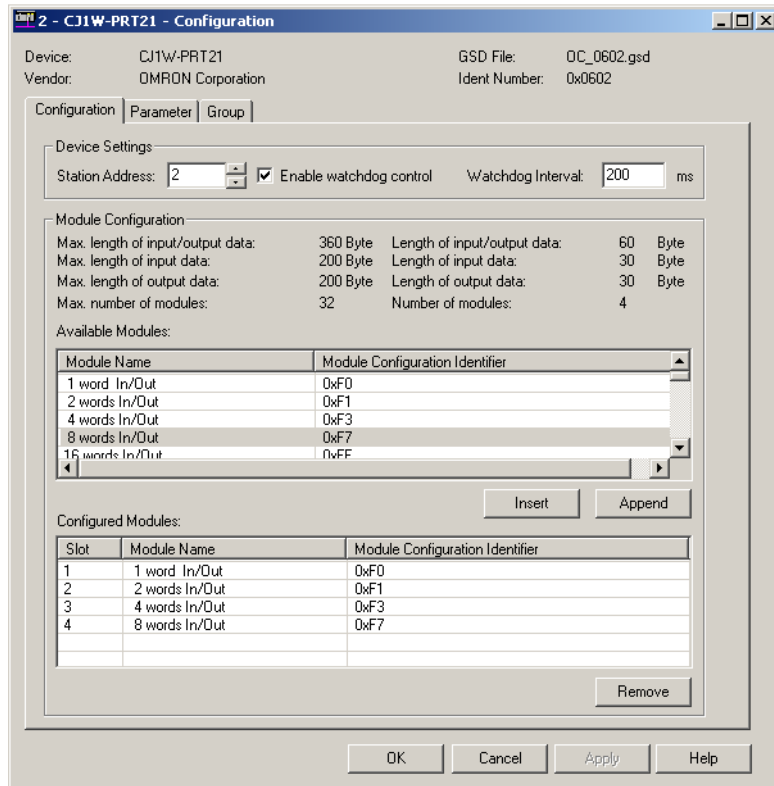

In general, the Configuration User Interface for the Generic Slave Device DTM, contains three tabs. Above these tabs the Device, the Manufacturer, the GSD file and the Unit's PROFIBUS Ident number are displayed.

Note The three tabs allow the user to set the slave parameters and configure the I/O for a standard PROFIBUS DP slave device. For slave devices which support the extension PROFIBUS DP-V1, two additional tabs will be displayed. These tabs are discussed later.

Configuration Tab

The Configuration tab contains the Device settings and the I/O module configuration.

Device Settings

The Device Settings contain the device address, i.e. the Unit's PROFIBUS address and the Watchdog time for the Unit. The device address is normally set automatically by the Master DTM, when the slave DTM is added to its tree. However, the user has the opportunity to change the address. The changed address will be transferred to the Master DTM.

Note In case a changed address is invalid, for example if there is already another slave device with the same new address, the Master DTM will set the number back to its old value.

The Watchdog value is the value used by the slave device to monitor communication from the Master Unit. If no messages are sent to the slave by its Master within the Watchdog timeout time, the slave device will stop data exchange and switch back to the fail safe mode.

Note In the current version of CX-Profibus, the Watchdog setting made in the Generic Slave DTM is overruled by the Watchdog setting in the Master DTM (see also section 6-4-2 *Setting the Bus Parameters*).

Module Configuration

The I/O module configuration defines the I/O Data which the slave will be exchanging with the Master Unit, when it is in data exchange mode. The upper window in the Configuration tab contains all possible modules, which are in the GSD file. The lower window holds all selected I/O modules.

The user has to select the modules, which are associated with the physical configuration of the slave device. Selecting, i.e. copying the module from the upper window to the lower window can be done in several ways.

- Double-click the left mouse button on the selected module in the upper window.
- Select the module in the upper window and click the **Insert** button or **Append** button. Insert will insert the module above the row selected in the lower window. Append will add the module to the end of the selected module list.

- Note**
1. The user can select multiple rows (in both windows) by simultaneously holding the **SHIFT** or **CTRL** key on the keyboard and selecting the rows using the left mouse button.
 2. The amount of I/O modules and data which can be selected depends on the slave device. The four rows of information above the module display the maximum amounts as well as the selected totals.

Removing one or more selected modules from the list is done by

- double-clicking the left mouse button on the module in the lower window.
- selecting the module in the lower window and click the **Remove** button. In this case selecting multiple modules is also possible.

Parameter Tab

The Parameter tab lists all settings to be made for the Parameter message. The Parameter tab is shown below (Example shown is the Parameter tab for an OMRON CJ1W-PRT21 PROFIBUS DP Slave Unit).

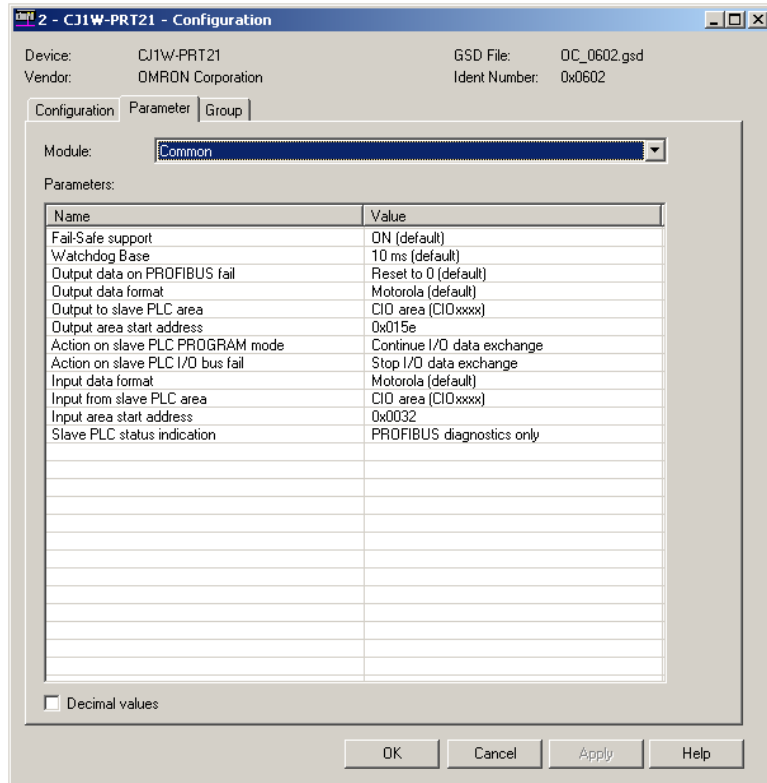

Common Parameters

The PROFIBUS DP parameter message contains a number of settings for the slave device. It is transmitted to the slave device before the I/O configuration message. In most cases a slave device requires a block of Common Parameter settings, i.e. settings which apply to the whole device.

Module Parameters

However, there are also more sophisticated - modular - devices which require parameter settings per I/O module selected. The specific parameters blocks can be selected from the drop-down list at the top of the Parameter tab. In the figure above, the Common parameters are shown. This particular device does not support module parameters, so the parameters shown are the only ones.

The Parameter list consist of a left column containing the name of the Parameter and a right column containing the settings options. In order to change the parameter setting, double-click the row, with the left mouse button. Depending on the type of parameter and the selection options, either the field can be edited directly, or a drop-down list with options will appear.

Note The parameter settings must be performed carefully. In general, the slave device will reject the parameter message, if it contains any faulty parameter. Consequently, the slave device will not reach I/O data exchange with the PROFIBUS Master.

The parameter values are by default displayed in Hexadecimal format. By checking the check box at the bottom, the values are converted to decimal values.

Group Tab

In the Group tab the user can define to which group the slave device will belong. This group definition is used to define multi-cast groups of slave device to which a Global-Control message can be transmitted. The window is shown below.

Selecting the Groups

The user can check the check boxes for each group the slave device will belong to. The group setting is transferred to the slave device as part of the parameter message.

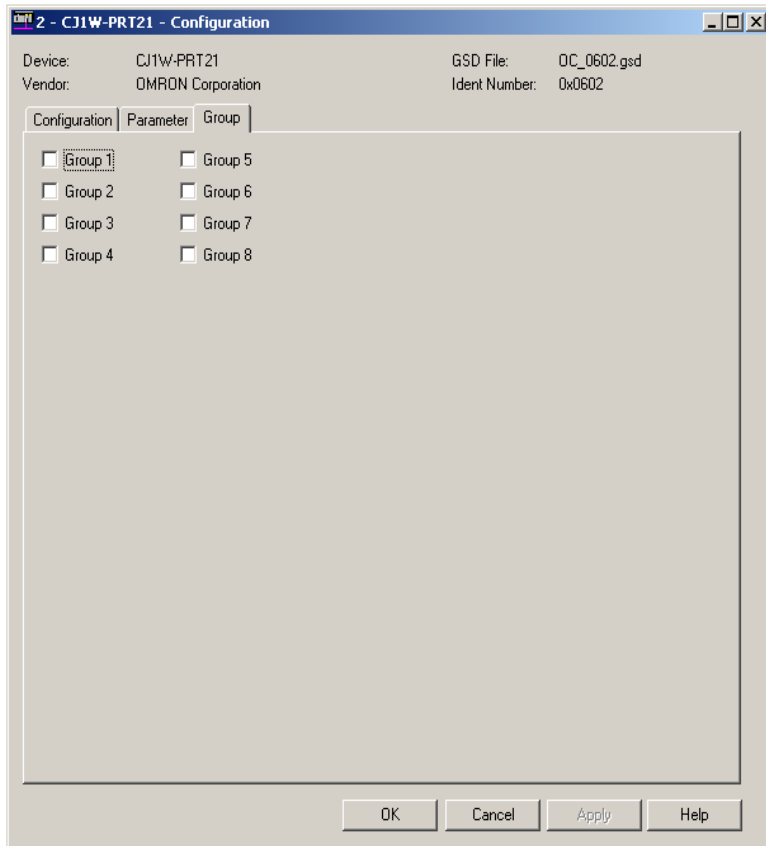

The three tabs discussed above, allow for making all the standard PROFIBUS DP settings for a slave device. For slave devices supporting PROFIBUS DP-V1, two additional tabs will show up. These tabs will appear, if the GSD file parameter **GSD_Revision** is set to 3 or higher. The additional tabs are discussed below.

Extensions Tab

The Extensions tab contains a number of settings, which define additional behaviour of the CS1/CJ1W-PRM21 PROFIBUS Master Unit with respect to a particular PROFIBUS DP-V1 slave device. Although this specific behaviour is defined in the PROFIBUS DP extensions standard (PROFIBUS DP-V1) it does not necessarily require PROFIBUS DP-V1 capabilities from the PROFIBUS Master Units. The Extension tab is shown below.

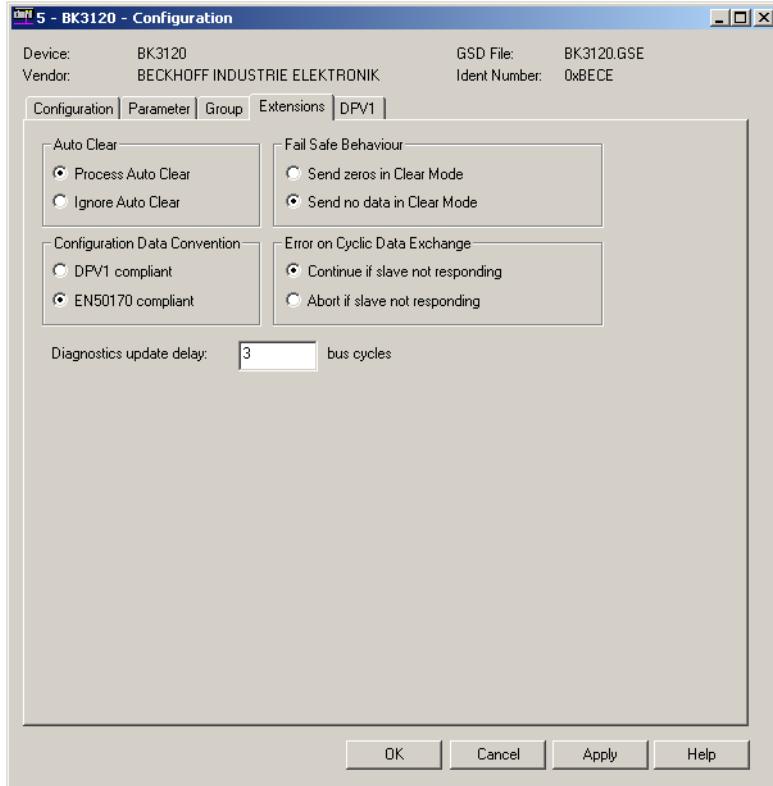

Auto-Clear Processing

The Auto-Clear processing box defines whether or not the PROFIBUS Master Unit should ignore a failure of this particular slave, when Auto-CLEAR has been enabled in the Master Unit (See *Auto-CLEAR Box* on page 69 in section 3-3-1 *Configuration User Interface*). When Ignore Auto-CLEAR has been selected, a failure of this particular slave device (i.e. the slave device requests new parameters, or fails to respond) will not activate the Auto-CLEAR mode. The Master Unit will however, service the slave device.

This feature can be used with slaves which can fail during operation, but for which failure it is not necessary to switch the entire network to Auto-CLEAR mode.

Control	Description
Process Auto-CLEAR	When Auto-CLEAR has been enabled in the PROFIBUS Master Unit, a failure of this particular slave will cause an Auto-CLEAR event.
Ignore Auto-CLEAR	When Auto-CLEAR has been enabled in the PROFIBUS Master Unit, a failure of this particular slave will not cause an Auto-CLEAR event. The Master will however service the slave device (e.g. send new parameters).

Configuration Data Convention

The Configuration Data Convention setting defines how the slave device will handle the special identifier format data parts of the Check I/O configuration message. The slave can perform the check either according to the original PROFIBUS DP standard, or according to the PROFIBUS DP-V1 standard. This allows PROFIBUS DP slaves to use either standard PROFIBUS DP data types or extended PROFIBUS DP-V1 data types.

Control	Description
DPV1 Compliant	The Check I/O configuration message will contain PROFIBUS DP-V1 Data type definitions in the special identifier format data parts and the slave device will perform the check on this assumption.
EN50170 Compliant	The Check I/O configuration message will contain standard PROFIBUS DP Data type definitions as well as vendor specific data types and the slave device will perform the check on this assumption.

Fail-Safe Behaviour

The Fail-Safe Behaviour box defines whether or not the PROFIBUS Master Unit will in CLEAR mode send an empty output data message to the slave device or a data message containing zeros. Depending on the slave device, an empty data message, may be required, if the slave device performs user specific functions in CLEAR mode, and during which the outputs can not be set to zero.

Note If the selected setting is not supported by the slave device, a parameter error will be returned by the device.

Control	Description
Send zeros in Clear mode	When in CLEAR mode, the PROFIBUS Master Unit will send a full output data message to the slave device, but the message will contain all zeros.
Send no data in Clear mode	When in CLEAR mode, the PROFIBUS Master Unit will send an empty output data message (i.e. no data bytes, only the message header) to the slave device.

Error on Cyclic Data Exchange

The Error on Cyclic Data Exchange settings box, defines the behaviour of the PROFIBUS Master Units on the PROFIBUS network with respect to this particular slave device, in case it fails to respond during I/O data exchange. Depending on the setting, the Master Unit will either continue sending I/O data exchange messages to the slave device, or abort I/O data exchange, and continue with requesting the slave diagnostics data. When continuing sending I/O data exchange data, the slave's diagnostics data will not be updated.

Control	Description
Continue if slave not responding	The PROFIBUS Master Unit will continue to send I/O data exchange messages, when the slave device fails to respond. The diagnostics data of the slave will not be updated.
Abort if slave not responding	The PROFIBUS Master Unit will abort the data exchange with the slave device, and continue to send diagnostics request message to the slave, until it responds. The diagnostics data of the slave will be updated accordingly.

Note A slave's failure to respond during I/O data exchange will always be reported to the PLC CPU, by resetting the corresponding Slave Data_Exchange Active flags in the CIO Words (see section 4-2-8 *Slave Data_Exchange Active Flags (Word n+9 to Word n+16)*). If Auto-CLEAR has been enabled, the failure to respond will result in the PROFIBUS Master Unit switching to CLEAR mode, based on this CIO flag.

Diagnostics Update Delay

The Diagnostics Update Delay defines the number of PROFIBUS DP cycles during which the PROFIBUS Master Unit will ignore diagnostics message

returned from the slave containing the Prm_Req flag. This flag indicates that the Master Unit should re-parameterize the slave, but in the case of reduced performance slave devices, the returned flag also indicates that the slave device is still processing the last received parameter message and has as yet not approved nor rejected that message.

During the Diagnostics Update Delay period the PROFIBUS Master Unit will continue requesting its diagnostics data. Also during this period, the diagnostics data received from this slave will not be updated in the PLC CPU.

DPV1 Tab

PROFIBUS DP-V1 defines extended communication functions between a PROFIBUS DP-V1 master and a PROFIBUS DP-V1 slave device. These extensions include:

- Acyclic communications between master and slave, to allow re-parameterization, during I/O data exchange.
- Extended alarm reporting and acknowledgement.

Settings related to these extensions are sent to the slave device through the Set_Prm message.

- Note**
1. The PROFIBUS DP-V1 settings in this tab refer to PROFIBUS DP-V1 Class 1 communication only. For PROFIBUS DP-V1 Class 2 communication no specific settings are required.
 2. The CS1/CJ1W-PRM21 PROFIBUS DP Master units will automatically disable the DP-V1 settings to avoid the slave devices to use PROFIBUS DP-V1 functions. Only the CS1/CJ1W-PRM21 PROFIBUS DP-V1 Master Units will use the settings below.

The DPV1 settings window is shown below.

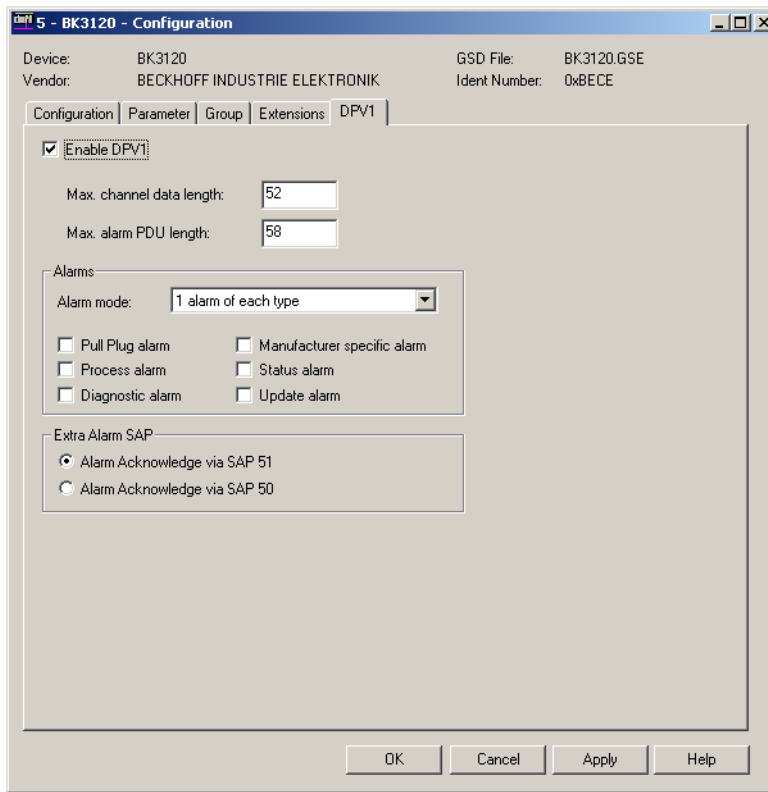

Enable DPV1

This checkbox enables or disables the DPV1 functions for the specific slave device. The Master DTM will clear this setting prior to download.

Max. Channel Data Length This parameter defines the maximum size in bytes of the acyclic message exchanged with the PROFIBUS DP-V1 Master Unit. The size ranges from 4 bytes to 244 bytes. The actual upper limit of the number is defined by the buffer capacity of the slave device.

Max. Alarm PDU Length This parameter defines the maximum size of an Alarm message sent from the slave device to the PROFIBUS DP-V1 Master Unit. The Master Unit uses this number to reserve buffers to handle the alarms. The maximum alarm message size ranges from 4 bytes to 63 bytes

Alarms The Alarms box defines the types of alarms the slave device will report, as well as the alarm handling capacity of the master device. The settings in this box are conveyed to the slave device through the Set_Prm message sent by the PROFIBUS DP-V1 Master Unit.

Control	Description
Alarm mode	The Alarm mode indicates to the slave device the amount of alarms the PROFIBUS DP-V1 Master Unit can process simultaneously. The following standard selections are available: <ul style="list-style-type: none"> • 1 alarm of each selected type • 2 alarms in total • 4 alarms in total • 8 alarms in total • 12 alarms in total • 16 alarms in total • 24 alarms in total • 32 alarms in total
Pull Plug alarm	When set, this checkbox enables the signalling of a pull/plug alarm type, i.e. the removal/insertion of a hardware I/O module.
Process alarm	When set, this checkbox enables the signalling of a process alarm type, i.e. an alarm related to the process connected to the I/O. Example: Upper Limit exceeded alarm.
Diagnostic alarm	When set, this checkbox enables the signalling of a diagnostic alarm, i.e. an alarm related to the functioning of a specific I/O module in a slot. Example: Short circuit detected.
Manufacturer specific alarm	When set, this checkbox enables the signalling of a Manufacturer specific alarm.
Status alarm	When set, this checkbox enables the signalling of a Status alarm, i.e. an alarm related to an internal state change in a module. Example: Change to Run state, Stop state.
Update alarm	When set, this checkbox enables the signalling of an Update alarm, i.e. an alarm indicating a change in the parameters related to a specific module, either by local or remote access.

Extra Alarm SAP For acyclic data exchange between a PROFIBUS DP-V1 Master Unit (Class 1) and a PROFIBUS DP-V1 slave device one specific SAP (Service Access Point, the PROFIBUS definition for a message identifier) is defined by the PROFIBUS DP Extension standard. By default SAP 51 is used for acyclic data exchange with the PROFIBUS DP-V1 Master Unit (Class 1).

For efficiency reasons however, acknowledgement of alarms, can be performed using a different, dedicated SAP or message identifier, SAP50. This will allow other acyclic communication (e.g. re-parameterization of the slave device) to continue without interference.

Control	Description
Alarm acknowledge via SAP 51	When selected, the PROFIBUS DP-V1 Master Unit will acknowledge each received alarm using SAP 51 message identifier (default).
Alarm acknowledge via SAP 50	When selected, the PROFIBUS DP-V1 Master Unit will acknowledge each received alarm using SAP 50 message identifier.

3-5-2 Diagnostics User Interface

The Generic Slave Device DTM provides a Diagnostics User Interface to display diagnostics data sent by the slave device to the PROFIBUS Master Unit. In general a slave device can send two type of diagnostics.

Basic Diagnostics

- Basic Diagnostics
The first six bytes of each diagnostic message sent by a slave device contain mandatory status and error flags. The flags are defined by the PROFIBUS standard. refer to *Appendix B Slave Diagnostics Message* for a detailed overview of diagnostics. The basic diagnostics information is displayed in the Diagnostic tab of the Diagnostics User Interface.

Extended Diagnostics

- Extended Diagnostics
Depending on the type of slave device, it may additionally send Extended diagnostic bytes in a format defined in the PROFIBUS standard. The Extended diagnostics usually contain device specific diagnostics information. The Extended diagnostics information is displayed in the Extended Diagnostics tab of the Diagnostics User Interface.

Updating the Diagnostics

The Diagnostics User Interface contains two tabs. It also contains an **Update** button, which will - when pressed - refresh the diagnostics data, by retrieving it from the PROFIBUS Master Unit. A Green LED indicator in the lower left corner will indicate whether or not the device is on-line.

Diagnostics Tab

The Diagnostics tab displays basic diagnostics for the slave. An example of the Diagnostic tab is shown below. The diagnostics information is displayed

as red and green LED indicators. Red LED indicators refer to error events. Green LED indicator refer to status situations.

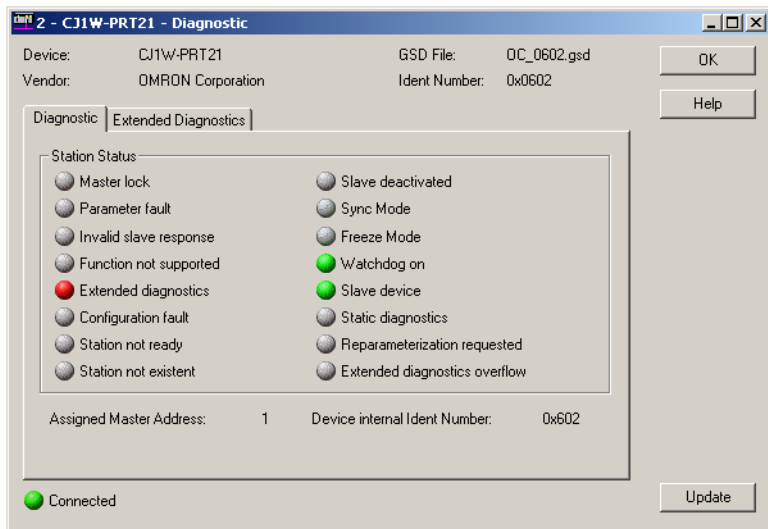

The LED indicators are listed in the table below.

Name	Description
Master lock	The slave device has been parameterized by another master.
Parameter fault	The last received parameter data from the Master Unit have been rejected. The parameter data in the slave device differ from the parameter sent by the Master Unit.
Invalid slave response	The slave has returned an invalid response to a Master request message.
Function Not supported	The Master Unit has sent a message to the slave device, which is not supported by the device.
Extended diagnostics	The diagnostics message returned by the slave device contains extended diagnostics, i.e. it contains more than the mandatory 6 bytes.
Configuration fault	The last received configuration data from the Master Unit have been rejected. The configuration data in the slave device differ from the configuration sent by the Master Unit.
Station not ready	The slave device is not yet ready for data transfer (the parameters data and the configuration data have been accepted).
Station not existent	The slave does not respond to any of the request messages sent by the master. If set the diagnostic bits contains the state of the last diagnostic message or the initial value.
Slave deactivated	When set to ON, it indicates that the slave device has been disabled (i.e. using the STOP FINS command). The slave device is allocated to the Master Unit, but removed from cyclic processing.
Sync mode	When set to ON, the slave device has been set to the Sync mode, using the global command.
Freeze mode	When set to ON, the slave device has been set to the Freeze mode, using the global command.
Watchdog on	The watchdog has been enabled at the slave device (through the appropriate setting in the parameterization message).
Slave device	Indicates that the device is a slave device.
Static diagnostics	When set, the slave device reports static diagnostics, i.e. the error event is serious enough that the diagnostics is continuously reported. No data exchange will be performed.
Re-parameterization requested	When set, the slave indicates that it requires a new parameter setting. The slave device is not in Data_Exchange with the Master Unit. The indicator remains ON as long as the slave device has not been parameterized successfully.
Extended diagnostics overflow	The slave device has more diagnostics to report than it can fit into its transmission buffer. Diagnostics information is being lost.

Extended Diagnostics Tab

The Extended Diagnostic tab contains any extended diagnostics reported by the slave device. The figure below shows an example of Extended diagnostics.

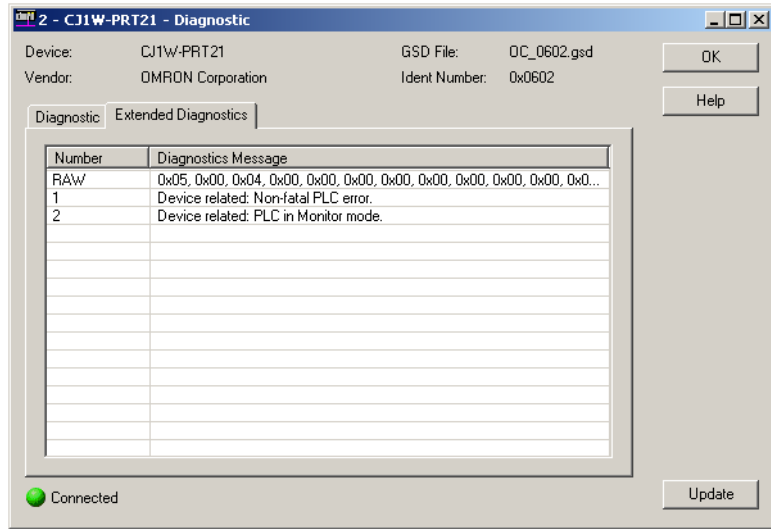

The first row of the Extended diagnostics window contains the raw data as received from the slave device. Depending on the GSD file, it may provide text strings for each Extended diagnostics events entry, i.e. if the event occurs and the diagnostics information is received by the DTM, it can display a text string in stead of only the raw bytes. This makes troubleshooting the device easier.

If the strings are not supported, the user must determine the event from the raw data bytes.

SECTION 4

Allocated CIO and DM Words

This section describes the words allocated to the CS1/CJ1W-PRM21 PROFIBUS Master Unit in the CIO and DM Areas. These words facilitate controlling the Unit and accessing the Unit and network statuses.

4-1	Overview of Word Allocations	110
4-1-1	CIO Area Word Allocations	111
4-1-2	DM Area Word Allocations	111
4-2	Allocated CIO Area Words	112
4-2-1	Software Switches 1 (Word n)	113
4-2-2	Global-Control Message (Word n+2)	114
4-2-3	Unit Status (Word n+4)	117
4-2-4	Master Status 1 (Word n+5)	118
4-2-5	Master Status 2 (Word n+6)	120
4-2-6	Slave Status (Word n+7)	121
4-2-7	Actual Bus Cycle Time (Word n+8)	122
4-2-8	Slave Data_Exchange Active Flags (Word n+9 to Word n+16)	122
4-2-9	Slave New Diagnostics Flags (Word n+17 to Word n+24)	123

4-1 Overview of Word Allocations

The words shown in the following diagram are allocated according to the unit number setting. For each CPU Bus Unit, there are 25 words allocated in the CIO Area and 100 words allocated in the DM Area.

First word allocated in the CIO Area: $n = \text{CIO } 1,500 + (25 \times \text{unit number})$

First word allocated in the DM Area: $m = \text{D30,000} + (100 \times \text{unit number})$

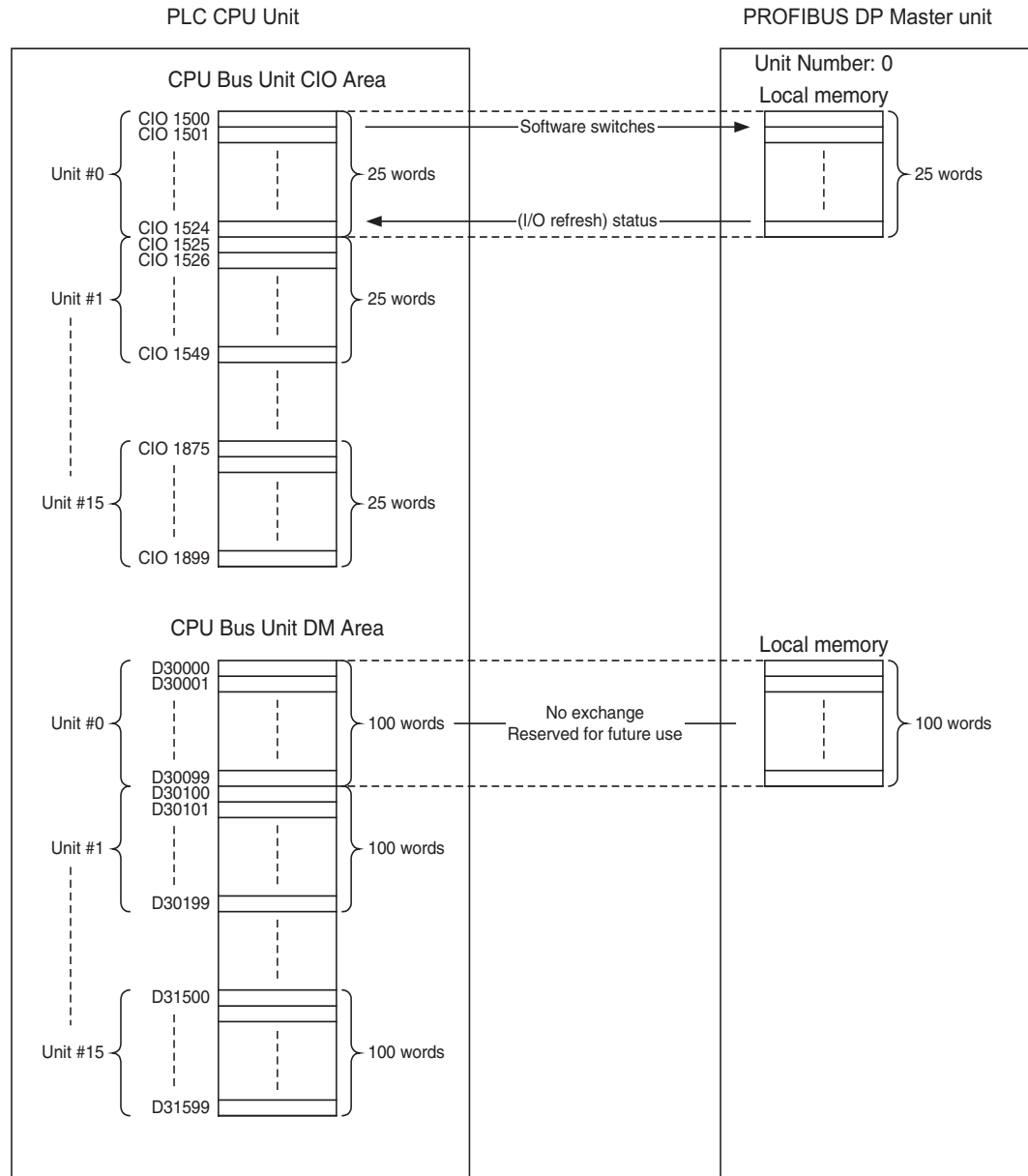

- Note**
1. The allocated DM words are not used by the PROFIBUS Master Unit. However, exchange of data to the allocated DM words is reserved for future use, and it is therefore not recommended to use the allocated DM words for other purposes.
 2. The allocation scheme as shown above does not apply to the C200HW-PRM21 PROFIBUS DP Master Unit. Word allocations for this Unit are listed in section G-2 *Word allocations*.

4-1-1 CIO Area Word Allocations

Software switches, PROFIBUS Master Unit status, and Slave Status data are allocated in the CIO Area according to the unit number, as shown below. Software switches are bits used as commands from the PLC CPU to the PROFIBUS Master Unit to enable executing Unit functions.

Unit number	Allocated words	Unit number	Allocated words
0	CIO 1500 to CIO 1524	8	CIO 1700 to CIO 1724
1	CIO 1525 to CIO 1549	9	CIO 1725 to CIO 1749
2	CIO 1550 to CIO 1574	10	CIO 1750 to CIO 1774
3	CIO 1575 to CIO 1599	11	CIO 1775 to CIO 1799
4	CIO 1600 to CIO 1624	12	CIO 1800 to CIO 1824
5	CIO 1625 to CIO 1649	13	CIO 1825 to CIO 1849
6	CIO 1650 to CIO 1674	14	CIO 1850 to CIO 1874
7	CIO 1675 to CIO 1699	15	CIO 1875 to CIO 1899

4-1-2 DM Area Word Allocations

The DM area words which are allocated for the PROFIBUS Master Unit are not used, i.e. no data is exchanged between an allocated DM area and the Unit. However, the allocated area is reserved for use in a future extension of the Unit. Therefore, using this area for user data is not recommended.

Unit number	Allocated words	Unit number	Allocated words
0	D30000 to D30099	8	D30800 to D30899
1	D30100 to D30199	9	D30900 to D30999
2	D30200 to D30299	10	D31000 to D31099
3	D30300 to D30399	11	D31100 to D31199
4	D30400 to D30499	12	D31200 to D31299
5	D30500 to D30599	13	D31300 to D31399
6	D30600 to D30699	14	D31400 to D31499
7	D30700 to D30799	15	D31500 to D31599

4-2 Allocated CIO Area Words

For each CPU Bus Unit, the CS/CJ-series PLC allocates up to 25 words in the CIO area. Data is stored in the offset position defined by the unit number and shown in the following figure, starting from the first allocated word to the Unit in the CIO Area. First word $n = \text{CIO } 1500 + (25 \times \text{Unit number})$.

Word	Bit 15	Bit 00	Data direction
n	Software switches 1		CPU Unit to PROFIBUS Unit
n+1	Reserved		
n+2	Global-Control command		CPU Unit to PROFIBUS Unit
n+3	Reserved		
n+4	Unit status word		PROFIBUS Unit to CPU Unit
n+5	Master status word 1		
n+6	Master status word 2		
n+7	Slave status word		
n+8	Actual bus cycle time		
n+9	Slave Data-Exchange Active flags		
n+10			
n+11			
n+12			
n+13			
n+14			
n+15			
n+16	Slave New-Diagnostics flags		
n+17			
n+18			
n+19			
n+20			
n+21			
n+22			
n+23			
n+24			

The CIO Words contain two Reserved Words:

- CIO Word n+1 is reserved for future extension of switch functions.
- CIO Word n+3 is reserved for future extension of data to be transferred to the Unit.

These words are reserved for future use, and it is therefore not recommended to use them for temporary data storage by a user program. The Unit will ignore the bits in these words, and consequently not change them, i.e. the Unit will not set the bits to OFF. The other CIO Words are explained in the following sections.

4-2-1 Software Switches 1 (Word n)

All the switches of Software Switch 1 execute a function when turned ON by the user (in any PLC mode). The Unit will turn the switch to OFF, after the command has been executed. All flags are set to OFF at Power-ON/Reset. The Unit state is not restored after a Power-Down of the Unit.

Note If multiple bits in the range of Bit 00 to 03 are set simultaneously, the command is ignored, the bits are set to OFF again and the Mode command error flag in Master status 2 word is set, see 4-2-5 Master Status 2 (Word n+6).

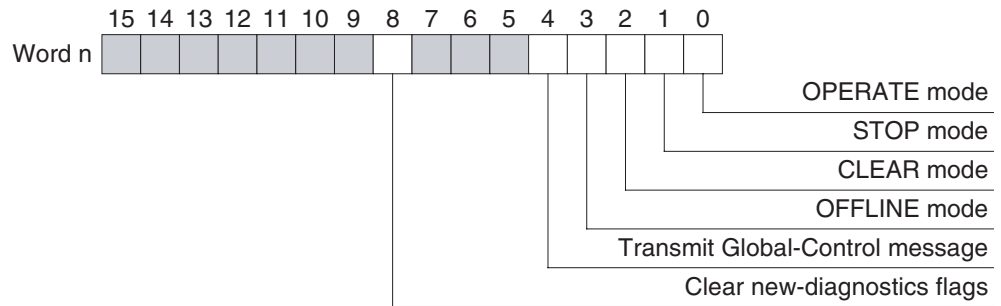

Word n [n = CIO 1,500 + (25 x unit number)]

Bit	Name	Status	Controlled by	Unit operation
00	Switch Master to OPERATE mode	OFF→ON	User	Switches the Unit to the OPERATE mode. If the Unit is already in this mode, no action will be taken. In OPERATE mode the PROFIBUS Master Unit will parameterize all allocated slave devices, and commence I/O Data-Exchange. See Note 1 and 2.
		OFF	Unit	If the PROFIBUS Master Unit has entered the OPERATE mode, the Unit will set this bit to OFF again.
01	Switch Master to STOP mode	OFF→ON	User	Switches the Unit to the STOP mode. If the Unit is already in this mode, no action will be taken. In STOP mode, the Unit will be online, connected to the network, but not communicate with its slave devices. See Note 1 and 2.
		OFF	Unit	If the PROFIBUS Master Unit has entered the STOP mode, the Unit will set this bit to OFF again.
02	Switch Master to CLEAR mode	OFF→ON	User	Switches the Unit to the CLEAR mode. If the Unit is already in this mode, no action will be taken. In CLEAR mode the PROFIBUS Master Unit will parameterize all allocated slave devices, and it will read the input data of the slave devices, but it will send zeros or empty output messages to slave devices. See Note 1 and 2.
		OFF	Unit	If the PROFIBUS Master Unit has entered the CLEAR mode, the Unit will set this bit to OFF again.
03	Switch Master to OFFLINE mode	OFF→ON	User	Switches the Unit to the OFFLINE mode. If the Unit is already in this mode, no action will be taken. In the OFF-LINE mode the Unit will be disconnected from the network. See Note 1 and 2.
		OFF	Unit	If the PROFIBUS Master Unit has entered the OFFLINE mode, the Unit will set this bit to OFF again.

Bit	Name	Status	Controlled by	Unit operation
04	Transmit Global-Control message	OFF→ ON	User	Upon setting this switch the Unit will transmit one Global-Control message over the network. The contents of the message is defined in CIO Word n+2, see 4-2-2 <i>Global-Control Message (Word n+2)</i> . See Note 3.
		OFF	Unit	The bit will be turned OFF by the Unit if the Global-Control message has been transmitted.
05 to 07	Reserved by system	---	---	These bits are ignored in the Unit. If set, they will be immediately returned to OFF.
08	Clear new diagnostics bits	OFF→ ON	User	Upon setting this switch the Unit will clear all new diagnostics bit flags in CIO Word n+17 to n+24. These bits indicate reception of new slave diagnostics data. Clearing the bit flags provides a clear indication for new messages to arrive.
		OFF	Unit	If the bit flags have been cleared, the Unit will reset this bit to OFF.
09 to 15	Reserved by system	---	---	These bits are ignored in the Unit. If set, they will immediately be set to OFF by the Unit.

- Note**
1. When switching the PROFIBUS Master Unit from one mode to another, it will internally implement the mode transition via the intermediate modes, e.g. from OFFLINE to OPERATE, will be performed as OFFLINE → STOP → CLEAR → OPERATE. See also section 1-1-7 *Network Operation Modes*.
 2. If two or more mode switches, i.e. Bit 00 to 03, have been set at the same time, or the Unit can not implement the mode change due to an invalid configuration, the command will be ignored and the Mode command error flag in the Master Status 2 word (CIO Word n+6) will be turned ON. See also section 4-2-5 *Master Status 2 (Word n+6)*.
 3. If the PROFIBUS Master Unit is not in the correct mode, i.e. the Unit is in OFFLINE or STOP mode, the Transmit Global-Control message command will be ignored, but the bit will remain ON. The command will be sent when the Unit transitions to the correct mode, unless the user clears the Bit. No error indication will be generated.

4-2-2 Global-Control Message (Word n+2)

A PROFIBUS Global-Control message can be transmitted by the Unit on user demand to either

Global-Control Multicast Command

- one or more groups of slave devices allocated to the PROFIBUS Master Unit (Multicast command), or

Global-Control Broadcast Command

- all slave devices allocated to the PROFIBUS Master Unit (Broadcast command).

The number of the group to which each slave device belongs, is defined in its parameterization message. Only the slave devices assigned to the groups to which the Global-Control message is addressed will process the command.

Group Address Setting

The group address to send the message to is specified in bit 00 through bit 07. Selecting specific groups of slave devices (i.e. a Multicast command), requires setting of one or more bits in this range to ON. Selecting all slaves (i.e. a Broadcast command) requires all bits in this range to be set to OFF.

The Global-Control command flags are specified in the bit 10 through bit 13.

Transmitting the message is done by setting the Transmit Global-Control message switch, bit 04 in CIO Word n, see 4-2-1 Software Switches 1 (Word n).

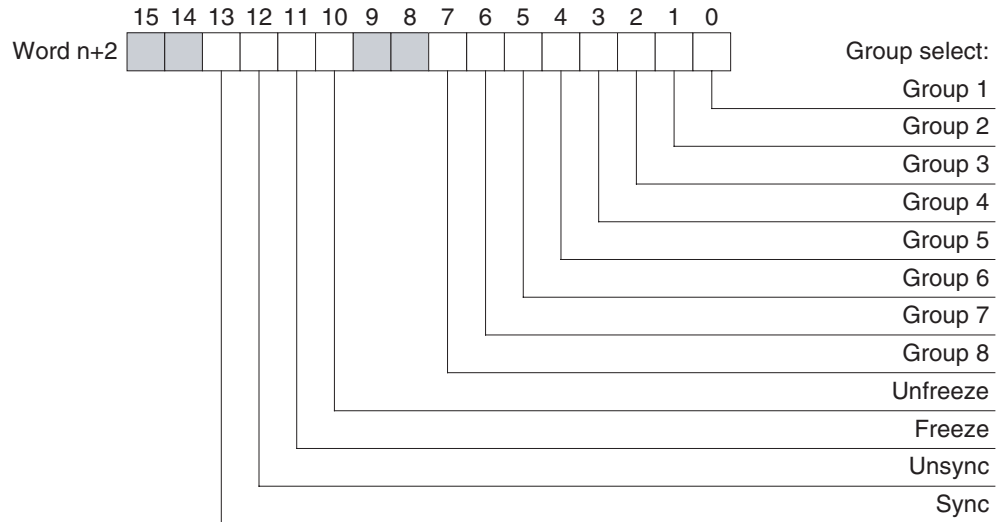

Word n+2 [n = CIO 1,500 + (25 x unit number)]

Bit	Name	Status	Controlled by	Unit operation
00 to 07	Group address	ON	User	Each bit in this range represents one of up to 8 groups of slaves. Bits 00 to Bit 07 will be included within the Global-Control message as group address indicators. If a Group number bit is set, the slave devices assigned to this group number will process the Global-Control command.
		OFF	User	If a Group number bit is not set, the slave devices assigned to this group number will ignore the Global-Control command, except if none of the Group address bits are set, i.e. Bit 00 to Bit 07 are all set to OFF. This selection defines a Broadcast command, causing all slave devices allocated to the PROFIBUS Master Unit to process the Global_Control command.
08 to 09	Reserved by system	---	---	These bits are reserved by the system and will ignored by the Unit.
10	Unfreeze	ON	User	If the Unfreeze bit is set, the Unfreeze command will be send to the targeted slave devices. The Unfreeze command releases the targeted slave devices from the Freeze mode (see below).
		OFF	User	The bit set to OFF indicates that the Unfreeze command will not be transferred to the slave devices.
11	Freeze	ON	User	The Freeze command forces the slave devices into the Freeze mode. In this mode a slave device will not update its inputs to the Master and continue to transmit the input data acquired before the Freeze command. If the slave device is already in the Freeze mode, a new Freeze command will force the slave to update its inputs only once and continue to transmit the new input data to the Master.
		OFF	User	The bit set to OFF indicates that the Freeze command will not be transferred to the slave devices.

Bit	Name	Status	Controlled by	Unit operation
12	Unsync	ON	User	If the Unsync bit is set, the Unsync command will be send to the targeted slave devices. The Unsync command releases the targeted slave devices from the Sync mode (see below).
		OFF	User	The bit set to OFF indicates that the Unsync command will not be transferred to the slave devices.
13	Sync	ON	User	The Sync command forces the slave devices into the Sync mode. In this mode the slave device will not update its outputs and continues to use the output data received before the Sync command. If the slave device is already in the Sync mode, a new Sync command will force the slave to update its outputs only once, with the most recent output data received from the Master.
		OFF	User	The bit set to OFF indicates that the Sync command will not be transferred to the slave devices.
14 to 15	Reserved by system	---	---	These bits are reserved by the system and will ignored by the Unit.

Freeze Mode

The user can set the Freeze and Unfreeze bits at the same time, and both will be transmitted to the targeted slave devices at the same time but the resulting action at the slave device is defined in the PROFIBUS standards.

Bit 10	Bit 11	Resulting action at slave
OFF	OFF	No change in function
OFF	ON	Slave device will be in Freeze mode
ON	OFF	Slave device will be in Unfreeze mode
ON	ON	Slave device will be in Unfreeze mode

Sync Mode

The user can set the Sync and Unsync bits at the same time, and both will be transmitted to the targeted slave devices at the same time, but the resulting action at the slave device is defined in the PROFIBUS standards.

Bit 12	Bit 13	Resulting action at slave
OFF	OFF	No change in function
OFF	ON	Slave device will be in Sync mode
ON	OFF	Slave device will be in Unsync mode
ON	ON	Slave device will be in Unsync mode

4-2-3 Unit Status (Word n+4)

The Unit status word contains all the status and error flags concerning the Unit itself, as well as error flags, which indicate the presence of error flags in the Master and Slave Status Words. All bits are controlled by the Unit.

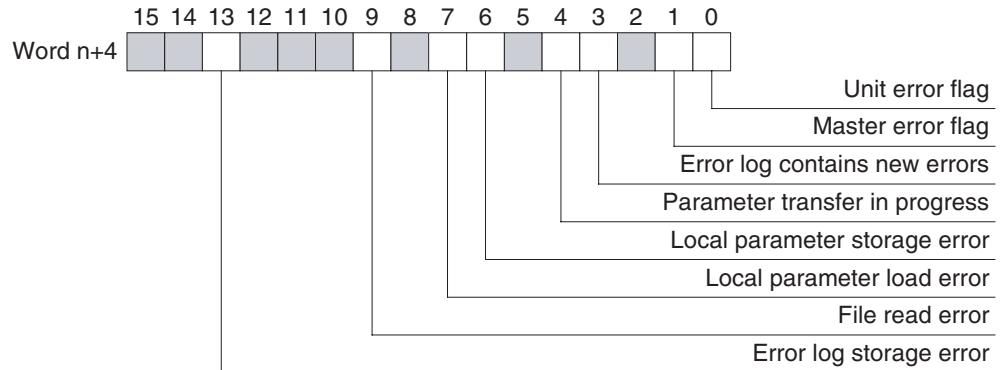

Word n+4 [n = CIO 1,500 + (25 x unit number)]

Bit	Name	Status	Controlled by	Unit operation
00	Unit error flag	ON	Unit	The Unit error flag collects the status of all error flags in CIO Word n+4. The bit flag is turned ON by the Unit if Bit 01, Bit 03, Bit 06, Bit 07, Bit 09 or Bit 13 in CIO Word n+4 is set to ON.
		OFF	Unit	Bit 00 is turned OFF by the Unit if Bit 01, Bit 03, Bit 06, Bit 07, Bit 09 and Bit 13 in CIO Word n+4 are set to OFF.
01	Master error flag	ON	Unit	The Master error flag collects the error flags in the Master status 2 Word, i.e. CIO Word n+6. Master status word 2 contains all error flags related to the PROFIBUS Master functions. Bit 01 is turned ON if any of the flags in Master status word 2, i.e. CIO Word n+6 is set to ON, see 4-2-5 Master Status 2 (Word n+6).
		OFF	Unit	Bit 01 is turned OFF if none of the flags in Master status word 2, i.e. CIO Word n+6 is set to ON.
02	Reserved by system	---	---	This bit will be set to OFF by the Unit.
03	Error log contains new errors	ON	Unit	This bit indicates new errors in the error log since the last time the error log was cleared or read. It is set to ON if the error log contains one or more new errors.
		OFF	Unit	The bit flag is set to OFF by the Unit if the error log is <ul style="list-style-type: none"> cleared using the ERROR LOG CLEAR FINS command, or read, using the ERROR LOG READ FINS command.
04	Parameter transfer in progress	ON	Unit	The Parameter transfer in progress indicates transfer of Configuration and setup data <ul style="list-style-type: none"> from the PC to the Unit's internal volatile memory, or from the Unit's internal volatile memory to non-volatile memory, or from the flash card to the Unit's internal volatile memory. During this transfer no other transfer of data can be started in parallel.
		OFF	Unit	When set to OFF, this bit indicates that no Configuration data transfer is in progress.
05	Reserved by system	---	---	This bit will be set to OFF by the Unit.

Bit	Name	Status	Controlled by	Unit operation
06	Local parameter storage error	ON	Unit	The local parameter storage error flag will be turned ON if an error occurred during an attempt to write the Configuration and setup data to internal non-volatile memory. If the error occurred, the data in the non-volatile memory may be corrupted and a new Configuration must be downloaded to the Unit.
		OFF	Unit	When set to OFF, this bit indicates that the Configuration and setup data has been transferred to the non-volatile memory successfully.
07	Local parameter load error	ON	Unit	The Local parameter load error flag will be turned ON if an error occurred during an attempt to transfer the Configuration and setup data from non-volatile to volatile memory.
		OFF	Unit	The flag will be turned OFF if a successful load attempt is made.
08	Reserved by system	---	---	This bit will be set to OFF by the Unit.
09	File read error	ON	Unit	The File read error flag will be turned ON if an error occurred during an attempt to transfer the Configuration and setup data from a flash card in the PLC CPU to the Unit's non-volatile memory. The error can be caused by an error in the File or an error during transfer.
		OFF	Unit	The flag will be turned OFF if a successful load from flash card is made.
10 to 12	Reserved by system	---	---	These bits will be set to OFF by the Unit.
13	Error log storage error	ON	Unit	The Error log storage error flag will be turned ON if an error occurred during an attempt to write the Error log to internal non-volatile memory. If the error occurred, the Error log data in the non-volatile memory may be corrupted. Upon a restart the Unit will attempt to repair the Error log.
		OFF	Unit	When set to OFF, this bit indicates that the Error log has been transferred to the non-volatile memory successfully.
14 to 15	Reserved by system	---	---	These bits will be set to OFF by the Unit.

4-2-4 Master Status 1 (Word n+5)

The Master Status 1 word collects all status information related to the PROFIBUS Master function. Any errors related to the PROFIBUS Master function are collected in the Master status 2 word.

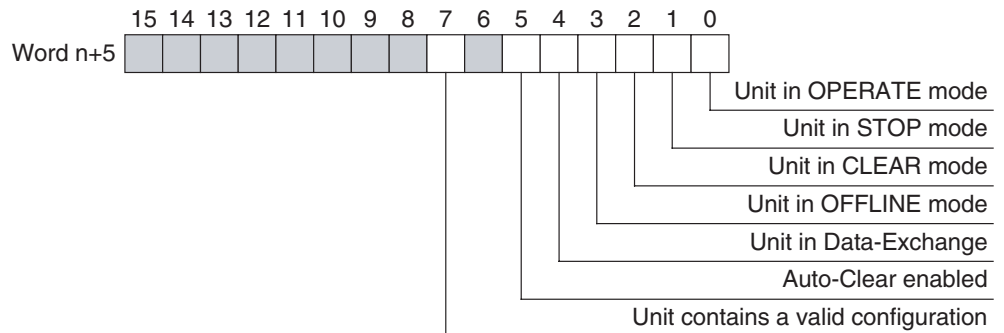

Word n+5 [n = CIO 1,500 + (25 x unit number)]

Bit	Name	Status	Controlled by	Unit operation
00	Unit in OPERATE mode	ON	Unit	Indicates that the Unit is in OPERATE mode. In OPERATE mode the PROFIBUS Master Unit will parameterize all allocated slave devices, and commence I/O Data-Exchange.
		OFF	Unit	Indicates that the Unit is not in OPERATE mode.
01	Unit in STOP mode	ON	Unit	Indicates that the Unit is in STOP mode. In STOP mode, the Unit will be ONLINE, connected to the network, but not communicate with its slave devices.
		OFF	Unit	Indicates that the Unit is not in STOP mode.
02	Unit in CLEAR mode	ON	Unit	Indicates that the Unit is in CLEAR mode. In CLEAR mode the PROFIBUS Master Unit will parameterize all allocated slave devices. If this is accomplished successfully, it will read all input data of the allocated slave devices, but it will send zeros or empty output messages to all slave devices.
		OFF	Unit	Indicates that the Unit is not in CLEAR mode.
03	Unit in OFFLINE mode	ON	Unit	Indicates that the Unit is in OFFLINE mode. In the OFF-LINE mode the Unit will be disconnected from the network.
		OFF	Unit	Indicates that the Unit is not in OFFLINE mode.
04	Unit in Data_Exchange	ON	Unit	If set to ON, this bit indicates that the Unit is in Data_Exchange with at least one allocated and enabled slave device.
		OFF	Unit	If set to OFF, this bit indicates that the Unit is not in Data_Exchange with at any of the allocated and enabled slave devices.
05	Auto-CLEAR enabled	ON	Unit	If set to ON, this bit indicates that the Auto-CLEAR function has been enabled. In case an error occurs in one of the allocated slave devices during Data_Exchange, this function forces the Unit to the CLEAR mode, in which it will force all allocated slave devices to a Fail Safe mode.
		OFF	Unit	If set to OFF, the Auto-CLEAR function has been disabled. If in this case an error occurs in an allocated slave device, the PROFIBUS Master Unit will continue Data_Exchange with the remaining slave devices.
06	Reserved by system	---	---	This bit will be set to OFF by the Unit.
07	Unit contains a valid configuration	ON	Unit	If set to ON, this bit indicates that the Unit contains a valid Configuration. With this Configuration it can parameterize the allocated slave devices and achieve Data_Exchange.
		OFF	Unit	If this bit is set to OFF, the Unit does not contain a valid Configuration or transfer of a new Configuration is in progress.
08 to 15	Reserved by system	---	---	These bits will be set to OFF by the Unit

4-2-5 Master Status 2 (Word n+6)

The Master Status 2 word collects all error information on the Unit master function. The status information is collected in the Master Status 1 word.

The contents of the Master Status 2 word (Word n+6) are:

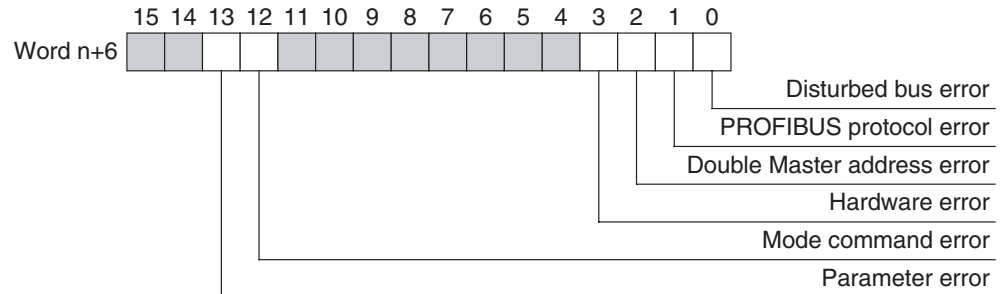

Word n+6 [n = CIO 1,500 + (25 x unit number)]

Bit	Name	Status	Controlled by	Unit operation
00	Disturbed Bus error	ON	Unit	When turned ON, the Disturbed Bus error indicates that distorted messages have been received by the Unit. This may occur if the network is not properly terminated or a cable is used, which is too long for the selected baud rate.
		OFF	Unit	Indicates that no Disturbed Bus error has occurred.
01	PROFIBUS protocol error	ON	Unit	The PROFIBUS Protocol error flag will be turned ON if an error has occurred in the protocol handling, e.g. a transmitted token frame could not be read back. Note In case this error occurs, the Unit will automatically switch to OFFLINE mode.
		OFF	Unit	Indicates that no PROFIBUS protocol error has occurred.
02	Double Master address error	ON	Unit	The Double Master Address error flag will be turned ON if there is another master on the bus with the same with the same device address as the CS1/CJ1W-PRM21. Note In case this error occurs, the Unit will automatically switch to OFFLINE mode.
		OFF	Unit	Indicates that no Double Master Address error has occurred.
03	Hardware error	ON	Unit	The Hardware error flag will be turned ON if an error has occurred on the bus, e.g. message exceeding 256 bytes, broken messages, faulty bus timing or devices beyond the HSA have been detected. Note In case this error occurs, the Unit will automatically switch to OFFLINE mode.
		OFF	Unit	Indicates that no Hardware error has occurred.
04 to 11	Reserved by system	---	---	These bits will be set to OFF by the Unit.

Bit	Name	Status	Controlled by	Unit operation
12	Mode command error	ON	Unit	This bit will be turned ON, if <ul style="list-style-type: none"> • more than one command mode switch has been set, i.e. Bit 00 to Bit 03 in Word n has been set, or • a mode command switch is set while the previous command is in progress, or • a mode transition command is given and the Unit has detected that it does not (yet) have a valid configuration or it detected an internal error, either of which prevented it from reaching that mode, e.g. Invalid Parameter set and transition to OPERATE mode. If this bit is turned ON, it will remain so until a valid command is sent to the Unit. The invalid mode command will be ignored.
		OFF	Unit	If the bit flags have been cleared, the Unit will reset this bit to OFF.
13	Parameter error	ON	Unit	The Parameter set error will be turned to ON if an error has been detected in the contents of the Parameters set while configuring the PROFIBUS interface, using these parameters.
		OFF	Unit	If the bit flags have been cleared, the Unit will reset this bit to OFF.
14 to 15	Reserved by system	---	---	These bits will be set to OFF by the Unit.

4-2-6 Slave Status (Word n+7)

The Slave Status word collects all the information on the slave devices allocated to the Unit Master. It summarizes the slave information of the Slave Data_Exchange Active flags, see 4-2-8 *Slave Data_Exchange Active Flags (Word n+9 to Word n+16)* and the Slave New-Diagnostics flags, see 4-2-9 *Slave New Diagnostics Flags (Word n+17 to Word n+24)*.

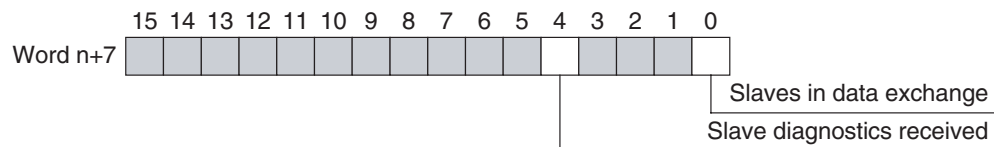

Word n+7 [n = CIO 1,500 + (25 x unit number)]

Bit	Name	Status	Controlled by	Unit operation
00	All slaves in Data_Exchange mode	ON	Unit	All slave devices, which are allocated to the PROFIBUS Master Unit and enabled are in Data_Exchange with the PROFIBUS Master Unit. All slaves which are in Data exchange are indicated in CIO Word n+9 to n+16, see 4-2-8 <i>Slave Data_Exchange Active Flags (Word n+9 to Word n+16)</i> .
		OFF	Unit	When turned OFF, this bit indicates that at least one slave device is not in Data_Exchange with the PROFIBUS Master Unit.
01 to 03	Reserved by system	---	---	These bits are reserved for future use and are always set to OFF by the Unit.

Bit	Name	Status	Controlled by	Unit operation
04	New slave diagnostics received	ON	Unit	At least one of the slave devices, allocated to the PROFIBUS Master Unit indicates that new Diagnostics data is available. The slaves which indicates this data are indicated in CIO Word n+17 to n+19, see 4-2-9 <i>Slave New Diagnostics Flags (Word n+17 to Word n+24)</i> .
		OFF	Unit	When turned OFF, this bit indicates that none of the slave device has returned new diagnostics messages, since the last time the flags were cleared.
05 to 15	Reserved by system	---	---	These bits are reserved for future use and are always set to OFF by the Unit.

4-2-7 Actual Bus Cycle Time (Word n+8)

The actual bus cycle time word indicates the current bus cycle time expressed in BCD in 0.1 ms units. The maximum value is, therefore, 999.9 ms. Values larger than 999.9 ms are set at 9999.

4-2-8 Slave Data_Exchange Active Flags (Word n+9 to Word n+16)

The Slave Data_Exchange Active flags indicate for each slave device if it is in Data_Exchange mode with the PROFIBUS Master Unit. The flags are allocated to a block of eight CIO words, and each bit in the block corresponds to a device address.

	15	14	13	12	11	10	9	8	7	6	5	4	3	2	1	0		
Word n+9	15	14	13	12	11	10	9	8	7	6	5	4	3	2	1	0	Slave station 00 ~ 15	
Word n+10	31	30	29	28	27	26	25	24	23	22	21	20	19	18	17	16	Slave station 16 ~ 31	
Word n+11	47	46	45	44	43	42	41	40	39	38	37	36	35	34	33	32	Slave station 32 ~ 47	
Word n+12	63	62	61	60	59	58	57	56	55	54	53	52	51	50	49	48	Slave station 48 ~ 63	
Word n+13	79	78	77	76	75	74	73	72	71	70	69	68	67	66	65	64	Slave station 64 ~ 79	
Word n+14	95	94	93	92	91	90	89	88	87	86	85	84	83	82	81	80	Slave station 80 ~ 95	
Word n+15	111	110	109	108	107	106	105	104	103	102	101	100	99	98	97	96	Slave station 96 ~ 111	
Word n+16				125	124	123	122	121	120	119	118	117	116	115	114	113	112	Slave station 112 ~ 125

When a slave device is in Data_Exchange with the PROFIBUS Master Unit to which it has been allocated, it is exchanging I/O Data with the PROFIBUS Master Unit.

If the PROFIBUS Master Unit is in CLEAR mode, it will read the slave's input data, but send zeros or an empty message as output data.

If the PROFIBUS Master Unit is in OPERATE mode, it will read the slave's input data, and send any output data provided by the PLC CPU

Word n+9 to n+16 [n = CIO 1,500 + (25 x unit number)]

Bit	Name	Status	Controlled by	Unit operation
-	Slave Data_Exchange Active flags	ON	Unit	If the bit corresponding to a slave device address is ON, it indicates that this slave device <ul style="list-style-type: none"> • is allocated to the PROFIBUS Master Unit, and • is exchanging I/O Data with PROFIBUS Master Unit. In this case, the PROFIBUS Master Unit must be in the CLEAR mode or the OPERATE mode.
		OFF	Unit	If the bit corresponding to a slave device address is OFF, it indicates that the slave is not in Data_Exchange with this PROFIBUS Master Unit, due to the fact that <ul style="list-style-type: none"> • the slave device is not allocated to this PROFIBUS Master Unit, or • the slave device has been allocated to this PROFIBUS Master Unit, but is forced out of Data_Exchange mode, due to a communication error, or • the slave device has been allocated to this PROFIBUS Master Unit, but is not responding, • the slave device has been allocated to this PROFIBUS Master Unit, but is it has temporarily been disabled, • the PROFIBUS Master Unit is not in CLEAR or OPERATE mode

4-2-9 Slave New Diagnostics Flags (Word n+17 to Word n+24)

The Slave New Diagnostics flags indicate for each slave device if it sent a new diagnostics message to the PROFIBUS Master Unit, since the last time it was read or cleared by the CS/CJ-series PLC. The flags are allocated to a block of eight CIO words, and each bit in the block corresponds to a device address.

	15	14	13	12	11	10	9	8	7	6	5	4	3	2	1	0	
Word n+17	15	14	13	12	11	10	9	8	7	6	5	4	3	2	1	0	Slave station 00 ~ 15
Word n+18	31	30	29	28	27	26	25	24	23	22	21	20	19	18	17	16	Slave station 16 ~ 31
Word n+19	47	46	45	44	43	42	41	40	39	38	37	36	35	34	33	32	Slave station 32 ~ 47
Word n+20	63	62	61	60	59	58	57	56	55	54	53	52	51	50	49	48	Slave station 48 ~ 63
Word n+21	79	78	77	76	75	74	73	72	71	70	69	68	67	66	65	64	Slave station 64 ~ 79
Word n+22	95	94	93	92	91	90	89	88	87	86	85	84	83	82	81	80	Slave station 80 ~ 95
Word n+23	111	110	109	108	107	106	105	104	103	102	101	100	99	98	97	96	Slave station 96 ~ 111
Word n+24			125	124	123	122	121	120	119	118	117	116	115	114	113	112	Slave station 112 ~ 125

Word n+17 to n+24 [n = CIO 1,500 + (25 x unit number)]

Bit	Name	Status	Controlled by	Unit operation
-	Slave New Diagnostics flags	ON	Unit	<p>If the bit corresponding to a slave device address is ON, it indicates that this slave device</p> <ul style="list-style-type: none"> • is allocated to the PROFIBUS Master Unit, and • has sent new diagnostics message to the PROFIBUS Master Unit. <p>In this case, the PROFIBUS Master Unit must be in CLEAR mode or OPERATE mode.</p>
		OFF	Unit	<p>If the bit corresponding to a slave device address is OFF, it indicates that</p> <ul style="list-style-type: none"> • the slave device has not sent a new diagnostics message to the PROFIBUS Master Unit, since the last time it was read or cleared, or • the slave device has not been allocated to this PROFIBUS Master Unit, or • the PROFIBUS Master Unit is not in CLEAR or OPERATE mode <p>Note In case an allocated slave device is not responding, and therefore not sending a diagnostics message, the PROFIBUS Master Unit itself will provide a diagnostics message to the PLC CPU containing the mandatory first 6 bytes. This diagnostics message will then indicate that the slave is not responding.</p>

SECTION 5

FINS Commands and Responses

This section describes the FINS message service communications commands concept as well as the commands supported by the CS1/CJ1W-PRM21 PROFIBUS Master Units.

5-1	FINS Commands and Responses	126
5-1-1	FINS Message Service Communications	126
5-1-2	Command Code List	127
5-1-3	Response Code List	127
5-1-4	Sending FINS using CMND	128
5-2	Command / Response Reference	129
5-2-1	MEMORY AREA READ (0101)	129
5-2-2	RUN (0401)	130
5-2-3	STOP (0402)	131
5-2-4	CONTROLLER DATA READ (0501)	132
5-2-5	ERROR LOG READ (2102)	132
5-2-7	EXPLICIT MESSAGE SEND (2801)	134
5-2-6	ERROR LOG CLEAR (0203)	134
5-2-8	PROFIBUS MESSAGE SEND (2809)	136

5-1 FINS Commands and Responses

5-1-1 FINS Message Service Communications

FINS

FINS (Factory Intelligent Network Services) commands are message service communications commands developed by OMRON for Factory Automation control devices. They do not depend on a particular transmission path, and can be used for reading from and writing to PLC memory or the Unit's memory, sending or receiving acyclic messages over a network, or for controlling various operations.

The FINS communications can be issued from a CPU Unit, Special I/O Unit, or host computer, and they can also be sent to any of these. The specific commands that can be sent depend on the destination.

When the source of the commands is a PLC CPU Unit, the FINS commands are sent by means of CMDND(490). For details on FINS commands, refer to the *Communications Commands Reference Manual (W342)*

Note The C200HW-PRM21 does not support FINS commands.

The CS1/CJ1W-PRM21 PROFIBUS Master Units support three types of FINS messages:

1. FINS commands targeted at the Unit itself, with the purpose of sending or retrieving data or invoking control actions.
2. FINS commands facilitating data transfer using PROFIBUS services, targeted at a specific slave device connected to the same PROFIBUS network as the PROFIBUS Master Unit.
3. FINS commands containing a CIP-defined explicit message, targeted at a specific OMRON slave device connected to the same PROFIBUS network as the PROFIBUS Master Unit.

Note FINS commands of the second type are supported as of Unit version 2.0. The FINS commands of the third type are supported as of Unit version 3.0.

The figure below depicts the FINS command structure for the CS1/CJ1W-PRM21 PROFIBUS Master units.

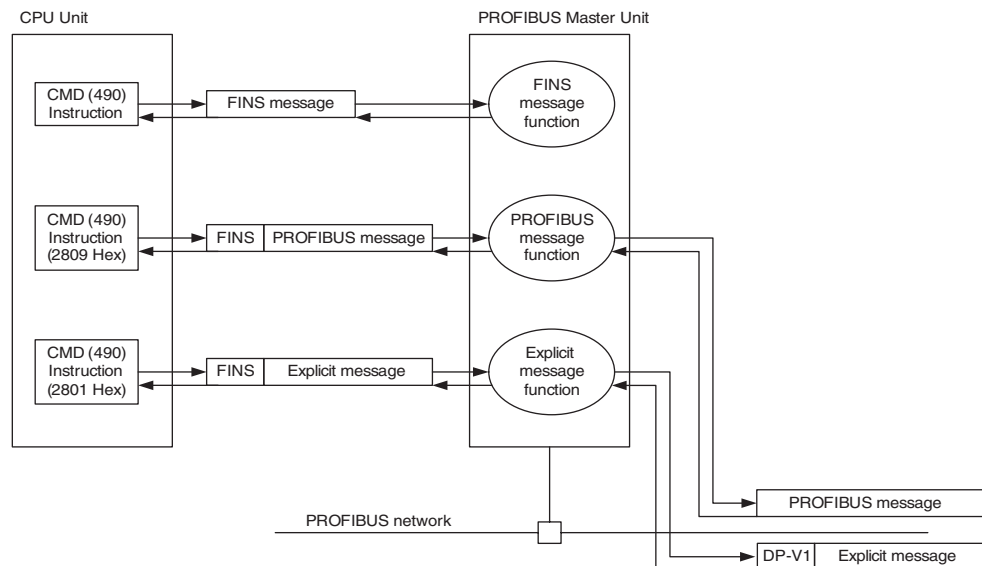

FINS messages are defined through their command and response codes.

Command Codes

Command codes are represented by a 2-byte hexadecimal code. FINS commands always begin with a 2-byte command code; any parameters required follow the command code.

Response Codes

The response code consists of a 2-byte hexadecimal code indicating the results of command execution. The first byte provides the main response code (MRES), which classifies the results, the second byte provides the sub-response code (SRES), which contains details about the results.

5-1-2 Command Code List

The command codes listed in the following table are supported by the PROFIBUS Master Unit. A PLC program can send these to the Unit.

Command code		Name	Page
MRC	SRC		
01	01	MEMORY AREA READ	129
04	01	RUN	130
	02	STOP	131
05	01	CONTROLLER DATA READ	132
21	02	ERROR LOG READ	132
	03	ERROR LOG CLEAR	134
28	01	EXPLICIT MESSAGE SEND (See Note 2)	134
28	09	PROFIBUS MESSAGE SEND (See Note 1)	136

- Note**
1. FINS command 2809 has been implemented as of Unit version 2.0.
 2. FINS command 2801 has been implemented as of Unit version 3.0.

5-1-3 Response Code List

Response codes are 2-byte codes which indicate the results of command execution. They are returned in the response following the command code.

The first byte of a response code is the MRES (main response code), which categorizes the results of command execution. The second byte is the SRES (sub-response code) which specifies the results.

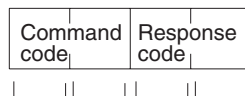

MRC: Main request code
 SRC: Sub-request code
 MRES: Main response code
 SRES: Sub-response code

MRC SRC MRES SRES

The MRES codes are shown in the following table along with the results they indicate. Refer to *Communications Commands Reference Manual (W342)* for details on response codes including the SRES.

MRES	Execution results
00	Normal completion
01	Master Unit error
02	Slave device error
04	Service not supported
10	Command format error
11	Parameter error

20	Read not possible
22	Status error

Note If the FINS command was not completed normally, the 2-byte Response code will be unequal 0000. In that case, the Response frame will not contain any further data. Data can only be returned - depending on the command - when the Response code is 0000.

5-1-4 Sending FINS using CMND

The CMND instruction can be executed from the user program in a CS/CJ-series PLC. CMND sends “n” bytes of command data beginning with S (the beginning send word for storing command data at the source node) to destination node N. In return, “m” bytes of response data are stored at the source node beginning with D (the beginning receive word for storing response data).

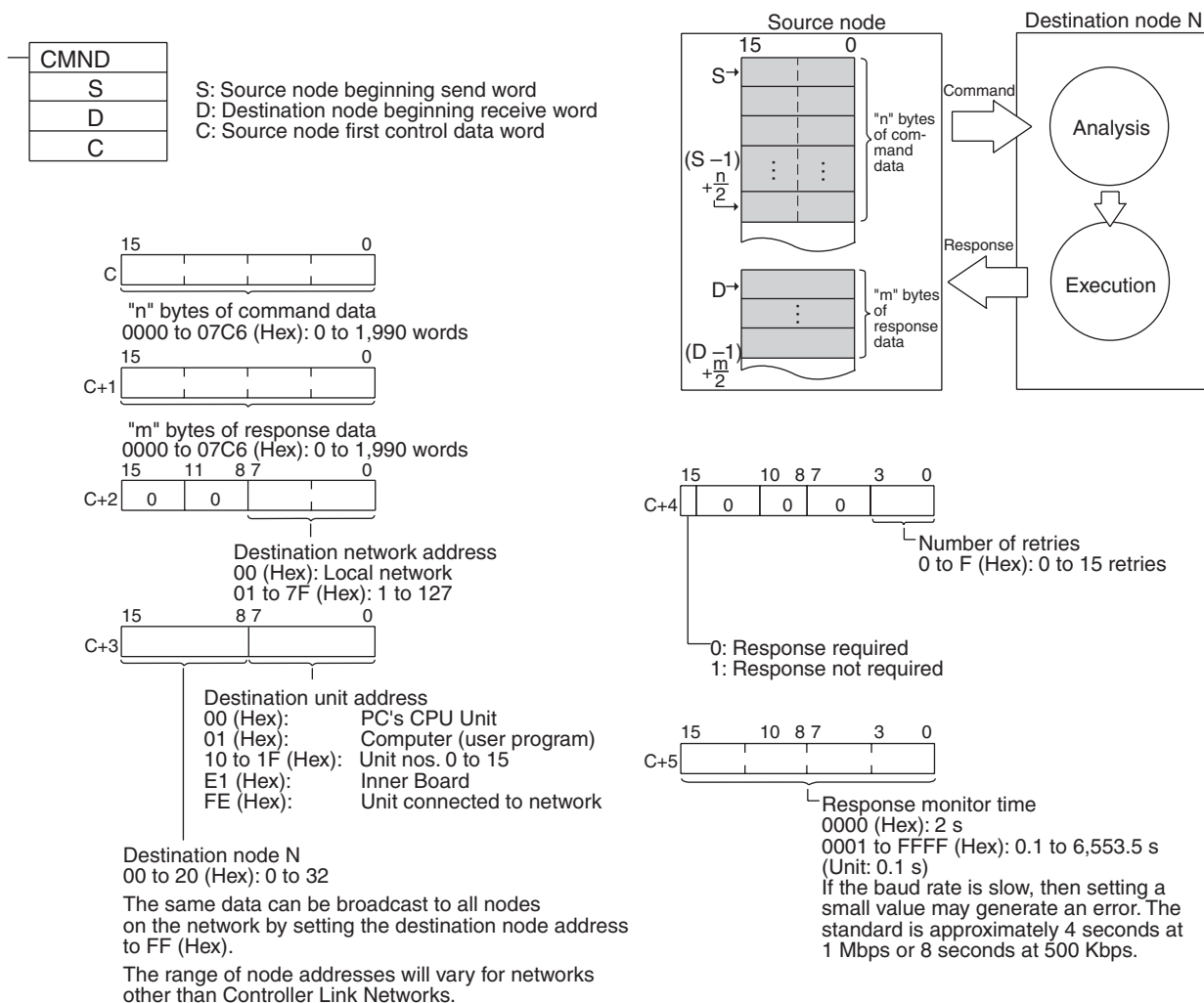

Note With the message service, there is no guarantee that a message to a destination node will reach its destination. It is always possible that the message may be lost in transit due to noise or some other condition. When using the message service, it is advisable to prevent this situation from occurring by performing resent processing at the node where instructions are issued. With the CMND instruction, resent processing is performed automatically once the

number of retries has been set, so be sure to specify a number other than "0" for the number of retries.

5-2 Command / Response Reference

This section describes the FINS commands that can be sent to the PROFIBUS Master Units and the responses to each command.

The command, response, and (where applicable) the results storage blocks are given with the commands in graphic form as shown in the following diagram. If the data is fixed, it is included in the blocks. If the data is variable, it is described following the blocks. Each box represents 1 byte; two boxes represent 1 word. The following diagram shows 2 bytes, or 1 word.

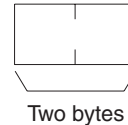

Response codes applicable to the command are described at the end of the command description.

Note If the FINS command was not completed normally, the 2-byte Response code will be unequal 0000, and the Response frame will not contain any further data. Data can only be returned - depending on the command - when the Response code is 0000.

5-2-1 MEMORY AREA READ (0101)

The MEMORY AREA READ command is used to the last diagnostics data message the PROFIBUS Master Unit received from the specified slave device. The command frame requires three byte data type specifier, specifying the information, and one byte specifying the slave device address.

The number of items to read must be 244 - the maximum data size of the PROFIBUS DP diagnostics message - or less.

Command Format

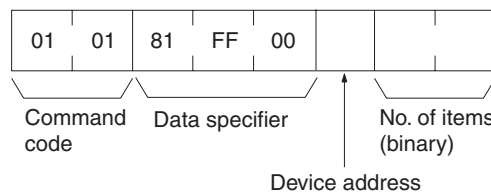

Response Format

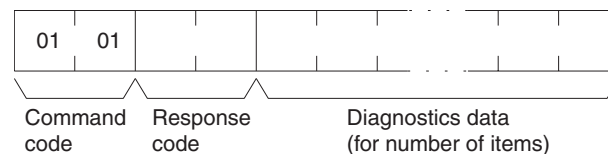

Parameters

Data specifier code (command)

Defines the data to be retrieved from the Unit. Always set to 81 FF 00 (Hex).

Slave device address (command)

Defines the slave device network address. Set to 00 ~ 7D (Hex).

Number of items to read (command)

Defines the number of bytes to read. Set to 1 ~ F4 (Hex).

Response Codes

The following end codes can be returned by the Unit in response to the RUN command:

Response code	Description
0000	Normal completion.
0203	Slave device not allocated to the PROFIBUS Master.
0402	Service not supported by Unit model / version.
1001	Command too large.
1002	Command too short.
110C	<ul style="list-style-type: none"> Invalid start address code word (non-specified code used). Invalid target slave address (exceeds 125).
2208	Unit is not in correct mode, e.g. it is in OFFLINE or STOP mode.

5-2-2 RUN (0401)

Initiates a state change within the PROFIBUS Master Unit. This command will enable a pre-allocated slave device in the PROFIBUS Master Unit. The targeted slave device will be added to the Unit's list of active devices and will be parameterized by the Unit.

The configured slave devices are by default enabled, but can temporarily be disabled, i.e. removed from the active device list (see 5-2-3 STOP (0402)).

The targeted slave device is defined by the device code in the command.

Command Format

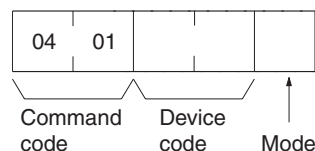

Response Format

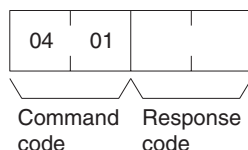

Parameters

Device code (command)

Defines the slave device to be enabled state as follows:

High byte: Always set to 81(Hex).

Low byte: 00 ~ 7D (Hex): Defines the slave device network address.

Mode (command)

Always set to 01 (Hex).

Response Codes

The following end codes can be returned by the Unit in response to the RUN command:

Response code	Description
0000	Normal completion.
0203	Slave device not allocated to the PROFIBUS Master.
0402	Service not supported by Unit model / version.
1001	Command too large.

Response code	Description
1002	Command too short.
110C	<ul style="list-style-type: none"> • Mode code setting not supported (code exceeds 01). • Invalid device code (High byte not equal to 81) • Invalid target slave address (exceeds 125).

5-2-3 STOP (0402)

Initiates a state change within the PROFIBUS Master Unit. This command will disable a pre-allocated slave device in the PROFIBUS Master Unit. The targeted slave device will temporarily be removed from the Unit's list of active devices. The Unit will Unlock the slave device and stop communication with it.

Note The configured slave devices are by default enabled. A disabled slave device can be enabled using the RUN command (see 5-2-2 RUN (0401)).

The targeted slave device is defined by the device code in the command.

Command Format

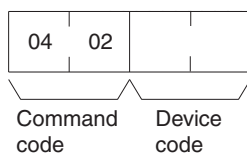

Response Format

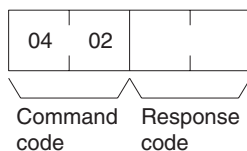

Parameters

Device code (command)

Defines the slave device to be enabled state as follows:

- High byte: Always set to 81(Hex).
- Low byte: 00 ~ 7D (Hex): Defines the slave device network address.

Response Codes

The following end codes can be returned by the Unit in response to the STOP command:

Response code	Description
0000	Normal completion.
0203	Slave device not allocated to the PROFIBUS Master.
0402	Service not supported by Unit model / version.
1001	Command too large.
1002	Command too short.
110C	<ul style="list-style-type: none"> • Mode code setting not supported (code exceeds 01). • Invalid device code (High byte not equal to 81) • Invalid target slave address (exceeds 125).

5-2-4 CONTROLLER DATA READ (0501)

Reads the model name and version number data from the PROFIBUS Master Unit.

Command Format

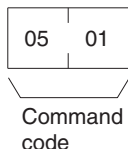

Response Format

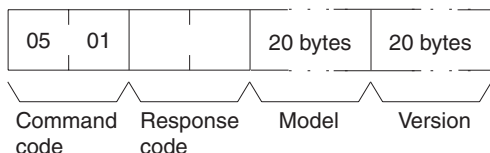

Parameters

Model, Version (Response)

The PROFIBUS Master Unit model and version are returned as ASCII characters occupying 20 bytes each (i.e., 20 characters each). If all bytes are not used, the remaining bytes will be all spaces (ASCII 20 Hex).

Example Model: CS1W-PRM21, CJ1W-PRM21
Version: V2.00

Response Codes

Response code	Description
0000	Normal completion.
1001	Command too large

5-2-5 ERROR LOG READ (2102)

Reads a specified number of error records from the error log.

Command Format

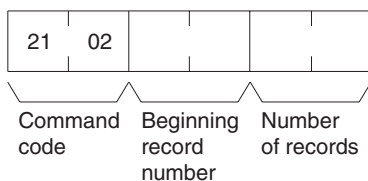

Response Format

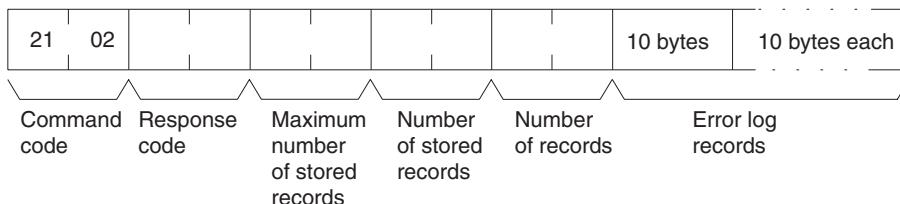

Parameters

First Record Number (Command)

The first record to be read. The first record number can be specified in the range between 0000 and 0050 (0 to 80 decimal) where 0000 is the oldest record in the Error Log, since the last performed ERROR LOG READ command.

Number of Records (Command, Response)

The number of records to read is specified between 0001 and 0050 (1 to 80 decimal) in the command. The response returns the actual number of records read.

Maximum Number of Stored Records (Response)

The maximum number of records that can be stored in the error log. In a PROFIBUS Master Unit, the maximum number of stored records is fixed at 50 (80 decimal).

Number of Stored Records (Response)

The number of records stored at the time the command is executed.

Error Log Data (Response)

The specified number of error log records from the starting record number is returned sequentially.

The total number of bytes in the error log is calculated as the number of records x 10 bytes/record. Each error log record thus consist of 10 bytes, configured as follows:

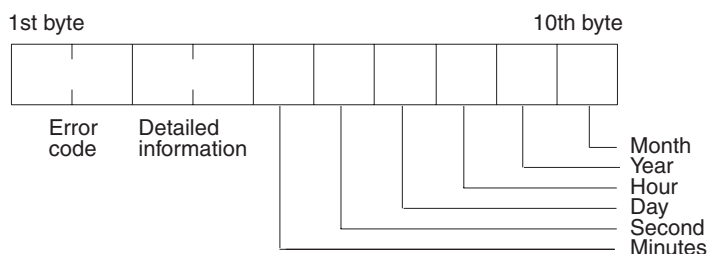

Error Code, Detailed Information

Details of the error stored in the record. Refer to SECTION 7 Troubleshooting and Maintenance for details.

Minute, Second, Day, Hour, Year, Month

Indicate the time at which the error stored in the record occurred.

Precautions

The total number of records to be returned is either the number specified in the command, or the number of available new records in the Error Log, whichever is smaller.

If more then one record is read, the records are returned in a oldest-to-newer sequence, i.e. the oldest record is the first in the response message.

Response Codes

Response code	Description
0000	Normal completion.
1001	Command too large.
1002	Command too small.
1103	Beginning record number is out of range.
110C	The number of read records is 0.

5-2-6 ERROR LOG CLEAR (0203)

Clears the number of records stored in the PROFIBUS Master Unit error log.

Command Format

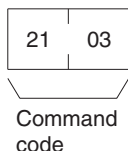

Response Format

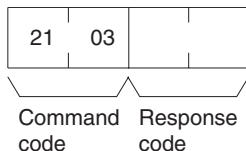

Response Codes

Response code	Description
0000	Normal completion.
250F	Memory writing error. Error Log was not cleared normally.
260B	Cannot Clear the Error Log. The error cause still exists.

5-2-7 EXPLICIT MESSAGE SEND (2801)

Sends an explicit message over the PROFIBUS network to an OMRON slave device and receives a response.

Explanation

The Explicit Message Send command sends a CIP-defined explicit message to an OMRON PROFIBUS Slave device supporting CIP messages.

Unlike other FINS commands, the Explicit Message Send command specifies the PROFIBUS Master Unit station address (i.e. the local node) as the CMND instruction control code destination. The actual destination address, i.e. address of the targeted slave device is specified using the Destination Station Address in the Explicit Message Send command.

Always specify the PROFIBUS Master Unit address in the CMND instruction control code. If another Unit's address is specified an error will occur.

- Note**
1. For information on explicit messages for OMRON slave, refer to *SmartSlice GRT1-Series GRT1-PRT PROFIBUS Communication Unit Operation Manual (W04E-EN-□)*.
 2. Since station address 0 is reserved in FINS commands, the Master unit and the targeted slave device must not have the station address set to 0.
 3. The Explicit Message Send command is wrapped in a PROFIBUS DP-V1 Class 2 message. The handling of this message, i.e. establishing a connection, transferring data and aborting a connection is done automatically by the PROFIBUS Master unit.

Command Format

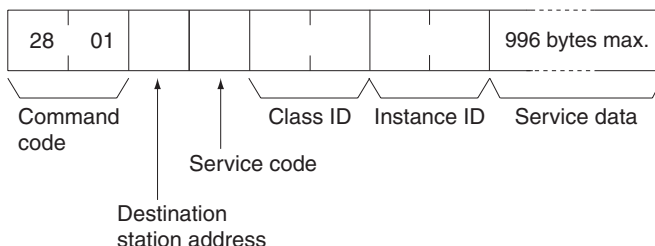

Response Format

If a normal response has been returned by the targeted device, the response format for the executed explicit message is as follows:

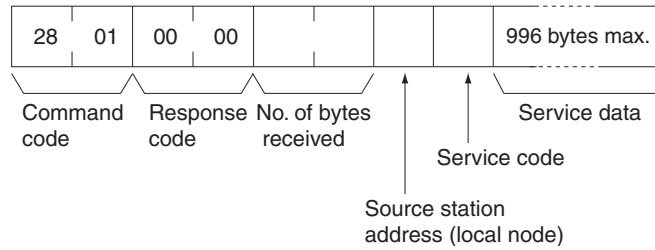

If transmission of the Explicit message was successful, but the execution was not, the FINS response message will still contain response code 0000 as well as return data. However, an error code, indicating the failure will be part of the data block. The response format for this case is shown below.

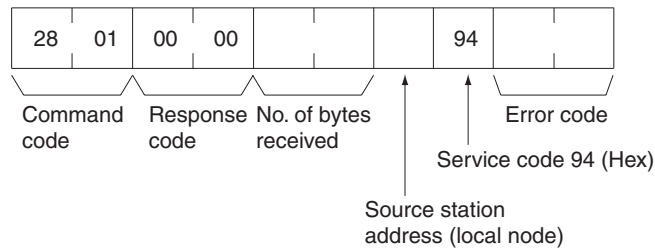

For the definition of the error codes for unsuccessful execution of CIP messages, refer to the *SmartSlice GRT1-Series GRT1-PRT PROFIBUS Communication Unit Operation Manual (W04E-EN-□)*.

If transmission of the FINS message was unsuccessful, the response frame will only contain a response code and no data block.

Response Codes

The table below lists the response codes for the FINS message transmission itself.

Response code	Description
0000	Normal completion.
1001	Command too large, i.e. > 1004 bytes.
1002	Command too short, i.e. < 8 bytes.
110C	Device Address Invalid, i.e. > 7E (Hex)
2208	PROFIBUS Master unit not in correct mode, i.e. it is in OFFLINE mode.
220F	<ul style="list-style-type: none"> The connection was rejected, i.e. the Master Unit could not establish connection to send the requested FINS message. A timeout has occurred, i.e. the Master Unit did not transmit the message in time, or the slave device did not respond in time. An open connection will be aborted. The slave device does not support this FINS message.

Parameters

Send Destination Station Address (Command)

Specifies the station address of device to send the explicit message to over the PROFIBUS network.

Service Code (Command, response)

The service code defines the action to be implemented with the data sent to the slave device, e.g. Read, Write, Save. The service codes are listed in the Operation manual of the targeted slave device.

For normal responses, the service code is returned within the response data block, with bit 15 of the service code set to ON. For error responses, 94 hex, which indicates an error, is returned.

Class ID (Command)

Specifies the class ID for the explicit message destination. The supported Class ID values are specified in the Operation manual of the targeted slave device.

Instance ID (Command)

Specifies the instance ID for the explicit message destination. The supported Instance ID values are specified in the Operation manual of the targeted slave device.

Service Data (Command, response)

For commands, specifies the data defined by the service code.
For responses, returns the reception data defined by the service code.

No. of Bytes Received (Response)

Returns the number of data bytes received in the rest of the message.

Source Station Address (local node) (Response)

Returns the Station Address of the responder.

Error Code (Response)

Returns the error code defined by the slave device.

5-2-8 PROFIBUS MESSAGE SEND (2809)

The PROFIBUS MESSAGE SEND FINS command provides a means to initiate transmission and reception of standard PROFIBUS DP and DP-V1 Class 1 services over the PROFIBUS network via the CS1/CJ1W-PRM21 PROFIBUS Master Unit. The general command/response structures are shown below.

Command Format

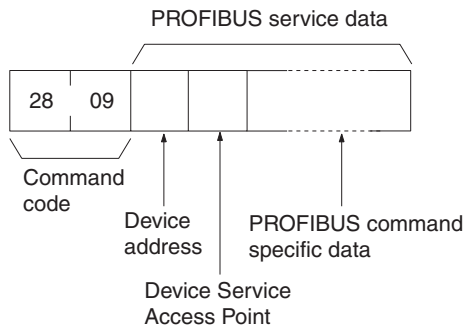

Response Format

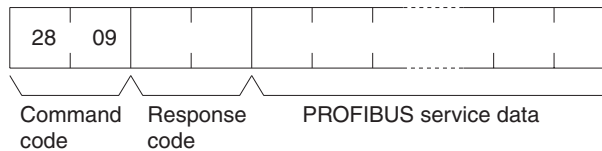

Parameters

The PROFIBUS service data part in both the command and response depends on the PROFIBUS service to be transmitted / received, and will therefore be different in length and contents for every service. Also, the response error codes will depend on the services requested. The common parameters are described below. Each supported service will be described separately after the common parameters.

Destination Address (Command)

The address of the device on the PROFIBUS network, to which the PROFIBUS message will be sent. The valid address range is 0 to 7E (Hex).

Device Service Access Point (Command)

The Device Service Access Point is a 1 byte number, identifying the PROFIBUS service to the slave device, as defined by the PROFIBUS standard.

The table below lists the PROFIBUS services supported using the PROFIBUS MESSAGE SEND FINS command.

PROFIBUS Service	DSAP (Hex)	Description	Page
Set_Slave_Add	37	Change the address of a slave device.	137
Rd_Inp	38	Read the Input data of a slave device.	139
Rd_Outp	39	Read the Output data of a slave device.	140
Get_Cfg	3B	Read the PROFIBUS DP I/O Configuration of a slave device.	141
MSAC1_Read	33	PROFIBUS DP-V1 (Class 1) Acyclic Data Read from a slave device.	142
MSAC1_Write	33	PROFIBUS DP-V1 (Class 1) Acyclic Data Write to a slave device.	144

Set Slave Add Service

The PROFIBUS DP Set_Slave_Add service allows a PROFIBUS Master Unit to change the address of a remote slave device. It is defined for slave devices of which the PROFIBUS address can not be set through switches. Slave devices which support this service also provide a means to store the address in internal non-volatile memory. In case this non-volatile memory does not contain an entry, the slave device will assume the default address 126.

The figures below show the command and response message formats.

Command Format

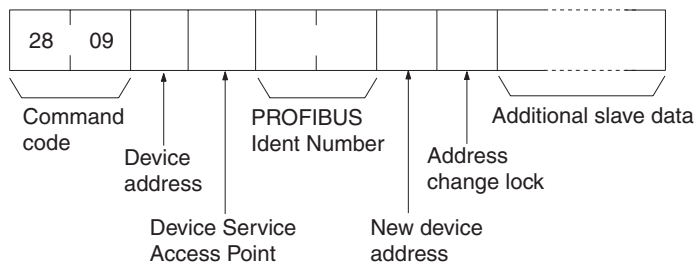

Response Format

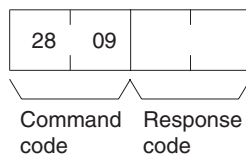

Parameters

Destination Address (Command)

The address of the device on the PROFIBUS network, to which the PROFIBUS message will be sent. The valid address range is 0 to 7E (Hex).

Device Service Access Point (Command)

The Device Service Access Point for the Set_Slave_Add PROFIBUS service must be set to 37 (Hex).

PROFIBUS Ident Number (Command)

The PROFIBUS Ident Number is a 1 word identifier, issued by PROFIBUS International, which identifies the slave device type and model. The number can be obtained from the slave device GSD file or from the slave documentation.

New Device Address (Command)

Contains the new address of the device. The valid address range is 0 to 7E (Hex).

Address Change Lock (Command)

Enables address lock, after changing it. Valid range:

- 00 Disable Address Lock
- 01: Enable Address Lock

 **WARNING** Enabling Address Lock makes any future changes of the address impossible, even after power-down/power-up of the slave device.

Response Codes

Response code	Description
0000	Normal completion
1001	Command too large, i.e. > 124 words
1002	Command too short, i.e. < 4 words.
110C	<ul style="list-style-type: none"> • Device Address Invalid, i.e. > 7E (Hex) • New Device Address Invalid, i.e. > 7E (Hex) • Address change lock invalid, i.e. not equal to 00 or 01. • Invalid target slave address (exceeds 125).
2208	PROFIBUS Master unit not in correct mode, i.e. it is in OFFLINE mode.
0001	<ul style="list-style-type: none"> • The slave has deactivated this service. • The slave has not responded to the request. • The slave does not have sufficient memory space for the request data. • New Address is same as current master address.
0402	Service is not supported: Device Service Access Point is invalid.

Rd Inp Service

The PROFIBUS DP Rd_Inp service allows a PROFIBUS Master Unit to read the current input data of any slave device, even if it is not allocated to the Master Unit.

The figures below show the command and response message formats.

Command Format

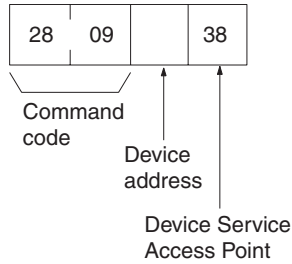

Response Format

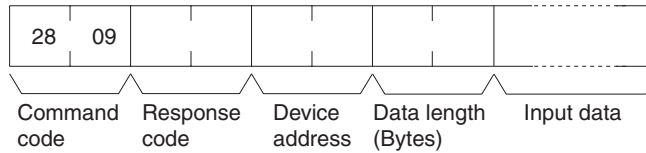

Parameters

Destination Address (Command, Response)

The address of the device on the PROFIBUS network, to which the PROFIBUS message will be sent. The valid address range is 0 to 7E (Hex). The most significant byte in the Response Format is set to 00.

Device Service Access Point (Command)

The Device Service Access Point for the Rd_Inp PROFIBUS service must be set to 38 (Hex).

Data length (Bytes) (Response)

This parameter defines the number of Input data bytes returned by the slave device. The number ranges from 0 to 244 bytes. The most significant byte is set to 00.

Input data (Response)

Input data returned by the slave device.

Response Codes

Response code	Description
0000	Normal completion
1001	Command too large, i.e. > 2 words
1002	Command too short, i.e. < 2 words.
110C	Device Address Invalid, i.e. > 7E (Hex)
2208	PROFIBUS Master unit not in correct mode, i.e. it is in OFFLINE mode.
0001	<ul style="list-style-type: none"> The slave has deactivated this service. The slave has not responded to the request. The slave does not have sufficient memory space for the request data. Destination address is same as current master address.
0402	Service is not supported: Device Service Access Point is invalid.

Rd Outp Service

The PROFIBUS DP Rd_Outp service allows a PROFIBUS Master Unit to read the current output data of any slave device, even if it is not allocated to the Master Unit.

The figures below show the command and response message formats.

Command Format

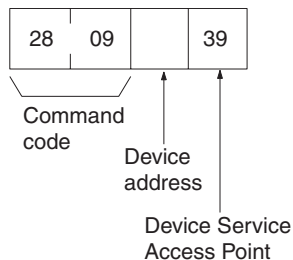

Response Format

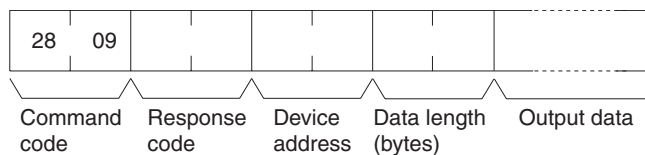

Parameters

Destination Address (Command, Response)

The address of the device on the PROFIBUS network, to which the PROFIBUS message will be sent. The valid address range is 0 to 7E (Hex). The most significant byte in the Response Format is set to 00.

Device Service Access Point (Command)

The Device Service Access Point for the Rd_Outp PROFIBUS service must be set to 39 (Hex).

Data length (Bytes) (Response)

This parameter defines the number of Output data bytes returned by the slave device. The number ranges from 0 to 244 bytes. The most significant byte is set to 00.

Output Data (Response)

Output data returned by the slave device.

Response Codes

Response code	Description
0000	Normal completion
1001	Command too large, i.e. > 2 words
1002	Command too short, i.e. < 2 words.
110C	Device Address Invalid, i.e. > 7E (Hex)
2208	PROFIBUS Master unit not in correct mode, i.e. it is in OFFLINE mode.
0001	<ul style="list-style-type: none"> The slave has deactivated this service. The slave has not responded to the request. The slave does not have sufficient memory space for the request data. Destination address is same as current master address.
0402	Service is not supported: Device Service Access Point is invalid.

Get Cfg Service

The PROFIBUS DP Get_Cfg service allows a PROFIBUS Master Unit to read the I/O Configuration data of any slave device, even if it is not allocated to the Master Unit.

The figures below show the command and response message formats.

Command Format

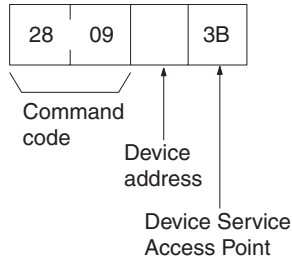

Response Format

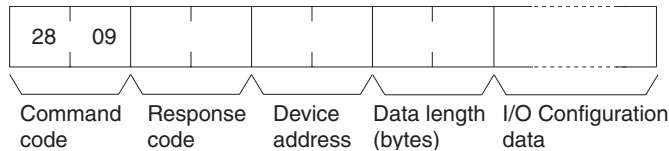

Parameters

Destination Address (Command, Response)

The address of the device on the PROFIBUS network, to which the PROFIBUS message will be sent. The valid address range is 0 to 7E (Hex). The most significant byte in the Response Format is set to 00.

Device Service Access Point (Command)

The Device Service Access Point for the Get_Cfg PROFIBUS service must be set to 3B (Hex).

Data length (Bytes) (Response)

This parameter defines the number of I/O Configuration bytes returned by the slave device. The number ranges from 0 to 244 bytes. The most significant byte is set to 00.

I/O Configuration data (Response)

I/O Configuration data returned by the slave device. The I/O Configuration bytes are coded according to the PROFIBUS standard.

Response Codes

Response code	Description
0000	Normal completion
1001	Command too large, i.e. > 2 words
1002	Command too short, i.e. < 2 words.
110C	Device Address Invalid, i.e. > 7E (Hex)
2208	PROFIBUS Master unit not in correct mode, i.e. it is in OFFLINE mode.
0001	<ul style="list-style-type: none"> The slave has deactivated this service. The slave has not responded to the request. The slave does not have sufficient memory space for the request data. Destination address is same as current master address.
0402	Service is not supported: Device Service Access Point is invalid.

MSAC1 Read Service

The PROFIBUS DP-V1 MSAC1_Read service allows a PROFIBUS DP-V1 Master Unit to read (parameter) data acyclically from a PROFIBUS DP-V1 slave device, which is allocated to that Master unit.

The figures below show the command and response message formats.

Command Format

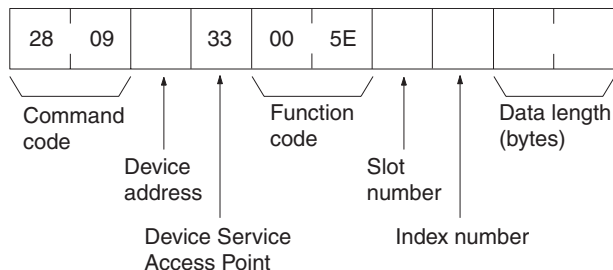

Response Format

Upon normal completion of the MSAC1_Read command service two types of response frames can be returned:

- A normal data response frame containing the requested data.
- A normal response frame containing PROFIBUS error codes, indicating that the PROFIBUS service was not completed correctly, although the FINS message was completed normally.

Both response frames are shown below.

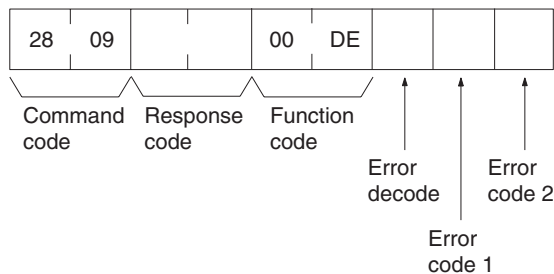
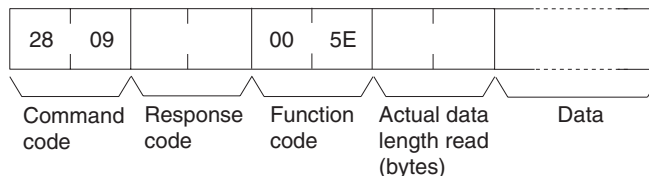

Parameters

Destination address (Command, Response)

The address of the device on the PROFIBUS network, to which the PROFIBUS message will be sent. The valid address range is 0 to 7E (Hex). The most significant byte in the Response Format is set to 00.

Device Service Access Point (Command)

The Device Service Access Point for the MSAC1_Read PROFIBUS service must be set to 33 (Hex).

Function code (Command, Response)

The function code is defined by the PROFIBUS standard and defines the type of MSAC1 message. In the command it must be fixed to 005E (Hex). The response will contain either 005E (Hex) indicating a normal PROFIBUS completion, or 00DE (Hex), indicating PROFIBUS errors.

Slot number (Command)

The parameter Slot_Number is used in the destination device for addressing the desired data slot (typically an I/O module). The number ranges from 0 to 254.

Index number (Command)

The parameter Index is used in the destination device for addressing the desired data block within a specified slot. The number ranges from 0 to 254.

Data length (Bytes) (Command)

The Data length indicates the number of bytes, which have to be read. If the actual data block length is less than requested, the length in the response will be the actual length of the data block. If the actual data block length is greater or equal than requested, the response will contain the requested length of data. The number ranges from 0 to 240.

Data (Response)

Requested data block as retrieved from the PROFIBUS DP-V1 slave device.

Error decode (Response)

The Error decode byte defines the type of errors reported in the Error code 1 and Error code 2, e.g. a PROFIBUS DP-V1 error. This response will only be returned if the FINS message was delivered successfully, but the PROFIBUS service returned an error. Refer to Appendix B-5 PROFIBUS DP-V1 Error codes for more information.

Error code 1, Error code 2 (Response)

The contents of the Error code bytes depends on the contents of the Error decode byte and the slave device. Refer to Appendix B-5 PROFIBUS DP-V1 Error codes for more information.

Response Codes

Response code	Description
0000	Normal completion
1001	Command too large, i.e. > 5 words
1002	Command too short, i.e. < 5 words.
110C	<ul style="list-style-type: none"> • Device Address Invalid, i.e. > 7E (Hex). • The slot number is invalid, i.e. > FE (Hex). • The Index number is invalid, i.e. > FE (Hex). • The Data Length is invalid, i.e. > F0 (Hex)
2208	PROFIBUS Master unit not in correct mode, i.e. it is in OFFLINE mode.
0001	<ul style="list-style-type: none"> • The slave has deactivated this service. • The slave has not responded to the request. • The slave does not have sufficient memory space for the request data. • Destination address is same as current master address.
0402	Service is not supported: <ul style="list-style-type: none"> • Device Service Access Point is invalid. • The Function code is invalid

MSAC1 Write Service

The PROFIBUS DP-V1 MSAC1_Write service allows a PROFIBUS DP-V1 Master Unit to write (parameter) data acyclically to a PROFIBUS DP-V1 slave device, which is allocated to that Master unit.

The figures below show the command and response message formats.

Command Format

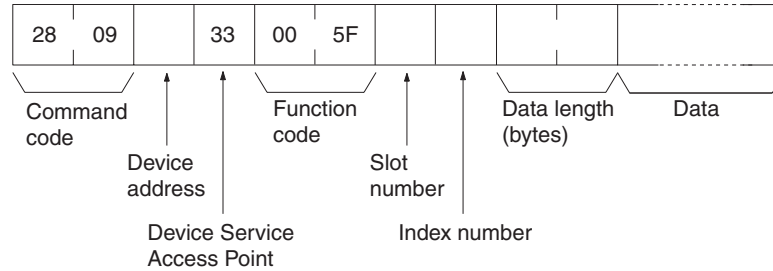

Response Format

Upon normal completion of the MSAC1_Write command service two types of response frames can be returned:

- A normal data response frame, signalling successful completion of both the FINS command and the PROFIBUS service.
- A normal response frame containing PROFIBUS error codes, indicating that the PROFIBUS service was not completed correctly, although the FINS message was completed normally.

Both response frames are shown below.

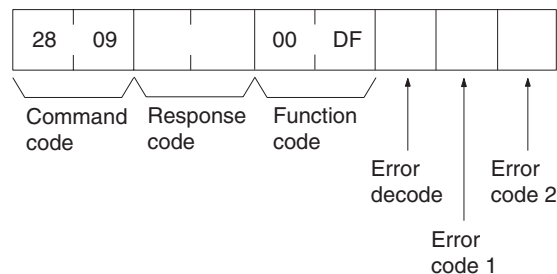
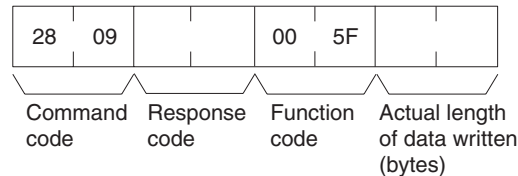

Parameters

Destination address (Command, Response)

The address of the device on the PROFIBUS network, to which the PROFIBUS message will be sent. The valid address range is 0 to 7E (Hex). The most significant byte in the Response Format is set to 00.

Device Service Access Point (Command)

The Device Service Access Point for MSAC1 PROFIBUS services must be set to 33 (Hex).

Function code (Command, Response)

The Function code is defined by the PROFIBUS standard and specifies the type of MSAC1 message. For the MSAC1_Read service it must be fixed to 005F (Hex). The Response Format will contain either 005F (Hex) indicating a normal PROFIBUS completion, or 00DF (Hex), indicating PROFIBUS errors.

Slot number (Command)

The parameter Slot number is used in the destination device for addressing the desired data slot (typically an I/O module). The number ranges from 0 to 254.

Index number (Command)

The parameter Index is used in the destination device for addressing the data block within a specified slot to which the data must be written. The number ranges from 0 to 254.

Data length (Bytes) (Command, Response)

The Data length indicates the number of bytes, which must be written. If the actual data block length is less than the length of the data written, the response will contain an error code in the Error code 1 byte. If the actual data block length is greater or equal than the length of the data block written, the response will contain the actual number of bytes written. The data length number ranges from 0 to 240.

Data (Command)

Data to be written to the PROFIBUS DP-V1 slave device.

Error decode (Response)

The Error decode byte defines the type of errors reported in the Error code 1 and Error code 2, e.g. PROFIBUS DP-V1 error. This response will only be returned if the FINS message was delivered successfully, but the PROFIBUS service returned an error. Refer to Appendix B-5 PROFIBUS DP-V1 Error codes for more information.

Error code 1, Error code 2 (Response)

The contents of the Error code bytes depends on the contents of the Error decode byte and the slave device. Refer to Appendix B-5 PROFIBUS DP-V1 Error codes for more information.

Response Codes

Response code	Description
0000	Normal completion
1001	Command too large, i.e. > 125 words
1002	Command too short, i.e. < 5 words.
110C	<ul style="list-style-type: none"> • Device Address Invalid, i.e. > 7E (Hex). • The slot number is invalid, i.e. > FE (Hex). • The Index number is invalid, i.e. > FE (Hex). • The Data Length is invalid, i.e. > F0 (Hex)
2208	PROFIBUS Master unit not in correct mode, i.e. it is in OFFLINE mode.
0001	<ul style="list-style-type: none"> • The slave has deactivated this service. • The slave has not responded to the request. • The slave does not have sufficient memory space for the request data. • Destination address is same as current master address.
0402	Service is not supported: <ul style="list-style-type: none"> • Device Service Access Point is invalid. • The Function code is invalid

SECTION 6

Operation

This section describes how to operate the CS1/CJ1W-PRM21 PROFIBUS Master Unit in a Network. It will discuss setting up a network, configuring all the connected devices and starting the network. Furthermore, it provides information the I/O data exchange performance and it also provides information on how to monitor a network, using the Unit and CX-Profibus.

6-1	Introduction	148
6-2	Setting up a network	148
6-2-1	Adding Devices to the Network	150
6-2-2	Changing Device and DTM Addresses	152
6-3	Configuring the Slave Devices	155
6-3-1	Defining the I/O configuration	155
6-3-2	Setting Parameters	158
6-3-3	Selecting the Group Assignment	159
6-4	Configuring the Master	161
6-4-1	Setting the Master Parameters	161
6-4-2	Setting the Bus Parameters	163
6-4-3	Defining and Changing I/O Mapping	164
6-4-4	Configuring CX-Server	165
6-4-5	Downloading the Configuration	167
6-5	I/O Communication Characteristics	168
6-5-1	I/O Data Configuration	168
6-5-2	Mapping I/O Data	168
6-5-3	Supported Data Types	175
6-5-4	Exchanging I/O Data over PROFIBUS	176
6-5-5	PLC Cycle Time Performance	178
6-5-6	I/O Response Time	178
6-5-7	System Startup Time	181
6-6	Operating the Network	182
6-6-1	User Access to the Network	182
6-6-2	Changing PROFIBUS Mode of the Master Unit	183
6-6-3	Transmitting Global-Control Commands	185
6-6-4	Using Auto-CLEAR	189
6-7	Monitoring the Network	190
6-7-1	Monitoring the Master Unit and the Network	190
6-7-2	Monitoring Slave Status	194
6-7-3	Using the Error Log	195
6-8	PROFIBUS DP-V1 Services	197

6-1 Introduction

This section discusses the operational aspects of using the PROFIBUS Master Unit and the configuration software. The section has been setup, to follow the general process flow of setting up and configuring a network, downloading the configuration, and operating the PROFIBUS network.

- Note**
1. In case Error messages are displayed, while using CX-Profibus, refer to *Appendix D Configurator Error and Warning Messages* for more information on errors.
 2. This section does not discuss how to operate the C200HW-PRM21 PROFIBUS DP Master Unit. For more information on how to operate this type of unit, refer to the C200H-series PROFIBUS Master Units Operation Manual (W349-E2-□).

Example

To illustrate the explanations, examples are marked with the word Example in the side line.

6-2 Setting up a network

Starting CX-Profibus

Setting up a network involves setting up a configuration in CX-Profibus and downloading it to the PROFIBUS Master Unit. To start CX-Profibus, select **Program, OMRON, and CX-Profibus**, from the Start Menu if the default program folder name is used.

The Login Window will be displayed. Login as either **Administrator** or **Planning Engineer**.

- Note** The default password for all levels is "**password**".

CX-Profibus will now start, displaying the main window, as shown below.

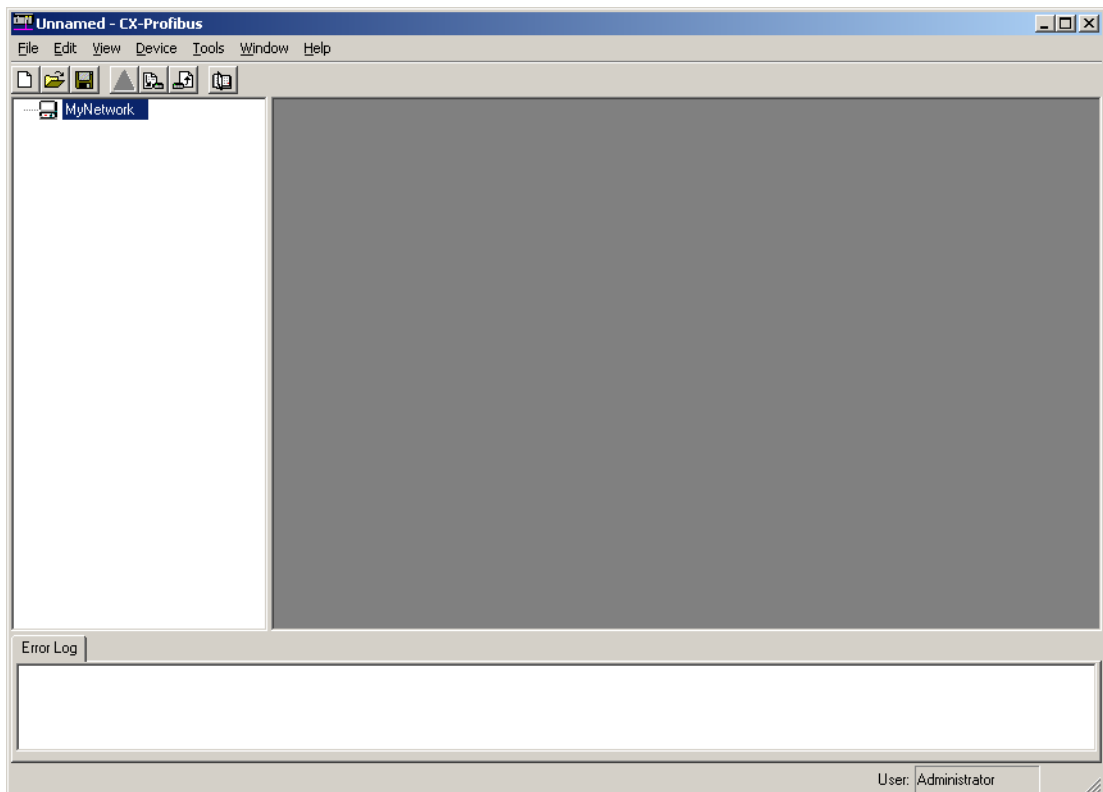

Before starting the assembly of the network in CX-Profibus, make the following preparation steps.

- 1,2,3... 1. Open the Device Catalogue: Either select the **View - Device Catalogue** menu option, or press the  button in the Tool Bar. The opened Device Catalogue is shown below.

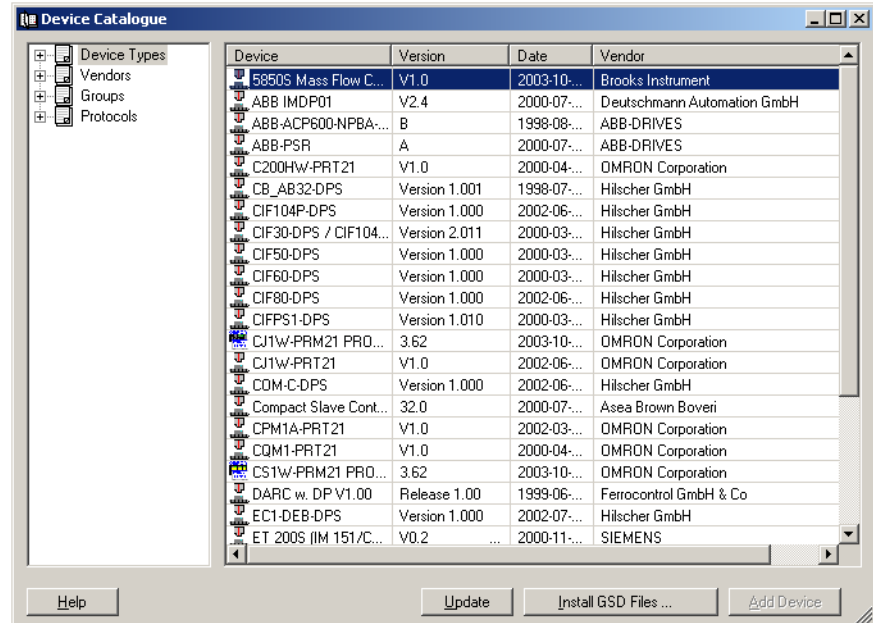

2. Check the list of available DTMs, and verify that all the devices that need to be added to the Network - both master and slave devices - are among the DTMs in the list.
3. If one or more of the DTMs is missing, these DTMs must first be installed and the Device Catalogue updated.

- Note**
1. Non-GSD file based DTMs are usually provided with their own setup program. Installation of these DTMs must be performed outside CX-Profibus, e.g. from **Windows Explorer**.
 2. In case of DTM installations outside CX-Profibus, always initiate an update of the Device Catalogue, before assembling a network. Without this update the newly installed DTM will not appear in the list of devices. To Update the Device Catalogue, press the **Update** button in the Device Catalogue main window.
 3. An Update must also be performed when an already existing DTM is upgraded. Without the update, the old version number will still be shown in the list. Failure to update the Device Catalogue in this case may also result in undesired behaviour, when adding these DTMs to the Network.

Installing New GSD Files

GSD file based DTMs can be installed from within the Device Catalogue main window. To do so, follow the procedure below.

- 1,2,3... 1. Press the **Install GSD File...** button at the bottom of the Device Catalogue main window (refer to figure above). The standard windows **File - Open** window will be displayed.
2. In the **File - Open** window browse to the sub-directory containing the GSD file, select the (one or more) GSD file(s) and press the **Open** button in the

window. The GSD file(s) will be copied to a sub-directory of the CX-Profibus directory.

3. After completing the copy, a window will be displayed, asking the user permission for an update of the Device Catalogue (see figure below). If more GSD files need to be installed, select the **No** button and continue with installation of GSD file. Otherwise, select the **Yes** button.

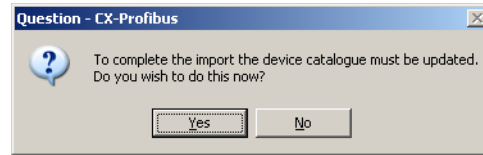

Note Updating the Device Catalogue may take several minutes, depending on the number of installed GSD files.

6-2-1 Adding Devices to the Network

If the Device Catalogue is up to date, it can be used to setup the network. Setting up a network in CX-Profibus starts with adding single device DTMs to the Network view. First the CS1/CJ1W-PRM21 Master DTM must be added to the main branch of the project Network. To do so, one of three procedures as outlined below must be used to add the DTM.

Using the Context Menu

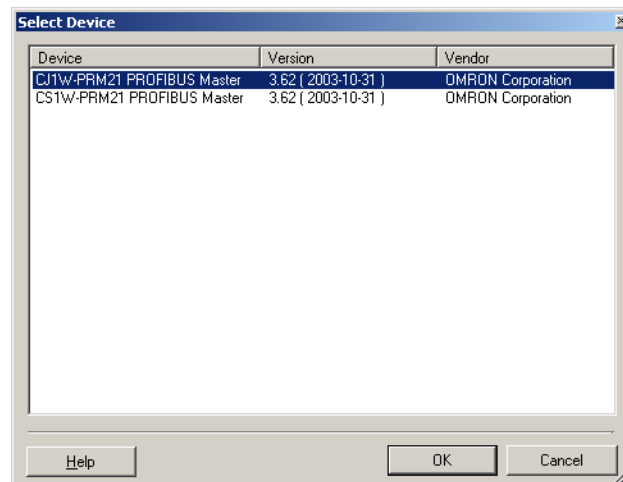

- 1,2,3... 1. Select the top of the network to which the DTM must be added, i.e. select **MyNetwork** in the Network view.
2. Right click the mouse and a context menu will be displayed.
3. From the menu select **Add Device**.
4. A simplified Device Catalogue is displayed. The list only contains the devices which can be inserted at the selected network location (see figure below, only Master devices are listed).
5. From the displayed list, select the device DTM to be added and select the **OK** button. The Device DTM will be added to the network.



Using Drag & Drop

- 1,2,3...
1. Open the Device Catalogue: Either select the **View - Device Catalogue** menu option, or press the  button in the Tool Bar.
 2. Select a device DTM in the Device Catalogue.
 3. Left click the mouse and Drag the mouse pointer to the desired location in the network, i.e. **MyNetwork** in the Network view.
 4. Release the mouse button and the device DTM will be added to that location.

Note Master DTMs can only be added to the main branch of the Network. Slave Device DTMs can only be added to Master DTMs. Whether or not a DTM can be added to the branch is indicated by the cursor:

 indicates no addition,  indicates that addition is allowed.

Using the Add Device Button

- 1,2,3...
1. Select the top of the network to which the DTM must be added, i.e. select **MyNetwork** in the Network view.
 2. Open the device Catalogue: Either select the **View - Device Catalogue** menu option, or press the  button in the Tool Bar.
 3. Select the device that must be added to the network.
 4. Select the **Add Device** button at the bottom of the Device Catalogue window. The device DTM is added to the network.

Note If a DTM is selected in the Device Catalogue, which can not be added to the current location in the network, the **Add Device** button will be disabled, which is shown as a grayed out button.

Note When adding a CS1/CJ1W-PRM21 Master DTM to the network, it is automatically assigned the PROFIBUS network address 1. This address can be changed, after opening the CS1/CJ1W-PRM21 Master DTM.

After adding the Master DTM to the Network view, repeat (one of) the procedures as outlined above to add slave DTMs to the Master DTM. In the procedures above, the highest level for adding slave DTMs is the Master DTM.

Note When adding slave DTMs to the CS1/CJ1W-PRM21 Master DTM, they are automatically assigned their PROFIBUS network addresses, in ascending order, i.e. the first slave is assigned address 2, the second address 3, etc. The addresses can be changed in the slave DTM User Interface.

Example

The figure below shows an example network consisting of a CJ1W-PRM21 PROFIBUS Master and three OMRON slave devices.

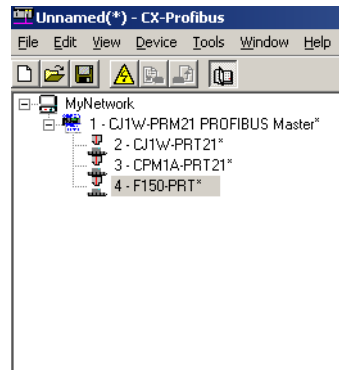

Note that the slave DTMs all have the automatically assigned network addresses, displayed to the left of the device name.

6-2-2 Changing Device and DTM Addresses

In order to achieve communication between the Master Unit and its allocated slave devices, the latter must have the same physical network address as set in the configuration. The network address on the slave devices are usually set

- through dip-switches or rotary switches on the device, or
- remotely, using the dedicated Set_Slave_Add PROFIBUS service and stored in the device.

The physical address setting may differ from the slave DTM address, which was automatically assigned by the Master DTM.

Changing the Slave Device Address

Slave devices which are not equipped with switches to set the address, must support the Set_Slave_Add PROFIBUS service. Typical device types supporting this address setting method are PROFIBUS PA devices or IP65 devices.

The default address for these devices is 126. This allows them to communicate with a Master unit, with the purpose of changing the address. I/O data exchange with slave address 126 is not allowed. Usually, these slave devices also provide a means to store the remotely set address in local non-volatile memory.

As of Unit version 2.0, the CS1/CJ1W-PRM21 PROFIBUS Master units support the Set_Slave_Add PROFIBUS service, which can be initiated from the Master DTM. This service can be sent to any slave on the network, even if it is not allocated to the Master DTM.

In order to change a slave device's address remotely, first make sure that the Master DTM is on-line with the Master. Next, open the Set Device Station Address window:

- 1,2,3... 1. Select the DTM in the Network view.
2. Right click the mouse, and select the **Additional functions** entry from the context menu.
3. Select the **Set Device Station Address** option

The window as shown below is displayed.

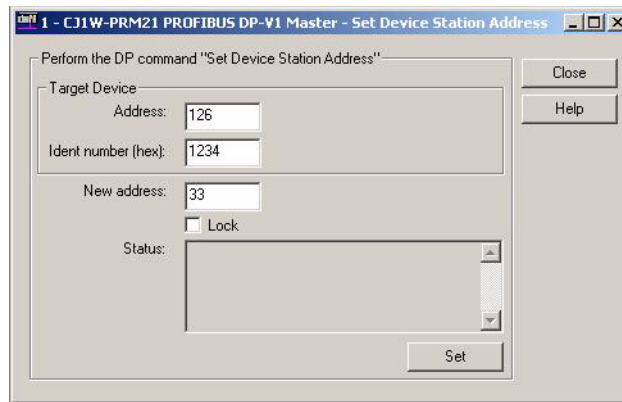

In order to change the address of a slave device perform the following steps:

- 1,2,3...**
1. Enter the device's current address and its PROFIBUS Ident Number. The PROFIBUS Ident Number can be found in the Generic Slave DTM or through the device's documentation. By default the device's current address will be 126. If necessary, change this to the actual current address.
 2. Enter the new device address in the **New Address** field.
 3. Optionally, select the **Lock** checkbox, if the address change must be made permanent.
 4. Press the Set button to invoke the PROFIBUS DP Set Slave Address service. The Status field will display the status of this service.

WARNING Selecting the Lock option makes any future changes of the address impossible, even after power-down/power-up of the slave device.

Note After successful completion of the address change, the device DTM address in the Network view has to be changed as well.

Changing the Slave DTM Address

When assembling the PROFIBUS configuration in the Network view, the Master DTM automatically assigns addresses in ascending order to the slave DTMs. If the physical address on the slave device differs from the DTM address, the DTM address must be changed to match that setting.

Changing the DTM address can be done in two ways.

- Change the DTM address through the Generic Slave DTM
- Change the DTM address through the Slave DTM Address Assignment table via the Master DTM.

Changing the DTM address via the Generic Slave DTM

The first option, using the Generic Slave DTM is illustrated in the example below.

Example

Assume that the F150-PRT Vision system in the previous example, has an actual network address of 10, instead of 4, which was automatically assigned. In order to change the network address of the F150-PRT (or any other slave device), perform the procedure outlined below.

- 1,2,3...**
1. Open the Configuration User Interface for the slave device, by selecting it in the Network view, and double-clicking the left mouse button.
 2. Select the Station Address field at the top of the Configuration tab (see figure below) and change the value to 10.

3. Select the **OK** or **Apply** button at the bottom of the window. The **OK** button will close the DTM Configuration User Interface.

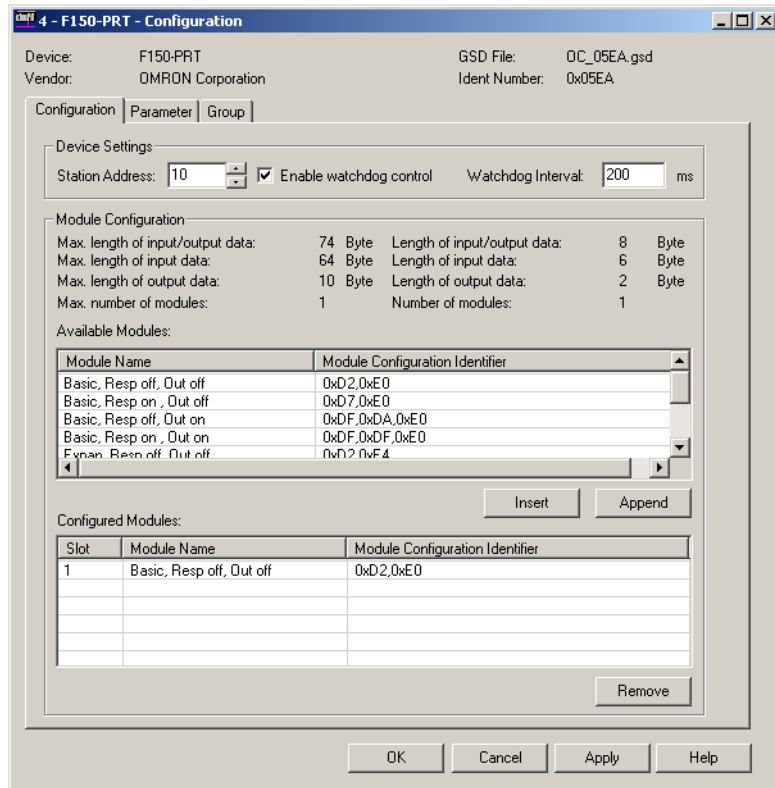

Note If, when pressing the **Apply** or **OK** button, no I/O modules have been selected as yet, a warning message will be displayed. The I/O modules can be selected later. Pressing the **OK** button with the warning, will apply the changed device address.

After changing the address in the slave DTM Configuration User Interface, the updated address will be shown in the Network view, next to the device name.

The slave DTM address can also be changed via the Master DTM. To accomplish this, first open the Slave DTM Address Assignment table.

Changing the DTM address via the Master DTM

- 1,2,3...**
1. Select the Master DTM in the Network view.
 2. Right click the mouse, and select the **Additional functions** entry from the context menu.
 3. Select the **Slave DTM Address Assignment** function.

The window as shown below will be displayed.

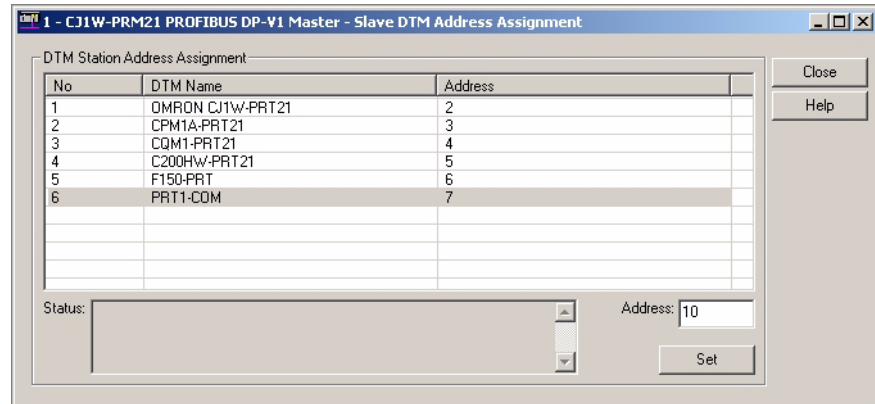

In order to change the slave DTM address perform the following steps.

- 1,2,3...**
1. Select the slave device in the list.
 2. Enter the new address in the field Address in the lower right corner of the window.

Press the **Set** button. The Status field will display the status of this service

After changing the slave DTM address, the new address will also be shown in the Network view.

6-3 Configuring the Slave Devices

After adding each of the slave DTMs to the network, configurations have to be selected for each of them. Setting up a configuration involves

- Selecting the proper I/O modules, which define the I/O data to be exchanged when operational.
- Setting up the device parameters, which will be send to the device to make or verify its settings.
- Selecting the group assignment, which defines the group of slave devices each slave belongs to and to allow sending Global-Control commands to this particular group.

All these settings will be downloaded to the Master Unit, which will send the data to the individual slave devices over the PROFIBUS network.

6-3-1 Defining the I/O configuration

Opening the DTM Configuration User Interface

In order to define the I/O configuration, the DTM Configuration User Interface must be opened. To do this, either

- select the device in the Network view and double-click the left mouse button.
- select the device in the Network view, right click the mouse and select **Configuration** from the context menu.

Example

The figure below, shows the DTM User Interface for the CJ1W-PRT21 PROFIBUS DP slave device.

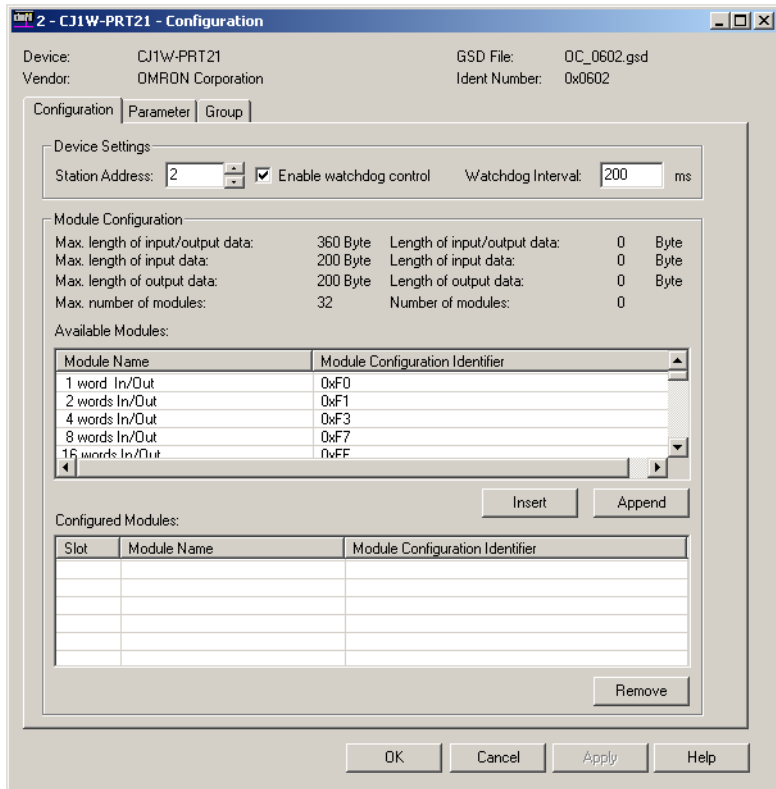

The DTM Configuration User Interface displays two lists.

- The Available Modules list, which contains the I/O modules the user can select.
- The Configured Modules list, which contains all the I/O modules selected by the user.

Adding/Inserting I/O Modules

To select the I/O modules, perform one of the following procedures.

- Select the I/O module that needs to be added in the Available Modules list, and double-click it with the left mouse button. If more than one module must be added, repeat this step for the other modules.
- Select the I/O module that needs to be added in the Available Modules list, and press either the **Insert** or **Append** button. This method allows selection of more than one module, by pressing either the **Shift** or the **Ctrl** key on the keyboard, while selecting the modules.

- Note**
1. When pressing the **Insert** button, the selected I/O module will be inserted above the selected module in the Configured Modules list.
 2. The selected I/O modules are sent to the slave device, in the same sequence as selected in the user interface. Depending on the device, the sequence may be checked by the slave device. If an incorrect sequence is sent, the I/O configuration is rejected. This is for example the case with the OMRON PRT1-COM Multiple I/O PROFIBUS DP Interface.
 3. A mandatory I/O module sequence is sometimes indicated in the GSD file, by using non-PROFIBUS standard GSD file keywords (i.e. only interpreted by a specific configurator). The Generic Slave DTM does not check such keywords. In this case, refer to the manual of the specific device for details.

4. Also in this window are the maximum values, which can be set, and the totals of I/O data that actually have been set. If - while selecting I/O modules - one of the maximum values is exceeded, a warning message will be displayed.

Example

For the CJ1W-PRT21, the first four I/O modules have been selected, see figure below.

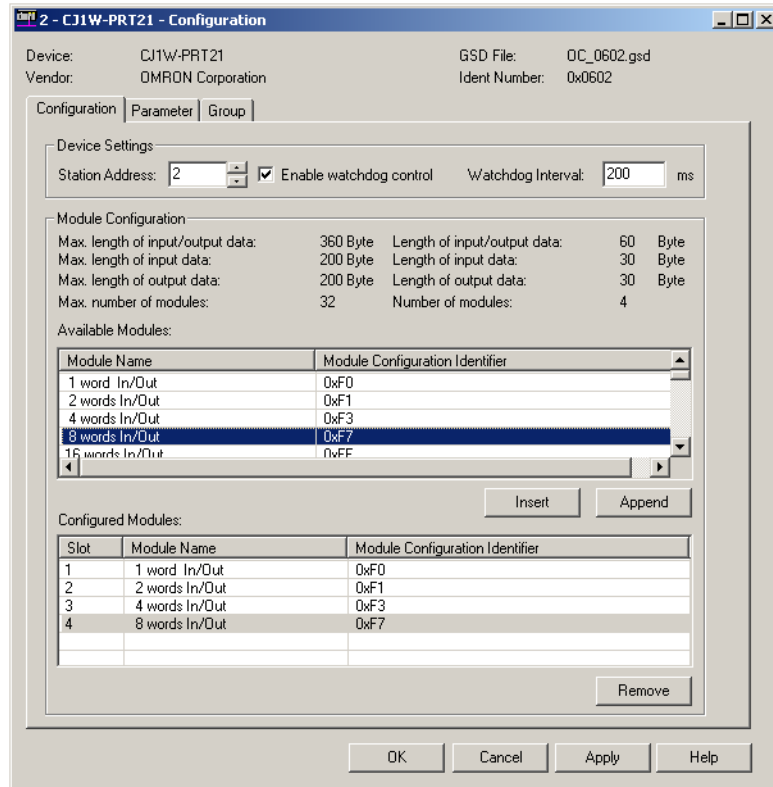

Removing I/O Modules

To remove I/O modules from the Configured Modules list, perform one of the following procedures.

- Select the I/O module that needs to be removed from the Configured Modules list, and double-click it with the left mouse button. If more than one module must be added, repeat this step for the other modules.
- Select the I/O module that needs to be removed from the Configured Modules list, and press either the **Remove** button. This method allows selection of more than one module, by pressing either the **Shift** or the **Ctrl** key on the keyboard, while selecting the modules.

Watchdog Settings

Apart from the I/O module selection, the Configuration tab also contains the settings for two other parameters.

1. Enable Watchdog Control

This parameter will enable/disable the monitoring of the Master-Slave communication in the slave device. If enabled, the slave will stop I/O data exchange with the Master, if the Master has not send any request message to the slave, within the configured Watchdog time. Furthermore, the slave will

 - switch its outputs to a known state.
 - signal its change of state in a diagnostics message, the next time the Master addresses the slave.

- request re-parameterization from the Master, before resuming I/O data exchange.

If disabled, the slave will remain in data exchange, even if the Master is not communicating, thus maintaining its outputs in the latest known state, based on the last I/O data exchange message.

2. Watchdog Interval

This value is the watchdog timeout related to the Master-Slave communication time out.

Note Enabling the Watchdog Control is highly recommended for safe operation of the network.

 **Caution** In the current version of CX-Profibus, the watchdog value for each of the slave devices is overruled by the value determined by the Master DTM. Therefore, changing the value in the Generic Slave DTM has no effect.

When done, making the I/O configuration settings, press the **Apply** button at the bottom of the window. Next, select the Parameter tab, to make the necessary parameter selections.

6-3-2 Setting Parameters

The parameters are sent by the Master Unit to the slave device prior to establishing I/O data exchange. The slave device will reject incorrect parameters and not establish I/O data exchange, unless the parameters are changed.

In general there will be two types of parameters.

- Common Parameters

Most of the slave devices require at least the common parameters. These parameters apply to the whole slave device.

- Module Parameters

Modular slaves often apply parameters related to a specific I/O module, e.g. the physical slave device consist of a number of hardware modules, each defining an amount of I/O data, requiring its I/O module selection and requiring its own parameters.

Example

The Parameter tab of the CJ1W-PRT21 is shown in the figure below. It lists the common parameters for the CJ1W-PRT21.

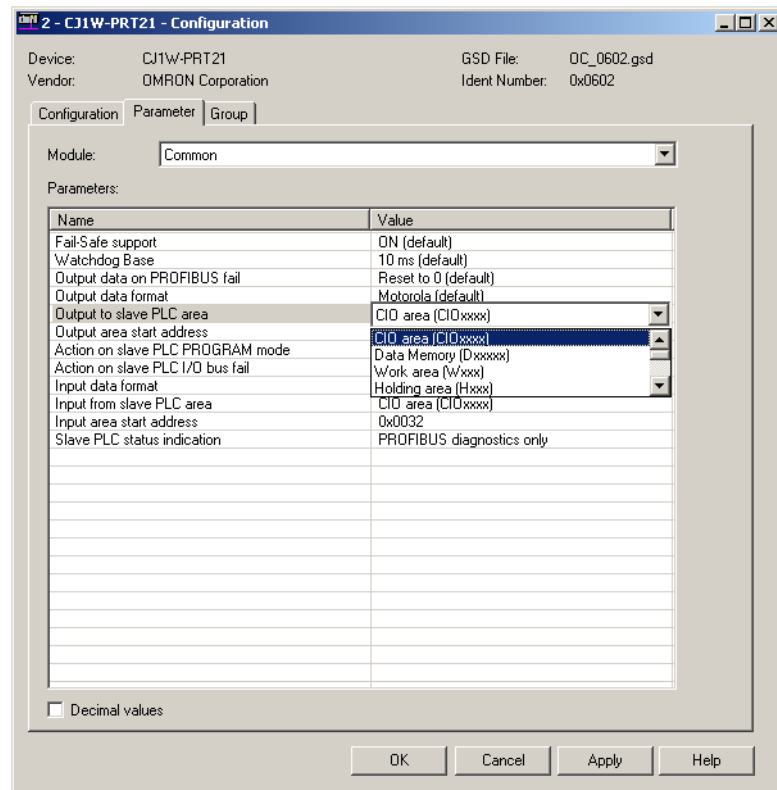

In the figure above, the parameter captions are listed in the left column and the options can be set in the right column. In order to change settings, double-click the required parameter row with the left mouse button. Depending on the parameter type, either a drop-down lists will become available for selection or a value can be entered.

Example

In the figure above, the parameter setting allowing the user to define the target location of the output data in the PLC memory has been selected.

Note Readable captions and/or convenient selection items are not always provided with the parameters. Depending on the slave device and the GSD file implementation, setting the parameter values may require the help of the user documentation for that slave.

6-3-3 Selecting the Group Assignment

The group assignment is sent to the slave devices as part of the parameter message. The group assignment is used as an address within the Global-Control command message (see section 6-6-3 *Transmitting Global-Control Commands*), to address a specific group of slaves, or all slaves. To set a slave device's group address, perform the following steps.

- 1,2,3... 1. Open the Configuration User Interface of the Generic Slave DTM the specific slave device.
2. Select the Group tab.
3. Select the checkbox next to the group numbers for all the groups to which the slave device will belong.
4. Select the **Apply** button at the bottom of the User Interface.

Example

Assigning slave devices to groups is application dependent. The figure below shows the Group selection tab for the CJ1W-PRT21, which has been assigned to groups 1, 2 and 4.

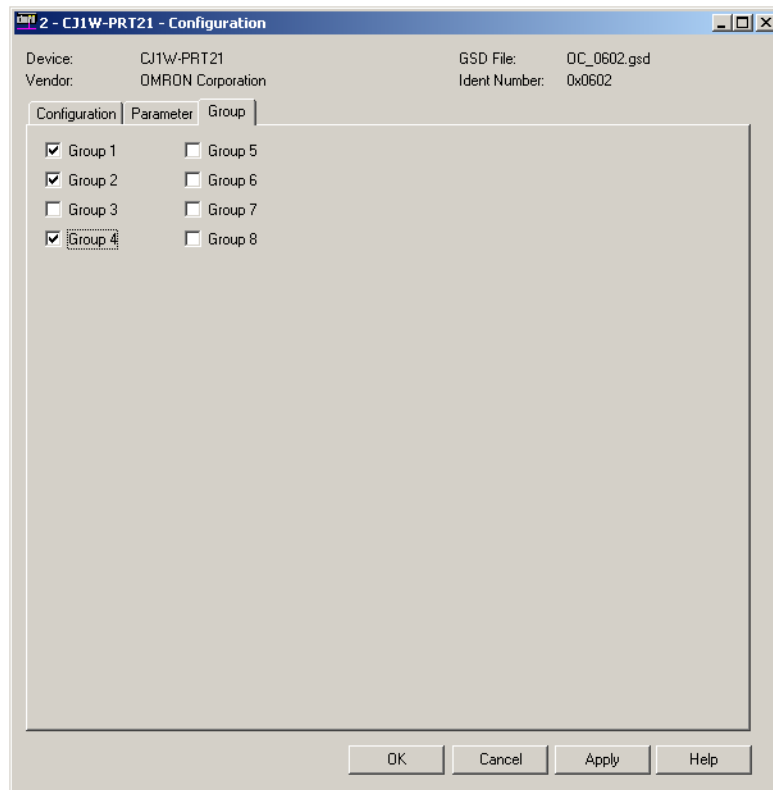

After making the group assignment, press the **OK** button to save the changes and close the DTM Configuration User Interface.

6-4 Configuring the Master

Opening the Master DTM Configuration Interface

After configuring all the slave DTMs, the CS1/CJ1W-PRM21 Master DTM must be configured. In order to open the Master DTM Configuration Interface do either one of the following.

- Select the CS1/CJ1W-PRM21 Master DTM in the Network view and double-click the left mouse button.
- Select the CS1/CJ1W-PRM21 Master DTM in the Network view, and right-click the mouse. From the context menu, select **Configuration**.

The DTM Configuration User Interface is shown below.

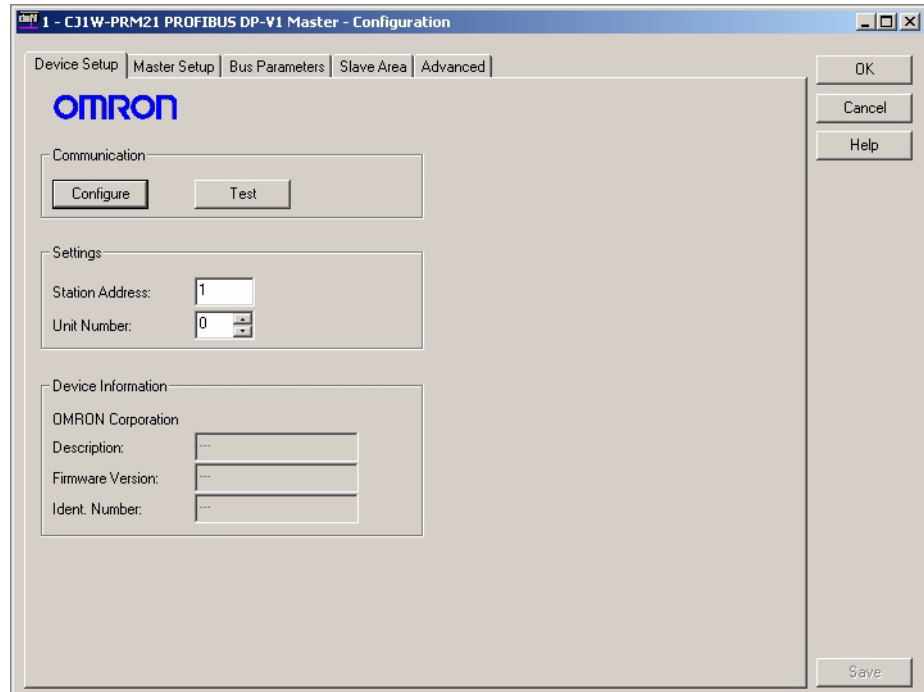

Master Address

In the first tab, the device address and the unit number must be set. The device address can be set in the range from 0 to 125.

Unit Number

The setting of the unit number is required to setup communication with the Unit through CX-Server. The setting in the user interface must match the setting made with the rotary switch on the front of the Unit.

Note The device address is normally assigned automatically. Only in the case where there are other devices in the network which have the same address, the device address of the CS1/CJ1W-PRM21 Master DTM may need to be changed.

After making the changes, select the **Save** button in the lower right corner of the user interface to accept the changes. Next select the Master Setup tab, to display the Master Setup options.

6-4-1 Setting the Master Parameters

Master Setup Tab

The Master Setup tab defines

- the behaviour of the Master Unit, when the PLC CPU switches its mode between RUN / MONITOR and PROGRAM mode.

- The behaviour of the Master Unit in case an error occurs in one of the slave devices allocated to the Master Unit.
- The method of I/O data mapping.

The figure below shows the Master Setup tab.

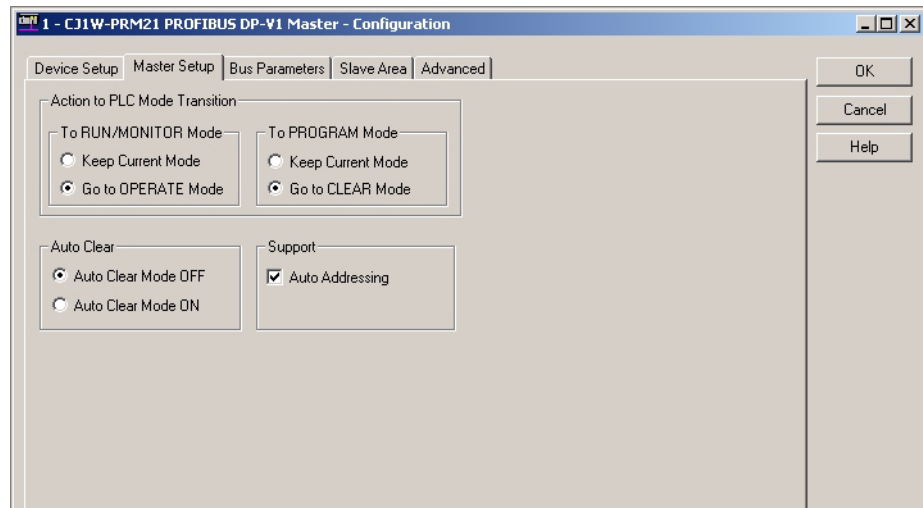

Unit Behaviour upon PLC Mode Changes

The user can select the way the Unit will behave if the PLC mode is changed. The default settings are:

- Set the Unit's operational mode to CLEAR (i.e. set all outputs to a safe state), when switching the PLC CPU to PROGRAM mode.
- Set the Unit's operational mode to OPERATE (i.e. start I/O data exchange with the slave devices), when switching the PLC CPU to RUN / MONITOR mode.

- Note**
1. The advantage of this setting is that the user does not have to program the starting of the network. The disadvantage is that the moment at which the network is started is out of direct control of the PLC user program. I/O data exchange is started, while the program may still be initializing its memory. Depending on the application this may have unexpected effects.
 2. To avoid potential problems at startup, it is recommended to set the network operational mode to 'keep current mode' in case the PLC mode in case the PLC mode changes to RUN / MONITOR and to set the operational mode to CLEAR in case the PLC mode changes to PROGRAM. This requires the PLC user program to switch the network to OPERATE, after startup. Refer to section 6-6-2 *Changing PROFIBUS Mode of the Master Unit* for a programming example.
 3. A side effect of the default settings can be that the network is started right after downloading the parameters to the CS1/CJ1W-PRM21 PROFIBUS Master Unit. After downloading the parameters, the CS1/CJ1W-PRM21 Master DTM will restart the Unit and switch the PLC mode back from PROGRAM mode to the mode it had before downloading. This can be RUN / MONITOR mode.

Auto-CLEAR behaviour

The Auto-CLEAR behaviour defines how the CS1/CJ1W-PRM21 PROFIBUS Master Unit will behave in case one of its allocated slave devices fails during I/O data exchange. This option can be enabled if the application in which the Master Unit is used warrants safety precautions to be taken to prevent unexpected behaviour of the application.

If Auto-CLEAR has been enabled, the Master Unit will automatically transition to the CLEAR state and set the allocated slave device outputs to the safe

state. Refer to section 6-6-4 *Using Auto-CLEAR*, for a description of how to use the Auto-CLEAR function.

Auto-Addressing

Auto-Addressing defines whether or not the CS1/CJ1W-PRM21 Master DTM will automatically map the I/O data in such a way that no gaps exist in the I/O data. If enabled, the user does not need to handle the exact mapping of I/O data on to the PLC memory areas. Refer to section 6-4-3 *Defining and Changing I/O Mapping* for more information on I/O data mapping.

After making the changes, select the **Save** button in the lower right corner of the user interface to accept the changes. Next select the Bus Parameter tab to display the Bus Parameters.

6-4-2 Setting the Bus Parameters

The Bus Parameter setup tab contains all the settings required to setup the communication cycles on the network. The settings depend on the selected baud rate, the number of slaves, the amount of I/O data per slave, etc.

By default, the CS1/CJ1W-PRM21 Master DTM will calculate the bus parameters, based on this information.

Caution Although the user can decide to modify some of these parameters, it is not recommended to do that. Making the wrong configuration may lead to unexpected behaviour.

Example

An example of the Bus Parameter tab is shown below.

The screenshot shows the 'Bus Parameters' tab of the configuration dialog. The 'Baud Rate' is set to 1500 kBits/s. The 'Optimize' section has 'by standard' selected. The 'Slot time' is 300 tBit. The 'Min Station Delay of Responders' is 11 tBit, and the 'Max Station Delay of Responders' is 150 tBit. The 'Quiet Time' is 0 tBit, and the 'Setup Time' is 1 tBit. The 'Min Slave Interval' is 7936 tBit (5.2240 ms). The 'Target Rotation Time' is 7936 tBit. The 'Max Retry Limit' is 1. The 'Highest Station Address' is 7. The 'GAP Update Factor' is 1. The 'Poll Timeout' is 10 ms, the 'Data Control Time' is 140 ms, and the 'Watchdog Control' is 20 ms. Buttons for 'OK', 'Cancel', 'Help', and 'Save' are visible.

The baud rate has been set to 1500 kBit/s. The amount of slaves and the amount of I/O data, results in a poll cycle time of approximately 5.2 ms (Min Slave Interval).

After making the changes, select the **Save** button in the lower right corner of the user interface to accept the changes. Next select the Slave Area tab to display the I/O Mapping.

6-4-3 Defining and Changing I/O Mapping

The I/O data of all slaves can be mapped on to the PLC memory areas through two Output Areas and two Input Areas. The Output data can be distributed over two Output Areas, each of which can be mapped on to PLC memory. Similarly, the Input data can be distributed over two Input Areas, each of which can be mapped on to PLC memory.

Example

The figure below shows the CS1/CJ1W-PRM21 Master DTM's Slave Area tab for an example network with a CJ1W-PRT21, a CPM1A-PRT21, and an F150-PRT Vision system.

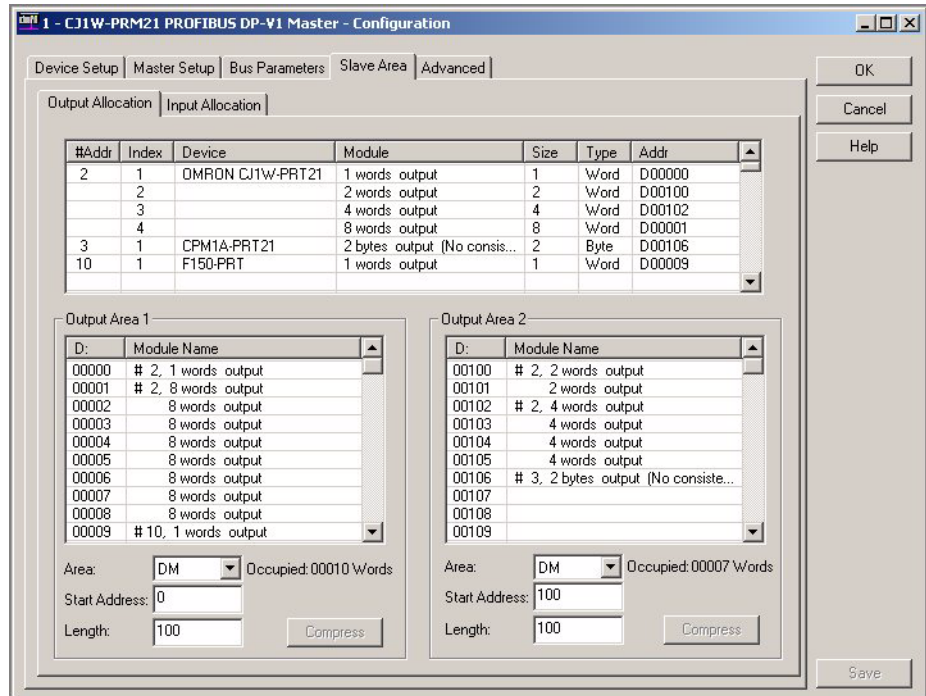

By default all Output data is mapped on to Output Area 1, and all Input data is mapped on to Input Area 1. Each of these Areas can be mapped on to PLC memory independently of each other.

Changing the mapping can be achieved using drag & drop. The module which is mapped to Area 1 and which must be mapped to Area 2, can be copied there by dragging it from the overall module list on top to Area 2.

The I/O mapping concept is discussed in section 6-5-2 Mapping I/O Data.

- Note**
1. By default the Auto-Addressing option will be enabled (see section 6-4-1 Setting the Master Parameters). If any I/O modules are moved from one Area to another, the I/O modules in first Area are re-mapped to close all the gaps between mappings.
 2. Prior to download, the CS1/CJ1W-PRM21 Master DTM will check the mappings for possible Area overlaps, PLC memory overlaps and non-existing EM banks. If an error is detected, download will be aborted and the necessary correction must be made first.

Caution When mapping the I/O Areas, make sure that the I/O data will not overlap the Unit's own CIO Area or one or more of the I/O data areas of any other PLC CPU or I/O Unit. The CS1/CJ1W-PRM21 Master DTM does not check this. Failure to avoid this, will lead to unpredictable behaviour of the Unit.

6-4-4 Configuring CX-Server

Configuring Communication

The CS1/CJ1W-PRM21 Master DTM uses CX-Server to connect to the Unit for downloading a configuration as well as monitoring the Master Unit. To setup the communication to the Unit, perform the following procedure.

- 1,2,3...
1. Open the CS1/CJ1W-PRM21 Master DTM Configuration Interface, Device Setup tab.
 2. Make sure that the Unit Number has been set to the unit number set on the PROFIBUS Master Unit, through the rotary switch on the front.
 3. Select the **Configure** button to start CX-Server.

CX-Server

Up on pressing the **Configure** button, CX-Server is launched and displays the CX-Server User Interface as shown below.

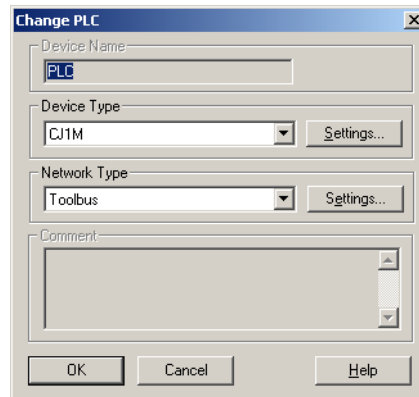

Configuring CX-Server

In order to configure CX-Server for communication with the Unit, perform the following procedure.

- 1,2,3...
1. Select the type of PLC to which the Unit is attached, from the **Device Type** drop down selection box.
 2. Press the **Settings** button next to the PLC type selected. The PLC settings window (see figure below) is displayed.

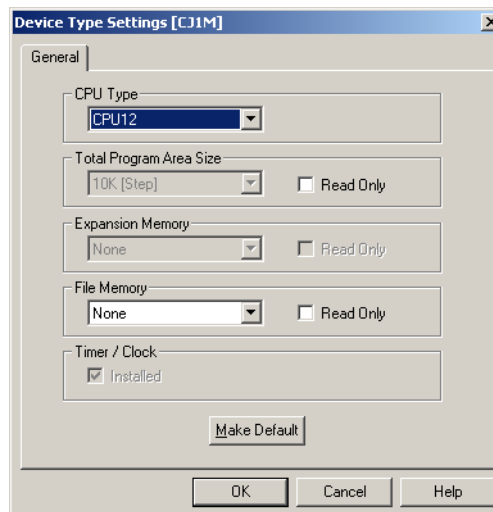

3. In this window make the proper adjustments if necessary. The selections made, must match the physical configuration of the PLC system. When done, press the **OK** button.

4. Select the **Network Type** to be used as connection between the PC and the Unit. The available options may include other PLC systems or Communication Units, which are setup to act as a gateway. Refer to *CX-Server Runtime user Manual (W391)* for details on configuring CX-Server.

Note 1) For further explanation, only the direct connections between the PC and the PLC on which the Unit is attached are considered. These include ToolBus and SYSMAC WAY.

- 2) Select the Settings button next to the Network Type selected, to display the Network settings window, and select the Driver tab (Toolbus is shown as example below).
- 3) Although SYSMAC WAY can be used for the majority of applications, it is limited in a sense that it can not handle the absolute maximum of I/O configuration and parameters, i.e. it can not handle a slave device which requires 244 I/O modules and 244 parameter bytes. Toolbus does not have that limitation.

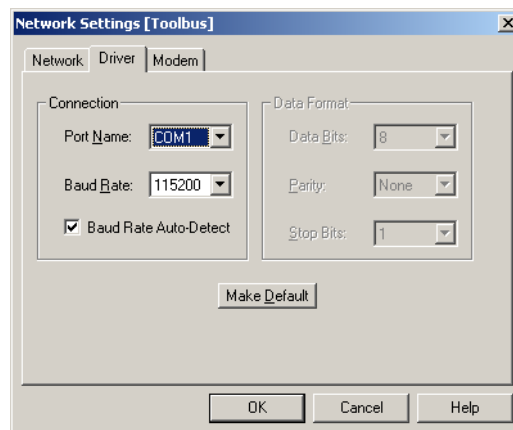

5. Make the necessary selections to facilitate communication between the PC and the PLC CPU to which the PROFIBUS Master Unit is attached, and press the **OK** button.

Testing CX-Server setup

After making the settings, press the **OK** button to close the CX-Server interface. In order to verify that the communication has been setup correctly, press the Test button in the Device Setup tab of the DTM Configuration User Interface. This will initiate a FINS command to read the Unit's profile, i.e. the name of the Unit and the firmware version.

If the communication has been setup correctly, the response of the FINS command will yield the required information, which will be displayed in the Device Information box, in the **Description** and **Firmware Version** fields. If the communication is not setup correctly, the two fields will contain three dashes, i.e. "---", and an Error message will be displayed in the Error Log view of CX-Profibus. The communication settings must be changed to the correct value first. Refer to *Appendix D Configurator Error and Warning Messages* for more information on communication and download errors.

Note Since CX-Server is the common driver software for connection between PC-based CX- programs (e.g. CX-Programmer, CX-Supervisor, etc.) and the CS1/CJ1-series PLC, all these programs can communicate simultaneously with the PLC. However, the settings for CX-Server made through each of these programs have to be exactly the same, to allow simultaneous communication.

6-4-5 Downloading the Configuration

Downloading Parameters In order to download the parameter sets to the CS1/CJ1W-PRM21 PROFIBUS Master Unit, the following sequence must be performed.

- 1,2,3...**
1. Select the CS1/CJ1W-PRM21 Master DTM in the Network view and right-click the mouse to display the context menu.
 2. Select **Download Parameters** from the menu, to initiate a download. A communication channel through CX-Server will be opened automatically.
 3. When communication is achieved with the PLC, a warning window will be displayed, notifying the user that the PLC will be switched to PROGRAM mode. If the user confirms this, the download will continue.
 4. The downloading process is handled by the CS1/CJ1W-PRM21 Master DTM. The CS1/CJ1W-PRM21 Master DTM will switch the Master Unit to OFFLINE, commence the download, and after successful download, issue a command to the Master Unit to store the parameter sets in the Unit. A window is displayed to show the progress of the download.
 5. After storage has been completed, the CS1/CJ1W-PRM21 Master DTM will issue a command to restart the CS1/CJ1W-PRM21 PROFIBUS Master Unit. The new parameter sets will then become effective.
 6. After restarting the Unit, a warning window will be displayed, allowing the user to switch the PLC CPU back to its original mode.

- Note**
1. When switching the PLC CPU back to its original mode, after download, the PROFIBUS Master Unit will behave according to the setting made in the Master Setup Tab (see section 6-4-1 *Setting the Master Parameters*) If the Action to PLC mode change has been set to go to OPERATE mode, when the PLC switches to RUN/MONITOR mode, the last action of the download process may start up the network. Therefore, if this is not desired, care must be taken to select the right setting.
 2. In case of a failure in the download process, refer to section 7-4-1 *Troubleshooting Parameter Download*, to establish the cause and the remedy.
 3. After successfully downloading the configuration to the CS1/CJ1W-PRM21 PROFIBUS Master Unit, the user can make a backup of the configuration on a memory card, which can be inserted in the PLC CPU. This backup can facilitate configuration of a replacement Unit, without the need of a PC. Refer to *Appendix E Memory Card Backup Functions* for the backup/restore procedure.

6-5 I/O Communication Characteristics

6-5-1 I/O Data Configuration

I/O Data Configuration

Each slave device defines its I/O data size, sequence and format by means of I/O modules, each of which consists of one or more bytes, containing a PROFIBUS defined coding scheme. The I/O modules can define input data, or output data or both input and output data. The I/O modules are used to configure the I/O data exchange process in the Master Unit and also to verify the amount of I/O data to be exchanged with the slave device.

For modular slave devices the I/O modules are selected by the user from a list of available modules. The modules usually have to be consistent with the physical I/O of the slave device. For non-modular slave devices there is only one I/O module, and can therefore not be selected by a user.

The selected I/O module bytes are sent over the PROFIBUS network to the slave device at startup, using a Chk_Cfg message. The slave device has to check and approve the I/O modules sent by the Master Unit, before I/O data exchange can be established.

I/O Data Range Supported

The CS1/CJ1W-PRM21 PROFIBUS Master Unit supports up to 4000 I/O modules, which can define a total of up to 7168 words of input data and/or output data. The I/O module selection made per slave by the user is also used to setup the I/O mapping, i.e. the definition of which I/O modules are mapped to which PLC memory location.

This section discusses the aspects of I/O data exchange between the CS1/CJ1W-PRM21 PROFIBUS Master Unit and the PLC CPU.

6-5-2 Mapping I/O Data

I/O Mapping Concept

The CS1/CJ1W-PRM21 PROFIBUS Master Unit provides an I/O mapping concept, based on the I/O module selection for each slave device. Each selected I/O module can - depending on whether it defines input and/or output data - be mapped to one of two input and/or output areas. Each of the two input and output areas can be mapped to any PLC memory area location, independent of each other. The I/O mapping must be setup using the CS1/CJ1W-PRM21 Master DTM, as provided with CX-Profibus.

Mapping the I/O modules involves two steps:

- Allocate each I/O module to one or more of the Input/Output areas.
- Allocate each Input/Output area to PLC memory.

Default I/O Mapping Algorithm

When setting up the network, i.e. selecting the slave devices and I/O modules per slave, all input modules will - by default - be allocated to Input area 1, all output modules will be allocated to Output area 1. The following rules apply when allocating the I/O modules to the areas:

- I/O modules are mapped starting at the lowest address of an Input/Output area.
- I/O modules are mapped in ascending order according to slave device address.
- I/O modules per slave device, are mapped in the order in which they were selected, when setting up the slave device.

Furthermore, Input area 1 is by default mapped to CIO 3300, whereas Output area 1 is by default mapped to CIO 3200.

Example

The default mapping algorithm is illustrated in the figure below, with the following configuration:

- Slave device 1: One input/output module, one output modules.
- Slave device 2: One input module.
- Slave device 3: One output module.
- Slave device 4: Two input modules.

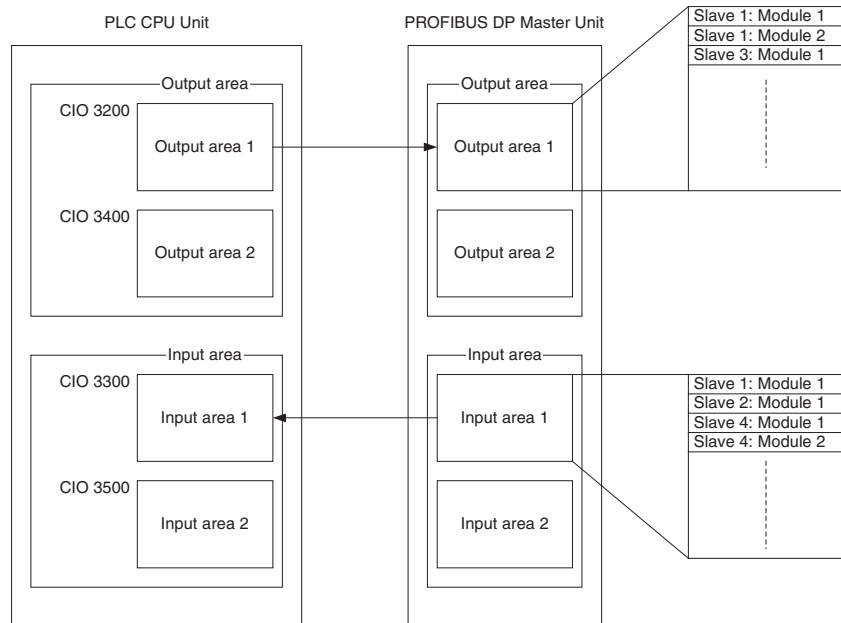

- Note**
1. The end address of each Input/Output area in the PLC memory, depends on the size of the allocated I/O data.
 2. If more than 100 words of input or output have been configured for the slave, overlap of memory areas will occur in the PLC, if default I/O mapping is used as shown above.

Caution The default mapping of areas on to the PLC memory is the same default mapping as used in the CS1/CJ1W-DRM21 Devicenet Master/Slave Unit. Care should be taken to avoid data overlap, if such a Unit is part of the same PLC CPU system as the CS1/CJ1W-PRM21 PROFIBUS Master Unit.

The CS1/CJ1W-PRM21 PROFIBUS Master Unit, will assemble the correct PROFIBUS data messages from the storage order in the Input and Output memory areas.

Auto Addressing

The default allocation of I/O modules, i.e. I/O modules are mapped in ascending order of slave addresses and module selection, uses the concept of Auto Addressing of the CS1/CJ1W-PRM21 Master DTM. Auto Addressing will (re)allocate I/O modules according to the algorithm explained above in each area.

If a configuration has been selected, which is changed later - for example - by adding an I/O module to one of the slaves, the Auto Addressing feature will add that module to the default area, between the already selected modules of that particular slave device.

Caution When an I/O module is added to or deleted from a configuration at a later point in time, Auto Addressing will cause a change in the addresses of subsequent I/O modules in an Input/Output area. This will cause I/O data of (a part of the) slave devices to be re-mapped to different locations in the PLC memory. In order to avoid unexpected results, the PLC user program may have to be adapted as well.

- Note**
1. Auto Addressing will not change the allocation of I/O modules to a certain area, i.e. a module allocated to Input/Output area 2, will not be re-allocated to area 1, if Auto Addressing is enabled.
 2. Auto Addressing will not change the start address of the areas.
 3. Auto Addressing is by default enabled, when starting a new project. It is however, disabled for existing projects to avoid unwanted re-mapping.

Example

The figure below shows an example of the effects of Auto Addressing on (re)allocation of I/O modules. In the original I/O configuration on the left, the first slave - an OMRON CJ1W-PRT21 - consisted of two I/O modules. In new configuration one I/O module was inserted, and subsequent modules were re-allocated in the process.

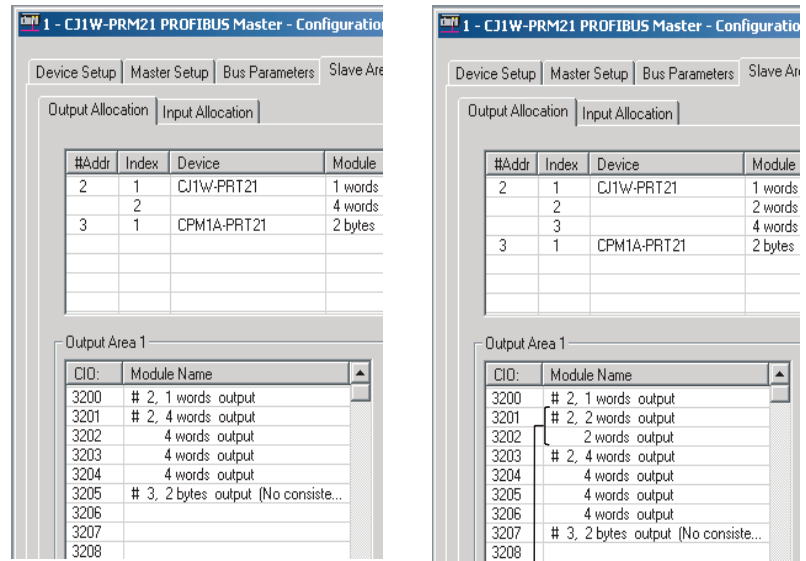

Initial I/O Configuration

One I/O module of two output words was inserted, and re-allocated subsequent I/O modules.

Note The start address of Output area 1 in the example remains the same, after adding an I/O module.

Re-allocating I/O Modules

After setting up the initial I/O configuration, the I/O modules can be re-mapped to the second Input/Output area. This can be accomplished by using drag & drop to move the I/O modules. To accomplish this, perform the following sequence.

- 1,2,3... 1. Open the CS1/CJ1W-PRM21 Master DTM - Configuration User Interface.
2. Select the Slave Area tab. The window shows two sub tabs: One for Output Allocation and one for Input Allocation. The following points apply to each of these tabs.
3. After setting up the initial I/O configuration, all I/O modules will be shown in the overall list in the upper half of the Slave Area tab. This is a pick list

from which modules can be selected. The allocated I/O modules are listed in area 1, the column on the left of the lower half of the window.

Note The I/O modules in the pick list, all remain there. The allocated I/O modules are copies of the modules selected from the pick list.

4. In order to move an I/O module from one area to another, select the module in the pick list.
5. Hold the left mouse button and drag the I/O module to the Input/Output area of choice. Release the left mouse button to drop the module in place.

Note The area to place the module in must be empty. The area to put the modules in does not need to be selected first.

Auto Addressing and Re-allocating I/O Modules

Auto Addressing (re)allocates I/O modules in all Input/Output areas. If - after setting up the initial I/O configuration - two or more I/O modules are moved from one area to another, Auto Addressing maintains the same sequence, i.e. the slave device with the lowest address and its I/O modules in the selected sequence are allocated before a slave device with a higher address.

Example

In the figure below two output modules from the initial I/O configuration (top window) have been re-allocated to Output area 2 (bottom window)

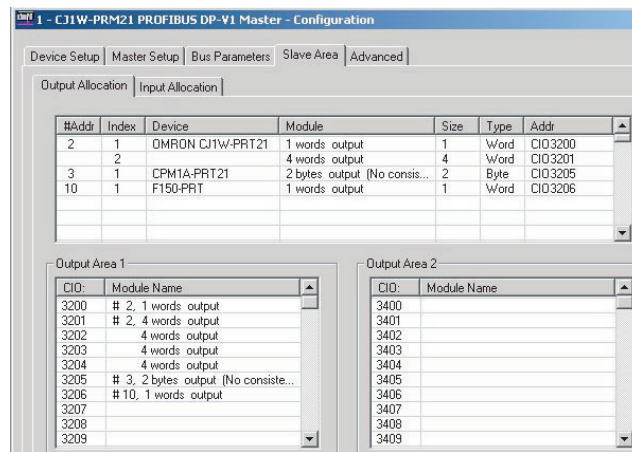

Initial I/O configuration

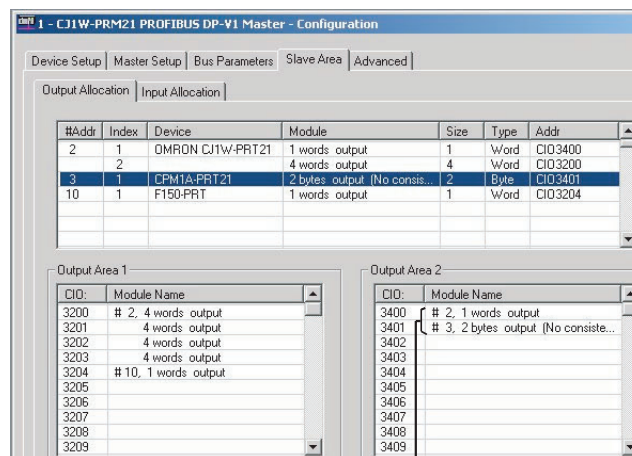

The first Output modules of slave device #2 and #3 were moved to Output area 2.

The example shows that the sequence of slave addresses is maintained, the sequence of I/O modules selected is maintained and the I/O modules are allocated to the lowest address of the area.

Enable/Disable Auto Addressing

The Auto Addressing feature can be disabled in the CS1/CJ1W-PRM21 Master DTM. In order to do that, perform the following sequence.

- 1,2,3...**
1. Open the CS1/CJ1W-PRM21 Master DTM - Configuration User Interface.
 2. Select the Master Setup tab.
 3. Enable/Disable Auto Addressing by selecting/deselecting the Auto Addressing checkbox in the Support box.
 4. When Auto Addressing is being enabled, a warning message is displayed, informing the user of the effects of enabling Auto Addressing.

 **Caution** Enabling Auto Addressing has the immediate effect of re-allocating I/O modules of an existing configuration, within each Input/Output area. The I/O modules are re-mapped according to the algorithm described above.

Note Disabling Auto Addressing has no immediate effect on an existing I/O mapping.

I/O Mapping Without Auto Addressing

A disabled Auto Addressing feature has the following effects on I/O mapping:

- When adding new slave devices or new I/O modules to an existing slave configuration, the I/O modules will be mapped to the first I/O areas, but the modules will be appended to the existing I/O mapping.
- When deleting a slave device from the network configuration, or deleting I/O modules from a slave device, the deleted I/O modules will leave gaps behind in the already existing I/O mapping. If after deleting an I/O module a slave device still has more than one module configured, but these modules are not in the same place, the DTM will attempt to remap them together.
- Changing the address of a slave device, of which already an I/O mapping exists, has no effect on the existing mapping
- Selecting an additional I/O module for a slave device, in the presence of already allocated I/O modules, will cause a complete re-map of all existing modules if the total I/O does not fit within the space it is already occupying. The modules are re-mapped to the next available location in the area, leaving behind a gap in the existing I/O mapping. Subsequent I/O modules of other slave device will remain mapped as before the module addition.
- When moving an I/O module from one area to another, they can be located anywhere within the target area. They are not re-mapped to the start of that.
- When moving an I/O module from one area to another, the module leaves behind a gap in the I/O mapping of the first area.

- Note**
1. Gaps in the I/O mapping still contribute to the total size of an area, although they do not contain valuable data. They therefore decrease the total I/O capacity of the CS1/CJ1W-PRM21 PROFIBUS Master Unit, and unnecessarily occupy PLC memory.
 2. In the I/O data exchange with the PLC CPU, these gaps will contain zeros.

Example

The figure below illustrates the effects of re-allocating I/O modules, when Auto Addressing has been disabled.

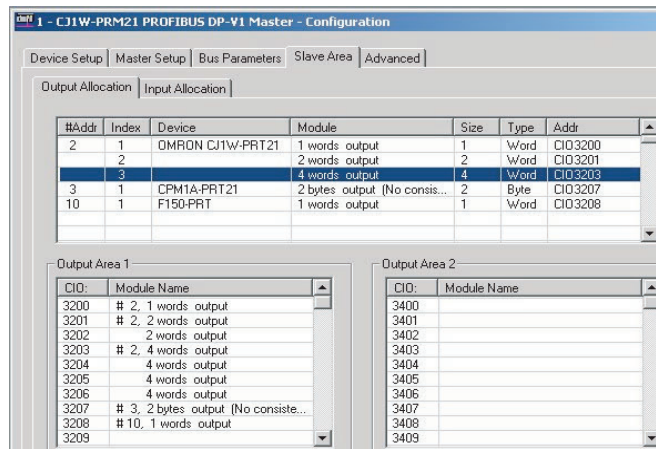

Initial I/O Configuration

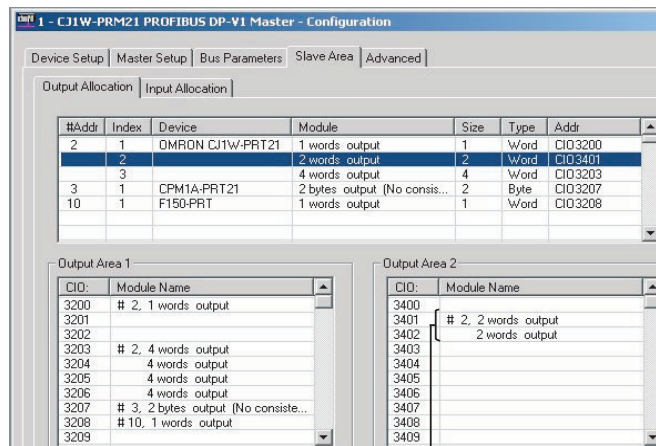

Note: Auto-addressing is disabled

Output module 2 of slave device #2 was moved to Output area 2, location CIO 3401, leaving behind a gap in Output area 1.

Removing Gaps from the I/O Mapping

Since gaps in the I/O mapping are generally undesirable, the CS1/CJ1W-PRM21 Master DTM provides a means to remove all gaps, after finalizing the I/O mapping procedure. This removal is accomplished by compressing the I/O modules in a particular area.

Compressing the I/O Mapping

Compressing re-allocates all I/O modules in an area as close to the start of the area as possible. Compressing an area does not change the sequence of the slave devices and/or the I/O modules. It only removes the unused memory gaps. Compressing can be initiated for each area individually.

In order to compress an area, perform the following sequence.

- 1,2,3... 1. Open the CS1/CJ1W-PRM21 Master DTM - Configuration User Interface, and select the Slave Area tab.
2. Select the Output Allocation tab or the Input Allocation tab, to display the areas to compress.
3. To compress the area, press the **Compress** button at the bottom.
4. After finalizing the compress action, select the **Save** button at the lower right corner, to save the changes made.

Note Compressing an Input/Output area has no effect on the start address of the area.

Example

The figure below, shows the effects on the previous example, after pressing the **Compress** button in both Output areas.

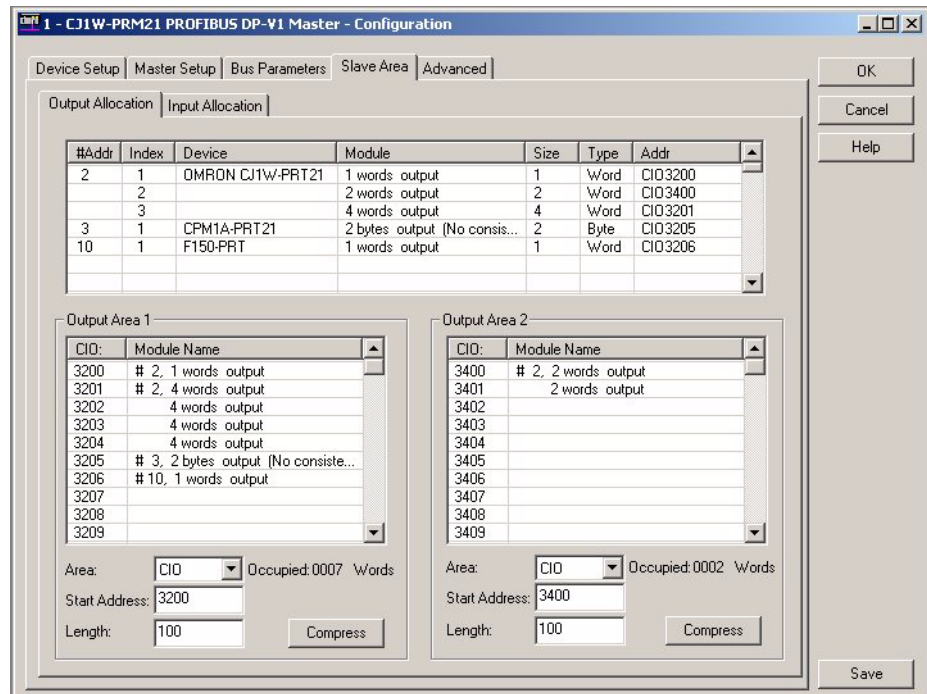

Selecting the I/O Area Start Address

1,2,3...

After finalizing the mapping of the I/O modules on to the various I/O areas, the addresses to which the areas will be mapped in the PLC memory need to be defined. To define the area mapping, perform the following settings.

1. For each area, which contains I/O modules, select the PLC memory area.
2. For that area, set the address to which the first location of the Input/Output area will be mapped. The Input/Output area will occupy the PLC memory area, from this start address to ascending memory locations.
3. The total size per Input/Output area can be found for each area, next to the PLC memory area selection box (see for example, the figure above, in which Output area 1 occupies 6 words).

Note

1. The CS1/CJ1W-PRM21 Master DTM will check whether two or more selected mappings on to the PLC memory will be overlapping. In that case, the start address set, will be shown in red.
2. Upon downloading the configuration to the CS1W/CJ1W-PRM21 PROFIBUS Master Unit, the Master DTM will also check if the PLC memory areas selected do exist in the PLC CPU model, connected to the Master Unit (e.g. are any selected EM-banks present).
3. If any mapping error is discovered by the Master DTM, an error message is displayed, and download is terminated.

6-5-3 Supported Data Types

The CS1/CJ1W-PRM21 PROFIBUS Master Units perform an interface function between a PROFIBUS network and the CS1/CJ1 PLC CPU. On both sides of the interface different formats for data and data storages are used.

To ensure that I/O data transferred through the interface can be used on both sides of the interface without additional formatting, the CS1/CJ1W-PRM21 PROFIBUS Master Units perform the necessary data formatting. This ensures that I/O data in the PLC CPU memory can be processed by standard PLC Instructions, and that the I/O data transferred to / from the PROFIBUS DP slaves over the network is compliant with the PROFIBUS DP definitions.

The table below lists the I/O data formats supported by both the PROFIBUS network and PLC CPU. *Appendix C I/O Data Conversions* defines the conversion of I/O data in detail.

Data Type	Size [bytes]	PROFIBUS DP	CS/CJ-series PLC
Single 8-bit Integer signed/unsigned	1	Supported. Data is transmitted on a byte-by-byte basis.	Not supported Minimum is 16-bit words. Two bytes will be formatted in one word. Words containing odd bytes will be padded with zeros.
Single 16-bit Integer signed/unsigned	2	Supported. Data is transmitted on a Most-Significant-Byte First basis.	Supported. Single 16-bit integers are transferred to memory words in PLC memory.
Single 32-bit Integer signed/unsigned	4	Supported. Data is transmitted on a Most-Significant-Byte First basis.	Supported. Data is stored with the Least-Significant-Word at the lowest address.
Floating point	4	Supported. Data is transmitted on a Most-Significant-Byte First basis.	Supported. Data is stored with the Least-Significant-Word at the lowest address.
Visible string	--	Supported. Length of string is fixed by I/O configuration. Data is transmitted on a left-to-right basis (i.e. first character is transmitted first).	Supported. First characters are stored at the lowest address. String is padded with a zero byte or a zero word, depending on the number of characters.
Byte string	--	Supported. Length of string is fixed by I/O configuration. Data is transmitted on a left-to-right basis (i.e. first character is transmitted first).	Supported. First bytes are stored at the lowest address. String is padded with a zero byte or a zero word, depending on the number of characters.
Date / Clock time	7	Supported. Date/Time format contains absolute time with respect to start of century. Date/Time is coded in individual bytes.	Not Supported. Date/Time format is transferred to PLC memory as string of words.
Time of day	6	Supported. Time of day format contains time since midnight.	Not Supported. Time of day format is transferred to PLC memory as string of words.
Time difference	6	Supported. Time difference format is the same as Time of day format, but contains a time difference.	Not Supported. Time difference format is transferred to PLC memory as string of words.

6-5-4 Exchanging I/O Data over PROFIBUS

The cyclic refresh cycles of the PLC CPU and the I/O data exchange cycles of the PROFIBUS network are two asynchronous processes, for which the CS1/CJ1W-PRM21 PROFIBUS Master Unit performs the interface function.

PLC Cyclic Refresh vs. PROFIBUS I/O Exchange Cycle

In general, all I/O data exchanged during a PROFIBUS I/O data exchange cycle must be exchanged with the PLC CPU, as soon as possible after the end of each PROFIBUS DP I/O data exchange cycle is signalled.

In order to transfer I/O data between the Unit and the PLC CPU, the Unit, has to request a transfer of I/O data. The actual transfer of I/O data will then be performed during the next PLC cyclic refresh, which depends on the PLC user program.

PLC Cyclic Refresh Rules

To avoid missing I/O data as much as possible, the CS1/CJ1W-PRM21 uses the following rules for cyclic refresh with the PLC CPU.

- The PROFIBUS Master Unit estimates - based on the actual PLC cycle and the last cyclic refresh - when a new cyclic refresh from the PLC CPU can be expected and requests a refresh of I/O data, shortly before that.
- If the end of PROFIBUS DP I/O data exchange is signalled, before the request based on the estimation is issued, the PROFIBUS Master Unit will immediately request a cyclic refresh.
- If the end of PROFIBUS DP I/O data exchange is signalled, after the request has been issued or during the cyclic refresh, the PROFIBUS Master Unit will request a cyclic refresh, as soon as the requested cyclic refresh has been finished.

The implementation of these rules are illustrated in the figures below for two distinctive cases.

PROFIBUS DP Cycle > PLC Cyclic Refresh

The figure below shows the effects of these rules for the case in which the PROFIBUS DP I/O data exchange cycle > PLC cyclic refresh.

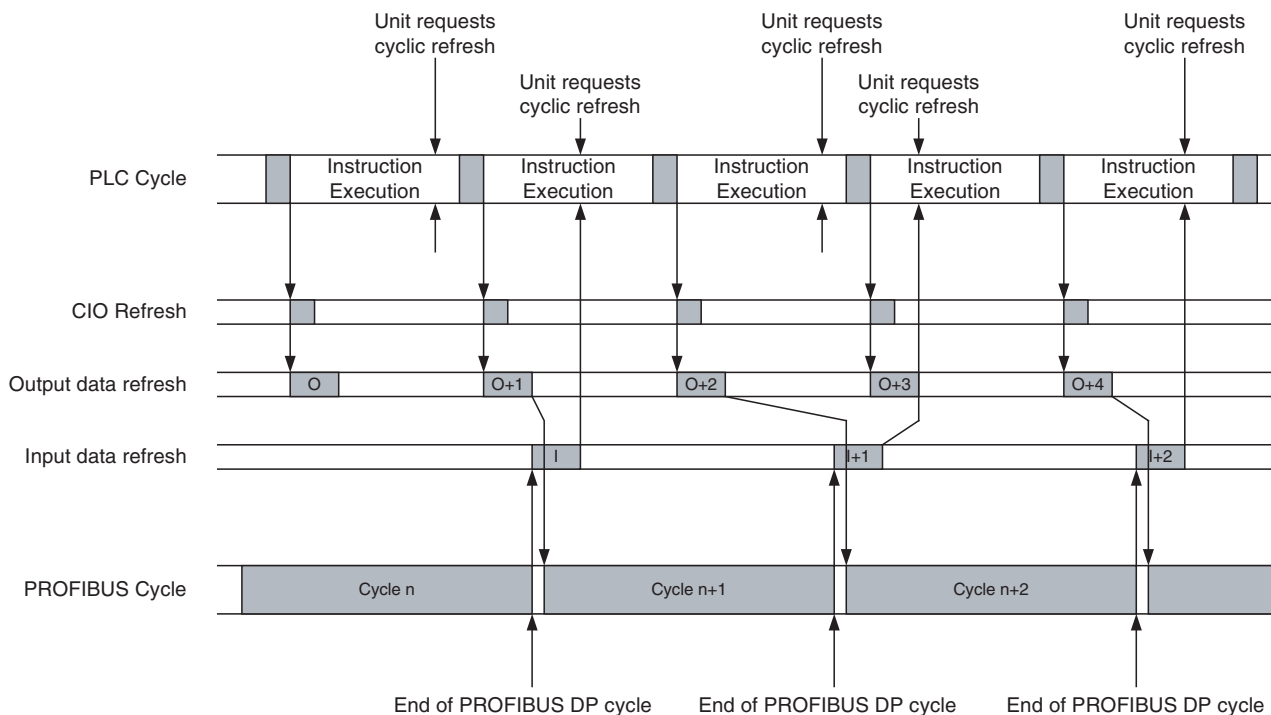

PROFIBUS DP I/O data exchange cycle > PLC cyclic refresh results in the following I/O transfer characteristics.

- Not all output data is guaranteed to be transmitted over the PROFIBUS network (referring to the figure above: Output data marked with “O” is overwritten by “O+1” and therefore lost).
- Input data is always sent to the PLC CPU.

- Note**
1. PLC cyclic refresh times may vary, depending on the execution of the user program. If variation is too large, this may result in I/O data being lost.
 2. To prevent output data not being transmitted over the PROFIBUS network, the PROFIBUS DP cycle time must be made at least two times the PLC cyclic refresh time. This can be accomplished by changing the Target Token Rotation time in the Master DTM Configuration User Interface (see section 6-4-2 *Setting the Bus Parameters*).

PROFIBUS DP Cycle < PLC Cyclic Refresh

The figure below shows the effects of the cyclic refresh rules for the case in which the PROFIBUS DP I/O data exchange cycle < PLC cyclic refresh.

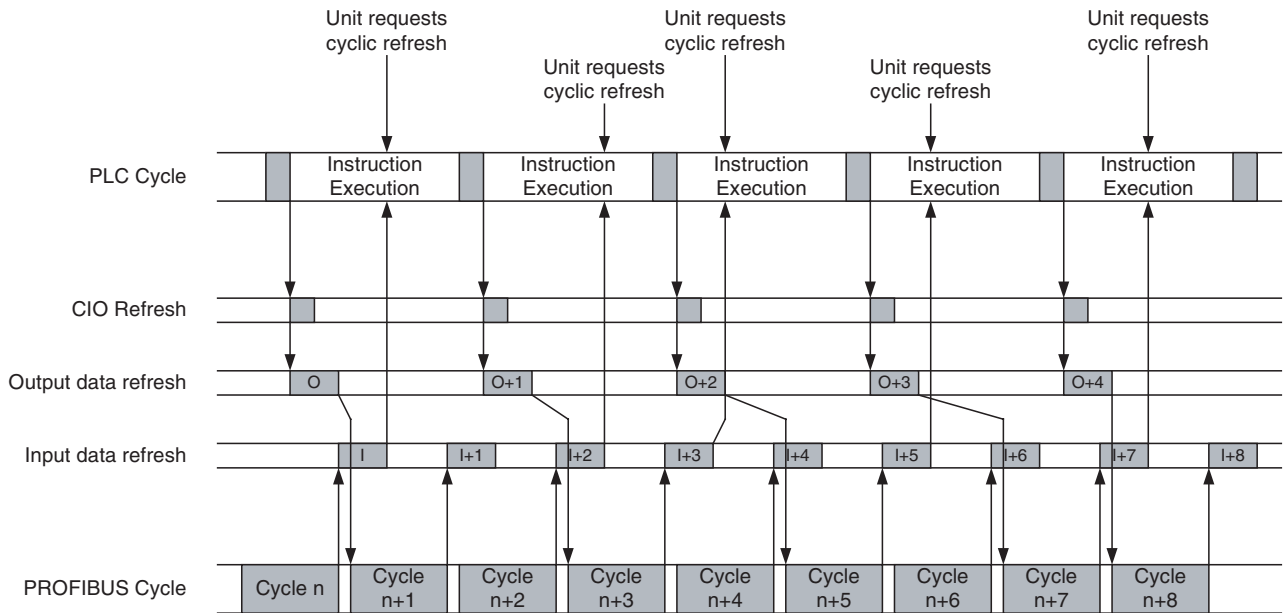

PROFIBUS DP I/O data exchange cycle < PLC cyclic refresh results in the following I/O transfer characteristics.

- All output data sent by the PLC CPU is transmitted over the PROFIBUS network.
- Not all Input data is transferred to the PLC CPU (referring to the figure above: Input data marked with I+1, I+4, I+6 and I+8 are lost).

- Note** To prevent input data not being transferred to the PLC CPU, the PLC cyclic refresh time must be at least two times the PROFIBUS DP cycle time.

6-5-5 PLC Cycle Time Performance

The cyclic refresh time is the time required for I/O data to be exchanged between the PLC CPU Unit and the PROFIBUS Master Unit. The PLC CPU Unit cyclic refresh time is increased when a PROFIBUS Master Unit is mounted, as shown below.

PLC CPU type	PROFIBUS Master Unit cyclic refresh time (ms)
CS1/CJ1G-H CPU	$0.5 + 0.001 \times \text{the number of I/O words}$ (See notes)
CS1/CJ1H-H CPU	$0.3 + 0.001 \times \text{the number of I/O words}$ (See notes)
CJ1M	$0.5 + 0.001 \times \text{the number of I/O words}$ (See notes)

- Note**
1. The number of words refreshed is the total number of words in the I/O area that are used by the slave devices, including any unused words that may be present in I/O mapping gaps (refer to section 6-5-2 *Mapping I/O Data*).
 2. The number of words refreshed also includes the 25 CIO status and command words.
 3. If FINS message communications is being performed, add the number of words used in the message communications to the above number of words when messages are being processed.
 4. For details about cyclic refresh time or PLC cycle time, refer to operation manual of the PLC.

Note To avoid missing input data or output data, the PLC cyclic refresh time must be at least 3 ms.

6-5-6 I/O Response Time

The maximum I/O response time is defined as the time from the moment an input on a slave device with the lowest PROFIBUS address is switched ON (OFF) until the moment the output on a slave device with the highest PROFIBUS address is switched ON (OFF).

PROFIBUS DP Cycle > PLC Cyclic Refresh

The figure below shows the timing in case the PROFIBUS DP cycle > PLC cyclic refresh.

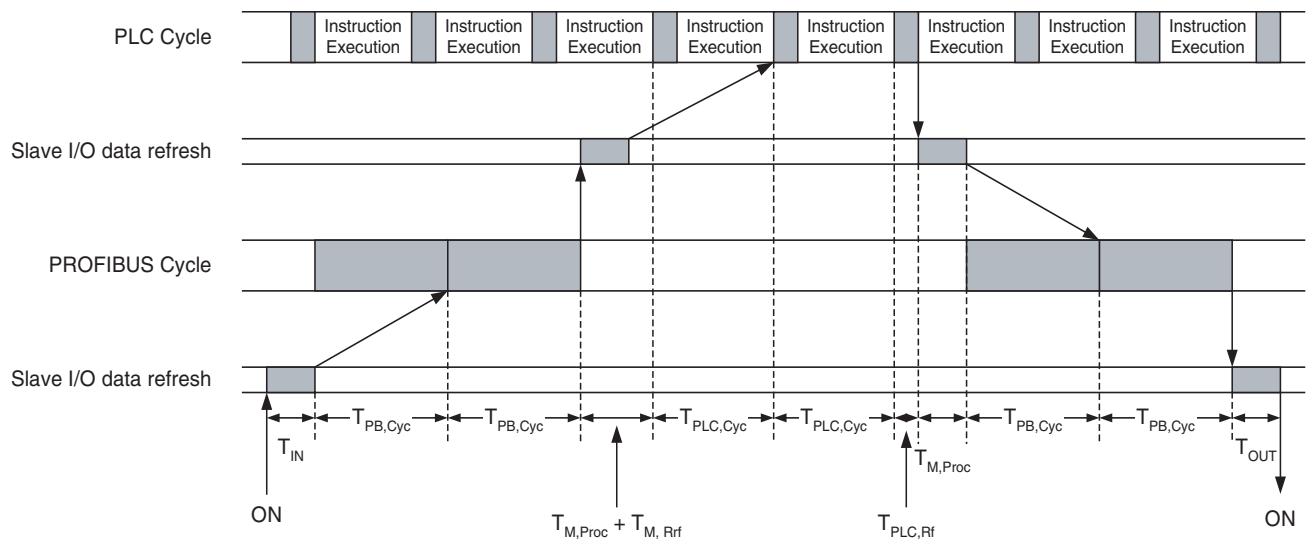

- T_{IN} Slave device Input ON (OFF) delay.
- $T_{PB,Cyc}$ PROFIBUS I/O data exchange cycle time
(See *Appendix A Bus Parameters*)
- $T_{M,Proc}$ I/O Processing time in the Master Unit. Minimum value is 430 μ s, but may increase with increasing I/O data size.
- $T_{M,Rrf}$ Master request cyclic refresh until actual start of cyclic refresh.
- $T_{PLC,Cyc}$ PLC cycle time (See section 6-5-5 *PLC Cycle Time Performance*).
- $T_{PLC,Rf}$ PLC cyclic refresh time (See section 6-5-5).
- T_{OUT} Slave device Output ON (OFF) delay.

The total I/O response time is the sum of all components:

$$T_{IO} = T_{IN} + 4 * T_{PB,Cyc} + 2 * T_{M,Proc} + T_{M,Rrf} + 2 * T_{PLC,Cyc} + T_{PLC,Rf} + T_{OUT}$$

Note The calculation assumes the presence of only one Master Unit on the PROFIBUS network.

PROFIBUS DP Cycle < PLC Cyclic Refresh

The figure below shows the timing in case the PROFIBUS DP cycle < PLC cyclic refresh.

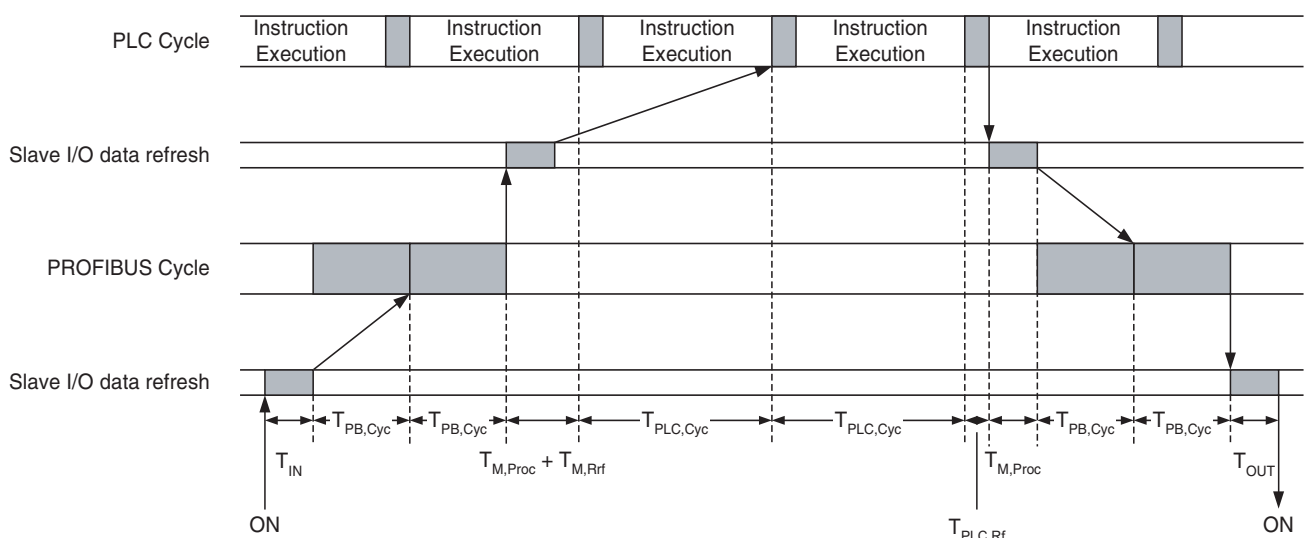

- T_{IN} Slave device Input ON (OFF) delay.
- $T_{PB,Cyc}$ PROFIBUS I/O data exchange cycle time
(See *Appendix A Bus Parameters*)
- $T_{M,Proc}$ I/O Processing time in the Master Unit.
- $T_{M,Rrf}$ Master request cyclic refresh until actual start of cyclic refresh.
- $T_{PLC,Cyc}$ PLC cycle time (See section 6-5-5 *PLC Cycle Time Performance*).
- $T_{PLC,Rf}$ PLC cyclic refresh time (See section 6-5-5).
- T_{OUT} Slave device Output ON (OFF) delay.

The total I/O response time is the sum of all components:

$$T_{IO} = T_{IN} + 4 * T_{PB,Cyc} + 2 * T_{M,Proc} + T_{M,Rrf} + 2 * T_{PLC,Cyc} + T_{PLC,Rf} + T_{OUT}$$

Note The calculation assumes the presence of only one Master Unit on the PROFIBUS network

Minimum I/O Response Time

The minimum response time, i.e. the time from an input on a slave device being set to the time the output on the same slave device is set is calculated, based on the figure below. The following assumptions are made:

- The slave device is the first one in the PROFIBUS I/O data exchange.
- The input data is available right before the internally generated cyclic refresh request is set. In this case, a complete cyclic refresh will take place (See section 6-5-4 Exchanging I/O Data over PROFIBUS)

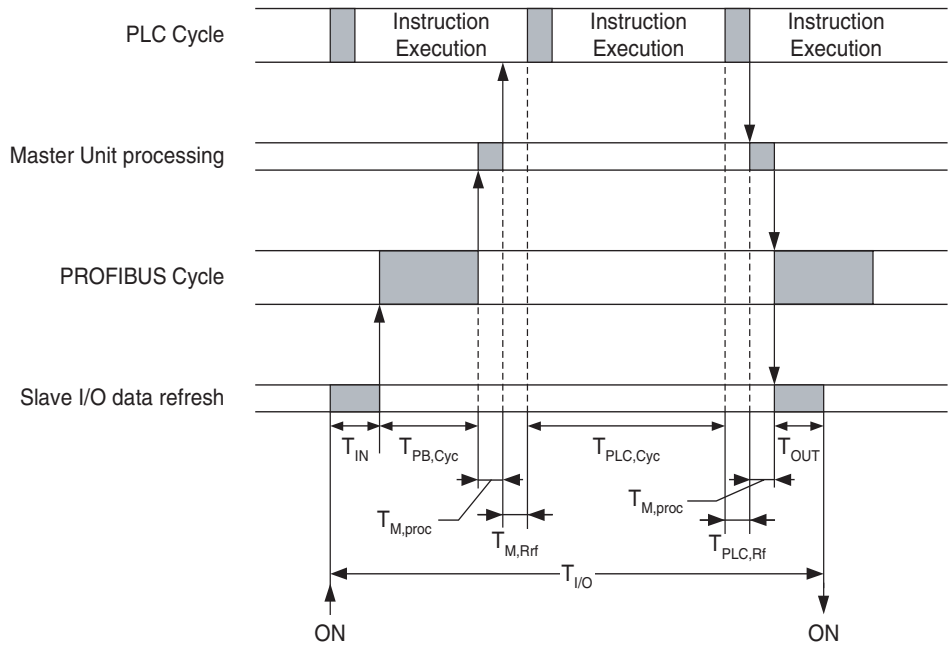

- T_{IN} Slave device Input ON (OFF) delay.
- $T_{PB,Cyc}$ PROFIBUS I/O data exchange cycle time (See Appendix A Bus Parameters)
- $T_{M,Proc}$ I/O Processing time in the Master Unit.
- $T_{M,Rrf}$ Master request cyclic refresh until actual start of cyclic refresh.
- $T_{PLC,Cyc}$ PLC cycle time (See section 6-5-5 PLC Cycle Time Performance).
- $T_{PLC,Rf}$ PLC cyclic refresh cycle time (See section 6-5-5).
- T_{OUT} Slave device Output ON (OFF) delay.

The total I/O response time is the sum of all components:

$$T_{IO} = T_{IN} + T_{PB,Cyc} + 2 * T_{M,Proc} + T_{M,Rrf} + T_{PLC,Cyc} + T_{PLC,Rf} + T_{OUT}$$

6-5-7 System Startup Time

Startup Time Definition

The system startup time is the delay from the time the CS1/CJ1W-PRM21 PROFIBUS Master Unit is turned ON, or reset, until I/O data exchange with all slave devices has been established. For this, the following is assumed:

- The Master Unit has been configured to go to OPERATE mode, if the PLC mode is set to RUN / MONITOR mode.
- All slave devices are powered up and initialized before the Master Unit is turned ON.
- All slave devices are assumed to go to I/O data exchange without delays.

The total system startup time is the sum of the following components:

- Master Unit startup checking.
- Initialization of communication with PLC CPU.
- Master Unit I/O configuration initialization, after which the Master Unit goes to OPERATE.
- One PROFIBUS DP cycle to request slave diagnostics.
- One PROFIBUS DP cycle to transmit parameter messages to all slave devices.
- One PROFIBUS DP cycle to transmit the I/O configuration messages to all slave devices.
- One PROFIBUS DP cycle to request slave diagnostics.

The average time for the first three actions - assuming a maximum I/O configuration - is approximately 2 seconds. The remaining time depends on the PROFIBUS settings.

For a maximum I/O configuration, with 125 slave devices, 56 words I/O each, (i.e. the total I/O size amounts up to 7000 words) one PROFIBUS DP cycle lasts approximately 70 ms. A complete start up cycle will then last approximately 280 ms.

The total system start up time, from Unit reset until I/O data exchange, will then be 2.3 seconds.

6-6 Operating the Network

6-6-1 User Access to the Network

There are several ways through which a user can have access to and control over the PROFIBUS network.

- Through a PLC user program
A PLC user program can set the operational mode of the Unit, send Global-Control commands, read Master and slave status / diagnostics information, and access the Unit's Error Log. Furthermore, the I/O data transferred between the PROFIBUS network and the PLC memory, and can be used by the user program.
- Through CX-Profibus
The CS1/CJ1W-PRM21 Master DTM Diagnosis User Interface provides the user with buttons to set the operational mode of the Unit, send Global-Control commands, read Master and slave status information, and access the Unit's Error Log.
- Through any other CX-Server based program, capable of accessing PLC memory areas and communicating through FINS messages, e.g. CX-Programmer, CX-Supervisor, etc.

This section will explore both means to control the CS1/CJ1W-PRM21 PROFIBUS Master Unit.

The CS1/CJ1W-PRM21 Master DTM Diagnosis User Interface provides the means to control the Master Unit directly from CX-Profibus, running on a PC.

Access to the Unit

For access to the Unit's controls, an online connection with the Unit has to be established first. To achieve this perform the following sequence.

- 1,2,3...**
1. To go on line, select the DTM in the Network view, and perform one of the following actions.
 - Select the **Device - Go Online** option from the main menu, or the DTM context menu, or
 - Select the  button from the Tool Bar.
 2. A communication channel will be opened through CX-Server. The name of the DTM in the Network view, will turn to Italic font, to indicate that the Unit is on-line.
 3. From the context menu, select the **Diagnosis** option. The DTM's Diagnostics User Interface will be displayed.
 4. Select the Online Operations tab, for the Units controls.

 **Caution** Controlling the CS1/CJ1W-PRM21 PROFIBUS Master Unit from the CS1/CJ1W-PRM21 Master DTM Diagnosis User Interface, may interfere with a PLC user program running at the same time. This can result in unexpected behaviour. It is recommended to change the PLC CPU mode to PROGRAM mode to avoid this interference, during the use of the CS1/CJ1W-PRM21 Master DTM Diagnosis User interface.

6-6-2 Changing PROFIBUS Mode of the Master Unit

PROFIBUS DP Network Modes

The PROFIBUS standard defines four different network modes, in which a Master Unit can operate. The modes are:

- OFFLINE
The PROFIBUS Master Unit does not access the network, nor does it respond to messages.
- STOP
The PROFIBUS Master Unit is on-line, but does not communicate with its slave devices. It does communicate with other Master Units, in that it passes the token message.
- CLEAR
The PROFIBUS Master Unit is on-line and communicates with its slave devices. It will parameterize all allocated slave devices, but only read their input data. The Master Unit does not send valid output data to the slave devices. Instead it will send empty output data messages or messages containing zeros.
- OPERATE
The PROFIBUS Master Unit is on-line and communicates with its slave devices. It will parameterize all allocated slave devices, and exchange all I/O data for which it has been configured.

Normal Operating Modes

The OPERATE mode is the mode used for normal network operation. The CLEAR mode is the mode used for situations which require a safety state to fall back to (see section 6-6-4 *Using Auto-CLEAR*).

Changing the Mode from the CS1/CJ1W-PRM21 Master DTM

In order to change the Unit's operational mode, open the CS1/CJ1W-PRM21 Master DTM Diagnosis User Interface. The figure below shows this Online Operations tab. Press the desired mode button in the upper left corner of the window.

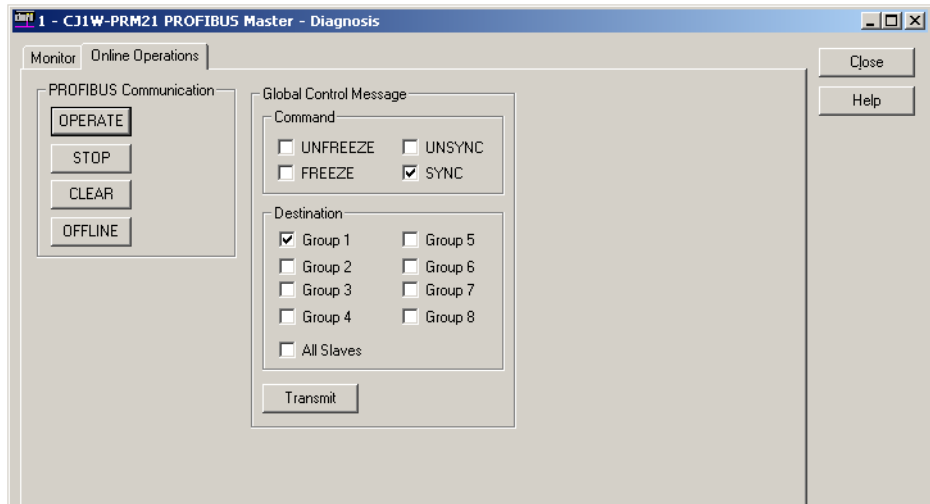

Example

In order to change the network to OPERATE mode, i.e. start I/O data exchange, press the **OPERATE** button. The OPERATE status of the Master Unit can be retrieved from the Monitor - Master status tab in the same user interface.

Changing the Mode Using the PLC Program

The Unit's operational mode can also be changed from the PLC user program, by setting the appropriate bit in the Software Switches 1 Word (CIO Word n, see section 4-2-1 *Software Switches 1 (Word n)*).

Example

Below is an example ladder program, which changes the operational mode to OPERATE, if the current mode is not OPERATE and non of the other mode switches are set. The unit number for the example Unit is 0.

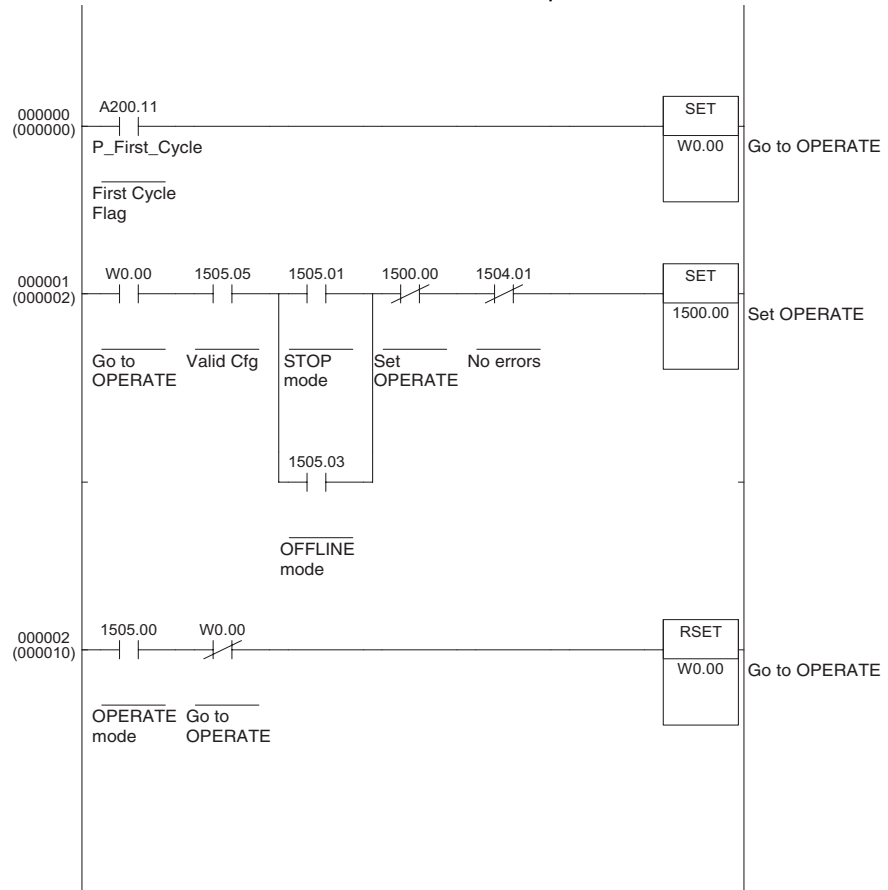

Note If an attempt is made to change the operational mode, while a previous change command is still being processed, the new command is ignored, and the Mode command error bit flag (bit 12) in the Master Status 2 word (CIO word n+6, see section 4-2-5 *Master Status 2 (Word n+6)*) will be set.

Indirect Mode Changes

The Unit's operational mode can also be changed in indirect ways, i.e. without direct user or program interference.

- Mode changes caused by Auto-CLEAR
When the Auto-CLEAR function has been enabled, and one or more of the slave devices on the network stop I/O data exchange, the Master Unit's operational mode will automatically change from OPERATE to CLEAR. This is discussed in section 6-6-4 *Using Auto-CLEAR*.
- Mode changes caused by PLC mode changes
An operational mode change will take place if the PROFIBUS Master Unit has been configured to change its operational mode together with the PLC mode, i.e. OPERATE when the PLC mode is set to RUN/MONITOR and CLEAR mode, when the PLC mode is changed to PROGRAM mode. Refer to section 6-4-1 *Setting the Master Parameters* for more information.

6-6-3 Transmitting Global-Control Commands

Global-Control commands	The CS1/CJ1W-PRM21 PROFIBUS Master Units support the transmission of Global-Control commands. These messages are unconfirmed broadcast messages (i.e. the slave devices do not send a response message), which can be used to synchronize I/O data related events two more slave devices.
I/O Data Synchronization	<p>Two types of synchronization can be achieved.</p> <ol style="list-style-type: none"> 1. Synchronization of input data The inputs on one or more slave devices are read at the same time. The synchronized data is transferred to the Master Unit during the next I/O data exchange cycle. The commands are defined as Freeze and Unfreeze. 2. Synchronization of output data The outputs on one or more slave devices are set at the same time. The synchronized data has been transferred to the slave devices during the previous I/O data exchange cycle. The commands are defined as Sync and Unsync. <p>Note</p> <ol style="list-style-type: none"> 1. The CS1/CJ1W-PRM21 PROFIBUS Master Unit also uses Global-Control commands to broadcast its own operational mode to other devices on the network. These Global-Control commands are sent automatically, without user interference <ul style="list-style-type: none"> • to all devices on the network (i.e. not to specific groups), • always at the start of every I/O data exchange cycle, and • only when the Master Unit is either in OPERATE or in CLEAR mode 2. The user can only initiate transmission of Freeze/Unfreeze and Sync/Unsync to either all slave devices or specific groups of slave devices. These Global-Control commands are transmitted separately from the automatically transmitted messages, at the end of the PROFIBUS I/O data exchange cycle.
Group Address Setting	User initiated Global-Control commands can be transmitted to either all slave devices allocated to a Master Unit, or to one or more of up to eight groups of slave devices. The group addresses are defined by up to eight bits in a group address byte, which is part of the Global-Control command.
	<p>Note If a Global-Control command is targeted to all slave devices, all the group bits in the group address bytes are set to 0.</p>
Setting the Group Address of a Slave Device	<p>In order for a specific slave device to belong to a certain group, the group assignment for the slave has to be defined through the Generic Slave DTM Configuration User Interface. A slave device can belong to one or more groups at the same time, or to no specific group at all. The group assignment is sent to the slave devices as part of the parameter message.</p> <p>To define the group assignment of a slave device, through the Generic Slave DTM, refer to section 6-3-3 <i>Selecting the Group Assignment</i>.</p>
Freeze / Unfreeze commands	<p>Sending a Global-Control - Freeze command to a slave device has the following effect</p> <ul style="list-style-type: none"> • The slave device will continue to read its physical inputs, but not send this data to the PROFIBUS Master Unit. • Instead, it will continue to transfer the input data to the Master Unit from the moment the Global-Control - Freeze command was received. • If a new Global-Control - Freeze command is sent, the slave device will update its PROFIBUS input buffers only once, with the most recent physi-

cal input data, and continue to transfer this data to the Master Unit with subsequent I/O data exchange messages.

- If a Global-Control - Unfreeze command is sent, the slave device will revert back to its original situation, and transfer updated input information to the Master Unit with subsequent I/O data exchange messages.

Note If a Global-Control command contains both a Freeze and an Unfreeze command, the Unfreeze will prevail.

The figure shown below illustrates the Freeze / Unfreeze feature as implemented by the CS1/CJ1W-PRM21 PROFIBUS Master Unit.

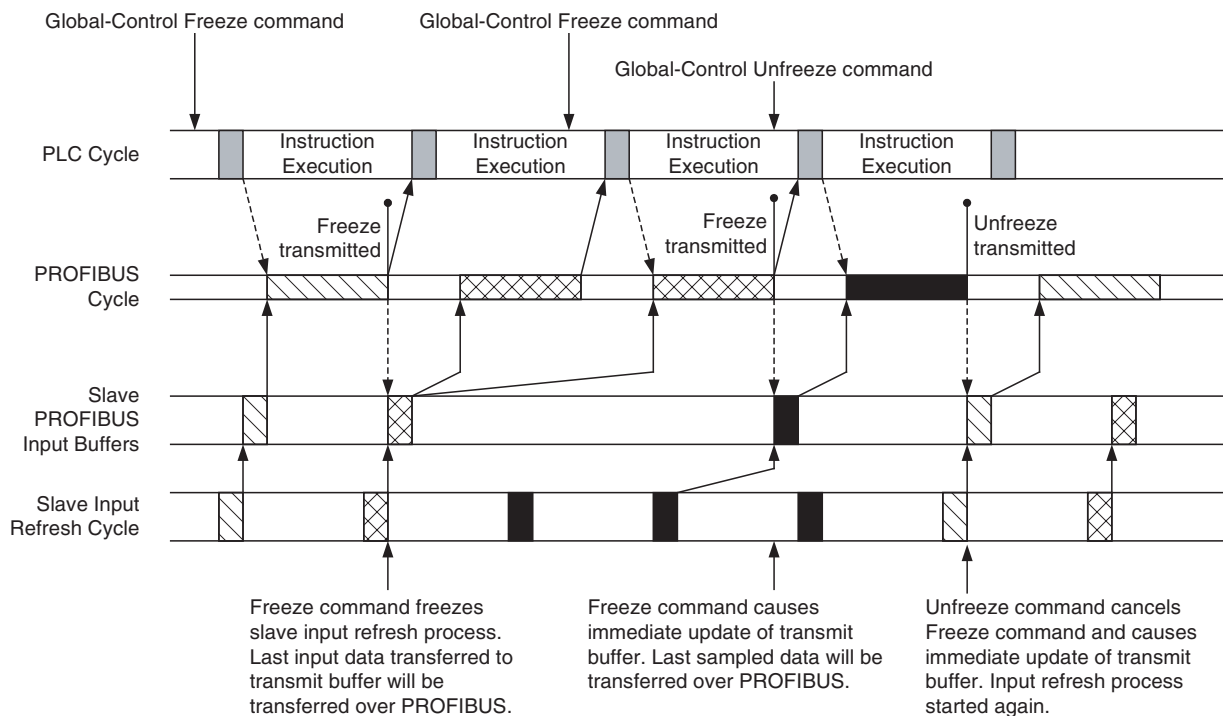

Note The Global-Control command as set in the CIO words is transferred to the Unit together with the I/O data, but the Global-Control command is sent over the PROFIBUS network, following the I/O data. The Freeze command forces an immediate update of the PROFIBUS transmission buffers in the slave device, with the last input value sampled. This input data is then transferred to the PROFIBUS Master Unit, with the next I/O data exchange cycle.

Sync / Unsync commands

Sending a Global-Control - Sync command to a slave device has the following effect

- The slave device will update its physical outputs only once with the last received PROFIBUS output data, despite new output data being received from the PROFIBUS Master Unit.
- If a new Global-Control - Sync command is sent, the slave device will update its physical outputs only once, with the most recent received output data.
- If a Global-Control - Unsync command is sent, the slave device will revert back to its original situation, and transfer updated output information to the Master Unit with each subsequent I/O data exchange message.

Note If a Global-Control command contains both a Sync and an Unsync command, the Unsync will prevail.

The figure shown below illustrates the Sync / Unsync feature as implemented by the CS1/CJ1W-PRM21 PROFIBUS Master Unit.

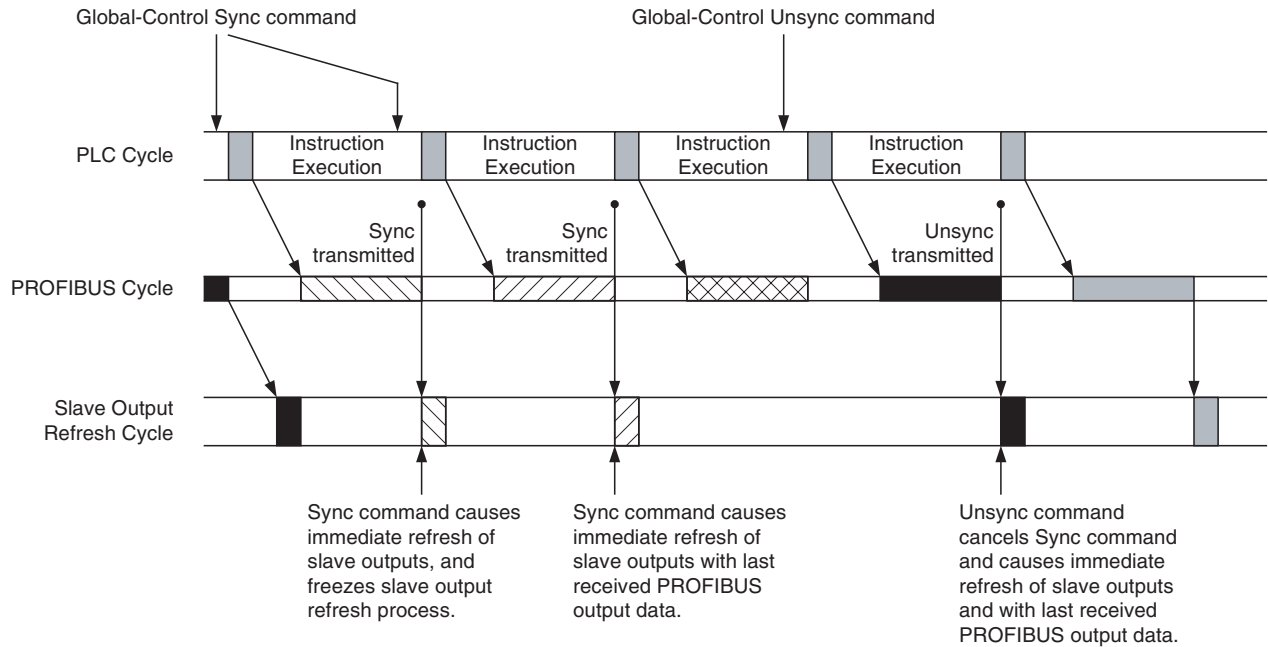

Note The Global-Control command as set in the CIO words is transferred to the Unit together with the I/O data, but the Global-Control command is sent over the PROFIBUS network, following the I/O data. This means that the outputs of the targeted slave device will be updated with the values sent to the slave prior to the Global-Control command.

Transmitting Global-Control Commands

In order to transmit a Global-Control command the user has to define the group address and the command (e.g. Freeze, Sync). These two parameters must be entered in Global-Control command word (CIO Word n+2, see section 4-2-2 *Global-Control Message (Word n+2)*).

After setting these parameters, the Global-Control command must be transmitted over the PROFIBUS network. This is accomplished by setting the Transmit Global-Control command bit (bit 04) in the Software Switches 1 word (CIO Word n, see section 4-2-1 *Software Switches 1 (Word n)*). Setting this bit will transmit the message only once. After transmission has been completed, bit 04 in the Software Switches 1 word will be reset again.

PLC User Program

Transmitting a Global-Control command from a PLC user program can be accomplished using the steps described above.

Example

Below is an example ladder program, which transmits one Global-Control - Freeze command to Group 2. The unit number for the example Unit is 0.

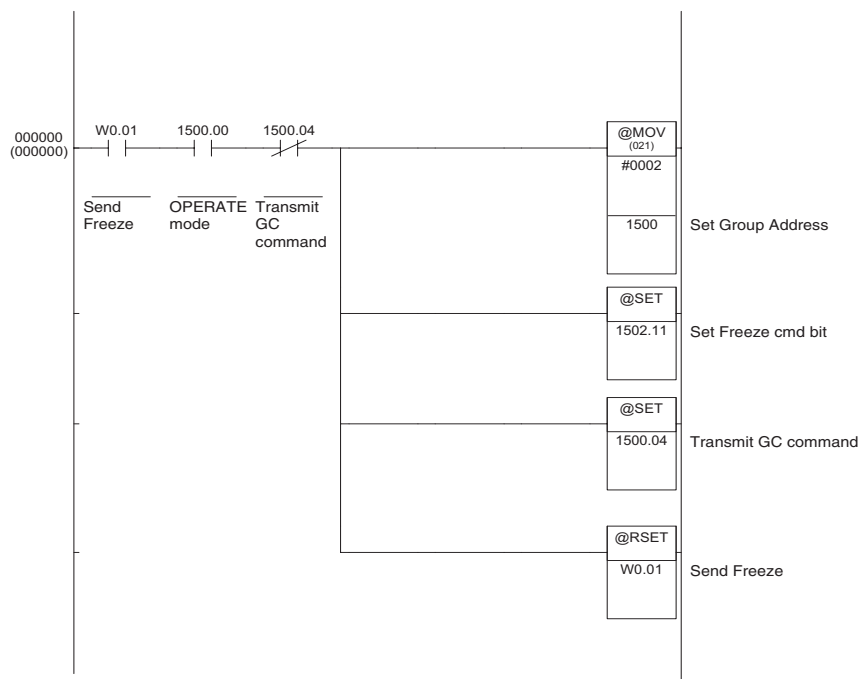

CX-Profibus

CX-Profibus also provides a means to transmit Global-Control commands from the PC, through the CS1/CJ1W-PRM21 Master DTM Diagnosis User Interface - Online Operations tab. This means uses the same CIO words as described above

To accomplish a Global-Control command transmission, per from the following sequence.

- 1,2,3...**
1. Make sure the CS1/CJ1W-PRM21 Master DTM is online with the PROFIBUS Master Unit.
 2. Open the CS1/CJ1W-PRM21 Master DTM Diagnosis User Interface.
 3. Select the Online Operations tab.
 4. Select the commands to be transmitted (e.g. Freeze, Sync) using the checkboxes.
 5. Select the groups to transmit the Global-Control command to.
 6. Press the **Transmit** button to transfer the command to the Unit's CIO area, and to set bit 04 in the Software Switches 1 word.
 7. The **Transmit** button will be disabled until the command has been transmitted.

Note The time between pressing the **Transmit** button in the CS1/CJ1W-PRM21 Master DTM user interface and the Global-Control command actually being transmitted over the PROFIBUS network, will be (much) longer than when the Global-Control command is initiated from a PLC user program, due to the additional communication between the PC and the PLC CPU.

6-6-4 Using Auto-CLEAR

Auto-CLEAR Feature	<p>The CS1/CJ1W-PRM21 PROFIBUS Master Units support the Auto-CLEAR function as defined in the PROFIBUS standard. This feature - when enabled - will switch the PROFIBUS Master Unit to CLEAR mode automatically, in case one of the slave devices fails on the network. The purpose of this, is to force the PROFIBUS network to a safe state.</p> <p>When in CLEAR mode, the PROFIBUS Master Unit will read each slave's input data, but not send output data. Depending on the slave device, the Master will instead send either empty output data messages or output data messages containing all zeros.</p>
Enabling Auto-CLEAR	<p>The Auto-CLEAR function can only be enabled through CX-Profibus. The controls to enable it can be found in the CS1/CJ1W-PRM21 Master DTM - Master Setup tab (see section 6-4-1 <i>Setting the Master Parameters</i>).</p>
	<p>Note The Auto-CLEAR function will only be active if the Master Unit has been switched to OPERATE mode.</p>
Transition Conditions	<p>An automatic transition to CLEAR mode will take place in the following situations.</p> <ol style="list-style-type: none"> 1. During network startup at least one slave device rejects its parameter or I/O configuration message or fails to respond. All slave devices which have already reached data exchange with the Master will be switched to CLEAR mode again. Also, slave device which remain in not ready state during a time period which exceeds the Data Control Time (See section 6-4-2 <i>Setting the Bus Parameters</i>), will cause the Master Unit to switch to CLEAR mode. 2. After successful network start up, there is no I/O data exchange with at least one slave device for a period of time which exceeds the Data Control Time.
	<p>Note</p> <ol style="list-style-type: none"> 1. Slave devices which have either been disabled in the Master Unit, or slave devices for which the Ignore Auto-CLEAR flag has been set (see section 3-5-1 <i>Configuration User Interface, Extensions Tab</i>), will not cause a transition to Auto-CLEAR, not even when they fail on the network. 2. In case a slave device requires more time than the Data Control Time to validate its parameter or configuration message, premature triggering of Auto-CLEAR can be avoided by increasing the Watchdog Control Time in the Bus parameter set (see 6-4-2 <i>Setting the Bus Parameters</i>). Increasing the Watchdog time will consequently increase the Data Control Time
Resume OPERATE mode after Auto-CLEAR	<p>The CS1/CJ1W-PRM21 PROFIBUS DP does not automatically resume normal operation after an Auto-CLEAR has been initiated. In order to resume normal I/O data exchange, perform the following sequence.</p>
1,2,3...	<ol style="list-style-type: none"> 1. Determine which slave device failed during network startup or data exchange. To do this, use the CS1/CJ1W-PRM21 Master DTM Monitoring User Interface or the slave DTM (see sections 6-7-1 <i>Monitoring the Master Unit and the Network</i> and 6-7-2 <i>Monitoring Slave Status</i>) to determine the slave and its type of failure. 2. Remove the cause of the failure. 3. Press the OPERATE Button in the Master Units Monitoring window. <p>Alternatively, the Master can also be switched to OPERATE from the PLC program.</p>

6-7 Monitoring the Network

6-7-1 Monitoring the Master Unit and the Network

Both the CS1/CJ1W-PRM21 Master DTM and the Generic Slave DTM provide special user interfaces to facilitate status debugging and diagnostics determination. This section and the next will discuss the use and the features of these diagnosis user interfaces.

CS1/CJ1W-PRM21 Master DTM Diagnosis User interface

The CS1/CJ1W-PRM21 Master DTM Diagnosis - Monitor User Interface provides a means to

- Monitor the CS1/CJ1W-PRM21 Master Unit status.
- Monitor an overview of the status of all allocated slave devices.
- Monitor standard slave diagnostics.
- Monitor the Unit's Error Log

The Error Log is discussed in section 6-7-3 *Using the Error Log*.

The information is obtained directly from the Master Unit, using FINS commands. The Master DTM reads the Unit's CIO words from the PLC memory, as well as the standard slave device diagnostics bytes as received by the Master Unit.

To open the CS1/CJ1W-PRM21 Master DTM Diagnosis - Monitor User Interface, perform the following steps.

1,2,3...

1. Make sure the Master DTM is online with the Master Unit. To go on line, select the DTM in the Network view, and perform one of the following actions.
 - Select the **Device - Go Online** option from the main menu, or the DTM context menu, or
 - Select the  button from the Tool Bar.
2. A communication channel will be opened through CX-Server. The name of the DTM in the Network view, will turn to Italic font, to indicate that the Unit is on-line.
3. From the context menu, select the **Diagnosis** option. The DTM's Diagnostics User Interface will be displayed.
4. Select the Monitor tab, for status monitoring.

Using Auto-Update or Manual Refresh

The information displayed in the CS1/CJ1W-PRM21 Master DTM Diagnosis - Monitor User Interface can be updated either Automatically or Manually.

- Automatic update
Select the Automatic checkbox in the upper right corner of the Monitor tab. The refresh cycle will be approximately 0.5 to 1 second, depending on the PC System. The Manual button will be disabled
- Manual update
Press the Manual button in the upper right corner of the Monitor tab, to force a refresh of the window contents.

Reading the Master Unit's Status

The Master status sub-tab displays the status of the Master Unit itself. The LED indicators are directly related to the four CIO status words of the Unit (see sections 4-2-3 to 4-2-6). They can be used to

- Obtain the status of the Master Unit and the network.
- Determine errors in the unit or the network.
- Troubleshoot the Master Unit and the network.

The Master Status 1 box indicates the Master Unit's status. The Master Status 2 box and the Unit Status box all indicate errors. These LED indicators are discussed in section 7-4-2 *Troubleshooting the Network using CX-Profibus*.

The Slave Status box indicates the overall status of the allocated slave devices.

Master Status 1

Main indicators in this box are the LED indicators for operational status of the Master Unit. They indicate whether the Master Unit is in

- OFFLINE mode,
- STOP mode,
- CLEAR mode, or in
- OPERATE mode

The Data Exchange LED indicates if I/O data exchange is taking place with at least one slave device.

The Auto Clear enabled LED and Valid Configuration LED provide feedback on the I/O configuration downloaded to the Unit.

Example

The figure below shows an example of the Master Status tab, in the case of a fully functional network, i.e. there are no errors and all slave devices are exchanging I/O data with the Master Unit.

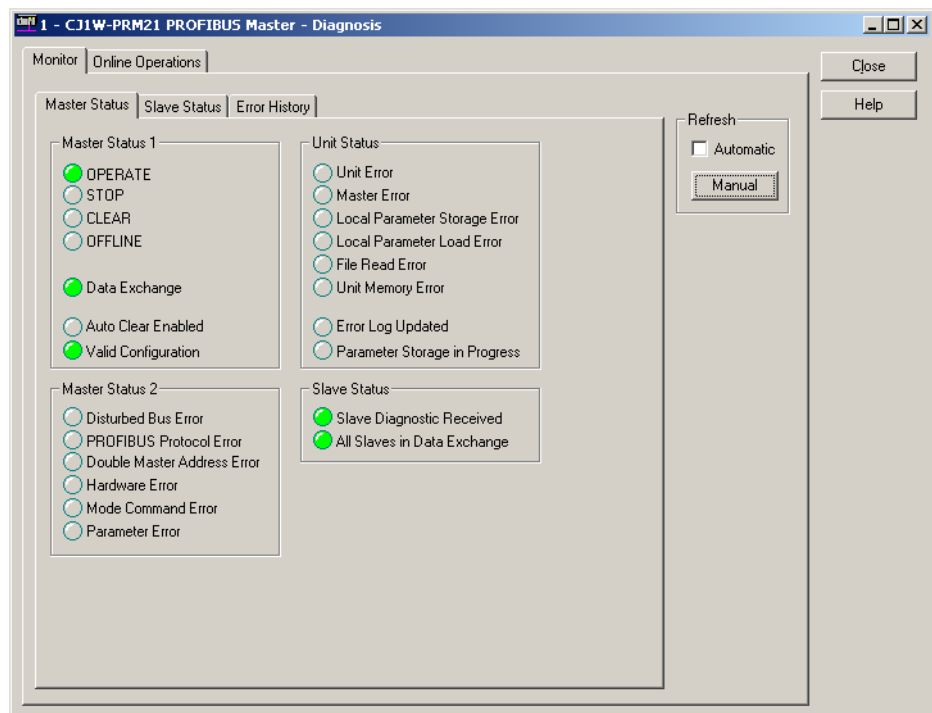

Slave Status

The Slave Diagnostics Received LED indicates if any of the allocated slave device have returned diagnostics information to the Master Unit. In order to determine which slave reported diagnostics, select the Slave Status tab next to the Master status tab.

Slave Status Overview

The CS1/CJ1W-PRM21 Master DTM Diagnosis User Interface provides a comprehensive overview of the slave device status, without having the user to open all the slave DTMs. The overview is presented in the Monitoring - Slave Status tab of the user interface, and displays only the standard PROFIBUS

diagnostics flags. An example is shown in the figure below. For the extended, non-standard diagnostics see section 6-7-2 *Monitoring Slave Status*.

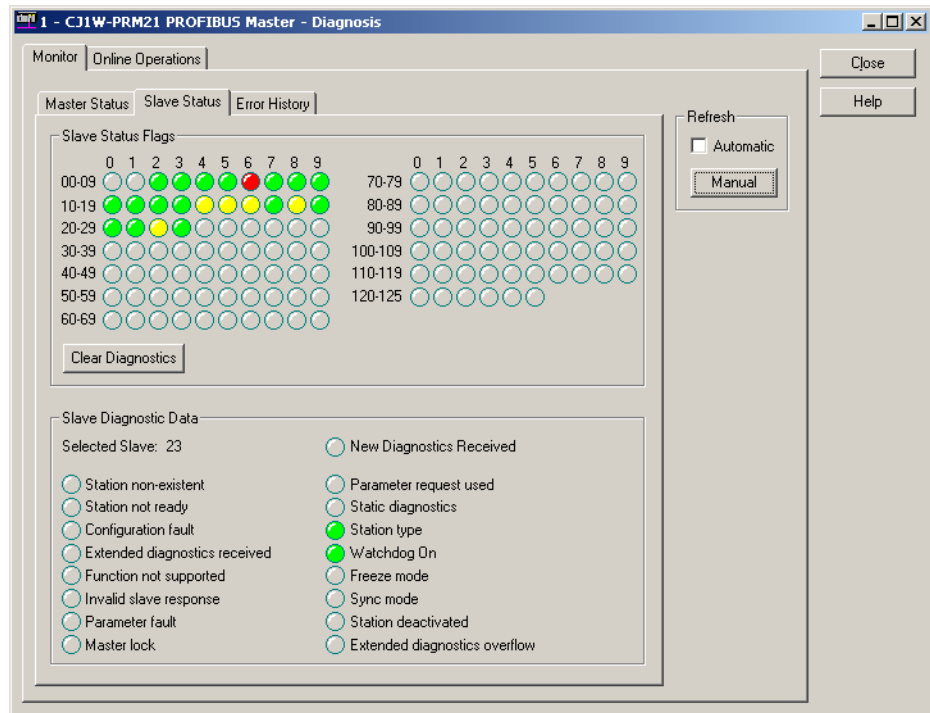

The upper half of the window - the Slave Status Flags box - presents the status of each slave device using coloured LED indicators. The colours are listed in the table below.

Indicator Colour	Slave Status
Grey	Associated device does not exchange Diagnostics with this Master Unit, i.e. <ul style="list-style-type: none"> Slave not allocated to this Master Unit, or Device is this Master Unit, or Device is another master device. Example figure: Slave device 0 is not allocated.
Red	The slave device is not communicating with the PROFIBUS Master Unit. It may be disconnected, or the Master is in OFFLINE or STOP mode. Example figure: Slave device 6 is not responding.
Orange	The slave device is communicating with the PROFIBUS Master Unit, but it is not in Data Exchange, due to incorrect parameter settings. See the slave diagnostics for more information.
Yellow	The slave device is in data exchange with the PROFIBUS Master Unit, but it has reported diagnostics data. See the slave diagnostics for more information. Example figure: Slave device 14 has returned diagnostics.
Green	The slave device is in data exchange with the PROFIBUS Master Unit. No diagnostics reported. Example figure: Slave device 2 is in I/O data exchange.

Any other colour than green or grey, indicates that new diagnostics have been received from the associated slave device, since the last time the diagnostics was monitored.

The newly received diagnostics can be viewed, by clicking with the left mouse button on the LED indicator, indicating diagnostics. The mouse pointer will change in to a hand icon, when positioned over the LED indicator.

Reading Standard Slave Diagnostics

Clicking the LED indicator with the left mouse button has the following effects

- The address of the associated slave device will be displayed in the Slave Diagnostics Data box in the lower half of the window.
- The standard diagnostics flags of the associated slave device will be displayed. LED indicators representing a status are coloured green, LED indicators representing a potential problem are coloured red.
- The colour of the LED indicator for the specific slave device in the Slave Status Flags box will change colour, if no new diagnostics is available, i.e. a yellow LED will turn to green.
- The New Diagnostics Received LED indicator in the Slave Diagnostics Data box will be set to ON.

Note If the Auto-Update refresh mode has been selected, the New Diagnostics Received LED indicator, will be ON only during one update cycle, provided no new diagnostics are received after displaying.

The standard diagnostics for a slave device displayed in the Slave Diagnostics Data box can be used to

- Troubleshoot the device, the configuration or the network connection
Troubleshooting the device and the connection is discussed in section 7-4-2 *Troubleshooting the Network using CX-Profibus*.
- Determine the status of the slave device
- Determine if the slave device has reported extended diagnostics
If extended diagnostics have been reported to the Master Unit, the Extended diagnostics received LED indicator will be on.

Refer to section 7-4-2 *Troubleshooting the Network using CX-Profibus* for a discussion on the errors reported by the slave and how to correct them.

Clearing Diagnostics Flags

Since all slave devices will have to return their status in the diagnostics message after parameterization, all the LED indicators associated with the slave devices allocated to the Master Unit, will indicate received diagnostics right after network startup.

If all slave devices have established I/O data exchange with the Master Unit, this information may be less relevant. To detect new diagnostics, received during I/O data exchange, the user can clear all current new diagnostics flags by pressing the **Clear Diagnostics** button in the window, thus making it easy to spot newly received, more relevant diagnostics afterwards.

Note Pressing **Clear Diagnostics** button will cause all yellow LED indicators to turn green.

6-7-2 Monitoring Slave Status

The Generic Slave DTM provides a Diagnosis User Interface with two tabs:

- Standard diagnostics tab, displaying the same information for the associated slave device as in the Slave Diagnostics Data box in the Master DTM Monitoring User Interface.
- The Extended Diagnostics tab, displaying the extended diagnostics reported by the slave device. The interpretation of this diagnostics information depends on the type of slave device.

Standard Slave Diagnostics Example

As an example, the standard slave device diagnostics information window is shown below. For more information regarding interpretation of the LED indicators, refer to section 6-7-1 *Monitoring the Master Unit and the Network*.

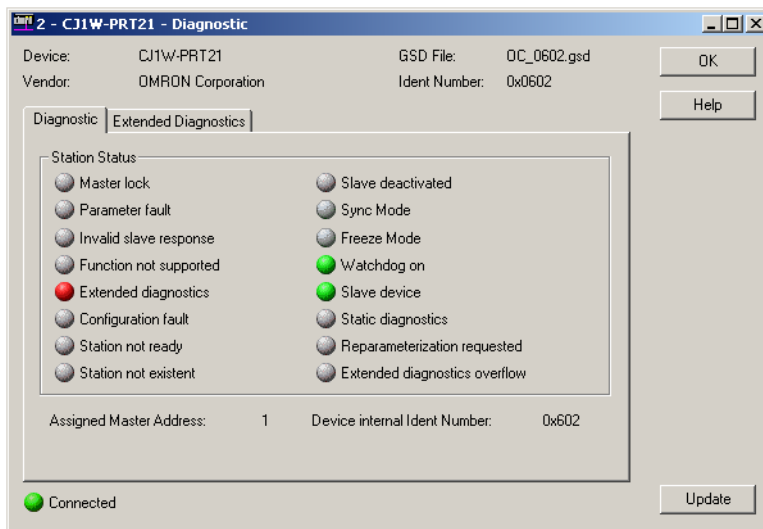

Extended Slave Diagnostics

Extended diagnostics data are often - not always - provided by a slave device to indicate additional slave specific diagnostics, error and alarm information, which can not be contained in the standard data part of the diagnostics message. These extended diagnostics data bytes are sent by the slave in a diagnostics message following the standard data part.

For slave devices supporting extended diagnostics data, the associated GSD files often - again, not always - provide language dependent text strings to facilitate interpretation of the diagnostics codes, sent by the slave device.

The Generic Slave DTM provides an easy to use interface, which facilitates the displaying of such extended diagnostics data strings.

The presence of extended diagnostics as part of the diagnostics data message, is indicated by

- the LED indicator marked Extended Diagnostics received in the Master DTM - Monitor tab, Slave Status tab (refer to section 6-7-1 *Monitoring the Master Unit and the Network*).
- the LED indicator in the Diagnostics tab of the slave Diagnostics User Interface (see for example, the figure above).

Also, if no extended diagnostics are available, the Extended Diagnostics tab will be disabled, and inaccessible.

To display the extended diagnostics, click on the Extended diagnostics tab in the Slave Diagnostics User Interface.

Example

The figure below shows an example of the extended diagnostics window, containing extended diagnostics data. The first row in the diagnostics window shows the raw data bytes, the second and third row show the actual message contained within the extended diagnostics message.

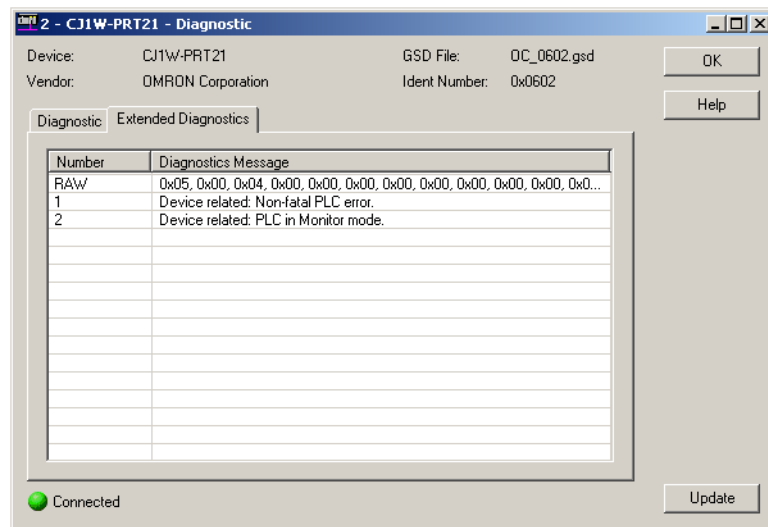

6-7-3 Using the Error Log

Error Log Concept

The CS1/CJ1W-PRM21 PROFIBUS Master Units are equipped with an error logging mechanism, which will internally store error events. Most of the errors, which are stored in the Unit's Error Log are stored in volatile memory, i.e. when power to the Unit is switched off, the errors are lost.

Severe errors however, are also stored in non-volatile memory, i.e. these error reports are still available after cycling the power down and up again. The errors which can be logged are listed in section 7-5-2 *Error Codes*.

The CS1/CJ1W-PRM21 PROFIBUS Master Units can log up to 80 error events, 16 of which can be logged in non-volatile memory.

Detecting New Errors in the Error Log

If a new error event is logged in the Error Log of the Unit, a bit flag 03 is set in the Units Status Word (CIO word n+4, see section 4-2-3 *Unit Status (Word n+4)*).

This bit flag can be evaluated by the user, through the CS1/CJ1W-PRM21 Master DTM Diagnosis User Interface. In order to view the bit flag, perform the following actions.

- 1,2,3... 1. Open the CS1/CJ1W-PRM21 Master DTM Diagnosis User Interface,
2. Select the Monitor - Master Status tab
3. If the Automatic checkbox in the Refresh box has not been selected, press the **Manual** button to refresh the status.

The figure below shows as an example this Error Log Updated bit flag, indicating that a new error event has been logged.

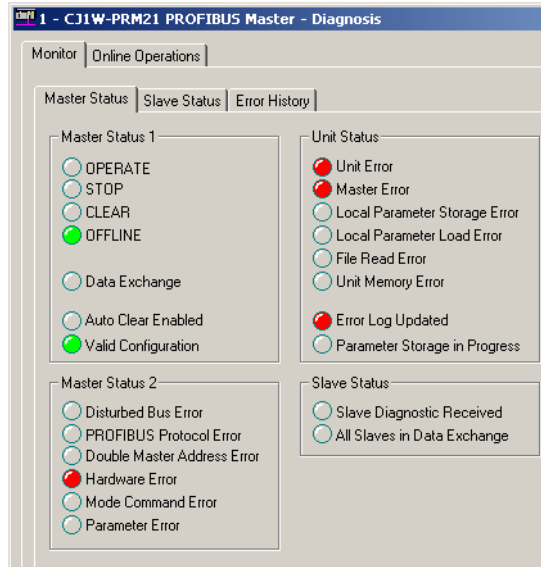

Reading the Error Log

The Error Log can now be retrieved from the Unit, and displayed through the CS1/CJ1W-PRM21 Master DTM Diagnosis User Interface. To retrieve and view the Unit's Error Log,

1,2,3...

1. Open the CS1/CJ1W-PRM21 Master DTM Diagnosis User Interface.
2. Select the Monitor - Error History Tab tab.
3. If the Automatic checkbox in the Refresh box has not been selected, press the **Manual** button to retrieve the Error Log contents from the Unit.

As an example, the contents of the Error Log as it is displayed is shown in the figure below. In this case a Hardware Error has been detected on the PROFIBUS network.

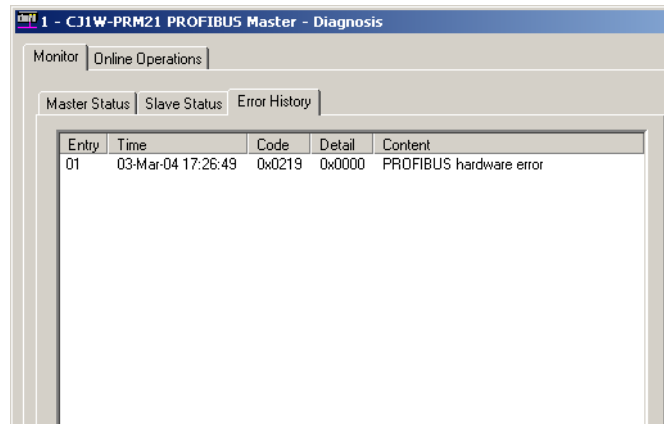

Note Reading the Error Log contents will not clear it.

Clearing the Error Log

In order to clear the Error Log, perform the following actions.

1,2,3...

1. Open the CS1/CJ1W-PRM21 Master DTM Diagnosis User Interface.
2. Select the Monitor - Error History Tab tab.
3. Press the **Clear** button in the lower right corner of the window.

This will clear not only the Error Log stored in volatile memory, but also the error log events stored in the non-volatile memory.

Note Clearing the Error Log is not possible, if an error, which was just added to the Error Log is still active. The cause of the active error has to be removed first before the Error Log can be cleared. Attempting to clear the Error Log, while an error is still active, does not result in an Error message from the CS1/CJ1W-PRM21 Master DTM.

Accessing the Error Log from the PLC CPU

The CS1/CJ1W-PRM21 Master DTM Diagnosis User Interface uses FINS messages to read the CIO bit flags and access/clear the Error Log contents. A user program running in the PLC CPU can use these same means to detect new errors in the Error Log as well as read and clear them. Refer to sections 5-2-5 *ERROR LOG READ (2102)* and 5-2-6 *ERROR LOG CLEAR (0203)* for details on FINS commands.

6-8 PROFIBUS DP-V1 Services

Next to the cyclic I/O data exchange, the CS1/CJ1W-PRM21 PROFIBUS Master Units are capable of communicating using acyclic DP-V1 messages. The following section explains the basic operation of DP-V1 functionality.

6-8-1 Configuring and Monitoring Slaves using DTMs

The FDT/DTM framework enables the configuration and monitoring of specific parameters of PROFIBUS slaves. The DTMs support sending PROFIBUS DP-V1 Class 1 (MSAC1) and Class 2 (MSAC2) messages directly to the slaves. The slave DTMs, provided by the Slave's manufacturer, can therefore perform application related configuration and monitoring.

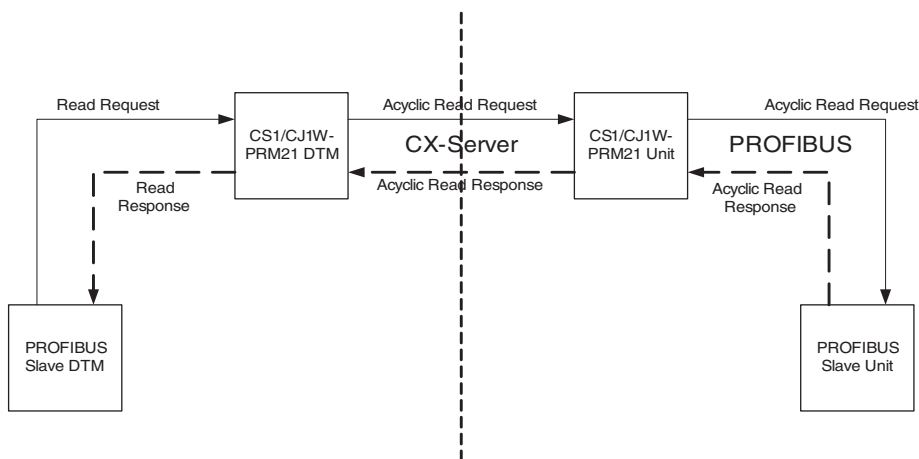

Note The CS1/CJ1W-PRM21 master (communication) DTM will determine which connection is initiated with the slave Unit. The default connection is PROFIBUS DP-V1 Class 2. If this is not supported by the slave, PROFIBUS DP-V1 Class 1 messages will be send.

Caution Since using PROFIBUS DP-V1 Class 2 messages are by definition aimed at setting parameters in a slave device, it is highly recommended to make those settings with the PROFIBUS Master Unit in CLEAR mode, to prevent undesirable effects on I/O data.

As an example, the figure below shows the DTM of the GRT1-PRT PROFIBUS Communication for SmartSlice I/O Units (see Operation Manual W04E-EN-□). The DTM is used to configure and monitor the GRT1-Series Smart-Slice I/O Units.

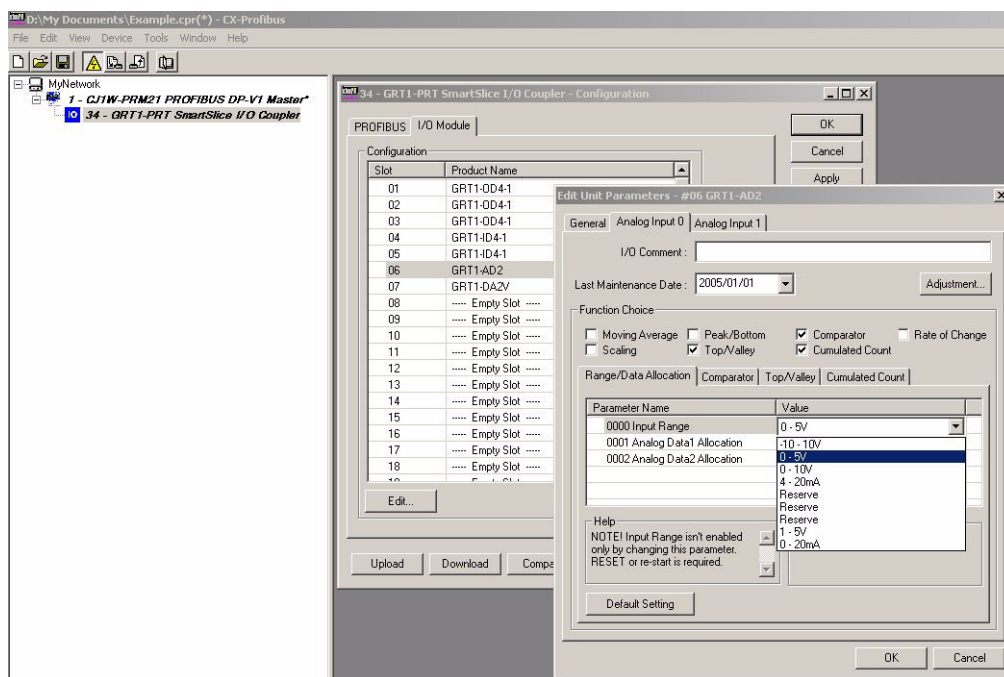

6-8-2 PROFIBUS Services from PLC CPU

CIP Messaging

The CS1/CJ1W-PRM21 PROFIBUS Master Units support sending Explicit DeviceNet (CIP) messages to their slaves (as of Unit version 3.0). Like the DeviceNet master this is done by using the EXPLICIT MESSAGE SEND (FINS 2801).

Please refer to section 5-2-7 *EXPLICIT MESSAGE SEND (2801)* for more details on this command.

PROFIBUS MSAC1

As of Unit version 2.0, the CS1/CJ1W-PRM21 PROFIBUS Master units provide a means to initiate PROFIBUS DP-V1 services from the PLC CPU. These services allow for reading and writing (parameter) data from and to PROFIBUS DP-V1 slave devices. This data exchange is performed acyclically, i.e. only once, in between the cyclic I/O data exchange messages.

The services are initiated using the PROFIBUS MESSAGE SEND FINS command (see section 5-2-8 *PROFIBUS MESSAGE SEND (2809)*). The example below shows a ladder program initiating a PROFIBUS DP-V1 MSAC1_Read service to retrieve data from a slave device.

Example

In the example below, a PROFIBUS DP-V1 MSAC1_Read service is sent to PROFIBUS DP-V1 slave device at address 2, requesting up to 10 data bytes

from slot number 1 (first I/O module), and index 0. The service is processed successfully and the device returns 4 data bytes.

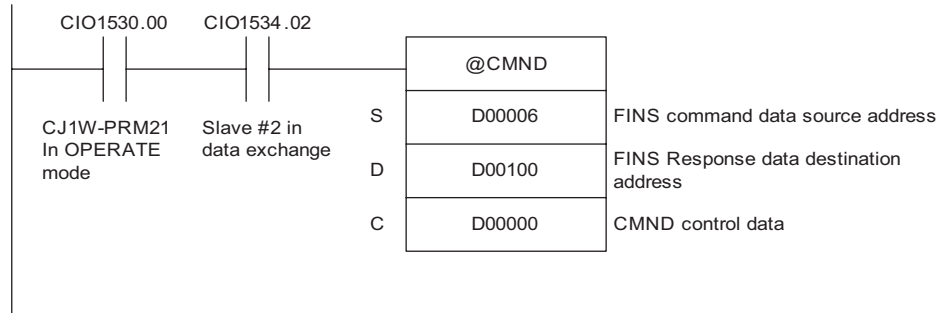

	15	8	7	0		
S:	D00006	2	8	0	9	Command code : 2809 (Hex) PROFIBUS MESSAGE SEND Slave device #2, Device Service Access Point: 33 Function code: 005E (Hex) Slot number: 1, Index: 0 Requested data length : 10 bytes
S + 1:	D00007	0	2	3	3	
S + 2:	D00008	0	0	5	E	
S + 3:	D00009	0	1	0	0	
S + 4:	D00010	0	0	0	A	

	15	8	7	0		
D:	D00100	2	8	0	9	Command code : 2809 (Hex) PROFIBUS MESSAGE SEND Response code: Normal completion Function code: 005E (Hex) Actual data length : 4 bytes } Data
D + 1:	D00101	0	0	0	0	
D + 2:	D00102	0	0	5	E	
D + 3:	D00103	0	0	0	4	
D + 4:	D00104	0	0	0	0	
D + 5:	D00105	0	0	0	0	

	15	8	7	0		
C:	D00000	0	0	0	A	Number of command data bytes : 000A (Hex), 10 bytes Number of response data bytes : 0012 (Hex), 18 bytes Destination address : 0000 (Hex): Local network 0011 (Hex): PRM21 Unit number Retries, ports Monitoring timeout : 2 sec (default)
C + 1:	D00001	0	0	1	2	
C + 2:	D00002	0	0	5	E	
C + 3:	D00003	0	0	1	1	
C + 4:	D00004	0	0	0	0	
C + 5:	D00005	0	0	0	0	

SECTION 7

Troubleshooting and Maintenance

This section describes the troubleshooting procedures and maintenance operations for the CS1/CJ1W-PRM21, needed to keep the PROFIBUS network optimally working.

7-1	Overview	202
7-2	Troubleshooting Using LED Indicators	203
7-2-1	LED Indicators	203
7-2-2	Unit Start-up Errors	203
7-2-3	Unit Operational Errors	205
7-2-4	Unit Configuration Errors	206
7-2-5	Network Errors	207
7-3	Troubleshooting Using Error Status	209
7-3-1	Unit Status Word	209
7-3-2	Master Status 2 Word	210
7-4	Troubleshooting the Network	212
7-4-1	Troubleshooting Parameter Download	212
7-4-2	Troubleshooting the Network using CX-Profibus	213
7-4-3	Troubleshooting I/O Communication	218
7-4-4	Troubleshooting PROFIBUS DP-V1 Communication	221
7-5	Troubleshooting Using the Error Log	222
7-5-1	Error Log Overview	222
7-5-2	Error Codes	223
7-6	Troubleshooting FINS Commands	225
7-7	Maintenance	226
7-7-1	Cleaning	226
7-7-2	Inspection	226
7-8	Replacing the Unit	227
7-8-1	Replacement Precautions	227
7-8-2	Setting the Unit after Replacement	227
7-8-3	Addition/Replacement of Units on the PROFIBUS Network	227

7-1 Overview

The CS1/CJ1W-PRM21 PROFIBUS Master Unit and the Configuration software package provides extensive means for troubleshooting, which can be used to quickly determine errors in the Unit, in the configuration, in the network, and/or in remote slave devices, allocated to the Unit.

Troubleshooting on the Master Unit

For troubleshooting purposes, the following error indicators can be used:

- LED indicators on the front of the Unit
Three red error LED indicators and four status LED indicators show Unit and network status and errors.
- CIO Words
Unit Status (CIO Word $n + 4$) containing status and error flags of the Unit, and Master Status 2 (CIO Word $n+6$) containing error information about the PROFIBUS network and the PROFIBUS functions of the Unit.
- The Error Log collects error codes for various error events. Serious errors are stored in non-volatile memory and can be retrieved, even after a Unit power down.
- FINS command provide defined response codes, which can indicate specific errors.

Note $n = \text{CIO } 1500 + (25 \times \text{unit number})$.

This section provides a number of procedures for troubleshooting, based on the error indicators listed above.

Troubleshooting the Configuration Software

The Configuration software, i.e. CX-Profibus, the PROFIBUS Master DTM and the Generic Slave DTM provide several mechanisms for error detection and correction:

- Errors occurring in CX-Profibus are displayed in pop-up message windows and/or the error log window. The contents of the error log window can be copied to the clipboard to allow analysis afterwards.
- CX-Profibus provides a FDT communication log window, which can be copied to the clipboard. Analysis of this communication may provide additional information in case errors occur.

Troubleshooting the network

The PROFIBUS Master DTM and the Generic Slave DTM diagnostics information windows, which can display:

- Indications of errors in the PROFIBUS interface of the Unit
- Indications of errors in the communication between the PROFIBUS Master Unit and remote slave devices.
- Indications of errors in the remote slave devices, allocated to the PROFIBUS Master Unit.

The CX-Profibus and DTM capabilities for troubleshooting are extensively discussed in *SECTION 6 Operation*.

7-2 Troubleshooting Using LED Indicators

7-2-1 LED Indicators

This section presents a number of easy to use procedures to troubleshoot possible errors using the LED indicators on the front of the Unit (see figure below).

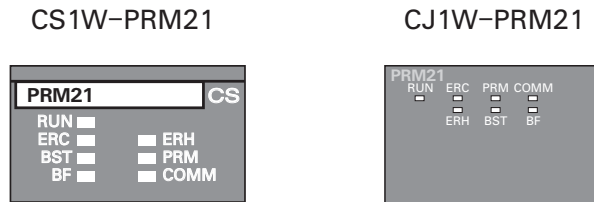

The possible errors which could occur have been categorized and for each category a group of two or three LED indicators can be used to troubleshoot the problem:

- Unit start-up errors
These include errors in the PLC CPU, as well as errors in the Unit, which prevents the combination from starting up correctly. Use RUN, ERC, and ERH indicators to troubleshoot the errors.
- Operational errors
These include PLC errors, PLC Bus errors, and error log problems, all during operations. Use RUN, ERC, and ERH indicators to troubleshoot the errors.
- Configuration problems
These include errors during or after downloading a new configuration as well as errors in the configuration after startup. Use ERC and PRM indicators to troubleshoot the errors.
- I/O data communication errors
These include errors in the PROFIBUS interface or on the network. Use BST, COMM and BF indicators to troubleshoot.

7-2-2 Unit Start-up Errors

Unit start-up errors are errors which occur at starting up the system and which prevent the Unit from functioning correctly in the PLC system. Usually these errors also cause the CS/CJ PLC CPU ERR/ALM indicator to be lit or flashing. For more information on error indications in the PLC, refer to the *CS1 Series CPU Unit Operation Manual (W339)* or the *CJ Series CPU Unit Operation Manual (W393)* for more details.

The error determination procedure uses the table below. To determine the error

- First find the status of the RUN LED indicator (left column).
- Move one column to the right and find the ERH LED indicator status.
- Move one column to the right and find the ERC LED indicator status.

The probable error causes are then listed to the right of the third column.

Unit Start up Errors

RUN	ERH	ERC	Probable cause	Correction		
Not lit	Not lit	Not lit	Power is not being supplied to the CPU Unit or the power supply voltage is too low.	Supply power. Make sure that the correct voltage is being supplied.		
			The CPU Unit or Backplane is faulty.	Replace the CPU Unit or the Backplane.		
			The mounting screws on the PROFIBUS Master Unit are loose (CS Series) or the sliders are not properly locked into place (CJ Series).	Tighten the mounting screws to the specified torque (CS Series) or lock the sliders into place (CJ Series).		
			The PROFIBUS Master Unit is faulty.	Replace the PROFIBUS Master Unit.		
	Lit	Not lit	Lit	The PROFIBUS Master Unit is faulty (COMM LED indicator is also flashing).	Replace the PROFIBUS Master Unit.	
				The I/O tables are not registered in the CPU Unit.	Register the I/O tables.	
				The same unit number is being used on another Unit as well.	Correct the unit number. Make sure that all unit numbers used in the system are unique.	
				The PLC CPU Unit is faulty.	Restart the CPU Unit. If the problem persists, replace the CPU Unit.	
		Lit	Not lit	Lit	Not a valid combination at startup.	
					Unit is functionally correct. If there are still problems, check on the other LED indicators.	
Lit	Not lit	Not lit	Unit is functionally correct. If there are still problems, check on the other LED indicators.			
			Lit	During startup the checksum of the Error Log stored in non-volatile memory was found to be corrupted.	Send a ERROR LOG CLEAR FINS command to the Unit. Restart the Unit.	
				During startup the checksum of the Parameter sets stored in non-volatile memory was found to be corrupted.	Re-download the Parameter sets from CX-Profibus or the Memory Card. If the problem persists, replace the PROFIBUS Master Unit.	
		During startup the Parameter set stored in non-volatile memory was correct, but the contents contains errors preventing the PROFIBUS interface to be initialized correctly.		Check the Parameter set in CX-Profibus and re-download the Parameter sets from CX-Profibus. If the problem persists, replace the PROFIBUS Master Unit.		
		Lit	---	---	There is an error in the CPU Bus Unit Setup or routing tables.	Read the error history and correct the data that is causing the error. If the problem persists, replace the CPU Unit.
					Memory in the CPU Unit is faulty.	Restart the CPU Unit. If the problem persists, replace the CPU Unit.
	The CPU Unit is faulty.				Restart the CPU Unit. If the problem persists, replace the CPU Unit.	
	A Fatal error occurred in the PLC system.				Verify that the PLC CPU and all Units are working correctly. Restart the CPU Unit. If the problem persists, replace the CPU Unit.	

Note If startup errors prevent the Unit from functioning correctly, the PRM, BST and BF LED indicators will remain OFF.

7-2-3 Unit Operational Errors

Unit Operational errors are errors which can occur during normal operation, i.e. after normal startup.

The error determination procedure uses the table below. To determine the error, first find the status of the RUN LED indicator (left column). Then move one column to the right and find the status of the ERH LED indicator. Then move again one column to the right and find the status of the ERC LED indicator. The probable error causes are listed to the right of the third column.

Unit Operational Errors.

RUN	ERH	ERC	Probable cause	Correction
Not lit	Not lit	Not lit	Power is not being supplied to the CPU Unit or the power supply voltage is too low.	Supply power. Make sure that the correct voltage is being supplied.
			The CPU Unit or Backplane is faulty.	Replace the CPU Unit or the Backplane.
			The mounting screws on the PROFIBUS Master Unit are loose (CS Series) or the sliders are not properly locked into place (CJ Series).	Tighten the mounting screws to the specified torque (CS Series) or lock the sliders into place (CJ Series).
			A fatal error has occurred in the Unit, preventing it from running any program.	Restart the CPU Unit. If the problem persists, replace the PROFIBUS Master Unit.
		Lit	A fatal error has occurred in the Unit's program. The appropriate error code is stored in the error log.error	Restart the CPU Unit. If the problem persists, replace the PROFIBUS Master Unit.
		Lit	Not lit	Not a valid combination during operation.
	Lit	Not a valid combination during operation.		
Lit	Not lit	Not lit	Unit is functionally correct. If there are still problems, proceed to check on the other LED indicators.	
		Lit	A write-verify check failed, while writing the error log to the non-volatile memory.	Send a ERROR LOG CLEAR FINS command to the Unit. Restart the Unit.
		Lit	A write-verify check failed, while writing the (new) configuration to the non-volatile memory.	Check the Parameter set in CX-Profibus and re-download the Parameter sets from CX-Profibus. If the problem persists, replace the PROFIBUS Master Unit.
	Lit	Not Lit	Memory in the CPU Unit is faulty.	Restart the CPU Unit. If the problem persists, replace the CPU Unit.
			The CPU Unit is faulty.	Restart the CPU Unit. If the problem persists, replace the CPU Unit.
			A cyclic Monitor time out has occurred, i.e a timeout on exchange of data between the Unit and the PLC CPU.	Restart the CPU Unit. If the problem persists, replace the PROFIBUS Master Unit.
		Lit	Not a valid combination during operation.	

Note If operational errors prevent the Unit from functioning correctly, the PRM, BST, COMM and BF LED indicators will remain OFF.

7-2-4 Unit Configuration Errors

Unit configuration errors are errors which occur during download of the new configuration, or after restarting the Unit, following a download. The error can be determined by examining the ERC and the PRM LED indicators.

The error determination procedure uses the table below. To determine the error

- First find the status of the ERC LED indicator (left column).
- Move one column to the right and find the PRM LED indicator status.

The probable error causes are then listed to the right of the third column.

Unit Configuration Errors

ERC	PRM	Probable cause	Correction
Not Lit	Not Lit	Not a valid combination.	
	Lit	No errors. The PROFIBUS DP Parameter set is ready for use.	
	Flashing	No errors. A new configuration is being downloaded from the configurator or from the Memory Card.	
Lit	Not Lit	An error has occurred while writing the Parameter sets to the non-volatile memory.	Re-download the Parameter sets from CX-Profibus or the Memory Card. If the problem persists, replace the PROFIBUS Master Unit.
		During startup the checksum of the Parameter sets stored in non-volatile memory was found to be corrupted.	Re-download the Parameter sets from CX-Profibus or the Memory Card. If the problem persists, replace the PROFIBUS Master Unit.
		During startup the Parameter set stored in non-volatile memory was correct, but the contents contains errors preventing the PROFIBUS interface to be initialized correctly.	Check the Parameter set in CX-Profibus and re-download the Parameter sets from CX-Profibus. If the problem persists, replace the PROFIBUS Master Unit.
	Lit	Not a valid combination.	

- Note**
1. The table above assumes that the RUN LED indicator is ON and the ERH indicator is OFF. Otherwise, refer to section 7-2-2 *Unit Start-up Errors*, or section 7-2-3 *Unit Operational Errors*.
 2. If the PRM LED indicator is OFF or Flashing, the BST, COMM and BF LED indicators remain OFF.

7-2-5 Network Errors

Network errors are errors which occur when attempting to startup a network, i.e. the PROFIBUS Master Unit has been switched to CLEAR or OPERATE mode. The Unit will parameterize the slave devices and start data exchange. An error in this process can be determined by examining the BST, COMM and BF LED indicators.

The error determination procedure uses the table below. To determine the error

- First find the status of the BST LED indicator (left column).
- Move one column to the right and find the COMM LED indicator status.
- Move one column to the right and find the BF LED indicator status.

The probable error causes are then listed to the right of the third column.

Network Errors

BST	COMM	BF	Probable cause	Correction	
Not lit	Not lit	Not lit	The PROFIBUS Master Unit is in OFFLINE or STOP mode. No communication over the network.	Switch the Unit to either CLEAR or OPERATE mode.	
		Lit	A hardware error has occurred in the PROFIBUS interface of the Unit, or a master device has been detected beyond the Highest Station Address. The Unit has switched to OFFLINE. This indicates faulty wiring, broken message, short-circuits, faulty bus timings, or an active device has been detected beyond the Highest Station Address setting (HSA).	<ul style="list-style-type: none"> • Check the network wiring, and make sure it is correct (not too long, long stub lines, etc.) • Check for short-circuits. • Check the bus timing set in CX-Profibus. • Check the HSA setting in the DTM's Bus Parameter tab. Set it to the highest master address which is on the network. • Check if any other faulty devices are on the same network. • Switch the Unit to CLEAR / OPERATE mode again. 	
			A protocol error has occurred in the PROFIBUS interface of the Unit, the Unit has switched to OFFLINE. This indicates lost tokens.	<ul style="list-style-type: none"> • Check the network wiring, and other master devices on the network. Make sure they are all correct. • Check if any other faulty devices are on the same network. • Switch the Unit to CLEAR / OPERATE mode again. 	
	Lit	Not lit	Not a valid combination.		
		Lit	Not a valid combination.		
			Not a valid combination.		

BST	COMM	BF	Probable cause	Correction	
Flashing/ Lit	Not lit	Not lit	Not a valid combination.		
		Lit	A Bus disturbance error has been detected. This indicates a termination error (termination resistors are missing, or inductors are not used), or two slave devices with the same address.	<ul style="list-style-type: none"> Switch the Unit to OFFLINE mode. Terminate the network at the appropriate places (see section 2-4-2 <i>Bus Termination</i>). Check if any other faulty devices are on the same network. Switch the Unit to CLEAR / OPERATE mode again. 	
		Flashing	<ul style="list-style-type: none"> None of the allocated slave devices responds to the master's request messages. None of the slaves is in I/O data exchange with the Master Unit. This may indicate a loose network connector on the Master Unit, or a broken cable.	<ul style="list-style-type: none"> Switch the Unit to OFFLINE mode. Check the network wiring. Check if any other faulty devices are on the same network. Check if actual slave addresses match the configured addresses. Check if the slave parameter settings are correct. If necessary change them, and download them again. Switch the Unit to CLEAR / OPERATE mode again. 	
	Lit	Not-Lit	There are no errors. The Unit is in CLEAR or OPERATE mode and exchanging data.		
		Lit	Not a valid combination.		
		Flashing	At least one slave device has responded to the master's request messages and is not in Data Exchange. There is also at least one slave which has either <ul style="list-style-type: none"> not responded to the master's requests messages, or been parameterized incorrectly. 	<ul style="list-style-type: none"> Switch the Unit to OFFLINE mode. Check the network wiring. Check if any other faulty devices are on the same network. Check if the slave parameter settings are correct. Re-download after correction. Switch the Unit to CLEAR / OPERATE mode again. 	

Note The table above assumes that the RUN and the PRM LED indicators are ON and the ERH indicator is OFF. Otherwise, refer to section 7-2-2 *Unit Start-up Errors*, section 7-2-3 *Unit Operational Errors* or section 7-2-4 *Unit Configuration Errors*.

7-3 Troubleshooting Using Error Status

Error status in CIO Words The PROFIBUS Master Unit provides error status indications to the PLC CPU Unit in the Unit Status Word and the Master Status Word 2, which are part of the CIO Words.

7-3-1 Unit Status Word

The Unit status word (CIO Word n+4) contains status and error indications on the Unit itself. The figure below shows the Unit Status Word Layout. The corresponding bit flag will turn ON if an error event has occurred.

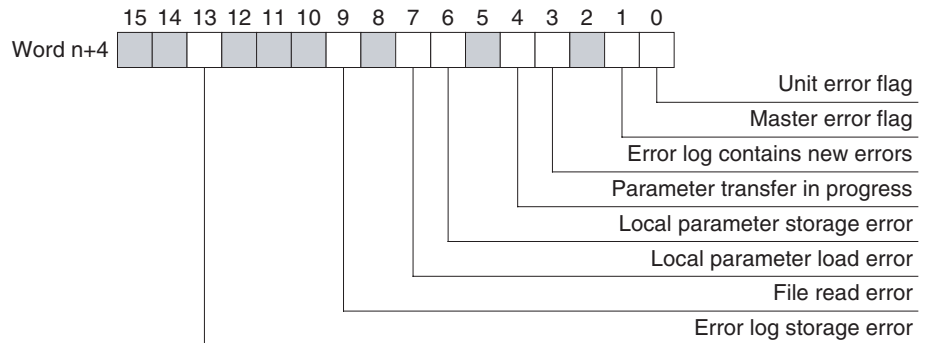

Note n = CIO 1500 + (25 x unit number).

Bit	Name	Description / Correction
00	Unit error flag	If this bit is set, one of the other error flags in the Unit Status Word is set. Refer to these bits for error determination.
01	Master error flag	If this bit is set, one of the error flags in the Master Status 2 Word is set. Refer to these bits for error determination.
03	Error Log contains new errors	There are new errors available in the Error Log, since the last time the error log was read. Reading the error log (using the ERROR LOG READ FINS command) will clear this bit flag.
04	Parameter transfer in progress	A Parameter transfer is in progress either from the configurator to the Unit or between the Unit and the Memory Card.
06	Local parameter storage error	An error has occurred, when writing the configuration to the non-volatile memory. To correct this: <ul style="list-style-type: none"> Restart the Unit. Re-download the configuration. If the problem persists, replace the PROFIBUS Master Unit.
07	Local parameter load error	An error has occurred, when loading the configuration from the non-volatile memory to the volatile memory at start up. Most likely causes: <ul style="list-style-type: none"> A failure or interruption during the writing process. A faulty parameter setting, which makes initialization of the PROFIBUS interface not possible. To correct this: <ul style="list-style-type: none"> Check the parameter settings for incorrect values. Restart the Unit. Re-download the configuration. If the problem persists, replace the PROFIBUS Master Unit.

09	File read error	<p>An error has occurred, when loading the configuration from the non-volatile memory to the volatile memory at start up. Most likely cause is a failure or interruption during the writing process.</p> <p>Most likely causes:</p> <ul style="list-style-type: none"> • A failure or interruption during the writing process. • A failure during the reading process. • A faulty Memory Card. <p>To correct this:</p> <ul style="list-style-type: none"> • Check the Memory Card for faults. • Restart the PLC Unit, to re-download the configuration. • If the problem persists, use CX-Profibus to re-download the configuration. • If the problem persists, replace the PROFIBUS Master Unit.
13	Error Log storage error	<p>An error has occurred, when writing the error log to the non-volatile memory, or when reading the error log from non-volatile memory during start up.</p> <p>Most likely causes: A failure or interruption during the writing process.</p> <p>To correct this:</p> <ul style="list-style-type: none"> • Send an ERROR LOG CLEAR FINS command to the Unit. • Restart the Unit. • If the problem persists, replace the PROFIBUS Master Unit.

7-3-2 Master Status 2 Word

The Master Status 2 Word (CIO Word n+6) contains error indications on the PROFIBUS interface and network. The figure below shows the Master Status 2 Word layout. The corresponding bit flag will turn ON if an error event has occurred.

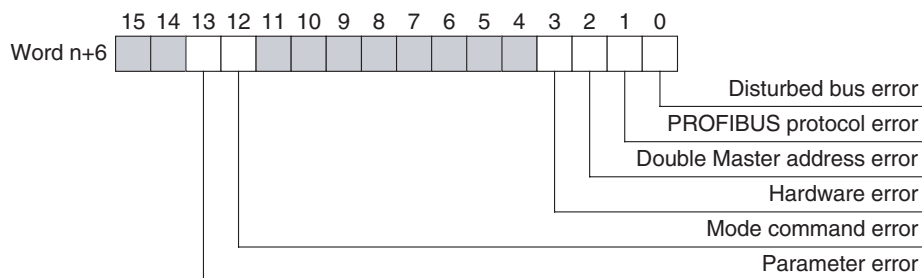

Note n = CIO 1500 + (25 x unit number).

Bit	Name	Description / Correction
00	Disturbed bus Error	<p>An error has occurred in the PROFIBUS interface, with distorted messages received by the PROFIBUS Master Unit.</p> <p>Most likely causes:</p> <ul style="list-style-type: none"> • No or invalid termination or no inductors used at high baud rates. • Faulty wiring. <p>To correct this:</p> <ul style="list-style-type: none"> • Check the termination on the appropriate devices. • Restart the PLC Unit, to re-download the configuration. • If the problem persists, use CX-Profibus to re-download the configuration. • If the problem persists, replace the PROFIBUS Master Unit.

01	PROFIBUS protocol error	<p>An error has occurred in the PROFIBUS interface, with distorted messages received by the PROFIBUS Master Unit.</p> <p>Most likely causes:</p> <ul style="list-style-type: none"> • Lost token messages (the token is not returned). <p>To correct this:</p> <ul style="list-style-type: none"> • Check the master devices on the network, and make sure they are all working correctly. • After correction, switch the Unit to CLEAR / OPERATE mode again.
02	Double master address error	<p>A second master device with the same network address has been detected on the PROFIBUS network. The PROFIBUS Master Unit has switched to OFFLINE.</p> <p>To correct this:</p> <ul style="list-style-type: none"> • Check the master devices on the network and ensure that they have unique device addresses. • After correction, switch the Unit to CLEAR / OPERATE mode again.
03	Hardware error	<p>A hardware error has occurred in the PROFIBUS interface of the Unit. The PROFIBUS Master Unit has switched to OFFLINE.</p> <p>Most likely causes:</p> <ul style="list-style-type: none"> • Faulty wiring, • Broken messages, • Short-circuits, or • Faulty bus timings. • A master device has been detected beyond the Highest Station Address (HSA). <p>To correct this:</p> <ul style="list-style-type: none"> • Check the network wiring, and make sure it is correct. • Check for short-circuits. • Check the bus timing set through CX-Profibus. • Check if any other faulty devices are on the same network. • After correction, switch the Unit to CLEAR / OPERATE mode again.
12	Mode command error	<p>An error has occurred when setting two or more mode switches in Switch Word (CIO Word n). The flag will be set to ON, until the correct command, i.e. one mode switch has been issued.</p>
13	Parameter error	<p>An error has occurred initializing the PROFIBUS interface, after reading the parameter sets from the non-volatile memory to the volatile memory.</p> <p>Most likely cause: A faulty parameters has been downloaded to the Unit.</p> <p>To correct this: Check the parameter settings in CX-Profibus and correct them if necessary. After correction, perform a download of the new parameters to the Unit.</p>

7-4 Troubleshooting the Network

7-4-1 Troubleshooting Parameter Download

The PROFIBUS Master DTM provides clear error messages if downloading of the parameters to the PROFIBUS Master Unit fails. Failure can be due to either

- Errors or inconsistencies in the slave parameter sets, which are checked prior to download.
- The Master DTM being unable to establish communication with the CS1/CJ1W-PRM21 PROFIBUS Master Unit.
- A communication interruption of the process during download.

Errors in Slave Parameter Sets

The error messages displayed will provide a clear indication of the problem. A download initiated by the user, starts with a check on the slave parameter sets. The Master DTM will check

- The total number of slave devices assigned, which must be at least one slave device.
- The total number of I/O modules per slave, which must be at least one I/O module per slave.
- The maximum size of the I/O data size, which must not exceed 7168 words.
- The maximum number of I/O modules, which must not exceed 4000.
- Any existing overlap in the I/O Areas configured.
- Any existing overlap in the allocated PLC memory areas.
- Availability of EM banks should any of the I/O Areas be mapped to one of the EM Banks. Availability of the EM banks depends on the PLC CPU type.

Anyone of these errors will abort the download process without consequences for the CS1/CJ1W-PRM21 PROFIBUS Master Unit.

The error messages associated with these failures are listed in Appendix *D-2 Error Messages - Configuration*. The list also provides remedies.

Errors when Establishing Communication

If no errors occurred during the checking phase, the Master DTM will try to establish communication with the CS1/CJ1W-PRM21 PROFIBUS Master Unit through CX-Server. If this fails, an error message will be displayed, indicating a communication problem (see Appendix *D-3 Error Messages - Communication*). A failure to establish communication prior to download will have no consequences for the CS1/CJ1W-PRM21 PROFIBUS Master Unit. The list provided in Appendix *D-3 Error Messages - Communication* also provides possible remedies.

Errors During Download

If none of the first two processes result in a failure, downloading will commence. As soon as downloading has started, the data in the volatile memory of the CS1/CJ1W-PRM21 PROFIBUS Master Unit will be overwritten.

Recovery After Failing Download

If a failure occurs during the download process, which prevents the Master DTM from completing the process, the user must restart the Unit manually. Restarting the Master Unit will abort the download process in the Master Unit and recover the previous configuration from its non-volatile memory.

7-4-2 Troubleshooting the Network using CX-Profibus

CX-Profibus Troubleshooting

CX-Profibus provides several means to troubleshoot either the CS1/CJ1W-PRM21 PROFIBUS Master Unit, the slave devices or the network. The means all rely on features discussed in the previous section.

Troubleshooting the Master Unit

To troubleshoot the Master Unit or the network, the Master DTM Diagnosis User Interface provides a help in determining problems. The figure below shows the Monitor - Master Status tab of the Master DTM Diagnosis User Interface.

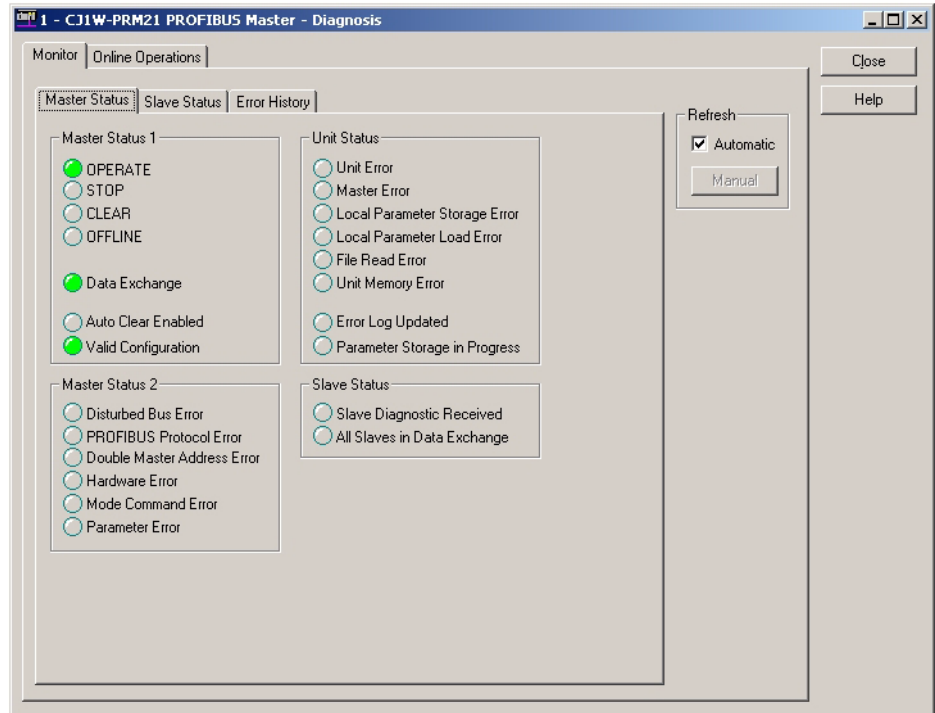

The LED indicators shown in the (example) figure above are all related to bit flags in the Unit Status Word, the Master Status Word 1, the Master Status Word 2, and the Slave Status Word (see section 4-2 *Allocated CIO Area Words*).

The table below lists combinations of LED indicators with information on possible problems.

LED Indicators	Description / Correction
Local Parameter Storage Error (Valid Configuration Indicator will be OFF)	An error has occurred, when writing the configuration to the non-volatile memory. To correct this: <ul style="list-style-type: none"> • Restart the Unit. • Re-download the configuration. • If the problem persists, replace the PROFIBUS Master Unit.
Local Parameter Load Error (Valid Configuration Indicator will be OFF)	An error has occurred, when loading the configuration from the non-volatile memory to the volatile memory at start up. Most likely causes: <ul style="list-style-type: none"> • A failure or interruption during the writing process. • A faulty parameter setting, which makes initialization of the PROFIBUS interface not possible. To correct this: <ul style="list-style-type: none"> • Check the parameter settings for incorrect values. • Restart the Unit. • Re-download the configuration. • If the problem persists, replace the PROFIBUS Master Unit.
File read error is ON (Valid Configuration Indicator will be OFF)	An error has occurred, when loading the configuration from the non-volatile memory to the volatile memory at start up. Most likely causes: <ul style="list-style-type: none"> • A failure or interruption during the writing process. • A failure during the reading process. • A faulty Memory Card. To correct this: <ul style="list-style-type: none"> • Check the Memory Card for faults. • Restart the PLC Unit, to re-download the configuration. • If the problem persists, use CX-Profibus to re-download the configuration.
Parameter error: ON (Valid Configuration Indicator will be OFF)	An error has occurred initializing the PROFIBUS interface, after reading the parameter sets from the non-volatile memory to the volatile memory. Most likely cause: <ul style="list-style-type: none"> • A faulty parameters has been downloaded to the Unit. To correct this: <ul style="list-style-type: none"> • Check the parameter settings in CX-Profibus and correct them if necessary. After correction, perform a download of the new parameters to the Unit.
Disturbed bus Error: ON	An error has occurred in the PROFIBUS interface, with distorted messages received by the PROFIBUS Master Unit. Most likely causes: <ul style="list-style-type: none"> • No or invalid termination or no inductors used at high baud rates. • Faulty wiring. To correct this: <ul style="list-style-type: none"> • Check the termination on the appropriate devices. • Restart the PLC Unit, to re-download the configuration. • If the problem persists, use CX-Profibus to re-download the configuration. • If the problem persists, replace the PROFIBUS Master Unit.

LED Indicators	Description / Correction
PROFIBUS protocol error: ON (OFFLINE indicator will be ON)	An error has occurred in the PROFIBUS interface, with distorted messages received by the PROFIBUS Master Unit. Most likely causes: <ul style="list-style-type: none"> • Lost token messages (the token is not returned). To correct this: <ul style="list-style-type: none"> • Check the master devices on the network, and make sure they are all working correctly. • After correction, switch the Unit to CLEAR / OPERATE mode again.
Double master address error: ON (OFFLINE indicator will be ON)	A second master device with the same network address has been detected on the PROFIBUS network. The PROFIBUS Master Unit has switched to OFFLINE. To correct this: <ul style="list-style-type: none"> • Check the master devices on the network and ensure that they have unique device addresses. • After correction, switch the Unit to CLEAR / OPERATE mode again.
Hardware error: ON (OFFLINE indicator will be ON)	A hardware error has occurred in the PROFIBUS interface of the Unit. The PROFIBUS Master Unit has switched to OFFLINE. Most likely causes: <ul style="list-style-type: none"> • Faulty wiring, • Broken messages, • Short-circuits, or • Faulty bus timings. • A master device has been detected beyond the Highest Station Address (HSA). To correct this: <ul style="list-style-type: none"> • Check the network wiring, and make sure it is correct. • Check for short-circuits. • Check the bus timing set through CX-Profibus. • Check if any other faulty devices are on the same network. • After correction, switch the Unit to CLEAR / OPERATE mode again.
<ul style="list-style-type: none"> • Auto-Clear enabled: ON • CLEAR: ON • Slave Diagnostics received: ON 	This combination indicates that one of the slave devices on the network failed, causing an automatic transition to the CLEAR mode. Check the Monitor - Slave Status tab, to see which slave failed.
<ul style="list-style-type: none"> • OPERATE: ON • Slave Diagnostics received is: ON • Data Exchange: OFF • Auto-Clear enabled: OFF 	The Master Unit is still in OPERATE mode, but not exchanging data with all its slave devices. One or more of the slave devices on the network failed. Check the Monitor - Slave Status tab, to see which slave failed.

Troubleshooting the Slave Devices

If the Master Status tab indicates problems related to slave devices, their status can be obtained by checking the Slave Status tab. The figure below shows this tab. As an example a failure of slave device 2 is shown.

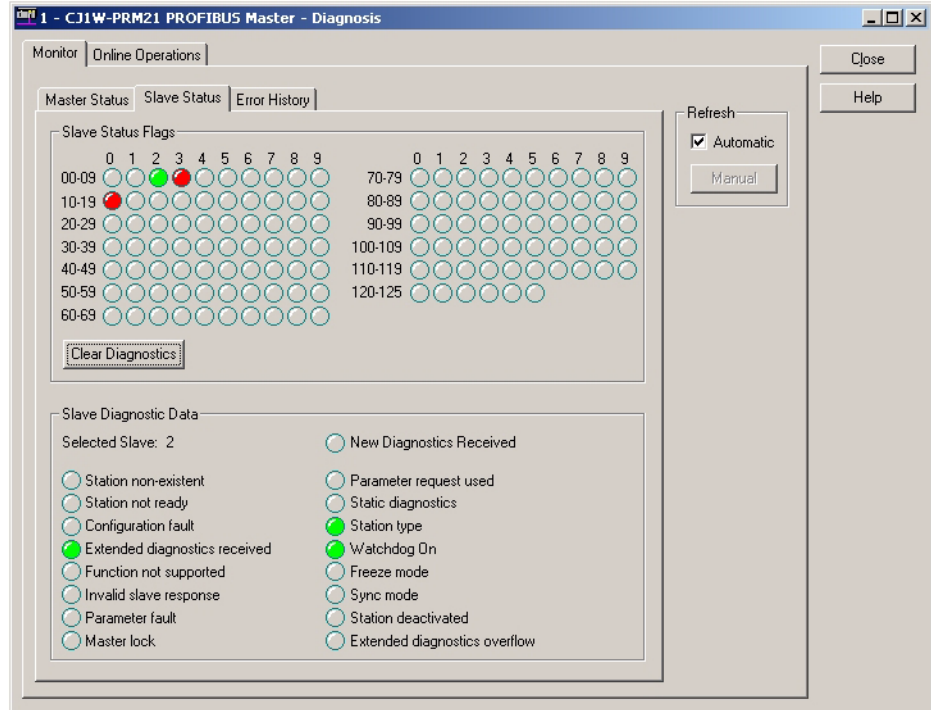

The LED indicators in the upper half of the Slave Status tab shown in the figure above, indicates the status of the slave devices, by using different colours (see section 6-7-1 *Monitoring the Master Unit and the Network, Slave Status Overview*).

In case an LED indicator is either Red or Orange, additional information can be obtained from the PROFIBUS Master Unit, by using the mouse pointer to click on the coloured LED indicator. The basic diagnostics information, for the selected slave device is retrieved from the Master Unit and displayed in the lower half of the Slave Status tab. The table below lists the LED indicators, which are of interest for troubleshooting.

LED Indicator	Description / Correction
Station non-existent	The slave device does not respond to any of the request messages sent by the Master Unit. <ul style="list-style-type: none"> • Make sure that the slave device is powered correctly. • Check the wiring and make sure that the slave device and the Master Unit are connected.
Station not ready	The slave is communicating, but not ready for data transfer. <ul style="list-style-type: none"> • Check the slave device and make sure that it is working properly. • Check any loose modules, in case the slave device is a modular device. • Consult the operation manual of the slave device. Check if additional action must be taken to initiate I/O data exchange (e.g. reset the device after a malfunction).
Configuration fault	The I/O configuration sent by the Master Unit is rejected by the slave device. The Parameter request used LED indicator will also be ON. <ul style="list-style-type: none"> • Check the selected I/O modules in the Slave DTM. Make sure they match the expected total I/O number and sequence. • Consult the operation manual of the slave device. Check if additional modules must be selected (e.g. empty i/O modules for power modules in a modular slave).
Extended diagnostics received	The slave device has returned extended diagnostics information. This does not necessarily indicate a malfunction. The Master DTM does not display the extended diagnostics returned by a slave device. Open the associated Slave DTM to check on the contents of the extended diagnostics.

LED Indicator	Description / Correction
Function not supported	The Master Unit has sent a message to the slave device, which is not supported by that device.
Invalid slave response	This bit is set by the Master Unit if the slave has returned an invalid response to a master request message.
Parameter fault	<p>The parameters sent by the Master Unit are rejected by the slave device. The Parameter request used LED indicator will also be ON.</p> <ul style="list-style-type: none"> • Check the common parameter settings in the Slave DTM. Make sure the parameters are within range, and match the physical configuration of the slave device. • Consult the operation manual of the slave device. Check if additional parameters must be selected (e.g. parameters associated with selected I/O modules).
Master lock	<p>The slave device is parameterized and locked by another Master Unit on the network. The Parameter request used LED indicator will also be ON.</p> <ul style="list-style-type: none"> • Remove the slave device from either one of the two Master Units on the network. • Switch off the other Master Unit.
Parameter request used	<p>The slave device is not in I/O data exchange with the Master Unit and has requested new parameters.</p> <ul style="list-style-type: none"> • Check the parameters and the I/O configuration for the slave device and make sure they are correct (Check the Parameter fault, Configuration fault and Master Lock LED indicators).
Static diagnostics	<p>The slave device is sending static diagnostics, and is not exchanging I/O data. This usually indicates a problem at the slave device which prevents it from reading its inputs or setting its outputs.</p> <ul style="list-style-type: none"> • Check the slave device and make sure that it is working properly. • Check any loose modules, in case the slave device is a modular device. • Check the wiring of the I/O at the slave device. Slaves can often detect short-circuits on their physical I/O. • Consult the operation manual of the slave device. Check if additional action must be taken to initiate I/O data exchange (e.g. reset the device after a malfunction).
Station type	This LED indicator only indicates the device type (i.e. slave device) and does not indicate a problem.
Watchdog On	This LED indicator only indicates that the Watchdog has been enabled at the slave device and does not indicate a problem.
Freeze mode	This LED indicator only indicates the slave device has received a Global-Control Freeze command and does not indicate a problem.
Sync mode	This LED indicator only indicates the slave device has received a Global-Control Sync command and does not indicate a problem.
Slave deactivated	This LED indicator indicates the slave device has been disabled in the Master Unit and does not indicate a problem.
Extended diagnostics overflow	<p>The slave device has more diagnostics to report than it can hold in its buffer. This is usually an indication for problems.</p> <ul style="list-style-type: none"> • Check the slave device's extended diagnostics information. Open the associated Slave DTM to check on the contents of the extended diagnostics, if this has been returned. • Check the slave device and make sure that it is working properly. • Check any loose modules, in case the slave device is a modular device. • Check the wiring of the I/O at the slave device. Slaves can often detect short-circuits on their physical I/O. • Consult the operation manual of the slave device. Check if additional action must be taken to initiate I/O data exchange (e.g. reset the device after a malfunction).

7-4-3 Troubleshooting I/O Communication

This section deals with troubleshooting the I/O communication on the network from a behaviour point of view. The tables below describe the general perceived problem to the user, probable causes and probable remedies.

Communication Problems

Problem	Probable cause	Correction
PROFIBUS Master Unit is configured, but none of the slaves are exchanging data.	No power is supplied to the system. <ul style="list-style-type: none"> All LED indicators on the system are OFF. 	<ul style="list-style-type: none"> Verify that power is supplied to the system.
	A PLC CPU (startup) error occurred. <ul style="list-style-type: none"> The ERH indicator is ON, the other LED indicators are OFF. The ERR/ALM LED indicator on the PLC CPU is ON. 	<ul style="list-style-type: none"> Determine error in the PLC CPU (Refer to the <i>CS1 Series CPU Unit Operation Manual (W339)</i> or the <i>CJ Series CPU Unit Operation Manual (W393)</i>).
	The stored configuration contains a checksum error (storing configuration was interrupted or failed). <ul style="list-style-type: none"> After restarting the Unit, the ERC LED indicator is ON, and the PRM LED indicator is OFF. Unit Status error flag may provide more information (CIO Word n+4, bit 06, bit 07, bit 09, see Note). 	<ul style="list-style-type: none"> Re-download the configuration. If the problem persists, replace the Unit.
	The configuration contains timing errors. <ul style="list-style-type: none"> After restarting the Unit, the ERC LED indicator is ON, and the PRM LED indicator is OFF. 	<ul style="list-style-type: none"> Verify that the Bus parameter sets are correct. Re-download the configuration. If the problem persists, replace the Unit.
	The PROFIBUS Master Unit is in either OFFLINE or STOP mode. <ul style="list-style-type: none"> The BST LED indicator is OFF The Unit may have been configured to maintain its current mode (last mode was OFFLINE, during download). The BF LED indicator is ON: A PROFIBUS interface error has occurred: see Master Status 2 error flags (CIO Word n+6, bit 00 ~ 03, see Note) for details. 	Determine the mode of the Unit: Check the Master Status 1 Word (CIO Word n+5, bit 00 to bit 03, see Note). If Unit is in OFFLINE or STOP mode: <ul style="list-style-type: none"> Verify that the master does not use the same address as another Master Unit on the network. Otherwise, correct the Master Unit's PROFIBUS address. Verify that all Master Units on the network use the same baud rate setting. Otherwise, correct the baud rate settings. Set CLEAR or OPERATE switch in CIO Word n (see Note). Change the configuration to set the Unit OPERATE mode when switching the PLC to RUN/MONITOR mode (see Master DTM, Master Setup Tab). Download the configuration, and switch the PLC to RUN/MONITOR mode.
	Network cabling is not correct. <ul style="list-style-type: none"> BF LED indicator is ON. Master Status 2 error flag may provide more information (CIO Word n+6, bit 00 ~ 03, see Note). CIO Words n+9 to n+16 show which slaves have problems. 	Verify that the network installation is correct: <ul style="list-style-type: none"> Verify that all slaves are powered up and functioning correctly. Verify that all slave devices are correctly connected to the network. Verify that any repeaters used are functioning correctly. Check the cable length versus the selected baud rate. Verify that any stubs used are not too long. Verify that termination (resistors and inductors) are properly set and used.

Problem	Probable cause	Correction
<p>PROFIBUS Master Unit is configured. Some, but not all slaves exchange data.</p>	<p>Network cabling is not correct.</p> <ul style="list-style-type: none"> • BF LED indicator is ON or Flashing. • Master Status 2 error flag may provide more information (CIO Word n+6, bit 00 ~ 03, see Note). • CIO Words n+9 to n+16 show which slaves have problems. 	<p>Verify that the network installation is correct:</p> <ul style="list-style-type: none"> • Verify that all slaves are powered up and functioning correctly. • Verify that all slave devices are correctly connected to the network. • Verify that any repeaters used are functioning correctly. • Check the cable length versus the selected baud rate. • Verify that any stubs used are not too long. • Verify that termination (resistors and inductors) are properly set and used.
	<p>Configuration is not correct.</p> <ul style="list-style-type: none"> • BF LED indicator is Flashing. • CIO Words n+9 to n+16 show which slaves have problems. • Use CX-Profibus and DTMs to determine slave diagnostics. 	<p>Verify that the configuration is correct:</p> <ul style="list-style-type: none"> • Verify that address of targeted slave device matches the configured address. • Verify that the slave parameter and configuration settings are correct. • Verify that the watchdog setting for the slave device is not too low.
	<p>The configuration contains timing errors.</p> <ul style="list-style-type: none"> • BF LED indicator is Flashing. • Slaves are sometimes briefly in and out of data exchange. 	<ul style="list-style-type: none"> • Increase slave Watchdog Control value in the Master Unit Bus parameter set. • Verify that the Bus parameter sets are correct. If necessary, increase Target Rotation Time and/or Min. Slave Interval parameters. • Re-download the configuration. • If the problem persists, replace the Unit.
	<p>A second master device (with its own slave devices) is on the same network, interfering with this Master Unit.</p> <ul style="list-style-type: none"> • The baud rate settings of both masters is different. • The total Target Rotation Time set to both masters is too small (i.e. not the sum of both individual time values). 	<ul style="list-style-type: none"> • Verify that all masters on the network are set to the same baud rate. • Verify that the total Target Rotation Time for all masters on the network is set to the sum of all individual masters.
	<p>Specific slave devices are configured and allocated to the Master Unit, but the slave which is not exchanging data may have been disabled using the FINS STOP command.</p>	<p>Use the FINS RUN command to enable the slave devices.</p>

Problem	Probable cause	Correction
<p>PROFIBUS Master Unit is configured. All slaves were in data exchange, but it has now stopped.</p>	<p>No power is supplied to the system. All LED indicators on the system are OFF.</p>	<ul style="list-style-type: none"> • Verify that power is supplied to the system.
	<p>A PLC CPU error occurred.</p> <ul style="list-style-type: none"> • The ERH indicator is ON, the other LED indicators are OFF. • The ERR/ALM LED indicator on the PLC CPU is ON. 	<ul style="list-style-type: none"> • Determine error in the PLC CPU (Refer to the <i>CS1 Series CPU Unit Operation Manual (W339)</i> or the <i>CJ Series CPU Unit Operation Manual (W393)</i>).
	<p>A Unit error occurred.</p> <ul style="list-style-type: none"> • The ERC indicator is ON, the other LED indicators are OFF. • The ERR/ALM LED indicator on the PLC CPU is ON. 	<ul style="list-style-type: none"> • Restart the Unit, and read the error log to determine the type of error.
	<p>The PROFIBUS Master Unit is in either OFFLINE or STOP mode.</p> <ul style="list-style-type: none"> • The BST LED indicator is OFF • The BF LED indicator is ON: A PROFIBUS interface error has occurred: see Master Status 2 error flags (CIO Word n+6, bit 00 ~ 03, see Note) for details. 	<p>Determine the mode of the Unit: Check the Master Status 1 Word (CIO Word n+5, bit 00 to bit 03, see Note). If Unit is in OFFLINE or STOP mode:</p> <ul style="list-style-type: none"> • Verify that the master does not use the same address as another Master Unit on the network. Otherwise, correct the Master Unit's PROFIBUS address. • Set CLEAR or OPERATE switch in CIO Word n (see Note).
<p>PROFIBUS Master Unit is configured. After switching the Master Unit to OPERATE, the Unit itself or other Units on the PLC CPU showed unexpected behaviour.</p>	<p>Network cabling is not correct.</p> <ul style="list-style-type: none"> • BF LED indicator is ON. • Master Status 2 error flag may provide more information (CIO Word n+6, bit 00 ~ 03, see Note). 	<p>Verify that the network installation is correct:</p> <ul style="list-style-type: none"> • Verify that the network is still in tact, and connected to the Unit. • Verify that any repeaters used are functioning correctly.
	<p>The I/O data mapping of the Master Unit may overwrite either its own or other Unit CIO/DM Areas settings:</p> <ul style="list-style-type: none"> • Master Unit operational mode changes unexpectedly. • Global-Control commands are transmitted unexpectedly. • Other Special I/O Units or Special Bus Units change behaviour unexpectedly. 	<p>Verify the I/O Mapping of the Master Unit:</p> <ul style="list-style-type: none"> • Ensure that the I/O data of the Master Unit, does not overwrite its own CIO words. • Ensure that the I/O data of the Master Unit, does not overwrite CIO words or DM words of other Special I/O or Special CPU Units (e.g. Ethernet Units)
<p>PROFIBUS Master Unit is configured. All slaves were in data exchange, but all outputs are now set to zeros. Inputs can still be read.</p>	<p>The bus parameter used on the network are wrong.</p> <ul style="list-style-type: none"> • I/O data exchange between the Master Unit and the PLC stops. 	<p>Verify that the correct bus parameters have been used.</p> <ul style="list-style-type: none"> • (If necessary) Restart the Unit and force it to OFFLINE immediately, or • Disconnect the network cable first and restart the Unit. • Download the correct Bus parameters.
<p>PROFIBUS Master Unit is configured. All slaves were in data exchange, but all outputs are now set to zeros. Inputs can still be read.</p>	<p>The Master Unit is in CLEAR mode.</p> <ul style="list-style-type: none"> • The BST LED indicator is Flashing. • The CLEAR switch has been set in the Switch word 1 (CIO Word n, bit 02, see Note) • The Unit has been configured for Auto-CLEAR and an error occurred on the Network with one or more slave devices. 	<ul style="list-style-type: none"> • If Auto-CLEAR is enabled, correct the network problem first. • Set OPERATE switch in CIO Word n (see Note) to force the Unit to the OPERATE mode.

Problem	Probable cause	Correction
PROFIBUS Master Unit is configured. All slaves are in data exchange, but the outputs of some slave devices are not updated.	The specified slave devices may be in Sync mode.	Send a Global-Control Unsync command to the targeted slave or group of slaves. Use either the Global-Control feature in CIO Words. Refer to 4-2-2 <i>Global-Control Message (Word n+2)</i> .
	The specified slave device may have its watchdog disabled and is disconnected from the network, due to a cabling problem. <ul style="list-style-type: none"> • BF LED indicator is Flashing. • CIO Words n+9 to n+16 (see Note) show which slaves have problems. • Use CX-Profibus and DTMs to determine slave diagnostics. 	Verify that the specified slave device is still connected to the network.
PROFIBUS Master Unit is configured. All slaves are in data exchange, but the inputs of some slave devices are not updated.	The specified slave devices may be in Freeze mode.	Send a Global-Control Unfreeze command to the targeted slave or group of slaves. Use either the Global-Control feature in CIO Words. Refer to 4-2-2 <i>Global-Control Message (Word n+2)</i> .
	The specified slave device may have its watchdog disabled and is disconnected from the network, due to a cabling problem. <ul style="list-style-type: none"> • BF LED indicator is Flashing. • CIO Words n+9 to n+16 (see Note) show which slaves have problems. • Use CX-Profibus and DTMs to determine slave diagnostics. 	Verify that the specified slave device is still connected to the network.

Note n = CIO 1500 + (25 x unit number).

7-4-4 Troubleshooting PROFIBUS DP-V1 Communication

This section deals with troubleshooting the PROFIBUS DP-V1 Communication on the network from a behaviour point of view. The column on the left describes the general perceived problem to the user. The columns on the right list the possible causes and their remedies.

Communication Problems

Problem	Probable cause	Correction
PROFIBUS Master Unit is configured. Both the I/O Communication as the PROFIBUS DP-V1 Communication fail.	A possible problem with the network.	Please refer to sections 7-4-2 <i>Troubleshooting the Network using CX-Profibus</i> and/or 7-4-3 <i>Troubleshooting I/O Communication</i> .
	The I/O Configuration is incorrect and the slave device is not in data exchange with the PROFIBUS Master Unit.	Correct the I/O Configuration if required.
PROFIBUS Master Unit is configured and the I/O Communication is operational. The PROFIBUS DP-V1 Communication fails.	FINS commands can not be send to a PROFIBUS Slave which has address value zero.	Change the address of the PROFIBUS Slave and the PROFIBUS configuration if required.
	When communicating with the DTM or from the PLC program, the previous PROFIBUS DP-V1 communication session may not have been ended correctly. Corresponding PROFIBUS DP-V1 Connection bit (refer to <i>Acyclic Connection/Abort Status Box</i> on page 74) is still set.	Put the DTM offline and online again to initiate communication. If this does not clear the problem, put the master in OFFLINE mode and back into the original state.
	The PROFIBUS Slave may not support PROFIBUS DP-V1 (class 1 or class 2).	Please check the Slave's Operation manual or GSD file.

7-5 Troubleshooting Using the Error Log

7-5-1 Error Log Overview

The PROFIBUS Master Unit maintains an Error Log, which contains the reports on specific error events.

Logged Errors

The following errors are recorded in the error log.

- Errors in network operation
- Errors in data transfers
- Error in the CPU Unit

Error Log Records

Each error is recorded as one record in an error log table. Each record contains:

- A main error code (see 7-5-2 *Error Codes*)
- A detailed error code (see 7-5-2 *Error Codes*)
- A time stamp (from the clock in the CPU Unit)

Error Log Location

When an error is detected, the error codes and time stamp are recorded in an error log record, which is stored in the error login volatile memory (i.e. RAM memory) inside the PROFIBUS Master Unit. Serious errors are also recorded in non-volatile memory (i.e. Flash ROM).

A total of 80 error records can be logged in volatile memory.

Up to 16 more serious system errors are also copied to non-volatile memory.

Adding Error Records to the Error Log

When adding a new record to the error log and the error log is full, the latest error will replace the oldest error in the log. At power up / reset, the non-volatile error log will first be copied to the volatile error log.

The contents of the non-volatile error log will be corrupted if the Unit is interrupted (i.e. power-down / reset), while writing to the error log.

If an error in the non-volatile error log is detected at power up / reset, the Unit:

1. Will try to repair the contents of the error log.
2. If the log remains corrupted, the Error Log Storage Error bit in the Unit Status Word (CIO Word n+4, Bit 13) will be set. In this case, the error and the flag can only be cleared through the FINS command ERROR LOG CLEAR. The start-up procedure will be completed normally.

If, during normal operation, writing errors to the error log fails, the Unit will set the Error Log Storage Error bit in the Unit Status Word (CIO Word n+4, Bit 13).

Note $n = \text{CIO } 1500 + (25 \times \text{unit number})$.

Reading the Error Log

The error records in the error log can be read with the FINS command ERROR LOG READ. The error log can be read from the PLC, via CX-Profibus, and via CX-Programmer.

Clearing the Error Log

Sending the FINS command ERROR LOG CLEAR to the Unit clears both the non-volatile and the volatile error logs.

(See 5-2-5 *ERROR LOG READ (2102)* and 5-2-6 *ERROR LOG CLEAR (0203)*).

7-5-2 Error Codes

The error codes are described in the following table. The detailed error code will provide detailed information on an error.

Error code	Meaning	Detailed error code		Correction	Non-volatile
		1st byte	2nd byte		
0001	Watchdog timer error in CPU Unit.	00	00	Replace the PLC CPU Unit.	Saved
0002	CPU Unit service monitor error.	Actual monitoring time ms (Hex)		Check the operating environment.	Saved
000E	PLC Bus error.	00	00	Replace the CPU Unit.	Saved
0011	Event time out	MRC	SRC	Replace the CPU Unit.	Saved
0012	CPU Unit memory error	01: Read error 02: Write error	03: Routing table	01: Recreate the data specified by the 2nd byte of the detailed error code. 02: Clear memory using procedure in the PLC operation manual.	Saved
010D	Destination address not in routing tables (send failed)	Commands Bit 15: OFF Bits 08 to 14: SNA Bits 00 to 07: SA1 Responses Bit 15: ON Bits 08 to 14: DNA Bits 00 to 07: DA1		Set the destination address in the routing tables.	---
010E	No routing table entry (send failed)			Set the local node, remote node and relay nodes in the routing tables.	---
010F	Routing table error (send failed)			Create the routing tables correctly.	---
0110	Too many relay points (send failed)			Reconstruct the network or correct the routing tables so that commands are set to within a 3-level network range.	---
0112	Header error (send failed)			Check the command format and set the correct command data.	---
0120	Unexpected routing error			Check the routing tables.	---
0202	PROFIBUS parameter set invalid.	00	80: Bus parameter error 00 ~ 7D: Slave parameter error	<ul style="list-style-type: none"> Check the parameter settings. Re-download the configuration if necessary. 	---
020C	Protocol error.	00	00 ~ 7D: Failing Master Address	Check the master devices on the network, and make sure they are all working correctly.	---
0211	Duplicate master address.	00	00 ~ 7D: Failing Master Address	Check the master devices on the network and ensure that they have unique device addresses.	---
0219	Hardware error.	00	00	<ul style="list-style-type: none"> Check the network wiring, and make sure it is correct. Check for short-circuits. Check the bus timing set through CX-Profibus. Check the HSA setting in CX-Profibus, and make sure it is set to the master device with the highest address on the network. Check if any other faulty devices are on the same network. Verify that the Highest Station Address setting includes any other master address on the bus. 	---

Error code	Meaning	Detailed error code		Correction	Non-volatile
		1st byte	2nd byte		
021A	Logic error in setting table	00	03: Routing tables	Recreate the data specified by the 2nd byte of the detailed error code.	Saved
0601	CPU Bus Unit fatal error.	Error address in program.		Restart the CPU Unit. If the problem persists, replace the PROFIBUS Master Unit.	Saved
0602	CPU Bus Unit memory error.	01: Read error. 02: Write error.	02: Network Parameter. 06: Error log.	Restart the CPU Unit. If the problem persists, replace the PROFIBUS Master Unit.	Saved

- Note**
1. The time information from the CPU Unit is used in the PROFIBUS Master Unit.
 2. An error record is not created in non-volatile memory when the error concerns an Error Log Write error.

7-6 Troubleshooting FINS Commands

Any problems in FINS communications can be determined using the response codes when the CMND(490) instruction has been used. The table below lists response codes returned by the PROFIBUS Master Unit, after execution of FINS commands, the probable cause of errors, and recommended remedies. Refer to the *Communications Commands Reference Manual (W342)* for further information on response codes.

Main code	Sub-code	Probable cause	Correction
00: No errors	00	---	---
02: Remote node error	03	A FINS command was sent to read/write specific slave data or to control a slave, but the specified slave is not allocated to the PROFIBUS -DP Master Unit.	Specify only addresses of allocated slaves in the FINS command.
04: Service not supported.	02	A FINS command, which is not supported by the Unit/Model has been sent.	Check the command code and be sure the command is supported by the Unit.
10: Command format error	01	The command is longer than the max. permissible length.	Check the command format of the command and set it correctly.
	02	The command is shorter than min. permissible length.	Check the command format of the command and set it correctly.
11: Parameter error	03	The first word is in an inaccessible area or the bit number is not 00.	Set a first word that is in an accessible area. The bit number must be 00 for Ethernet Units.
	0C	Parameters are set incorrectly in the command data. <ul style="list-style-type: none"> • Non-specified code used. • Invalid slave address (exceeds 125). • Invalid code in program number (exceeds 128) • The number of read records is 0. 	Check the command data and correct any parameters that are incorrect.
22: Status error (operating mode disagreement)	08	A FINS command was sent to retrieve slave data, but the Master Unit is in the wrong mode to access the slave device.	Change Master mode to either CLEAR or OPERATE, before re-sending the FINS command.
25: Unit Error	0F	An attempt to clear the Error Log failed.	Re-send the ERROR LOG CLEAR FINS command. If the problem persist, non-volatile memory may be corrupted. Replace the Unit.
26: Environment error (no such Unit)	05	A FINS command was sent to enable or disable a slave device from the poll list, but the targeted slave is already in that mode.	No need to sent the FINS command again, unless a change to the slave state needs to be made.
	0B	Cannot clear the Error Log. The Error cause still exists.	Remove the error cause and Re-send the ERROR LOG CLEAR FINS command.

7-7 Maintenance

This section describes the routine cleaning and inspection recommended as regular maintenance.

7-7-1 Cleaning

Clean the PROFIBUS Master Unit regularly as described below in order to keep it in an optimum operating condition.

- Regularly wipe the Unit with a dry, soft cloth.
- If a spot cannot be removed with a dry cloth, dampen the cloth with a neutral cleaner, wring out the cloth and wipe the Unit.

 **Caution** Never use volatile solvents such as paint thinner, benzene or chemical wipes. These substances could damage the surface of the Unit.

7-7-2 Inspection

Be sure to inspect the system periodically to keep it in optimum operating condition. In general, inspect the system once or twice a year, but more frequently if the system is used in high temperature or high humidity environments or dirty/dusty conditions.

Inspection Equipment

Prepare the following equipment before inspecting the system.

Required Equipment

Philips type screwdriver, multimeter, alcohol, and a clean cloth.

Optional Test Equipment

Depending on system conditions, a synchroscope, oscilloscope, thermometer or hygrometer (to measure humidity) might be needed.

Inspection Procedure

Check the items in the following table and correct any that are below standard.

	Item	Standard	Equipment
Environmental conditions	Ambient temperature	0° C to 55° C	Thermometer
	Ambient humidity	10% to 90%	Hygrometer
	Dust/dirt accumulation	None	---
Installation	Are the units installed securely?	No looseness	---
	Are the communications connectors fully inserted?	No looseness	---
	Are the external wiring screws tight?	No looseness	---
	Are the connecting cables undamaged?	No damage	---

7-8 Replacing the Unit

7-8-1 Replacement Precautions

The PROFIBUS Master Unit is a Network device. If the Unit is damaged, it will effect the entire Network, so always ensure repairs are undertaken immediately. It is recommended to have a spare PROFIBUS Master Unit on hand so that repairs may be conducted quickly.

Replacement Precautions

Observe the following precautions when replacing the Unit.

- Always turn OFF the power before replacing the Unit.
- Ensure that the new Unit is not faulty.
- If a poor connection is suspected of causing the malfunction, clean the connectors using a clean, soft cloth and industrial-grade alcohol. Remove any lint or threads left from the cloth, and remount the Unit.
- When returning a faulty Unit for repair, always attach a detailed fault report to the Unit and return it to the nearest OMRON dealer.

Note

1. In order to prevent faulty operation be sure to turn off the power to all master and slave devices before replacing the Unit.
2. When replacing the Unit, do not reconnect it to the Network before carrying out the procedures listed below.

7-8-2 Setting the Unit after Replacement

After replacing a PROFIBUS Master Unit - before re-applying the power - set the unit number to the same unit number as the previous Unit.

After re-applying the power, the configuration settings, present in the previous Unit, must also be transferred to the new Unit. There are two methods to accomplish this.

- Start up CX-Profibus and reload the original project from the stored location, and download it to the new Unit.
- Use a Memory Card to store the all the Unit's settings, before replacement, and restore it to the new Unit after replacement.

After configuring the new Unit, re-connect it to the network, and restart operation.

7-8-3 Addition/Replacement of Units on the PROFIBUS Network

The PROFIBUS network allows to connect and disconnect devices while in operation.

Connecting / Disconnecting Devices

Connecting / disconnecting any device in a PROFIBUS network is liable to result in a temporary increase of the communication cycle time. An existing slave device can only be replaced by the same type of device with the same configuration. Any change to this configuration is likely to require a new configuration. Changing a device with a different device (type and/or configuration) will have a significant influence on the performance on the PROFIBUS network.

Adding a Device

The addition of a new device to an existing configuration will require a new configuration file to be downloaded in the PROFIBUS Master Unit, which will temporarily disable all communication by this Unit on PROFIBUS.

Appendix A

Bus Parameters

A-1 Bus Parameters

The PROFIBUS Bus Parameters define both the baud rate and the bus timing settings, necessary to perform the exchange of messages over PROFIBUS. The Bus Parameters settings must be determined for each and every Master device on the bus, and usually depend on

- the number of I/O data bytes per slave device,
- the number of slave devices connected to the master,
- the number of other masters on the bus.

The Bus Parameter settings consist for one part of a number of settings, which are directly entered into the PROFIBUS interface hardware registers. These settings implement the necessary timing to enable the transfer of a single message between the PROFIBUS Master Unit and a slave device. The other part of the Bus Parameters must be calculated. These parameters implement the overall cyclic timing as well as the watchdog time to monitor the communication.

The calculation is performed by the PROFIBUS Master Unit DTM. The software implements a formula to calculate the settings which will be downloaded to the PROFIBUS Master Unit. Most of the parameters have baud rate dependent default values. Some of the parameters can be tuned by the user. However, this is not recommended, since the communication may not function correctly, due to incorrect settings or too small timing margins.

This appendix defines the parameters which are shown by the PROFIBUS Master Unit DTM, and provides the formula used for the timing calculations.

A-2 Bus Parameter definitions

The figure below shows the PROFIBUS Master Unit DTM, Bus Parameter tab, in which the bus parameter settings can be made.

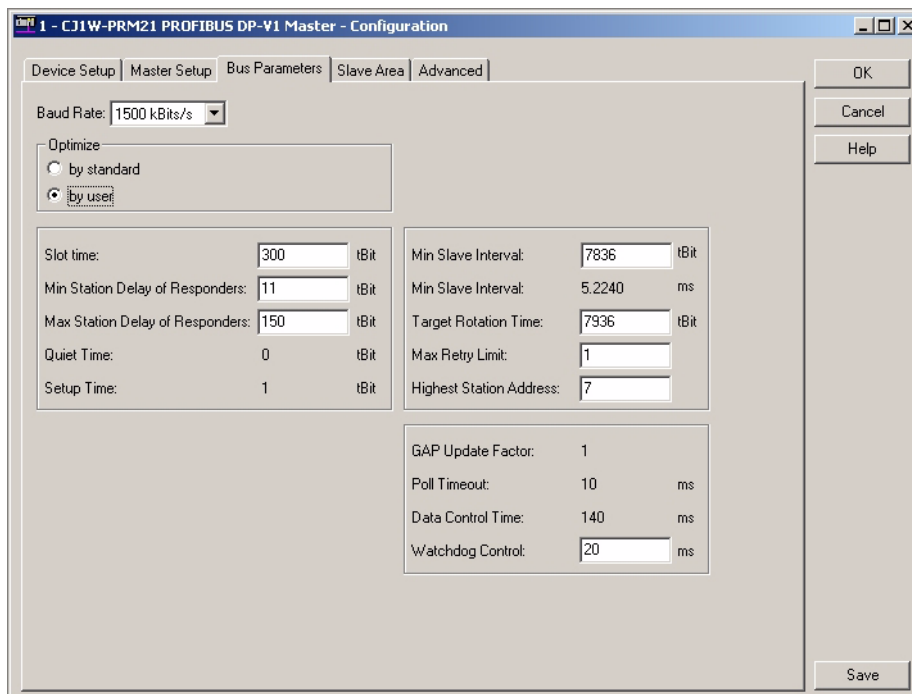

The table below defines the bus parameter settings options, shown in the figure. The Unit t_{BIT} is defined as the transmission time for one bit at the selected baud rate.

Item	Symbol	Description	Unit	Editable by User
Baud rate	--	Defines the transmission rate on the PROFIBUS DP Network. The following baud rate values are defined by the PROFIBUS DP standard: <ul style="list-style-type: none"> • 9.6 • 19.2 • 45.45 • 93.75 • 187.5 • 500 • 1500 (default value) • 3000 • 6000 • 12000 	kBits/s	Yes
Optimize	--	The Optimize setting defines whether or not selected parameters can be changed by the user. <ul style="list-style-type: none"> • By Standard Forces the user to use the default (optimized) settings. • By User Makes selected fields editable. <p>Note</p> <ol style="list-style-type: none"> 1. If the By User option is selected and changes have been made, it is still possible to switch between Optimize settings, without the changes being lost. 2. If the By User option is selected and the baud rate is changed, the parameters will be optimized to the new baud rate. 	--	Yes
Slot Time	T_{SL}	The maximum time a Master Unit must wait for a response to a request message.	t_{BIT}	Yes
Min. Station Delay of Responders	min T_{SDR}	The minimum allowed time for a slave device before it will generate a response to a request message.	t_{BIT}	Yes
Max. Station Delay of Responders	max T_{SDR}	The maximum allowed time for a slave device to generate a response to a request message.	t_{BIT}	Yes
Quiet Time	T_{QUI}	The time a transmitting device must wait after the end of a message frame, before enabling its receiver.	t_{BIT}	No
Setup Time	T_{SET}	The time between an event and the necessary reaction.	t_{BIT}	No
Min. Slave Interval	--	The Minimum Slave Interval defines the poll cycle, i.e. the minimum time between two consecutive Data_Exchange Cycles to the same slave device. The Minimum Slave Interval must be smaller than the Target Rotation Time.	ms	Yes
		Calculated Minimum Slave Interval in milliseconds.	ms	No
Target Rotation Time	T_{TR}	The anticipated time for one token cycle, including allowances for high and low priority transactions, errors and GAP maintenance. Do not set the value below the calculated value, to avoid bus communication interruptions.	t_{BIT}	Yes
Max Retry Limit	--	Maximum number of request transmission retries by this master if a device does not reply to a request.	--	Yes

Item	Symbol	Description	Unit	Editable by User
Highest Station Address	HSA	The HSA defines the Highest Master device address on the network, of which the Master device will request the FDL status, when updating the active device list (See GAP Update Factor). Shows the device address of the master. If new slaves are added to the network, this field shows the highest device address. The Master will periodically check whether new active devices have been added between address its own address and the Highest Station Address. If any devices are detected, GAP is updated. Permissible values are in the range of 0 to 126.	--	Yes
GAP Update Factor	G	The GAP update factor defines the amount of updates of the active devices (i.e. Master devices) list times during one token rotation cycle. To update the list, the Master device will transmit FDL_Status_request messages to ascending device addresses until it finds a next Master device, or until it reaches the Highest Station Address (See HSA below). The GAP Update Factor is fixed to 1.	--	No
Poll Timeout	--	The maximum time interval that this master device may need for the execution of a master-master function.	ms	No
Data Control Time	--	The cycle time in which the master updates its Data Transfer List, in which it keeps an overview of all slave states. Data Control Time is based on the Watchdog time T_{WD} : Data Control Time = $7 * T_{WD}$.	ms	No
Watchdog Control	T_{WD}	The Watchdog Control Time defines the time for a slave device to set its outputs to a fail-safe state, if during that time no communication between the Master device and that slave device was detected. The Watchdog is automatically set for all configured slaves, based on the value of T_{TR} .	ms	Yes

A-3 Determining the Bus Parameters

The bus parameters defined in the previous paragraph are used to configure the PROFIBUS DP hardware interface and to calculate the cycle time for I/O data exchange as well as the watchdog value. Most of the parameters, set in the Bus Parameter Tab are directly transferred to the interface hardware registers. The table below, lists these parameters, along with their default value for the available baud rates. These values are also the minimum values for each parameter at a given baud rate.

Baud rate [kBits/s]	T_{QUI} [t _{BIT}]	T_{SET} [t _{BIT}]	T_{SL} [t _{BIT}]	G	Retry Limit	Poll Timeout [ms]	min T_{SDR} [t _{BIT}]	max T_{SDR} [t _{BIT}]
9.6	0	1	100	1	1	10	11	60
19.2	0	1	100	1	1	10	11	60
45.45	0	95	640	1	1	10	11	400
93.75	0	1	100	1	1	10	11	60
187.5	0	1	100	1	1	10	11	60
500	0	1	200	1	1	10	11	100
1500	0	1	300	1	1	10	11	150
3000	3	4	400	1	2	10	11	250
6000	6	8	600	1	3	10	11	450
12000	9	43	1000	1	4	10	11	1600

The parameters to calculate are:

- Min. Slave Interval (t_{BIT})
- Target Rotation Time (t_{BIT})
- Watchdog timeout (ms)
- Data Control Time (ms)

These four values depend on the number of slave devices allocated to the PROFIBUS Master Unit, the number of I/O bytes each of the slave devices will exchange with the Master Unit, and how many other Master Units are on the PROFIBUS network at the same time. Furthermore, the Unit will require additional time to process the PROFIBUS I/O data and exchange this with the PLC CPU.

Based on this, the Min. Slave Interval value for one Master Unit can be calculated as follows:

$$\text{Min. Slave Interval} = A_1 + (B_1 * \text{slave devices}) + (C_1 * \text{bytes to transfer}) + (\text{bits per } \mu\text{s}) * ((A_2 * \text{slave devices}) + B_2 * \text{modules}) + (C_2 * \text{Words to exchange}) [1]$$

in which: A_1, B_1, C_1 are constants (in t_{BIT}) determining the PROFIBUS DP cycle time on the bus,
 A_2, B_2, C_2 are constants (in μs), determining the cycle time between the Unit and the PLC CPU,
 slave devices are the devices allocated to this Master Unit only,
 modules are the total number of I/O modules, selected for the slave devices.

$$T_{TR} = \sum(\text{Min. Slave Interval}_{\text{Master}}) [2]$$

The total Target Rotation Time is calculated as the sum of all individual Min. Slave Interval values for each Master Unit on the PROFIBUS network.

From the total Target Rotation Time the Watchdog time for each slave device is calculated as follows:

$$T_{WD} = 3 * T_{TR} / \text{Baud rate} [3]$$

in which: T_{TR} is the total Target Rotation Time in t_{BIT} .
 Baud rate is the selected baud rate value.

The Watchdog Time value is in turn used to calculate the total Data Control Time:

$$\text{Data Control Time} = 7 * T_{WD} [4]$$

Based on measurements, the following values have been determined for the 6 factors in equation [1]:

Baud rate [kBits/s]	A1 [t_{BIT}]	B1 [t_{BIT}]	C1 [t_{BIT}]	Minimum Min. Slave Interval	
				[t_{BIT}]	[ms]
9.6	414	280	11	1250	130
19.2	418	280	11	1250	65.1
45.45	1942	361	11	1250	27.5
93.75	450	280	11	1250	13.3
187.5	1390	310	10	1250	6.67
500	2183	310	10	1850	3.7
1500	4339	310	11	4800	3.2
3000	11578	410	5	9600	3.2
6000	23556	800	10	19200	3.2
12000	47112	1600	20	38400	3.2

A2: 65.1 μs , B2: 2 μs , C2: 0.5 μs

Appendix B

Slave Diagnostics Message

B-1 Slave Diagnostics Data Message

Every PROFIBUS DP slave device has to support the transfer of a cyclic diagnostics message. The contents of these messages allow a PROFIBUS Master Unit to assess the status of the slave device in every state of the communication. The diagnostics message format is defined in the PROFIBUS standard.

The slave diagnostics message consists of at least 6 mandatory bytes. If supported, the slave can send additional extended diagnostics bytes in the same message. The extended diagnostics format is defined in the PROFIBUS standard. The extended bytes are usually only included in the diagnostics message if an event has occurred, which results in extended diagnostics.

In some cases the PROFIBUS Master Unit will itself form a slave Diagnostics message. This is the case if the slave device is not responding to any request sent by the Master Unit. The format of the message will be the same as a message sent by a slave device, but the contents has been sent by the Master Unit.

The last received diagnostics message for each slave device allocated to the PROFIBUS Master Unit can at any time be retrieved from the Unit through the MEMORY AREA READ FINS command.

B-2 MEMORY AREA READ (0101)

In order to retrieve the last received slave diagnostics message from the PROFIBUS Master Unit, the PLC CMND(490) can be used to transmit a MEMORY AREA READ FINS command to the PROFIBUS Master Unit. The MEMORY AREA READ command format is given below.

Command Format



Response format

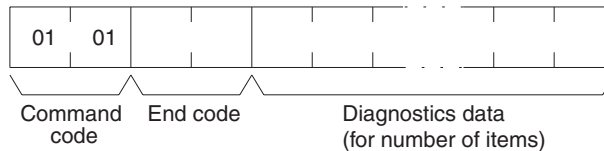

Parameters

- **Data specifier code (command)**
Defines the data to be retrieved from the Unit. Always set to 81 FF 00 (Hex).
- **Slave device address (command)**
Defines the slave device network address. Set to 00 ~ 7D (Hex).
- **Number of items to read (command)**
Defines the number of bytes to read. Set to 1 ~ F4 (Hex).

The diagnostics message is returned from the slave device as a sequence of bytes. When transferred to the PLC memory, the format is converted to words. The format is shown in the figure below. The location in the PLC memory, designated as D is the Destination location as specified in the CMND (490) instruction.

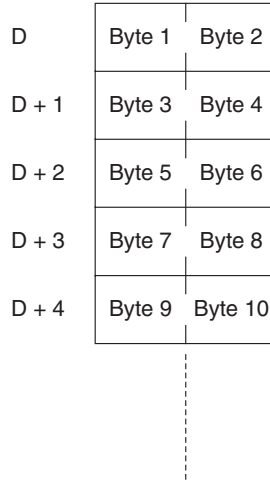

The first 6 bytes or 3 words - Word D ~ Word D+2 - are mandatory bytes, which will always be sent by the slave device. Any additional, i.e. extended diagnostics bytes start at Word D+3. The contents of the first six bytes is defined by the PROFIBUS standard. The contents of the extended diagnostics information is slave device dependent, but the format is defined in the PROFIBUS standard. The first 6 bytes and the Extended diagnostics format are explained below.

B-3 Standard Diagnostics Data Bytes

Slave Diagnostics Byte 1

A layout of Byte 1 is shown below. This byte is mapped to the high-byte of Word D.

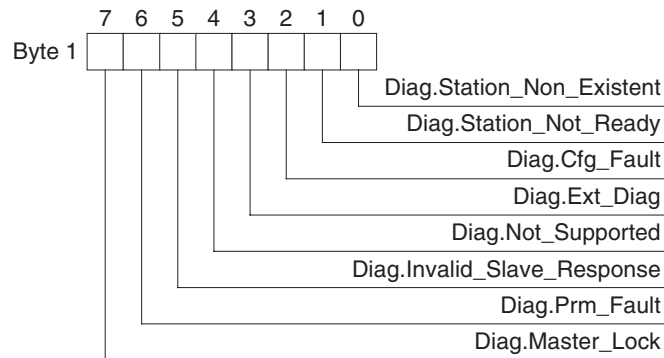

Bit	Name	Description
00	Diag.Station_Non_Existent	This bit is set by the Master Unit if the slave does not respond to any of the request messages sent by the master. If this bit is set the diagnostic bits contains the state of the last diagnostic message or the initial value. The slave device sets this bit to zero in case of a correct response.
01	Diag.Station_Not_Ready	This bit indicates that the slave device is not yet ready for data transfer.
02	Diag.Cfg_Fault	Set by the slave device, this bit indicates that the last received configuration data from the Master Unit are rejected. The configuration data in the slave device differ from the configuration sent by the Master Unit.
03	Diag.Ext_Diag	This bit indicates that the diagnostics message returned by the slave device contains extended diagnostics, i.e. it contains more than the mandatory 6 bytes.
04	Diag.Not_Supported	In case the Master Unit sent a message to the slave device, which is not supported by that device, this bit will be set by the slave device.

Bit	Name	Description
05	Diag.Invalid_Slave_Response	This bit is set by the Master Unit if the slave has returned an invalid response to a Master request message. The slave device will set this bit to 0.
06	Diag.Prm_Fault	Set by the slave device, this bit indicates that the last received parameter data from the Master Unit have been rejected. The parameter data in the slave device differ from the parameter sent by the Master Unit.
07	Diag.Master_Lock	This bit indicates that the slave device has been parameterized by another master. The bit is set by the Master Unit, if the address in byte 4 differs from 255 and from the Master Unit's own address. The slave device sets this bit to zero.

Slave Diagnostics Byte 2

A layout of Byte 2 is shown below. This byte is mapped to the low-byte of Word D.

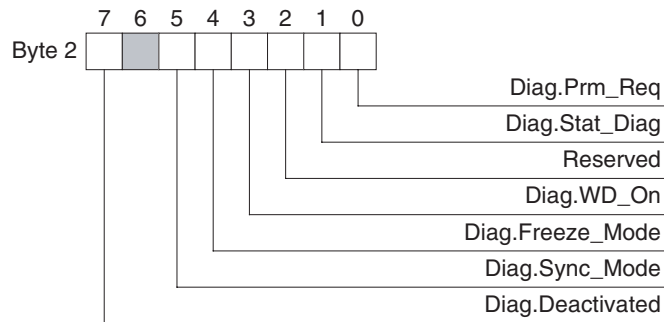

Bit	Name	Description
00	Diag.Prm_Req	This bit is set by the slave device and indicates that it needs to be (re-)parameterized. The slave device is not in Data_Exchange with the Master Unit. The bit remains on as long as it has not been parameterized successfully.
01	Diag.Stat_Diag	This bit indicates static diagnostics at the slave device. The Master Unit will repeatedly request diagnostics data. As long as this bit is set, Data_Exchange with the Master Unit is not being performed.
02	Reserved	This bit is reserved and always set to 1 by the slave device.
03	Diag.WD_On	If the watchdog has been enabled at the slave device (through the appropriate setting in the parameterization message) this bit will be set.
04	Diag.Freeze_Mode	If the slave device has been set to the Freeze mode, using the global command, this bit will be set to on. The bit will be set to off, if an Unfreeze command has been received.
05	Diag.Sync_Mode	If the slave device has been set to the Sync mode, using the global command, this bit will be set to on. The bit will be set to off, if an Unsync command has been received.
06	Reserved	This bit is reserved.
07	Diag.Deactivated	This bit is set by the Master Unit, indicating that the slave device has been disabled (i.e. using the STOP FINS command). The slave device is allocated to the Master Unit, but removed from cyclic processing.

Slave Diagnostics Byte 3

A layout of Byte 2 is shown below. This byte is mapped to the high-byte of Word D + 1.

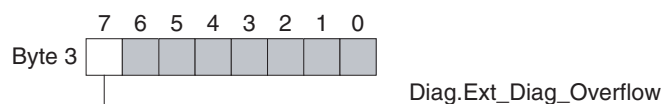

Bit	Name	Description
00 ~ 06	Reserved	These bits are reserved and always set to 0 by the slave device.
07	Diag.Ext_Diag_Overflow	If set, this bit indicates that there exists more diagnostic information than specified in Ext_Diag_Data. This bit will - for example - be set if the slave device has more diagnostics available than it can enter in its send buffer. This bit will also be set if the Master Unit receives more diagnostic information than it can enter in its diagnostic buffer.

Slave Diagnostics Byte 4

Slave Diagnostics Byte 4 is mapped to the low byte of Word D+1. This byte contains the PROFIBUS address of the Master Unit, which parameterized the slave. If the slave is not parameterized correctly, the byte contains FF (Hex) or 255 (Decimal).

Slave Diagnostics Bytes 5 to 6

Slave Diagnostics Bytes 5 and 6 are mapped to Word D+2. They contain the PROFIBUS Ident Number of the slave device. The Ident number uniquely identifies the type of device. The Ident Number is a 16-bit code issued by the PROFIBUS Organization. For example, the Ident number of the CJ1W-PRT21 PROFIBUS DP slave is 0602 (Hex).

B-4 Extended Diagnostics Data Bytes

The afore mentioned 6 diagnostics bytes are a mandatory minimum, which is supported by every PROFIBUS DP slave device. Depending on the device however, it may also support extended diagnostics information, which is coded into the bytes following the first 6 mandatory bytes. The number of extended bytes depends on the coding and the events that have occurred in the slave device. Normally, they will not be added to the standard diagnostics message, i.e. the first 6 mandatory bytes, if no event occurred.

There are three types of extended diagnostics information:

- Device related diagnostics
- Module related diagnostics
- Channel related diagnostics

The Module related diagnostics, are usually followed by the Channel related diagnostics. Both the Device related diagnostics and the Module / Channel related diagnostics can occur in one message.

Device Related Diagnostics

The Device related diagnostics data block consist of a header byte followed by one or more device dependent diagnostics data bytes. The header byte indicates the type of diagnostics data and the total length of the data block. The header byte layout is shown below.

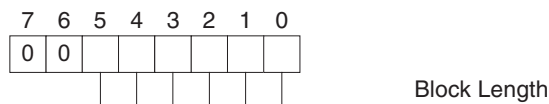

Bit	Name	Description
00 ~ 05	Block length	These bits contain the length of the Device related diagnostics data block, including the header byte. The Device diagnostics will follow this header byte. Maximum length of the block, including the header is 63 bytes. Interpretation of the diagnostics bytes in this block is device dependent.
06 ~ 07	Reserved	Fixed to 00. The combination of bit 6 and 7 indicate the type of diagnostics, i.e. 00 indicates Device related diagnostics data.

Note The Device related diagnostics as defined above is according to the PROFIBUS-DP standard. With the release of the PROFIBUS DP-V1 standard, the Device related diagnostics contents has been re-defined to accommodate diagnostics from slave devices supporting PROFIBUS DP-V1.

Module Related Diagnostics

The Module or Identifier related diagnostics data block consist of a header byte followed by one or more bytes containing flags, which indicate if there is diagnostics pending related to the I/O configuration modules. Each flag is related to the corresponding I/O module, defined during configuration. Non-used flags are always set to 0.

The figure below shows the header byte, and one module diagnostics byte. Depending on the number of I/O modules configured, there may be more bytes.

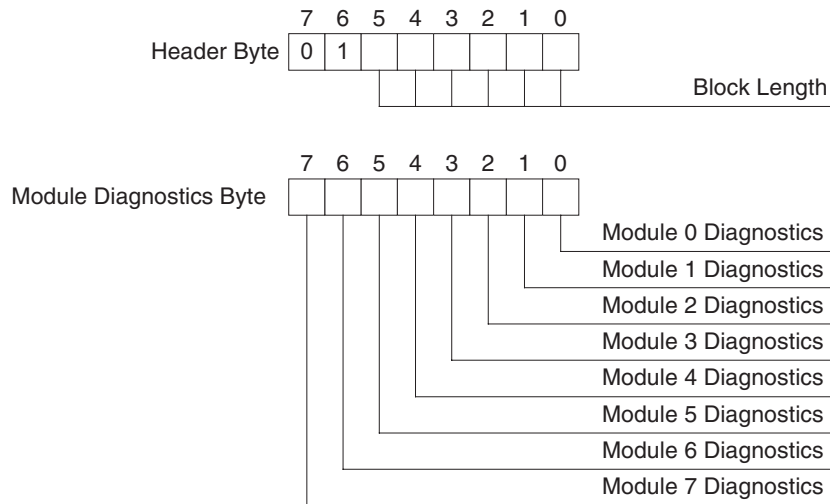

Header byte

Bit	Name	Description
00 ~ 05	Block length	These bits contain the length of the Module related diagnostics data block, including the header byte. The Module diagnostics flags will follow this header byte. Maximum length of the block, including the header is 63 bytes.
06 ~ 07	Reserved	Fixed to 01. The combination of bit 6 and 7 indicate the type of diagnostics, i.e. 01 indicates Module related diagnostics data.

Module Diagnostics byte

Bit	Name	Description
00	Module 0 Diagnostics	When set, this bit indicates that there is Diagnostics information pending related to configuration module 0, i.e. the first configuration module.
01	Module 1 Diagnostics	When set, this bit indicates that there is Diagnostics information pending related to configuration module 1.
02	Module 2 Diagnostics	When set, this bit indicates that there is Diagnostics information pending related to configuration module 2.
03	Module 3 Diagnostics	When set, this bit indicates that there is Diagnostics information pending related to configuration module 3.
04	Module 4 Diagnostics	When set, this bit indicates that there is Diagnostics information pending related to configuration module 4.
05	Module 5 Diagnostics	When set, this bit indicates that there is Diagnostics information pending related to configuration module 5.
06	Module 6 Diagnostics	When set, this bit indicates that there is Diagnostics information pending related to configuration module 6.
07	Module 7 Diagnostics	When set, this bit indicates that there is Diagnostics information pending related to configuration module 7.

Consecutive bytes contain the diagnostics flags for Module 8 through 15, 16 through 23, etc.

The Module related diagnostics information is usually followed by the Channel related diagnostics, which contain the actual diagnostics data per module.

Channel Related Diagnostics

Channel related diagnostics contain diagnostics information related to a specific channel in a configured I/O module, e.g. over peak current detected on current input channel 2, module 0.

The Channel related diagnostics information entry in the diagnostics message, always consists of three bytes, which are outlined below. From these bytes the actual event can be deduced.

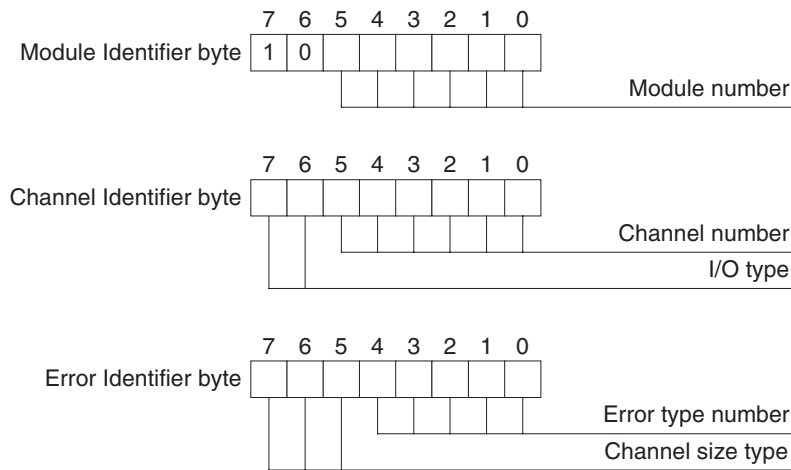

Module Identifier byte

Bit	Name	Description
00 ~ 05	Module number	These bits contain the number of the configuration module, to which the channel, reporting diagnostics belongs. The module number ranges from 0 to 63.
06 ~ 07	Reserved	Fixed to 10. The combination of bit 6 and 7 indicate the type of diagnostics, i.e. 10 indicates Channel related diagnostics data.

Channel Identifier byte

Bit	Name	Description
00 ~ 05	Channel number	These bits contain the number of the channel, which reports the diagnostics. The channel number ranges from 0 to 63.
06 ~ 07	I/O type	Bit 6 and 7 indicate the type of I/O channel, from which the diagnostics data is sent. <ul style="list-style-type: none"> • 00: Reserved • 01: Input • 10: Output • 11: Input/Output

Error Identifier byte

Bit	Name	Description
00 ~ 04	Error number	These bits contain the number of the error which occurred at the channel. The error number ranges from 0 to 31, and can have the following meaning: <ul style="list-style-type: none"> • 0: Reserved • 1: Short circuit • 2: Under voltage • 3: Over voltage • 4: Overload • 5: Over temperature • 6: Line break • 7: Upper limit value exceeded • 8: Lower limit value exceeded • 9: Error • 10 ~ 15: Reserved • 16 ~ 31: Manufacturer specific
05 ~ 07	Channel size type	Bit 5, 6 and 7 indicate the size of the channel, from which the diagnostics data is sent. <ul style="list-style-type: none"> • 000: Reserved • 001: Bit • 010: 2 Bit • 011: 4 Bit • 100: Byte • 101: Word • 110: 2 Words • 111: Reserved

Example of Extended Diagnostics

Below an example of Extended diagnostics data is given, using the definitions above. The 6 mandatory bytes preceding them are not shown.

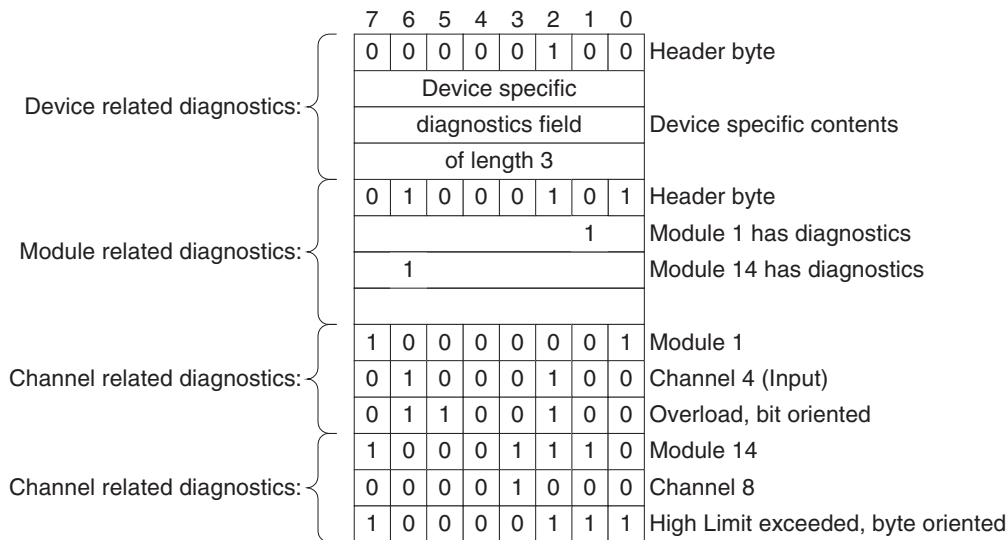

The figure above shows the extended diagnostics of a slave device, which contains:

- **Device related diagnostics:**
One header byte and three device specific diagnostics bytes are shown in this example. The contents of the diagnostics is device specific.
- **Module related diagnostics:**
One header byte and three module diagnostics bytes. The first of three bytes indicates pending diagnostics in module1, the next byte indicates pending diagnostics in module14.
- **Channel related diagnostics:**
Two channel related diagnostics entries are shown: One for module 1 and one for module 14. In module 1, Input channel 4, has detected an overload. In module 14, channel 8, has detected an high-limit exceeded event.

B-5 PROFIBUS DP-V1 Error codes

The Error codes returned by a PROFIBUS DP-V1 slave device are defined in the PROFIBUS DP-V1 Extension to the PROFIBUS standard. This section lists the Error codes, which can be returned as a result of a PROFIBUS DP-V1 MSAC1 services. From these codes, the user can determine the cause of the failure.

The figure below shows the two of the three Error code bytes, returned by a PROFIBUS DP-V1 slave device, in case an MSAC1 service resulted in an error. The third byte, Error code 2, which is not shown below will always contain user specific error codes.

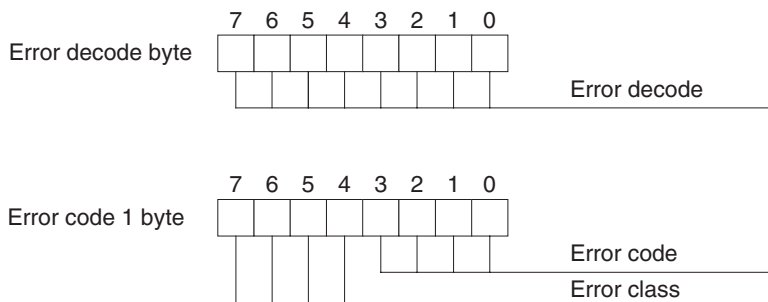

Error decode byte

Bit	Name	Description
00 ~ 07	Error decode	<p>The code determines the protocol type of the slave which returned the error code. Since this error scheme can also be used in network applications containing protocol converters (i.e. gateways), non-PROFIBUS protocols are also defined in this list.</p> <ul style="list-style-type: none"> • 0 to 127: Reserved • 128: PROFIBUS DP-V1 • 129 to 253: Reserved • 254: PROFIBUS FMS • 255: HART®

In case the Error decode byte is 128, i.e. PROFIBUS DP-V1, the Error code 1 byte can have the possible values defined in the table below.

Error code 1 byte

Error class code	Error code	Description	
0 ~ 9	Reserved	--	
10	Application	<ul style="list-style-type: none"> • 0: Read error • 1: Write error • 2: Module failure • 3 to 7: Reserved • 8: Version conflict • 9: Feature not supported • 10 to 15: User specific 	Error codes related to the application, i.e. the slave device it self or I/O modules connected to this device.
11	Access	<ul style="list-style-type: none"> • 0: Invalid index • 1: Write length error • 2: Invalid slot • 3: Type conflict • 4: Invalid area • 5: State conflict • 6: Access denied • 7: Invalid range • 8: Invalid parameter • 9: Invalid type • 10 to 15: User specific 	Error codes related to accessing the requested data area in the slave device or I/O modules connected to the slave device.
12	Resource	<ul style="list-style-type: none"> • 0: Read constrain conflict • 1: Write constrain conflict • 2: Resource busy • 3: Resource unavailable • 4 to 7: Reserved • 8 to 15: User specific 	Error codes related to resources inside the slave device which are required to process the requested data, e.g. functions required to implement a requested action.
13~15	User specific	--	

Error code 2 byte

This error code will always contain user specific error codes. If necessary, refer to the slave device's documentation for decoding the returned byte.

Appendix C

I/O Data Conversions

C-1 I/O Data type definitions

Standard PROFIBUS DP defines two types of I/O data.

- 8-bit bytes sized data.
- 16-bit word sized data.

The standard for PROFIBUS extension, also referred to as PROFIBUS DP-V1, defines the following additional data types:

- 8-bit byte signed / unsigned Integer data.
- 16-bit word signed / unsigned Integer data.
- 32-bit double word signed / unsigned Integer data.
- 32-bit single precision floating point (IEEE754 format).
- ASCII Text strings of indeterminate length (in 8-bit bytes).
- 7 byte Date format.
- 6 byte Time of Day format.
- 6 byte Time Difference format.

The CS1/CJ1-series PLC defines similar data types, which however differ in size and/or storage format in the PLC memory. Since the PROFIBUS Master Units provides an interface between a PROFIBUS network and the CS1/CJ1-series PLC, the Unit will provide the necessary conversions to ensure that the I/O data on the PROFIBUS network is transferred to the PLC memory in the correct format. This Appendix explains the conversions in detail.

C-2 Integer Data Conversions

8-bit Byte Data

The CS1/CJ1-series PLC memory layout is word oriented, and does not support storage of single 8-bit byte data types. The PROFIBUS Master will therefore convert a stream consisting of one or more bytes of data into words. The figure below shows the conversion in graphic format.

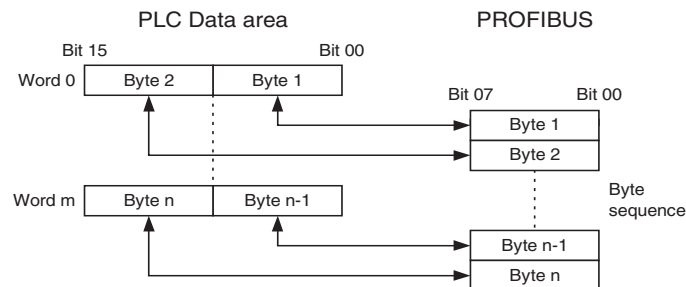

Note $m = (n-1)/2$, rounded to the next lowest integer.

A sequence of bytes transmitted over the PROFIBUS network is copied to the PLC memory in the following procedure.

- The first two bytes are stored in the lowest word of the destination data block in PLC memory word. Every consecutive two bytes are stored in the next higher words.

- Odd byte numbers are copied to the Least Significant byte of a PLC memory word.
- Even byte numbers are copied to the Most Significant Byte of a PLC memory word.
- If the total number of bytes is an odd number, the Most Significant Byte of the last word is filled with 0.

16-bit Word Data

16-bit word data is transferred over the PROFIBUS network with the Most Significant Byte first. The PROFIBUS Master Unit will ensure that a word transmitted or received over PROFIBUS is mapped to one word in the PLC memory area. The figure below shows the conversion in graphic format.

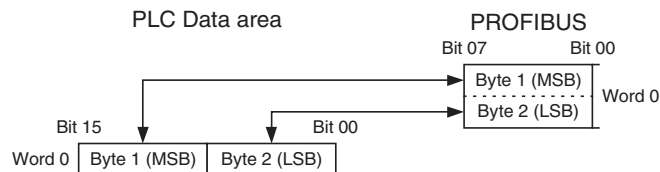

32-bit Double Word Data

32-bit double word data is transferred over PROFIBUS with the Most Significant Byte first. The PROFIBUS Master Unit will ensure that a double word transmitted or received over PROFIBUS is mapped on to CS1/CJ1-series double word format in the PLC memory area. The figure below shows the conversion in graphic format.

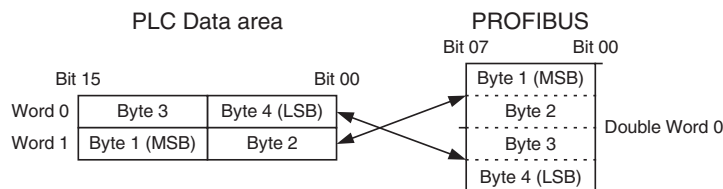

C-3 Floating Point Data Conversions

PROFIBUS defines the IEEE 754 format single precision floating point data type. It is transferred over the network as a 4 byte data, Most Significant Byte first. In the PLC memory area the same data type and size is defined, but data of this type is stored with the Most Significant bytes on the higher memory location and the Least Significant Bytes on the lower memory location. The figure below shows the conversion in graphic format.

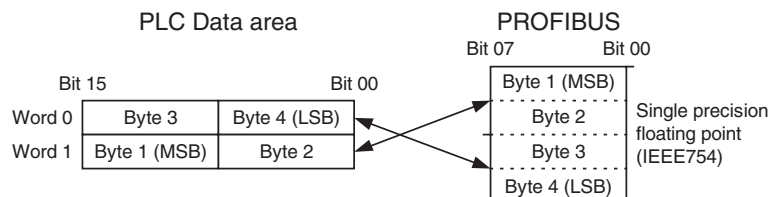

C-4 Text String Data Conversion

PROFIBUS defines ASCII text strings data type. It is transferred over the network as a string of characters. In order to maintain a readable string in the PLC memory, the data is converted to fit the odd character in the Most Significant Byte of the words, and the even characters in the Least Significant Byte of the words. The string is stored on ascending word addresses in PLC memory. The figure below illustrates the conversion.

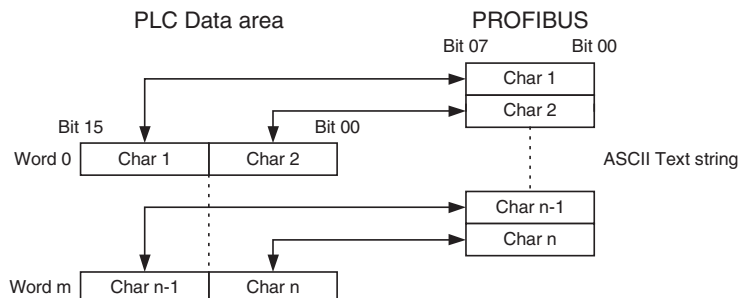

Note $m = (n-1)/2$, rounded to the next lowest integer.

If the number of text characters is even, all bytes will fit in the words, but one additional word will be set to 0000. If the number of bytes is odd, the last byte of the sequence will be mapped to the high-byte of the last word. The low-byte of the last word will be padded with a 0.

C-5 Date / Clock Time Data Conversions

Date, Time and Time Difference data types as defined in PROFIBUS are not supported by the CS1/CJ1-series PLC. To ensure that workable data is transferred from PROFIBUS to the PLC memory, these data types are treated as 16-bit word data. The figure below illustrates the conversion.

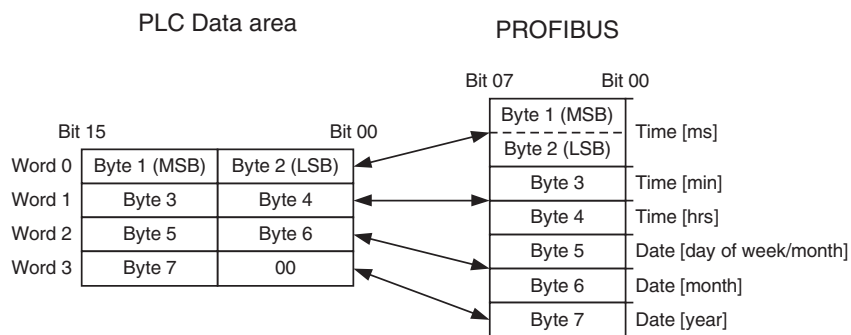

Date and Time information is coded as defined by the PROFIBUS DP standard. The figure and the table below define the format as it is stored in the PLC memory.

	15	14	13	12	11	10	9	8	7	6	5	4	3	2	1	0
Word 0	Time [ms]															
Word 1	Time [min]				SU		Time [hrs]									
Word 2	Day [wk]				Day [month]						Month					
Word 3	Year															

Note The grey areas in the figure above denote reserved bits, which are always set to 0.

Word	Bits	Type	Description	Range
0	00 ~ 15	Time	Milliseconds	0 ~ 59999
1	00 ~ 04		Hours	0 ~ 23
	07		Daylight saving time indication	0: Standard time 1: Daylight saving time
	08 ~ 13		Minutes	0 ~ 59
2	00 ~ 05	Date	Month of the year	0 ~ 12
	08 ~ 12		Day of the month	0 ~ 31
	13 ~ 15		Day of the week	0 ~ 7
3	08 ~ 14		Year	0 ~ 99

Appendix D

Configurator Error and Warning Messages

D-1 Warning Messages

The table below lists the Warning messages which can be displayed by the PROFIBUS Master Unit DTM. These messages usually indicate that the user is about to perform an action, which will have significant impact, or an action which is only partly supported by the Unit. The user is given a chance to abort the function if the impact is undesirable.

Number	Message	Description	When occurring
00	Change the PLC to PROGRAM mode?	In order to start downloading a configuration, the PLC must be set to PROGRAM mode, to prevent I/O data being exchanged with the Unit, during the change of the configuration. <ul style="list-style-type: none"> • Yes Change state and download configuration. • No Stop download. 	At the start of downloading, in case the PLC is in RUN/MONITOR mode.
01	PROFIBUS DP-V1 Slave/slaves is assigned to master. PROFIBUS DP-V1 slaves are not fully supported.	The PROFIBUS Master Unit supports only basic DPV0 functions. This means that the PROFIBUS DP-V1 slave can still be operated, but the PROFIBUS DP-V1 functionality is not possible: <ul style="list-style-type: none"> • OK Close message box. 	At the start of downloading, in case one of the slaves is a PROFIBUS DP-V1 slave.
02	Return the PLC to [mode] mode?	After download with PLC previously in RUN or MONITOR the PLC can be returned to RUN or MONITOR mode <ul style="list-style-type: none"> • Yes Change state. • No PLC remains in PROGRAM mode. • Cancel PLC remains in PROGRAM mode. 	After completing the download.
03	PLC Memory "area overlapping" and/or "exceeding memory range" Save anyway?	One or more of the PLC Memory mappings is incorrect. The I/O data, a part of the I/O data or the PROFIBUS DP-V1 Status Monitoring table is mapped beyond an existing memory area, or two or more mappings are overlapping in memory. <ul style="list-style-type: none"> • Yes Save settings. • No Do not save settings. • Cancel Do not save settings. 	Closing the Configuration User Interface with invalid configuration or saving invalid settings
04	Settings have been changed. Would you like to save?	One or more settings have been changed, but not yet saved. <ul style="list-style-type: none"> • Yes Save data and close DTM. • No Do not save data and close DTM. • Cancel Do not close the DTM. 	Closing the Configuration User Interface without saving the changes.
05	Settings have been changed. Would you like to leave without saving?	Closing the GUI without saving the configuration. <ul style="list-style-type: none"> • Yes Do not save data and close DTM. • No Do not save data and do not close DTM. 	Closing the Configuration User Interface without saving the changes.
06	Compressing will re-allocate slave configuration in [memory area]. Continue? Note [Memory Area] = Input Area 1/ Input Area 2/ Output Area 1/ Output Area 2	Each of the slave I/O data mapping areas can be compressed, by pressing the Compress button. This will result in the DTM filling up all the gaps in the mapping, by moving I/O data from higher addresses closer to the start address of the mapping area. <ul style="list-style-type: none"> • Yes Compress memory area. • No Do nothing. 	When pressing the Compress button in the Slave Area tab, I/O Allocation.

Number	Message	Description	When occurring
07	[I/O area] must be empty. Move all modules into other area Note [I/O area] = output area1/ output area2/ input area1/ input area2	“Not used” item in the start address combo box in output/input allocation tabs can only be selected if there are no I/O module mapped in that area. • OK Close message box. Move modules to other I/O area first.	When selecting the “Not Used” item from the memory area box.
08	Slave_User_data part of the PROFIBUS slave parameter set will be ignored. See slave [no]-[name] Note [no] = slave address [name] = slave DTM name	Slave_User_data part of the slave parameter set will not be used. The additional user parameters in the slave parameter set are not supported by the PROFIBUS Master Unit. • OK Close message box	When adding a slave DTM to the network, which defines additional user parameters.
09	Auto addressing will reallocate slave I/O mapping. Would you like to proceed?	When selecting the Auto-Addressing check box in the Master Setup tab, all slave I/O data mappings will be compressed in each of the I/O mappings. The slave I/O mapping will be changed. • Yes Update slave I/O module mapping and check checkbox. • No Do not update slave I/O module mapping and uncheck checkbox.	When checking the Auto-Addressing check-box on the Master Setup tab.
10	Settings cannot be uploaded, unit must be restarted. Would you like to continue?	The settings uploaded were not used by stack • Yes: Restart the unit and upload the settings. • No: Do nothing.	When attempting to upload settings.
11	Upload is not supported.	Upload is not supported • OK: Close message box.	When attempting to upload settings.
12	After locking address it cannot be changed any more. Would you like to proceed?	When sending Set Device Station Address command with 'Lock' check box is checked, the address will be stored permanently in the Slave device and can not be changed anymore. • Yes: Lock option is checked. • No: Lock option is unchecked.	When 'Lock' check box in the Set Device Station Address GUI is checked.
13	PROFIBUS DP-V1 alarms are not supported by the Master Unit and will be disabled.	Alarm settings set by the Slave DTM are not supported and will be reset. • OK: Close message box.	Downloading settings and one of the alarm bits are set in Slave Parameter Set.
14	Publisher functionality is not supported by the Master Unit and will be disabled.	Publisher functionality set by the Slave DTM is not supported and will be reset. • OK: Close message box.	Downloading settings and the Publisher bit is set in Slave Parameter Set.
15	Isochronous mode is not supported by the Master Unit and will be disabled.	Isochronous mode set by the Slave DTM is not supported and will be reset. • OK: Close message box.	Downloading settings and the Isochronous mode bit is set in Slave Parameter Set.
16	Acyclic Connection / Abort Status Area and Acyclic Slave Timeout settings are not supported by the Master Unit and will be disabled.	The connected Master Unit has version V2.00. The new features for version V3.00 (and up) are not supported by the Master Unit.	Downloading settings to Master Unit V2.00 with Master DTM V3.00 (or up).

D-2 Error Messages - Configuration

The table below lists the Error messages which can be displayed by the PROFIBUS Master Unit DTM in case there are configuration errors. Usually, these are detected either when entering, or up on download. The table suggests corrections to the problems in the right most column.

Number	Message	Description	Correction
00	Total I/O area size exceeds maximum	The I/O configuration exceeds the maximum limit of 7168 (or 7k words).	Change configuration to reduce the amount of I/O data to 7168 words maximum or less.
01	PLC Memory overlapping	Input/Output areas and/or PROFIBUS DP-V1 Status table are overlapping within the current configuration.	Check the Input/Output areas and make sure they are not overlapping. Retry download.
02	PLC Memory exceeds memory range	Input/Output areas and/or PROFIBUS DP-V1 Status table exceeds memory range (combination of start address and length).	Change the configuration to be within the memory area and retry download.
03	Slaves should have unique addresses	Unique bus addresses must be assigned for each slave.	Change the addresses of the slaves and ensure no duplicates are present. Retry download.
04	DTM cannot be added to the network, it is not a PROFIBUS device DTM	The slave DTM cannot be connected, e.g. if adding HART device DTM.	Avoid using non-PROFIBUS DP DTMs.
05	Max. number of slaves configured. New slave cannot be added	DTM can not be added, since the master has already the maximum number of slaves (125) assigned.	Do not add any more DTMs. If more are still needed, a second PROFIBUS Master Unit on the same PLC system may be solution.
06	Slave address overlap detected. New address assigned: [new address]	Changing the address of an existing slave results in an address overlap.	Automatically recovers.
07	Invalid data set received from a slave DTM. Slave parameter changes ignored	An internal error has occurred preventing the master DTM to obtain the slave's parameter set.	Add a new slave DTM into the network (or change the modules of the existing slave) with correct slave parameter set.
08	Set Parameters failed. Slave cannot be configured	An internal error has occurred preventing the master DTM from setting/changing the slave's bus address.	Non recoverable. Master DTM tries to assign a new bus address to the slave DTM, but the slave DTM's database is locked.
09	No slaves assigned. Download aborted	No slaves have been assigned to the master. At least one slave must be assigned.	Retry download when at least one slave has been assigned.
10	Slave(s) has no modules. Download aborted	A slave (or slaves) has no modules.	Retry download when modules have been added to the slave(s) having no modules.
11	Configured EM bank (banks) is not available in the connected PLC. Download aborted	The configured EM bank (banks) are not available in the connected PLC.	Change the configuration to use only memory areas available in the PLC and retry download.
12	Connected unit is busy. Download aborted	Unit is busy with parameter storage.	Retry download when parameter storage has finished.
13	Slave configuration too big	The total number of configured parameter bytes and configuration bytes does not fit into the FINS message for downloading.	Reduce the configuration.
14	Maximum number of modules exceeded	The total number of configured I/O modules over all allocated slave devices can not exceed 4000.	Do not add any more modules to the configuration.

Number	Message	Description	Correction
15	PROFIBUS Master is not in correct mode. Please set the PROFIBUS Master in one of the following modes: STOP, CLEAR or OPERATE.	The Set Device Station Address command can not be executed because the PROFIBUS Master is not in correct mode, i.e. the Master Unit is OFFLINE.	Set the PROFIBUS Master into one of the following modes: STOP, CLEAR or OPERATE.
16	Master Unit indicated failure of Set Device Station Address.	When sending Set Device Station Address command, one of the following problems occurred: <ul style="list-style-type: none"> • The slave has deactivated this service. • The slave has not responded to the request. • The slave does not have sufficient memory space for the request data. 	<ul style="list-style-type: none"> • Check target Slave device on the PROFIBUS network. • Check specified Slave address. • Check Slave timeout parameter
17	'New address' and/or 'Ident number (hex)' are/is empty.	No data is entered in the New Address and Ident Number fields.	Fill-in both the 'New address' and the 'Ident number (hex)' fields.
18	Slave/Master DTM does not accept the specified address.	The DTM has not accepted the new address setting. Possible cause is that the slave DTM data set has been locked for parameter changes.	
19	Master Unit version and DTM version do not match. Please select DTM that can be used with the connected device (refer to section 1-3-2 Specifications).	The selected DTM is not suitable to configure the connected PROFIBUS Master.	Please use the DTM as specified in the error message.

D-3 Error Messages - Communication

The table below lists the Error messages related to CX-Server communication between the PROFIBUS Master Unit DTM and the PLC.

Number	Message	Description	Correction
50	Communication Failure with Unit	The communication between the PC and the Unit on the PLC could not be achieved.	<ul style="list-style-type: none"> • Ensure there are no problems with the connection between the Personal Computer and the PLC. • Ensure the Master Unit has been correctly mounted - Refer to section 2-2 <i>Installing the CS1/CJ1W-PRM21 Units</i> for detailed information. • Make sure the Device settings are correct. • Perform one of the following successfully to confirm the problem has been solved: <ul style="list-style-type: none"> * Download configuration * Communication Test in Device Settings tab * Update monitoring data (Slave Diagnostics, clearing error log).

Number	Message	Description	Correction
51	Communication Failure with PLC	The communication between the PC and the PLC could not be achieved.	<ul style="list-style-type: none"> • Ensure there are no problems with the connection between the Personal Computer and the PLC. • Make sure the Device Settings are correct. • When problem has been removed, disconnect and re-connect. Perform one of the following successfully to confirm the problem has been solved: <ul style="list-style-type: none"> * Update monitoring data (Slave Diagnostics, clearing error log). * Changing the master state
52	CX-Server could not be configured	Configuration of CX-Server failed.	<ul style="list-style-type: none"> • Make sure the settings within the Device Set-up tab are correct. Select the Test Button to check this. • Make sure the Personal Computer COM port selected within the Device Set-up Configuration is not in use by another application. If it is close the connection from within the other application. • Restart CX-Profibus. • Restart Personal Computer to ensure COM port is released. • Ensure the correct version of CX-Server is installed on the Personal Computer. Refer to the Master Manual for installation details. <p>When the problem has been removed, perform one of the following successfully to confirm the problem has been solved:</p> <ul style="list-style-type: none"> * Select the Configure Button in the Device Set-up tab * Select the Test Button in the Device Set-up tab
53	CX-Server could not be initialized	Initialization of CX-Server was not possible.	<ul style="list-style-type: none"> • Ensure the correct version of CX-Server is installed on the Personal Computer. Refer to the Master Manual for installation details.

D-4 Error Messages - System

The table below lists the Error messages related to the System on which the DTM is installed.

Number	Message	Description	Correction
100	Connected device can not be configured with this DTM	Incorrect firmware type.	Make sure the unit connected is a CS1W-PRM21 or CJ1W-PRM21. Make sure the Unit number in the Device set-up corresponds to the physical unit.
101	Incorrect version of CX-Server.	Incorrect version of CX-Server.	Make sure the correct CX-Server version is installed. Version must be 1.7 and up.

Number	Message	Description	Correction
102	[Name of the function] called with improper parameters	Container called a function with NULL pointer.	There must be problem in the container. Reinstall CX-Profibus, if problem persists contact supplier.
103	Received XML Document does not fit its XML schema	Container called a function with an improper XML document.	There must be a problem in container program. Reinstall CX-Profibus, if problem persists contact supplier.
104	Ole Register Drop Target Failed	An internal error has occurred.	Reinstall CX-Profibus, if problem persists contact supplier.
105	Undefined control type	An internal error has occurred.	Reinstall CX-Profibus, if problem persists contact supplier.
106	Communication failure with the DTM	An internal error has occurred.	Reinstall CX-Profibus, if problem persists contact supplier.
107	GUI could not be closed	An internal error has occurred.	Reinstall CX-Profibus, if problem persists contact supplier.

Appendix E

Memory Card Backup Functions

E-1 Outline of Functions

The PROFIBUS Master Unit stores the following setup data in the internal non-volatile memory (Flash ROM).

- Bus Parameters set
- Allocated slave parameter sets.

All these parameter sets can be backed up to and restored from a Memory Card mounted to the CPU Unit. If the parameter data of a good functioning PROFIBUS Master Unit has been saved on a Memory Card, this saved data can be used to perform a quick configuration, when replacing the PROFIBUS Master Unit, without the direct use of the Configuration software. The data can be backed up to a Memory Card only. It cannot be backed up to a EM file.

The backup process does not only involve the backup of the PROFIBUS Master parameter data, but also the parameter data of any other Special CPU Bus Unit on the same PLC, as well as the PLC program, parameter area data, and I/O memory data. This function can be executed in any operating mode.

When performing a backup from the PROFIBUS Master Unit to the Memory Card, the parameter sets are stored in the file BACKUPnn.PRM, where nn is the Unit number in 2-digit hexadecimal.

Note This function is not supported by CS-series CS1 CPU Units that are pre-EV1.

Note With the release of CS1/CJ1W-PRM21 PROFIBUS DP-V1 Master Units, Unit version 2.0, the parameter sets, which are written to the Memory Card have been changed slightly. A Unit with Unit version 2.0 can still restore its parameter sets from a Memory Card written with an older CS1/CJ1W-PRM21, but an older CS1/CJ1W-PRM21 will not restore its data from a Memory card, written with a newer CS1/CJ1W-PRM21 Unit.

E-2 Backing Up Unit Setup Files

In order to save the Unit's parameter sets to the Memory Card mounted to the CPU Unit, perform the following procedure (see figure below).

1. Make sure that the parameter sets in the Unit are correct and that the Unit starts up normally, and insert a Memory Card into the Card slot.
2. Turn ON pin 7 of the DIP switch on the front of the CPU Unit (behind the cover above the Memory Card slot).
3. Press and hold the Memory Card power supply switch for 3 seconds. When the switch is pressed, the MCP-WR Indicator on the front of the CPU Unit will flash once and then remain lit while the data is being written. The indicator will go OFF after the data has been written properly. During the transfer to the Memory Card, the Parameter Transfer in Progress bit in Unit Status Word (CIO Word n+4) will turn ON.

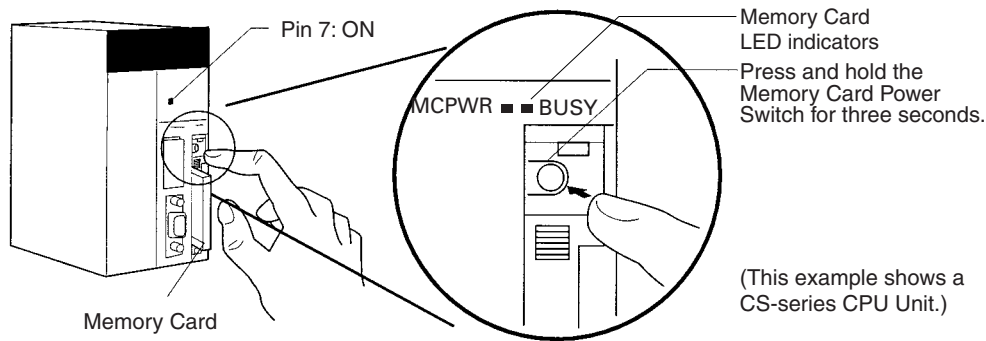

E-3 Restoring Unit Setup Files

In order to restore the Unit's parameter sets from the Memory Card mounted to the CPU Unit, perform the following procedure.

1. Power down the PLC and insert a Memory Card into the Card slot.
2. Turn ON pin 7 of the DIP switch on the front of the CPU Unit (behind the cover above the Memory Card slot).
3. Turn ON the PLC's power supply.
4. When the PLC's power is turned ON, the MCPWR Indicator on the front of the CPU Unit will light and flash once. The MCPWR Indicator will remain lit while the data is being read. The Indicator will go OFF after the data has been read properly. During the Data Transfer, the PRM LED on the front of the Unit will flash, and the Parameter Transfer in Progress bit in Unit Status Word (CIO Word n+4) will turn ON.
5. Restart the PLC.

- Note**
1. Data will not be read from the Memory Card to the CPU Unit if pin 1 of the DIP switch is ON (write-protecting program memory).
 2. A CS1-H, CJ1-H, or CJ1M CPU Unit will remain in PROGRAM mode after the simple backup operation has been performed and cannot be changed to MONITOR or RUN mode until the power supply has been cycled. After completing the backup operation, turn OFF the power supply to the CPU Unit, change the settings of pin 7, and then turn the power supply back ON.
 6. File backups may take from several seconds to several minutes. Refer to *CS/CJ-series Programming Manual (W394)* for information on execution times.
 7. If an error occurred in the transfer from the Memory Card to the Unit, the File Read Error bit in Unit Status Word (CIO Word n + 4, bit 09) will turn ON. To correct this, re-perform the Restore action. If the problem persists, use CX-Profibus to download the original settings from the PC.

Appendix F

Application Notes

F-1 Introduction

This appendix contains an application note regarding the use of a special ladder program to detect any CS1/CJ1W-PRM21 PROFIBUS Master Unit failures. This programs specifically covers failures due to faulty bus parameters, set by the user.

F-2 Application Note Background

The CS1/CJ1W-PRM21 Master DTM allows the user to change certain bus parameter, in order to further optimize the PROFIBUS network performance. The risk however in doing this is that certain combinations may lead to failures in the communication, either direct, or at a later point in time. The direct result of this failure is that communication between the Master Unit and the PLC CPU - the PLC I/O refresh cycle - will take longer than anticipated.

A ladder program can now be used to detect this, if the application warrants this safety measure. It relies on the fact that non-used software switches (see section 4-2-1 *Software Switches 1 (Word n)*) when set by the user program, are always reset by the Master Unit.

F-3 Application Program

The ladder program, as shown in the figure below, will regularly set switch number 15 in the Software Switches 1 word (CIO Word n, where n in the example is 1500), and start a counter. The counter will count the amount of PLC I/O refresh cycles, before the Master Unit resets the switch. If the counter reaches the maximum value (e.g. 40 as in the example ladder program), without the switch being reset, a PLC error will be generated.

The counter must be configured by the user, and depends on the PROFIBUS cycle. The longer that cycle is, the longer the counter has to count up. It is recommended to include a safety margin to avoid the PLC error being generated too soon. An estimate for the value can be made using the formula below.

$$\text{Timer value} = \text{Max} \left(40, \frac{2 \cdot T_{TR}}{\text{min. PLC Cycle}} \right)$$

In the ladder program shown as example below, the minimum value of 40 has been used. The unit number for the example Unit is 0.

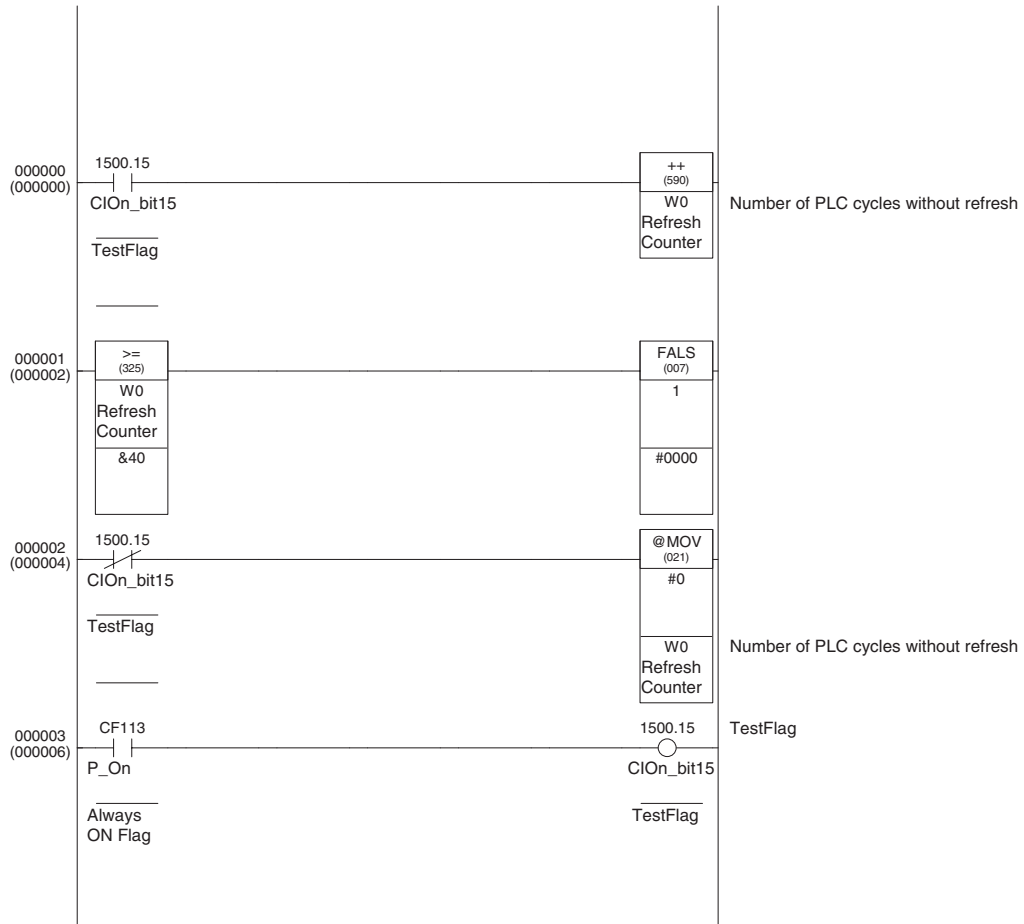

Appendix G

C200HW-PRM21 Notes

G-1 Introduction

This appendix contains notes on the use of the C200HW-PRM21 PROFIBUS DP Master unit on a CS1 PLC System. The C200HW-PRM21 is a special I/O Unit, originally designed for the C200H-series PLC, but can also be used on the CS1-series PLC systems.

G-2 Word allocations

This section provides a brief overview of the memory allocations required by the C200HW-PRM21 for Unit settings and Control and status words. For more details refer to the C200HW-PRM21 PROFIBUS DP Master Unit Operation Manual (W349-E2-□).

MACH No	Unit settings area	Control and Status Area	Error flag	Restart flag
0	DM20000 to DM20017	CIO2000 to CIO2004	AR418.00	AR502.00
1	DM20100 to DM20117	CIO2010 to CIO2014	AR418.01	AR502.01
2	DM20200 to DM20217	CIO2020 to CIO2024	AR418.02	AR502.02
3	DM20300 to DM20317	CIO2030 to CIO2034	AR418.03	AR502.03
4	DM20400 to DM20417	CIO2040 to CIO2044	AR418.04	AR502.04
5	DM20500 to DM20517	CIO2050 to CIO2054	AR418.05	AR502.05
6	DM20600 to DM20617	CIO2060 to CIO2064	AR418.06	AR502.06
7	DM20700 to DM20717	CIO2070 to CIO2074	AR418.07	AR502.07
8	DM20800 to DM20817	CIO2080 to CIO2084	AR418.08	AR502.08
9	DM20900 to DM20917	CIO2090 to CIO2094	AR418.09	AR502.09
A	DM21000 to DM21017	CIO2100 to CIO2104	AR418.10	AR502.10
B	DM21100 to DM21117	CIO2110 to CIO2114	AR418.11	AR502.11
C	DM21200 to DM21217	CIO2120 to CIO2124	AR418.12	AR502.12
D	DM21300 to DM21317	CIO2130 to CIO2134	AR418.13	AR502.13
E	DM21400 to DM21417	CIO2140 to CIO2144	AR418.14	AR502.14
F	DM21500 to DM21517	CIO2150 to CIO2154	AR418.15	AR502.15

Unit Settings

The Unit settings are located in the DM area in the PLC memory. The exact location of the block of settings depends on the Machine Number setting, as set prior to power-up on the front of the Unit using the rotary switch.

The Unit settings define

- the I/O mapping areas and the mapping of the slave status data,
- the data exchange procedure (synchronous or asynchronous)
- the Units behaviour in case of a fatal PLC error (CLEAR or HOLD outputs)

The Unit can be operated in a default mode, i.e. all DM settings set to 0000. The table below lists the contents of the Unit settings.

Word m [m = DM 20000 + (100 x Machine number)]

DM word	Function	Value	Description
m	Number of output data areas	0000	Default mapping. PLC addresses CIO0050 to CIO0099 are mapped to Unit output buffer bytes 000 to 099
		0001	One user-defined output data area. DM word m+1, m+2 and m+3 define the first area.
		0002	Two user-defined output data areas. DM word m+4, m+5 and m+6 define the second area.
		Other	Default mapping (see 0000)
m+1	Output Area 1: Start address in the Unit output buffer	0000 to 0510	Byte 000 ~ 510 (even) in output buffer of the Unit
		Other	Setting error, output area is ignored (See Note 1)
m+2	Output Area 1: Start address in the Unit output buffer	0000 to 5999	D00000 ~ D05999
		A000 to A235	CIO0000 ~ CIO0235
		A300 to A511	CIO0300 ~ CIO0511
		B000 to B099	HR000 ~ HR099
		C000 to C063	CIO1000 ~ CIO1063
		Other	Setting error, output area is ignored (See Note 1)
m+3	Output Area 1: Size	0000 to 0100	0000 ~ 0100 words to be transferred from PLC to the Unit output buffer (See Note 1 and 2)
m+4	Output Area 2: Start address in the Unit output buffer	See m+1	
m+5	Output Area 2: Start address in the Unit output buffer	See m+2	
m+6	Output Area 2: Size	See m+3	
m+7	Number of input data areas	0000	Default mapping. PLC addresses CIO0050 to CIO0099 are mapped to Unit input buffer bytes 000 to 099
		0001	One user-defined input data area. DM word m+8, m+9 and m+10 define the first area.
		0002	Two user-defined input data areas. DM word m+11, m+12 and m+13 define the second area.
		Other	Default mapping (see 0000)
m+8	Input Area 1: Start address in the Unit input buffer	0000 to 0510	Byte 000 ~ 510 (even) in input buffer of the Unit
		Other	Setting error, input area is ignored (See Note 1)
m+9	Input Area 1: Start address in the Unit input buffer	0000 to 5999	D00000 ~ D05999
		A000 to A235	CIO0000 ~ CIO0235
		A300 to A511	CIO0300 ~ CIO0511
		B000 to B099	HR000 ~ HR099
		C000 to C063	CIO1000 ~ CIO1063
		Other	Setting error, input area is ignored (See Note 1)
m+10	Input Area 1: Size	0000 to 0100	0000 ~ 0100 words to be transferred from PLC to the Unit input buffer (See Note 1 and 2)
		Other	Setting error, input area is ignored (See Note 1)
m+11	Input Area 2: Start address in the Unit input buffer	See m+8	
m+12	Input Area 2: Start address in the Unit input buffer	See m+9	

DM word	Function	Value	Description
m+13	Input Area 2: Size	See m+10	
m+14	Slave status data mapping	0001	User-defined mapping. Area defined by DM m+15.
		Other	Default mapping to CIO0200 to CIO0215
m+15	Start address in user-defined mapping mode (Area size = 16 words)	0000 to 5984	D00000 ~ D05984
		A000 to A220	CIO0000 ~ CIO0220
		A300 to A496	CIO0300 ~ CIO0496
		B000 to B084	HR000 ~ HR084
		C000 to C048	CIO1000 ~ CIO1048
		Other	Default mapping to CIO0200 to CIO0215
m+16	Data Exchange procedure	0000	Fieldbus cycle asynchronous with PLC cycle (Default) The fieldbus cycles are triggered independently (i.e. asynchronous) of the PLC cycle, providing optimal I/O response time when the PLC cycle time is at least twice the fieldbus cycle time.
		Other	Fieldbus cycle synchronous with PLC cycle The fieldbus cycles are triggered at the end of an I/O refresh and are therefore synchronised with the PLC cycle. If the fieldbus cycle time exceeds the PLC program execution time, the next fieldbus cycle will not be triggered until the completion of the next I/O refresh. This method ensures synchronization between PLC cycle and fieldbus cycle.
m+17	Fatal PLC error handling (asynchronous data exchange mode)	0000	CLEAR outputs All output data sent to the slaves will be cleared.
		Other	HOLD outputs All output data sent to the slaves will remain the same as before the occurrence of the Fatal PLC error.

- Note**
- Setting errors are indicated in CIO n+2. Additionally, the ERR LED will be flashing to indicate a non-fatal error.
 - If the specified number of words would make the area exceed the boundaries of the available buffer, DM, LR, CIO or HR areas, the actual number of transferred words will be limited as to remain within all of these boundaries.
 - The Unit does not check the validity of the contents of any PLC data area, from which output data is to be transferred. Any data present in the area will be transferred to the output buffer of the Unit.
 - If multiple fieldbus masters (e.g. PROFIBUS DP, Devicenet, SYSMAC BUS) are mounted on the same PLC system, only one of them can be used in default mapping mode. The Unit does not check if the mapped PLC input area is in use by other Units. If so, this Unit's data may overwrite another Unit's data, or vice versa.
 - If the settings cause two destination areas to overlap, the data of the higher number area will overwrite the lower. This practice must be avoided by the user.

Control Words

The control words for the C200HW-PRM21 PROFIBUS DP Master Unit to allow the PLC CPU program to initiate actions with respect to the PROFIBUS network. In general the following features are provided:

- Change the state of the Unit with respect to transfer of I/O data.
- Clear the mailbox.
- Transmit a Global_Control command over the PROFIBUS network, with specified settings.

The table below lists the two control words and their description of individual bits.

Word n [n = CIO 2000 + (10 x Machine number)]

CIO Word	Bit	Name	Value	Description
n	00	Run	OFF	No exchange of I/O data between PLC and remote I/O, and no processing of mailbox commands will take place. A transition from ON to OFF will clear or hold the outputs depending on the value set in DM m+17. Holding remote outputs is only available in asynchronous data exchange mode.
			ON	Unit in normal operation; exchange of I/O data with PLC, and processing of mailbox commands are enabled.
	01	I/O Communication inhibit	OFF	I/O communication is enabled.
			ON	I/O communication is disabled. A transition from OFF to ON changes the PROFIBUS DP network state from 'Operate' via 'Clear' to 'Stop'. All remote outputs will therefore be reset.
	02	Input Mailbox clear	OFF	No specific action.
			ON	Each I/O refresh, one unprocessed response (if available) is removed from the input mailbox.
	03~06	Not Used		
	07	Issue Control command	OFF	No control commands are issued.
			ON	Each I/O refresh, one control command is issued. The control command is specified by CIO n.09~13, and the destination is specified by CIO n+1.
	08	Not Used		
	09	Clear_Data	OFF	Clear_Data bit will not be set in next Global_Control message.
			ON	Set Clear_Data bit in next Global_Control message: Clear output data at slave device.
	10	Unfreeze	OFF	Unfreeze will not be set in next Global_Control message.
			ON	Set Unfreeze bit in next Global_Control message: Unfreeze input data at slave device (See Note 1).
	11	Freeze	OFF	Freeze bit will not be set in next Global_Control message.
			ON	Set Freeze bit in next Global_Control message: Freeze input data at slave device (See Note 1).
	12	Unsync	OFF	Unsync bit will not be set in next Global_Control message.
			ON	Set Unsync bit in next Global_Control message: Unsync output data at slave device (See Note 1).
	13	Sync	OFF	Sync bit will not be set in next Global_Control message.
			ON	Set Sync bit in next Global_Control message: Sync output data at slave device (See Note 1).
	14, 15	Not Used		

CIO Word	Bit	Name	Value	Description
n+1	00~06	Station address	00~ 7D	Selected slave device address.
			7F	Target Global_Control message to all slave devices, which comply with the selected group bits (See bit 08 ~ 15)
	07	Not Used		
	08	Group 1	--	Select individual groups of slave devices, by setting bits associated with the group. Set all group bits to 00 to select all slaves.
	09	Group 2		
	10	Group 3		
	11	Group 4		
	12	Group 5		
	13	Group 6		
	14	Group 7		
15	Group 8			

- Note**
1. The Clear_Data command will always clear the output data, whether the Freeze command is activated or not.
 2. When activated simultaneously, Unsync has priority over Sync, and Unfreeze has priority over Freeze.

Status Words

The status words for the C200HW-PRM21 PROFIBUS DP Master Unit to allow the PLC CPU program to determine the status of the Unit as well as the PROFIBUS network. In general the following features are provided:

- Change the state of the Unit with respect to transfer of I/O data.
- Clear the mailbox.
- Transmit a Global_Control command over the PROFIBUS network, with specified settings. Send

The table below lists the two control words and their description of individual bits

CIO Word	Bit	Name	Value	Description
n+2	00	Input data transferred	OFF	No input data has been transferred to the mapped PLC data area(s) during the last I/O refresh.
			ON	Input data has been transferred to the mapped PLC data area(s) during the last I/O refresh.
	01	Not Used		
	02	Auto-Clear	OFF	Not in Auto_clear mode.
			ON	The master branched into Auto_clear mode, because of a remote node error.
	03	No data	OFF	All remote nodes are in data exchange mode. This bit is also cleared during a database download or when a P-DP H/W failure is detected (CIO n+2.06 is set).
			ON	At least one remote node is not in the data exchange mode or reports a fatal error.
	04~05	Not Used		
	06	P-DP H/W failure	OFF	No error
			ON	Malfunctioning of the PROFIBUS DP hardware.
	07	Wrong CPU unit	OFF	No error
			ON	The Unit is mounted to a PLC type which does not support the C200HW-PRM21.
	08	DM setting error (exceeding max. words)	OFF	No error
			ON	The input/output area mapping, defined by the Unit's DM settings, exceeds the maximum allowed number of words (300 words).

CIO Word	Bit	Name	Value	Description
n+2 (cont'd)	09	DM setting error (output area mapping)	OFF	No error
			ON	There is an error in the output area mapping. The mapping contains an incorrect value for either: <ul style="list-style-type: none"> the start address in the output buffer in the Master, the start address of the output area(s) in the PLC, or the size of the output area(s), or the specified size exceed the boundaries of available buffer, DM, LR, CIO or HR areas.
	10	DM setting error (input area mapping)	OFF	No error
			ON	There is an error in the input area mapping. The DM settings contain an incorrect value for either: <ul style="list-style-type: none"> the start address in the input buffer in the Master, the start address of the input area(s) in the PLC, or the size of the input area(s), or the specified size exceed the boundaries of available buffer, DM, LR, CIO or HR areas.
	11	Control command not processed	OFF	The output mailbox was able to receive and process the previously issued control command message.
			ON	The issued control command could not be processed because the output mailbox was full (see section 5-2) or the RUN-bit was not set or the bus communication was inhibited.
	12	Output mailbox full	OFF	The output mailbox is able to receive (and process) a message. This message can be a control command issued via CIO n or any PROFIBUS command by using the IOWR instruction.
			ON	The output mailbox is full and cannot receive new messages.
	13	Reply in input mailbox	OFF	The input mailbox does not contain a response message to a command message issued with IOWR.
			ON	The input mailbox contains a response message to a command message issued with IOWR.
	14~15	Network state	00	Offline: Communication with all DP participants is stopped.
			01	Stop: Only communication with DP-Master (class 2) is possible.
			10	Clear: The master tries to set parameters, check configuration and perform data exchange with its associated DP-slaves; the slaves' inputs are transferred to the input buffer, their outputs are cleared.
			11	Operate: The master exchanges data with the assigned DP-slaves.
n+3	00~07	Error number	--	Error numbers CIO n+3 contains error messages related to either a specific slave device or the Unit itself. For detailed error code, refer to the C200HW-PRM21 PROFIBUS DP Master Unit Operation Manual (W349-E2-□).
	08~15	Station address	00~7D	The Error number is related to a specific slave device, as indicated by the station number.
			FF	The Error number is related to the Unit itself.
n+4	00~11	Message length	001~128	When CIO n+2.13 is set (Reply in output mailbox), this CIO word contains the length of the message that can be retrieved with an IORD instruction. Combined with the Unit number, this constitutes the correct source information for the IORD instruction. Refer to the C200HW-PRM21 PROFIBUS DP Master Unit Operation Manual (W349-E2-□).
	12~15	Unit number	0~F	

G-3 CIF Driver error messages

This section lists the most common error messages encountered with the serial communication driver for the C200HW-PRM21. Extended error messages are available through the Help files of the C200HW-PRM21 DTM.

Error Number	Description
-20	No COM port found or COM port already in use
-21	COM port already opened
-22	Function call into driver has failed
-23	Internal driver error
-24	Could not create read thread
-25	Could not create read event
-26	Could not create write event
-27	Could not create timer event
-28	Error by writing data
-29	Wrong COM state
-30	COM state error is set
-31	COM buffer setup failed
-32	COM set timeout failed
-33	Receive buffer overrun
-34	Receive buffer full
-35	Send busy
-36	Error during close driver
-40	COM port not opened
-41	Invalid handle value
-42	Invalid COM number
-43	Size parameter invalid
-44	Size parameter zero
-45	Buffer pointer is NULL
-46	Buffer too short
-47	Setup error
-50	Send message, timeout error
-51	Could not send a message
-52	Send message, no device connected
-53	Error by send message, message receiving
-54	Telegram collision
-55	Telegram, no acknowledgement received
-56	Telegram, noise
-57	Telegram, data overrun
-58	Telegram, parity error
-59	Telegram, framing error
-60	User: Telegram, unknown error
-70	Timeout by receive a message
-71	No message received

Index

A

- About
 - Manual, ix
- Acyclic Connection
 - Configuration, 74
 - Connection Abort status flags, 76
 - Connection status flags, 75
- Adding Devices to the Network, 150
- Application, 255
- Auto addressing
 - See* I/O data, Mapping
- Auto-CLEAR, 6, 69
 - Behaviour, 101
 - Enable, 189
 - Feature, 189
 - Resume OPERATE mode after, 189
 - Transition conditions, 189

B

- Basic Operating Procedure, 24
- Broadcast communication
 - See* Global Control
- Bus access protocol, 4
- Bus connector, 40
 - See* Wiring
- Bus parameters, 229
 - Baud rate, 230
 - Data control time, 231
 - Definitions, 229
 - Determining bus parameters, 231
 - GAP update factor, 231
 - Highest station address, HSA, 231
 - Max retry limit, 230
 - Max Tsdr, 230
 - Min slave interval, 230
 - Min Tsdr, 230
 - Poll timeout, 231
 - Quiet time, 230
 - Setup time, 230
 - Slot time, 230
 - Target rotation time, 230
 - Watchdog control, 231
- Bus termination
 - See* Wiring

C

- C200HW-PRM21 DTM, 20
 - Address table tab, 90
 - Adjusting bus parameters, 90
 - Auto addressing, 92
 - Bus parameter tab, 88
 - Changing address mapping, 92

- CIF error messages, 263
 - CIO Control words, 260
 - CIO status words, 261
 - Configuration user interface, 87
 - Configuring communication, 95
 - Connecting, 95
 - Diagnostics user interface, 92
 - Downloading parameters, 95
 - Installation, 52
 - Memory layout, 91
 - Monitoring, 96
 - Sorting I/O modules, 92
 - Unit DM settings, 257
 - Word allocations, 257
- Cable
 - see* Wiring
- CIO Area
 - See* I/O Allocations, CIO Area
- CIP messaging, 198
- Configuring the PROFIBUS DP Master
 - See* C200HW-PRM21 DTM, Configuration
 - See* CS1/CJ1W-PRM21 DTM, Configuration
- CS1/CJ1W-PRM21
 - External dimensions, 16
 - Functional Specifications, 12
 - Protocol Specification, 14
 - Specifications, 12
- CS1/CJ1W-PRM21 dimensions, 16
- CS1/CJ1W-PRM21 DTM, 19
 - Address, 161
 - Auto addressing, 163
 - Auto Update, 190
 - Auto-CLEAR, 162
 - Bus parameter, 163
 - Changing mode, 183
 - Diagnosis User Interface, 190
 - Downloading the configuration, 167
 - Error Log, 195
 - Access from PLC program, 197
 - Clearing, 196
 - Concept, 195
 - Detecting new errors, 195
 - Reading, 196
 - I/O Mapping, 164
 - Manual refresh, 190
 - Master parameters, 161
 - Master setup tab, 161
 - Master Status, 191
 - Monitoring, 190
 - Reading the Master status, 190
 - Set device station address, 76, 154
 - Slave DTM Address assignment, 76, 154
 - Slave status, 191
 - Storing the configuration, 167
 - Unit description, 166

- Unit firmware version, 166
- Unit number, 161
- Unit PLC behaviour, 162
- CX-Profibus
 - CD-ROM, 44
 - Default password, 53
 - Device Catalogue
 - See* Device Catalogue
 - DTM view, 55
 - Error Log view, 55
 - FDT Monitoring view, 55
 - Features, 19
 - Generic slave DTM
 - See* Generic slave DTM
 - Installation
 - Procedure, 44
 - Requirements, 44
 - Login window, 53
 - Main Menu, 55
 - Main window, 54
 - Master DTM
 - See* C200HW-PRM21 DTM
 - See* CS1/CJ1W-PRM21 DTM
 - Network view, 54
 - Specifications, 22
 - Starting, 53
 - Status Bar, 56
 - Tool Bar, 56
- CX-Server
 - Configuring, 165
 - CPU selection, 165
 - Network type, 166
 - Testing the setup, 166

D

- Data conversion
 - See* I/O data, Types, Conversion
- Device address, 152
- Device Catalogue
 - Additional DTM Information, 58
 - DTM group selection window, 58
 - DTM view layout, 57
 - Generating the Device Catalogue, 53
 - Installing GSD files, 59
 - Invoking, 57
 - Main components, 57
 - Open, 149
 - Updating, 59
- Device DTM, 7
- Device profile, 4
- Diagnostic functions, 5
- Diagnostics
 - Channel Related, 5
 - Device Related, 5

- Module Related, 5
- Diagnostics Update Delay, 102
- DM Area
 - See* I/O Allocations, DM Area
- Downloading the configuration, 21
- DTM
 - non-GSD based, 149
 - PROFIBUS DP-V1 services, 20
 - Set device station address, 77
 - Slave DTM address assignment, 77

E

- EC Directives
 - Low voltage, EN 61131-2:1994+A12:2000, xx
- EMC Directives
 - EMI directive, xx
 - EMS directive, xx
- Environment, 13
- Error codes, 223
- Error log, 222
 - Adding records, 222
 - Clearing, 222
 - Error codes, 223
 - Error log location, 222
 - Error log records, 222
 - Logged errors, 222
 - Reading Error log, 222
- Error messages
 - Communication, 250
 - Configuration, 249, 255, 257
 - System, 251
- Error on Cyclic Data Exchange, 102
- Exchanging I/O data, 176
 - I/O response time, 178
 - Minimum I/O response time, 180
 - PLC cycle time performance, 178
 - PLC cyclic refresh, 176
 - PLC vs. PROFIBUS, 176, 177
- Explicit messages
 - See* FINS communication

F

- Fail-safe, 6, 102
- FDT/DTM
 - Communication DTM, 8
 - Device DTM, 7
 - DTM properties, 8
 - DTM versus GSD file, 9
 - FDT Container application, 7
 - FDT/DTM Concept, 7
 - FDT/DTM technology, 7

- User interface, 8
- XML based data transfer, 8
- FINS communication
 - Command codes, 127
 - Command reference
 - CONTROLLER AREA READ (0501), 132
 - ERROR LOG CLEAR (0203), 134
 - ERROR LOG READ (2102), 132
 - EXPLICIT MESSAGE SEND (2801), 134
 - MEMORY AREA READ (0101), 129
 - PROFIBUS MESSAGE SEND (2809), 136
 - RUN (0401), 130
 - STOP (0402), 131
 - Message communication, 126
 - PROFIBUS DP services, 136
 - Get_Cfg service, 141
 - Rd_Inp service, 139
 - Rd_Outp service, 140
 - Set_Slave_Add service, 137
 - PROFIBUS DP-V1 services, 136
 - MSAC1_Read, 142
 - MSAC1_Write, 144
 - Response codes, 127
 - Sending, using CMND, 128
 - Troubleshooting, 225
- Freeze
 - See* Global Control

G-H

- Generic Slave DTM, 20
 - Extended diagnostics, 194
 - Extensions
 - Alarm SAP, 104
 - Alarms, 104
 - Auto-Clear behavior, 101
 - Configuration processing, 101
 - Diagnostics Update Delay, 102
 - DPV1 enable, 103
 - Error on Cyclic Data Exchange, 102
 - Fail-safe behavior, 102
 - Max. Alarm PDU length, 104
 - Max. channel data length, 104
 - Standard diagnostics, 194
- Generic slave DTM
 - Configuring, 155
 - Group assignment, 159
 - I/O Configuration, 156
 - Appending, 156
 - Defining, 155
 - Inserting, 156
 - Removing, 157
 - Parameters, 158
 - Common, 158
 - Module, 158
 - Watchdog, 157

- Global Control
 - Broadcast message, 114
 - Commands, 185
 - Freeze/Unfreeze, 83, 185
 - I/O synchronization, 185
 - Multicast message, 114
 - Selecting groups
 - in CIO words, 114
 - in CX-Profibus, 84
 - Sync/Unsync, 83, 185, 186
 - Transmitting commands, 187
 - CIO Words, via, 114
 - CX-Profibus, via, 84, 188
 - PLC program, via, 187
- GSD file
 - DP-master section, 9
 - DP-slave section, 9
 - DTM versus GSD file, 9
 - General section, 9
 - GSD file technology, 8
 - Installing new, 149
 - Language, 9
- HSA
 - See* Bus parameters

I

- I/O Allocations
 - CIO Area
 - Actual bus cycle time (Word n+8), 122
 - Global Control message (Word n+2), 114
 - Master status word 1 (Word n+5), 118
 - Master status word 2 (Word n+6), 120
 - Reserved words, 112
 - Slave Data_Exchange flags (Word N+9~n+16), 122
 - Slave New diagnostics flags (Word n+17~n+24), 123
 - Slave status word (Word n+7), 121
 - Software switches 1 (Word n), 113
 - Unit status word (Word n+4), 117
 - CIO/DM Area Overview, 110
 - DM Area
 - Allocations, 111
- I/O data
 - Configuration, 168
 - Mapping
 - Algorithm, 168
 - Area start address, 174
 - Auto addressing
 - Default behaviour, 169
 - Enable/disable, 172
 - Mapping without, 172
 - Re-allocating modules, behaviour when, 171
 - Compressing, 173
 - Concept, 168
 - Re-allocating modules, 170
 - Removing gaps, 173

- Supported I/O range, 168
- Types, 175, 243
 - Conversion, 243
 - Date/Time, 175, 245
 - Floating point, 175, 244
 - Integer, 175, 243, 244
 - Text string, 175, 245
 - Time difference, 175
 - Time of day, 175

- I/O table
 - Creating, 36

- Installation
 - Handling precautions, 32
 - Mounting
 - CJ1W-PRM21, 34
 - CS1W-PRM21, 32

- Installing new GSD files, 149

L-M

- LED indicators, 29
 - Specifications, 29
 - See also* Troubleshooting, LED indicators

- Low voltage directive, xx

- Maintenance, 226
 - Cleaning, 226
 - Inspection, 226
 - Equipment, 226
 - Procedure, 226

- Manual
 - About, ix
 - Revision history, 271

- Master devices
 - See* PROFIBUS, Master

- Master DTM
 - Configuration, 7
 - See* C200HW-PRM21 DTM
 - See* CS1/CJ1W-PRM21 DTM

- Medium Access Control, 4

- Memory card
 - Backing up Unit setup files, 253
 - Backup functions, 253
 - Restoring Unit setup files, 254

- Message communication
 - See* FINS communication

- Min slave interval, 230

- Monitoring
 - CS1/CJ1-PRM21 Master Unit, 6
 - Monitoring Time, 6
 - Slave device, 6

- Monitoring slave status, 194

- Multicast communication
 - See* Global Control

N

- Network operation modes
 - CLEAR, 6
 - OFFLINE, 6
 - OPERATE, 6
 - STOP, 6

- Network structure, 37
 - Linear bus topology, 37
 - Repeaters, 38
 - Tree topology, 38

O-P

- OMRON
 - Copyright notice, iv

- Operation modes
 - See* Network Operation modes, 6

- OSI reference model, 2
 - ISO-7498, 2
 - Layer 1, Physical Layer, 2
 - Layer 2, Data Link Layer, 2
 - Layer 7, Application Layer, 2

- Password
 - Default, 53

- PLC cycle time performance, 178

- Polling procedure, 5

- Precautions
 - Application, xviii
 - General, xvi
 - Operating Environment, xvii
 - Safety, xvi

- PROFIBUS
 - Device profile, 4
 - Master
 - Class 1 Master (DPM1), 4
 - Class 2 Master (DPM2), 4

- Network
 - Changing mode, 183
 - Indirect mode changes, 184
 - Mode changes, 183
 - Monitoring, 190
 - Operational modes, 6
 - User access, 182
- PROFIBUS DP, Decentralized Periphery, 2
- PROFIBUS DP-V1, 4
- PROFIBUS FMS, Fieldbus Message Specification, 2
- PROFIBUS PA, Process Automation, 2
- Protocol Specification, 14

- PROFIBUS DP-V1 services, 197
 - Acyclic abort status, 76
 - Acyclic connection status, 74, 75
 - Configuring using DTM, 74, 197
 - Error codes, 240
 - Initiate from PLC CPU, 198

MSAC1_Read, 142
MSAC1_Write, 144

R

RS-485

Cable length, 3
Cable Type, 39
Transmission medium, 3
Transmission speed, 3
See also Wiring

S

Safety Precautions, xvi
Set device station address, 77
Setting up a network, 148
shock resistance, 13
Slave devices, 4
Slave diagnostics
 Data, 233
 Extended data, 236
 Channel related, 238
 Device related, 236
 Example, 240
 Module related, 237
 Reading
 MEMORY AREA READ, 233
 Standard data, 234
startup times, 181
Sync
 See Global Control
system
 startup times, 181
System startup time, 181

T

Target rotation time
 See also Bus parameters
Token passing, 5
Trademarks, iv
Transmission medium, 3
 RS-485, 3
Transmission speed, 3
Troubleshooting
 CS1/CJ1-PRM21 Master Unit, 202
 CX-Profibus, 202
 Error codes, 223
 Error log, 222
 Adding records, 222
 Clearing, 222
 Error log location, 222
 Error log records, 222

 Logged errors, 222
 Reading Error log, 222
Error status, 209
 CIO words, 209
 Unit status word, 209
FINS Commands, 225
LED indicators, using, 203
Network
 CS1/CJ1W-PRM21 DTM, 213
 CX-Profibus, using, 213
 I/O communication, 218
 LED indicators, using, 207
 Slave devices, 215
Overview, 202
PROFIBUS DP-V1 communication, 221
PROFIBUS network, 202
Unit configuration
 LED indicators, using, 206
Unit operational errors
 LED indicators, using, 205
Unit startup
 LED indicators, using, 203

U

Unit number
 CPU Bus Unit allocations, 30
 Setting, 30
 See also CS1/CJ1W-PRM21 DTM
Unit replacement, 227
 Precautions, 227
 Replacing PROFIBUS Units, 227
Unit setup, 227

V-W

vibration resistance, 13
Warning messages, 247
Watchdog control
 See Bus parameters
Wiring
 Bus connector, 40
 Bus termination, 39
 Inductors, 40
 Resistors, 39
 Cable length, 3
 Cable shield connection, 41

Revision History

A manual revision code appears as a suffix to the catalog number on the front cover of the manual.

Cat. No. W409-E2-04

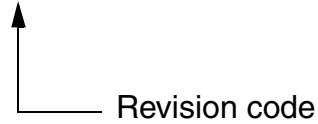

The following table outlines the changes made to the manual during each revision. The page numbers of a revision refer to the previous version.

Revision Code	Date	Revised Content
01	March, 2004	Initial version.
02	February, 2005	Page ix: Added line on C200HW-PRM21 to About section. Page 8: Added C200HW-PRM21 DTM to bullet list. Page 11: Added Vibration, Shock and Dielectric strength data to table. Page 16: Added C200HW-PRM21 DTM to bullet list. Page 16: Added description of C200HW-PRM21 DTM. Page 17: Added C200HW-PRM21 DTM downloading description. Page 17: Updated figure. Page 18: Added C200HW-PRM21 connection method to table. Page 19: Added C200HW-PRM21 DTM to table. Page 20: Improved Basic Operations flow chart. Page 28: Renamed section 2.2. Page 40: Added C200HW-PRM21 DTM to bullet list. Page 48: Added section 3-1-3. Page 61: Renamed section 3.3. Page 76: Renamed section 3.3.3. Page 79: Renumbered section 3.4 to section 3.5. Page 79: Added new section 3.4. Page 92: Added note on C200HW-PRM21 word allocations. Page 108: Added note on C200HW-PRM21 and FINS. Page 118: Added note on operation of the C200HW-PRM21. Page 223: Added Appendix G.

Revision History

Revision Code	Date	Revised Content
03	July, 2005	<p>Changed title of document.</p> <p>Corrected PROFIBUS DP naming to comply with PROFIBUS standards.</p> <p>Corrected terminology regarding views, tabs and windows.</p> <p>Changed Unit naming from PROFIBUS DP Master to PROFIBUS Master.</p> <p>Page vi: Added HART Trademark.</p> <p>Page ix: Added function/version number table and description.</p> <p>Page 4: Added description on PROFIBUS DP-V1.</p> <p>Page 5: Removed text in brackets from Multicast command description.</p> <p>Page 5: Changed Extensive Diagnostics to Extended Diagnostics.</p> <p>Page 5: Edited description on Extensive Diagnostics.</p> <p>Page 8: Added new DTM to CX-Profibus DTM list.</p> <p>Page 8: Updated name of PROFIBUS organization.</p> <p>Page 9: Added paragraph on PROFIBUS DP-V1 services to DP slave section.</p> <p>Page 10: Added paragraph on extended services to FINS messages.</p> <p>Page 10: Changed first specification table to include version numbers.</p> <p>Page 12: Added support of acyclic message services to table.</p> <p>Page 14: Added PROFIBUS MESSAGE SEND FINS to table.</p> <p>Page 15: Added support of acyclic message services to comparison table.</p> <p>Page 16: Added DTM to bullet list.</p> <p>Page 16: Changed description of CS1/CJ1W-PRM21 DTM.</p> <p>Page 16: Changed naming of DTM parts from DTM to user interface.</p> <p>Page 16: Added description on additional PROFIBUS DP-V1 DTM functions.</p> <p>Page 17: Changed naming of DTM parts from DTM to user interface.</p> <p>Page 17: Added Note to Generic Slave DTM description.</p> <p>Page 19: Added PROFIBUS DP-V1 functions to specification table.</p> <p>Page 40: Added Note 1 on uninstalling previous versions of CX-Profibus.</p> <p>Page 54: Changed first line description in upper table for Version.</p> <p>Page 61: Changed section 3.3. title.</p> <p>Page 61: Added new DTM names to section 3.3 in table format.</p> <p>Page 62: Added note below Configuration DTM view image.</p> <p>Page 70: Added description of new functions to end of section 3.3.1.</p> <p>Page 95: Updated note PROFIBUS DP-V1 tab.</p> <p>Page 118: Added explanation and figure on FINS over PROFIBUS.</p> <p>Page 119: Added note below table.</p> <p>Page 123: Changed example version number to 2.00.</p> <p>Page 125: Added section 5.2.7.</p> <p>Page 132: Renamed and rewrote section 6.6.2.</p> <p>Page 217: Added section B-5 on PROFIBUS DP-V1 error codes.</p> <p>Page 224: Added warnings to table.</p> <p>Page 225: Added errors to table.</p> <p>Page 229: Added Note on backward compatibility for Memory Card.</p>

Revision History

Revision Code	Date	Revised Content
04	May 2006	<p>Changed Manual title.</p> <p>Page ix: Changed/Updated version table and note on versions.</p> <p>Page ix: Added note on terminology.</p> <p>Page x: Updated Manual reference list with new manuals.</p> <p>Page xi: Added Warranty section.</p> <p>Page xvii: Added precaution on slave configuration via PROFIBUS DP-V1.</p> <p>Page 4: Updated text on version numbers.</p> <p>Page 6: Extended text on STOP mode capabilities.</p> <p>Page 8: Added GRT1-PRT DTM to bullet list.</p> <p>Page 10: Added PROFIBUS DP-V1 feature description.</p> <p>Page 10: Specified Class 1 and Class 2 for PROFIBUS DP services.</p> <p>Page 10: Added description on PROFIBUS DP Class 2 services.</p> <p>Page 11: Added text on retrieving the Unit's version.</p> <p>Page 11: Updated Version table and notes.</p> <p>Page 12: Added PROFIBUS DP-V1 status flags mapping to table.</p> <p>Page 13: Removed text on error log from Device State Changes table entry.</p> <p>Page 13: Added text on Explicit Message Send FINS command.</p> <p>Page 13: Added supported PROFIBUS DP-V1 Class 2 messages.</p> <p>Page 14: Corrected entry on Class 1 and Class 2 services.</p> <p>Page 14: Added supported PROFIBUS DP-V1 Class 2 messages.</p> <p>Page 14: Added notes to the table.</p> <p>Page 16: Updated comparison table.</p> <p>Page 18: Added GRT1-PRT DTM to bullet list.</p> <p>Page 18: Added description of GRT1-PRT DTM.</p> <p>Page 19: Added feature description to DP-V1 Master unit.</p> <p>Page 22: Added support for Class 2 messages to table.</p> <p>Page 37: Added note on minimum cable length.</p> <p>Page 39: Improved text in bullet list in section 2.5.</p> <p>Page 48: Removed text on License window.</p> <p>Page 49: Modified list item 21 text.</p> <p>Page 50: Updated text on registration.</p> <p>Page 64: Updated GUI image (new tab).</p> <p>Page 66: Added Ident number description to table.</p> <p>Page 66: Updated GUI image (new tab).</p> <p>Page 67: Updated GUI image (new tab).</p> <p>Page 70: Updated GUI image (new tab).</p> <p>Page 71: Renamed controls in table.</p> <p>Page 72: Added description of new DTM settings after note.</p> <p>Page 72: Corrected DTM version number in Additional Functions text.</p> <p>Page 98: Added note to Fail Safe Behaviour.</p> <p>Page 99: Added note on PROFIBUS DP-V1 Class 1 to DPV1 Tab description.</p> <p>Page 122: Added third bullet to FINS type list and updated FINS concept image.</p> <p>Page 123: Added FINS command 2801 to table.</p> <p>Page 130: Added new subsection 5.2.7.</p> <p>Page 130: Added Class 1 to supported services for FINS 2809.</p> <p>Page 131: Improved text in table.</p> <p>Page 155: Updated GUI image (new tab).</p> <p>Page 156: Updated GUI image (new tab).</p> <p>Page 157: Updated GUI image (new tab).</p> <p>Page 158: Updated GUI image (new tab).</p> <p>Page 158: Improved Caution text.</p>

Revision Code	Date	Revised Content
04 (Continued)	May 2006	Page 165: Updated GUI image (new tab). Page 167: Updated GUI image (new tab). Page 168: Updated GUI image (new tab). Page 184: Moved contents of section 6.6.5 to section 6.8.2. Page 192: Added section 6.8. Page 196: Updated table for troubleshooting routing tables. Page 210: Updated text above table. Page 210: Added baud rate to table as item to check/correct. Page 213: Added section 7.4.3 related to PROFIBUS DP-V1 Troubleshooting. Page 215: Added error log details when using routing tables. Page 237: Updated warning 03 description. Page 238: Added new warning 16. Page 239: Updated error 01 and 02 description.

Terms and Conditions of Sale

1. **Offer; Acceptance.** These terms and conditions (these "Terms") are deemed part of all quotes, agreements, purchase orders, acknowledgments, price lists, catalogs, manuals, brochures and other documents, whether electronic or in writing, relating to the sale of products or services (collectively, the "Products") by Omron Electronics LLC and its subsidiary companies ("Omron"). Omron objects to any terms or conditions proposed in Buyer's purchase order or other documents which are inconsistent with, or in addition to, these Terms.
2. **Prices; Payment Terms.** All prices stated are current, subject to change without notice by Omron. Omron reserves the right to increase or decrease prices on any unshipped portions of outstanding orders. Payments for Products are due net 30 days unless otherwise stated in the invoice.
3. **Discounts.** Cash discounts, if any, will apply only on the net amount of invoices sent to Buyer after deducting transportation charges, taxes and duties, and will be allowed only if (i) the invoice is paid according to Omron's payment terms and (ii) Buyer has no past due amounts.
4. **Interest.** Omron, at its option, may charge Buyer 1-1/2% interest per month or the maximum legal rate, whichever is less, on any balance not paid within the stated terms.
5. **Orders.** Omron will accept no order less than \$200 net billing.
6. **Governmental Approvals.** Buyer shall be responsible for, and shall bear all costs involved in, obtaining any government approvals required for the importation or sale of the Products.
7. **Taxes.** All taxes, duties and other governmental charges (other than general real property and income taxes), including any interest or penalties thereon, imposed directly or indirectly on Omron or required to be collected directly or indirectly by Omron for the manufacture, production, sale, delivery, importation, consumption or use of the Products sold hereunder (including customs duties and sales, excise, use, turnover and license taxes) shall be charged to and remitted by Buyer to Omron.
8. **Financial.** If the financial position of Buyer at any time becomes unsatisfactory to Omron, Omron reserves the right to stop shipments or require satisfactory security or payment in advance. If Buyer fails to make payment or otherwise comply with these Terms or any related agreement, Omron may (without liability and in addition to other remedies) cancel any unshipped portion of Products sold hereunder and stop any Products in transit until Buyer pays all amounts, including amounts payable hereunder, whether or not then due, which are owing to it by Buyer. Buyer shall in any event remain liable for all unpaid accounts.
9. **Cancellation; Etc.** Orders are not subject to rescheduling or cancellation unless Buyer indemnifies Omron against all related costs or expenses.
10. **Force Majeure.** Omron shall not be liable for any delay or failure in delivery resulting from causes beyond its control, including earthquakes, fires, floods, strikes or other labor disputes, shortage of labor or materials, accidents to machinery, acts of sabotage, riots, delay in or lack of transportation or the requirements of any government authority.
11. **Shipping; Delivery.** Unless otherwise expressly agreed in writing by Omron:
 - a. Shipments shall be by a carrier selected by Omron; Omron will not drop ship except in "break down" situations.
 - b. Such carrier shall act as the agent of Buyer and delivery to such carrier shall constitute delivery to Buyer;
 - c. All sales and shipments of Products shall be FOB shipping point (unless otherwise stated in writing by Omron), at which point title and risk of loss shall pass from Omron to Buyer; provided that Omron shall retain a security interest in the Products until the full purchase price is paid;
 - d. Delivery and shipping dates are estimates only; and
 - e. Omron will package Products as it deems proper for protection against normal handling and extra charges apply to special conditions.
12. **Claims.** Any claim by Buyer against Omron for shortage or damage to the Products occurring before delivery to the carrier must be presented in writing to Omron within 30 days of receipt of shipment and include the original transportation bill signed by the carrier noting that the carrier received the Products from Omron in the condition claimed.
13. **Warranties.** (a) **Exclusive Warranty.** Omron's exclusive warranty is that the Products will be free from defects in materials and workmanship for a period of twelve months from the date of sale by Omron (or such other period expressed in writing by Omron). Omron disclaims all other warranties, express or implied. (b) **Limitations.** OMRON MAKES NO WARRANTY OR REPRESENTATION, EXPRESS OR IMPLIED, ABOUT NON-INFRINGEMENT, MERCHANTABILITY OR FITNESS FOR A PARTICULAR PURPOSE OF THE PRODUCTS. BUYER ACKNOWLEDGES THAT IT ALONE HAS DETERMINED THAT THE PRODUCTS WILL SUITABLY MEET THE REQUIREMENTS OF THEIR INTENDED USE. Omron further disclaims all warranties and responsibility of any type for claims or expenses based on infringement by the Products or otherwise of any intellectual property right. (c) **Buyer Remedy.** Omron's sole obligation hereunder shall be, at Omron's election, to (i) replace (in the form originally shipped with Buyer responsible for labor charges for removal or replacement thereof) the non-complying Product, (ii) repair the non-complying Product, or (iii) repay or credit Buyer an amount equal to the purchase price of the non-complying Product; provided that in no event shall Omron be responsible for warranty, repair, indemnity or any other claims or expenses regarding the Products unless Omron's analysis confirms that the Products were properly handled, stored, installed and maintained and not subject to contamination, abuse, misuse or inappropriate modification. Return of any Products by Buyer must be approved in writing by Omron before shipment. Omron Companies shall not be liable for the suitability or unsuitability or the results from the use of Products in combination with any electrical or electronic components, circuits, system assemblies or any other materials or substances or environments. Any advice, recommendations or information given orally or in writing, are not to be construed as an amendment or addition to the above warranty. See <http://oeweb.omron.com> or contact your Omron representative for published information.
14. **Limitation on Liability; Etc.** OMRON COMPANIES SHALL NOT BE LIABLE FOR SPECIAL, INDIRECT, INCIDENTAL, OR CONSEQUENTIAL DAMAGES, LOSS OF PROFITS OR PRODUCTION OR COMMERCIAL LOSS IN ANY WAY CONNECTED WITH THE PRODUCTS, WHETHER SUCH CLAIM IS BASED IN CONTRACT, WARRANTY, NEGLIGENCE OR STRICT LIABILITY. Further, in no event shall liability of Omron Companies exceed the individual price of the Product on which liability is asserted.
15. **Indemnities.** Buyer shall indemnify and hold harmless Omron Companies and their employees from and against all liabilities, losses, claims, costs and expenses (including attorney's fees and expenses) related to any claim, investigation, litigation or proceeding (whether or not Omron is a party) which arises or is alleged to arise from Buyer's acts or omissions under these Terms or in any way with respect to the Products. Without limiting the foregoing, Buyer (at its own expense) shall indemnify and hold harmless Omron and defend or settle any action brought against such Companies to the extent based on a claim that any Product made to Buyer specifications infringed intellectual property rights of another party.
16. **Property; Confidentiality.** Any intellectual property in the Products is the exclusive property of Omron Companies and Buyer shall not attempt to duplicate it in any way without the written permission of Omron. Notwithstanding any charges to Buyer for engineering or tooling, all engineering and tooling shall remain the exclusive property of Omron. All information and materials supplied by Omron to Buyer relating to the Products are confidential and proprietary, and Buyer shall limit distribution thereof to its trusted employees and strictly prevent disclosure to any third party.
17. **Export Controls.** Buyer shall comply with all applicable laws, regulations and licenses regarding (i) export of products or information; (ii) sale of products to "forbidden" or other proscribed persons; and (iii) disclosure to non-citizens of regulated technology or information.
18. **Miscellaneous.** (a) **Waiver.** No failure or delay by Omron in exercising any right and no course of dealing between Buyer and Omron shall operate as a waiver of rights by Omron. (b) **Assignment.** Buyer may not assign its rights hereunder without Omron's written consent. (c) **Law.** These Terms are governed by the law of the jurisdiction of the home office of the Omron company from which Buyer is purchasing the Products (without regard to conflict of law principles). (d) **Amendment.** These Terms constitute the entire agreement between Buyer and Omron relating to the Products, and no provision may be changed or waived unless in writing signed by the parties. (e) **Severability.** If any provision hereof is rendered ineffective or invalid, such provision shall not invalidate any other provision. (f) **Setoff.** Buyer shall have no right to set off any amounts against the amount owing in respect of this invoice. (g) **Definitions.** As used herein, "including" means "including without limitation"; and "Omron Companies" (or similar words) mean Omron Corporation and any direct or indirect subsidiary or affiliate thereof.

Certain Precautions on Specifications and Use

1. **Suitability of Use.** Omron Companies shall not be responsible for conformity with any standards, codes or regulations which apply to the combination of the Product in the Buyer's application or use of the Product. At Buyer's request, Omron will provide applicable third party certification documents identifying ratings and limitations of use which apply to the Product. This information by itself is not sufficient for a complete determination of the suitability of the Product in combination with the end product, machine, system, or other application or use. Buyer shall be solely responsible for determining appropriateness of the particular Product with respect to Buyer's application, product or system. Buyer shall take application responsibility in all cases but the following is a non-exhaustive list of applications for which particular attention must be given: (i) Outdoor use, uses involving potential chemical contamination or electrical interference, or conditions or uses not described in this document. (ii) Use in consumer products or any use in significant quantities. (iii) Energy control systems, combustion systems, railroad systems, aviation systems, medical equipment, amusement machines, vehicles, safety equipment, and installations subject to separate industry or government regulations. (iv) Systems, machines and equipment that could present a risk to life or property. Please know and observe all prohibitions of use applicable to this Product. NEVER USE THE PRODUCT FOR AN APPLICATION INVOLVING SERIOUS RISK TO LIFE OR PROPERTY OR IN LARGE QUANTITIES WITHOUT ENSURING THAT THE SYSTEM AS A WHOLE HAS BEEN DESIGNED TO ADDRESS THE RISKS, AND THAT THE OMRON'S PRODUCT IS PROPERLY RATED AND INSTALLED FOR THE INTENDED USE WITHIN THE OVERALL EQUIPMENT OR SYSTEM.
2. **Programmable Products.** Omron Companies shall not be responsible for the user's programming of a programmable Product, or any consequence thereof.
3. **Performance Data.** Data presented in Omron Company websites, catalogs and other materials is provided as a guide for the user in determining suitability and does not constitute a warranty. It may represent the result of Omron's test conditions, and the user must correlate it to actual application requirements. Actual performance is subject to the Omron's Warranty and Limitations of Liability.
4. **Change in Specifications.** Product specifications and accessories may be changed at any time based on improvements and other reasons. It is our practice to change part numbers when published ratings or features are changed, or when significant construction changes are made. However, some specifications of the Product may be changed without any notice. When in doubt, special part numbers may be assigned to fix or establish key specifications for your application. Please consult with your Omron's representative at any time to confirm actual specifications of purchased Product.
5. **Errors and Omissions.** Information presented by Omron Companies has been checked and is believed to be accurate; however, no responsibility is assumed for clerical, typographical or proofreading errors or omissions.



OMRON ELECTRONICS LLC

1 Commerce Drive
Schaumburg, IL 60173
847.843.7900
For US technical support or
other inquiries: 800.556.6766

OMRON CANADA, INC.

885 Milner Avenue
Toronto, Ontario M1B 5V8
416.286.6465

OMRON ON-LINE

Global - www.omron.com
USA - www.omron247.com
Canada - www.omron.ca
Brazil - www.omron.com.br
Latin America - www.espanol.omron.com

UNITED STATES

To locate a Regional Sales Office, local Distributor or
to obtain product information, call: 847.843.7900

MEXICO SALES OFFICES

Mexico, D.F.	555.660.3144
Ciudad Juárez	656.623.7083
Monterrey, N.L.	818.377.4281
Querétaro	442.135.4510

BRAZIL SALES OFFICE

Sao Paulo	55.11.2101.6310
-----------	-----------------

ARGENTINA SALES OFFICE

Cono Sur	54.114.787.1129
----------	-----------------

OTHER LATIN AMERICAN SALES

mela@omron.com