

PLC-Description

HEIDENHAIN TNC 150 B/TNC 150 Q Contouring Control



DR. JOHANNES HEIDENHAIN

Precision Mechanics, Optics and Electronics · Precision Graduations
P.O.Box 1260 · D-8225 Traunreut · Telephone (08669) 31-0
Telex: 5 6831 · Telegramme: DIADUR Traunreut

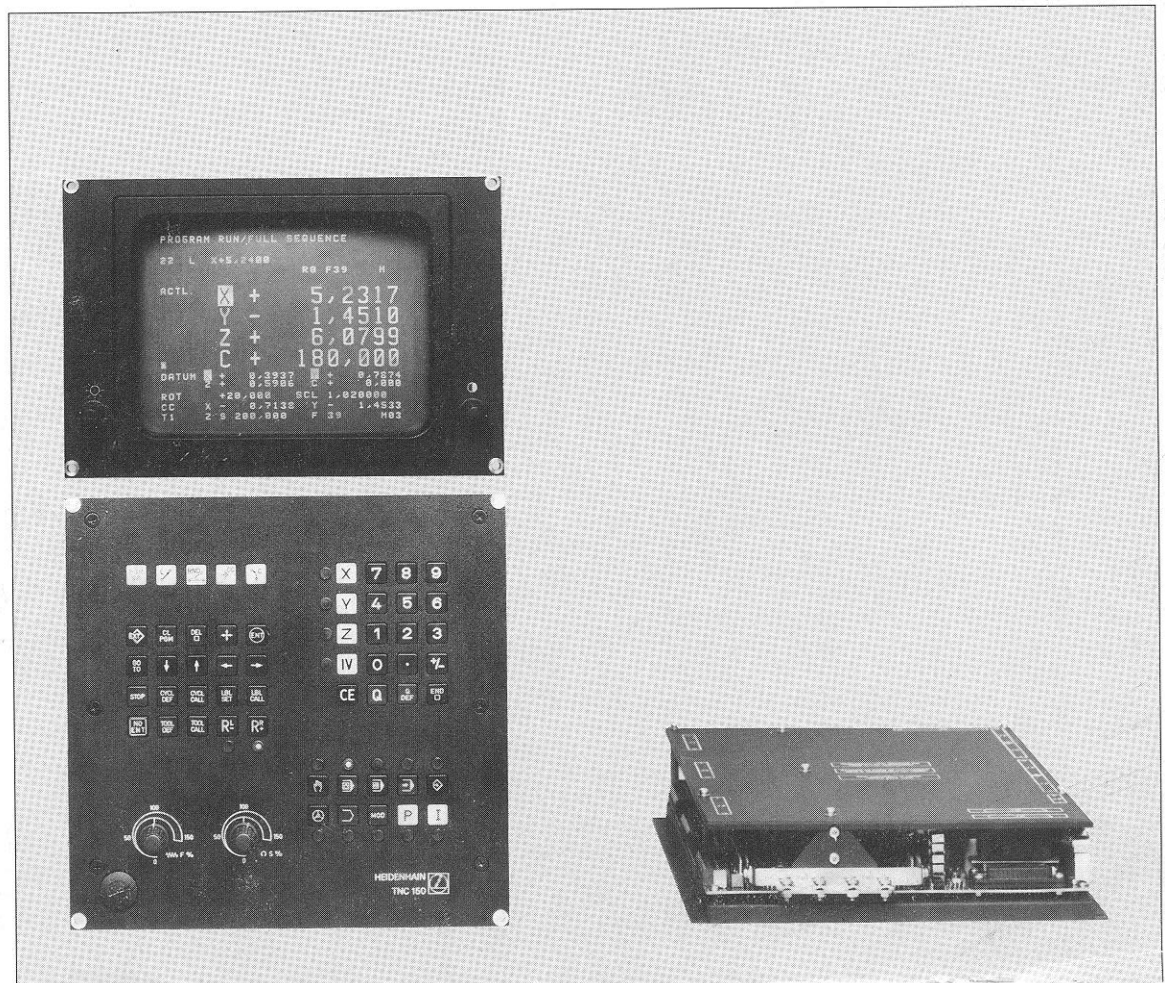

Contents

	Section	Page
Introduction	A)	5
Connection and technical data	B)	6
Connection and technical data TNC 150 B	B 1)	6
Connection and technical data TNC 150 Q	B 2)	7
Connection of TNC 150 Q	B 2.1)	7
Grounding diagram	B 2.2)	8
Technical data for PLC	B 2.3)	9
Layout of inputs and outputs of PLC-boards	B 2.4)	12
PLC-boards PL 100 B/PL 110 B as first PLC-board	B 2.4.1)	12
PLC-boards PL 100 B/PL 110 B as second PLC-board	B 2.4.2)	13
EPROM for the PLC-Programme	B 3)	14
Programming of the HEIDENHAIN PLC	C)	15
Description of the PLC-Commands	C 1)	15
No Operation: NOP	C 1.1)	15
Assignment: =	C 1.2)	15
AND-Command: U	C 1.3)	16
AND-Command with inverted operand: UN	C 1.4)	16
OR-Command: O	C 1.5)	16
OR-Command with inverted operand: ON	C 1.6)	17
Exklusive OR-Command: XO	C 1.7)	17
Exklusiv OR-command with inverted operand: XON	C 1.8)	17
Programming of logic sequences	C 1.9)	18
Logic sequences with U-commands	C 1.9.1)	18
Logical sequences with UN-commands	C 1.9.2)	19
Logical sequences with O-commands	C 1.9.3)	20
Logic sequence with ON-commands	C 1.9.4)	21
Logic sequence with XO/XON commands	C 1.9.5)	22
Programming of an arbitrary logic sequence	C 1.9.6)	22
Setting and resetting of a marker	C 1.10)	23
Address allocation for PLC-markers	C 2)	24
User markers: Address letter M	C 2.1)	24
Markers for the signal exchanges between PLC and NC:		
Address letter M	C 2.2)	24
Markers for the axis release: X, Y, Z, IV	C 2.2.1)	24
Markers for axes in position: X, Y, Z, IV	C 2.2.2)	25
Markers for traverse-dependent lubrication impulses: X, Y, Z, IV	C 2.2.3)	25
Markers for M-S-T-Code-Outputs	C 2.2.4)	26
Markers for coded M-S-T-Code Outputs	C 2.2.4.1)	26
Markers for decoded M-Code output	C 2.2.4.2)	28
Markers for analogue output of the spindle speed	C 2.2.5)	30
Marker for tapping cycle	C 2.2.6)	31
Markers for the currently activated axis button: X, Y, Z, IV	C 2.2.7)	32
Markers for selected operating mode	C 2.2.8)	32
Markers for operating mode-code	C 2.2.8.1)	32
Markers for the decoded operating mode-code	C 2.2.8.2)	32
Markers for the first PLC-program cycle after power on and after interruption of PLC-programme	C 2.2.9)	33
Markers affected by machine parameter 158	C 2.2.10)	33

	Section	Page
Markers for inhibiting buttons _____	C 2.2.11)	34
Markers for control status and error messages _____	C 2.2.12)	36
Markers for inhibiting the Servo Loop _____	C 2.2.13)	39
Markers for transfer of actual position values as nominal values (Teach-in) _____	C 2.2.14)	39
Markers for external buttons and switches _____	C 2.2.15)	40
Markers for the PLC-Positioning _____	C 2.2.16)	42
Code for the external selection of TNC-buttons _____	C 2.2.17)	44
PLC-Inputs and PLC-Outputs:		
Address letters E, A _____	C 2.3)	46
Summary _____	C 2.3.1)	46
Bipolar PLC-outputs for PL 110 B _____	C 2.3.2)	48
Output "Emergency Stop" _____	C 2.3.3)	48
Counters _____	C 3)	49
Timers _____	C 4)	50
Macro-programmes _____	C 5)	51
Selecting and exiting from the PLC-modes _____	C 6)	51
"PLC Programme editor": PCE button _____	C 6.1)	52
Keyboard layout for PLC-programming _____	C 6.1.1)	53
Button functions _____	C 6.1.2)	54
Programming PLC-commands _____	C 6.1.3)	55
Call-up of a specific PLC-command _____	C 6.1.4)	55
Sequential checking of PLC commands _____	C 6.1.5)	56
Deleting PLC-commands _____	C 6.1.6)	56
Entering PLC-commands into an existing programme _____	C 6.1.7)	56
Deleting a PLC-Programme _____	C 6.1.8)	56
Transfer of a programme from the main memory into the read/write-store _____	C 6.1.9)	57
Input/Output of PLC-programmes on magnetic tape or printer _____	C 6.1.10)	57
Operating mode "PLC-Programme trace function": PCT -button _____	C 6.2)	59
Operating mode "Table E/A/Z/T/M": TAB -button _____	C 6.3)	60
Off-line PLC programming _____	C 7)	60
PLC-command format _____	C 7.1)	61
PLC-Operation codes for PLC-Commands _____	C 7.2)	61
PLC-Address for PLC-Commands _____	C 7.3)	61
EPROM Address list _____	C 7.4)	61
Standard TNC 150 B / TNC 150 Q PLC-program description _____	D)	62
Address list _____	D 1)	62
Reference listing for markers, inputs / outputs and timers _____	D 2)	64
Standard PLC-program for the TNC 150 B / TNC 150 Q _____	D 3)	68
Terminal layout for input / output signals for TNC 150 B / TNC 150 Q _____	D 4)	82
Programming list _____	E)	83
List of machine parameters TNC 150 _____	F)	88
List of markers for signal exchange between PLC and NC _____	G)	92

This PLC-description is valid for the controls:

TNC 150-versions with interface for an external machine PLC

Transducer inputs: sinusoidal signals Transducer inputs: square wave signals

TNC 150 B

TNC 150 BR

TNC 150 F (without 3D-movement) TNC 150 FR

TNC-versions with PLC-power board(s)

Transducer inputs: sinusoidal signals Transducer inputs: square wave signals

TNC 150 Q

TNC 150 QR

TNC 150 W (without 3D-movement) TNC 150 WR

A) Introduction

Logic circuits operate in binary i.e. two unique, dedicated switching states.

The two possible logic states will be represented by the figures "1" and "0" in this description.

Example:

Switch closed = "1"

Switch open = "0"

Lamp on = "1"

Lamp off = "0"



This relationship can be represented with the aid of a function table (truth table). The switch state is represented as an input variable (operand) E1 and the lighted lamp as a logic result A1.

Truth Table:

E1	A1
0	0
1	1

Digital switching signals can be combined (logic circuits). The basic logic elements in the switching algebra are:

AND

OR

NOT

The logic results of digital switching signals can be realised in the following ways:

- .through relays
- .through integrated circuits
- .through software programmes

Since the implementation of logic sequences using software programmes allows greater flexibility in the event of alterations, the programmable interface (PLC = Programmable Logic Controller) has gained ground in the application to machine tool control.

The PLC is integrated in the HEIDENHAIN control TNC 150, giving the following advantages:

- .The signals between NC and PLC are markers, making more input and output signals possible and the control more flexible
- .The hardware interface is simplified
- .As the PLC programme can be entered at the control, an external programming station is unnecessary
- .When programming the PLC functions, an immediate check is possible
- .Machine faults can be displayed on the screen

Please note:

We are constantly working on the further development of our TNC-Controls and a certain control may deviate from the versions described within this manual.

B) Connection and technical data

The HEIDENHAIN TNC 150 control is available in two basic versions:

TNC 150 B with interface for external machine adaptation (similar to TNC 145 C)

TNC 150 Q with external PLC-power board

Technical data for controls TNC 150 B/TNC 150 Q

Mains voltage supply	Selectable 100/120/140/200/220/240 V + 10 % / – 15 %, 48 ... 62 Hz
Power consumption	ca. 60 W (with 9" or 12" VDU-screen unit)
Ambient temperature	Operation 0 ... + 45°C (+ 32 ... + 113°F) Storage – 30 ... + 70°C (– 22 ... + 158°F)
Weight	Control: 11.5 kg 9"-VDU-screen unit: 6.8 kg, 12"-VDU-screen unit: 10 kg, PC-power board: 1.2 kg (TNC 150 Q)

Please note:

All inputs and outputs of the controls TNC 150 B/TNC 150 Q may only be connected to circuits having protective low voltage.

B 1) Connection and technical data TNC 150 B

TNC 150 B is adapted to the machine externally.

The interface of the TNC 150 B function via an internal PLC-program (see section D 3). This program may, if required, be subjected to slight alterations by the machine tool manufacturer.

With TNC 150 B only the
inputs E0 – E23
and
outputs A0 – A22
are used an extended externally via connectors J1 – J6 (see section D)

Technical data for control inputs

Potential-free opto-couplers (switched into groups)	
Operating voltage	max. 30 V; filtered
Optocouplers switched through	\cong 15 V
Optocouplers open	\leq 8 V
Loading per input	< 10 mA

Technical data of control outputs

Potential-free relay contacts (switched into groups)	
Operating voltage	max. 30 V =/min. 15 V =/
Operating current per contact	max. 50 mA
Permissible load	Resistive load; inductive load only with quenching diode parallel to inductivity.

To prevent welding of contacts during a short circuit, a current limiting resistor of 47 ohms is switched into series with each contact.

Detailed information concerning the connection and adaptation of the TNC 150 B is available in the special interfacing manual.

B 2) Connection and technical data of TNC 150 Q

B 2.1) Connection of TNC 150 Q

With TNC 150 Q a clear and simple arrangement of the control-adaptation system is possible.

Due to loss of power the inputs and outputs of the PLC have been accommodated on one (or two) boards which are separated from the TNC-unit.

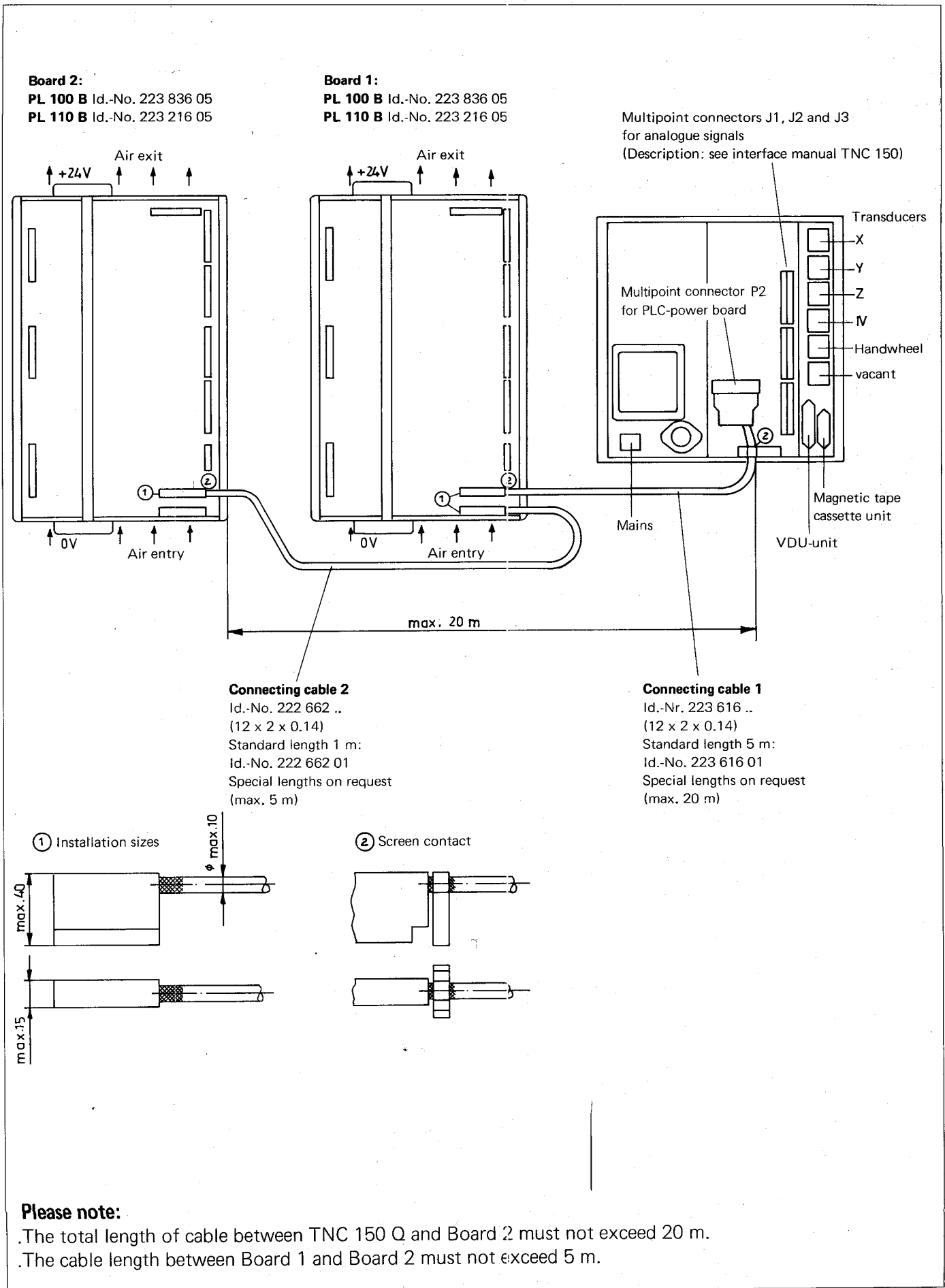

B 2.2) Grounding diagram

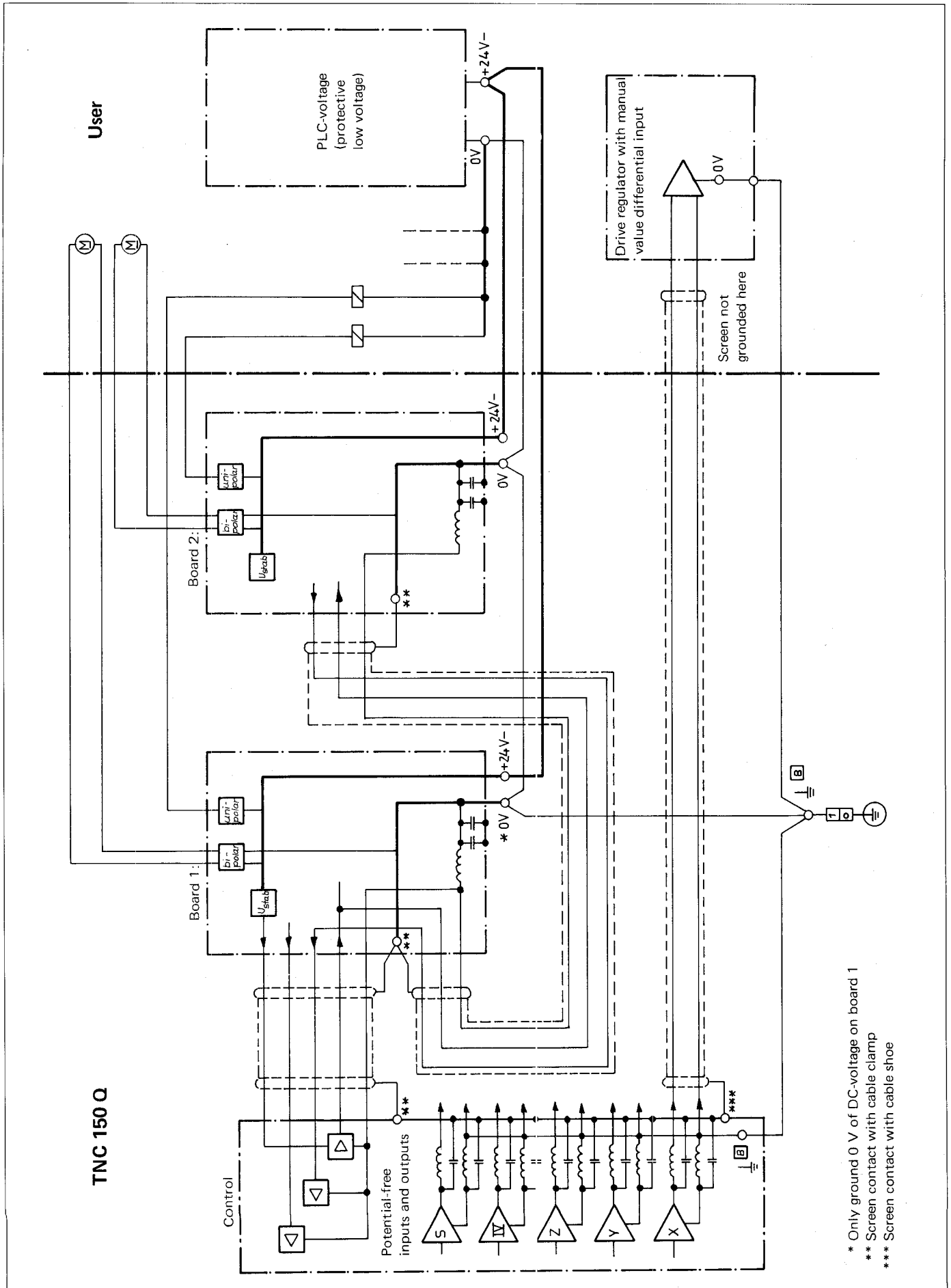

* Only ground 0 V of DC-voltage on board 1

** Screen contact with cable clamp

*** Screen contact with cable shoe

B 2.3) Technical data for PLC

The HEIDENHAIN-PLC offers the following hardware:

The figures in brackets apply to the second input/output board

	Abbreviation	Remarks
1000 User Markers – not power fail protected	M	Marker = 1 bit memory User Marker is a marker freely available for PLC-programming
1000 User Markers – power fail protected	M	
1024 Designated Markers	M	Designated Marker is a marker allocated for data transfer between the TNC and PLC
16 Counters	Z	For counting function in PLC programme
32 Timers	T	For timing function in PLC programme
PL 100 B		
64 (+64) Inputs	E	9 Inputs are designated for TNC input signals (only with Board 1) 1 Input per PCB is internally wired
32 (+32) Outputs	A	1 Output per PCB is internally wired
1 (+1) Output "Emergency Stop"		Internal "Emergency Stop" wired from the NC section of the control directly to the output
1 (+1) Output "Current supervision"		For the monitoring of the bipolar outputs
PL 110 B		
64 (+64) Inputs	E	9 Inputs are designated for TNC input signals (only with Board 1) 1 Input per PCB is internally wired
26 (+26) Outputs	A	1 Output per PCB is internally wired
3 (+3) Bipolar Output Pairs	A	For control of D.C. motors
1 (+1) Output "Emergency Stop"		Internal "Emergency Stop" wired from the NC section of the control directly to the output
1 (+1) Output "Current supervision"		For the monitoring of the bipolar outputs

The PLC programme will – irrespective of the programme length – cycle through every 20 ms, thus the inputs will be interrogated once every 20 ms, an outputs can change once every 20 ms.

Nominal values and tolerances

External voltage supply for PLC

Nominal voltage: 24 V, –

Voltage range: 20.4 V to 28.8 V

Furthermore, superimposed AC-voltages having a relative oscillation width of 10 % with respect to the DC voltage average are permitted.

Circuitry example:

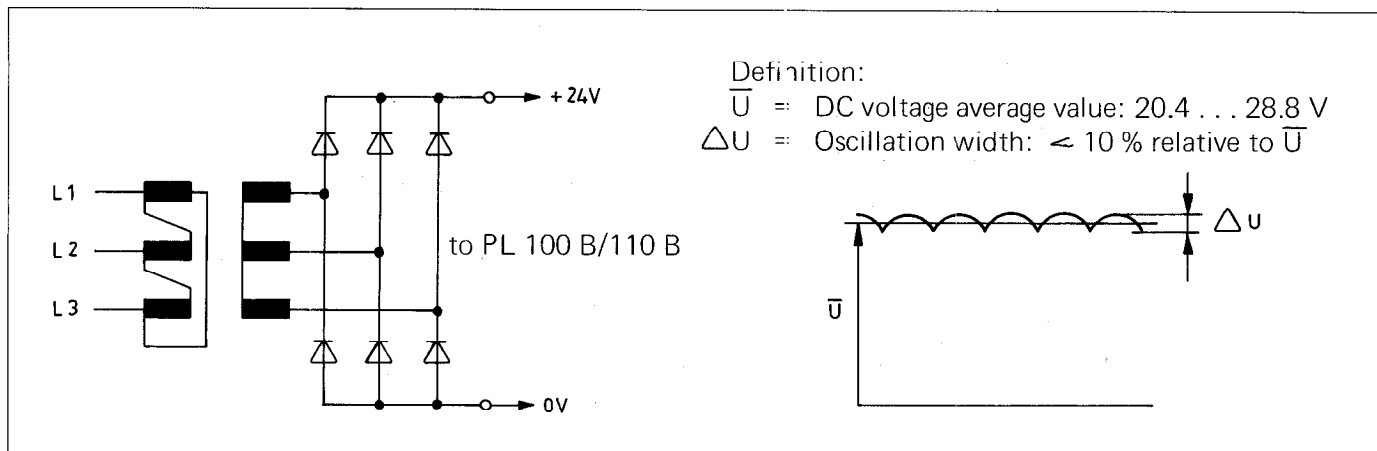

Binary input signals (E0 to E62 and E64 to E126)

Nominal voltage: 24 V, –

Voltage range for signal "1": 16.5 V to 30 V

Voltage range for signal "0": – 3 V to + 4 V

Current range for signal "1": 6.2 mA to 12.6 mA

Please note:

Interference signals < 1 ms at the PLC-outputs are filtered via a Schmitt-Trigger input circuit. Interference signals which are of longer duration must be filtered out by the software.

Binary output signals (PL 100B: A0 to A30, A32 to A62; PL 110 B: A0 to A24, A32 to A56 and "Emergency stop")

Nominal voltage: 24 V, –

Max. voltage difference to supply voltage: < 3 V

Max. output current: 1.2 A

Permissible loading: Resistive load; inductive load only with quenching diode parallel to inductivity.

Max. circuit frequency: 50 Hz

Please note:

Adjacent PLC-Outputs (e.g. A7 with A8) can be switched parallel via resistors (e.g. 2 x 0,47 Ω).

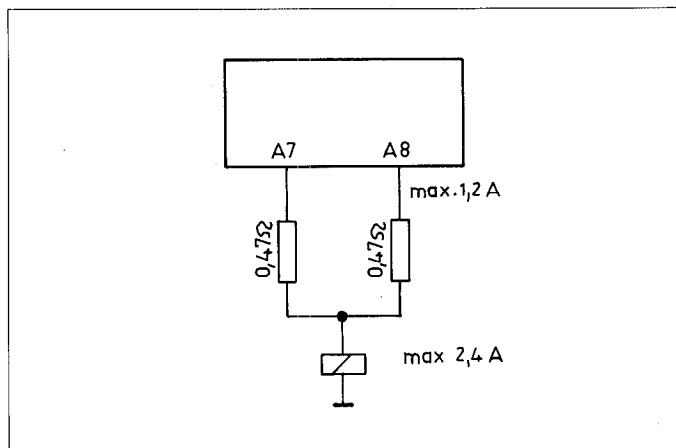

Bipolar outputs (PL 110 B: A25 to A30 and A57 to A62)

Nominal voltage: 15 V

(Measured between to bipolar outputs whereby one out is switched to signal "1" and the other to signal "0")

Nominal current: 300 mA

Voltage range with nominal current: 14.0 V to 15.5 V)

Max. output current 1.2 A for 1 minute

Range for current limitation: 1.35 A to 1.6 A

Permissible loading: Resistive load:

inductive load only with quenching diode parallel to inductivity.

Max. circuit frequency: 50 Hz

Please note:

Bipolar PLC-outputs may not be switched parallel.

Use of bipolar outputs as binary output signals:

Voltage for signal "1": >14.2 V

Voltage for signal "0": ≤ 3.0 V

Nominal current: 300 mA

Max. output current 1.2 A for 1 minute

Output for current monitoring

Monitoring of output currents of all bipolar outputs. The output J3/11 supplies signal "1" if the sum of the output currents of all bipolar outputs ≥ 0.8 A to 0.9 A.

Nominal voltage: 24 V, –

Max. output current: 55 mA to 65 mA

Max. voltage difference to supply voltage: ≤ 1.5 V

B 2.4) Layout of inputs and outputs of PLC-boards

All inputs and outputs may only be connected to circuits with protective low voltage.

B 2.4.1) PLC-board PL 100 B / PL 110 B as first PLC-board

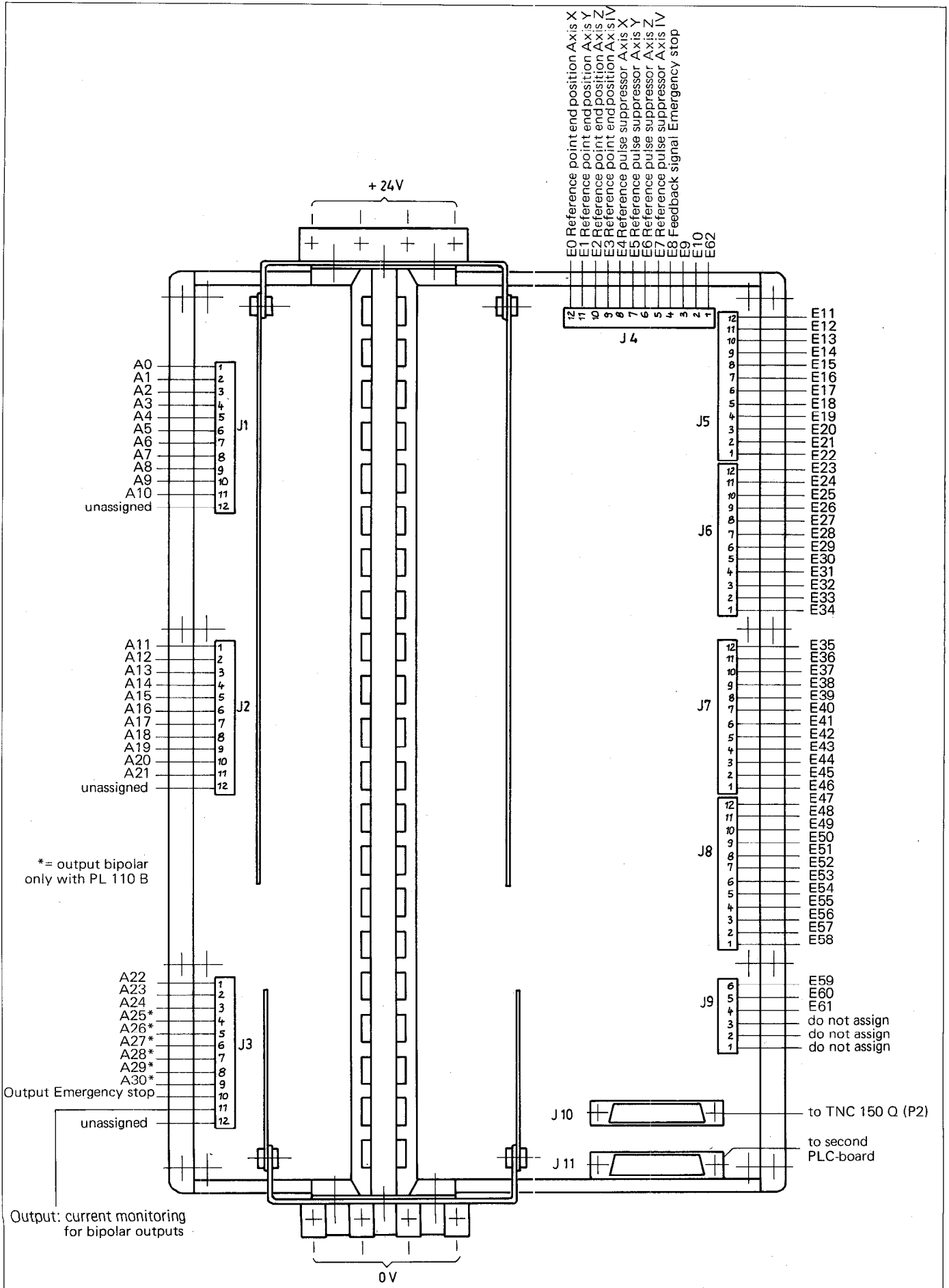

B 2.4.2) PLC-board PL 100 B / PL 110 B as second PLC-board

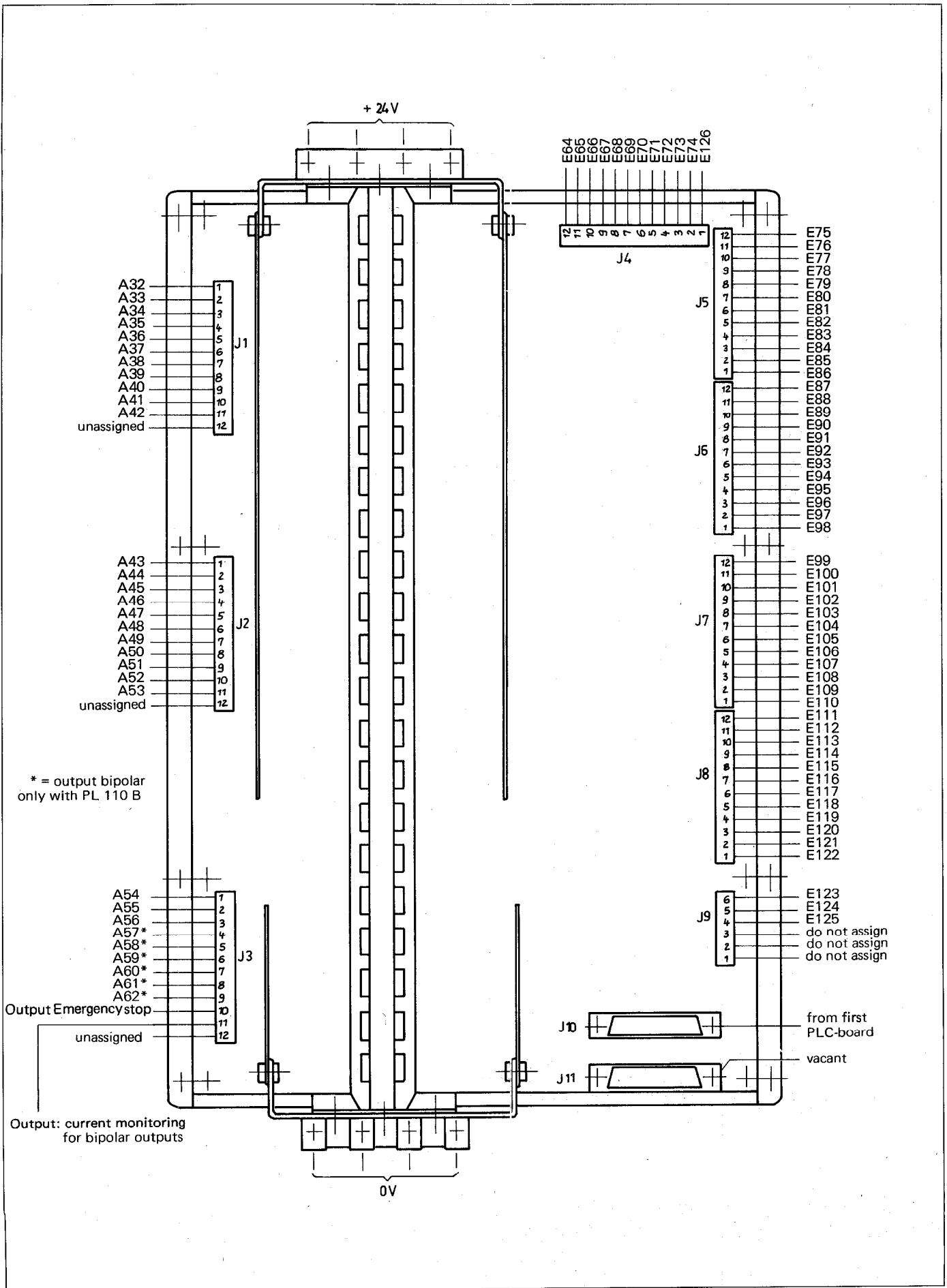

B 3) EPROM for the PLC-Programme

The PLC-programme, together with the internal PLC-software and the PLC-dialogue text, is permanently stored in an EPROM type HN 2764 (see section C 7.4 for address allocation).

The EPROM is located in the TNC-unit on the **second plug-in PCB from the front** – counting from the first panel. It carries the identification 9 . . (the points represent arbitrary numbers and letters).

Please note:

The PLC-software number is displayed in the "MOD"-mode (please refer to the TNC 150-Operating manual).

The plug-in location can be taken from the sketch below.

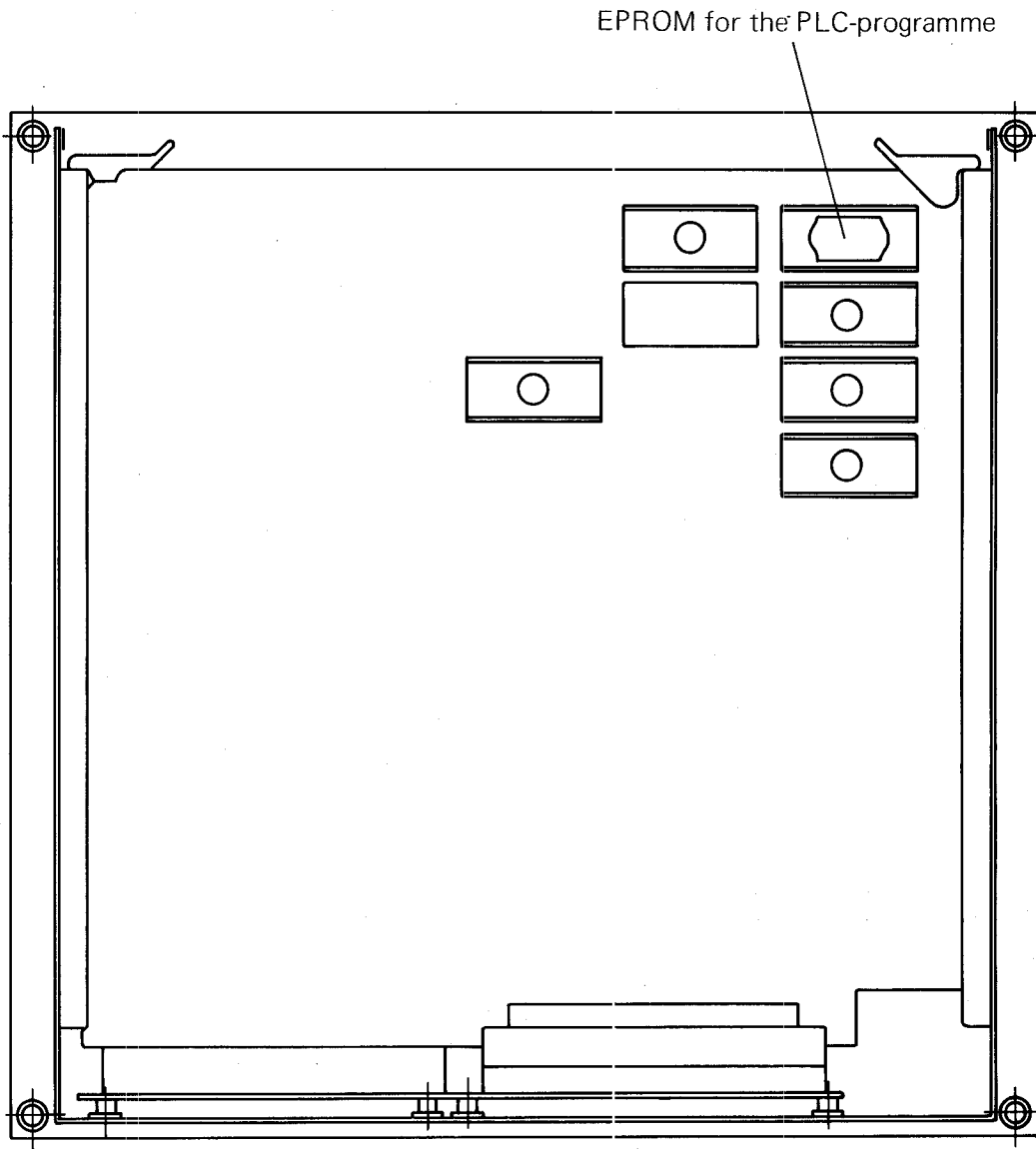

Please note:

Customer-specific PLC-programs can be entered into the control before delivery ex-works. If HEIDENHAIN is not informed of the customer-specific PLC-program, the control is supplied with the standard PLC-program. More detailed information is available from your nearest HEIDENHAIN sales office.

C) Programming of the HEIDENHAIN PLC

C 1) Description of the PLC Commands

It is convenient to represent the integrated PLC in the HEIDENHAIN control TNC 150 as relays or various logic circuits. These comprise commands that the binary operations (logic gates) execute.

A PLC programme can consist of up to 2048 commands. Each individual logic command combines two input values, of which the first is the result of the previous logic gate and the second is self-addressed with the logic command. Gates with inputs are possible using a series string of multiple commands.

The following commands are programmable:

Command	Abbreviation
No Operation	NOP
Assignment	=
AND	U
AND with negative operand (NAND)	UN
OR	O
OR with negative operand (NOR)	ON
EXCLUSIVE OR	XO
EXCLUSIVE OR with negative operand (EXCLUSIVE NOR)	XON
Set memory or output if result of previous logic gate is logic "1"	S
Set memory or output if result of previous logic gate is logic "0"	SN
Reset memory or output if result of previous logic gate is "1"	R
Reset memory or output if result of previous logic gate is "0"	RN

C 1.1) No Operation: NOP

No Operation designates an empty memory location in the command memory.

Every memory location in the command memory which is not occupied by another command, functions as a NOP-command.

Command	Abbreviation
No operation	NOP

C 1.2) Assignment: =

The preceding logic circuit is assigned to a marker or output: a logic sequence is interrupted.

Command	Abbreviation	PLC-Programme
Assignment	=	U E1 U E2 = M30

C 1.3) AND-Command: U

With the aid of the U-command, two input variables can be gated according to the logical AND-function.

The first input variable is either:

the logic result of an immediately preceding gating operation (U, UN, O, ON, XO, XON)

or

logic "1" in the event of an immediately preceding operation being R, RN, S, SN or =.

The second input variable is self-addressed with the U-command.

Command	Abbreviation	Symbol	PLC-Programme
AND	U	Preceding result — E27 — 	U E27

C 1.4) AND-Command with inverted operand: UN

With the aid of the UN-command, two input variables can be gated according to the logical AND-function.

The first input variable is either:

the logic result of an immediately preceding gating operation (U, UN, O, ON, XO, XON)

or

logic "1" in the event of an immediately preceding operation being R, RN, S, SN or =.

The second input variable is self-addressed with the UN-command and **inverted**.

Command	Abbreviation	Symbol	PLC-Programme
AND with inverted operand	UN	Preceding result — E12 — 	UN E12

C 1.5) OR-Command: O

With the aid of the O-command, two input variables can be gated according to the logical OR-function.

The first input variable is either:

the logic result of an immediately preceding gating operation (U, UN, O, ON, XO, XON)

or

logic "0" in the event of an immediately preceding operation being R, RN, S, SN or =.

The second input variable is self-addressed with the O-command.

Command	Abbreviation	Symbol	PLC-Programme
OR	O	Preceding result — E8 — 	O E8

C 1.6) OR-Command with inverted operand: ON

With the aid of the ON-command, two input variables can be gated accordingly to the logical OR-function.

The first input variable is

either

the logic result of an immediately preceding gating operation (U, UN, O, ON, XO, XON)

or

logic "0" in the event of an immediately preceding operation being R, RN, S, SN or =.

The second input variable is self-addressed with the ON-command and **inverted**.

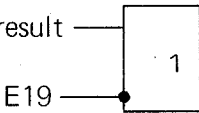
Command	Abbreviation	Symbol	PLC-Programme
OR with inverted operand	ON		ON E19

C 1.7) Exclusive OR-Command: XO

With the aid of the XO-command, two input variables can be gated according to the logical Exclusive OR-function.

The first input variable is

either

the logic result of an immediately preceding gating operation (U, UN, O, ON, XO, XON)

or

logic "0" in the event of an immediately preceding operation being R, RN, S, SN or =.

The second input variable is self-addressed with the XO-command.

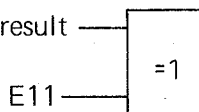
Command	Abbreviation	Symbol	PLC-Programme
Exclusive-OR	XO		XO E11

Note:

An Exclusive OR function generates a logic "1" at the output, when **only one** input is set to logic "1". If both inputs are logic "1" or logic "0", the output generates a logic "0".

C 1.8) Exclusiv OR-command with inverted operand: XON

With the aid of the XON-command, two input variables can be gated according to the logical Exclusive NOR-function.

The first input variable is

either

the logic result of an immediately preceding gating operation (U, UN, O, ON, XO, XON)

or

logic "0", in the event of an immediately preceding operation being R, RN, S, SN or =.

The second input variable is self-addressed with the XON-command and **inverted**.

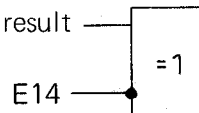
Command	Abbreviation	Symbol	PLC-Programme
Exclusive OR command with inverted operand	XON		XON E14

C 1.9) Programming of logic sequences

The logic-commands of the PLC can be arranged in chains to form a logic sequence.

Logic sequences are interrupted by the PLC-commands: R, RN, S, SN or =; a new logic sequence begins after these commands.

C 1.9.1) Logic sequences with U-commands

A logic sequence with U-commands effects a series switching of contacts. These contacts are normally open. This corresponds to an AND-gate.

PLC-Programme	Gating-logic	Abbreviated Symbol	Truth table			Contact example
			E1	E2	A1	
U E1 U E2 = A1			0	0	0	
			0	1	0	
			1	0	0	
			1	1	1	

Examples:

a)

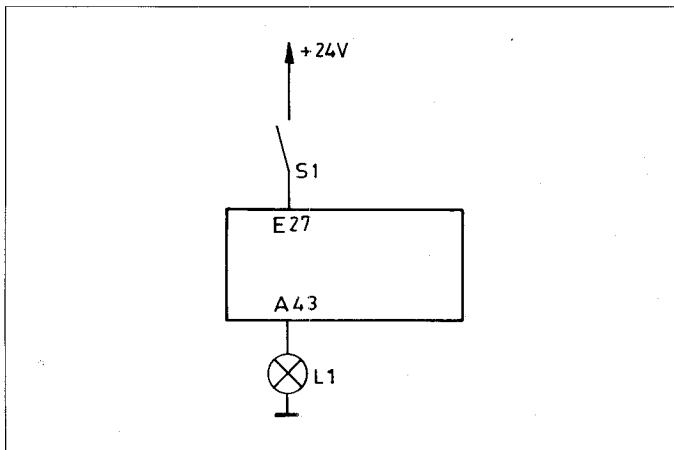

The lamp L1 is connected to the output 43. The closing of the contacts S1 should result in the illumination of the lamp. The contacts are connected to input E27 of the PLC.

PLC-Programme: U E27
= A43

This PLC-programme effects the following switching:

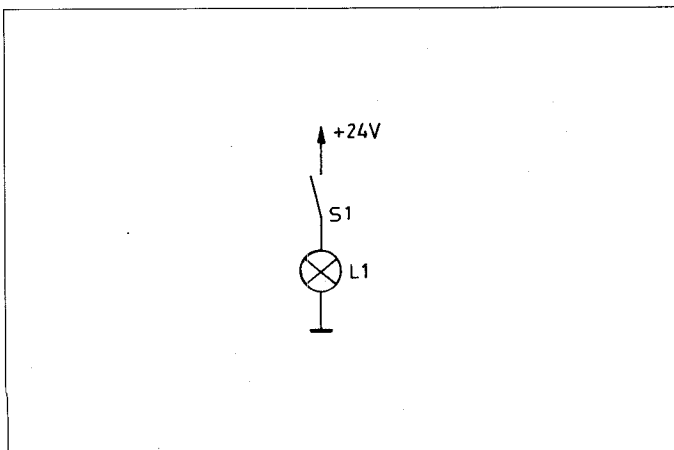

b)

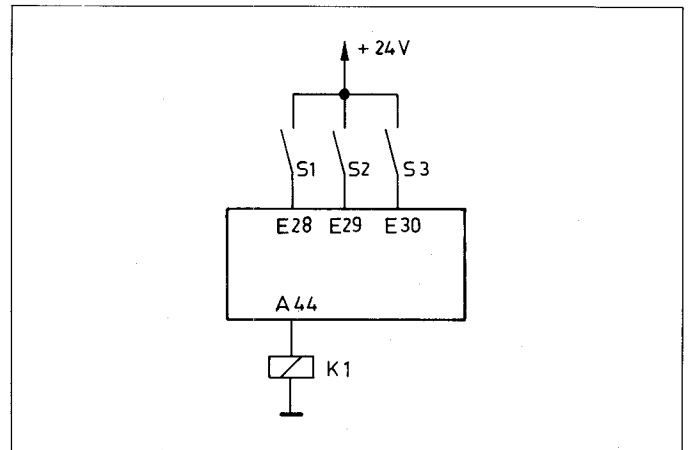

The relay K1 should energise, in the event of the contacts S1, S2 and S3 closing simultaneously.

PLC-Programme: U E28
U E29
U E30
= A44

The PLC-programme effects a series switching of the contacts S1, S2 and S3:

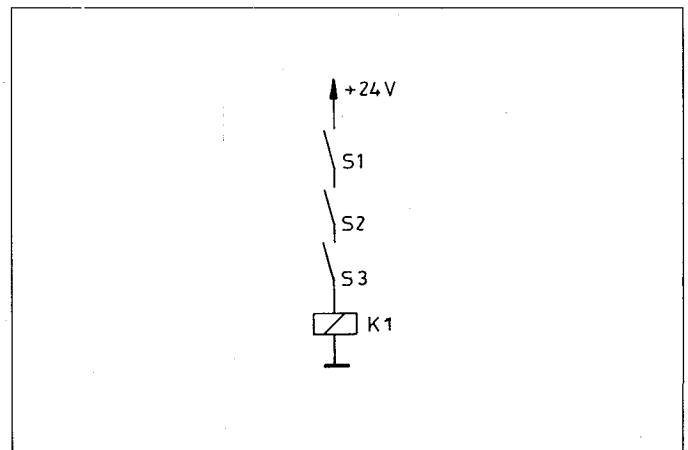

C 1.9.2) Logical sequences with UN-commands

A logical sequence with UN-commands effects a series switching of contacts. These contacts are normally closed. This corresponds to an AND gate with inverted operands.

PLC-Programme	Gating-logic	Abbreviated symbol	Truth table			Contact example
			E1	E2	A1	
UN E1 UN E2 = A1			0	0	1	
			0	1	0	
			1	0	0	
			1	1	0	

It can be deduced from the truth table that this logic element is behaving as a NOR-function. This also follows the mathematical rules governing Boolean algebra:

$$\overline{E1} \cdot \overline{E2} = \overline{E1 + E2}$$

Examples:

a)

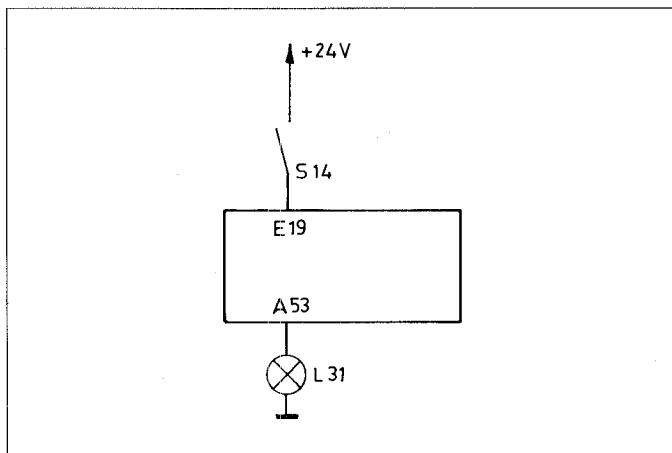

The lamp L31 should illuminate when the contact S14 is opened.

PLC-Programme: UN E19
= A53

This PLC-programme effects the following switching:

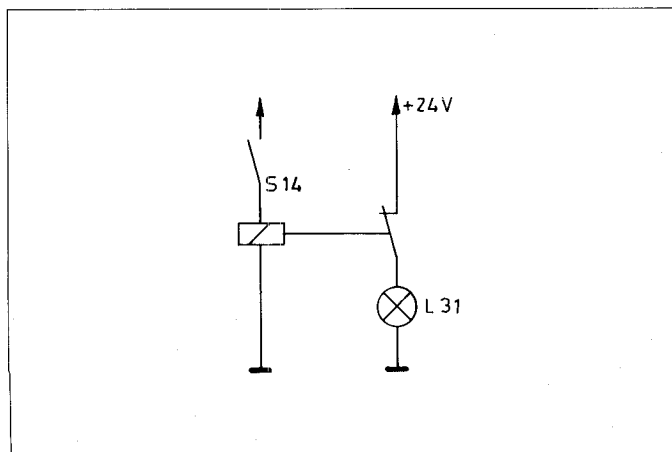

b)

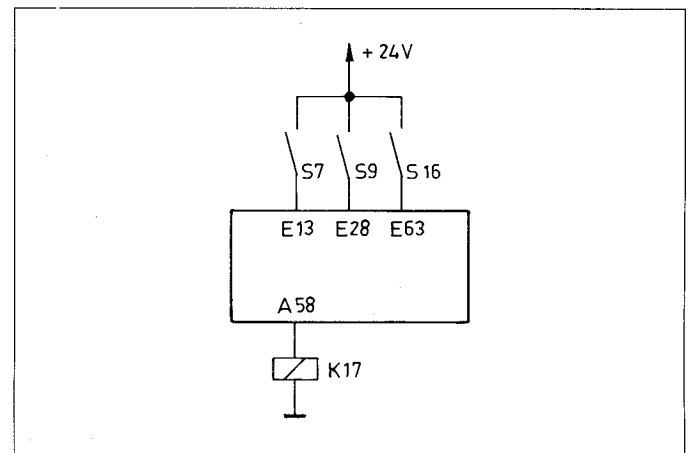

The relay K17 should only energise when all three contacts S7, S9 and S16 are open.

PLC-Programme: UN E13
UN E28
UN E63
= A58

This PLC-programme effects the following switching:

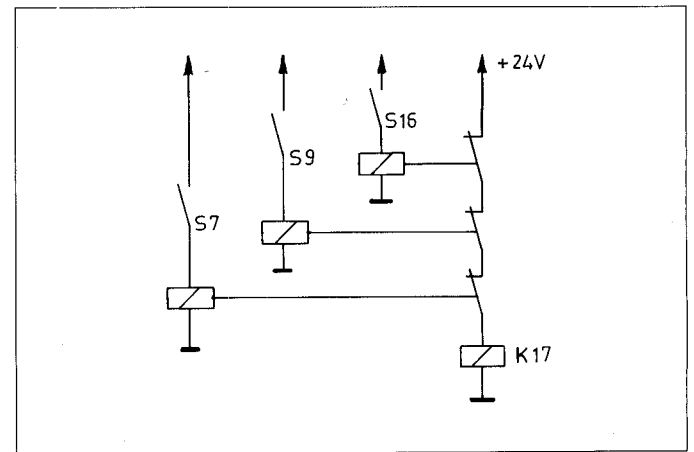

C 1.9.3) Logic sequences with O-commands

A logic sequence with O-commands effects a parallel switching of contacts. The contacts are normally open. This corresponds to an OR-gate.

PLC-Programme	Gating logic	Abbreviated symbol	Truth table			Contact example
			E1	E2	A1	
O E1 O E2 = A1			0 0 0 0 1 1 1 0 1 1 1 1			

Examples:

a)

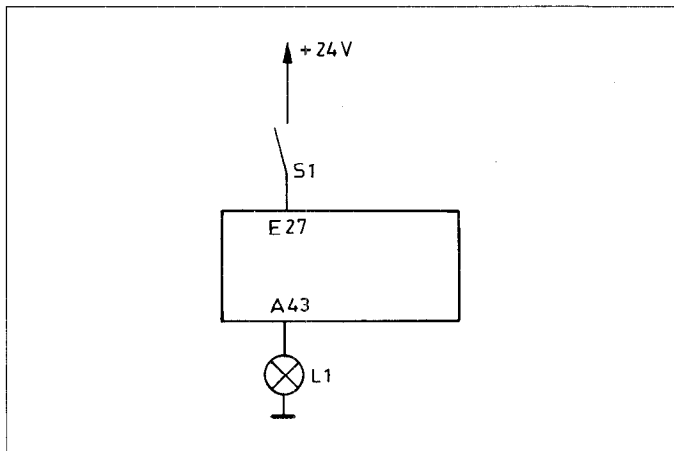

Lamp L1 is connected to output 43.
 The closing of contact S1 illuminates the lamp.
 The contact is connected to input E27 of the PLC

PLC-Programme: O E27
 = A43

This PLC-programme effects the following switching:

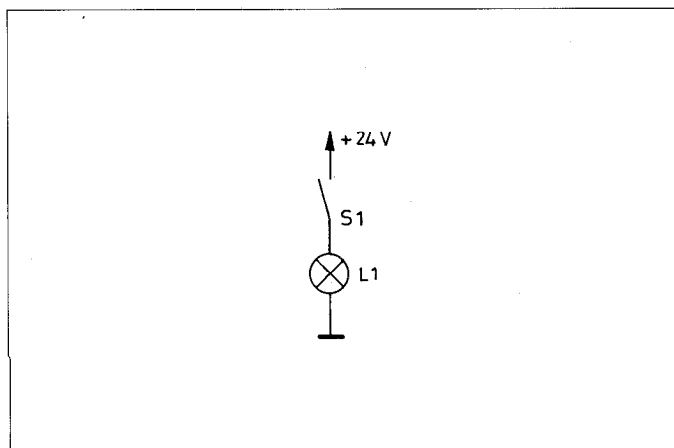

b)

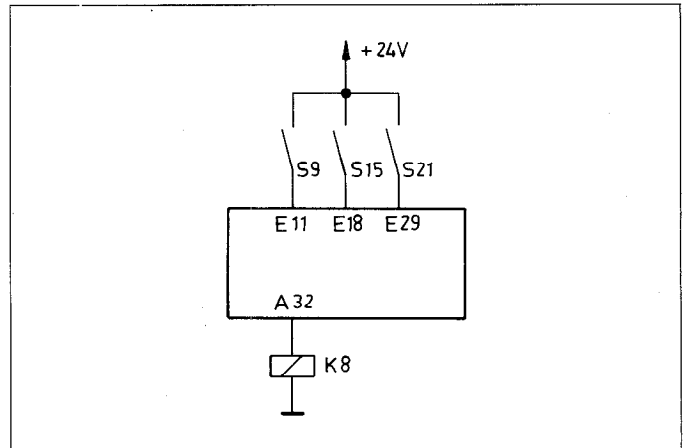

The relay K8 should energise when the contacts S9 or S15 or S21 of any combination therefore are simultaneously closed.

PLC-Programme: O E11
 O E18
 O E29
 = A32

This PLC-programme effects a parallel switching of contacts S9, S15 and S21:

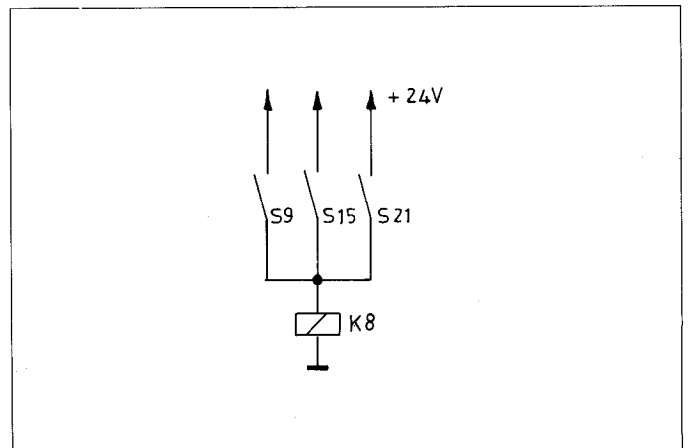

C 1.9.4) Logic sequence with ON-commands

A logic sequence with ON-commands effects a parallel switching of contacts. These contacts are normally closed. This corresponds to an OR-Gate with inverted operand.

PLC-Programme	Gating-logic	Abbreviated symbol	Truth table			Contact example
			E1	E2	A1	
ON E1 ON E2 = A1			0	0	1	
			0	1	1	
			1	0	1	
			1	1	0	

It can be deduced from the truth table that this logic element is behaving as a NAND-function. This also follows the rules governing the Boolean Algebra:

$$\overline{E1} + \overline{E2} = \overline{E1 \cdot E2}$$

Examples:

a)

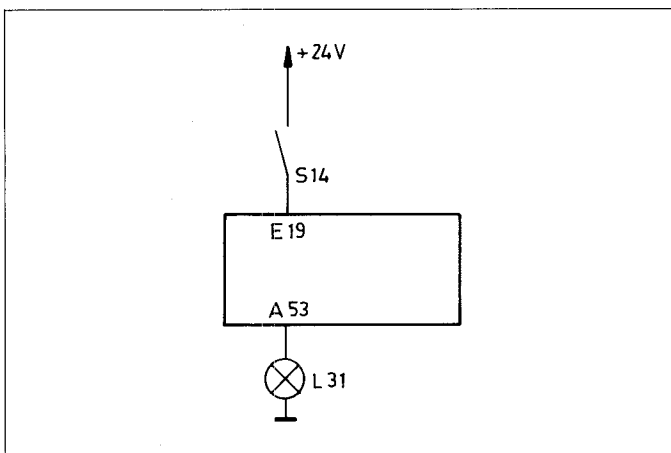

Lamp 31 should illuminate in the event of contact S14 being open.

PLC-Programme: ON E19
= A53

This PLC-programme effects the following switching:

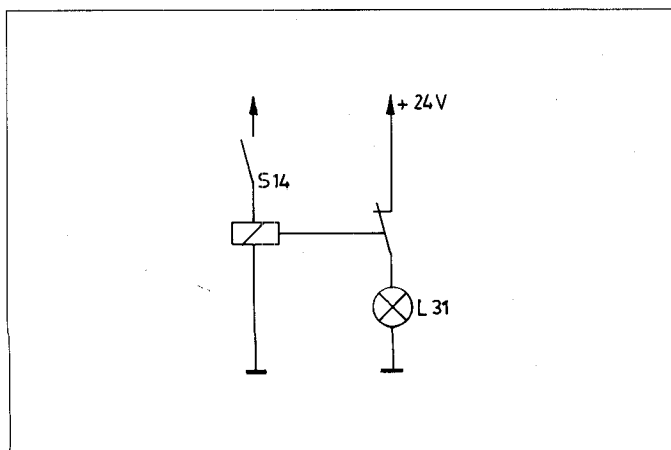

b)

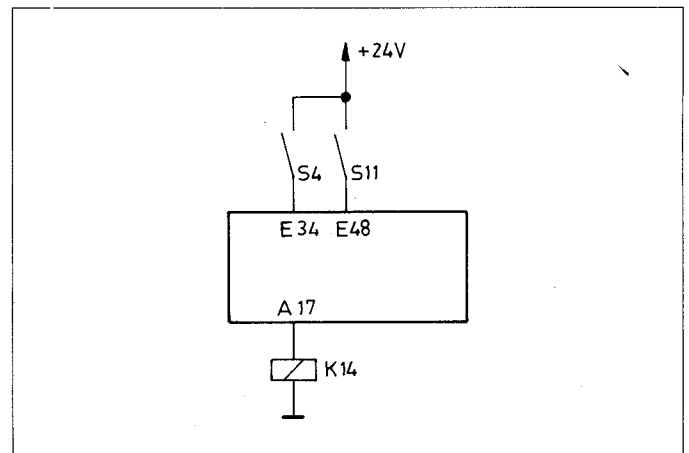

The relay K14 should energise when contact S4 or S11, or both, are open.

PLC-Programme: ON E34
ON E48
= A17

This PLC-programme effects the following switching:

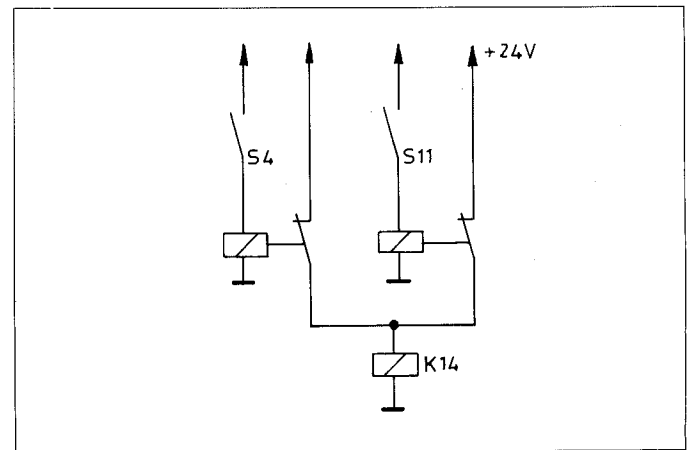

C 1.9.5) Logic sequence with XO/XON commands

A logic sequence with XO or XON-commands can, for example, be used for a parity-check.

Example:

A 3 bit binary number is to be checked for parity with the aid of a logic sequence consisting of XO-commands.

PLC-Programme	Gating logic	Truth table																																				
<pre>XO E1 XO E2 XO E3 = A1</pre>		<table border="1"> <thead> <tr> <th>E1</th> <th>E2</th> <th>E3</th> <th>A1</th> </tr> </thead> <tbody> <tr><td>0</td><td>0</td><td>0</td><td>0</td></tr> <tr><td>0</td><td>0</td><td>1</td><td>1</td></tr> <tr><td>0</td><td>1</td><td>0</td><td>1</td></tr> <tr><td>0</td><td>1</td><td>1</td><td>0</td></tr> <tr><td>1</td><td>0</td><td>0</td><td>1</td></tr> <tr><td>1</td><td>0</td><td>1</td><td>0</td></tr> <tr><td>1</td><td>1</td><td>0</td><td>0</td></tr> <tr><td>1</td><td>1</td><td>1</td><td>1</td></tr> </tbody> </table>	E1	E2	E3	A1	0	0	0	0	0	0	1	1	0	1	0	1	0	1	1	0	1	0	0	1	1	0	1	0	1	1	0	0	1	1	1	1
E1	E2	E3	A1																																			
0	0	0	0																																			
0	0	1	1																																			
0	1	0	1																																			
0	1	1	0																																			
1	0	0	1																																			
1	0	1	0																																			
1	1	0	0																																			
1	1	1	1																																			

The logic sequence produces a logic "1" for odd parity and a logic "0" for even parity.

The parity-check can also be carried out using a logic sequence consisting of XON-commands.

PLC-Programme	Gating logic	Truth table																																				
<pre>XON E1 XON E2 XON E3 = A1</pre>		<table border="1"> <thead> <tr> <th>E1</th> <th>E2</th> <th>E3</th> <th>A1</th> </tr> </thead> <tbody> <tr><td>0</td><td>0</td><td>0</td><td>1</td></tr> <tr><td>0</td><td>0</td><td>1</td><td>0</td></tr> <tr><td>0</td><td>1</td><td>0</td><td>0</td></tr> <tr><td>0</td><td>1</td><td>1</td><td>1</td></tr> <tr><td>1</td><td>0</td><td>0</td><td>0</td></tr> <tr><td>1</td><td>0</td><td>1</td><td>1</td></tr> <tr><td>1</td><td>1</td><td>0</td><td>1</td></tr> <tr><td>1</td><td>1</td><td>1</td><td>0</td></tr> </tbody> </table>	E1	E2	E3	A1	0	0	0	1	0	0	1	0	0	1	0	0	0	1	1	1	1	0	0	0	1	0	1	1	1	1	0	1	1	1	1	0
E1	E2	E3	A1																																			
0	0	0	1																																			
0	0	1	0																																			
0	1	0	0																																			
0	1	1	1																																			
1	0	0	0																																			
1	0	1	1																																			
1	1	0	1																																			
1	1	1	0																																			

The logic sequence produces a logic "0" for odd parity and a logic "1" for even parity.

C 1.9.6) Programming of an arbitrary logic sequence

Arbitrary logic sequences may be assembled from various logic commands.

Example:

```
U   E27
O   E13
ON  E23
XO  E18
=   A27
```

This programme effects the following switching:

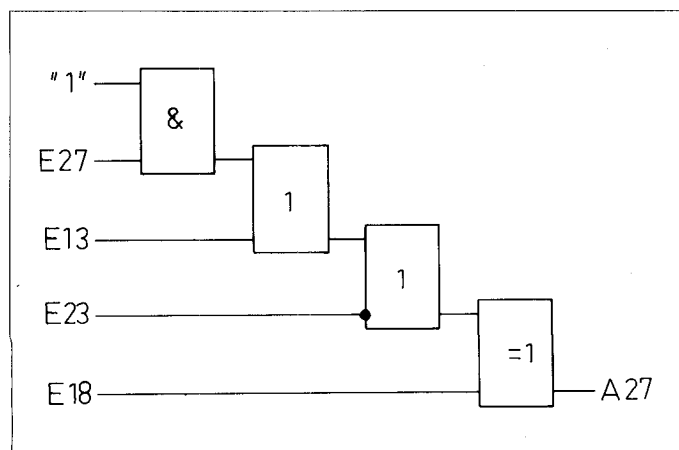

C 1.10) Setting and resetting of a marker

With the aid of the command S or SN, a marker can be set, dependent upon the preceding logic result.

With the aid of the command R or RN, a marker can be reset, dependent upon the preceding logic result.

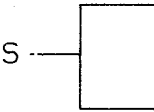
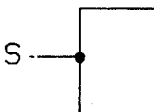
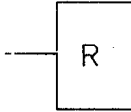
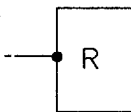
Function	Abbreviation	Symbol	PLC-Programme
Set marker or output if previous gating result is "1"	S		U E1 U M10 S M15
Set marker or output if previous gating result is "0"	SN		U E1 U M11 SN M16
Reset marker or output if previous gating result is "1"	R		U M10 R M16
Reset marker or output if previous gating result is "0"	RN		U M11 RN M15

Examples:

a)

Setting a marker

PLC-Programme: U E25
 U M33
 U M61
 S M300

If input 25 and markers 33 and 61 are logic "1", then marker 300 will be set to "1". In contrast to the = — functions, marker 300 remains set even if the logic result in the next PLC-programme cycle produces logic "0". Normally, the marker is reset by the command R or RN.

b)

Resetting of a memory location

PLC-Programme: U E18
 U E39
 R M300

C 2) Address allocation for PLC-markers

C 2.1) User markers: Address letter M

Address	Description
M 0 – M 999	User markers which are available for use and are reset after powering up
M 1000 – M 1999	User markers which are available for use and remain unchanged in memory after a power interruption. These markers remain unaffected after powering up.

C 2.2) Markers for the signal exchanges between PLC and NC: Address letter M

Address	Description
M 2000 – M 2447	Markers for signals from the NC to the PLC (NC→PLC).
M 2448 – M 3023	Markers for signals from the PLC to the NC (PLC→NC).

C 2.2.1) Markers for the axis release: X, Y, Z, IV

Marker No.	Function	Signal direction
2000	Axis release X	NC → PLC
2001	Axis release Y	
2002	Axis release Z	
2003	Axis release IV	

The markers for the axis release are set by the NC-part as follows:

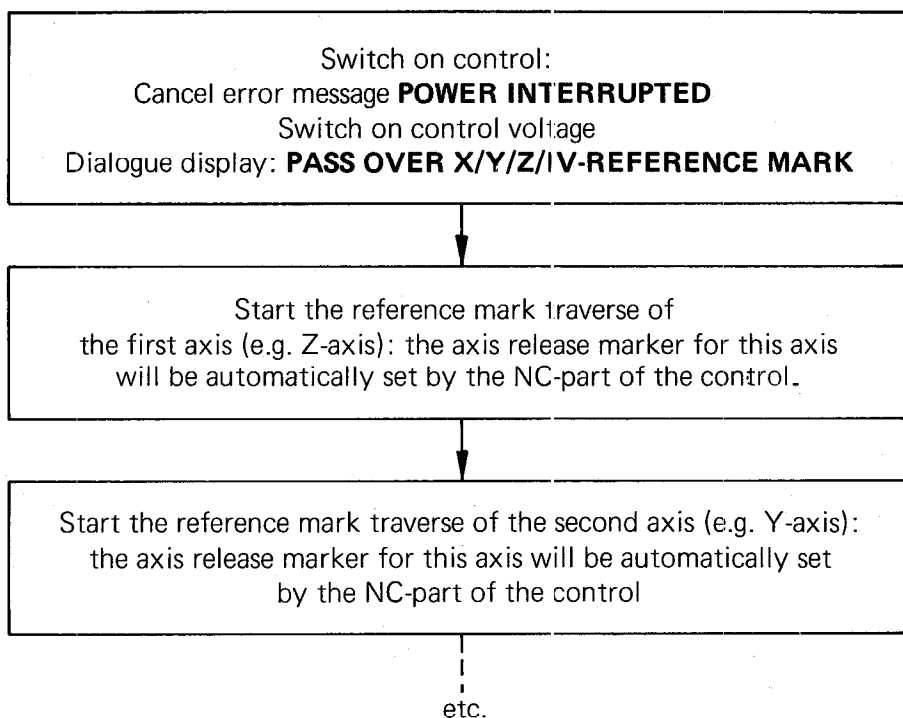

The axis release markers remain set to "1" after traversing over the reference marks, thus keeping the machine axes in closed positioning loop through the control.

Exception:

The axis release markers are reset should a position loop be inhibited by the PLC-part (e.g. in order to clamp an axis, see section C 2.2.13).

C 2.2.2) Markers for axes in position: X, Y, Z, IV

Marker No.	Function	Signal direction
2008	X-Axis in Position	NC → PLC
2009	Y-Axis in Position	
2010	Z-Axis in Position	
2011	IV-Axis in Position	

When the axes X, Y, Z or IV have achieved the positioning tolerance (defined as a window in parameters 58 and 192) after a move, the corresponding markers are set to "1" by the NC-part of the control (this also applies to the condition after power switch-on).

When the axes X, Y, Z or IV are moving and are not within the positioning-window: the corresponding markers are reset to zero by the NC-part of the control (this also applies during the reference mark approach procedure).

Note:

The marker "X axis in position" is not set for contours which can be machined at a constant contouring speed. Setting only takes place:

- .for discontinuous contours (e.g. internal corners)
- .with an interruption of the programme run

C 2.2.3) Markers for traverse-dependent lubrication impulses: X, Y, Z, IV

Marker No.	Function	Signal direction
2012	Lubrication impulse necessary X , when traverse limit exceeded	NC → PLC
2013	Lubrication impulse necessary Y , when traverse limit exceeded	
2014	Lubrication impulse necessary Z , when traverse limit exceeded	
2015	Lubrication impulse necessary IV , when traverse limit exceeded	

The traverse section, after which a lubrication-impulse-marker should be set, is specified for each axis as a machine parameter (Machine parameters 159 to 162).

When the traverse limit for an axis is exceeded, the corresponding lubrication-impulse-marker is then set to "1" by the NC-part of the control.

The summation of the traverse sections covered can be reset to zero by the PLC-programme using the following markers.

Marker No.	Function	Signal direction
2548	The summation of the traverse – dependent lubrication to be reset in the X-axis	PLC → NC
2549	The summation of the traverse – dependent lubrication to be reset in the Y-axis	
2550	The summation of the traverse – dependent lubrication to be reset in the Z-axis	
2551	The summation of the traverse – dependent lubrication to be reset in the IV-axis	

C 2.2.4) Markers for M-S-T-Code-Outputs

C 2.2.4.1) Markers for coded M-S-T-Code Outputs

Marker No.	Function	Signal direction	
2032	1. Bit T-Code (lsb)	NC → PLC	
2033	2. Bit T-Code		
2034	3. Bit T-Code		
2035	4. Bit T-Code		
2036	5. Bit T-Code		
2037	6. Bit T-Code		
2038	7. Bit T-Code		
2039	8. Bit T-Code (msb)		
2044	Strobe signal for S-Code		
2045	Strobe signal for M-Code		
2046	Strobe signal for T-Code		
2047	Strobe signal for second T-Code (see machine parameter 157)		
2064	1. Bit S-Code (lsb)	NC → PLC	
2065	2. Bit S-Code		
2066	3. Bit S-Code		
2067	4. Bit S-Code		
2068	5. Bit S-Code		
2069	6. Bit S-Code		
2070	7. Bit S-Code		
2071	8. Bit S-Code (msb)		
2072	1. Bit M-Code (lsb)		NC → PLC
2073	2. Bit M-Code		
2074	3. Bit M-Code		
2075	4. Bit M-Code		
2076	5. Bit M-Code		
2077	6. Bit M-Code		
2078	7. Bit M-Code		
2079	8. Bit M-Code (msb)		
2481	Feedback S-Code complete	PLC → NC	
2482	Feedback M-Code complete		
2483	Feedback T-Code complete		
2484	Feedback 2nd T-Code complete		

The markers for the M-S-T outputs and the markers for the strobe signals are set by the NC part of the control when an auxiliary function (M) coded spindle R.P.M. (S) or tool number (T) is programmed.

Note:

The output of the S and T-functions can be suppressed by machine parameters 61 and 62.

The programmed and unsuppressed S and T-functions are, in the event of a tool call, outputted in the following sequence by the NC part of the control:

- .first the tool number T
- .finally the spindle RPM S

In the event that an automatic tool-changer with tool magazine is installed, it can be necessary, that after the changing of the current tool, a second tool number is outputted in addition for the next tool. The second T-code can be activated by machine parameter 157 and will be outputted after the feedback "first T-code completed" (i.e. first tool changed). A search can then be made in the tool magazine for the following tool prior to the next tool change.

The setting and resetting of the corresponding markers proceeds as follows:

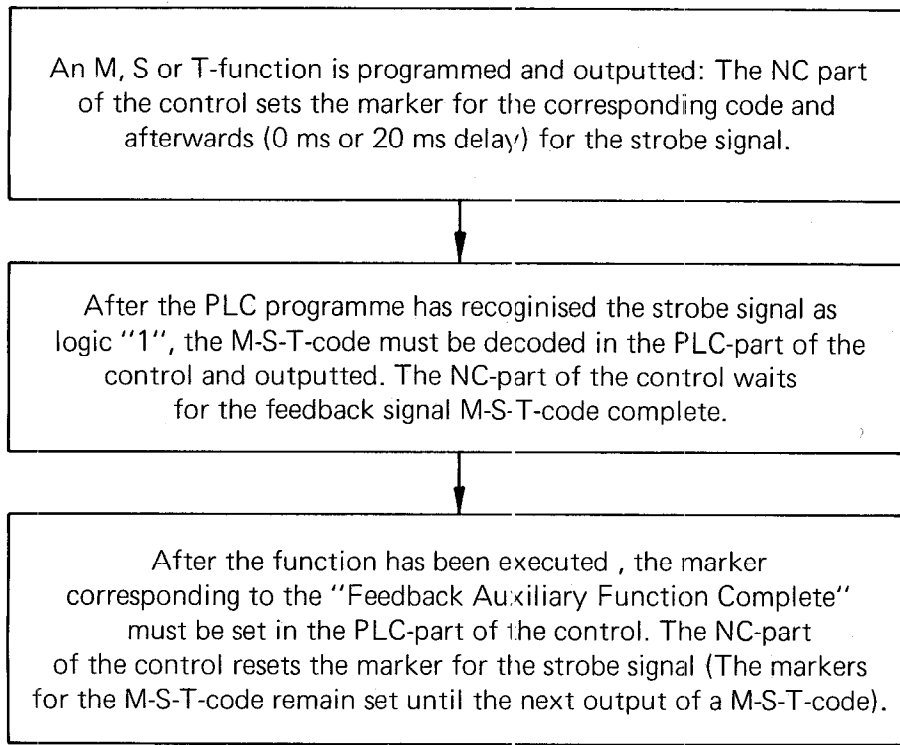

Note:

The timing for the code output must be implemented via the PLC.

For an example of the M-S-T-code output, please refer to section D 3.

C 2.2.4.2) Markers for decoded M-Code output

Marker No.	Function	Signal direction
1900	Auxiliary function M00	NC → PLC
1901	Auxiliary function M01	
1902	Auxiliary function M02	
1903	Auxiliary function M03	
1904	Auxiliary function M04	
1905	Auxiliary function M05	
1906	Auxiliary function M06	
1907	Auxiliary function M07	
1908	Auxiliary function M08	
1909	Auxiliary function M09	
1910	Auxiliary function M10	
1911	Auxiliary function M11	
1912	Auxiliary function M12	
1913	Auxiliary function M13	
1914	Auxiliary function M14	
1915	Auxiliary function M15	
1916	Auxiliary function M16	
1917	Auxiliary function M17	
1918	Auxiliary function M18	
1919	Auxiliary function M19	
1920	Auxiliary function M20	
1921	Auxiliary function M21	
1922	Auxiliary function M22	
1923	Auxiliary function M23	
1924	Auxiliary function M24	
1925	Auxiliary function M25	
1926	Auxiliary function M26	
1927	Auxiliary function M27	
1928	Auxiliary function M28	
1929	Auxiliary function M29	
1930	Auxiliary function M30	
1931	Auxiliary function M31	
1932	Auxiliary function M32	
1933	Auxiliary function M33	
1934	Auxiliary function M34	
1935	Auxiliary function M35	
1936	Auxiliary function M36	
1937	Auxiliary function M37	
1938	Auxiliary function M38	
1939	Auxiliary function M39	
1940	Auxiliary function M40	
1941	Auxiliary function M41	
1942	Auxiliary function M42	
1943	Auxiliary function M43	
1944	Auxiliary function M44	
1945	Auxiliary function M45	
1946	Auxiliary function M46	
1947	Auxiliary function M47	
1948	Auxiliary function M48	
1949	Auxiliary function M49	
1950	Auxiliary function M50	
1951	Auxiliary function M51	
1952	Auxiliary function M52	

Marker No.	Function	Signal direction
1953	Auxiliary function M53	NC → PLC
1954	Auxiliary function M54	
1955	Auxiliary function M55	
1956	Auxiliary function M56	
1957	Auxiliary function M57	
1958	Auxiliary function M58	
1959	Auxiliary function M59	
1960	Auxiliary function M60	
1961	Auxiliary function M61	
1962	Auxiliary function M62	
1963	Auxiliary function M63	
1964	Auxiliary function M64	
1965	Auxiliary function M65	
1966	Auxiliary function M66	
1967	Auxiliary function M67	
1968	Auxiliary function M68	
1969	Auxiliary function M69	
1970	Auxiliary function M70	
1971	Auxiliary function M71	
1972	Auxiliary function M72	
1973	Auxiliary function M73	
1974	Auxiliary function M74	
1975	Auxiliary function M75	
1976	Auxiliary function M76	
1977	Auxiliary function M77	
1978	Auxiliary function M78	
1979	Auxiliary function M79	
1980	Auxiliary function M80	
1981	Auxiliary function M81	
1982	Auxiliary function M82	
1983	Auxiliary function M83	
1984	Auxiliary function M84	
1985	Auxiliary function M85	
1986	Auxiliary function M86	
1987	Auxiliary function M87	
1988	Auxiliary function M88	
1989	Auxiliary function M89	
1990	Auxiliary function M90	
1991	Auxiliary function M91	
1992	Auxiliary function M92	
1993	Auxiliary function M93	
1994	Auxiliary function M94	
1995	Auxiliary function M95	
1996	Auxiliary function M96	
1997	Auxiliary function M97	
1998	Auxiliary function M98	
1999	Auxiliary function M99	
2496	Release marker for decoded M-Code output	

If the marker 2496 is set, the programmed M-functions are outputted in decoded form via markers 1900 to 1999. The release marker 2496 is necessary since the markers 1900 to 1999 are located within the range of user markers. If markers 1900 – 1999 are required for other functions, marker 2496 must be reset.

C 2.2.5) Markers for analogue output of the spindle speed

Marker No.	Function	Signal direction
2004	"0" means: The analogue voltage for the spindle drive is located in the ramp	NC → PLC
2005	"1" means: The analogue voltage for the spindle drive is 0 V	
2043	Strobe signal gear range code (G-Code) for S-Analogue output	
2104	1. Bit gear range code for S Analogue (lsb)	
2105	2. Bit gear range code for S Analogue	
2106	3. Bit gear range code for S Analogue (msb)	
2480	Feedback gear range code for S analogue complete	PLC → NC
2485	Status display and sign of the analogue output M 03	
2486	Status display and sign of the analogue output M 04	
2487	Status display M 05	
2489	Inversion of analogue voltage. The polarity which has been determined by MP172 is reversed.	
2490	Spindle CW for gearchange	
2491	Spindle CW for gearchange	

The spindle speed gear ranges are specified via machine parameters (MP78 – 85) when an analogue output for the spindle speed is selected (S-analogue is activated via machine parameter 62).

When a spindle speed requiring a new gear range, is programmed, the markers will be set as follows:

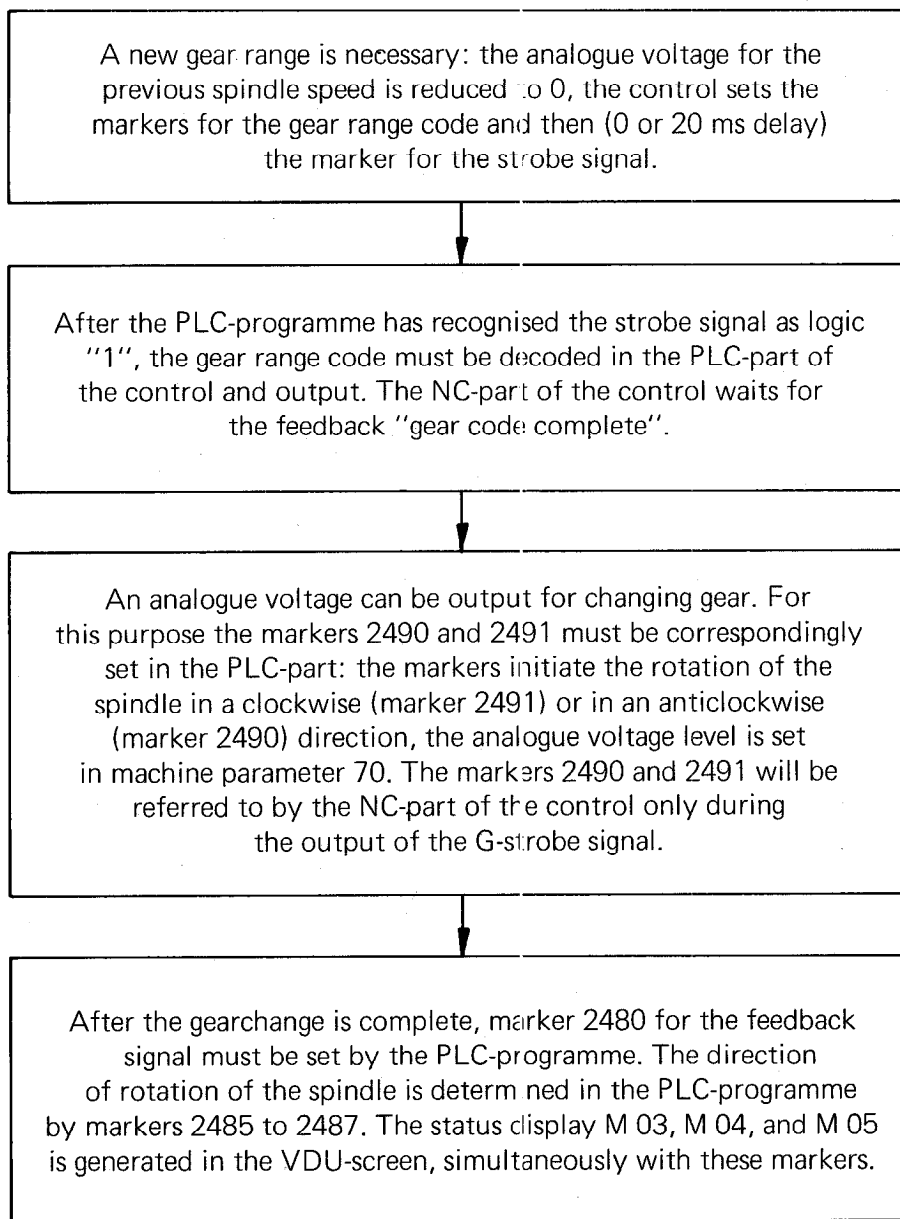

After the gearchange is complete, the control outputs the relevant analogue voltage (determined by machine parameters 86, 87, 88, 89).

For an example of the programming of the analogue spindle speed, please refer to section D 3.

C 2.2.6) Marker for tapping cycle

Marker No.	Function	Signal direction
2048	Tapping cycle is called-up	NC → PLC

If the tapping cycle is called, "1" is set for marker 2048.

C 2.2.7) Markers for the currently activated axis button: X, Y, Z, IV

Marker No.	Function	Signal direction
2096	Currently activated TNC-axis button X	NC → PLC
2097	Currently activated TNC-axis button Y	
2098	Currently activated TNC-axis button X	
2099	Currently activated TNC-axis button IV	

These markers identify the currently activated TNC-axis button: The corresponding symbol will be displayed on the VDU-screen in reverse image (e.g. **X**).

These markers can, for example, be employed for an external handwheel display. An external handwheel control panel can be implemented by using these markers in conjunction with the markers for external operation of the TNC-buttons (see section C 2.2.17).

C 2.2.8) Markers for selected operating mode

C 2.2.8.1) Markers for operating mode-code

Marker No.	Function	Signal direction
2176	1. Bit for the operating mode-code (lsb)	NC → PLC
2177	2. Bit for the operating mode-code	
2178	3. Bit for the operating mode-code	
2179	4. Bit for the operating mode-code (msb)	

The operating mode code is determined by the selected operating mode. The operating modes are coded as follows:

0000	=	Programme entry and editing
0001	=	Manual operation
0010	=	Electronic handwheel
0011	=	Single block positioning with MDI
0100	=	Program run, single block
0101	=	Automatic programme run
0110	=	Programme test

C 2.2.8.2) Markers for the decoded operating mode-code

Marker No.	Function	Signal direction
2050	Programme entry and editing	NC → PLC
2051	Manual operation	
2052	Electronic handwheel	
2053	Single block positioning with MDI	
2054	Programme run, single block	
2055	Automatic programme run	
2056	Programme test	
2057	Approach to reference point	

Markers 2050 to 2057 depend on the operating mode which has been selected.

C 2.2.9) Markers for the first PLC-program cycle after power on and after interruption of PLC-programme

Marker No.	Function	Signal direction
2180	1. PLC-programme cycle after a power on	NC → PLC
2185	1. PLC-programme cycle after interruption of PLC-programme	

Marker 2180 is set at logic "1" only during the first PLC-programme-cycle after a power on. This also applies to Marker 2185 during the first PLC-program-cycle after an interruption of the PLC-programme.

C 2.2.10) Markers affected by machine parameter 158

Marker No.	Function	Signal direction
2192	Value 1	NC → PLC
2193	Value 2	
2194	Value 4	
2195	Value 8	
2196	Value 16	
2197	Value 32	
2198	Value 64	
2199	Value 128	
2200	Value 256	
2201	Value 512	
2202	Value 1024	
2203	Value 2048	
2204	Value 4096	
2205	Value 8192	
2206	Value 16384	
2207	Value 32768	

Markers 2192 to 2207 can be set or reset via machine parameter 158. The contents of these markers are utilised to activate various PLC-programme routines. It is therefore possible to employ one PLC-programme for various machines. In the event, for example, that machines of a particular series are fitted with different gear ranges, a common PLC-programme can be employed for these machines. The different PLC-programme routines for the decoding the gear ranges are selected by appropriate entry values in machine parameter 158.

The value of the markers which are to be set for a machine are simply added and the resultant numeric value is entered in machine parameter 158.

Example:

The marker 2193, 2199 and 2206 should be set. The entry value for machine parameter 158 is established as follows:





























Marker No. 2193:	Value	2
Marker No. 2199:	Value	128
Marker No. 2206:	Value	16 384



























Entry value	16 514
-------------	--------

Note:

These markers should not be set in the PLC-programme. Setting and resetting should, without exception, take place via machine parameter 158.

C 2.2.11) Markers for inhibiting buttons

Marker No.	Function	Signal direction
2182	Inhibited TNC-button presse	NC → P_C
2855	 Inhibit button	PLC → NC
2856	 Inhibit button	
2857	 Inhibit button	
2858	 Inhibit button	
2859	 Inhibit button	
2860	 Inhibit button	
2861	 Inhibit button	
2862	 Inhibit button	
2863	 Inhibit button	
2864	 Inhibit button	
2868	 Inhibit button	
2869	 Inhibit button	
2870	 Inhibit button	
2871	 Inhibit button	
2872	 Inhibit button	
2880	 Inhibit button	
2881	 Inhibit button	
2882	 Inhibit button	
2883	 Inhibit button	
2884	 Inhibit button	
2885	 Inhibit button	
2886	 Inhibit button	
2887	 Inhibit button	
2888	 Inhibit button	
2889	 Inhibit button	
2890	 Inhibit button	
2891	 Inhibit button	
2892	 Inhibit button	

Marker No.	Function	Signal direction
2893	 Inhibit button	PLC → NC
2894	 Inhibit button	
2895	 Inhibit button	
2896	 Inhibit button	
2897	 Inhibit button	
2898	 Inhibit button	
2899	 Inhibit button	
2900	 Inhibit button	
2901	 Inhibit button	
2902	 Inhibit button	
2903	 Inhibit button	
2904	 Inhibit button	
2905	 Inhibit button	
2906	 Inhibit button	
2907	 Inhibit button	
2908	 Inhibit button	
2909	 Inhibit button	
2910	 Inhibit button	
2911	 Inhibit button	
2912	 Inhibit button	
2913	 Inhibit button	
2914	 Inhibit button	
2915	 Inhibit button	
2920	 Inhibit button	
2921	 Inhibit button	
2922	 Inhibit button	
2923	 Inhibit button	

The buttons on the TNC front panel can be inhibited by setting the corresponding markers. When an inhibited TNC-button is pressed, the NC-part signals this by setting the marker 2182. **This marker must be reset again by the PLC-programme.**

C 2.2.12) Markers for control status and error messages

Marker No.	Function	Signal direction
2183	Program interruption (Display: "Control in operation" flashing)	NC → PLC
2184	Control in operation (Display: "Control in operation" either on or flashing)	
2190	Eraseable error message is displayed	
2191	Error message: "External emergency stop" is displayed	
2815	Flashing error message from PLC	PLC → NC
2924	Error message 0 from PLC to be displayed in VDU-screen	
2925	Error message 1	
2926	Error message 2	
2927	Error message 3	
2928	Error message 4	
2929	Error message 5	
2930	Error message 6	
2931	Error message 7	
2932	Error message 8	
2933	Error message 9	
2934	Error message 10	
2935	Error message 11	
2936	Error message 12	
2937	Error message 13	
2938	Error message 14	
2939	Error message 15	
2940	Error message 16	
2941	Error message 17	
2942	Error message 18	
2943	Error message 19	
2944	Error message 20	
2945	Error message 21	
2946	Error message 22	
2947	Error message 23	
2948	Error message 24	
2949	Error message 25	
2950	Error message 26	
2951	Error message 27	
2952	Error message 28	
2953	Error message 29	
2954	Error message 30	
2955	Error message 31	
2956	Error message 32	
2957	Error message 33	
2958	Error message 34	
2959	Error message 35	
2960	Error message 36	
2961	Error message 37	
2962	Error message 38	
2963	Error message 39	
2964	Error message 40	
2965	Error message 41	
2966	Error message 42	
2967	Error message 43	
2968	Error message 44	
2969	Error message 45	
2970	Error message 46	
2971	Error message 47	

Marker No.	Function	Signal direction
2972	Error message 48	PLC → NC
2973	Error message 49	
2974	Error message 50	
2975	Error message 51	
2976	Error message 52	
2977	Error message 53	
2978	Error message 54	
2979	Error message 55	
2980	Error message 56	
2981	Error message 57	
2982	Error message 58	
2983	Error message 59	
2984	Error message 60	
2985	Error message 61	
2986	Error message 62	
2987	Error message 63	
2988	Error message 64	
2989	Error message 65	
2990	Error message 66	
2991	Error message 67	
2992	Error message 68	
2993	Error message 69	
2994	Error message 70	
2995	Error message 71	
2996	Error message 72	
2997	Error message 73	
2998	Error message 74	
2999	Error message 75	
3000	Error message 76	
3001	Error message 77	
3002	Error message 78	
3003	Error message 79	
3004	Error message 80	
3005	Error message 81	
3006	Error message 82	
3007	Error message 83	
3008	Error message 84	
3009	Error message 85	
3010	Error message 86	
3011	Error message 87	
3012	Error message 88	
3013	Error message 89	
3014	Error message 90	
3015	Error message 91	
3016	Error message 92	
3017	Error message 93	
3018	Error message 94	
3019	Error message 95	
3020	Error message 96	
3021	Error message 97	
3022	Error message 98	
3023	Error message 99 from PLC to be displayed in VDU-screen	

Display: Control in operation

The initial program status is displayed in the VDU-screen of the TNC 150 via the symbol ✕ (see illustration).

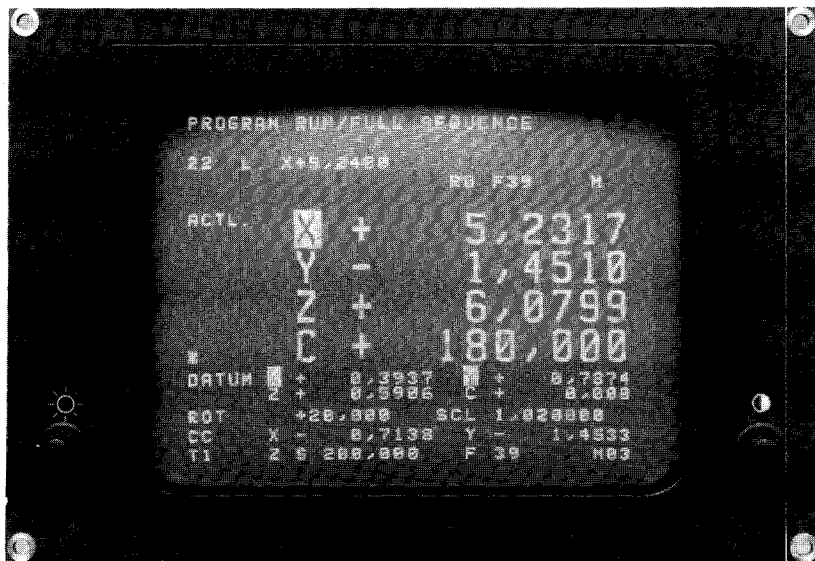

The NC-part of the control signals a program interruption to the PLC via marker 2183 (display flashes). The initial status is signalled via the marker 2184 (display on or flashing). When both markers are reset, the program run has been terminated.

Error message NC → PLC

When an erasable **error message** is displayed in the VDU, the NC-part of the control sets the marker **2190**.

When the **error message EXTERNAL EMERGENCY STOP** is displayed, the NC-part of the control sets the marker **2190 and 2191**. With flashing error messages from the NC, the program run of the PLC is halted and the PLC-outputs set to "0".

Error messages PLC → NC

The NC-part of the control can display error messages from the PLC-part. The PLC-error messages are selected via markers **2924 to 3023**.

The error messages are coded from 0 – 99. When a marker for a PLC error message is set, the following error message is displayed, e.g.

PC : ERROR 58

on the VDU-screen of the control.

Plain language error messages can also be displayed instead of the coded error messages (e.g. Oil pressure too low). The error messages 0 – 34 may have max. 32 characters; the error messages 35 – 99 max. 16 characters. Should you require specific plain language error messages, please contact your nearest HEIDENHAIN agency.

The setting of the marker 2815 results in the markers 2924 to 3023 being checked. If one of these markers is set, then the error message will be shown as a flashing display. Should none of the markers for the PLC-error messages be set, then

EMERGENCY STOP PC

is shown as a flashing display.

C 2.2.13) Markers for inhibiting the Servo Loop

Marker No.	Function	Signal direction
2492 2493 2494 2495	Enable the servo loop for the X-axis Enable the servo loop for the Y-axis Enable the servo loop for the Z-axis Enable the servo loop for the IV-axis	PLC → NC
2544 2545 2546 2547	Open X-axis servo loop Open Y-axis servo loop Open Z-axis servo loop Open IV-axis servo loop	

Operation with open loop control (after a positioning procedure) generally implies a longer delay in switching axes over. Since these delays are unnecessary for machines with permanently activated live servo control loops, the marker **“Enable Servo Loop” (markers 2492 to 2495)** has been made available. Only when these markers are set, does the NC-part of the control wait for the **PLC-signal “Open Servo loop” (markers 2544 to 2547)**, when the marker **“Axis in Position” (markers 2008 to 2011)** from the NC-part of the control has been set.

In operation without “Enable Opening of Control Loop”, the switching over from one axis to another takes place as quickly as possible.

Note:

If the marker for “Enable opening of Control Loop” has not been set, the control loop cannot be opened with the markers 2544 to 2547.

Should a control loop be opened (e.g. for clamping of axes), the markers are set as follows:

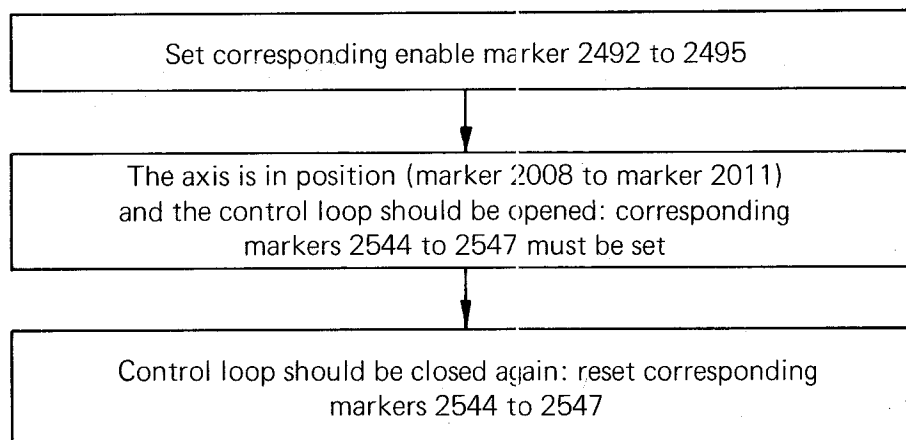

C 2.2.14) Markers for transfer of actual position values as nominal values (Teach-in)

Marker No.	Function	Signal direction
2552 2553 2554 2555	Teach-in for position loop X-axis Teach-in for position loop Y-axis Teach-in for position loop Z-axis Teach-in for position loop IV-axis	PLC → NC

If the appropriate markers 2552 to 2555 are set to logic “1”, the momentary position value is transformed into a nominal value.

Note:

Teach-in, is only possible in the manual operating mode.

C 2.2.15) Markers for external buttons and switches

Marker No.	Function	Error message	Signal direction
2448	NC-Start	A	PLC → NC
2449	NC-Rapid	B	
2450	Latching function for Manual traverse	C	
2451	Feed release	D	
2456	Manual traverse X+	I	
2457	Manual traverse X-	J	
2458	Manual traverse Y+	K	
2459	Manual traverse Y-	L	
2460	Manual traverse Z+	M	
2461	Manual traverse Z-	N	
2462	Manual traverse IV+	O	
2463	Manual traverse IV-	P	
2464	Complemented NC-Start		
2465	Complemented NC-Rapid Override		
2466	Complement latching Function for manual traverse		
2467	Complemented feed release		
2472	Complemented manual traverse X+		
2473	Complemented manual traverse X-		
2474	Complemented manual traverse Y+		
2475	Complemented manual traverse Y-		
2476	Complemented manual traverse Z+		
2477	Complemented manual traverse Z-		
2478	Complemented manual traverse IV+		
2479	Complemented manual traverse IV-		
2488	NC-Stop ("0" corresponds to Stop)		
2556	Reference end position for the X-axis		
2557	Reference end position for the Y-axis		
2558	Reference end position for the X-axis		
2559	Reference end position for the IV-axis		

Important functions are controlled via marker and complementary markers.

The signals from external buttons and switches must set the corresponding markers in the PLC-programme and generate the complemented markers with the inverted information in the same PLC-cycle. Should both markers not be correctly set or reset, then the flashing message

ERROR IN PC-PROGRAM A/B/C ...

is displayed.

The displayed letter A, B, C etc, indicates at which marker the fault lies (see list above).

Example:

The NC-start button is provided with two normally open contacts. The markers are then set as follows:

U E18 (first contact of the NC-start-button)
= M2448

UN E19 (second contact of the NC-start-button)
= M2464

If only one NC-Start contact exists, the programme may be written in the following way:

U E18 (NC-Start button)
= M2448

UN E18 (NC-Start button)
= M2464

The following program is wrong and should not be implemented

U E18 (NC-Start button)
= M2448

UN M2448
= M2464

A defect in the memory cell M 2448 cannot be recognised with this method of programming!

C 2.2.16) Markers for the PLC-Positioning

Marker No.	Function	Error message	Signal direction
2452	Start PLC-positioning X axis	E	PLC → NC
2453	Start PLC-positioning Y axis	F	
2454	Start PLC-positioning Z axis	G	
2455	Start PLC-positioning IV axis	H	
2468	Complemented* start PLC-positioning X axis		
2469	Complemented* start PLC-positioning Y axis		
2470	Complemented* start PLC-positioning Z-axis		
2471	Complemented* start PLC-positioning IV axis		
2560	PLC-positioning X axis (lsb)		
2561	PLC-positioning X axis		
2562	PLC-positioning X axis		
2563	PLC-positioning X axis		
2564	PLC-positioning X axis (msb)		
2565	PLC-positioning Y axis (lsb)		
2566	PLC-positioning Y axis		
2567	PLC-positioning Y axis		
2568	PLC-positioning Y axis		
2569	PLC-positioning Y axis (msb)		
2570	PLC-positioning Z axis (lsb)		
2571	PLC-positioning Z axis		
2572	PLC-positioning Z axis		
2573	PLC-positioning Z axis		
2574	PLC-positioning Z axis (msb)		
2575	PLC-positioning IV axis (lsb)		
2576	PLC-positioning IV axis		
2577	PLC-positioning IV axis		
2578	PLC-positioning IV axis		
2579	PLC-positioning IV axis (msb)		

Thirty-one position values can be programmed via machine parameters 126 to 156. These positions can be called up via the PLC-program, e.g. for the approach to a tool-change position. The markers for the PLC-positioning are only acted upon during the output of a G-M-S-T-strobe signal.

Note:

- .Software limit switches are not taken into account
- .Tool compensations are not considered.
- .A PLC-positioning procedure automatically ends path compensation.

*For programming of the complement marker please refer to section C 2.2.15.

The PLC-positions are coded as follows:

PLC-Code	calls-up the Position in Machine Parameter
0 0 0 0 0	126
0 0 0 0 1	127
0 0 0 1 0	128
0 0 0 1 1	129
0 0 1 0 0	130
0 0 1 0 1	131
0 0 1 1 0	132
0 0 1 1 1	133
0 1 0 0 0	134
0 1 0 0 1	135
0 1 0 1 0	136
0 1 0 1 1	137
0 1 1 0 0	138
0 1 1 0 1	139
0 1 1 1 0	140
0 1 1 1 1	141
1 0 0 0 0	142
1 0 0 0 1	143
1 0 0 1 0	144
1 0 0 1 1	145
1 0 1 0 0	146
1 0 1 0 1	147
1 0 1 1 0	148
1 0 1 1 1	149
1 1 0 0 0	150
1 1 0 0 1	151
1 1 0 1 0	152
1 1 0 1 1	153
1 1 1 0 0	154
1 1 1 0 1	155
1 1 1 1 0	156

Note:

PLC-code 11111 addresses the reference mark as PLC-position.

A PLC-positioning (e.g. for the X-axis) is programmed as follows:

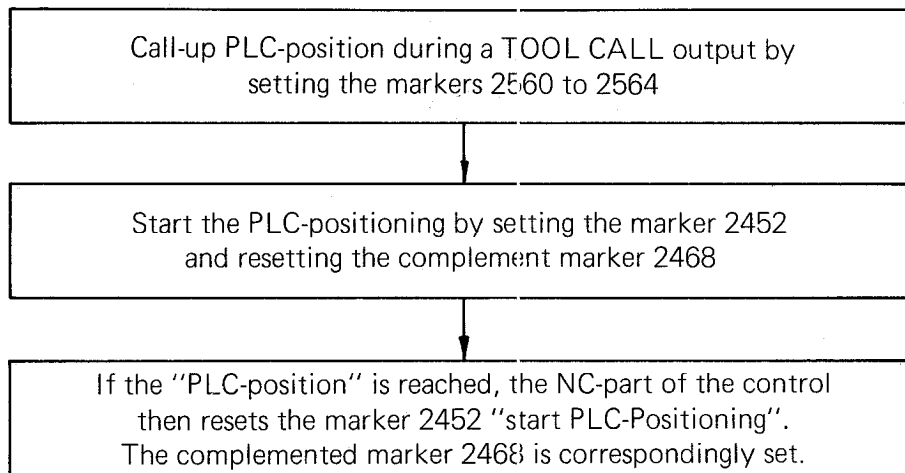

Note:



























The feedrate for the PLC-positioning is specified in machine parameters 163 to 166. In the event of simultaneous PLC-positioning (up to 3 axes), the PLC-positions will be approached in a straight line at the lowest of the specified feedrates.





























C 2.2.17) Code for the external selection of TNC-buttons

Marker No.	Function	Signal direction
2800	1. Bit TNC-button-code (lsb)	PLC → NC
2801	2. Bit TNC-button-code	
2802	3. Bit TNC-button-code	
2803	4. Bit TNC-button-code	
2804	5. Bit TNC-button-code	
2805	6. Bit TNC-button-code	
2806	7. Bit TNC-button-code	
2807	8. Bit TNC-button-code (msb)	
2808	Strobe for button-code	

Each button operation on the front panel of the TNC can be simulated by an external signal via the markers for the TNC-button-code.

The buttons are coded as follows:

Button	Code
	0011 1011
	0011 1100
	0011 1101
	0011 1110
	0011 1111
	0100 0000
	0100 0001
	0100 0010
	0100 0011
	0100 0100
	0100 1000
	0100 1001
	0100 1010
	0100 1011
	0100 1100
	0101 0100
	0101 0101
	0101 0110
	0101 0111
	0101 1000
	0101 1001
	0101 1010
	0101 1011
	0101 1100
	0101 1101
	0101 1110
	0101 1111

Button	Code
	0110 0000
	0110 0001
	0110 0010
	0110 0011
	0110 0100
	0110 0101
	0110 0110
	0110 0111
	0110 1000
	0110 1001
	0110 1010
	0110 1011
	0110 1100
	0110 1101
	0110 1110
	0110 1111
	0111 0000
	0111 0001
	0111 0010
	0111 0011
	0111 0100
	0111 0101
	0111 0110
	0111 0111
	0111 1100
	0111 1101
	0111 1110
	0111 1111

C 2.2.18) Markers for transfer of machine parameter "Limitation rpm-code" into the PLC-programme

Marker No.	Function	Signal direction
2080	1. Bit for min. rpm (lsb)	PLC → NC
2081	2. Bit for min. rpm	
2082	3. Bit for min. rpm	
2083	4. Bit for min. rpm	
2084	5. Bit for min. rpm	
2085	6. Bit for min. rpm	
2086	7. Bit for min. rpm	
2087	8. Bit for min. rpm (msb)	
2088	1. Bit for step width (lsb)	
2089	2. Bit for step width	
2090	3. Bit for step width	
2091	4. Bit for step width (msb)	

The minimum rpm and the step width from the machine parameter "limitation of rpm-code" (machine parameter 63) is transferred into the markers 2080 to 2091.

C 2.3) PLC-Inputs and PLC-Outputs: Address letters E, A

Ncte:

Before each PLC-cycle, all inputs are read-in and stored for further processing; the outputs are outputted after the complete program run. Refer to section B 2.3 for technical data on in- and outputs.

C 2.3.1) Summary

The following inputs and outputs are available:

Address	Meaning
E0 – E62 E63	PLC-inputs on the first PLC-board, internally wired on the first PLC-board
E64 – E126 E127	PLC-inputs on the second PLC-board, internally wired on the second PLC-board
PL 100 B	
A0 – A30 A31	PLC-Outputs for first PLC-board, internally wired on the first PLC-board
A32 – A62 A63	PLC-Outputs for second PLC-board internally wired on the second PLC-board
PL 110 B	
A0 – A24 A25 – A30 A31	PLC-outputs on the first PLC-board, bipolar outputs on the first PLC-board internally wired on the first PLC-board
A32 – A56 A57 – A26 A63	PLC-outputs on the second PLC-board, bipolar outputs on the second PLC-board, internally wired on the second PLC-board

The following inputs and outputs are reserved and cannot be freely allocated:

Input	Function
E0	Reference End Position X
E1	Reference End Position Y
E2	Reference End Position Z
E3	Reference End Position IV
E4	Reference Pulse Inhibit X
E5	Reference Pulse Inhibit Y
E6	Reference Pulse Inhibit Z
E7	Reference Pulse Inhibit IV
E8	Feedback Emergency Stop
E63	Overload of a PLC-output stage on the first PLC-board (internally wired)
E127	Overload of a PLC-output stage on the second PLC-board (internally wired)
Output	Function
A31	Cancellation of the "overload-condition" on the first PLC-board (internally wired)
A63	Cancellation of the "overload-condition" on the second PLC-board (internally wired)

Note:

Input E8 "Feedback Emergency Stop"!

The NC-part of the TNC 150 receives this signal direct from input E8, it is not processed by the PLC. Nevertheless, the status of the feedback can be interrogated in the PLC-programme.

C 2.3.2) Bipolar PLC-outputs for PL 110 B

The PLC-input/output board PL 110 B is equipped with bipolar output stages for the control of D.C. motors. The following output pairs are on the first PLC-board:

A25, A26
A27, A28
A29, A30

On the second PLC-board:

A57, A58
A59, A60
A61, A62

The programming is achieved as follows:
for the output stages A25, A26

Output A25 set	→	Output A25 + 15 V
Output A26 reset	→	Output A26 0 V
Output A25 reset	→	Output A25 0 V
Output A26 set	→	Output A26 + 15 V

Circuit example:

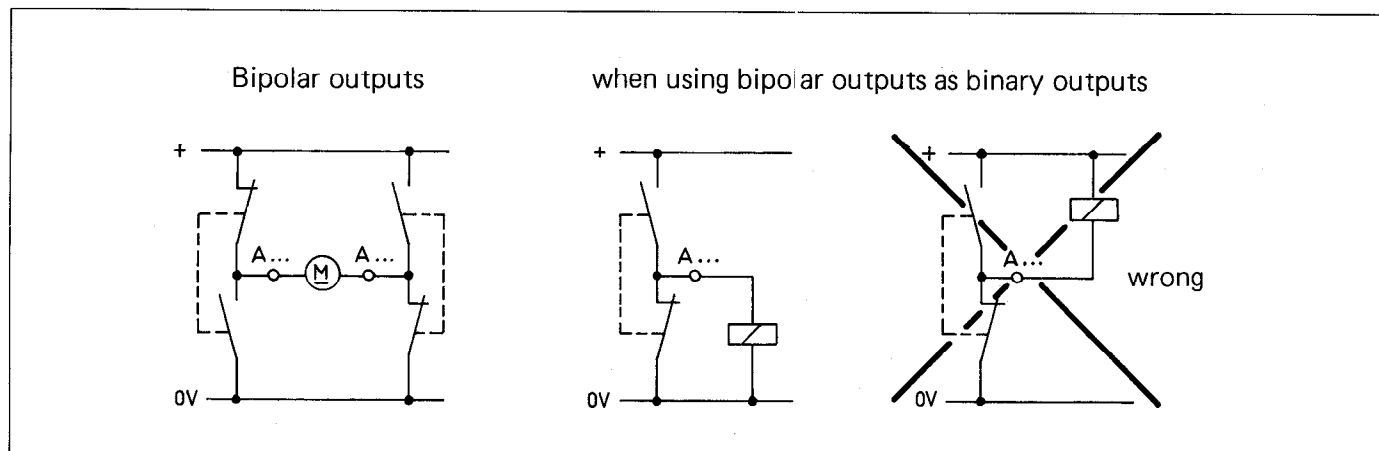

Output overcurrent protection for the bipolar outputs

The output for the overcurrent protection is set to logic "1" if the summation of the three bipolar output currents exceeds 0.8 – 0.9 A. This signal cannot be directly interrogated via the PLC. For the overcurrent protection to be evaluated, this output should be connected to a PLC-input.

Note:

Reaching the current limit of 0.8 – 0.9 A indicates no error message! This signal must be processed according to requirements.

C 2.3.3) Output "Emergency Stop"

The internal "Emergency Stop" signal is not processed by the PLC. The output is set directly by the NC-part of the control in order to minimise any delay.

The sequence of the emergency stop routine on powering up the control (i.e. checking the emergency stop contact with the aid of the input E8 "Feedback Emergency Stop") is described in the interface description for the TNC 150.

These monitoring routines must not be implemented in the PLC-programme, as the signal from the input E8 is interrogated directly by the NC-part of the control.

Note:

If two PLC-boards are connected to a control, it is sufficient when the "emergency stop" output and the "Feedback signal emergency stop" input are wired on board.

C 3) Counters

The PLC in the TNC 150 has 16 counters at its disposal, each of the 16 counters being controlled through two special markers with the identification Z. Whether or not the counter status has reached "0" can be interrogated by the use of an additional marker, also represented by the identification Z. The counter is set to the entry value programmed in the corresponding machine parameter (max. 65535) and counts backwards to the counter status "0". The counter is decremented by 1 with every cycle of the PLC-programme (20 ms).

Function	Marker identification	Remarks
Set Counter	Z0 – Z15	Through the assignment of a logic "1", the corresponding counter will be set to the preset value in the machine parameter. The assignment of the logic "1" must only exist for one PLC cycle, otherwise the setting will be repeated at each subsequent cycle.
Counter not equal to "0"	Z48 – Z63	The marker Z48 – Z63 corresponding to the counter Z0 to Z15 is at logic "1" when a counter has been set. The counter has been set. The counter status can be interrogated via Z48 to Z63. On reaching the counter status "0" the marker for the counter status is set again to logic "0". Note: For the duration of the first program cycle after the setting of the counter, the corresponding marker Z48 to Z63 remains at logic "0".
Counter impulse-release	Z96 – Z111	The counter will be decremented by "1" if the corresponding marker has a logic state "1" at the end of a PLC-cycle. In the event of the corresponding marker having a logic state "0" at the end of a PLC-cycle, no decrement occurs.

Impulse diagram

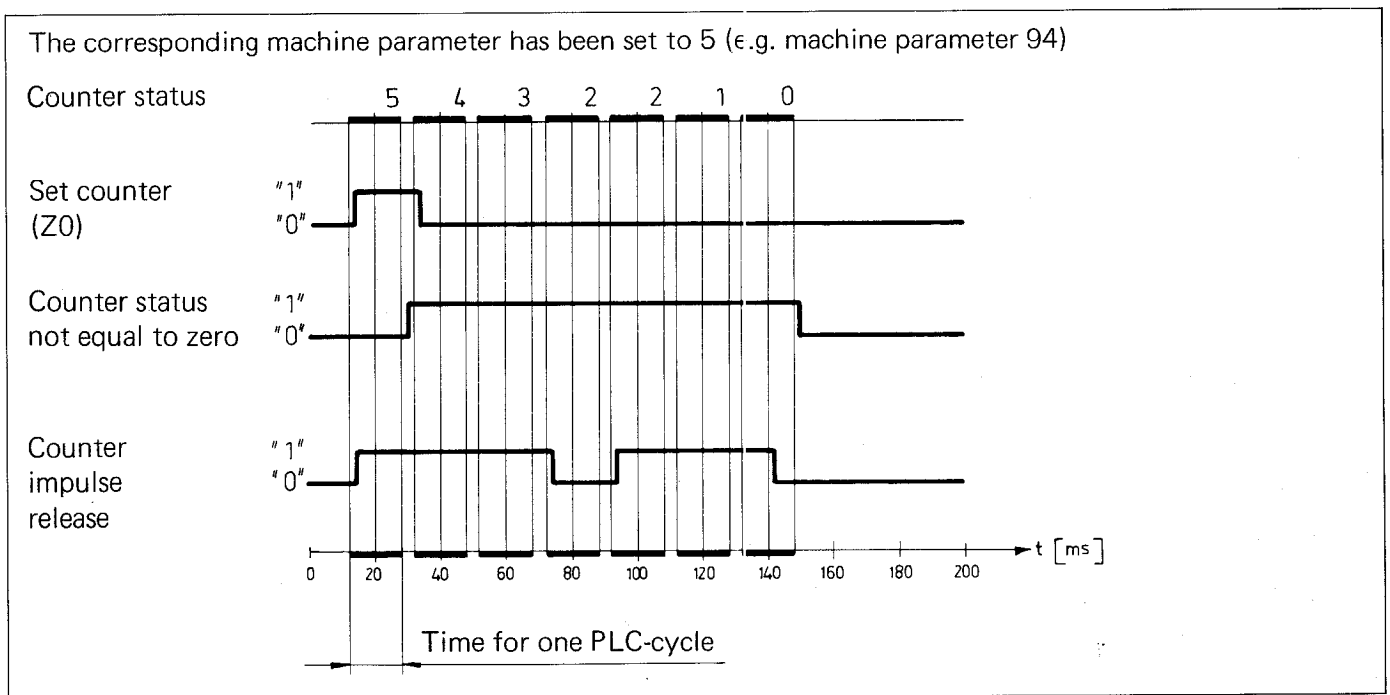

Relationship of the counter-markers to the machine parameters

Set counter	Z0	Z1	Z2	Z3	Z4	Z5	Z6	Z7	Z8	Z9	Z10	Z11	Z12	Z13	Z14	Z15
Counterstatus not equal to "0"	Z48	Z49	Z50	Z51	Z52	Z53	Z54	Z55	Z56	Z57	Z58	Z59	Z60	Z61	Z62	Z63
Counter impulse release	Z96	Z97	Z98	Z99	Z100	Z101	Z102	Z103	Z104	Z105	Z106	Z107	Z108	Z109	Z110	Z111
Machine parameter for preset value	94	95	96	97	98	99	100	101	102	103	104	105	106	107	108	109

C 4) Timers

The PLC in the TNC 150 has 16 timers at its disposal. The start of each of the 16 timers is controlled by a special marker with the identification T. The timers time out from the times programmed in the corresponding machine parameters. The unit of time is 20 ms (max. 65535 units programmable). An additional special marker with the identification T enables "Timer running" to be interrogated.

Function	Marker identification	Remarks
Timer start	T0 to T31	Through the assignment of a logic "1", the corresponding timer will be set to the preset value in the associated machine parameter and started. The assignment of the logic "1" must only exist for one PLC cycle, otherwise the setting will be repeated on each subsequent program cycle.
Timer running	T48 to T79	The marker T48 to T63 corresponding to the timer T0 to T15 is at logic "1", when a Timer has been set. The status "Timer running" can be interrogated via T48 to T63. On the timing out of the timer, the marker "Timer running" is set again to logic "0". Note: For the duration of the first program cycle after the setting of the timer, the corresponding marker T48 to T63 remains at logic "0".

Impuls diagram

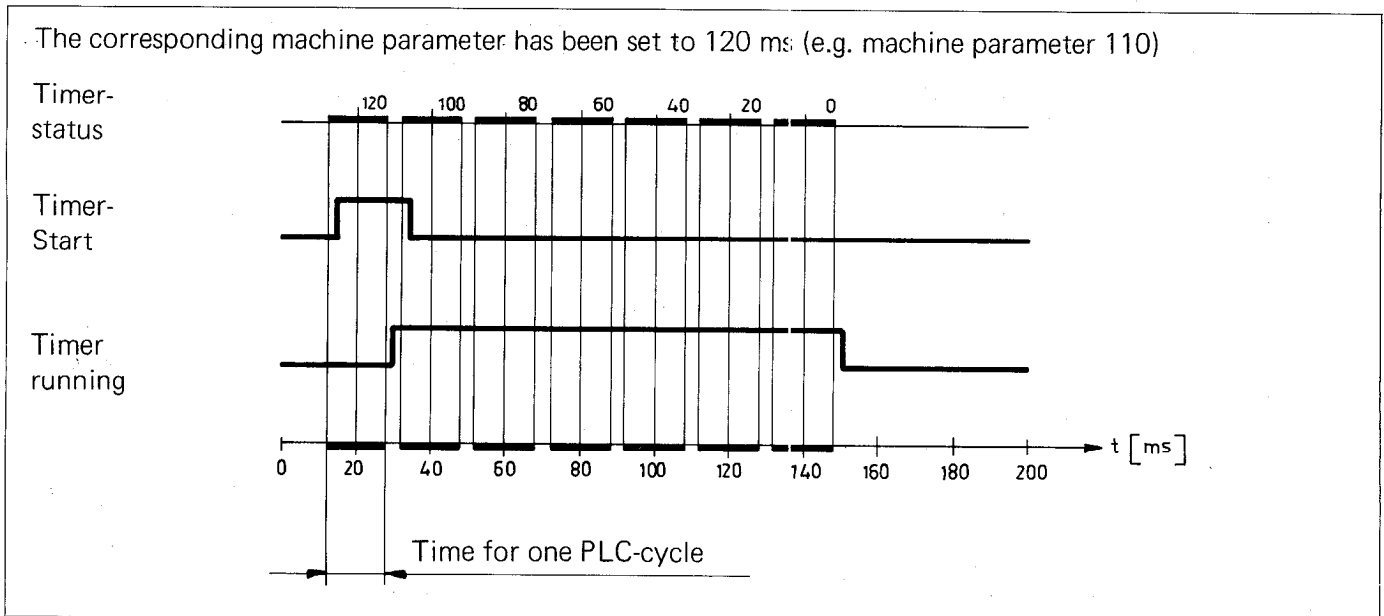

Relationship of the markers:

Timer start	T0	T1	T2	T3	T4	T5	T6	T7	T8	T9	T10	T11	T12	T13	T14	T15
Timer running	T48	T49	T50	T51	T52	T53	T54	T55	T56	T57	T58	T59	T60	T61	T62	T63
Machine parameter	110	111	112	113	114	115	116	117	118	119	120	121	122	123	124	125
Timer start	T16	T17	T18	T19	T20	T21	T22	T23	T24	T25	T26	T27	T28	T29	T30	T31
Timer running	T64	T65	T66	T67	T68	T69	T70	T71	T72	T73	T74	T75	T76	T77	T78	T79
Machine parameter	193	194	195	196	197	198	199	200	201	202	203	204	205	206	207	208

C 5) Macro-programmes

The TNC 150 Q can be equipped for customer-specific macro-programmes e.g. for aiding a toolchanger.

Exact information concerning macro-programs can be obtained from HEIDENHAIN.

C 6) Selecting and exiting from the PLC-modes

The TNC 150 control offers the possibility of programming and the subsequent testing of the PLC program.

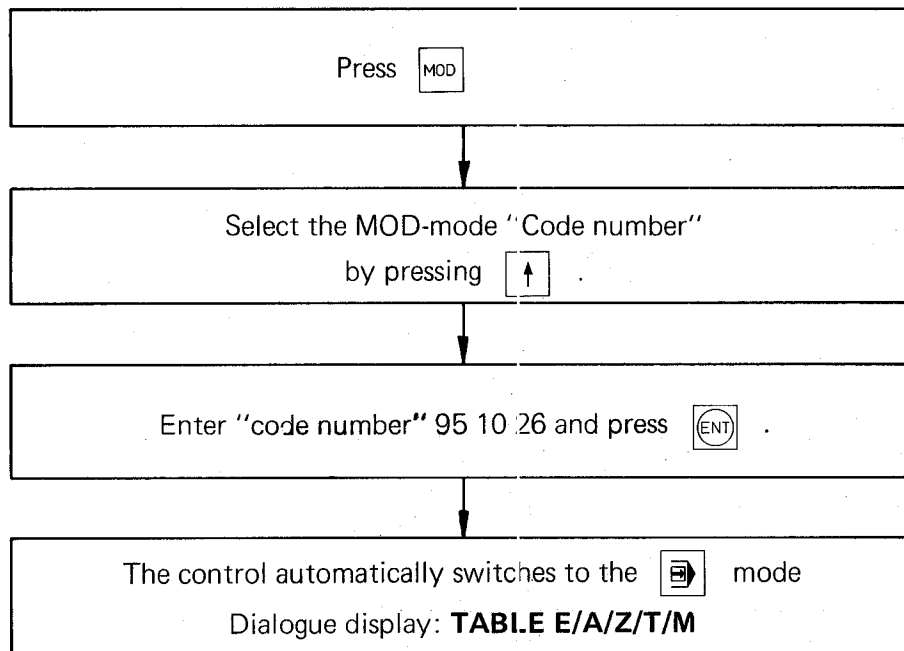

The mode buttons select the following PLC modes:

Button	Mode
[TAB] ≙ TAB	Table E/A/Z/T/M (see section C 6.3)
[PCT] ≙ PCT	PLC Programme "Trace" (see section C 6.2)
[PCE] ≙ PCE	PLC Programme "Editor" (see section C 6.1)

The PLC modes are exited by pressing **END**

C 6.1) "PLC Programme editor": PCE button

Select the "PLC Programme editor" mode with the PCE button.

The VDU displays the following:

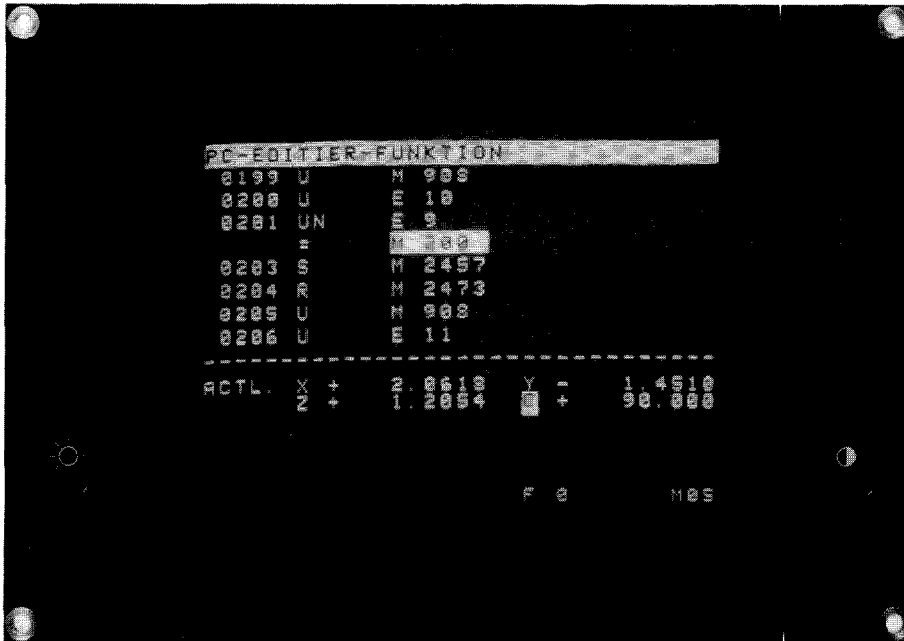

In this mode, the PLC programme can be compiled and edited. When compiling the PLC-programme at the control, the PLC-programme is stored internally in RAM (Random Access Memory).

A PLC-programme can be copied from the control onto a ME 101/102 cassette or directly into an EPROM programming unit. A master EPROM with the PLC-programme is compiled by HEIDENHAIN from the magnetic tape containing the PLC-programme.

Programme administration is also carried out by HEIDENHAIN.

In the control, there is a socket provided for the EPROM. Machine parameter 77 selects whether the machine should utilise the PLC program in RAM or EPROM.

For editing purposes, a program can be copied from EPROM into RAM.

Machine Parameter 77

Entered value 1: The PLC-programme is stored in the EPROM area.

Entered value 0: The PLC-programme is stored in the RAM area.

Note:

The PLC-programme in the RAM-memory is checked after control switch-on. An erroneous programme is erased and the following error message is displayed:

PC: PROGRAM MEMORY ERASED

C 6.1.1) Keyboard layout for PLC-programming

If the control mode "PLC program editor" is selected, some of the buttons on the front panel are assigned as PLC programming functions. A PLC-programming keyboard foil showing the appropriate button designations forms part of this manual.

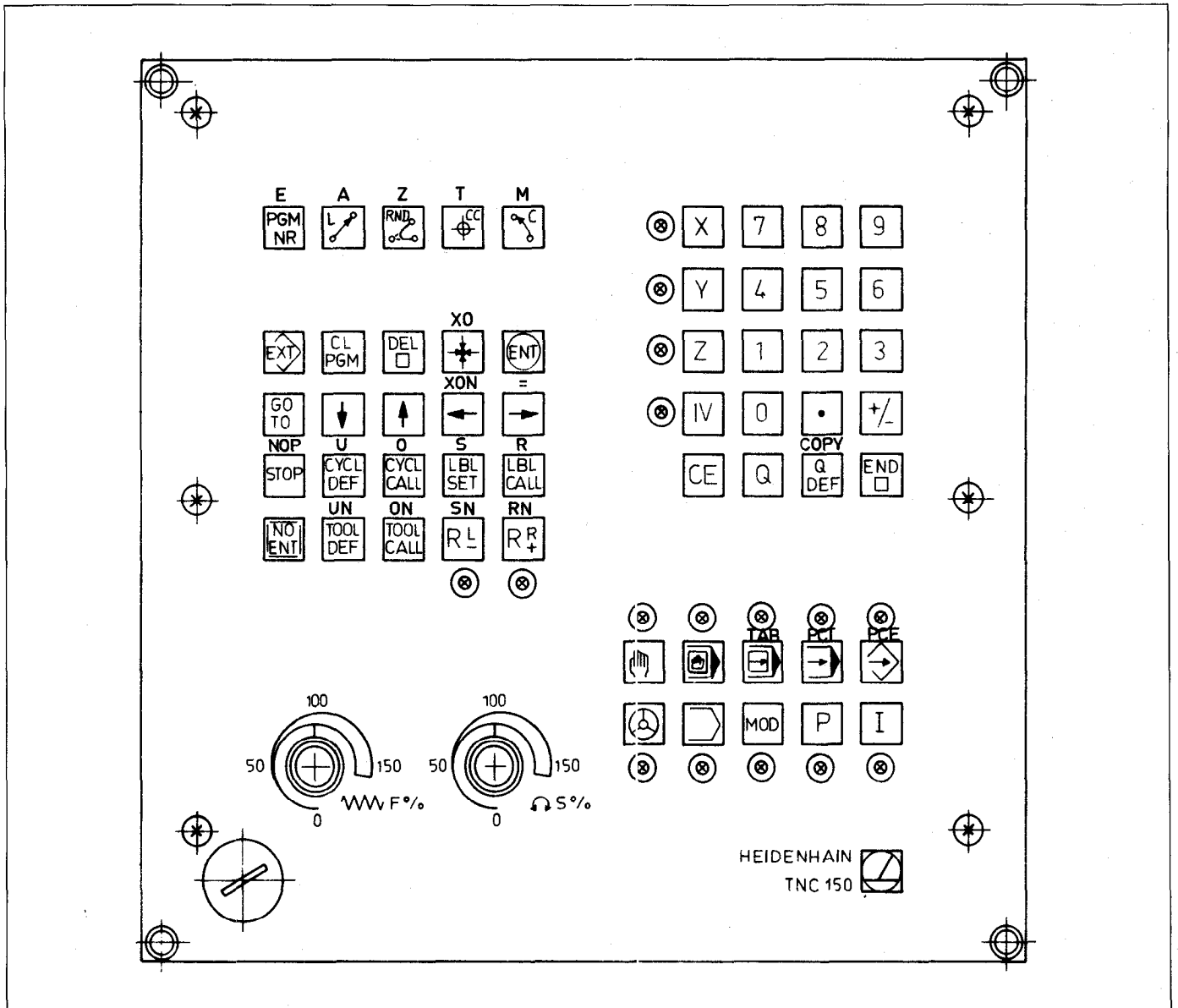

C 6.1.2) Button functions

TNC-Symbol	PLC-Symbol	PLC-Function	
		When is also pressed, the PLC-program is erased	
		Clears the actual PLC-command (VDU blank)	
		If an additional numeric value (0 ... 2047) and is pressed, the respective PLC-command is selected	
		Selects the following PLC-command	
		Selects the previous PLC-command	
		Transfers as necessary and available PLC-programme (EPROM) into RAM after additional press of -key.	
		Input/Output of PLC-programs to Cassette (ME) or printer	
		Exits from the PLC-editor into normal NC operation	
		Enters the PLC-command NOP.	
		The description of the PLC-commands can be found in section C 1	
			The following buttons provide the PLC commands with the operands. Terminate operand input with the button or by entering the next PLC-command.
			Input; plus the necessary numeric value (0 ... 125)
		Output; plus the necessary numeric value (0 ... 63)	
		Counter; plus the necessary numeric value (0 ... 15)	
		Timer; plus the necessary numeric value (0 ... 31)	
		Marker; plus the necessary numeric value (0 ... 3023)	

C 6.1.3) Programming PLC-commands

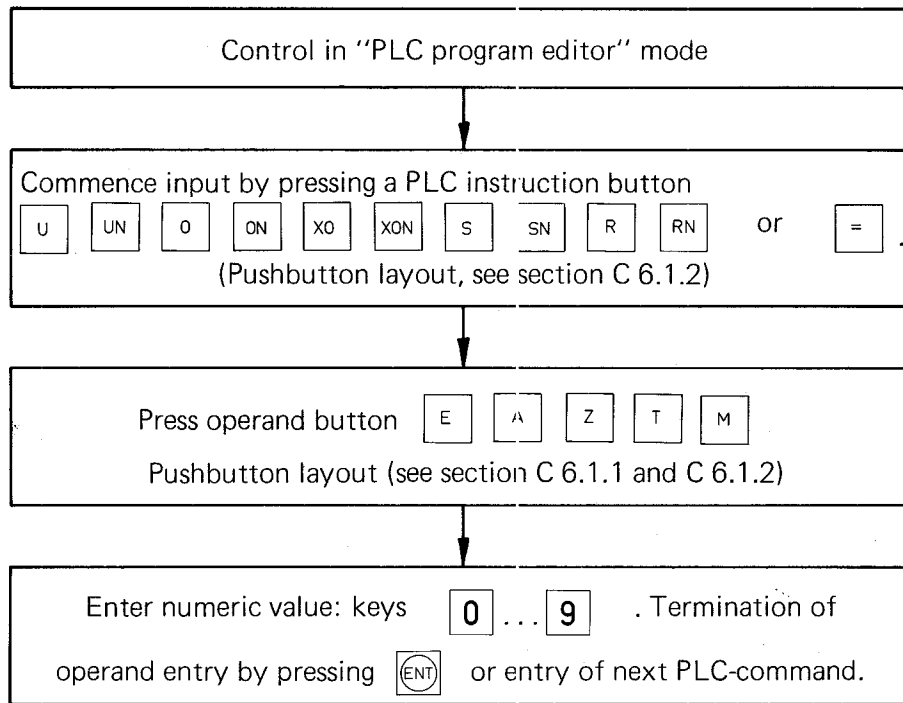

Programming the NOP PLC-command: Press .

Note:

Free command lines are displayed on the VDU as NOP's.

C 6.1.4) Call-up of a specific PLC-command

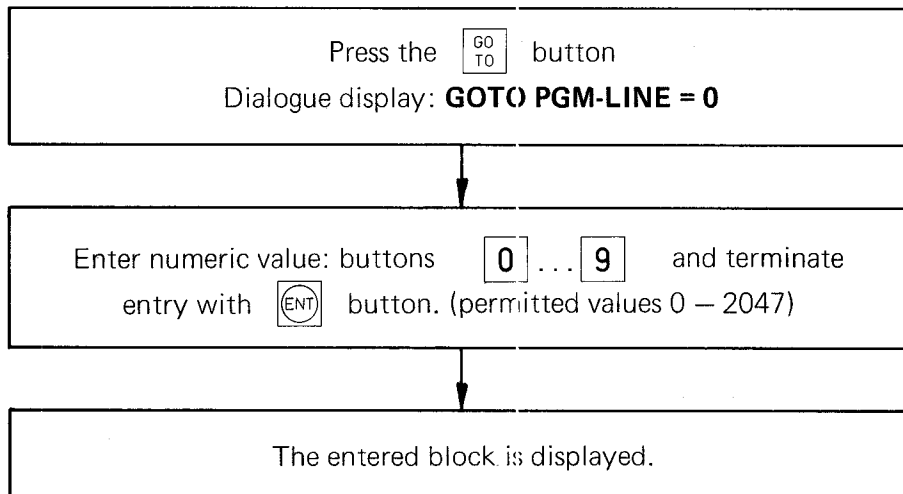

C 6.1.5) Sequential checking of PLC commands

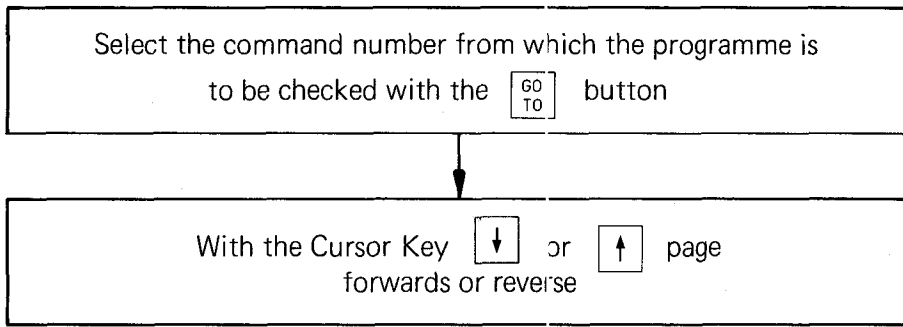

C 6.1.6) Deleting PLC-commands

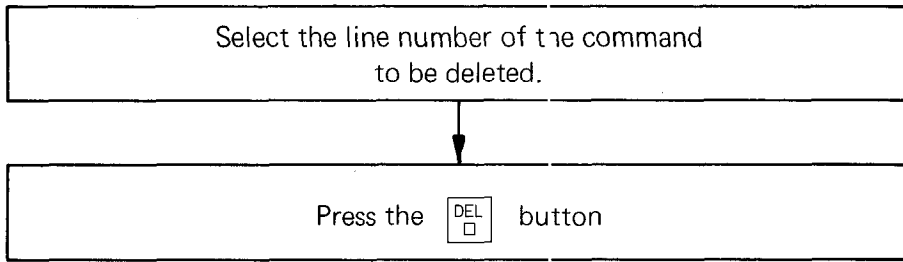

C 6.1.7) Entering PLC-commands into an existing programme

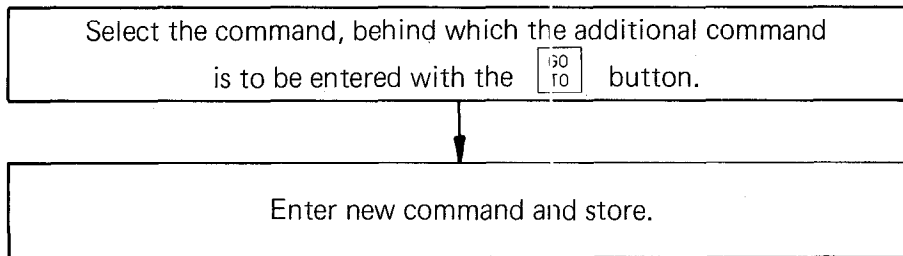

C 6.1.8) Deleting a PLC-Programme

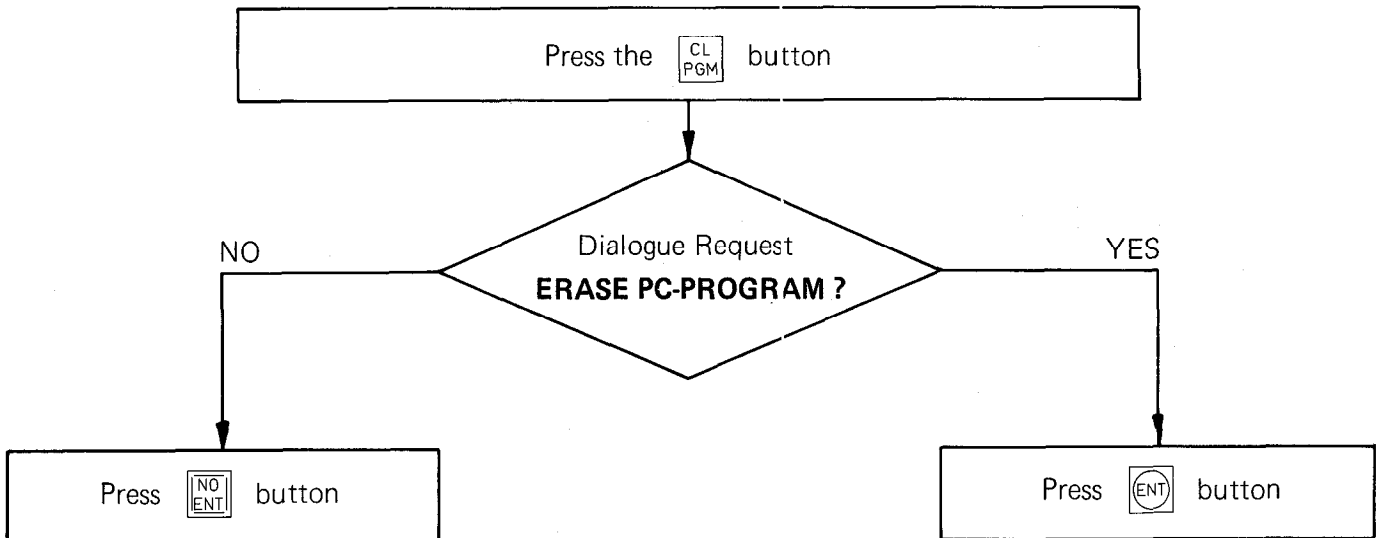

C 6.1.9) Transfer of a programme from the main memory into the read/write-store

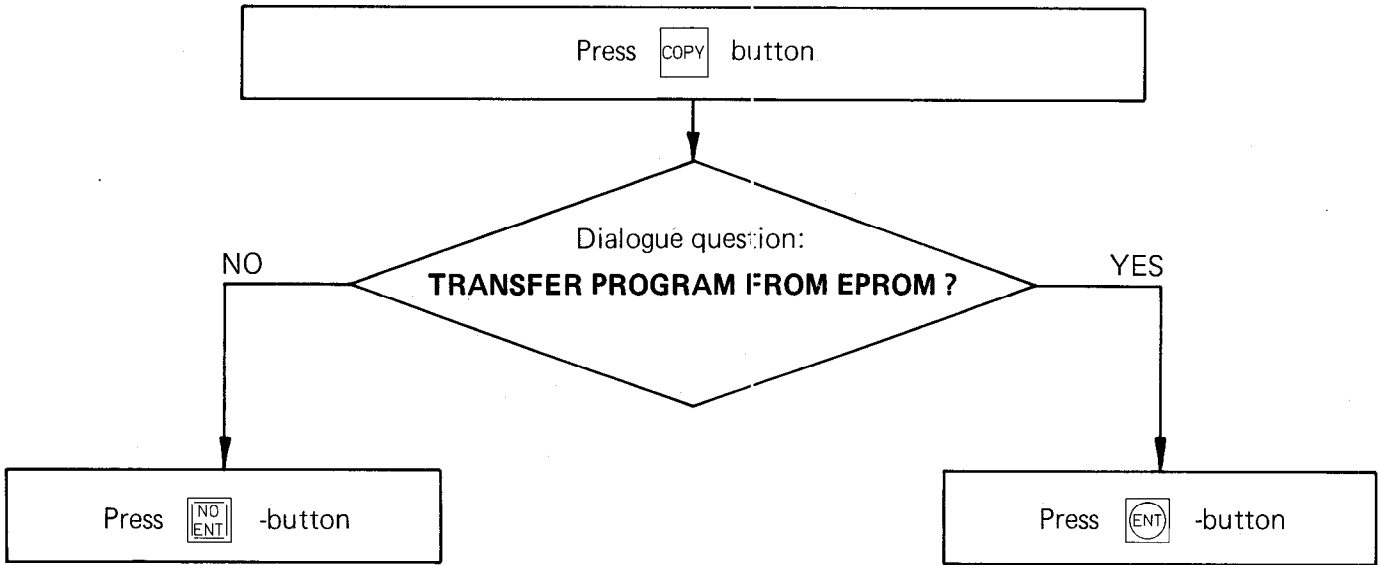

6.1.10) Input/Output of PLC-programmes on magnetic tape or printer

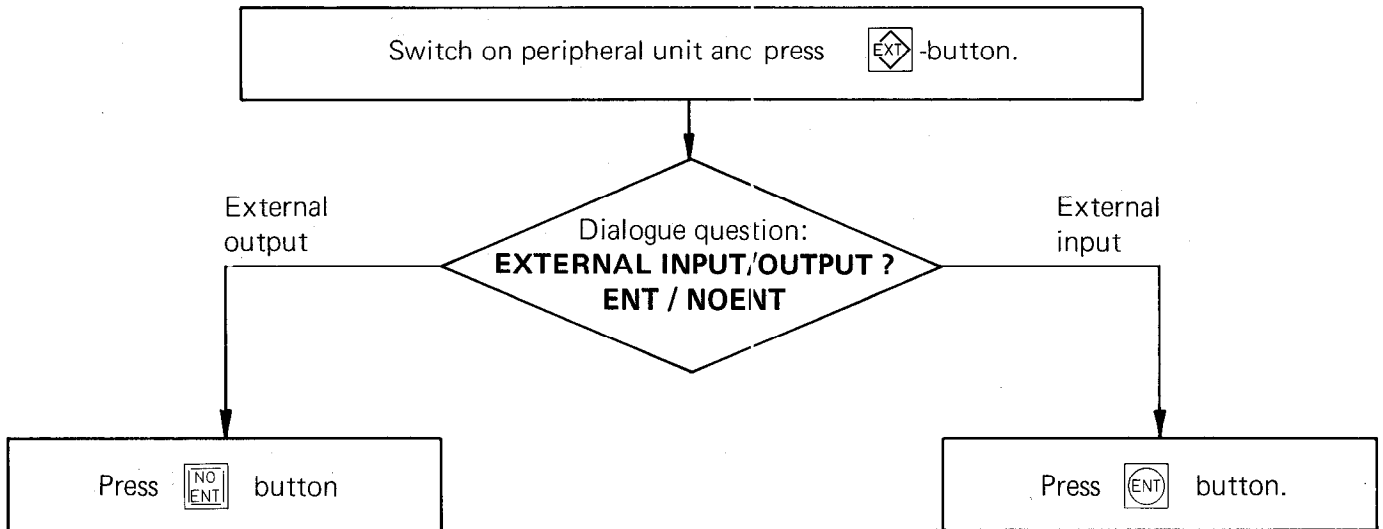

With external data output, the following dialogue questions are posed:

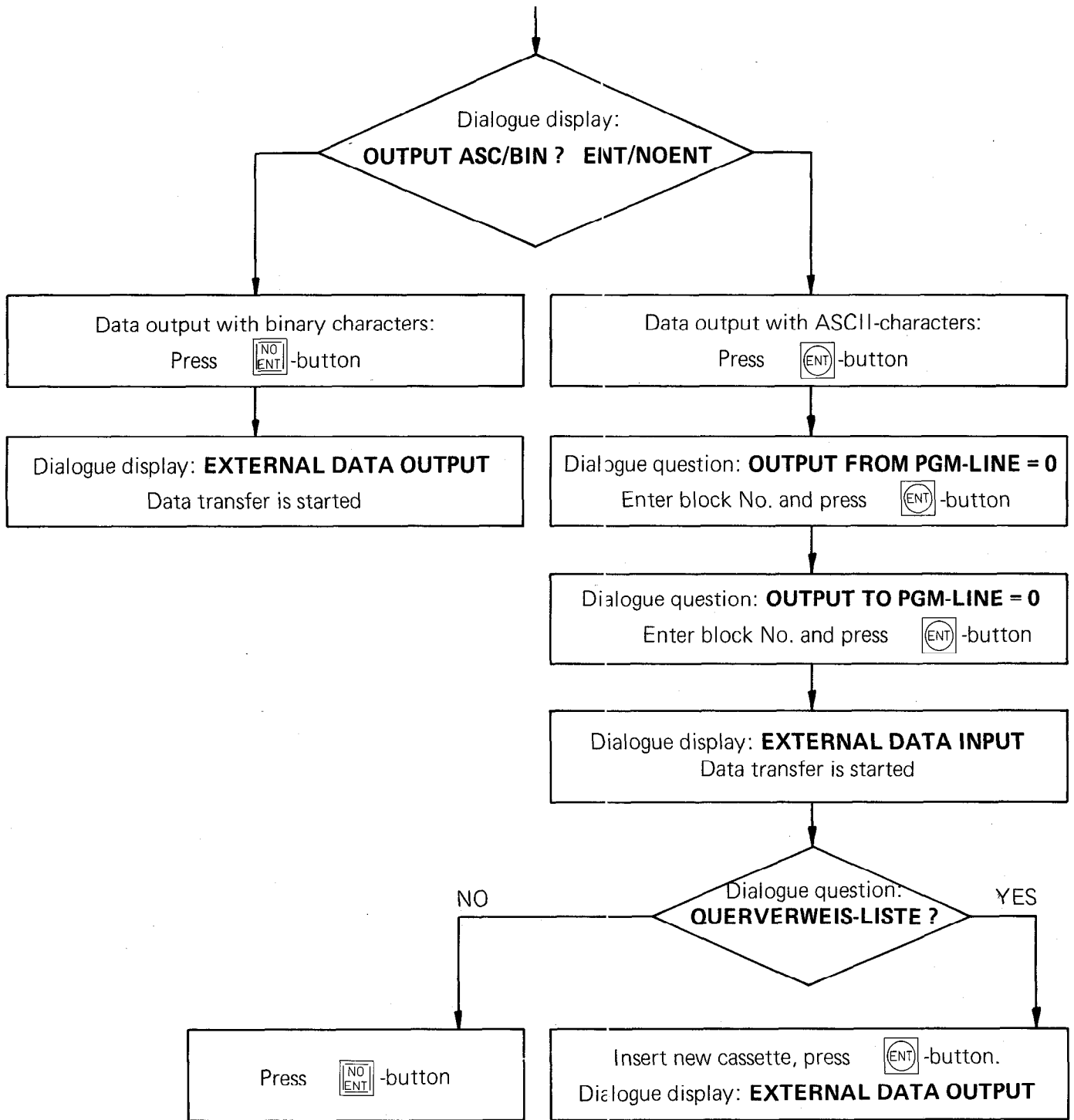

With external data input, the following dialogue questions are posed:

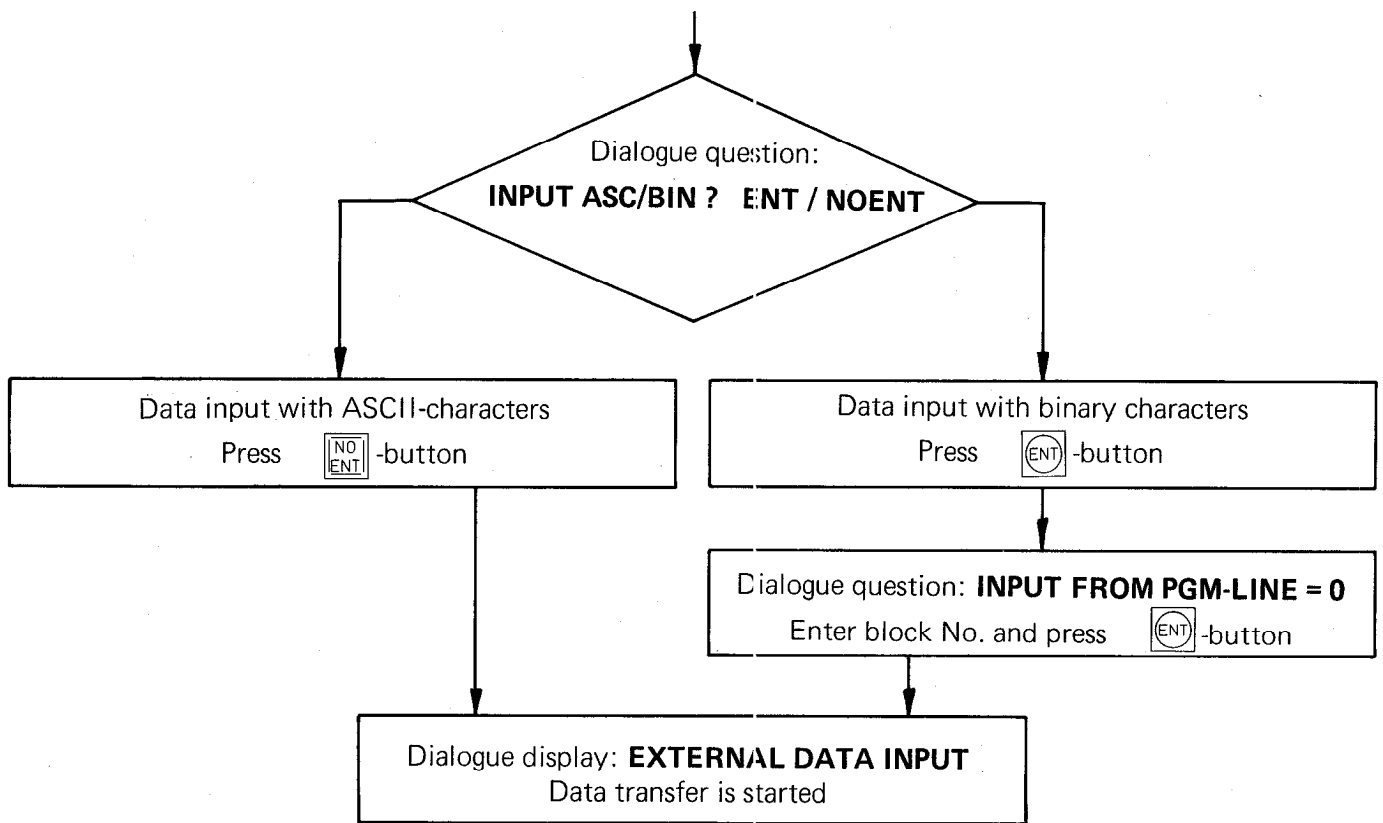

C 6.2) Operating mode "PLC-Programme trace function": -button

Operating mode selection "PLC-Programme trace-function" by the pressing the mode-key .

The following display appears on the VDU:

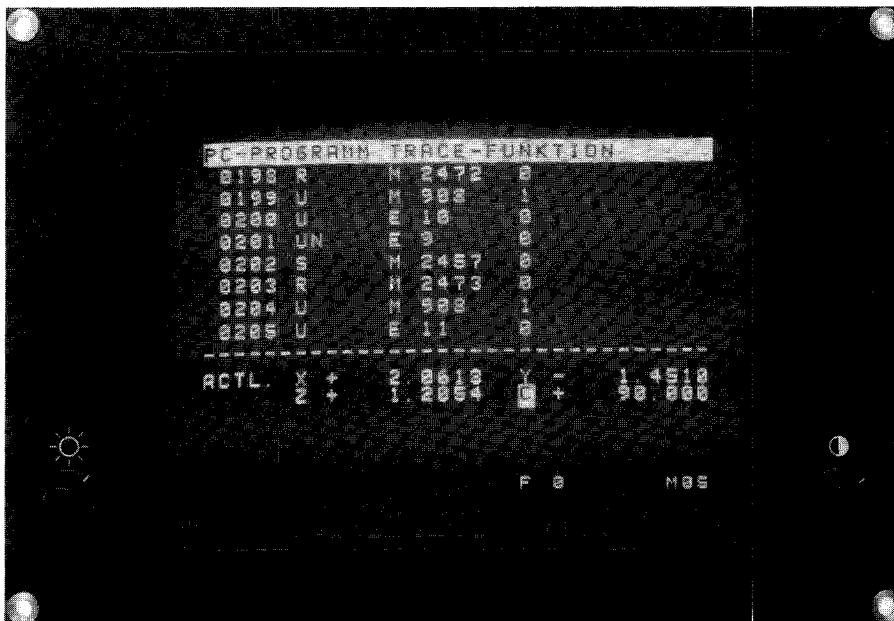

In this mode, the function of the PLC-program can be checked in the RAM-memory. In addition to the PLC-commands, the logic state of the operands and gating results are displayed.

C 6.3) Operating mode "Table E/A/Z/T/M": -button

Select the "Operand display" mode by pressing the -button (see section C 6).

The VDU-display shows the following dialogue:

TABLE E/A/Z/T/M

By pressing the respective operand button, the states of all the

Inputs : -button

Outputs : -button

Counters : -button

Timers : -button

Markers : -button

are displayed on the VDU.

Note:

If a change to some other display mode or operating mode from an operand display mode is required, first press the -button.

The cursor buttons , and , enable a specified operand to be highlighted in inverse video on the VDU-display, in order that the logic state of an operand can be easily observed.

Marker logic state display:

As only 120 markers can be displayed simultaneously, the -button and the entry of a numeric value selects some other marker range.

The VDU-displays the following (e.g. the logic input states):

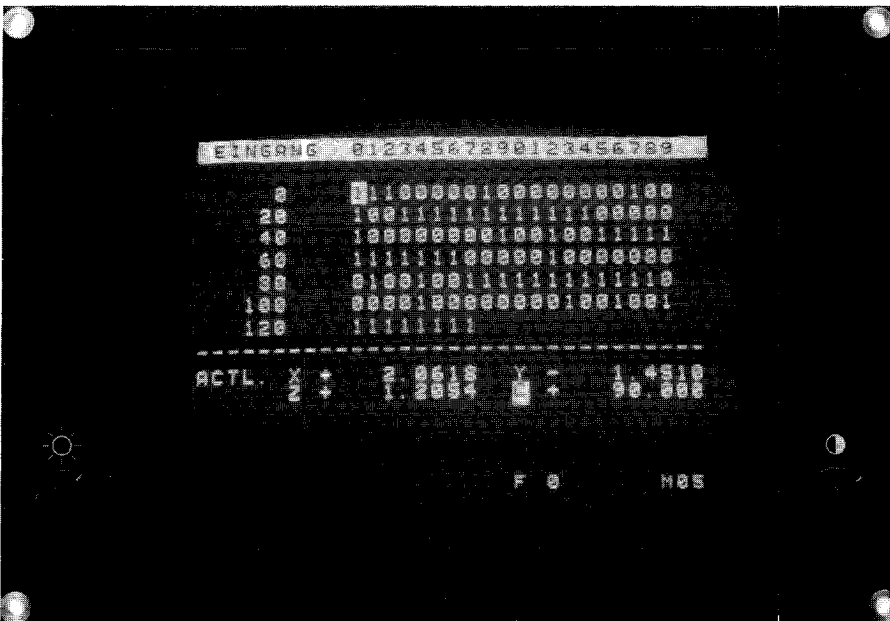

C 7) Off-line PLC-programming

An off-line programming terminal is not currently available from HEIDENHAIN. This section provides information as to the format of the PLC-commands so that off-line programming terminal suppliers can develop a terminal for the HEIDENHAIN-PLC if they so wish.

Note:

With external programming, comments following PLC-commands must be separated from the PLC-command by the character *;.

C 7.1) PLC-command format

Every PLC-command requires a 16 bit word i.e. 2 bytes are defined in the PLC-command memory. An command consists of a 4 bit PLC-operation code and the 12 bit PLC-address. The PLC-operation code defines the binary instruction and the PLC-address calls a memory location for the operands which are to be processed.

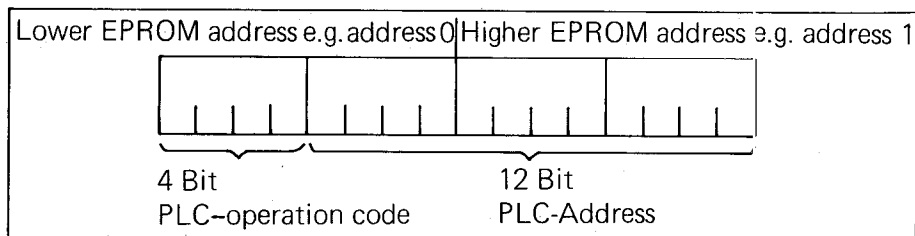

C 7.2) PLC-Operation codes for PLC-Commands

Abbreviation	PLC-Operation code
NOP	0000
U	0001
UN	0010
O	0011
ON	0100
XO	0101
XON	0110
S	0111
SN	1000
R	1001
RN	1010
=	1011
NOP	1111

C 7.3) PLC-Address for PLC-Commands

Abbreviation	PLC-Address (Hexadecimal)
M0 – M3279	000 – CCF
E0 – E127	CD0 – D4F
A0 – A63	E50 – E8F
Z0 – Z15	F10 – F1F
Z48 – Z63	F40 – F4F
Z96 – Z111	F70 – F7F
T0 – T31	FA0 – FBF
T48 – T79	FD0 – FEF

C 7.4) EPROM Address list

The PLC program is stored in an HN2764 EPROM.

Addresses:

PLC-Operand	msb - PLC-Address	EPROM-Address 0
PLC-Address	lsb	EPROM-Address 1
PLC-Operand	msb - PLC-Address	EPROM-Address 2
PLC-Address	lsb	EPROM-Address 3
PLC-Operand	msb - PLC-Address	EPROM-Address 4
PLC-Address	lsb	EPROM-Address 5
PLC-Operand	msb - PLC-Address	EPROM-Address 4094
PLC-Address	lsb	EPROM-Address 4095
Internal PLC-software		
EPROM-Address 8191		

D) Standard TNC 150 B/TNC 150 Q PLC-program description

The **TNC 150 B** control has interfacing for an **external machine interface** (similar to the TNC 145 C). This interface is achieved by a PLC program.

The **TNC 150 Q** control is supplied with an **external PLC-board**. The definition of the inputs the outputs and the specific PLC-program is defined by the machine tool builder.

In order to simplify the first commissioning of the TNC 150 Q, the PLC-program for the TNC 150 B is programmed into the PLC program EPROM.

This program must be exchanged for the specific machine tool builders program.

The following description covers the standard stored PLC program for the TNC 150 B/TNC 150 Q controls.

D 1) Address list

Input address		Output address	
0	REF end position X	0	X axis enable
1	REF end position Y	1	Y axis enable
2	REF end position Z	2	X axis enable
3	REF end position IV	3	IV axis enable
4	REF impulse inhibit X	4	Control in operation
5	REF impulse inhibit Y	5	Control in automatic
6	REF impulse inhibit Z	6	Spindle on control
7	REF impulse inhibit IV	7	M-S-T code Bit 1
8	EMERGENCY Stop feedback	8	M-S-T code Bit 2
9	Direction button X+	9	M-S-T code Bit 3
10	Direction button X-	10	M-S-T code Bit 4
11	Direction button Y+	11	M-S-T code Bit 5
12	Direction button Y-	12	M-S-T code Bit 6
13	Direction button Z+	13	M-S-T code Bit 7
14	Direction button Z-	14	M-S-T code Bit 8
15	Direction button IV+	15	M03, spindle clockwise
16	Direction button IV-	16	M04, spindle counter clockwise
17	Miscellaneous function complete feedback	17	M05 spindle stop
18	Feed enable	18	M08, coolant on
19	Manual pressed	19	M09 coolant off
20	Internal link to output 6	20	G/S Strobe
21	Rapid button	21	M Strobe
22	Start button	22	T Strobe
23	Stop button		

Timers

10	G-M-S-T-output: strobe delay
11	G-M-S-T-output: strobe duration
12	G-M-S-T-output: delay for "auxiliary function complete"
13	Jog spindle CW
14	Jog spindle CCW
15	Delay feed enable (Positioning loop)

Marker List

900	“Programming” mode
901	“Manual” mode
902	“Electronic handwheel” mode
903	“Manual data input” mode
904	“Single block” mode
905	“Automatic” mode
908	“Manual” mode
909	“Control” mode
910	Buffer marker actual position value transfer – X axis
911	Buffer marker actual position value transfer – Y axis
912	Buffer marker actual position value transfer – Z axis
913	Buffer marker actual position value transfer – I/V axis
917	Buffer marker manual pressed
919	Manual pressed
920	Buffer marker – start button
921	Buffer marker – rapid button
922	Buffer marker – M03 output
923	Buffer marker – M04 output
924	Buffer marker – M05 output
925	1st buffer marker G/S change signal
926	1st buffer marker M change signal
927	1st buffer marker T1 change signal
929	Buffer marker – Output 6
930	Buffer marker – M00
932	Buffer marker – M02
933	Buffer marker – M03
934	Buffer marker – M04
935	Buffer marker – M05
936	Buffer marker – M06
938	Buffer marker – M08
939	Buffer marker – M09
943	Buffer marker – M13
944	Buffer marker – M14
945	Buffer marker – M30
948	Buffer marker – M code-decade 0x
949	Buffer marker – M code-decade 1x
950	2nd Buffer marker – G/S change signal
951	2nd Buffer marker – M-change signal
952	2nd Buffer marker – T1 change signal
960	Buffer marker – gear range (0)
961	Buffer marker – gear range (1)
962	Buffer marker – gear range (2)
963	Buffer marker – gear range (3)
964	Buffer marker – gear range (4)
965	Buffer marker – gear range (5)
966	Buffer marker – gear range (6)
967	Buffer marker – gear range (7)
968	Buffer marker – T13 running
969	Buffer marker – T14 running

D 2) Reference listing for markers, inputs/outputs and timers

This list shows which instructions use which markers, inputs/outputs and timers. For PLC-commands marked with * a signal is generated. With the remaining PLC-commands the signal is gated.

Marker Nos. – Used with PLC-command numbers:

M 0	*0000	0152	0153	0425	0426				
M 900	*0004	0025							
M 901	*0008	0026							
M 902	*0012	0027							
M 903	*0016	0029							
M 904	*0020	0030							
M 905	*0024	0031							
M 908	*0028	0061	0186	0194	0199	0204	0209	0214	
		0219	0224	0229					
M 909	*0032	0043	0060						
M 910	*0076	0089	*0093						
M 911	*0080	0094	*0098						
M 912	*0084	0099	*0103						
M 913	*0088	0104	*0108						
M 917	0064	*0067							
M 919	*0065	0068	0073	0077	0081	0085	0090	0095	
		0100	0105	0123	0126	0129	0132		
M 920	0179	*0191							
M 921	0183	*0193							
M 922	0058	*0357	*0364	*0374	*0390	0393			
M 923	0059	*0358	*0365	*0375	*0391	0395			
M 924	*0359	*0366	*0376	*0392	0397				
M 925	0401	*0420							
M 926	0404	*0422							
M 927	0407	*0424							
M 929	0047	0052	*0056						
M 930	*0249	0367	0383						
M 932	*0255	0368	0384						
M 933	*0261	0353							
M 934	*0267	0360							
M 935	*0273	0369	0385						
M 936	*0279	0370							
M 938	*0285	0377							
M 939	*0291	0382							
M 943	*0297	0354	0378						
M 944	*0303	0361	0379						
M 945	*0312	0371	0386						
M 948	*0238	0244	0250	0256	0262	0268	0274	0280	
		0286							
M 949	*0243	0292	0298						
M 950	*0402	0409							
M 951	*0405	0410							
M 952	*0408	0411							
M 960	*0317	0451							
M 961	*0322	0454							
M 962	*0327	0457							
M 963	*0332	0460							
M 964	*0337	0463							
M 965	*0342	0466							
M 966	*0347	0469							
M 967	*0352	0472							
M 968	0560	*0566	*0581						
M 969	0568	*0574	*0584						
M 2000	0033								

Marker Nos. — Used with PLC-command-numbers

M 2001	0035							
M 2002	0037							
M 2003	0039							
M 2008	0074	0112	0124					
M 2009	0078	0115	0127					
M 2010	0082	0118	0130					
M 2011	0086	0121	0133					
M 2032	0523							
M 2033	0526							
M 2034	0529							
M 2035	0532							
M 2036	0535							
M 2037	0538							
M 2038	0541							
M 2039	0544							
M 2043	0313	0318	0323	0328	0333	0338	0343	0348
	0399	0418	0435	0443	0450	0453	0456	0459
	0462	0465	0468	0471	0546	0559	0567	0585
M 2044	0400	0419	0437	0444	0474	0477	0480	0483
	0486	0489	0492	0495	0547	0590		
M 2045	0355	0362	0372	0380	0387	0403	0421	0439
	0445	0498	0501	0504	0507	0510	0513	0516
	0519	0551	0595					
M 2046	0406	0423	0441	0446	0522	0525	0528	0531
	0534	0537	0540	0543	0555	0600		
M 2064	0475							
M 2065	0478							
M 2066	0481							
M 2067	0484							
M 2068	0487							
M 2069	0490							
M 2070	0493							
M 2071	0496							
M 2072	0245	0251	0257	0263	0269	0275	0281	0287
	0293	0299	0304	0499				
M 2073	0246	0252	0258	0264	0270	0276	0282	0288
	0294	0300	0305	0502				
M 2074	0247	0253	0259	0265	0271	0277	0283	0289
	0295	0301	0306	0505				
M 2075	0248	0254	0260	0266	0272	0278	0284	0290
	0296	0302	0307	0508				
M 2076	0234	0239	0308	0511				
M 2077	0235	0240	0309	0514				
M 2078	0236	0241	0310	0517				
M 2079	0237	0242	0311	0520				
M 2104	0314	0319	0324	0329	0334	0339	0344	0349
M 2105	0315	0320	0325	0330	0335	0340	0345	0350
M 2106	0316	0321	0326	0331	0336	0341	0346	0351
M 2176	0001	0005	0009	0013	0017	0021		
M 2177	0002	0006	0010	0014	0018	0022		
M 2178	0003	0007	0011	0015	0019	0023		
M 2184	0041	0057						
M 2185	0045	0050						
M 2191	0389							
M 2448	*0154	*0180						
M 2449	*0155	*0184						
M 2450	*0156	*0188						

Marker Nos. — Used with PLC-command-numbers

M 2451	*0135	*0136	*0142
M 2456	*0157	*0197	
M 2457	*0158	*0202	
M 2458	*0159	*0207	
M 2459	*0160	*0212	
M 2460	*0161	*0217	
M 2461	*0162	*0222	
M 2462	*0163	*0227	
M 2463	*0164	*0232	
M 2464	*0165	*0181	
M 2465	*0166	*0185	
M 2466	*0167	*0189	
M 2467	*0137	*0138	*0143
M 2472	*0168	*0198	
M 2473	*0169	*0203	
M 2474	*0170	*0208	
M 2475	*0171	*0213	
M 2476	*0172	*0218	
M 2477	*0173	*0223	
M 2478	*0174	*0228	
M 2479	*0175	*0233	
M 2480	*0436	*0589	
M 2481	*0438	*0594	
M 2482	*0440	*0599	
M 2483	*0442	*0604	
M 2485	*0394		
M 2486	*0396		
M 2487	*0398		
M 2488	*0177		
M 2490	*0576		
M 2491	*0578		
M 2492	*0069		
M 2493	*0070		
M 2494	*0071		
M 2495	*0072		
M 2544	*0075	0091	0111 *0125
M 2545	*0079	0096	0114 *0128
M 2546	*0083	0101	0117 *0131
M 2547	*0087	0106	0120 *0134
M 2552	*0092		
M 2553	*0097		
M 2554	*0102		
M 2555	*0107		
M 2556	*0145		
M 2557	*0147		
M 2558	*0149		
M 2559	*0151		
M 2815	*0049	*0054	

Input Nos. — Used with PLC-command-numbers

E 0	0144			
E 1	0146			
E 2	0148			
E 3	0150			
E 9	0195	0201		
E 10	0196	0200		
E 11	0205	0211		
E 12	0206	0210		
E 13	0215	0221		
E 14	0216	0220		
E 15	0225	0231		
E 16	0226	0230		
E 17	0588	0593	0598	0603
E 18	0141			
E 19	0063	0066		
E 20	0048	0053		
E 21	0182	0192		
E 22	0178	0187	0190	
E 23	0176			

Output Nos. — Used with PLC-command-numbers

A 0	*0034				
A 1	*0036				
A 2	*0038				
A 3	*0040				
A 4	*0042				
A 5	*0044				
A 6	0046	0051	0055	*0062	
A 7	*0427	*0452	*0476	*0500	*0524
A 8	*0428	*0455	*0479	*0503	*0527
A 9	*0429	*0458	*0482	*0506	*0530
A 10	*0430	*0461	*0485	*0509	*0533
A 11	*0431	*0464	*0488	*0512	*0536
A 12	*0432	*0467	*0491	*0515	*0539
A 13	*0433	*0470	*0494	*0518	*0542
A 14	*0434	*0473	*0497	*0521	*0545
A 15	*0356				
A 16	*0363				
A 17	*0373				
A 18	*0381				
A 19	*0388				
A 20	*0550				
A 21	*0554				
A 22	*0558				

Timer Nos. — Used with PLC-command-numbers

T 10	*0415					
T 11	*0416					
T 12	*0417	0586	0591	0596	0601	
T 13	0561	*0565	0569	0579		
T 14	0562	0570	*0573	0582		
T 15	*0109	*0110	*0113	*0116	*0119	*0122 0139
T 58	0412	*0447	0548	0552	0556	
T 59	0413	*0448	0549	0553	0557	
T 60	0414	*0449	0587	0592	0597	0602
T 61	0563	0571	0575	0580		
T 62	0564	0572	0577	0583		
T 63	0140					

D 3) Standard PLC-program for the TNC 150 B / TNC 150 Q

Note:

The note "terminal J ../.." refers to the TNC 150 B terminal numbers (see section D 4).

0000 =	M 0	Chooses a logic chain where it is incomplete at the end of the program
Mode decoding		
0001 UN	M 2176	Mode-code 2 ⁰
0002 UN	M 2177	Mode-code 2 ¹
0003 UN	M 2178	Mode-code 2 ²
0004 =	M 900	"Store program" mode
0005 U	M 2176	Mode-code 2 ⁰
0006 UN	M 2177	Mode-code 2 ¹
0007 UN	M 2178	Mode-code 2 ²
0008 =	M 901	"Manual" mode
0009 UN	M 2176	Mode-code 2 ⁰
0010 U	M 2177	Mode-code 2 ¹
0011 UN	M 2178	Mode-code 2 ²
0012 =	M 902	"Electronic handwheel" mode
0013 U	M 2176	Mode-code 2 ⁰
0014 U	M 2177	Mode-code 2 ¹
0015 UN	M 2178	Mode-code 2 ²
0016 =	M 903	"Manual data input" mode
0017 UN	M 2176	Mode-code 2 ⁰
0018 UN	M 2177	Mode-code 2 ¹
0019 U	M 2178	Mode-code 2 ²
0020 =	M 904	"Single block" mode
0021 U	M 2176	Mode-code 2 ⁰
0022 UN	M 2177	Mode-code 2 ¹
0023 U	M 2178	Mode-code 2 ²
0024 =	M 905	"Automatic" mode
0025 O	M 900	"Store program" mode
0026 O	M 901	"Manual" mode
0027 O	M 902	"Electronic handwheel" mode
0028 =	M 908	Manual modes
0029 O	M 903	"Manual data input" mode
0030 O	M 904	"Single block" mode
0031 O	M 905	"Automatic" mode
0032 =	M 909	Control in "automatic" mode
Axis enables		
0033 U	M 2000	Enable X-axis
0034 =	A 0	Terminal J1/1
0035 U	M 2001	Enable Y-axis
0036 =	A 1	Terminal J1/2
0037 U	M 2002	Enable Z-axis
0038 =	A 2	Terminal J1/3
0039 U	M 2003	Enable IV-axis
0040 =	A 3	Terminal J1/4

0041 U	M 2184	Control in operation
0042 =	A 4	Terminal J1/5
0043 U	M 909	Control in automatic mode
0044 =	A 5	Terminal J1/6
		Checking for spindle on
0045 U	M 2185	1st. PLC-cycle following PLC cycle interruption
0046 U	A 6	Check for "spindle on": Terminal J1/7
0047 U	M 929	Buffer marker A6 – delayed during 1st PLC cycle (contact opened)
0048 UN	E 20	Spindle checking feedback terminal J5/4
0049 S	M 2815	Flashing alarm from PLC
0050 U	M 2185	1st PLC-cycle following PLC cycle interruption
0051 UN	A 6	Check for "spindle on" terminal J1/7
0052 UN	M 929	Buffer marker A6 – delayed during 1st PLC-cycle (contact opened)
0053 U	E 20	Spindle checking feedback: Terminal J5/4
0054 S	M 2815	Flashing alarm from PLC
0055 U	A 6	Check for "spindle on": Terminal J1/7
0056 =	M 929	Buffer marker A6 – delayed during 1st PLC-cycle (contact opened)
		Checking for "Spindle on"
0057 O	M 2184	Control in operation
0058 O	M 922	Buffer marker M03
0059 O	M 923	Buffer marker M04
0060 U	M 909	Control in "automatic" mode
0061 O	M 908	Manual mode
0062 =	A 6	Check for "spindle on": Terminal J1/7
		Manual pressed – Disable servo-loops
		Following manual presse, transfer position value
0063 U	E 19	Input manual pressed: Terminal J5/5
0064 U	M 917	Buffer marker – E19 delayed during 1st PLC cycle (contact opened)
0065 =	M 919	Manual pressed
0066 U	E 19	Input Manual pressed
0067 =	M 917	Buffer marker – E19 delayed during 1st PLC-cycle (contact opened)
		Pre-select servo-enable
0068 U	M 919	Manual pressed
0069 =	M 2492	Initial marker: X-servo-loop enabled
0070 =	M 2493	Initial marker: Y-servo-loop enabled
0071 =	M 2494	Initial marker: Z-servo-loop enabled
0072 =	M 2495	Initial marker: IV-servo-loop enabled

Switch "Manual pressed" disables servo-loop if axes are in position

0073 U	M 919	Manual pressed
0074 U	M 2008	X-axis in position
0075 S	M 2544	Disable X-axis servo-loop
0076 S	M 910	Buffer marker X-axis actual position value transfer
0077 U	M 919	Manual pressed
0078 U	M 2009	Y-axis in position
0079 S	M 2545	Disable Y-axis servo-loop
0080 S	M 911	Buffer marker Y-axis actual position value transfer
0081 U	M 919	Manual pressed
0082 U	M 2010	Z-axis in position
0083 S	M 2546	Disable Z-axis servo-loop
0084 S	M 912	Buffer marker Z-axis actual position value transfer
0085 U	M 919	Manual pressed
0086 U	M 2011	IV-axis in position
0087 S	M 2547	Disable IV-axis servo-loop
0088 S	M 913	Buffer marker IV-axis
Position value transfer		
0089 U	M 910	Buffer marker X-axis actual position value transfer
0090 UN	M 919	Manual pressed
0091 U	M 2544	Disable X-axis servo-loop
0092 =	M 2552	Transfer X-axis position value
0093 R	M 910	Buffer marker X-axis actual position value transfer
0094 U	M 911	Buffer marker Y-axis actual position value transfer
0095 UN	M 919	Manual pressed
0096 U	M 2545	Disable Y-axis servo-loop
0097 =	M 2553	Transfer Y-axis position value
0098 R	M 911	Buffer marker Y-axis actual position value transfer
0099 U	M 912	Buffer marker Z-axis actual position value transfer
0100 UN	M 919	Manual pressed
0101 U	M 2546	Disable Z-axis servo-loop
0102 =	M 2554	Transfer Z-axis position value
0103 R	M 912	Buffer marker Z-axis actual position value transfer
0104 U	M 913	Buffer marker IV-axis
0105 UN	M 919	Manual pressed
0106 U	M 2547	Disable IV-axis servo-loop
0107 =	M 2555	Transfer IV-axis actual position value
0108 R	M 913	Buffer marker IV-axis

Time for Delaying Feed Enable Start

0109	R	T 15	Delay feed enable
0110	RN	T 15	
0111	U	M 2544	Disable X-axis servo-loop
0112	UN	M 2008	X-axis in position
0113	S	T 15	Delay feed enable
0114	U	M 2545	Disable Y-axis servo-loop
0115	UN	M 2009	Y-axis in position
0116	S	T 15	Delay feed enable
0117	U	M 2546	Disable Z-axis servo-loop
0118	UN	M 2010	Z-axis in position
0119	S	T 15	Delay feed enable
0120	U	M 2547	Disable IV-axis servo-loop
0121	UN	M 2011	IV-axis in position
0122	S	T 15	Delay feed enable
			Enable Servo-loop if axis is not in position or manual not activated
0123	ON	M 919	Manual pressed
0124	ON	M 2008	X-axis in position
0125	R	M 2544	Enable X-axis servo-loop (servo-loop X-axis inhibiting not permitted)
0126	ON	M 919	Manual pressed
0127	ON	M 2009	Y-axis in position
0128	R	M 2545	Enable Y-axis servo-loop (servo-loop Y-axis inhibiting not permitted)
0129	ON	M 919	Manual pressed
0130	ON	M 2010	Z-axis in position
0131	R	M 2546	Enable Z-axis servo-loop (servo-loop Z-axis inhibiting not permitted)
0132	ON	M 919	Manual pressed
0133	ON	M 2011	IV-axis in position
0134	R	M 2547	Enable IV-axis servo loop (servo-loop IV-axis inhibiting not permitted)
			Feed enable
0135	R	M 2451	Feed enable TNC
0136	RN	M 2451	
0137	S	M 2467	Complement TNC-feed enable
0138	SN	M 2467	
0139	UN	T 15	Delayed feed enable
0140	UN	T 63	Timer T15 running
0141	U	E 18	Feed enable
0142	S	M 2451	TNC feed enable
0143	R	M 2467	Complement feed enable
			Reference Point Switch
0144	U	E 0	Terminal J5/9
0145	=	M 2556	X-axis REF end position
0146	U	E 1	Terminal J5/10
0147	=	M 2557	Y-axis REF end position
0148	U	E 2	Terminal J5/11
0149	=	M 2558	Z-axis REF end position
0150	U	E 3	Terminal J5/12
0151	=	M 2559	IV-axis REF end position

Start conditions for setting button markers

0152	O	M 0	
0153	ON	M 0	
0154	R	M 2448	NC-Start
0155	R	M 2449	Rapid
0156	R	M 2450	Memory function for normal traverse
0157	R	M 2456	Manual traverse X+
0158	R	M 2457	Manual traverse X-
0159	R	M 2458	Manual traverse Y+
0160	R	M 2459	Manual traverse Y-
0161	R	M 2460	Manual traverse Z+
0162	R	M 2461	Manual traverse Z-
0163	R	M 2462	Manual traverse IV+
0164	R	M 2463	Manual traverse IV-
0165	S	M 2464	Complement of start
0166	S	M 2465	Complement of rapid
0167	S	M 2466	Complement memory function for manual traverse
0168	S	M 2472	Complement of manual traverse X+
0169	S	M 2473	Complement of manual traverse X-
0170	S	M 2474	Complement of manual traverse Y+
0171	S	M 2475	Complement of manual traverse Y-
0172	S	M 2476	Complement of manual traverse Z+
0173	S	M 2477	Complement of manual traverse Z-
0174	S	M 2478	Complement of manual traverse IV+
0175	S	M 2479	Complement of manual traverse IV--
Stop-, Start-, Latch buttons, Memory function for manual traversing			
0176	U	E 23	NC-Stop button: Terminal J5/1
0177	=	M 2488	NC-Stop
0178	U	E 22	NC-Start-button: Terminal J5/2
0179	U	M 920	Buffered marker, start button delayed during 1st PLC cycle (contact is opened)
0180	S	M 2448	NC-Start
0181	R	M 2464	Complemented NC-Start
0182	U	E 21	Rapid button: Terminal J5/3
0183	U	M 921	Buffer marker: rapid button delayed during 1st PLC cycle (contact is opened)
0184	S	M 2449	Rapid
0185	R	M 2465	Complement of rapid
0186	U	M 908	Manual mode
0187	U	E 22	NC-Start button
0188	S	M 2450	Memory function for manual traverse
0189	R	M 2466	Complemented memory function for manual traverse
0190	U	E 22	NC-Start-button: Terminal J5/2
0191	=	M 920	Buffer marker: NC-Start button
0192	U	E 21	Rapid button: Terminal J5/3
0193	=	M 921	Buffer marker: rapid button

Direction buttons

0194	U	M 908	Manual mode
0195	U	E 9	X+ direction button: Terminal J6/5
0196	UN	E 10	X- direction button: Terminal J6/6
0197	S	M 2456	X+ direction button
0198	R	M 2472	X+ direction button complemented
0199	U	M 908	Manual mode
0200	U	E 10	X- direction button: Terminal J6/6
0201	UN	E 9	X+ direction button: Terminal J6/5
0202	S	M 2457	X- direction button
0203	R	M 2473	X- direction button complemented
0204	U	M 908	Manual mode
0205	U	E 11	Y+ direction button: Terminal J6/7
0206	UN	E 12	Y- direction button: Terminal J6/8
0207	S	M 2458	Y+ direction button
0208	R	M 2474	Y+ direction button complemented
0209	U	M 908	Manual mode
0210	U	E 12	Y- direction button: Terminal J6/8
0211	UN	E 11	Y+ direction button: Terminal J6/7
0212	S	M 2459	Y- direction button
0213	R	M 2475	Y- direction button complemented
0214	U	M 908	Manual mode
0215	U	E 13	Z+ direction button: Terminal J6/9
0216	UN	E 14	Z- direction button: Terminal J6/10
0217	S	M 2460	Z+ direction button
0218	R	M 2476	Z+ direction button complemented
0219	U	M 908	Manual mode
0220	U	E 14	Z- direction button: Terminal J6/10
0221	UN	E 13	Z+ direction button: Terminal J6/9
0222	S	M 2461	Z- direction button
0223	R	M 2477	Z- direction button complemented
0224	U	M 908	Manual mode
0225	U	E 15	IV+ direction button: Terminal J6/11
0226	UN	E 16	IV- direction button: Terminal J6/12
0227	S	M 2462	IV+ direction button
0228	R	M 2478	IV+ direction button complemented
0229	U	M 908	Manual mode
0230	U	E 16	IV- direction button: Terminal J6/12
0231	UN	E 15	IV+ direction button: Terminal J6/11
0232	S	M 2463	IV- direction button
0233	R	M 2479	IV- direction button complemented

Buffer markers for setting M-codes

0234 UN M 2076 5th Bit M-code
0235 UN M 2077 6th Bit M-code
0236 UN M 2078 7th Bit M-code
0237 UN M 2079 8th Bit M-code
0238 = M 948 Buffer marker M-code decimal decade 0 x

0239 U M 2076 5th Bit M-code
0240 UN M 2077 6th Bit M-code
0241 UN M 2078 7th Bit M-code
0242 UN M 2079 8th Bit M-code
0243 = M 949 Buffer marker M-code decimal decade 1 x

0244 U M 948 Buffer marker M-code decimal decade 0 x
0245 UN M 2072 1st Bit M-code
0246 UN M 2073 2nd Bit M-code
0247 UN M 2074 3rd Bit M-code
0248 UN M 2075 4th Bit M-code
0249 = M 930 Buffered marker M00

0250 U M 948 Buffer marker M-code decimal decade 0 x
0251 UN M 2072 1st Bit M-code
0252 U M 2073 2nd Bit M-code
0253 UN M 2074 3rd Bit M-code
0254 UN M 2075 4th Bit M-code
0255 = M 932 Buffered marker M02

0256 U M 948 Buffer marker M-code decimal decade 0 x
0257 U M 2072 1st Bit M-code
0258 U M 2073 2nd Bit M-code
0259 UN M 2074 3rd Bit M-code
0260 UN M 2075 4th Bit M-code
0261 = M 933 Buffered marker M03

0262 U M 948 Buffer marker M-code decimal decade 0 x
0263 UN M 2072 1st Bit M-code
0264 UN M 2073 2nd Bit M-code
0265 U M 2074 3rd Bit M-code
0266 UN M 2075 4th Bit M-code
0267 = M 934 Buffered marker M04

0268 U M 948 Buffer marker M-code decimal decade 0 x
0269 U M 2072 1st Bit M-code
0270 UN M 2073 2nd Bit M-code
0271 U M 2074 3rd Bit M-code
0272 UN M 2075 4th Bit M-code
0273 = M 935 Buffered marker M05

0274 U M 948 Buffer marker M-code decimal decade 0 x
0275 UN M 2072 1st Bit M-code
0276 U M 2073 2nd Bit M-code
0277 U M 2074 3rd Bit M-code
0278 UN M 2075 4th Bit M-code
0279 = M 936 Buffered marker M06

0280 U M 948 Buffer marker M-code decimal decade 0 x
0281 UN M 2072 1st Bit M-code
0282 UN M 2073 2nd Bit M-code
0283 UN M 2074 3rd Bit M-code
0284 U M 2075 4th Bit M-code
0285 = M 938 Buffered marker M08

0286 U M 948 Buffer marker M-code decimal decade 0 x
0287 U M 2072 1st Bit M-code
0288 UN M 2073 2nd Bit M-code
0289 UN M 2074 3rd Bit M-code
0290 U M 2075 4th Bit M-code
0291 = M 939 Buffered marker M09

0292 U M 949 Buffer marker M-code decimal decade 1 x
0293 U M 2072 1st Bit M-code
0294 U M 2073 2nd Bit M-code
0295 UN M 2074 3rd Bit M-code
0296 UN M 2075 4th Bit M-code
0297 = M 943 Buffered marker M13

0298 U M 949 Buffer marker M-code decimal decade 1 x
0299 UN M 2072 1st Bit M-code
0300 UN M 2073 2nd Bit M-code
0301 U M 2074 3rd Bit M-code
0302 UN M 2075 4th Bit M-code
0303 = M 944 Buffered marker M14

0304 UN M 2072 1st Bit M-code
0305 UN M 2073 2nd Bit M-code
0306 UN M 2074 3rd Bit M-code
0307 UN M 2075 4th Bit M-code
0308 U M 2076 5th Bit M-code
0309 U M 2077 6th Bit M-code
0310 UN M 2078 7th Bit M-code
0311 UN M 2079 8th Bit M-code
0312 = M 945 Buffered marker M30

Buffered markers for setting gear range codes

0313 U M 2043 Change gear signal
0314 UN M 2104 1st Bit, gear range code (lsb)
0315 UN M 2105 2nd Bit, gear range code
0316 UN M 2106 3rd Bit, gear range code (msb)
0317 = M 960 Gear range (0)

0318 U M 2043 Change gear signal
0319 U M 2104 1st Bit, gear range code (lsb)
0320 UN M 2105 2nd Bit, gear range code
0321 UN M 2106 3rd Bit, gear range code (msb)
0322 = M 961 Gear range (1)

0323 U M 2043 Change gear signal
0324 UN M 2104 1st Bit, gear range code (lsb)
0325 U M 2105 2nd Bit, gear range code
0326 UN M 2106 3rd Bit, gear range code (msb)
0327 = M 962 Gear range (2)

0328 U M 2043 Change gear signal
0329 U M 2104 1st Bit, gear range code (lsb)
0330 U M 2105 2nd Bit, gear range code
0331 UN M 2106 3rd Bit, gear range code (msb)
0332 = M 963 Gear range (3)

0333 U M 2043 Change gear signal
0334 UN M 2104 1st Bit, gear range code (lsb)
0335 UN M 2105 2nd Bit, gear range code
0336 U M 2106 3rd Bit, gear range code (msb)
0337 = M 964 Gear range (4)

0338	U	M 2043	Change gear signal
0339	U	M 2104	1st Bit, gear range code (lsb)
0340	UN	M 2105	2nd Bit, gear range code
0341	U	M 2106	3rd Bit, gear range code (msb)
0342	=	M 965	Gear range (5)
0343	U	M 2043	Change gear signal
0344	UN	M 2104	1st Bit, gear range code (lsb)
0345	U	M 2105	2nd Bit, gear range code
0346	U	M 2106	3rd Bit, gear range code (msb)
0347	=	M 966	Gear range (6)
0348	U	M 2043	Change gear signal
0349	U	M 2104	1st Bit, gear range code (lsb)
0350	U	M 2105	2nd Bit, gear range code
0351	U	M 2106	3rd Bit, gear range code (msb)
0352	=	M 967	Gear range (7)
Decoded M Output			
0353	O	M 933	Buffered marker M03
0354	O	M 943	Buffered marker M13
0355	U	M 2045	Change M
0356	=	A 15	M03 output/spindle CW: Terminal J2/10
0357	S	M 922	Buffered marker output M03
0358	R	M 923	Buffered marker output M04
0359	R	M 924	Buffered marker output M05
0360	O	M 934	Buffered marker M04
0361	O	M 944	Buffered marker M14
0362	U	M 2045	Change signal M
0363	=	A 16	M04 output/spindle CCW: Terminal J2/11
0364	R	M 922	Buffered marker output M03
0365	S	M 923	Buffered marker output M04
0366	R	M 924	Buffered marker output M05
0367	O	M 930	Buffered marker M00
0368	O	M 932	Buffered marker M02
0369	O	M 935	Buffered marker M05
0370	O	M 936	Buffered marker M06
0371	O	M 945	Buffered marker M30
0372	U	M 2045	Change signal M
0373	=	A 17	M05 output/spindle stop: Terminal J2/12
0374	R	M 922	Buffered marker output M03
0375	R	M 923	Buffered marker output M04
0376	S	M 924	Buffered marker output M05
0377	O	M 938	Buffered marker M08
0378	O	M 943	Buffered marker M13
0379	O	M 944	Buffered marker M14
0380	U	M 2045	Change signal M
0381	=	A 18	M08 output/coolant ON: Terminal J3/1
0382	O	M 939	Buffered marker M09
0383	O	M 930	Buffered marker M00
0384	O	M 932	Buffered marker M02
0385	O	M 935	Buffered marker M05
0386	O	M 945	Buffered marker M30
0387	U	M 2045	Change signal M
0388	=	A 19	M09 output/coolant OFF: Terminal J3/2

Emergency stop condition for spindle on/off

0389 U M 2191 Error message external emergency stop is displayed
0390 R M 922 Buffered marker output M03
0391 R M 923 Buffered marker output M04
0392 S M 924 Buffered marker output M05

Spindle status feedback to TNC

0393 U M 922 Buffered marker M03
0394 = M 2485 Status display M03

0395 U M 923 Buffered marker M04
0396 = M 2486 Status display M04

0397 U M 924 Buffered marker M05
0398 = M 2487 Status display M05

Setting timers for G-M-S-T1-output on leading edge

0399 O M 2043 G-change signal
0400 O M 2044 S-change signal
0401 UN M 925 1st buffered G/S change signal
0402 = M 950 2nd buffered G/S change signal

0403 U M 2045 M-change signal
0404 UN M 926 1st buffered M change signal
0405 = M 951 2nd buffered M change signal

0406 U M 2046 T1-change signal
0407 UN M 927 1st buffered T1-change signal
0408 = M 952 2nd buffered T1-change signal

0409 O M 950 2nd buffered G/S-change signal
0410 O M 951 2nd buffered M change signal
0411 O M 952 2nd buffered T1-change signal
0412 UN T 58 Timer 10 running
0413 UN T 59 Timer 11 running
0414 UN T 60 Timer 12 running
0415 = T 10 Start T10 (G-M-S-T delayed coded strobe output)
0416 = T 11 Start T11 (G-M-S-T output permanent strobe)
0417 = T 12 Start T12 (G-M-S-T delayed feedback output)

Setting buffered markers

0418 O M 2043 Change signal G
0419 O M 2044 Change signal S
0420 = M 925 1st buffered G/S-change signal

0421 U M 2045 Change signal M
0422 = M 926 1st buffered M-change signal

0423 U M 2046 Change signal T1
0424 = M 927 1st buffered T1-change signal

Resetting M-S-T-outputs

0425 O M 0
0426 ON M 0
0427 R A 7 Reset M-S-T-output Bit 1
0428 R A 8 Reset M-S-T-output Bit 2
0429 R A 9 Reset M-S-T-output Bit 3
0430 R A 10 Reset M-S-T-output Bit 4
0431 R A 11 Reset M-S-T-output Bit 5
0432 R A 12 Reset M-S-T-output Bit 6
0433 R A 13 Reset M-S-T-output Bit 7
0434 R A 14 Reset M-S-T-output Bit 8

Resetting the G-M-S-T completed" feedback signals

0435	U	M 2043	G-code change signal
0436	RN	M 2480	G-code feedback
0437	U	M 2044	S-code change signal
0438	RN	M 2481	S-code feedback
0439	U	M 2045	M-code change signal
0440	RN	M 2482	M-code feedback
0441	U	M 2046	T1-code change signal
0442	RN	M 2483	T1-code feedback
Timer for G-M-S-T-output reset			
0443	UN	M 2043	G-code change signal for S-analogue
0444	UN	M 2044	S-code change signal
0445	UN	M 2045	M-code change signal
0446	UN	M 2046	T-code change signal
0447	R	T 58	Timer 10 runs: Delay of strobe
0448	R	T 59	Timer 11 runs: Strobe duration
0449	R	T 60	Timer 12 runs: Delay of feedback signal "auxiliary function completed"
Gear range code output			
0450	U	M 2043	Gear change signal
0451	U	M 960	Gear range code (0)
0452	S	A 7	Gear range code Bit 1: Terminal J2/2
0453	U	M 2043	Gear change signal
0454	U	M 961	Gear change code (1)
0455	S	A 8	Gear range code Bit 2: Terminal J2/3
0456	U	M 2043	Gear change signal
0457	U	M 962	Gear range code (2)
0458	S	A 9	Gear range code Bit 3: Terminal J2/4
0459	U	M 2043	Gear change signal
0460	U	M 963	Gear range code (3)
0461	S	A 10	Gear range code Bit 4: Terminal J2/5
0462	U	M 2043	Gear change signal
0463	U	M 964	Gear range code (4)
0464	S	A 11	Gear range code Bit 5: Terminal J2/6
0465	U	M 2043	Gear change signal
0466	U	M 965	Gear range code (5)
0467	S	A 12	Gear range code Bit 6: Terminal J2/7
0468	U	M 2043	Gear change signal
0469	U	M 966	Gear range code (6)
0470	S	A 13	Gear range code Bit 7: Terminal J2/8
0471	U	M 2043	Gear change signal
0472	U	M 967	Gear range code (7)
0473	S	A 14	Gear range code Bit 8: Terminal J2/9
S-outputs			
0474	U	M 2044	Change S-signal
0475	U	M 2064	S-code Bit 1
0476	S	A 7	S-code Bit 1: Terminal J2/2
0477	U	M 2044	Change S-signal
0478	U	M 2065	S-code Bit 2
0479	S	A 8	S-code Bit 2: Terminal J2/3

0480	U	M 2044	Change S-signal
0481	U	M 2066	S-code Bit 3
0482	S	A 9	S-code Bit 3: Terminal J2/4
0483	U	M 2044	Change S-signal
0484	U	M 2067	S-code Bit 4
0485	S	A 10	S-code Bit 4: Terminal J2/5
0486	U	M 2044	Change S-signal
0487	U	M 2068	S-code Bit 5
0488	S	A 11	S-code Bit 5: Terminal J2/6
0489	U	M 2044	Change S-signal
0490	U	M 2069	S-code Bit 6
0491	S	A 12	S-code Bit 6: Terminal J2/7
0492	U	M 2044	Change S-signal
0493	U	M 2070	S-code Bit 7
0494	S	A 13	S-code Bit 7: Terminal J2/8
0495	U	M 2044	Change S-signal
0496	U	M 2071	S-code Bit 8
0497	S	A 14	S-code Bit 8: Terminal J2/9
			M-Code outputs
0498	U	M 2045	Change M-signal
0499	U	M 2072	M-code Bit 1
0500	S	A 7	M-code Bit 1: Terminal J2/2
0501	U	M 2045	Change M-signal
0502	U	M 2073	M-code Bit 2
0503	S	A 8	M-code Bit 2: Terminal J2/3
0504	U	M 2045	Change M-signal
0505	U	M 2074	M-code Bit 3
0506	S	A 9	M-code Bit 3: Terminal J2/4
0507	U	M 2045	Change M-signal
0508	U	M 2075	M-code Bit 4
0509	S	A 10	M-code Bit 4: Terminal J2/5
0510	U	M 2045	Change M-signal
0511	U	M 2076	M-code Bit 5
0512	S	A 11	M-code Bit 5: Terminal J2/6
0513	U	M 2045	Change M-signal
0514	U	M 2077	M-code Bit 6
0515	S	A 12	M-code Bit 6: Terminal J2/7
0516	U	M 2045	Change M-signal
0517	U	M 2078	M-code Bit 7
0518	S	A 13	M-code Bit 7: Terminal J2/8
0519	U	M 2045	Change M-signal
0520	U	M 2079	M-code Bit 8
0521	S	A 14	M-code Bit 8: Terminal J2/9

T-Code outputs

0522 U	M 2046	Change T1-signal
0523 U	M 2032	T-code Bit 1
0524 S	A 7	T-code Bit 1: Terminal J2/2
0525 U	M 2046	Change T1-signal
0526 U	M 2033	T-code Bit 2
0527 S	A 8	T-code Bit 2: Terminal J2/3
0528 U	M 2046	Change T1-signal
0529 U	M 2034	T-code Bit 3
0530 S	A 9	T-code Bit 3: Terminal J2/4
0531 U	M 2046	Change T1-signal
0532 U	M 2035	T-code Bit 4
0533 S	A 10	T-code Bit 4: Terminal J2/5
0534 U	M 2046	Change T1-signal
0535 U	M 2036	T-code Bit 5
0536 S	A 11	T-code Bit 5: Terminal J2/6
0537 U	M 2046	Change T1-signal
0538 U	M 2037	T-code Bit 6
0539 S	A 12	T-code Bit 6: Terminal J2/7
0540 U	M 2046	Change T1-signal
0541 U	M 2038	T-code Bit 7
0542 S	A 13	T-code Bit 7: Terminal J2/8
0543 U	M 2046	Change T1-signal
0544 U	M 2039	T-code Bit 8
0545 S	A 14	T-code Bit 8: Terminal J2/9
Gear M-S-T1-Strobe		
0546 O	M 2043	Change gear range signal
0547 O	M 2044	Change S-signal
0548 UN	T 58	Timer 10 running (G-M-S-T delayed coded strobe output)
0549 U	T 59	Timer 11 running (G-M-S-T output permanent strobe)
0550 =	A 20	Gear range strobe/S-strobe: Terminal J3/3
0551 U	M 2045	Change M-signal
0552 UN	T 58	Timer 10 running (G-M-S-T delayed coded strobe output)
0553 U	T 59	Timer 11 running (G-M-S-T output permanent strobe)
0554 =	A 21	M-strobe: Terminal J3/4
0555 U	M 2046	Change T1-signal
0556 UN	T 58	Timer 10 running (G-M-S-T delayed coded strobe output)
0557 U	T 59	Timer 11 running (G-M-S-T output permanent strobe)
0558 =	A 22	T1-strobe: Terminal J3/5

Spindle jog when gear changing

0559 U M 2043 Change gear signal
0560 UN M 968 Buffer marker T13 running
0561 UN T 13 Jog duration, spindle cw
0562 UN T 14 Jog duration, spindle ccw
0563 UN T 61 Timer 13 running (jog duration, spindle cw)
0564 UN T 62 Timer 14 running (jog duration, spindle ccw)
0565 = T 13 Start timer 13 (jog duration, spindle cw)
0566 S M 968 Buffer marker T13 running

0567 U M 2043 Change gear signal
0568 UN M 969 Buffer marker T14 running
0569 UN T 13 Jog duration, spindle cw
0570 UN T 14 Jog duration, spindle ccw
0571 UN T 61 Timer 13 running (jog spindle cw)
0572 UN T 62 Timer 14 running (jog spindle ccw)
0573 = T 14 Timer 14 start (jog spindle ccw)
0574 S M 969 Buffer marker T14 running

0575 U T 61 Timer 13 running (jog spindle cw)
0576 = M 2490 Jog cw (to start spindle)

0577 U T 62 Timer 14 running (jog spindle ccw)
0578 = M 2491 Jog ccw (to start spindle)

Resetting buffer markers

0579 UN T 13 Jog duration spindle cw
0580 UN T 61 Timer 13 running
0581 R M 968 Buffer marker T13 running

0582 UN T 14 Jog duration spindle ccw
0583 UN T 62 Timer 14 running
0584 R M 969 Buffer marker T14 running

M-S-T1-Code feedback when T12 timed out

0585 U M 2043 Change gear signal
0586 UN T 12 G-M-S-T output: delay feedback
0587 UN T 60 Timer 12 running
0588 U E 17 Auxiliary function complete feedback: Terminal J5/7
0589 S M 2480 Gear range feedback

0590 U M 2044 Change S-signal
0591 UN T 12 G-M-S-T output: delay feedback
0592 UN T 60 Timer 12 running
0593 U E 17 Auxiliary function complete feedback: Terminal J5/7
0594 S M 2481 S feedback

0595 U M 2045 Change M-signal
0596 UN T 12 G-M-S-T output: delay feedback
0597 UN T 60 Timer 12 running
0598 U E 17 Auxiliary function complete feedback: Terminal J5/7
0599 S M 2482 M feedback

0600 U M 2046 Change T1-signal
0601 UN T 12 G-M-S-T output: delay feedback
0602 UN T 60 Timer 12 running
0603 U E 17 Auxiliary function complete feedback: Terminal J5/7
0604 S M 2483 T1 feedback

D 4) Terminal layout for input/output signals for TNC 150 B / TNC 150 Q

Control		User
TNC 150 Q Outputs PL 100 B PL 110 B	TNC 150 B multipoint connector of control	
A0	J1/1	X } Release
A1	J1/2	Y } Release
A2	J1/3	Z } Release
A3	J1/4	IV } Release
A4	J1/5	Control in operation
A5	J1/6	Control in automatic mode
A6	J1/7	Lock for spindle on
	J1/8	Emergency stop (no output from direct NC-part of machine)
	J1/9	+ 24 V supply
	J1/10	+ 24 V supply
	J1/11	+ 24 V supply
	J1/12	+ 24 V supply
	J2/1	+ 24 V supply
A7	J2/2	M-S-T Code bit 1
A8	J2/3	M-S-T Code bit 2
A9	J2/4	M-S-T Code bit 3
A10	J2/5	M-S-T Code bit 4
A11	J2/6	M-S-T Code bit 5
A12	J2/7	M-S-T Code bit 6
A13	J2/8	M-S-T Code bit 7
A14	J2/9	M-S-T Code bit 8
A15	J2/10	M03 Spindle clockwise
A16	J2/11	M04 Spindle counter-clockwise
A17	J2/12	M05 Spindle stop
A18	J3/1	M08 Coolant on
A19	J3/2	M09 Coolant off
A20	J3/3	S-Strobe
A21	J3/4	M-Strobe
A22	J3/5	T-Strobe
Multipoint connector of control		
J3/2	J3/6	+ 12 V only for feed rate potentiometer
J3/7	J3/7	do not assign
J3/3	J3/8	manual feed
J3/4	J3/9	0V
J3/10	J3/10	do not assign
J3/11	J3/11	do not assign
J3/12	J3/12	Housing
J1/1	J4/1	+/- } Analogue output X
J1/2	J4/2	0 V } Analogue output X
J1/3	J4/3	+/- } Analogue output Y
J1/4	J4/4	0 V } Analogue output Y
J1/5	J4/5	+/- } Analogue output Z
J1/6	J4/6	0 V } Analogue output Z
J1/7	J4/7	+/- } Analogue output IV
J1/8	J4/8	0 V } Analogue output IV
J1/9	J4/9	+/- } Analogue output spindle
J1/10	J4/10	0 V } Analogue output spindle
	J4/11	do not assign
	J4/12	0 V Return line
Inputs PL 100 B PL 110 B		
E23	J5/1	Stop-button
E22	J5/2	Start-button
E21	J5/3	Rapid traverse button
E20	J5/4	do not assign
E19	J5/5	Manual feed (opens position loop)
E18	J5/6	Feed rate release
E17	J5/7	Feedback: Auxiliary function completed
E8	J5/8	Feedback: Emergency stop test (is directly interrogated by NC-part of cont)
E0	J5/9	Reference end position X
E1	J5/10	Reference end position Y
E2	J5/11	Reference end position Z
E3	J5/12	Reference end position IV
E4	J6/1	Reference pulse suppressor X
E5	J6/2	Reference pulse suppressor Y
E6	J6/3	Reference pulse suppressor Z
E7	J6/4	Reference pulse suppressor IV
E9	J6/5	Direction button X+
E10	J6/6	Direction button X-
E11	J6/7	Direction button Y+
E12	J6/8	Direction button Y-
E13	J6/9	Direction button Z+
E14	J6/10	Direction button Z-
E15	J6/11	Direction button IV+
E16	J6/12	Direction button IV-

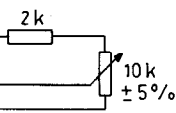

TNC 150 Q connector J2/1 – J2/12 do not assign

E) Programming list

PLC-program list

Command No.	Command	Remarks
0		
1		
2		
3		
4		
5		
6		
7		
8		
9		
0		
1		
2		
3		
4		
5		
6		
7		
8		
9		
0		
1		
2		
3		
4		
5		
6		
7		
8		
9		
0		
1		
2		
3		
4		
5		
6		
7		
8		
9		
0		

Inputs

First PCB

Input	Remarks
E 0	Reference end position X
E 1	Reference end position Y
E 2	Reference end position Z
E 3	Reference end position IV
E 4	Reference pulse inhibit X
E 5	Reference pulse inhibit Y
E 6	Reference pulse inhibit Z
E 7	Reference pulse inhibit IV
E 8	Feedback, Emergency stop
E 9	
E 10	
E 11	
E 12	
E 13	
E 14	
E 15	
E 16	
E 17	
E 18	
E 19	
E 20	
E 21	
E 22	
E 23	
E 24	
E 25	
E 26	
E 27	
E 28	
E 29	
E 30	
E 31	
E 32	
E 33	
E 34	
E 35	
E 36	
E 37	
E 38	

Input	Remarks
E 39	
E 40	
E 41	
E 42	
E 43	
E 44	
E 45	
E 46	
E 47	
E 48	
E 49	
E 50	
E 51	
E 52	
E 53	
E 54	
E 55	
E 56	
E 57	
E 58	
E 59	
E 60	
E 61	
E 62	
E 63	Overload of an output stage (internally wired)

Inputs

Second PCB

Input	Remarks
E 64	
E 65	
E 66	
E 67	
E 68	
E 69	
E 70	
E 71	
E 72	
E 73	
E 74	
E 75	
E 76	
E 77	
E 78	
E 79	
E 80	
E 81	
E 82	
E 83	
E 84	
E 85	
E 86	
E 87	
E 88	
E 89	
E 90	
E 91	
E 92	
E 93	
E 94	
E 95	
E 96	
E 97	
E 98	
E 99	
E 100	
E 101	
E 102	

Input	Remarks
E 103	
E 104	
E 105	
E 106	
E 107	
E 108	
E 109	
E 110	
E 111	
E 112	
E 113	
E 114	
E 115	
E 116	
E 117	
E 118	
E 119	
E 120	
E 121	
E 122	
E 123	
E 124	
E 125	
E 126	
E 127	Overload of an output stage (internally wired)

Outputs**First PCB**

Output	Remarks
A 0	
A 1	
A 2	
A 3	
A 4	
A 5	
A 6	
A 7	
A 8	
A 9	
A 10	
A 11	
A 12	
A 13	
A 14	
A 15	
A 16	
A 17	
A 18	
A 19	
A 20	
A 21	
A 22	
A 23	
A 24	
A 25	
A 26	
A 27	
A 28	
A 29	
A 30	
A 31	Cancellation of "overload condition" (internally wired)

Outputs**Second PCB**

Output	Remarks
A 32	
A 33	
A 34	
A 35	
A 36	
A 37	
A 38	
A 39	
A 40	
A 41	
A 42	
A 43	
A 44	
A 45	
A 46	
A 47	
A 48	
A 49	
A 50	
A 51	
A 52	
A 53	
A 54	
A 55	
A 56	
A 57	
A 58	
A 59	
A 60	
A 61	
A 62	
A 63	Cancellation of "overload condition" (internally wired)

Marker list

Marker No.	Remarks
0	
1	
2	
3	
4	
5	
6	
7	
8	
9	
0	
1	
2	
3	
4	
5	
6	
7	
8	
9	
0	
1	
2	
3	
4	
5	
6	
7	
8	
9	
0	
1	
2	
3	
4	
5	
6	
7	
8	
9	
0	

Marker No.	Remarks
0	
1	
2	
3	
4	
5	
6	
7	
8	
9	
0	
1	
2	
3	
4	
5	
6	
7	
8	
9	
0	
1	
2	
3	
4	
5	
6	
7	
8	
9	
0	

F) List of machine parameters for TNC 150

Machine parameters which affect the PLC have been marked.

Function		Parameter No.	Entry values
Rapid traverse	X	0	80 – 15 999 mm/min (IV: Degrees/min. with axis designation A or B or C)
	Y	1	
	Z	2	
	IV	3	
Manual feed (100 %)	X	4	
	Y	5	
	Z	6	
	IV	7	
Speed when approaching reference points	X	8	
	Y	9	
	Z	10	
	IV	11	
Signal evaluation	X	12	1 ≙ 20-fold
	Y	13	2 ≙ 10-fold
	Z	14	
	IV	15	
Traversing direction when approaching reference marks	X	16	0 ≙ Plus-direction
	Y	17	1 ≙ Minus-direction
	Z	18	(with correct programming of parameters Nos. 20 to 27)
	IV	19	
Counting direction	X	20	0 or 1
	Y	21	
	Z	22	
	IV	23	
Polarity of nominal value voltage	X	24	0 ≙ positive with positive traversing direction
	Y	25	1 ≙ negative with positive traversing direction
	Z	26	
	IV	27	
Integral factor	X	28	0 – 65 535
	Y	29	
	Z	30	
	IV	31	
Differential factor	X	32	0 – 65.535
	Y	33	
	Z	34	
	IV	35	
Backlash compensation	X	36	– 1.000 mm – + 1.000 mm
	Y	37	
	Z	38	
	IV	39	
Correction factor for linear correction	X	40	– 1.000 mm/m – + 1.000 mm/m
	Y	41	
	Z	42	
	IV	43	
Software limit switch ranges	X+	44	0 to ± 30 000.000 mm
	X–	45	
	Y+	46	
	Y–	47	
	Z+	48	
	Z–	49	
	IV+	50	
IV–	51	Angular axis 0 to ± 30 000°	
Analogue voltage with rapid traverse		52	+ 4.5 – + 9 Volts
Approach speed		53	0.1 – 10 m/min
Acceleration		54	0.001 – 1.5 m/s ²
Circular acceleration		55	

Function	Parameter No.	Entry values
Position supervision (eraseable)	56	0.001 – 30 mm
Position supervision (emergency stop)	57	
Positioning accuracy X, Y, Z	58	0.001 – 0,05 mm
Axis sequence for reference point approach	59	0 ≙ X Y Z IV 12 ≙ Z X Y IV 1 ≙ X Y IV Z 13 ≙ Z X IV Y 2 ≙ X Z Y IV 14 ≙ Z Y X IV 3 ≙ X Z IV Y 15 ≙ Z Y IV X 4 ≙ X IV Y Z 16 ≙ Z IV X Y 5 ≙ X IV Z Y 17 ≙ Z IV Y X 6 ≙ Y X Z IV 18 ≙ IV X Y Z 7 ≙ Y X IV Z 19 ≙ IV X Z Y 8 ≙ Y Z X IV 20 ≙ IV Y X Z 9 ≙ Y Z IV X 21 ≙ IV Y Z X 10 ≙ Y IV X Z 22 ≙ IV Z X Y 11 ≙ Y IV Z X 23 ≙ IV Z Y X
Speed pre-control	60	0 ≙ on 1 ≙ off
Output of tool numbers	61	0 No output 1 Output only when tool number changes 2 Output of all tool numbers
Output of spindle speeds codes or as S-analogue voltage	62	0 ≙ No output of spindle rpm 1 ≙ Coded output only when rpm changes 2 ≙ Coded output of all rpms 3 ≙ S-Analogue voltage output Gear switching signal only when gear ratio changes 4 ≙ S-Analogue voltage output, Output of gear switching signal with every tool call 5 ≙ S-Analogue voltage output without gear switching signal
rpm code limit	63	01991
Oscillation when accelerating	64	0.01 – 0.999
Display resolution	65	0 ≙ 1 μm 1 ≙ 5 μm
External feed rate potentiometer	66	0 ≙ internal potentiometer for override and manual feed 1 ≙ external potentiometer for override and manual feed 2 ≙ internal potentiometer for override external potentiometer for manual feed
Dwell time, rotation change of spindle in tapping cycle	67	0 – 65 535 msec.
Memory function for direction buttons	68	0 ≙ off 1 ≙ on
Special procedure for reference point approach	69	0 ≙ off 1 ≙ on
PLC: Nominal value voltage for spindle drive when gear changing	70	0 – 9.999 Volts
Program end character	71	1 – 126 (depending on value of appropriate character on tape)
Selection for control of inhibited axes	72	0 ≙ none Axis inhibited 1 ≙ X– Axis inhibited 2 ≙ Y– Axis inhibited 3 ≙ X–, Y– Axis inhibited 4 ≙ Z– Axis inhibited 5 ≙ X–, Z– Axis inhibited 6 ≙ Y–, Z– Axis inhibited 7 ≙ X–, Y–, Z– Axis inhibited

Function	Parameter No.	Entry values
		8 ≙ IV- Axis inhibited 9 ≙ X-, IV- Axis inhibited 10 ≙ Y-, IV- Axis inhibited 11 ≙ X-, Y-, IV- Axis inhibited 12 ≙ Z-, IV- Axis inhibited 13 ≙ X-, Z-, IV- Axis inhibited 14 ≙ Y-, Z-, IV- Axis inhibited 15 ≙ X-, Y-, Z-, IV- Axis inhibited
Pre-cut out time for "tapping" cycle	73	0 – 65.535 s
Override effective on pressing rapid button Override in 2 % steps or infinitely variable	74	0 ≙ Override ineffective on pressing rapid button Override in 2 % steps 1 ≙ Override effective on pressing rapid button Override in 2 % steps 2 ≙ Override ineffective on pressing rapid button Override infinitely variable 3 ≙ Override effective on pressing rapid button Override infinitely variable
Reference signal evaluation for inhibited axes	75	0 ≙ inactive 1 ≙ active
Display and transducer supervision for inhibited axes	76	0 ≙ inactive 1 ≙ active
PLC program from RAM or from EPROM	77	0 ≙ RAM 1 ≙ EPROM
RPM-range gear ratios 0	78	0 – 9 000,000 rpm
S-analogue output 1	79	
2	80	
3	81	
4	82	
5	83	
6	84	
7	85	
S-Analogue voltage with S-Override at 100 %	86	0.999 – 9.999 Volts
S-Analogue voltage with S-Override at max. output voltage	87	
Limitation of S-override		0 – 150 %
Maximum	88	
Minimum	89	
Axis designation for axis IV	90	0 ≙ A 2 ≙ C 4 ≙ V 1 ≙ B 3 ≙ U 5 ≙ W
Constant contouring speed at corners	91	0 – 179.999 Angle in degrees
Decimal character in program output via V.24	92	0 ≙ Decimal comma 1 ≙ Decimal point
Overlapping factor with pocket milling	93	0.001 – 1.414
PLC: Counter predetermined value for counters 0 – 15	94 to 109	0 – 65 535
PLC: Timer duration for timers 0 – 15	110 to 125	0 – 65 535 in units of 20 ms
PLC: Position values for 31 coordinates 31 = Ref.	126 to 156	± 30 000.000 mm
PLC: Activation of next tool No.	157	0 ≙ inactive 1 ≙ active
PLC: Setting of 16 markers to binary number	158	0 – 65 535
PLC: Automatic lubrication to programmed traversing distance in X Y Z IV	159 to 162	0 – 65 535 (in 65 536-µm-units)

Function	Parameter No.	Entry values
PLC: Feed rate for parameters Nos. 126 to 156	X Y Z IV 163 164 165 166	80 – 15 999 mm/min
Display of current feed rate before start in "manual"	167	0 ≙ off 1 ≙ on
Ramp gradient for S-analogue	168	0 – 1.999 Volts/ms
Standstill supervision	169	0.001 to 30 mm
Programming station	170	0 ≙ Control 1 ≙ Programming station: PLC active 2 ≙ Programming station: PLC inactive
Handwheel	171	not yet active, enter 0
Polarity S-analogue voltage	172	0 ≙ M 03: positive voltage M 04: negative voltage 1 ≙ M 03: negative voltage M 04: positive voltage 2 ≙ M 03 and M 04: positive voltage 3 ≙ M 03 and M 04: negative voltage
Cancellation of status display with with M 02 and M 30	173	0 ≙ Status display not to be cancelled 1 ≙ Status display to be cancelled
Trailing error supervision in trailing operation (Emergency stop) (eraseable)	174 175	0 – 100 mm 0 – 100 mm
Multiplication factor for K_V -factor	176	0.001 – 1.000
K_V -factor for	X 177 Y 178 Z 179 IV 180	0.100 – 10.000
Characteristic kink	181	0 – 100.000 %
Minimum for feed rate override with tapping	182	0 – 150 %
Maximum for feed rate override with tapping	183	0 – 150 %
Minimum voltage for S-analogue output	184	0 – 9.999 Volts
Waiting time for cut-out of remaining nominal value voltage with error display "Positioning error"	185	0 – 65.535 sec.
Tool change position (M 92)	X-Axis 186 Y-Axis 187 Z-Axis 188 IV-Axis 189	± 30 000.000
Programming of rpm S = 0 permitted (voltage value of MP 184 may be exceeded)	190	1 ≙ S = 0 not permitted 0 ≙ S = 0 permitted
Display of current spindle rpm before start in "manual"	191	0 ≙ on 1 ≙ off
Position window for axis IV	192	0.001 – 0.05 mm
PLC: Timer duration for timer 16 – 31	193 to 208	0 – 65 535 in units of 20 ms
Support of PLC-macro commands	209 to 212	0
Scaling cycle effective on 2 or 3 axes	213	0 ≙ Scaling in 3 main axes X, Y and Z 1 ≙ Scaling in working plane
Programmed stop with M 06	214	0 ≙ programmed stop with M 06 1 ≙ no programmed stop with M 06

G) List of markers for signal exchange between PLC and NC

Note:

Markers M 1900 to M 1999 are either user-markers or markers for signal exchange between the PLC and NC – depending on marker 2496 (see section C 2.2.4.2).

Marker-No.	Function
2000	Release X-axis
2001	Release Y-axis
2002	Release Z-axis
2003	Release IV-axis
2004	"0" = Analogue voltage for spindle drive is located in ramp
2005	"1" = Analogue voltage for spindle drive is 0 V
2008	X-axis in position
2009	Y-axis in position
2010	Z-axis in position
2011	IV-axis in position
2012	Lubrication impulse necessary X-axis limit exceeded
2013	Lubrication impulse necessary Y-axis limit exceeded
2014	Lubrication impulse necessary Z-axis limit exceeded
2015	Lubrication impulse necessary IV-axis limit exceeded
2032	1. Bit T-Code (lsb)
2033	2. Bit T-Code
2034	3. Bit T-Code
2035	4. Bit T-Code
2036	5. Bit T-Code
2037	6. Bit T-Code
2038	7. Bit T-Code
2039	8. Bit T-Code (msb)
2043	Change signal G-Code for S-analogue
2044	Change signal S-Code
2045	Change signal M-Code
2046	Change signal T-Code
2047	Change signal 2. T-Code (see machine parameter 157)
2048	Tapping cycle is called
2050	Programming
2051	Manual operation
2052	Electronic handwheel
2053	Positioning with MDI
2054	Program run single block
2055	Automatic
2056	Program test
2057	Approach to reference point
2064	1. Bit S-Code (lsb)
2065	2. Bit S-Code
2066	3. Bit S-Code
2067	4. Bit S-Code
2068	5. Bit S-Code
2069	6. Bit S-Code
2070	7. Bit S-Code
2071	8. Bit S-Code (msb)
2072	1. Bit M-Code (lsb)
2073	2. Bit M-Code
2074	3. Bit M-Code
2075	4. Bit M-Code
2076	5. Bit M-Code
2077	6. Bit M-Code
2078	7. Bit M-Code
2079	8. Bit M-Code (msb)

Marker-No.	Function
2080	1. Bit for minimum rpm (lsb)
2081	2. Bit for minimum rpm
2082	3. Bit for minimum rpm
2083	4. Bit for minimum rpm
2084	5. Bit for minimum rpm
2085	6. Bit for minimum rpm
2086	7. Bit for minimum rpm
2087	8. Bit for minimum rpm (msb)
2088	1. Bit for step width (lsb)
2089	2. Bit for step width
2090	3. Bit for step width
2091	4. Bit for step width (msb)
2096	TNC axis-button last pressed X
2097	TNC axis button last pressed Y
2098	TNC axis-button last pressed Z
2099	TNC axis-button last pressed IV
2104	1. Bit gear change Code S-Analogue (lsb)
2105	2. Bit gear change Code S-Analogue
2106	3. Bit gear change Code S-Analogue (msb)
2176	Code operating mode (lsb)
2177	Code operating mode
2178	Code operating mode
2179	Code operating mode (msb) 0000 = Programming 0001 = Manual operation 0010 = Electronic handwheel 0011 = Positioning with MDI 0100 = Program run single block 0101 = Automatic
2180	1. PLC-cycle run after power on
2182	Inhibited TNC-button pressed
2183	Program interruption (flashing of operation display lamp)
2184	Control in operation (permanent operation pilot)
2185	1. PLC-cycle run after interruption of PLC-program
2190	Erasable error display is displayed
2191	Error "external emergency stop" is displayed
2192	Marker influenced by machine parameter 158 (value 1)
2193	Marker influenced by machine parameter 158 (value 2)
2194	Marker influenced by machine parameter 158 (value 4)
2195	Marker influenced by machine parameter 158 (value 8)
2196	Marker influenced by machine parameter 158 (value 16)
2197	Marker influenced by machine parameter 158 (value 32)
2198	Marker influenced by machine parameter 158 (value 64)
2199	Marker influenced by machine parameter 158 (value 128)
2200	Marker influenced by machine parameter 158 (value 256)
2201	Marker influenced by machine parameter 158 (value 512)
2202	Marker influenced by machine parameter 158 (value 1024)
2203	Marker influenced by machine parameter 158 (value 2048)
2204	Marker influenced by machine parameter 158 (value 4096)

Marker-No.	Function
2205	Marker influenced by machine parameter 158 (value 8192)
2206	Marker influenced by machine parameter 158 (value 16384)
2207	Marker influenced by machine parameter 158 (value 32768)
2448	NC-Start
2449	NC-rapid
2450	Memory function for manual traversing
2451	Feed release
2452	Start PLC-positioning X-axis
2453	Start PLC-positioning Y-axis
2454	Start PLC-positioning Z-axis
2455	Start PLC-Positioning IV-axis
2456	Manual traversing X+
2457	Manual traversing X-
2458	Manual traversing Y+
2459	Manual traversing Y-
2460	Manual traversing Z+
2461	Manual traversing Z-
2462	Manual traversing IV+
2463	Manual traversing IV-
2464	Complemented NC-start
2465	Complemented NC-rapid
2466	Complemented memory function for manual traversing
2467	Complemented feed release
2468	Complemented start PLC-positioning X-axis
2469	Complemented start PLC-positioning Y-axis
2470	Complemented start PLC-positioning Z-axis
2471	Complemented start PLC-positioning IV-axis
2472	Complemented manual traverse X+
2473	Complemented manual traverse X-
2474	Complemented manual traverse Y+
2475	Complemented manual traverse Y-
2476	Complemented manual traverse Z+
2477	Complemented manual traverse Z-
2478	Complemented manual traverse IV+
2479	Complemented manual traverse IV-
2480	Feedback signal gear change code S-Analogue
2481	Feedback S-Code
2482	Feedback M-Code
2483	Feedback T-Code
2484	Feedback 2. T-Code
2485	Status display and sign of analogue output M03
2486	Status display and sign of analogue output M04
2487	Status display M05
2488	NC-Stop
2489	Inversion of analogue voltage
2490	Spindle ccw for gear change
2491	Spindle cw for gear change
2492	Activation position loop inhibit for X-axis
2493	Activation position loop inhibit for Y-axis
2494	Activation position loop inhibit for Z-axis
2495	Activation position loop inhibit for IV-axis
2496	Release marker for decoded M-Code-output via markers 1900 – 1999

Marker-No.	Function
2544	Inhibit position loop X-axis
2545	Inhibit position loop Y-axis
2546	Inhibit position loop Z-axis
2547	Inhibit position loop IV-axis
2548	Reset accumulated distance in X-axis for travel-dependent lubrication
2549	Reset accumulated distance in Y-axis for travel-dependent lubrication
2550	Reset accumulated distance in Z-axis for travel-dependent lubrication
2551	Reset accumulated distance in IV-axis for travel-dependent lubrication
2552	Transfer actual position value in position loop X-axis
2553	Transfer actual position value in position loop Y-axis
2554	Transfer actual position value in position loop Z-axis
2555	Transfer actual position value in position loop IV-axis
2556	REF-point end position X-axis
2557	REF-point end position Y-axis
2558	REF-point end position Z-axis
2559	REF-point end position IV-axis
2560	PLC-positioning X-axis (lsb)
2561	PLC-positioning X-axis
2562	PLC-positioning X-axis
2563	PLC-positioning X-axis
2564	PLC-positioning X-axis (msb)
2565	PLC-positioning Y-axis (lsb)
2566	PLC-positioning Y-axis
2567	PLC-positioning Y-axis
2568	PLC-positioning Y-axis
2569	PLC-positioning Y-axis (msb)
2570	PLC-positioning Z-axis (lsb)
2571	PLC-positioning Z-axis
2572	PLC-positioning Z-axis
2573	PLC-positioning Z-axis
2574	PLC-positioning Z-axis (msb)
2575	PLC-positioning IV-axis (lsb)
2576	PLC-positioning IV-axis
2577	PLC-positioning IV-axis
2578	PLC-positioning IV-axis
2579	PLC-positioning IV-axis (msb)
2800	TNC-button code for external address of TNC-buttons (see markers 2855 to 2923 for coding)
2801	TNC-button code for external address of TNC-buttons (see markers 2855 to 2923 for coding)
2802	TNC-button code for external address of TNC-buttons (see markers 2855 to 2923 for coding)
2803	TNC-button code for external address of TNC-buttons (see markers 2855 to 2923 for coding)
2804	TNC-button code for external address of TNC-buttons (see markers 2855 to 2923 for coding)
2805	TNC-button code for external address of TNC-buttons (see markers 2855 to 2923 for coding)
2806	TNC-button code for external address of TNC-buttons (see markers 2855 to 2923 for coding)
2807	TNC-button code for external address of TNC-buttons (see markers 2855 to 2923 for coding)
2808	Strobe for button-code
2815	Flashing error message from PLC

Marker-No.	Function	Button code
2855	Button inhibit	0011 1011
2856	Button inhibit	0011 1100
2857	Button inhibit	0011 1101
2858	Button inhibit	0011 1110
2859	Button inhibit	0011 1111
2860	Button inhibit	0100 0000
2861	Button inhibit	0100 0001
2862	Button inhibit	0100 0010
2863	Button inhibit	0100 0011
2864	Button inhibit	0100 0100
2868	Button inhibit	0100 1000
2869	Button inhibit	0100 1001
2870	Button inhibit	0100 1010
2871	Button inhibit	0100 1011
2872	Button inhibit	0100 1100
2880	Button inhibit	0101 0100
2881	Button inhibit	0101 0101
2882	Button inhibit	0101 0110
2883	Button inhibit	0101 0111
2884	Button inhibit	0101 1000
2885	Button inhibit	0101 1001
2886	Button inhibit	0101 1010
2887	Button inhibit	0101 1011
2888	Button inhibit	0101 1100
2889	Button inhibit	0101 1101
2890	Button inhibit	0101 1110
2891	Button inhibit	0101 1111
2892	Button inhibit	0110 0000
2893	Button inhibit	0110 0001
2894	Button inhibit	0110 0010
2895	Button inhibit	0110 0011
2896	Button inhibit	0110 0100
2897	Button inhibit	0110 0101
2898	Button inhibit	0110 0110
2899	Button inhibit	0110 0111
2900	Button inhibit	0110 1000
2901	Button inhibit	0110 1001
2902	Button inhibit	0110 1010
2903	Button inhibit	0110 1011
2904	Button inhibit	0110 1100
2905	Button inhibit	0110 1101
2906	Button inhibit	0110 1110
2907	Button inhibit	0110 1111
2908	Button inhibit	0111 0000
2909	Button inhibit	0111 0001
2910	Button inhibit	0111 0010
2911	Button inhibit	0111 0011
2912	Button inhibit	0111 0100

Marker-No.	Function	Button code
2913	Button inhibit	0111 0101
2914	Button inhibit	0111 0110
2915	Button inhibit	0111 0111
2920	Button inhibit	0111 1100
2921	Button inhibit	0111 1101
2922	Button inhibit	0111 1110
2923	Button inhibit	0111 1111
2924	Error message 0	
2925	Error message 1	
2926	Error message 2	
2927	Error message 3	
2928	Error message 4	
2929	Error message 5	
2930	Error message 6	
2931	Error message 7	
2932	Error message 8	
2933	Error message 9	
2934	Error message 10	
2935	Error message 11	
2936	Error message 12	
2937	Error message 13	
2938	Error message 14	
2939	Error message 15	
2940	Error message 16	
2941	Error message 17	
2942	Error message 18	
2943	Error message 19	
2944	Error message 20	
2945	Error message 21	
2946	Error message 22	
2947	Error message 23	
2948	Error message 24	
2949	Error message 25	
2950	Error message 26	
2951	Error message 27	
2952	Error message 28	
2953	Error message 29	
2954	Error message 30	
2955	Error message 31	
2956	Error message 32	
2957	Error message 33	
2958	Error message 34	
2959	Error message 35	
2960	Error message 36	
2961	Error message 37	
2962	Error message 38	
2963	Error message 39	
2964	Error message 40	

Marker-No.	Function
2965	Error message 41
2966	Error message 42
2967	Error message 43
2968	Error message 44
2969	Error message 45
2970	Error message 46
2971	Error message 47
2972	Error message 48
2973	Error message 49
2974	Error message 50
2975	Error message 51
2976	Error message 52
2977	Error message 53
2978	Error message 54
2979	Error message 55
2980	Error message 56
2981	Error message 57
2982	Error message 58
2983	Error message 59
2984	Error message 60
2985	Error message 61
2986	Error message 62
2987	Error message 63
2988	Error message 64
2989	Error message 65
2990	Error message 66
2991	Error message 67
2992	Error message 68
2993	Error message 69
2994	Error message 70
2995	Error message 71
2996	Error message 72
2997	Error message 73
2998	Error message 74
2999	Error message 75
3000	Error message 76
3001	Error message 77
3002	Error message 78
3003	Error message 79
3004	Error message 80
3005	Error message 81
3006	Error message 82
3007	Error message 83
3008	Error message 84
3009	Error message 85
3010	Error message 86
3011	Error message 87
3012	Error message 88

Marker-No.	Function
3013	Error message 89
3014	Error message 90
3015	Error message 91
3016	Error message 92
3017	Error message 93
3018	Error message 94
3019	Error message 95
3020	Error message 96
3021	Error message 97
3022	Error message 98
3023	Error message 99



DR. JOHANNES HEIDENHAIN

D-8225 Traunreut

Telefon (08669) 31-0, Telex 56831