











RC element, 24 ... 48 V AC, 24 ... 70 V DC, surge suppressor, for mounting onto contactors Size S2 and S3 !!! Phased-out product !!! Successor is SIRIUS 3RT2 Preferred successor type is >>3RT2936-1CB00<<

Figure similar

General technical data:		
Product brand name		SIRIUS
Product designation		surge suppressor
Design of the surge suppressor		with RC elements
Control circuit/ Control:		
Type of voltage of the control supply voltage		AC/DC
Control supply voltage frequency		
• 1 rated value	Hz	50
• 2 rated value	Hz	60
Control supply voltage 1		
• at DC		
— Initial rated value	V	24
— Final rated value	V	70
• at AC		
— at 50 Hz Initial rated value	V	24
— at 50 Hz Final rated value	V	48
— at 60 Hz Final rated value	V	48

Certificates/ approvals:

General Product Approval			Functional Safety/Safety of Machinery	Declaration of Conformity	Test Certificates
 CSA	 UR		Type Examination Certificate	 EG-Konf.	Special Test Certificate

Shipping Approval				other	
 ABS	 PRS	 RINA	 RMRS	Confirmation	Miscellaneous

Further information

Information- and Downloadcenter (Catalogs, Brochures,...)

<http://www.siemens.com/industrial-controls/catalogs>

Industry Mall (Online ordering system)

<http://www.siemens.com/industrymall>

Cax online generator

<http://support.automation.siemens.com/WW/CAXorder/default.aspx?lang=en&mlfb=3RT1936-1CB00>

Service&Support (Manuals, Certificates, Characteristics, FAQs,...)

<https://support.industry.siemens.com/cs/ww/en/ps/3RT1936-1CB00>

Image database (product images, 2D dimension drawings, 3D models, device circuit diagrams, EPLAN macros, ...)

http://www.automation.siemens.com/bilddb/cax_de.aspx?mlfb=3RT1936-1CB00&lang=en

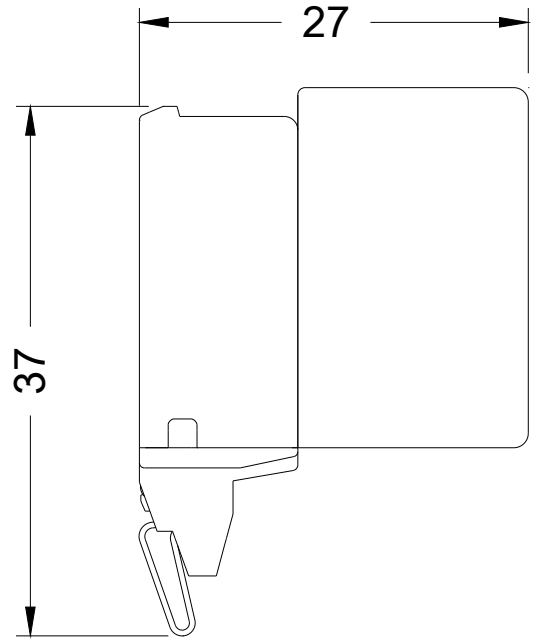
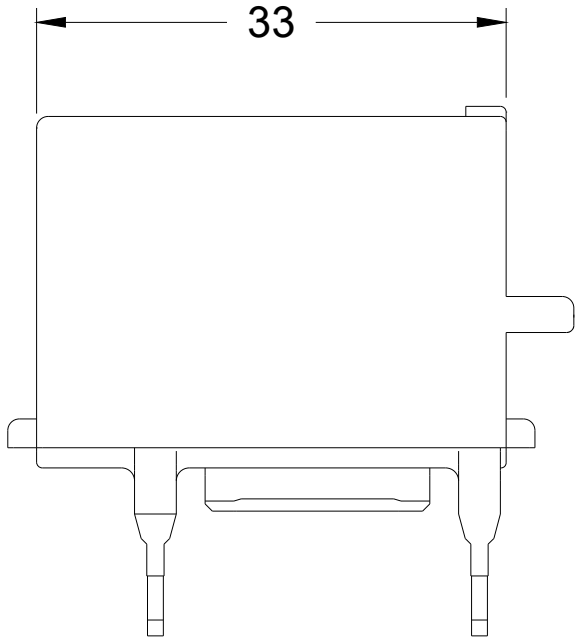

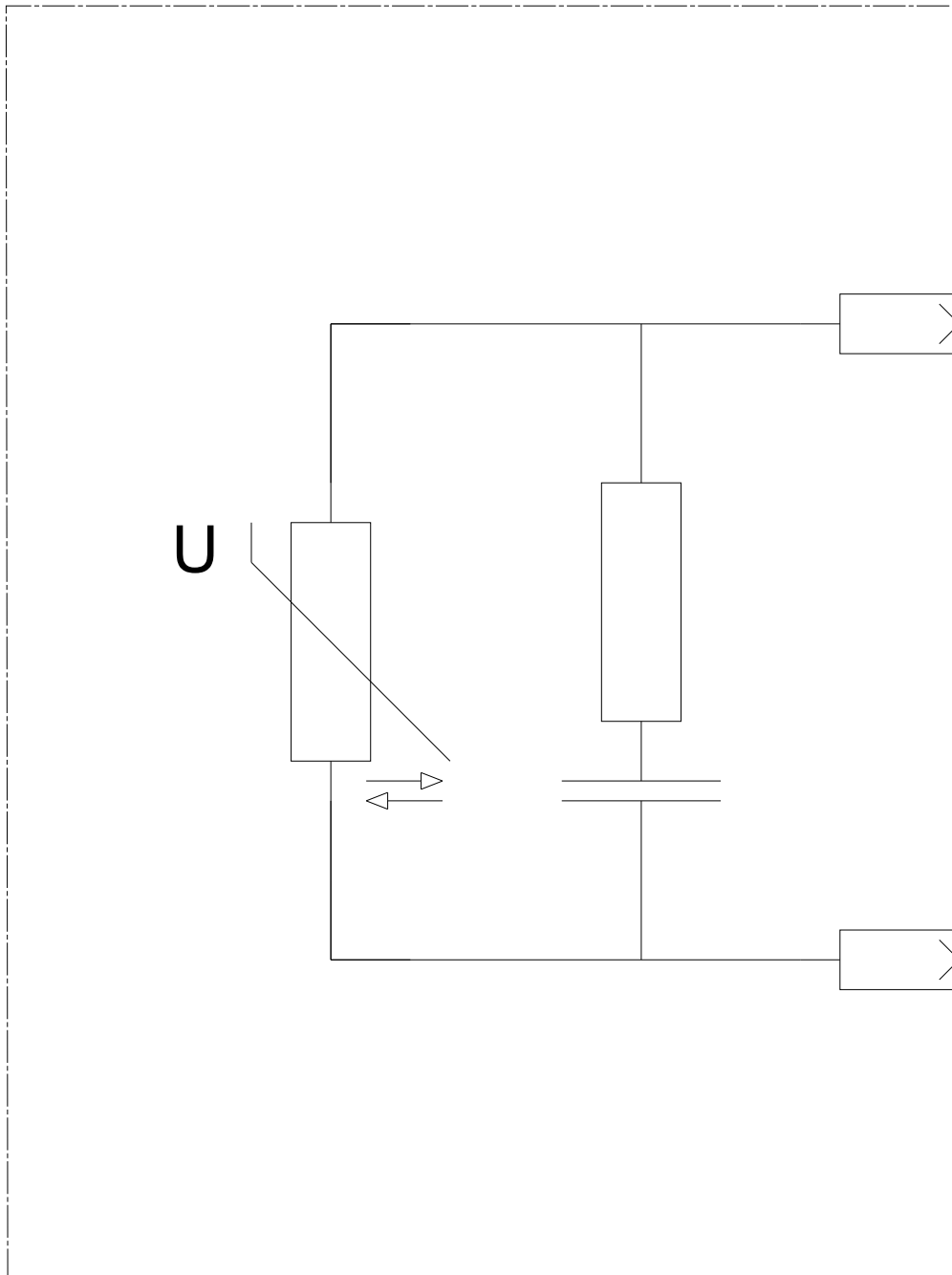

last modified:

11/17/2018