

FALOWNIK MX2

Stworzony, żeby napędzać maszyny



- » Jakość gwarantowana przez firmę Omron
- » Duża funkcjonalność programowania
- » Wbudowane zabezpieczenia

Optymalne sterowania silnikiem i maszyną

MX2 zaprojektowano specjalnie z myślą o napędzaniu maszyn. Produkt umożliwia optymalne sterowanie silnikiem i maszyną. Zaawansowana konstrukcja i algorytmy MX2 zapewniają płynne sterowanie do prędkości zerowej, precyzję obsługi szybkich, cyklicznych operacji oraz sterowania momentem obrotowym w trybie otwartej pętli. MX2 kompleksowo obsługuje funkcje sterowania maszynami, np. pozycjonowanie, synchronizację prędkości i programowanie logiczne. MX2 jest w pełni zintegrowane z inteligentną platformą automatyki Omron. MX2 to produkt lidera w dziedzinie automatyzacji.

STEROWANIE SILNIKIEM

200% momentu startowego

- Praca niemalże bez ruchu (0,5 Hz)
- Płynne sterowanie wysokimi obciążeniami od sił bezwładności
- Kontrola szybkich obciążeń cyklicznych

Regulacja momentu obrotowego w trybie otwartej pętli

- Idealne przy niskim lub średnim momencie obrotowym
- Zastępuje wektor przepływu lub serwo w odpowiednich układach

Silniki specjalne

- Silniki z magnesami stałymi
- Silniki o wysokiej prędkości do 1000 Hz

Automatyczne strojenie jednego parametru

- MX2 zapewnia płynne i bezpieczne działanie – wystarczy podać moc znamionową silnika w kW





STEROWANIE MASZYNĄ

Wbudowane zabezpieczenia

- Zgodne z normą bezpieczeństwa ISO-13849 CAT3, poziom wydajności PL d
- 2 wejścia bezpieczeństwa
- EDM (External Device Monitoring)

Programowanie sterowników logicznych

- Programowanie przy użyciu schematów blokowych
- Edytor tekstu
- Intuicyjne – nawet 5 równoległych zadań

Pozycjonowanie

- Maks. 8 pre-definiowanych pozycji z funkcją przywrócenia
- Synchronizacja prędkości

Integracja z inteligentną automatyką Omron

- Narzędzie programowania CX-Drive podłączone do MX2 przez wbudowany port USB.
- Wbudowany Modbus RS485
- Opcjonalne moduły EtherCAT, Profibus, DeviceNet, ML-II i inne...

Pełna kontrola...

Wysoki początkowy moment obrotowy i możliwość sterowania momentem obrotowym w trybie otwartej pętli zapewniają pełną kontrolę oraz dynamikę i wydajność maszyny. Opcje połączenia do wszystkich najważniejszych systemów magistrali oraz zasilanie zewnętrzne prądem stałym o napięciu 24 V umożliwiają pełną kontrolę użytkownika nad pracą maszyny.



Dostrajanie częstotliwości a zmienność momentu

Przykład: 4-biegunowy silnik 7,5 kW



Wzorzec momentu obrotowego

Falownik MX2 dostarcza 200% początkowego momentu obrotowego bliskiego stanowi spoczynku (0,5 Hz) i może sterować momentem obrotowym w trybie otwartej pętli. Pozwala to na wykorzystanie falownika MX2 w zastosowaniach, gdzie uprzednio wykorzystywane były napędy sterowane wektorem prądu przemiennego w pętli zamkniętej.

Łatwa integracja z siecią

Wbudowana komunikacja RS485 Modbus i standardowe sieci przemysłowe, np. EtherCAT (zgodne z profilem CoE - CiA402), MECHATROLINK-II, DeviceNet, Profibus lub opcjonalnie CompoNet.

Zewnętrzne 24 VDC - płynne działanie

Wejście 24 VDC urządzenia MX2 zapewnia procesorowi stałą kontrolę bez dodatkowego sprzętu, nawet po odłączeniu wejścia głównego. To klucz do kontrolowanego zatrzymania w sytuacji awaryjnej i ciągłości obsługi komunikacji sieciowej.

...0% ryzyka!

Falownik MX2 spełnia zasady bezpieczeństwa określone w normie ISO 13849-1 (kategoria 3) dzięki zastosowaniu dwóch wejść bezpieczeństwa i wyjścia EDM (External Device Monitoring – zewnętrzne monitorowanie urządzenia).

Nie wymaga zewnętrznych styczników po stronie silnika, co zapewnia użytkownikowi prostszą instalację.



Wbudowane funkcje bezpieczeństwa; ISO 13849-1, kategoria 3

Podwójne styczniki przy wyjściu falownika nie są już wymagane. Bezpośrednie połączenie z kontrolerem bezpieczeństwa zapewnia zgodność z normą ISO 13849-1, kategoria 3.



Wyjście monitorowania EDM

Wyjście EDM (External Device Monitoring) sprawdza bezpieczeństwo falownika, eliminując koszt i konieczność instalacji urządzeń zewnętrznych o tej samej funkcji.



Bezpośrednia integracja z obwodem bezpieczeństwa

Falowniki MX2 można łatwo wpasować w obwód bezpieczeństwa. Wejścia bezpieczeństwa można wykorzystać dla wielu falowników bez potrzeby stosowania dodatkowych przekaźników bezpieczeństwa.

Ustaw pozycję i uruchom!

MX2 to kontroler napędu i pozycji w jednym. Jest idealny do modułowych maszyn, które wymagają umiarkowanej dokładności pozycjonowania. Umożliwia synchronizację prędkości bez dodatkowego programowania.



Synchronizacja prędkości

Synchronizacja prędkości jest możliwa bez dodatkowych urządzeń zewnętrznych, poprzez standardowe ustawienia parametrów. MX2 pełni funkcję kontrolera prędkości zewnętrznego generatora impulsów/sygnatu kodera do 32 KHz.



Funkcja pozycjonowania

Specjalnie opracowane funkcje umożliwiają falownikowi MX2 rozwiązywanie prostych zadań związanych z pozycjonowaniem bez konieczności stosowania zewnętrznego sterownika. Użytkownik może wybrać maksymalnie 8 pozycji plus pozycja początkowa. Co więcej falownik MX2 może być przełączany pomiędzy trybami prędkości i pozycjonowania.

Programuj i działaj!

Falownik MX2 pozwala tworzyć inteligentne rozwiązania za pomocą dostępnych funkcji PLC. Narzędzie programistyczne wykorzystujące schematy blokowe pozwala tworzyć programy zawierające do 1000 linii kodu oraz uruchamiać 5 zadań jednocześnie.



Swobodne programowanie

- “Programowanie przy użyciu schematów blokowych
- Integracja w narzędziu CX-Drive
- Do 1000 linii kodu dla każdego programu
- Równoległe działanie 5 zadań”



MX2

Born to drive machines

- Current vector control
- High starting torque: 200% at 0.5 Hz
- Double rating VT 120%/1 min and CT 150%/1 min
- Speed range up to 1000 Hz
- IM & PM motor control
- Torque control in open loop vector
- Positioning functionality
- Built-in application functionality (i.e. Brake control)
- Built-in logic programming
- Safety embedded compliant with ISO13849-1 (double input circuit and external device monitor EDM)
- USB port for PC programming
- 24 VDC backup supply for control board
- Fieldbus communications: Modbus, DeviceNet, Profibus, Componet, Ethercat, ML-II and Ethernet/IP
- PC configuration tool: CX-Drive
- RoHS, CE, cULus

Ratings

- 200 V Class single-phase 0.1 to 2.2 kW
- 200 V Class three-phase 0.1 to 15.0 kW
- 400 V Class three-phase 0.4 to 15.0 kW



System configuration



Specifications

Type designation



200 V class

| Single-phase: 3G3MX2-□ | | B001 | B002 | B004 | B007 ¹ | B015 | B022 | - | - | - | - | - | |
|--------------------------------|---|---|---|------|-------------------|--------------------------------|---------------------------|------------|------|--------------------|------|------|------|
| Three-phase: 3G3MX2-□ | | 2001 | 2002 | 2004 | 2007 | 2015 | 2022 | 2037 | 2055 | 2075 | 2110 | 2150 | |
| Motor kW ² | For VT setting | 0.2 | 0.4 | 0.55 | 1.1 | 2.2 | 3.0 | 5.5 | 7.5 | 11 | 15 | 18.5 | |
| | For CT setting | 0.1 | 0.2 | 0.4 | 0.75 | 1.5 | 2.2 | 3.7 | 5.5 | 7.5 | 11 | 15 | |
| Output characteristics | Inverter capacity kVA | 200 VT | 0.4 | 0.6 | 1.2 | 2.0 | 3.3 | 4.1 | 6.7 | 10.3 | 13.8 | 19.3 | 23.9 |
| | | 200 CT | 0.2 | 0.5 | 1.0 | 1.7 | 2.7 | 3.8 | 6.0 | 8.6 | 11.4 | 16.2 | 20.7 |
| | | 240 VT | 0.4 | 0.7 | 1.4 | 2.4 | 3.9 | 4.9 | 8.1 | 12.4 | 16.6 | 23.2 | 28.6 |
| | | 240 CT | 0.3 | 0.6 | 1.2 | 2.0 | 3.3 | 4.5 | 7.2 | 10.3 | 13.7 | 19.5 | 24.9 |
| | Rated output current (A) at VT | | 1.2 | 1.9 | 3.5 | 6.0 | 9.6 | 12.0 | 19.6 | 30.0 | 40.0 | 56.0 | 69.0 |
| Rated output current (A) at CT | | 1.0 | 1.6 | 3.0 | 5.0 | 8.0 | 11.0 | 17.5 | 25.0 | 33.0 | 47.0 | 60.0 | |
| Max. output voltage | | Proportional to input voltage: 0..240 V | | | | | | | | | | | |
| Max. output frequency | | 1000 Hz ³ | | | | | | | | | | | |
| Power supply | Rated input voltage and frequency | | Single-phase 200..240 V 50/60 Hz 3-phase 200..240 V 50/60 Hz | | | | | | | | | | |
| | Allowable voltage fluctuation | | -15%..+10% | | | | | | | | | | |
| | Allowable frequency fluctuation | | 5% | | | | | | | | | | |
| Braking torque | At short-time deceleration At capacitor feedback | 100%: <50Hz 50%: <60Hz | | | | 70%: <50Hz 50%: <60Hz | | Approx 20% | | | - | | |
| | | Cooling method | | | | | Self cooling ⁴ | | | Forced-air-cooling | | | |

1. Three phase model use forced-air-cooling but single phase model is self cooling.
2. Based on a standard 3-Phase standard motor.
3. Above 400 Hz with some function limitation.
4. Forced air cooling for IP54 models

400 V class

| Three-phase: 3G3MX2-□ | | 4004 | 4007 | 4015 | 4022 | 4030 | 4040 | 4055 | 4075 | 4110 | 4150 | |
|--------------------------------|---|---|-----------------------------|------|------|--------------------------------|---------------------------|------|--------------------|------|------|------|
| Motor kW ¹ | For VT setting | 0.75 | 1.5 | 2.2 | 3.0 | 4.0 | 5.5 | 7.5 | 11 | 15 | 18.5 | |
| | For CT setting | 0.4 | 0.75 | 1.5 | 2.2 | 3.0 | 4.0 | 5.5 | 7.5 | 11 | 15 | |
| Output characteristics | Inverter capacity kVA | 380 VT | 1.3 | 2.6 | 3.5 | 4.5 | 5.7 | 7.3 | 11.5 | 15.1 | 20.4 | 25.0 |
| | | 380 CT | 1.1 | 2.2 | 3.1 | 3.6 | 4.7 | 6.0 | 9.7 | 11.8 | 15.7 | 20.4 |
| | | 480 VT | 1.7 | 3.4 | 4.4 | 5.7 | 7.3 | 9.2 | 14.5 | 19.1 | 25.7 | 31.5 |
| | | 480 CT | 1.4 | 2.8 | 3.9 | 4.5 | 5.9 | 7.6 | 12.3 | 14.9 | 19.9 | 25.7 |
| | Rated output current (A) at VT | | 2.1 | 4.1 | 5.4 | 6.9 | 8.8 | 11.1 | 17.5 | 23.0 | 31.0 | 38.0 |
| Rated output current (A) at CT | | 1.8 | 3.4 | 4.8 | 5.5 | 7.2 | 9.2 | 14.8 | 18.0 | 24.0 | 31.0 | |
| Max. output voltage | | Proportional to input voltage: 0..480 V | | | | | | | | | | |
| Max. output frequency | | 1000 Hz ² | | | | | | | | | | |
| Power supply | Rated input voltage and frequency | | 3-phase 380..480 V 50/60 Hz | | | | | | | | | |
| | Allowable voltage fluctuation | | -15%..+10% | | | | | | | | | |
| | Allowable frequency fluctuation | | 5% | | | | | | | | | |
| Braking torque | At short-time deceleration ^{*3} At capacitor feedback | 100%: <50Hz 50%: <60Hz | | | | 70%: <50Hz 50%: <60Hz | | - | | | - | |
| | | Cooling method | | | | | Self cooling ³ | | Forced-air-cooling | | | |

1. Based on a standard 3-Phase standard motor.
2. Above 400 Hz with some function limitation.
3. Forced air cooling for IP54 models

Specifications

Common specifications

| Model number 3G3MX2 | | Specifications |
|-------------------------|---|---|
| Control functions | Control methods | Phase-to-phase sinusoidal pulse with modulation PWM (Sensorless vector control, V/f) |
| | Output frequency range | 0.10..1000.00 Hz (with restrictions above 400Hz) |
| | Frequency precision | Digital set value: $\pm 0.01\%$ of the max. frequency Analogue set value: $\pm 0.2\%$ of the max. frequency (25 $\pm 10^\circ\text{C}$) |
| | Resolution of frequency set value | Digital set value: 0.01 Hz Analogue set value: 1/1000 of maximum frequency |
| | Resolution of output frequency | 0.01Hz |
| | Starting torque | 200% / 0.5 Hz |
| | Overload capability | Dual rating: Heavy duty (CT): 150% for 1 minute Normal Duty (VT): 120% for 1 minute |
| | Frequency set value | 0 to 10 VDC (10 K Ω), 4 to 20 mA (100 Ω), RS485 Modbus, Network options |
| | V/f Characteristics | Constant/ reduced torque, free V/f |
| Functionality | Inputs signals | FW (forward run command), RV (reverse run command), CF1~CF4 (multi-stage speed setting), JG (jog command), DB (external braking), SET (set second motor), 2CH (2-stage accel./decel. command), FRS (free run stop command), EXT (external trip), USP (startup function), CS (commercial power switchover), SFT (soft lock), AT (analog input selection), RS (reset), PTC (thermistor thermal protection), STA (start), STP (stop), F/R (forward/reverse), PID (PID disable), PIDC (PID reset), UP (remote control up function), DWN (remote control down function), UDC (remote control data clear), OPE (operator control), SF1~SF7 (multi-stage speed setting; bit operation), OLR (overload restriction), TL (torque limit enable), TRQ1 (torque limit changeover1), TRQ2 (torque limit changeover2), BOK (Braking confirmation), LAC (LAD cancellation), PCLR (position deviation clear), ADD (add frequency enable), F-TM (force terminal mode), ATR (permission of torque command input), KHC (Cumulative power clear), MI1~MI7 (general purpose inputs for EzSQ), AHD (analog command hold), CP1~CP3 (multistage-position switches), ORL (limit signal of zero-return), ORC (trigger signal of zero-return), SPD (speed/position changeover), GS1~GS2 (STO inputs, safety related signals), 485 (Starting communication signal), PRG (executing EzSQ program), HLD (retain output frequency), ROK (permission of run command), EB (rotation direction detection of B-phase), DISP (display limitation), OP (option control signal), NO (no function) |
| | Output signals | RUN (run signal), FA1~FA5 (frequency arrival signal), OL,OL2 (overload advance notice signal), OD (PID deviation error signal), AL (alarm signal), OTQ (over/under torque threshold), UV (under-voltage), TRQ (torque limit signal), RNT (run time expired), ONT (power ON time expired), THM (thermal warning), BRK (brake release), BER (brake error), ZS (0Hz detection), DSE (speed deviation excessive), POK (positioning completion), ODC (analog voltage input disconnection), OIdc (analog current input disconnection), FBV (PID second stage output), NDc (network disconnect detection), LOG1~LOG3 (Logic output signals), WAC (capacitor life warning), WAF (cooling fan warning), FR (starting contact), OHF (heat sink overheat warning), LOC (Low load), MO1~MO3 (general outputs for EzSQ), IRDY (inverter ready), FWR (forward operation), RVR (reverse operation), MJA (major failure), WCO (window comparator O), WCOI (window comparator OI), FREF (frequency command source), REF (run command source), SETM (second motor in operation), EDM (STO (safe torque off) performance monitor), OP (option control signal), NO (no function) |
| | Standard functions | Free-V/f, manual/automatic torque boost, output voltage gain adjustment, AVR function, reduced voltage start, motor data selection, auto-tuning, motor stabilization control, reverse running protection, simple position control, simple torque control, torque limiting, automatic carrier frequency reduction, energy saving operation, PID function, non-stop operation at instantaneous power failure, brake control, DC injection braking, dynamic braking (BRD), frequency upper and lower limiters, jump frequencies, curve accel and decel (S, U, inverted U,EL-S), 16-stage speed profile, fine adjustment of start frequency, accel and decel stop, process jogging, frequency calculation, frequency addition, 2-stage accel/decel, stop mode selection, start/end freq., analog input filter, window comparators, input terminal response time, output signal delay/hold function, rotation direction restriction, stop key selection, software lock, safe stop function, scaling function, display restriction, password function, user parameter, initialization, initial display selection, cooling fan control, warning, trip retry, frequency pull-in restart, frequency matching, overload restriction, over current restriction, DC bus voltage AVR |
| | Analogue inputs | 2 analogue inputs 0 to 10 V (10 K Ω), 4 to 20 mA (100 Ω) |
| | Pulse train input terminal | 0 to 10 V (up to 24 V), up to 32 kHz |
| | Accel/Decel times | 0.01 to 3600.0 s (line/curve selection), 2nd accel/decel setting available |
| | Display | Status indicator LED's Run, Program, Alarm, Power, Hz, Amps Digital operator: Available to monitor 32 items: frequency reference, output current, output frequency... |
| | Motor overload protection | Electronic Thermal overload relay and PTC thermistor input |
| | Instantaneous overcurrent | 200% of rated current |
| | Overload | Dual rating: Heavy duty (CT): 150% for 1 minute Normal Duty (VT): 120% for 1 minute |
| Overvoltage | 800 V for 400 V type and 400 V for 200 V type | |
| Undervoltage | 345 V for 400 V type and 172.5 V for 200 V type | |
| Momentary power loss | Following items are selectable: Alarm, decelerates to stop, decelerates to stop with DC bus controlled, restart | |
| Cooling fin overheat | Temperature monitor and error detection | |
| Stall prevention level | Stall prevention during acceleration/deceleration and constant speed | |
| Ground fault | Detection at power-on | |
| Power charge indication | On when power is supplied to the control part | |
| Ambient conditions | Degree of protection | IP20, Varnish coating on PCB & IP54 (For 3G3MX2-D□ type) |
| | Ambient humidity | 90% RH or less (without condensation) |
| | Storage temperature | -20 $^\circ\text{C}$..+65 $^\circ\text{C}$ (short-term temperature during transportation) |
| | Ambient temperature ¹ | -10 $^\circ\text{C}$ to 50 $^\circ\text{C}$ (Both the carrier frequency and output current need to be reduced over 40 $^\circ\text{C}$) |
| | Installation | Indoor (no corrosive gas, dust, etc.) |
| | Installation height | Max. 1000 m |
| Vibration | 5.9 m/s ² (0.6G), 10 to 55 Hz | |

1. Some types of 3G3MX2-D requires special derating depending on installation conditions and carrier frequency selected. Check the manual for details

Dimensions

IP20



| Voltage class | Inverter model 3G3MX2-A□ | Figure | Dimensions in mm | | | | | | | | | | | | | | | | | |
|-----------------------|-----------------------------|--------|------------------|-----|-----|-----|-----|-------|------|-----|-----|-------------|-----|-----|-----|-------|------|-----|-----|-----|
| | | | W | W1 | H | H1 | t | D | D1 | D2 | d | Weight (KG) | | | | | | | | |
| Single-phase 200 V | B001 | 1 | 68 | 56 | 128 | 118 | - | 109 | 13.5 | - | - | 1.0 | | | | | | | | |
| | B002 | 1 | | | | | | 123 | 27 | | | | 1.0 | | | | | | | |
| | B004 | 1 | | | | | | 170.5 | 55 | | | | 4.4 | 4.5 | 1.1 | | | | | |
| | B007 | 2 | | | | | | 170.5 | 55 | | | | 4.4 | 4.5 | 1.4 | | | | | |
| | B015 | 2 | | | | | | 170.5 | 55 | | | | 4.4 | 4.5 | 1.8 | | | | | |
| B022 | 2 | 170.5 | 55 | 4.4 | 4.5 | 1.8 | | | | | | | | | | | | | | |
| Three-phase 200 V | 2001 | 1 | 68 | 56 | 128 | 118 | - | 109 | 13.5 | - | - | 1.0 | | | | | | | | |
| | 2002 | 1 | | | | | | 113 | 27 | | | | 1.0 | | | | | | | |
| | 2004 | 1 | | | | | | 146 | 50 | | | | 1.1 | | | | | | | |
| | 2007 | 1 | | | | | | 170.5 | 55 | | | | 4.4 | 4.5 | 1.2 | | | | | |
| | 2015 | 2 | | | | | | 170.5 | 55 | | | | 4.4 | 4.5 | 1.6 | | | | | |
| | 2022 | 2 | | | | | | 170.5 | 55 | | | | 4.4 | 4.5 | 1.8 | | | | | |
| | 2037 | 3 | | | | | | 140 | 128 | | | | 128 | 118 | 5 | 170.5 | 55 | 4.4 | 4.5 | 2.0 |
| | 2055 | 3 | | | | | | 140 | 122 | | | | 260 | 248 | 6 | 155 | 73.3 | 6 | 6 | 3.0 |
| | 2075 | 3 | | | | | | 140 | 122 | | | | 260 | 248 | 6 | 155 | 73.3 | 6 | 6 | 3.4 |
| Three-phase 400 V | 2110 | 3 | 180 | 160 | 296 | 284 | 7 | 175 | 97 | 5 | 7 | 5.1 | | | | | | | | |
| | 2150 | 3 | 220 | 192 | 350 | 336 | 7 | 175 | 84 | 5 | 7 | 7.4 | | | | | | | | |
| | 4004 | 2 | 108 | 96 | 128 | 118 | - | 144 | 28 | - | - | 1.5 | | | | | | | | |
| | 4007 | 2 | | | | | | 171 | | | | | 1.6 | | | | | | | |
| | 4015 | 2 | | | | | | 171 | | | | | 1.8 | | | | | | | |
| | 4022 | 2 | | | | | | 171 | | | | | 1.9 | | | | | | | |
| | 4030 | 2 | 171 | 55 | 1.9 | | | | | | | | | | | | | | | |
| | 4040 | 3 | 140 | 128 | 128 | 118 | 5 | 171 | 55 | 4.4 | 4.5 | 2.1 | | | | | | | | |
| 4055 | 3 | 122 | | 260 | 248 | 6 | 155 | 73.3 | 6 | 6 | 3.5 | | | | | | | | | |
| 4075 | 3 | 122 | | 260 | 248 | 6 | 155 | 73.3 | 6 | 6 | 3.5 | | | | | | | | | |
| 4110 | 3 | 180 | | 160 | 296 | 284 | 7 | 175 | 97 | 5 | 7 | 4.7 | | | | | | | | |
| 4150 | 3 | 180 | 160 | 296 | 284 | 7 | 175 | 97 | 5 | 7 | 5.2 | | | | | | | | | |

Option board



Note: Option boards could be fitted inside the IP54 model

IP54

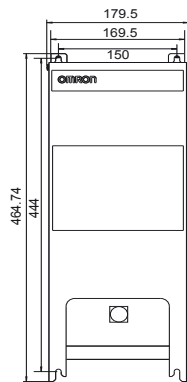

Figure 1



Figure 2

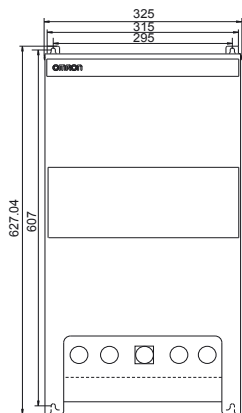
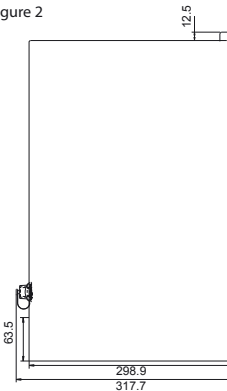

Figure 3

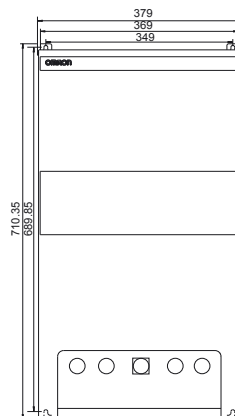
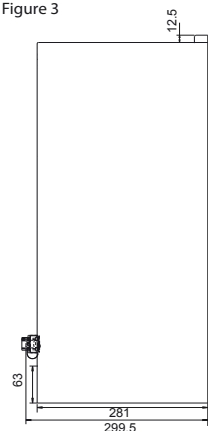
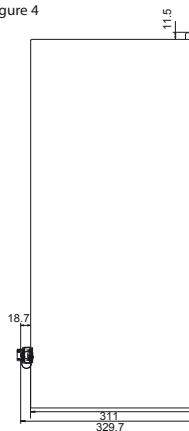

Figure 4



| Figure 1 | Figure 2 | Figure 3 | Figure 4 |
|----------------|-----------------|-----------------|-----------------|
| 3G3MX2-DB001-E | 3G3MX2-DB001-EC | 3G3MX2-D2055-EC | 3G3MX2-D2110-EC |
| 3G3MX2-DB002-E | 3G3MX2-DB002-EC | 3G3MX2-D2075-EC | 3G3MX2-D2150-EC |
| 3G3MX2-DB004-E | 3G3MX2-DB004-EC | 3G3MX2-D4055-EC | 3G3MX2-D4110-EC |
| 3G3MX2-D2001-E | 3G3MX2-DB007-EC | 3G3MX2-D4075-EC | 3G3MX2-D4150-EC |
| 3G3MX2-D2002-E | 3G3MX2-DB015-EC | | |
| 3G3MX2-D2004-E | 3G3MX2-DB022-EC | | |
| 3G3MX2-D2007-E | 3G3MX2-D2001-EC | | |
| | 3G3MX2-D2002-EC | | |
| | 3G3MX2-D2004-EC | | |
| | 3G3MX2-D2007-EC | | |
| | 3G3MX2-D2015-EC | | |
| | 3G3MX2-D2022-EC | | |
| | 3G3MX2-D2037-EC | | |
| | 3G3MX2-D4004-EC | | |
| | 3G3MX2-D4007-EC | | |
| | 3G3MX2-D4015-EC | | |
| | 3G3MX2-D4022-EC | | |
| | 3G3MX2-D4030-EC | | |
| | 3G3MX2-D4040-EC | | |

Rasmi footprint filters

| Rasmi model | | Dimensions | | | | | |
|-------------|---------------|------------|----|-----|-----|-----|----|
| | | W | H | L | X | Y | M |
| 1x200 V | AX-FIM1010-RE | 71 | 45 | 169 | 156 | 51 | M4 |
| | AX-FIM1014-RE | 111 | 50 | 169 | 156 | 91 | M4 |
| | AX-FIM1024-RE | 111 | 50 | 169 | 156 | 91 | M4 |
| 3x200 V | AX-FIM2010-RE | 82 | 50 | 194 | 181 | 62 | M4 |
| | AX-FIM2020-RE | 111 | 50 | 169 | 156 | 91 | M4 |
| | AX-FIM2030-RE | 144 | 50 | 174 | 161 | 120 | M4 |
| | AX-FIM2060-RE | 150 | 52 | 320 | 290 | 122 | M5 |
| | AX-FIM2080-RE | 188 | 62 | 362 | 330 | 160 | M5 |
| | AX-FIM2100-RE | 220 | 62 | 415 | 380 | 192 | M6 |
| 3x400 V | AX-FIM3005-RE | 114 | 46 | 169 | 156 | 91 | M4 |
| | AX-FIM3010-RE | 114 | 46 | 169 | 156 | 91 | M4 |
| | AX-FIM3014-RE | 144 | 50 | 174 | 161 | 120 | M4 |
| | AX-FIM3030-RE | 150 | 52 | 306 | 290 | 122 | M5 |
| | AX-FIM3050-RE | 182 | 62 | 357 | 330 | 160 | M5 |



Schaffner footprint filters

| Rasmi model | | Dimensions | | | | | | | |
|-------------|------------------|------------|----|-----|-----|-----|-----|-----|----|
| | | W | H | L | X | Y | A | B | M |
| 1x200 V | AX-FIM1010-SE-V1 | 70 | 40 | 166 | 156 | 51 | 150 | 50 | M5 |
| | AX-FIM1024-SE-V1 | 110 | 50 | 166 | 156 | 91 | 150 | 80 | M5 |
| 3x200 V | AX-FIM2010-SE-V1 | 80 | 40 | 191 | 181 | 62 | 150 | 50 | M5 |
| | AX-FIM2020-SE-V1 | 110 | 50 | 160 | 156 | 91 | 150 | 80 | M5 |
| | AX-FIM2030-SE-V1 | 142 | 50 | 171 | 161 | 120 | 150 | 112 | M5 |
| | AX-FIM2060-SE-V1 | 140 | 55 | 304 | 290 | 122 | 286 | 112 | M5 |
| | AX-FIM2080-SE-V1 | 180 | 55 | 344 | 330 | 160 | 323 | 140 | M5 |
| | AX-FIM2100-SE-V1 | 220 | 65 | 394 | 380 | 192 | 376 | 180 | M5 |
| 3x400 V | AX-FIM3005-SE-V1 | 110 | 50 | 166 | 156 | 91 | 150 | 80 | M5 |
| | AX-FIM3010-SE-V1 | 110 | 50 | 166 | 156 | 91 | 150 | 80 | M5 |
| | AX-FIM3014-SE-V1 | 142 | 50 | 171 | 161 | 120 | 150 | 112 | M5 |
| | AX-FIM3030-SE-V1 | 140 | 55 | 304 | 290 | 122 | 286 | 112 | M5 |
| | AX-FIM3050-SE-V1 | 180 | 55 | 344 | 330 | 160 | 323 | 140 | M5 |



Input AC Reactor

| Voltage | Reference | Dimensions | | | | | | Weight kg |
|---------|-------------------|------------|----|-----|-----|----|-----|-----------|
| | | A | B2 | C2 | D | E | F | |
| 200 V | AX-RAI02800080-DE | 120 | 70 | 120 | 80 | 52 | 5.5 | 1.78 |
| | AX-RAI00880200-DE | 120 | 80 | 120 | 80 | 62 | 5.5 | 2.35 |
| | AX-RAI00350335-DE | 180 | 85 | 190 | 140 | 55 | 6 | 5.5 |
| | AX-RAI00180670-DE | 180 | 85 | 190 | 140 | 55 | 6 | 5.5 |
| 400 V | AX-RAI07700050-DE | 120 | 70 | 120 | 80 | 52 | 5.5 | 1.78 |
| | AX-RAI03500100-DE | 120 | 80 | 120 | 80 | 62 | 5.5 | 2.35 |
| | AX-RAI01300170-DE | 120 | 80 | 120 | 80 | 62 | 5.5 | 2.50 |
| | AX-RAI00740335-DE | 180 | 85 | 190 | 140 | 55 | 6 | 5.5 |



DC Reactor

| Voltage | Reference | Dimensions | | | | | | | | Weight kg |
|---------|------------------|------------|-----|-------|-----|-----|-----|-----|------|-----------|
| | | A | B | C | D | E | F | G | H | |
| 200 V | AX-RC21400016-DE | 84 | 113 | 96 | 101 | 66 | 5 | 7.5 | 2 | 1.22 |
| | AX-RC10700032-DE | | | | | | | | | |
| | AX-RC06750061-DE | | | 105 | | | | | | |
| | AX-RC03510093-DE | | | 116 | | | | | | |
| | AX-RC02510138-DE | 108 | 135 | 124 | 120 | 82 | 6.5 | 9.5 | 3.20 | |
| | AX-RC01600223-DE | 120 | 152 | 136 | 135 | 94 | 7 | 9.5 | - | 5.20 |
| | AX-RC01110309-DE | | | 146 | | | | | | 6.00 |
| | AX-RC00840437-DE | | | 160 | | | | | | 11.4 |
| | AX-RC00590614-DE | 150 | 177 | 182.6 | 160 | 115 | - | 2 | - | 14.3 |
| | AX-RC00440859-DE | | | | | | | | | |



| Voltage | Reference | Dimensions | | | | | | | | Weight kg |
|------------------|------------------|------------|-------|-----|-----|-----|---|-----|---|-----------|
| | | A | B | C | D | E | F | G | H | |
| 400 V | AX-RC43000020-DE | 84 | 113 | 96 | 101 | 66 | 5 | 7.5 | 2 | 1.22 |
| | AX-RC27000030-DE | | | 105 | | | | | | 1.60 |
| | AX-RC14000047-DE | | | 116 | | | | | | 1.95 |
| | AX-RC10100069-DE | 120 | 152 | 133 | 135 | 94 | 7 | 9.5 | - | 3.70 |
| | AX-RC06400116-DE | | | 146 | | | | | | 6.00 |
| | AX-RC04410167-DE | 150 | 177 | 136 | 160 | 115 | 7 | 2 | - | 5.20 |
| | AX-RC03350219-DE | | | 146 | | | | | | 6.00 |
| | AX-RC02330307-DE | | | 160 | | | | | | 11.4 |
| AX-RC01750430-DE | | | 182.6 | | | | | | | 14.3 |

Output AC Reactor

| Voltage | Reference | Dimensions | | | | | | Weight kg |
|-------------------|-------------------|------------|-----|-----|-----|----|------|-----------|
| | | A | B2 | C2 | D | E | F | |
| 200 V | AX-RAO11500026-DE | 120 | 70 | 120 | 80 | 52 | 5.5 | 1.78 |
| | AX-RAO07600042-DE | 120 | 70 | 120 | 80 | 52 | 5.5 | 1.78 |
| | AX-RAO04100075-DE | 120 | 80 | 120 | 80 | 62 | 5.5 | 2.35 |
| | AX-RAO03000105-DE | 120 | 80 | 120 | 80 | 62 | 5.5 | 2.35 |
| | AX-RAO01830180-DE | 180 | 85 | 190 | 140 | 55 | 6 | 5.5 |
| | AX-RAO01150220-DE | 180 | 85 | 190 | 140 | 55 | 6 | 5.5 |
| | AX-RAO00950320-DE | 180 | 85 | 205 | 140 | 55 | 6 | 6.5 |
| | AX-RAO00630430-DE | 180 | 95 | 205 | 140 | 65 | 6 | 9.1 |
| | AX-RAO00490640-DE | 180 | 95 | 205 | 140 | 65 | 6 | 9.1 |
| 400 V | AX-RAO16300038-DE | 120 | 70 | 120 | 80 | 52 | 5.5 | 1.78 |
| | AX-RAO11800053-DE | 120 | 80 | 120 | 80 | 52 | 5.5 | 2.35 |
| | AX-RAO07300080-DE | 120 | 80 | 120 | 80 | 62 | 5.5 | 2.35 |
| | AX-RAO04600110-DE | 180 | 85 | 190 | 140 | 55 | 6 | 5.5 |
| | AX-RAO03600160-DE | 180 | 85 | 205 | 140 | 55 | 6 | 6.5 |
| | AX-RAO02500220-DE | 180 | 95 | 205 | 140 | 55 | 6 | 9.1 |
| AX-RAO02000320-DE | 180 | 105 | 205 | 140 | 85 | 6 | 11.7 | |



Chokes

| Reference | D diameter | Motor kW | Dimensions | | | | | | Weight kg |
|---------------|------------|----------|------------|----|-----|-----|----|---|-----------|
| | | | L | W | H | X | Y | m | |
| AX-FER2102-RE | 21 | < 2.2 | 85 | 22 | 46 | 70 | - | 5 | 0.1 |
| AX-FER2515-RE | 25 | < 15 | 105 | 25 | 62 | 90 | - | 5 | 0.2 |
| AX-FER5045-RE | 50 | < 45 | 150 | 50 | 110 | 125 | 30 | 5 | 0.7 |



Resistor dimensions

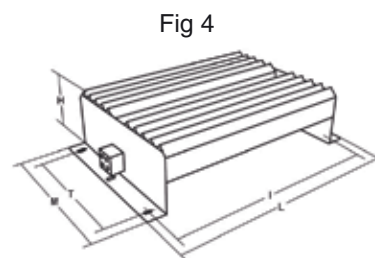
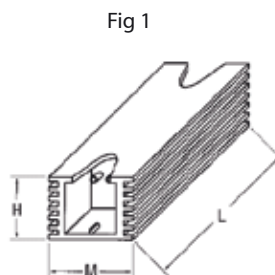

| Type | Fig. | Dimensions | | | | | Weight kg |
|------------------|------|------------|-----|-----|-----|-----|--------------|
| | | L | H | M | I | T | |
| AX-REM00K1400-IE | 1 | 105 | 27 | 36 | 94 | - | 0.2 |
| AX-REM00K2070-IE | | | | | | | |
| AX-REM00K2120-IE | | | | | | | |
| AX-REM00K2200-IE | | | | | | | |
| AX-REM00K4075-IE | | | | | | | |
| AX-REM00K4035-IE | 2 | 200 | 27 | 36 | 189 | - | 0.425 |
| AX-REM00K4030-IE | | | | | | | |
| AX-REM00K5120-IE | | | | | | | |
| AX-REM00K6100-IE | | | | | | | |
| AX-REM00K6035-IE | 3 | 320 | 27 | 36 | 309 | - | 0.73 |
| AX-REM00K9070-IE | | | | | | | |
| AX-REM00K9020-IE | | | | | | | |
| AX-REM00K9017-IE | 4 | 200 | 62 | 100 | 74 | - | 1.41 |
| AX-REM01K9070-IE | | | | | | | |
| AX-REM01K9017-IE | 4 | 365 | 73 | 105 | 350 | 70 | 4 |
| AX-REM02K1070-IE | | | | | | | |
| AX-REM02K1017-IE | | | | | | | |
| AX-REM03K5035-IE | | | | | | | |
| AX-REM03K5010-IE | 4 | 310 | 100 | 240 | 295 | 210 | 7 |
| AX-REM03K5035-IE | | | | | | | |
| AX-REM03K5010-IE | 4 | 365 | 100 | 240 | 350 | 210 | 8 |
| AX-REM03K5010-IE | | | | | | | |

Standard connections



Terminal Block Specifications

| Terminal | Name | Function (signal level) |
|------------------|------------------------------------|--|
| R/L1, S/L2, T/L3 | Main circuit power supply input | Used to connect line power to the drive. Drives with single-phase 200 V input power use only terminals R/L1 and N (T/L3), terminal S/L2 is not available for these units |
| U/T1, V/T2, W/T3 | Inverter output | Used to connect the motor |
| PD/+1, P/+ | External DC reactor terminal | Normally connected by the short-circuit bar. Remove the short-circuit bar between +1 and P/+ when a DC reactor is connected. |
| P/+, N/- | Regenerative braking unit terminal | Connect optional regenerative braking units (If a braking torque is required) |
| P/+, RB | Braking resistor terminals | Connect option braking resistor (if a braking torque is required) |
| ⊕ | Grounding | For grounding (grounding should conform to the local grounding code.) |

Control Circuit

| Type | No. | Signal name | Function | Signal level |
|------------------------|--------|---|--|--|
| Digital input signals | PLC | Intelligent input common | Source type: connecting [P24] to [1]-[7] turns inputs ON Sink type: connecting [L] to [1]-[7] turns inputs ON | - |
| | P24 | Internal 24 VDC | 24 VDC, 30mA | 24 VDC, 100 mA |
| | 1 | Multi-function Input selection 1 | Factory setting: Forward/ Stop | 27 VDC max |
| | 2 | Multi-function Input selection 2 | Factory setting: Reverse/ Stop | |
| | 3/GS1 | Multi-function Input selection 3 / safe stop input 1 | Factory setting: External trip | |
| | 4/GS2 | Multi-function Input selection 4 / safe stop input 2 | Factory setting: Reset | |
| | 5/PTC | Multi-function Input selection 5 / PTC thermistor input | Factory setting: Multi-step speed reference 1 | |
| | 6 | Multi-function input selection 6 | Factory setting: Multi-step speed reference 2 | |
| | 7/EB | Multi-function input selection 7 / Pulse train input B | Factory setting: Jog | |
| | L | Multi-function Input selection common (in upper row) | -- | |
| Pulse train | EA | Pulse train input A | Factory setting: Speed reference | 32 kHz max 5 to 24 VDC |
| | EO | Pulse train output | LAD frequency | 10 VDC 2 mA 32 kHz max |
| Analog input signal | H | Frequency reference power supply | 10 VDC 10 mA max | |
| | O | Voltage frequency reference signal | 0 to 10 VDC (10 kΩ) | |
| | OI | Current frequency reference signal | 4 to 20 mA (250 Ω) | |
| | L | Frequency reference common (bottom row) | -- | |
| Digital output signals | 11/EDM | Discrete logic output 1 / EDM output | Factory setting: During Run | 27 VDC, 50 mA max EDM based on ISO13849-1 |
| | 12 | Discrete logic output 2 | Factory setting: Frequency arrival type 1 | |
| | CM2 | GND logic output | -- | |
| | AL0 | Relay common contact | Factory setting: Alarm signal Under normal operation AL1 - AL0 Closed AL2 - AL0 Open | R load 250 VAC 2.5 A 30 VDC 3.0 A I load 250 VAC 0.2 A 30 VDC 0.7 A |
| | AL1 | Relay contact, normally open | | |
| | AL2 | Relay contact, normally closed | | |
| Monitor Signal | AM | Analog voltage output | Factory setting: LAD frequency | 0 to 10 VDC 1 mA |
| Comms | SP | Serial communication terminal | RS485 Modbus communication | |
| | SN | | | |

Side by side mounting

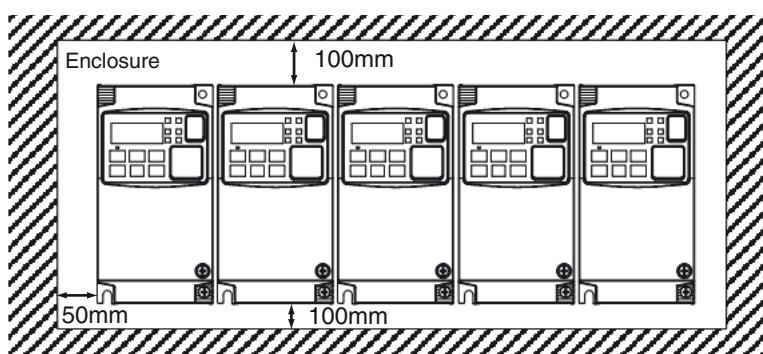

Inverter heat loss

Three-phase 200 V class

| Model 3G3MX2 | | A2001 | A2002 | A2004 | A2007 | A2015 | A2022 | A2037 | A2055 | A2075 | A2110 | A2150 |
|--------------------------|--------|--------------|-------|-------|-------|-------|--------------------|-------|-------|-------|-------|-------|
| Inverter capacity kVA | 200 VT | 0.4 | 0.6 | 1.2 | 2.0 | 3.3 | 4.1 | 6.7 | 10.3 | 13.8 | 19.3 | 23.9 |
| | 200 CT | 0.2 | 0.5 | 1.0 | 1.7 | 2.7 | 3.8 | 6.0 | 8.6 | 11.4 | 16.2 | 20.7 |
| | 240 VT | 0.4 | 0.7 | 1.4 | 2.4 | 3.9 | 4.9 | 8.1 | 12.4 | 16.6 | 23.2 | 28.6 |
| | 240 CT | 0.3 | 0.6 | 1.2 | 2.0 | 3.3 | 4.5 | 7.2 | 10.3 | 13.7 | 19.5 | 24.9 |
| Rated current (A) VT | | 1.2 | 1.9 | 3.4 | 6.0 | 9.6 | 12.0 | 19.6 | 30.0 | 40.0 | 56.0 | 69.0 |
| Rated current (A) CT | | 1.0 | 1.6 | 3.0 | 5.0 | 8.0 | 11.0 | 17.5 | 25.0 | 33.0 | 47.0 | 60.0 |
| Total heat loss | | 12 | 22 | 30 | 48 | 79 | 104 | 154 | 229 | 313 | 458 | 625 |
| Efficiency at rated load | | 89.5 | 90 | 93 | 94 | 95 | 95.5 | 96 | 96 | 96 | 96 | 96 |
| Cooling Method | | Self cooling | | | | | Forced-air-cooling | | | | | |

Single-phase 200 V class

| Model 3G3MX2 | | AB001 | AB002 | AB004 | AB007 | AB015 | AB022 |
|--------------------------|---------|--------------|-------|-------|-------|--------------------|-------|
| Inverter capacity kVA | 200V VT | 0.4 | 0.6 | 1.2 | 2.0 | 3.3 | 4.1 |
| | 200V CT | 0.2 | 0.5 | 1.0 | 1.7 | 2.7 | 3.8 |
| | 240V VT | 0.4 | 0.7 | 1.4 | 2.4 | 3.9 | 4.9 |
| | 240V CT | 0.3 | 0.6 | 1.2 | 2.0 | 3.3 | 4.5 |
| Rated current (A) VT | | 1.2 | 1.9 | 3.4 | 6.0 | 9.6 | 12.0 |
| Rated current (A) CT | | 1.0 | 1.6 | 3.0 | 5.0 | 8.0 | 11.0 |
| Total heat loss | | 12 | 22 | 30 | 48 | 79 | 104 |
| Efficiency at rated load | | 89.5 | 90 | 93 | 94 | 95 | 95.5 |
| Cooling Method | | Self cooling | | | | Forced-air-cooling | |

Three-phase 400 V class

| Model 3G3MX2 | | A4004 | A4007 | A4015 | A4022 | A4030 | A4040 | A4055 | A4075 | A4110 | A4150 |
|--------------------------|---------|--------------|-------|-------|-------|--------------------|-------|-------|-------|-------|-------|
| Inverter capacity kVA | 380V VT | 1.3 | 2.6 | 3.5 | 4.5 | 5.7 | 7.3 | 11.5 | 15.1 | 20.4 | 25.0 |
| | 380V CT | 1.1 | 2.2 | 3.1 | 3.6 | 4.7 | 6.0 | 9.7 | 11.8 | 15.7 | 20.4 |
| | 480V VT | 1.7 | 3.4 | 4.4 | 5.7 | 7.3 | 9.2 | 14.5 | 19.1 | 25.7 | 31.5 |
| | 480V CT | 1.4 | 2.8 | 3.9 | 4.5 | 5.9 | 7.6 | 12.3 | 14.9 | 19.9 | 25.7 |
| Rated current (A) VT | | 2.1 | 4.1 | 5.4 | 6.9 | 8.8 | 11.1 | 17.5 | 23.0 | 31.0 | 38.0 |
| Rated current (A) CT | | 1.8 | 3.4 | 4.8 | 5.5 | 7.2 | 9.2 | 14.8 | 18.0 | 24.0 | 31.0 |
| Total heat loss | | 35 | 56 | 96 | 116 | 125 | 167 | 229 | 296 | 411 | 528 |
| Efficiency at rated load | | 92 | 93 | 94 | 95 | 96 | 96 | 96 | 96.2 | 96.4 | 96.6 |
| Cooling Method | | Self cooling | | | | Forced-air-cooling | | | | | |

Input AC Reactor



| 3 phase 200 V class | | | | 400 V class | | | |
|---------------------------------|-------------------|-----------------|---------------|---------------------------------|-------------------|-----------------|---------------|
| Max. applicable motor output kW | Reference | Current value A | Inductance mH | Max. applicable motor output kW | Reference | Current value A | Inductance mH |
| 1.5 | AX-RAI02800080-DE | 8.0 | 2.8 | 1.5 | AX-RAI07700050-DE | 5.0 | 7.7 |
| 3.7 | AX-RAI00880200-DE | 20.0 | 0.88 | 4.0 | AX-RAI03500100-DE | 10.0 | 3.5 |
| 7.5 | AX-RAI00350335-DE | 33.5 | 0.35 | 7.5 | AX-RAI01300170-DE | 17.0 | 1.3 |
| 15 | AX-RAI00180670-DE | 67.0 | 0.18 | 15 | AX-RAI00740335-DE | 33.5 | 0.74 |

DC Reactor



| 200 V class | | | | 400 V class | | | |
|---------------------------------|------------------|-----------------|---------------|---------------------------------|------------------|-----------------|---------------|
| Max. applicable motor output kW | Reference | Current value A | Inductance mH | Max. applicable motor output kW | Reference | Current value A | Inductance mH |
| 0.2 | AX-RC21400016-DE | 1.6 | 21.4 | 0.4 | AX-RC43000020-DE | 2.0 | 43.0 |
| 0.4 | AX-RC10700032-DE | 3.2 | 10.7 | 0.7 | AX-RC27000030-DE | 3.0 | 27.0 |
| 0.7 | AX-RC06750061-DE | 6.1 | 6.75 | 1.5 | AX-RC14000047-DE | 4.7 | 14.0 |
| 1.5 | AX-RC03510093-DE | 9.3 | 3.51 | 2.2 | AX-RC10100069-DE | 6.9 | 10.1 |
| 2.2 | AX-RC02510138-DE | 13.8 | 2.51 | 3.0 | AX-RC08250093-DE | 9.3 | 8.25 |
| 3.7 | AX-RC01600223-DE | 22.3 | 1.60 | 4.0 | AX-RC06400116-DE | 11.6 | 6.40 |
| 5.5 | AX-RC01110309-DE | 30.9 | 1.11 | 5.5 | AX-RC04410167-DE | 16.7 | 4.41 |
| 7.5 | AX-RC00840437-DE | 43.7 | 0.84 | 7.5 | AX-RC03350219-DE | 21.9 | 3.35 |
| 11.0 | AX-RC00590614-DE | 61.4 | 0.59 | 11.0 | AX-RC02330307-DE | 30.7 | 2.33 |
| 15.0 | AX-RC00440859-DE | 85.9 | 0.44 | 15.0 | AX-RC01750430-DE | 43.0 | 1.75 |

Output AC Reactor

| 200 V class | | | | 400 V class | | | |
|---------------------------------|-------------------|-----------------|---------------|---------------------------------|-------------------|-----------------|---------------|
| Max. applicable motor output kW | Reference | Current value A | Inductance mH | Max. applicable motor output kW | Reference | Current value A | Inductance mH |
| 0.4 | AX-RAO11500026-DE | 2.6 | 11.50 | 1.5 | AX-RAO16300038-DE | 3.8 | 16.30 |
| 0.75 | AX-RAO07600042-DE | 4.2 | 7.60 | | | | |
| 1.5 | AX-RAO04100075-DE | 7.5 | 4.10 | | | | |
| 2.2 | AX-RAO03000105-DE | 10.5 | 3.00 | 2.2 | AX-RAO11800053-DE | 5.3 | 11.80 |
| 3.7 | AX-RAO01830160-DE | 16.0 | 1.83 | 4.0 | AX-RAO07300080-DE | 8.0 | 7.30 |
| 5.5 | AX-RAO01150220-DE | 22.0 | 1.15 | 5.5 | AX-RAO04600110-DE | 11.0 | 4.60 |
| 7.5 | AX-RAO00950320-DE | 32.0 | 0.95 | 7.5 | AX-RAO03600160-DE | 16.0 | 3.60 |
| 11 | AX-RAO00630430-DE | 43.0 | 0.63 | 11 | AX-RAO02500220-DE | 22.0 | 2.50 |
| 15 | AX-RAO00490640-DE | 64.0 | 0.49 | 15 | AX-RAO02000320-DE | 32.0 | 2.00 |

Ordering information



3G3MX2

| Voltage class | Specifications | | | | Model | |
|--------------------|-----------------|-----------------|-----------------|-----------------|-------------------|-------------------|
| | Constant torque | | Variable torque | | IP20 | IP54 |
| | Max motor kW | Rated current A | Max motor kW | Rated current A | | |
| Single-phase 200 V | 0.1 | 1.0 | 0.2 | 1.2 | 3G3MX2-AB001-E | 3G3MX2-DB001-E/EC |
| | 0.2 | 1.6 | 0.4 | 1.9 | 3G3MX2-AB002-E | 3G3MX2-DB002-E/EC |
| | 0.4 | 3.0 | 0.55 | 3.5 | 3G3MX2-AB004-E | 3G3MX2-DB004-E/EC |
| | 0.75 | 5.0 | 1.1 | 6.0 | 3G3MX2-AB007-E | 3G3MX2-DB007-E/EC |
| | 1.5 | 8.0 | 2.2 | 9.6 | 3G3MX2-AB015-E | 3G3MX2-DB015-E/EC |
| | 2.2 | 11.0 | 3.0 | 12.0 | 3G3MX2-AB022-E | 3G3MX2-DB022-E/EC |
| Three-phase 200 V | 0.1 | 1.0 | 0.2 | 1.2 | 3G3MX2-A2001-E | 3G3MX2-D2001-E/EC |
| | 0.2 | 1.6 | 0.4 | 1.9 | 3G3MX2-A2002-E | 3G3MX2-D2002-E/EC |
| | 0.4 | 3.0 | 0.55 | 3.5 | 3G3MX2-A2004-E | 3G3MX2-D2004-E/EC |
| | 0.75 | 5.0 | 1.1 | 6.0 | 3G3MX2-A2007-E | 3G3MX2-D2007-E/EC |
| | 1.5 | 8.0 | 2.2 | 9.6 | 3G3MX2-A2015-E | 3G3MX2-D2015-E/EC |
| | 2.2 | 11.0 | 3.0 | 12.0 | 3G3MX2-A2022-E | 3G3MX2-D2022-E/EC |
| | 3.7 | 17.5 | 5.5 | 19.6 | 3G3MX2-A2037-E | 3G3MX2-D2037-E/EC |
| | 5.5 | 25.0 | 7.5 | 30.0 | 3G3MX2-A2055-E | 3G3MX2-D2055-E/EC |
| | 7.5 | 33.0 | 11 | 40.0 | 3G3MX2-A2075-E | 3G3MX2-D2075-E/EC |
| 11 | 47.0 | 15 | 56.0 | 3G3MX2-A2110-E | 3G3MX2-D2110-E/EC | |
| Three-phase 400 V | 0.4 | 1.8 | 0.75 | 2.1 | 3G3MX2-A4004-E | 3G3MX2-D4004-E/EC |
| | 0.75 | 3.4 | 1.5 | 4.1 | 3G3MX2-A4007-E | 3G3MX2-D4007-E/EC |
| | 1.5 | 4.8 | 2.2 | 5.4 | 3G3MX2-A4015-E | 3G3MX2-D4015-E/EC |
| | 2.2 | 5.5 | 3.0 | 6.9 | 3G3MX2-A4022-E | 3G3MX2-D4022-E/EC |
| | 3.0 | 7.2 | 4.0 | 8.8 | 3G3MX2-A4030-E | 3G3MX2-D4030-E/EC |
| | 4.0 | 9.2 | 5.5 | 11.1 | 3G3MX2-A4040-E | 3G3MX2-D4040-E/EC |
| | 5.5 | 14.8 | 7.5 | 17.5 | 3G3MX2-A4055-E | 3G3MX2-D4055-E/EC |
| | 7.5 | 18.0 | 11 | 23.0 | 3G3MX2-A4075-E | 3G3MX2-D4075-E/EC |
| | 11 | 24.0 | 15 | 31.0 | 3G3MX2-A4110-E | 3G3MX2-D4110-E/EC |
| 15 | 31.0 | 18.5 | 38.0 | 3G3MX2-A4150-E | 3G3MX2-D4150-E/EC | |

① Line filters

| Inverter | | Line filter Rasmi | | Line filter Schaffner | |
|----------------------|-------------------------------|-------------------|-------------|-----------------------|-------------|
| Voltage | Model 3G3MX2-□ | Reference AX-FIM | Current (A) | Reference AX-FIM | Current (A) |
| 1Phase 200 VAC | AB001 / AB002 / AB004 | 1010-RE | 10 | 1010-SE-V1 | 8 |
| | AB007 | 1014-RE | 14 | 1024-SE-V1 | 27 |
| | AB015 / AB022 | 1024-RE | 24 | 1024-SE-V1 | 27 |
| | A2001 / A2002 / A2004 / A2007 | 2010-RE | 10 | 2010-SE-V1 | 7.8 |
| 3Phase 200 VAC | A2015 / A2022 | 2020-RE | 20 | 2020-SE-V1 | 16 |
| | A2037 | 2030-RE | 30 | 2030-SE-V1 | 25 |
| | A2055 / A2075 | 2060-RE | 60 | 2060-SE-V1 | 50 |
| | A2110 | 2080-RE | 80 | 2080-SE-V1 | 75 |
| 3Phase 400 VAC | A2150 | 2100-RE | 100 | 2100-SE-V1 | 100 |
| | A4004 / A4007 | 3005-RE | 5 | 3005-SE-V1 | 6 |
| | A4015 / A4022 / A4030 | 3010-RE | 10 | 3010-SE-V1 | 12 |
| | A4040 | 3014-RE | 14 | 3014-SE-V1 | 15 |
| | A4055 / A4075 | 3030-RE | 30 | 3030-SE-V1 | 29 |
| | A4110 / A4150 | 3050-RE | 50 | 3050-SE-V1 | 48 |

① Input AC reactors

| Inverter | | AC Reactor |
|-----------------|-----------------------|-------------------|
| Voltage | Model 3G3MX2-□ | Reference |
| 3-Phase 200 VAC | A2002 / A2004 / A2007 | AX-RAI02800080-DE |
| | A2015 / A2022 / A2037 | AX-RAI00880200-DE |
| | A2055 / A2075 | AX-RAI00350335-DE |
| | A2110 / A2150 | AX-RAI00180670-DE |
| 1-Phase 200 VAC | AB002 / AB004 | Under development |
| | AB007 | |
| | AB015 / AB022 | |
| 3-Phase 400 VAC | A4004 / A4007 / A4015 | AX-RAI07700050-DE |
| | A4022 / A4030 / A4040 | AX-RAI03500100-DE |
| | A4055 / A4075 | AX-RAI01300170-DE |
| | A4110 / A4150 | AX-RAI00740335-DE |

① DC reactors

| 200V single phase | | 200V 3-phase | | 400V 3-phase | |
|-------------------|------------------|--------------|------------------|--------------|------------------|
| Inverter | DC Reactor | Inverter | DC Reactor | Inverter | DC Reactor |
| 3G3MX2-AB001 | AX-RC10700032-DE | 3G3MX2-A2001 | AX-RC21400016-DE | 3G3MX2-A4004 | AX-RC43000020-DE |
| 3G3MX2-AB002 | | 3G3MX2-A2002 | | 3G3MX2-A4007 | |
| 3G3MX2-AB004 | AX-RC06750061-DE | 3G3MX2-A2004 | AX-RC10700032-DE | 3G3MX2-A4015 | AX-RC14000047-DE |
| 3G3MX2-AB007 | AX-RC03510093-DE | 3G3MX2-A2007 | AX-RC06750061-DE | 3G3MX2-A4022 | AX-RC10100069-DE |
| 3G3MX2-AB015 | AX-RC02510138-DE | 3G3MX2-A2015 | AX-RC03510093-DE | 3G3MX2-A4030 | AX-RC08250093-DE |
| 3G3MX2-AB022 | AX-RC01600223-DE | 3G3MX2-A2022 | AX-RC02510138-DE | 3G3MX2-A4040 | AX-RC06400116-DE |
| | | 3G3MX2-A2037 | AX-RC01600223-DE | 3G3MX2-A4055 | AX-RC04410167-DE |
| | | 3G3MX2-A2055 | AX-RC01110309-DE | 3G3MX2-A4075 | AX-RC03350219-DE |
| | | 3G3MX2-A2075 | AX-RC00840437-DE | 3G3MX2-A4011 | AX-RC02330307-DE |
| | | 3G3MX2-A2011 | AX-RC00590614-DE | 3G3MX2-A4015 | AX-RC01750430-DE |
| | | 3G3MX2-A2015 | AX-RC00440859-DE | | |

① Chokes

| Model | Diameter | Description |
|---------------|----------|----------------------------|
| AX-FER2102-RE | 21 | For 2.2 KW motors or below |
| AX-FER2515-RE | 25 | For 15 KW motors or below |
| AX-FER5045-RE | 50 | For 45 KW motors or below |

① Output AC reactor

| Inverter | | AC Reactor |
|----------|--|-------------------|
| Voltage | Model 3G3MX2-□ | Reference |
| 200 VAC | A2001 / A2002 / A2004 AB001 / AB002 / AB004 | AX-RAO11500026-DE |
| | A2007/AB007 | AX-RAO07600042-DE |
| | A2015 / AB015 | AX-RAO04100075-DE |
| | A2022 / AB022 | AX-RAO03000105-DE |
| | A2037 | AX-RAO01830160-DE |
| | A2055 | AX-RAO01150220-DE |
| | A2075 | AX-RAO00950320-DE |
| | A2110 | AX-RAO00630430-DE |
| 400 VAC | A2150 | AX-RAO00490640-DE |
| | A4004 / A4007 / A4015 | AX-RAO16300038-DE |
| | A4022 | AX-RAO11800053-DE |
| | A4030 / A4040 | AX-RAO07300080-DE |
| | A4055 | AX-RAO04600110-DE |
| | A4075 | AX-RAO03600160-DE |
| | A4110 | AX-RAO02500220-DE |
| A4150 | AX-RAO02000320-DE | |

② Accessories

| Types | Model | Description | Functions |
|------------------|-------------------|-------------------------------|---|
| Digital operator | AX-OP05-E | LCD remote operator | 5 Line LCD remote operator with copy function, cable length max. 3m. 3 meters cable for connecting remote operator LED remote operator, cable length max. 3m Mounting kit for LED operator on panel Holder to put the AX-OP05-E inside of the cabinet |
| | 3G3AX-CAJOP300-EE | Remote operator cable | |
| | 3G3AX-OP01 | LED remote operator | |
| | 4X-KITMINI | Mounting kit for LED operator | |
| | 3G3AX-OP05-H-E | Operator holder | |
| Accessories | AX-CUSBM002-E | PC configuration cable | Mini USB to USB connector cable |

③ Communication option boards

| Types | Model | Description | Functions |
|-----------------------|---------------|-----------------------------|--|
| Communication options | 3G3AX-MX2-PRT | Profibus option card | Used for running or stopping the inverter, setting or referencing parameters, and monitoring output frequency, output current, or similar items through communications with the host controller. |
| | 3G3AX-MX2-DRT | DeviceNet option card | |
| | 3G3AX-MX2-ECT | Ethercat option card | |
| | 3G3AX-MX2-CRT | CompoNet option card | |
| | 3G3AX-MX2-MRT | Mechatrolink II option card | |
| | 3G3AX-MX2-EIP | Ethernet IP option board | |

④ Braking unit, braking resistor unit

| Voltage | Inverter | | | | Braking resistor unit | | | | | |
|-----------------------------|---------------|------------------|---------|-------------------------------|---|---------------|------------------|---|---------------|------------------|
| | Max. motor kW | Inverter 3G3MX2□ | | Connectable min. resistance Ω | Inverter mounted type (3 %ED, 10 sec max) | | Braking torque % | Inverter mounted type (10%ED, 10 sec max) | | Braking torque % |
| | | 3-phase | 1-phase | | Type AX- | Resist Ω | | Type AX- | Resist Ω | |
| 200 V (Single-/Three-phase) | 0.12 | 2001 | B001 | 100 | REM00K1400-IE | 400 | 200 | REM00K1400-IE | 400 | 200 |
| | 0.25 | 2002 | B002 | | 180 | | | | | 180 |
| | 0.55 | 2004 | B004 | | 180 | REM00K1200-IE | 200 | 100 | REM00K1200-IE | 200 |
| | 1.1 | 2007 | B007 | 50 | REM00K2070-IE | 70 | 140 | REM00K4075-IE | 75 | 130 |
| | 1.5 | 2015 | B015 | | 90 | REM00K4035-IE | 35 | 50 | REM00K6035-IE | 35 |
| | 2.2 | 2022 | B022 | 35 | REM00K4075-IE | 75 | 75 | REM00K9020-IE | 20 | 150 |
| | 4.0 | 2040 | - | | 55 | REM00K4035-IE | 35 | 55 | REM01K9017-IE | 17 |
| | 5.5 | 2055 | - | 20 | REM00K6035-IE | 35 | 40 | REM02K1017-IE | 17 | 75 |
| | 7.5 | 2075 | - | | 55 | REM00K9017-IE | 17 | 55 | REM03K5010-IE | 10 |
| | 11 | 2110 | - | 17 | | | | | | |
| 15 | 2150 | - | 10 | | | | | | | |
| 400 V (Three-phase) | 0.55 | 4004 | - | 180 | REM00K1400-IE | 400 | 200 | REM00K1400-IE | 400 | 200 |
| | 1.1 | 4007 | - | | 200 | | | | | 200 |
| | 1.5 | 4015 | - | | 190 | REM00K1200-IE | 200 | 130 | REM00K2200-IE | 200 |
| | 2.2 | 4022 | - | 100 | REM00K2120-IE | 120 | 160 | REM00K5120-IE | 120 | 200 |
| | 3.0 | 4030 | - | | 120 | REM00K6100-IE | 100 | 140 | REM00K9070-IE | 70 |
| | 4.0 | 4040 | - | 70 | REM00K4075-IE | 75 | 100 | REM01K9070-IE | 70 | 110 |
| | 5.5 | 4055 | - | | 50 | REM00K6100-IE | 100 | 50 | REM02K1070-IE | 70 |
| | 7.5 | 4075 | - | 35 | REM00K9070-IE | 70 | 55 | REM03K5035-IE | 35 | 110 |
| | 11 | 4110 | - | | | | | | | |
| | 15 | 4150 | - | | | | | | | |

⑤ Computer software

| Types | Model | Description | Installation |
|----------|----------|-------------------|---|
| Software | CX-drive | Computer software | Configuration and monitoring software tool |
| | CX-One | Computer software | Configuration and monitoring software tool |
| | €Saver | Computer software | Software tool for Energy Saving calculation |

ALL DIMENSIONS SHOWN ARE IN MILLIMETERS.
To convert millimeters into inches, multiply by 0.03937. To convert grams into ounces, multiply by 0.03527.

OMRON EUROPE B.V. Wegalaan 67-69, NL-2132 JD, Hoofddorp, Holandia. Tel: +31 (0) 23 568 13 00 Fax: +31 (0) 23 568 13 88 industrial.omron.eu

POLSKA

OMRON ELECTRONICS Sp. z o.o.

ul. Cybernetyki 7A
Budynek LUMINAR
01-001 Warszawa
Tel. +48 22 458 66 66
Fax. +48 22 458 66 60
industrial.omron.pl

Austria

Tel: +43 (0) 2236 377 800
industrial.omron.at

Belgia

Tel: +32 (0) 2 466 24 80
industrial.omron.be

Dania

Tel: +45 43 44 00 11
industrial.omron.dk

Finlandia

Tel: +358 (0) 207 464 200
industrial.omron.fi

Francja

Tel: +33 (0) 1 56 63 70 00
industrial.omron.fr

Hiszpania

Tel: +34 913 777 900
industrial.omron.es

Holandia

Tel: +31 (0) 23 568 11 00
industrial.omron.nl

Niemcy

Tel: +49 (0) 2173 680 00
industrial.omron.de

Norwegia

Tel: +47 (0) 22 65 75 00
industrial.omron.no

Portugalia

Tel: +351 21 942 94 00
industrial.omron.pt

Republika Czeska

Tel: +420 234 602 602
industrial.omron.cz

Republika Południowej Afryki

Tel: +27 (0)11 579 2600
industrial.omron.co.za

Rosja

Tel: +7 495 648 94 50
industrial.omron.ru

Szwajcaria

Tel: +41 (0) 41 748 13 13
industrial.omron.ch

Szwecja

Tel: +46 (0) 8 632 35 00
industrial.omron.se

Turcja

Tel: +90 212 467 30 00
industrial.omron.com.tr

Węgry

Tel: +36 1 399 30 50
industrial.omron.hu

Wielka Brytania

Tel: +44 (0) 870 752 08 61
industrial.omron.co.uk

Włochy

Tel: +39 02 326 81
industrial.omron.it

Inne przedstawicielstwa

firmy Omron
industrial.omron.eu

Systemy automatyki

- Programowalne sterowniki logiczne (PLC) • Panele operatorskie (HMI) • Zdalne moduły We/Wy
- Przemysłowe komputery PC • Oprogramowanie

Sterowniki i napędy

- Kontrolery ruchu • Serwonapędy • Falowniki • Roboty

Komponenty sterujące

- Regulatory temperatury • Zasilacze • Przekazniki czasowe • Liczniki
- Przekazniki programowalne • Cyfrowe wskaźniki panelowe
- Przekazniki elektromechaniczne • Przekazniki monitorująco-kontrolne
- Przekazniki półprzewodnikowe • Wyłączniki krańcowe • Przyciski
- Niskonapięciowa aparatura przełączająca

Czujniki i urządzenia bezpieczeństwa

- Czujniki fotoelektryczne • Czujniki indukcyjne • Czujniki ciśnienia i pojemnościowe
- Kable połączeniowe • Czujniki przemieszczania i pomiaru szerokości
- Systemy wizyjne • Sieci bezpieczeństwa • Czujniki bezpieczeństwa
- Moduły bezpieczeństwa/moduły przekaznikowe • Zamki bezpieczeństwa/zamki ryglujące