

BI4U-M12-AP6X

Inductive sensor

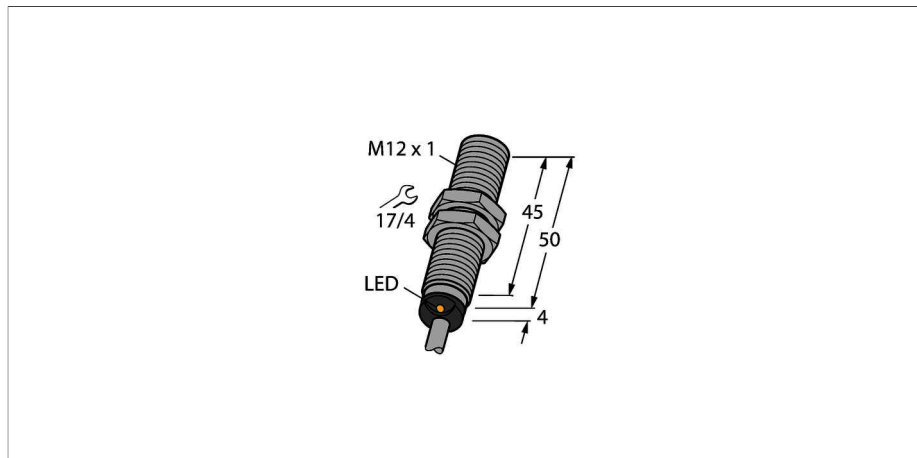

Features

- M12 x 1 threaded barrel
- Chrome-plated brass
- Factor 1 for all metals
- Protection class IP68
- Resistant to magnetic fields
- Large switching distance
- Recessed mountable
- DC 3-wire, 10...30 VDC
- NO contact, PNP output
- Cable connection

Wiring diagram

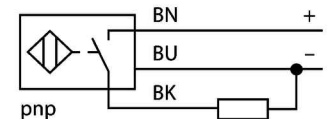

Inductive sensors detect metal objects contactless and wear-free. Due to the patented multi-coil system, *uprox*[®]+ sensors have distinct advantages over conventional sensors. They excel in largest switching distances, maximum flexibility and operational reliability as well as efficient standardization.

Technical data

Type	BI4U-M12-AP6X
ID number	1634803
Rated switching distance	4 mm
Mounting conditions	Flush
Secured operating distance	≤ (0,81 x S _n) mm
Repeat accuracy	≤ 2 % of full scale
Temperature drift	≤ ± 10 % ≤ ± 15 %, ≤ -25 °C v ≥ +70 °C
Hysteresis	3...15 %
Ambient temperature	-30...+85 °C
Operating voltage	10...30 VDC
Residual ripple	≤ 10 % U _{ss}
DC rated operational current	≤ 200 mA
No-load current	≤ 20 mA
Residual current	≤ 0.1 mA
Isolation test voltage	≤ 0.5 kV
Short-circuit protection	yes / Cyclic
Voltage drop at	≤ 1.8 V
Wire breakage/Reverse polarity protection	yes / Complete
Output function	3-wire, NO contact, PNP
Protection class	☐
Switching frequency	2 kHz
Design	Threaded barrel, M12 x 1
Dimensions	54 mm
Housing material	Metal, CuZn, Chrome-plated
Active area material	Plastic, LCP
End cap	Plastic, EPTR

Technical data

Max. tightening torque housing nut	10 Nm
Electrical connection	Cable
Cable quality	Ø 5.2 mm, LifYY, PVC, 2 m
Cable cross section	3 x 0.34 mm ²
Vibration resistance	55 Hz (1 mm)
Shock resistance	30 g (11 ms)
Protection class	IP68
MTTF	874 years acc. to SN 29500 (Ed. 99) 40 °C
Switching state	LED yellow

Mounting instructions/Description

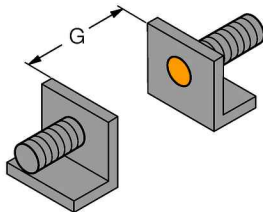
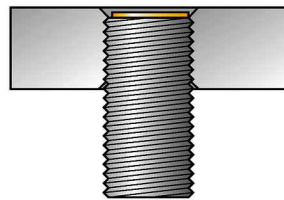
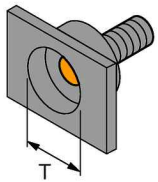

Distance D	24 mm
Distance W	3 x Sn
Distance T	3 x B
Distance S	1.5 x B
Distance G	6 x Sn
Diameter active area B	Ø 12 mm

All flush mountable *uprox*[®]+ threaded barrel types are also recessed mountable. Safe operation is ensured if the sensor is screwed in 0.5 mm.

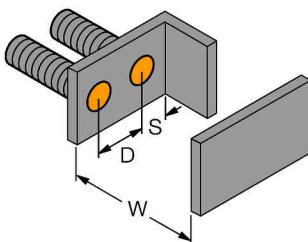

Mounting accessories

PN-M12 6905309

Impact protection nut for M12x1 threaded barrel devices; material: Stainless steel A2 1.4305 (AISI 303)

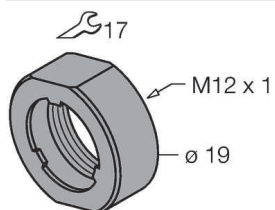

QM-12 6945101

Quick-mount bracket with dead-stop; material: Chrome-plated brass Male thread M16 x 1. Note: The switching distance of proximity switches can be reduced by the use of quick-mount brackets.

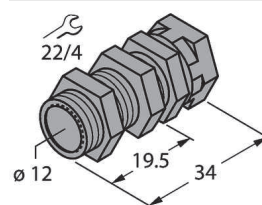

BST-12B 6947212

Fixing clamp for threaded barrel devices, with dead-stop; material: PA6

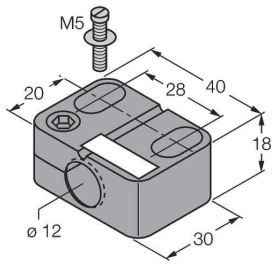

MW-12 6945003

Mounting bracket for threaded barrel devices; material: Stainless steel A2 1.4301 (AISI 304)

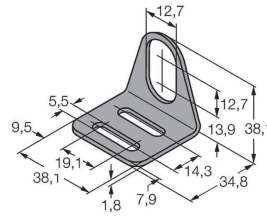

BSS-12 6901321

Mounting bracket for smooth and threaded barrel devices; material: Polypropylene

