

Altistart 46 Telemecanique

Guide d'exploitation

User's manual

Bedienungsanleitung

Guía de explotación

additif visualisation et réglage,
display and adjustment option,
Bedienmodul,
opción de visualización y ajuste,

VW3-G46101



GROUPE SCHNEIDER

■ Merlin Gerin ■ Modicon ■ Square D ■ Telemecanique

Additif visualisation et réglage

Page 2

Display and adjustment option

Page 36

Bedienmodul

Seite 70

opción de visualización y ajuste

Página 104

F
R
A
N
Ç
A
I
S

E
N
G
L
I
S
H

D
E
U
T
S
C
H

E
S
P
A
Ñ
O
L



Read this document carefully to achieve the optimum performance from the starter.

The descriptions and simplified schematics are intended for experienced personnel.

Changing the adjustments or configuration of the starter will affect its functions and performance. Ensure that any modifications carried out do not expose personnel or equipment to any risk.

Although every care has been taken in the preparation of this document, Schneider Electric SA cannot guarantee the contents and cannot be held responsible for any errors it may contain or for any damage which may result from its use or application.

The products and options described in this document may be changed or modified at any time, either from a technical point of view or in the way they are operated. Their description can in no way be considered contractual.

Contents

Technical characteristics :	38
 mounting the option on the starter	38
 mounting the option in a remote location	38
Setting up :	39 to 47
 presentation of the VW3-G46101	39
 parameter flowchart	40 to 44
 description of modes	45
 display of monitoring parameters	46
 display of configuration and adjustment parameters	46
 adjustment and configuration	47
Configuration functions	48 to 61
Adjustment functions	62 to 66
Monitoring functions	67
Maintenance assistance	68 and 69

Technical characteristics

Mounting the option on the starter

The **VW3-G46101** option can be connected while the starter is switched on.

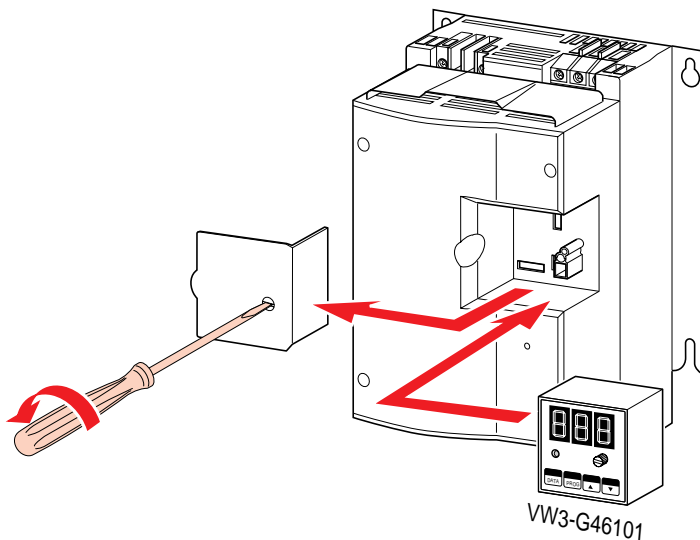

Mounting the option in a remote location

Remote mounting kit : **VW3-G46103**

In this case the option has an IP65 protection index

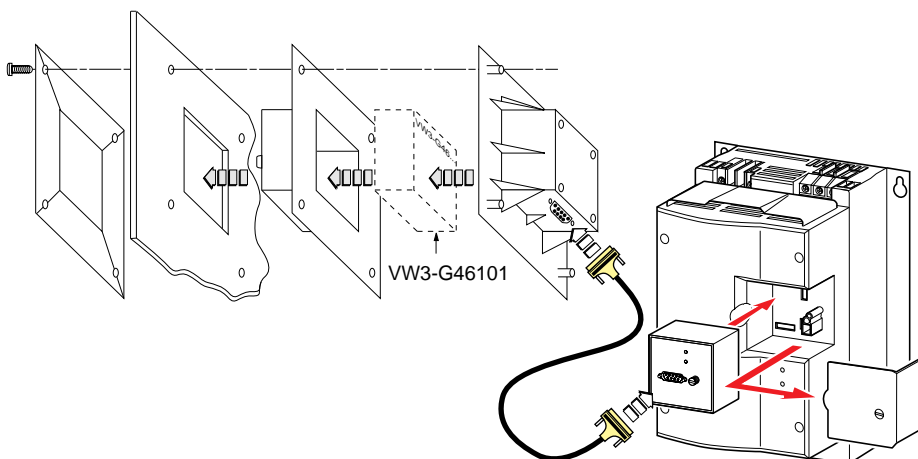

Setup

Presentation of the VW3-G46101

a) Front panel

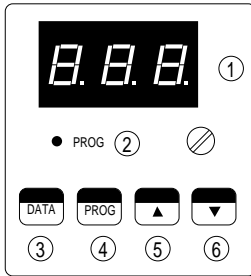

- ① 7-segment displays
- ② Programming lamp
- ③ DATA pushbutton
- ④ PROGRAMMING pushbutton
- ⑤ ▲ Up pushbutton
- ⑥ ▼ Down pushbutton

b) Rear panel

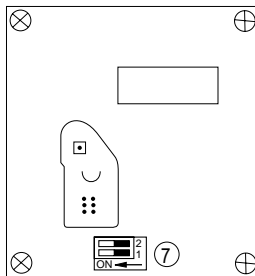

- ⑦ Switches for level 1, 2 and 3 adjustment and configuration, see page 45

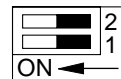

Factory setting

Description of the levels

Levels 1 and 2 are used to adjust and configure the basic product according to the application.

Level 3 is used for reconfiguring the basic product. This level is totally separate from levels 1 and 2.

Level 1 : Provides access to the basic parameters for starting and slowing down a motor for simple applications.

Level 2 : Provides additional parameters to those of level 1. These additional parameters can be accessed independently.

Level 3 : Used to reconfigure the basic product.

Example : reconfiguration of analog output AO1 from 0 - 20 mA to 4 - 20 mA.

Setup





Parameter flowchart

Level 1

The first time the option is switched on the pointer is on `rdy` for levels 1 and 2 or the display reads `nLP` if the power is not available.

Pressing **▲** positions the pointer on the `Lcr` parameter

Pressing **▼** positions the pointer on the `ln` parameter

-  Monitoring parameter
-  Adjustment parameter
-  Configuration parameter
-  Selection of stop type

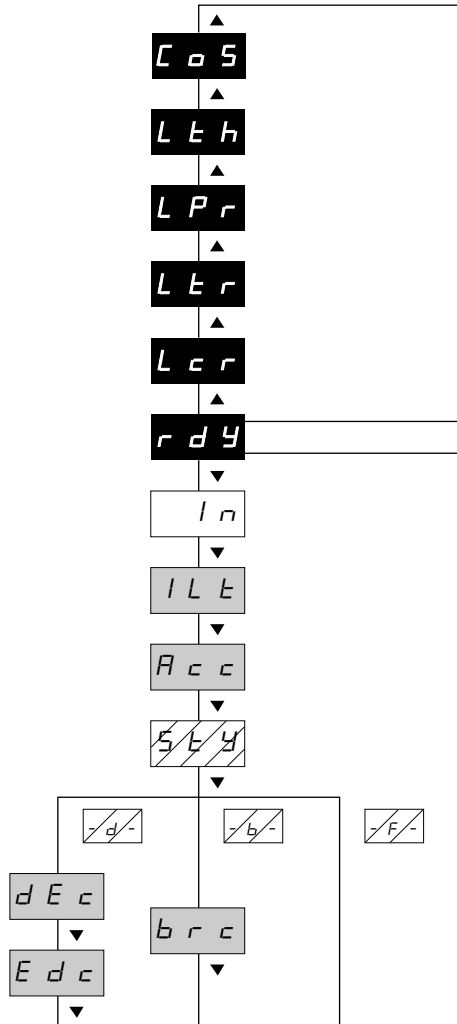

Setup

Level 2

The first time the option is switched on the pointer is on `r d y` for levels 1 and 2 or the display reads . `n L P` if the power is not available.

Pressing ▲ positions the pointer on the `L c r` parameter

Pressing ▼ positions the pointer on the `l n` parameter

- Monitoring parameter
- Adjustment parameter
- Configuration parameter
- Selection of stop type

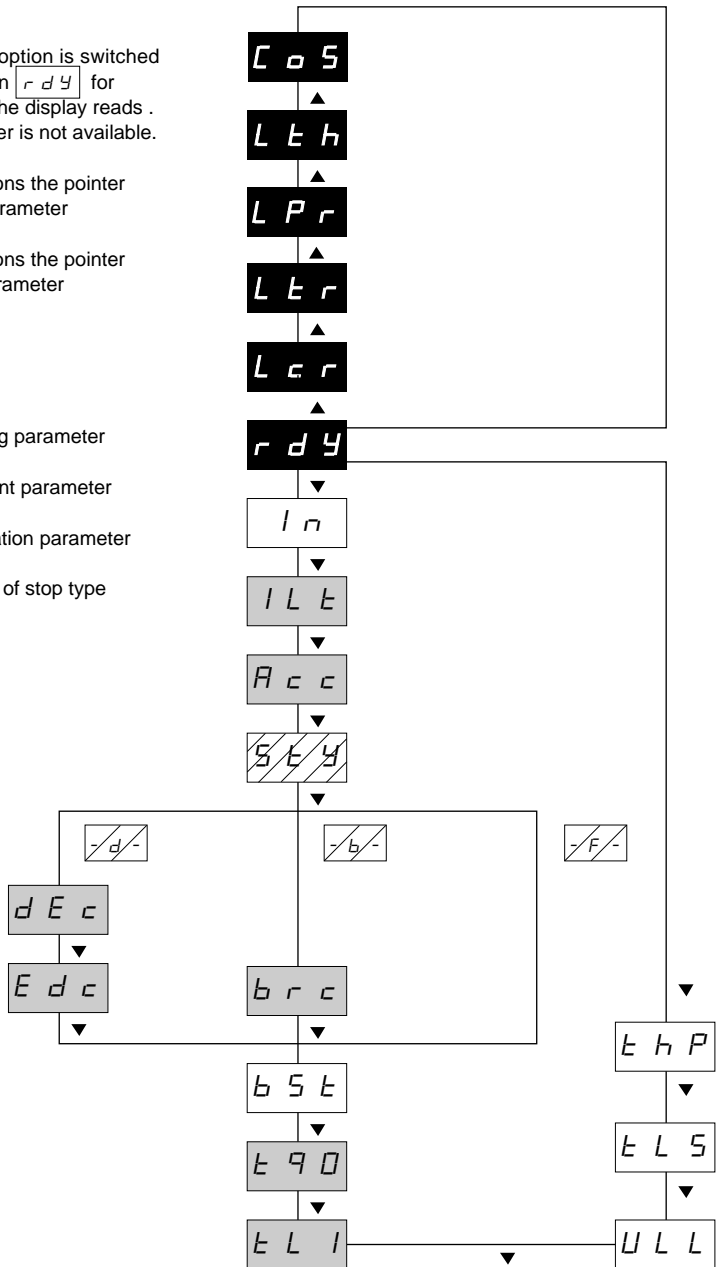

Setup

Level 3

The first time the option is switched on the pointer is on

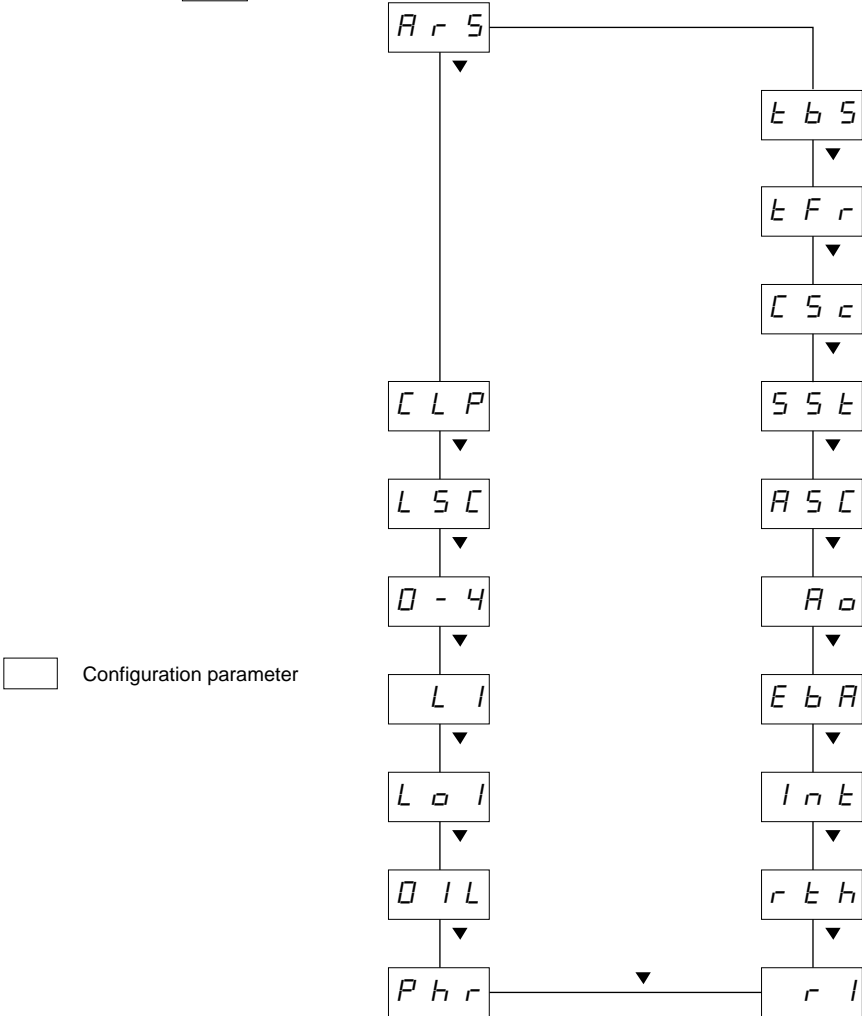

ENGLISH

Setup

Level 1 and 2 parameters

Parameter	Type	Adjustment range	Preset	Page
<input type="text" value="C o 5"/> Motor cos φ	Monitoring	0 to 1		67
<input type="text" value="L t h"/> Motor thermal state	Monitoring	0 to 250 (%)		67
<input type="text" value="L P r"/> Active motor power	Monitoring	0 to 255 (%)		67
<input type="text" value="L t r"/> Motor load state	Monitoring	0 to 250 (% of Tn*)		67
<input type="text" value="L c r"/> Motor current	Monitoring	0 to 6000 (A)		67
<input type="text" value="r d y"/> Starter state	Monitoring			67
<input type="text" value="I n"/> Motor nominal current	Configuration	(0.5 to 1.3) I _{CL} (A) (I _{CL} starter nominal current)		48
<input type="text" value="I L t"/> Motor limit current	Adjustment	150 to 700 (% of I _n) (maxi 500 % de I _{CL})	<input type="text" value="3 0 0"/>	62
<input type="text" value="P a c"/> Acceleration torque ramp	Adjustment	1 to 60 (s)	<input type="text" value="1 0"/>	62
<input type="text" value="S t y"/> Stop type	Configuration	<input type="text" value="- F -"/> <input type="text" value="- d -"/> <input type="text" value="- b -"/>	<input type="text" value="- F -"/>	49
<input type="text" value="d E c"/> Deceleration torque ramp	Adjustment	1 to 60 (s)	<input type="text" value="1 0"/>	63
<input type="text" value="E d c"/> Threshold for change to freewheel at end of deceleration	Adjustment	0 to 100 (% of Tn*)	<input type="text" value="2 0"/>	64
<input type="text" value="b r c"/> Braking torque level	Adjustment	0 to 100	<input type="text" value="5 0"/>	64
<input type="text" value="b 5 t"/> Voltage boost	Configuration	50 to 100 (% of U _n)	<input type="text" value="o F F"/>	49
<input type="text" value="t 9 0"/> Initial torque on starting	Adjustment	0 to 100 (% of Tn*)	<input type="text" value="1 0"/>	65
<input type="text" value="t L 1"/> Limitation of maximum torque during acceleration	Adjustment	10 to 200 (% of Tn*)	<input type="text" value="o F F"/>	65
<input type="text" value="U L L"/> Motor underload threshold	Configuration	20 to 100 (% of Tn*)	<input type="text" value="o F F"/>	50
<input type="text" value="t L 5"/> Start time too long	Configuration	10 to 999 (s)	<input type="text" value="o F F"/>	54
<input type="text" value="t H P"/> Motor thermal protection	Configuration	<input type="text" value="o F F"/> to <input type="text" value="3 0"/>	<input type="text" value="1 0"/>	51

Tn* : measured nominal torque.

Setup



Level 3 parameters

Parameter	Type	Adjustment range	Preset	Page
R r 5 Automatic reset	Configuration	<input type="text" value="o n"/> <input type="text" value="o F F"/>	<input type="text" value="o F F"/>	54
C L P Torque control	Configuration	<input type="text" value="o F F"/> <input type="text" value="o n"/>	<input type="text" value="o n"/>	54
L 5 c Stator loss compensation	Configuration	0 to 90 (as a %)	<input type="text" value="5 0"/>	55
0 - 4 Configuration of AO1	Configuration	<input type="text" value="0 2 0"/> <input type="text" value="4 2 0"/>	<input type="text" value="0 2 0"/>	55
L I Assignment of LI	Configuration	<input type="text" value="o F F"/> <input type="text" value="L I A"/>	<input type="text" value="L I A"/>	56
		<input type="text" value="L I E"/> <input type="text" value="L I H"/> <input type="text" value="L I L"/> <input type="text" value="L I r"/>		
		<input type="text" value="L I l"/> <input type="text" value="L I t"/> <input type="text" value="L I C"/>		
L o 1 Assignment of LO1	Configuration	<input type="text" value="o F F"/> <input type="text" value="t A 1"/> <input type="text" value="r n 1"/>	<input type="text" value="t A 1"/>	57
0 I L Current trip threshold	Adjustment	50 to 300 (% of I _n)	<input type="text" value="o F F"/>	66
P h r Detection of phase rotation	Configuration	<input type="text" value="o F F"/> <input type="text" value="1 2 3"/>	<input type="text" value="o F F"/>	57
		<input type="text" value="3 2 1"/>		
r 1 Assignment of relay R1	Configuration	<input type="text" value="r 1 F"/> <input type="text" value="r 1 l"/>	<input type="text" value="r 1 F"/>	58
r t h Reset of motor thermal state	Configuration	<input type="text" value="n 0"/> <input type="text" value="y e 5"/>	<input type="text" value="n 0"/>	58
I n t Return to factory setting	Configuration	<input type="text" value="n 0"/> <input type="text" value="y e 5"/>	<input type="text" value="n 0"/>	59
E b A Motor run-down time adjustment	Configuration	20 to 100 (as a %)	<input type="text" value="2 0"/>	59
R o Assignment of analog output AO1	Configuration	<input type="text" value="o F F"/> <input type="text" value="R c r"/>	<input type="text" value="R c r"/>	60
		<input type="text" value="R t r"/> <input type="text" value="R t h"/> <input type="text" value="R c o"/>		
R 5 c Scaling of analog output AO1	Configuration	<input type="text" value="5 0"/> <input type="text" value="5 0 0"/>	<input type="text" value="2 0 0"/>	60
S 5 t Test on low power motor	Configuration	<input type="text" value="o n"/> <input type="text" value="o F F"/>	<input type="text" value="o F F"/>	61
C 5 c Cascade-connection start	Configuration	<input type="text" value="o n"/> <input type="text" value="o F F"/>	<input type="text" value="o F F"/>	61
t F r Operating time since reset (in hour)	Configuration			61
t b 5 Time before restart	Adjustment	0 to 999 (s)	<input type="text" value="2"/>	63

E
N
G
L
I
S
H

Setup

Setup mode

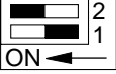
	Starter locked (switched on - no run command)	Motor operating
	Access to Level 1 Adjustment and configuration of level 1 parameters possible.	Only adjustment parameters can be modified. It is not possible to modify configuration parameters, but they can be displayed. The last parameter to be adjusted or configured remains displayed.
	Access to Level 2 Adjustment and configuration of level 2 parameters possible.	
	Access to Level 3 Adjustment and configuration of level 3 parameters possible.	

Operating mode

	Starter locked or motor operating
	Safety position Only the display is active : display of electrical operating values of a fault code. reading of adjustment values.

Setup

Displaying the monitoring parameters

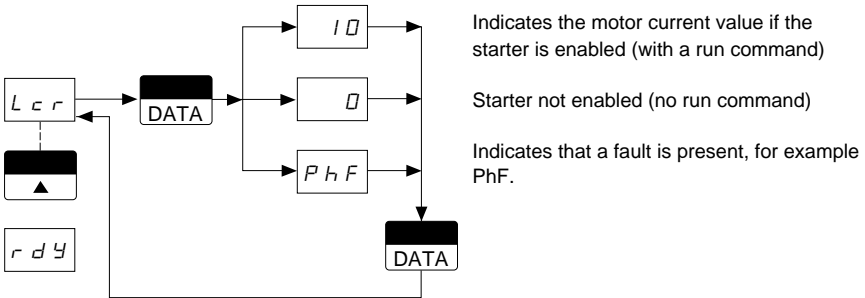

The same method is used for parameter Ltr.

For parameters Lth and CoS

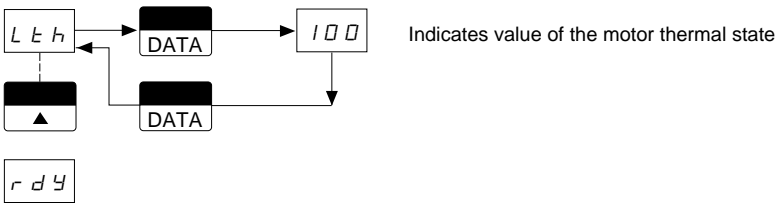

It is possible to select the parameter to be displayed each time the unit is subsequently switched on. It is selected using the **DATA** key, and only applies to parameters **Lcr**, **Ltr** and **rdY**. Using **DATA** to do this causes only the pointer to be memorized.

Displaying the configuration and adjustment parameters

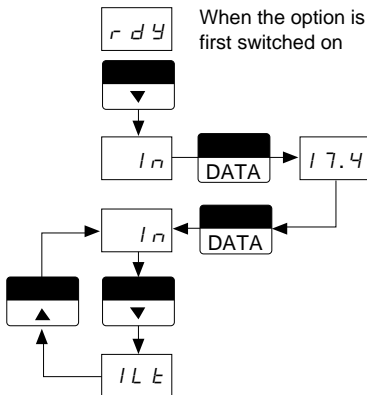

Operating mode

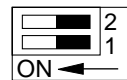

Switch at the rear of the option

Setup

Adjustment and configuration : VW3-G46101

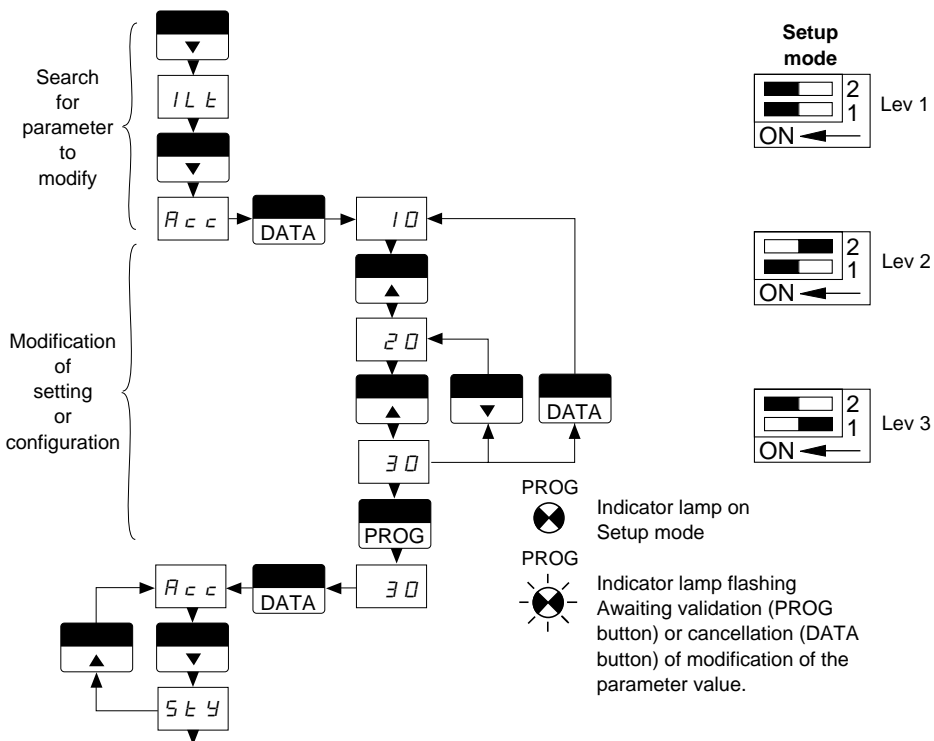

Configuration functions

I_n : Motor nominal current

This parameter is adapted according to the motor current indicated on the motor rating plate. Check that this current is between (0.5 and 1.3) I_{cL} .

(I_{cL} : Starter nominal current)

Factory setting according to the starter and the position of the switch beneath the control block flap

		normal duty	heavy duty
Rating	I_{cL} (A)	I_n (A)	I_n (A)
D17	17	15.2	11
D22	22	21	15.2
D32	32	28	21
D38	38	34	28
D47	47	42	34
D62	62	54	42
D75	75	68	54
D88	88	80	68
C11	110	98	80
C14	140	128	98
C17	170	160	128
C21	210	190	160
C25	250	236	190
C32	320	290	236
C41	410	367	290
C48	480	430	367
C59	590	547	430
C66	660	610	547
C79	790	725	610
M10	1000	880	725
M12	1200	1130	880

Configuration functions

5 E 4 : Stop type

Factory setting F

d Stop by deceleration torque control.

b Stop by dynamic braking.

F Freewheel stop.

6 5 E : Voltage boost

Factory setting F

Enables a voltage (adjustable from 50 to 100 % of motor nominal voltage) to be applied for 100 ms.

This makes it possible to increase the torque if it is too low at start-up (T_d), as a result of dry friction or a mechanical incident.

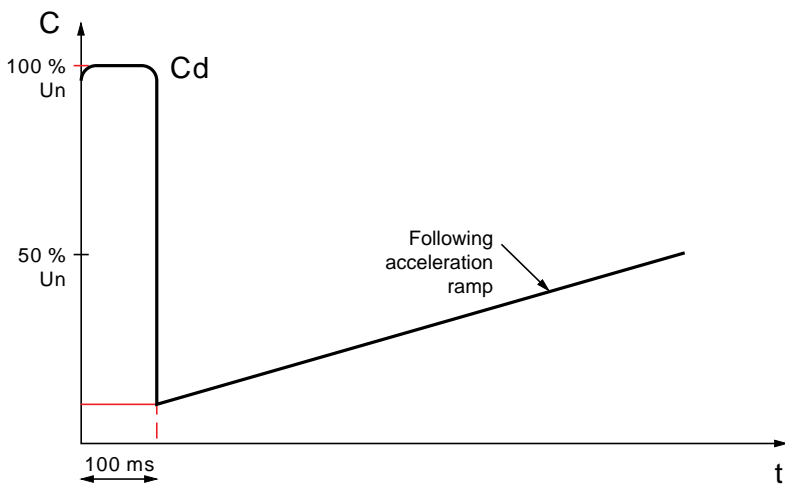

Configuration functions

ULL: Motor underload limit

Factory setting : **oFF**

Parameter adjustable from 20 to 100 % of motor load state Ltr. This function is only enabled in steady state.

The underload must last for at least 10 s (time delay). If the underload lasts for a short time and exceeds the value set at + 10% of Tn (hysteresis), the time delay is disabled.

Set at 60 % **60** (continuous underload)

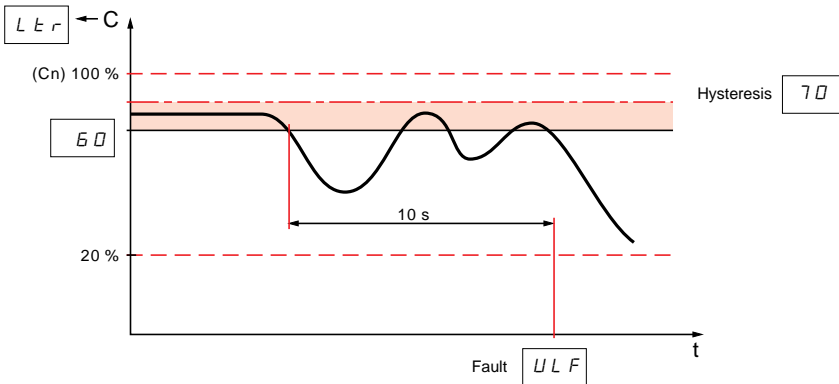

Set at 60 % **60** (underload for short period)

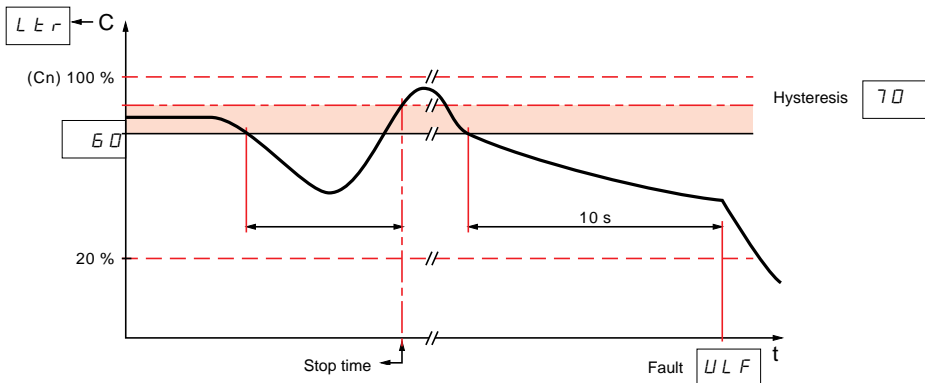

ENGLISH

Configuration functions

EHF: Motor thermal protection

Factory setting : normal duty

heavy duty

This is used to adapt the thermal protection class to the application. These classes define a cold and hot start capacity.

EHF	<input type="text" value="OFF"/>	Protection disabled
	<input type="text" value="2"/>	Subclass 2
	<input type="text" value="10A"/>	Class 10 A
	<input type="text" value="10"/>	Class 10
	<input type="text" value="15"/>	Subclass 15
	<input type="text" value="20"/>	Class 20
	<input type="text" value="25"/>	Subclass 25
	<input type="text" value="30"/>	Class 30

Configuration functions

Cold start curves

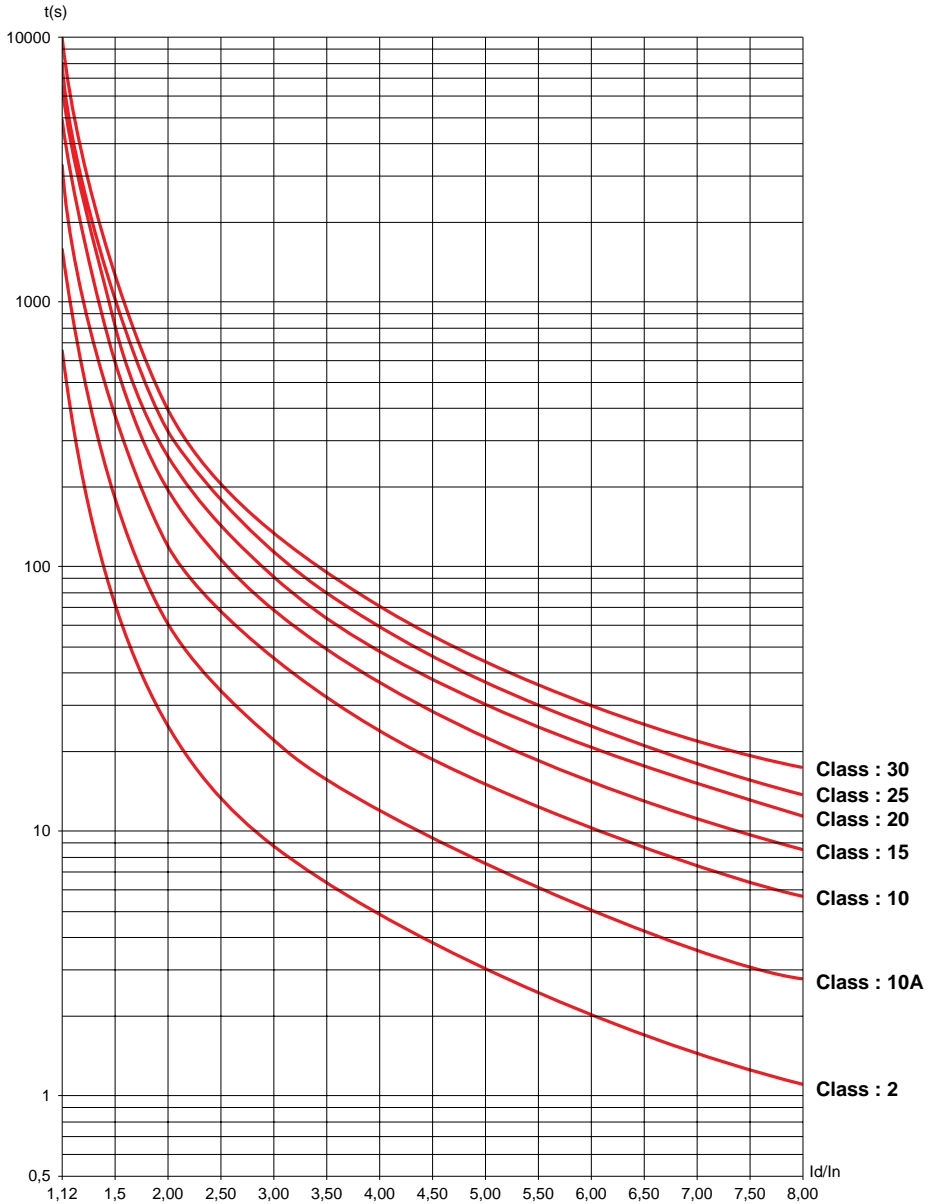

ENGLISH

Configuration functions

Hot start curves

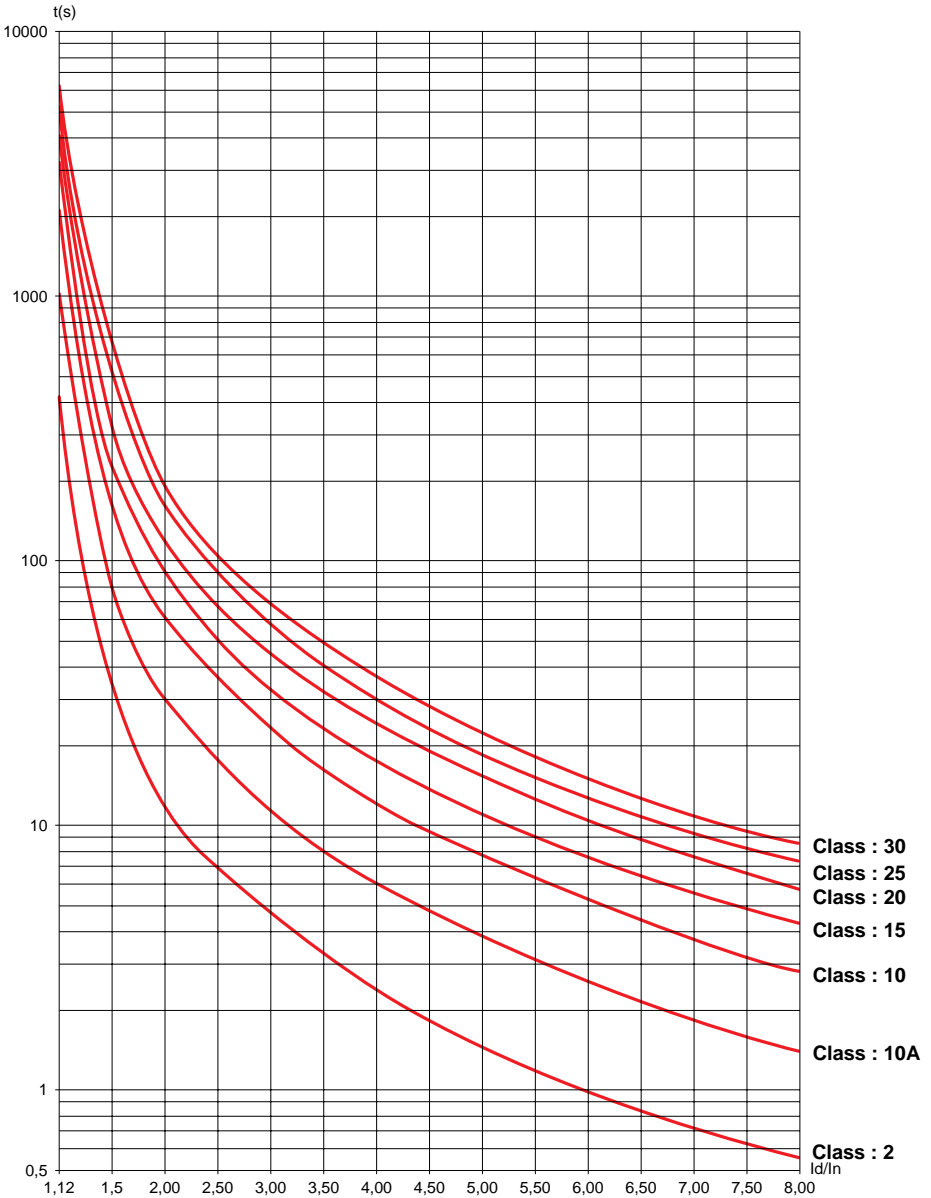

Configuration functions

ELS: Start time too long

Factory setting : FF

This is used to compare the acceleration time, before changing to steady state, and a time previously set (adjustable from 10 to 999 seconds) using ELS. This function is used to check all the modifications of the drive mechanism (mechanical incident, dry friction). If the time is exceeded, the starter changes to fault state SEF.

ArS: Automatic reset

Factory setting : FF

FF Manual reset

n Automatic reset

The starter handles 3 types of fault. The automatic reset only concerns type 1 and type 2 faults.

Type 1 fault

The option is reset by successive attempts every 60 s. If, after 6 attempts, the fault has not disappeared, it can no longer be reset.

Type 2 fault

The option is reset when the fault disappears.

Type 3 fault

The option can only be reset when there is a run request.



The ArS function can only be used in a sequence with 2-wire control.

CLP: Torque control

Factory setting : n

When turned n starting uses the torque gradient mode.

Torque control is not offered for applications using motors connected in parallel on the same starter or a motor whose power is very low in relation to the rating of the starter (using an undersized motor for maintaining the product).

In the above cases the torque loop must be open CLP = FF.

The motor is started and slowed down by varying the voltage.

Configuration functions

L 5 c : Stator loss compensation

Factory setting :

This optimizes the precision of the starting torque for constant torque applications.
Adjustable from 0 to 90 %.

0 - 4 : Configuration of output AO1

Factory setting :

Analog output AO1 is assigned to the motor current by default. This output can be configured to 0 - 20 mA or 4 - 20 mA .

Configuration functions

L I: Assignment of logic input LI

Factory setting : **L I A** Freewheel stop

L I	o F F	Not assigned
	L I A	Freewheel stop
	L I E	External fault
	L I H	Preheat motor
	L I L	Local control
	L I I	Inhibits all the safety features
	L I t	Clears the motor thermal fault
	L I C	Starts and slows in cascade
	L I r	Fault reset

L I A Force to freewheel stop

This is used to force, at a stop request, a change to freewheel stop.

L I E External fault

This enables the starter to be stopped when there is a fault external to the starter

The starter changes to fault state **E t F**.

L I H Preheat motor

If the starter is powered up, activating LIH (change to 1) supplies the motor with a current limited to 0.1 I_{CL} for preheating. When a run command is given, LIH is disabled (preheating stops).

L I L Local control

Input LIL must be assigned to local control for use with the communication option VW3-G46301.

L I I Inhibits all the safety features
Activating LII makes the product guarantee void

L I t Clears the motor thermal fault

L I C Starts and slows down 255 motors (max) in cascade (with a power ratio of 1 to 2). In this event, the motor thermal protection is inhibited and relay R1 is configured as a fault relay.

L I r Fault reset

Note : In order to avoid all errors, it is necessary to push the "Prog" button within 10 s of selecting **L I H** or **L I I**

Configuration functions

L o I: Assignment of logic output LO1

Factory setting: **L R I** Motor thermal alarm

L o I	o F F	Not assigned
	L R I	Motor thermal alarm
	r n I	Motor powered

L R I Motor thermal alarm

Changes to state 1 when there is a motor thermal overload.

r n I Motor powered

Change to state 1 when a motor current appears.

P h r: Detection of phase rotation

Factory setting: **o F F**

P h r	o F F	Not assigned
	1 2 3	Direct rotation direction
	3 2 1	Reverse rotation direction

This is used to check the direction of phase rotation in the mains supply. If the supply does not correspond to the selection, the starter changes to fault state **P I F**. This function is only activated when there is a run request, (**r u n** flashing).

Configuration functions

r l: Assignment of relay R1

Factory setting **r l F**

r l F fault relay

The fault relay de-energizes when there is a "non-resettable" type 1 or 3 fault.
The relay remains energized when there is type 2 fault.

r l l isolating relay (controls a line contactor)

The fault de-energizes when there a "non-resettable" or type 1, 2 or 3 fault.

r t h: Reset motor thermal state

Factory setting : **n 0**

n 0 No reset of motor thermal state

y e s Reset of motor thermal state

After each request to reset the motor thermal state, parameter **r t h** returns to **n 0**.

The use of this parameter must be limited to maintenance operations (changing motor, changing starter, etc).

Configuration functions

int : Return to factory setting

Factory setting :

No return to factory setting

Return to factory setting values

The parameter automatically returns to the factory setting.

EBR : Adjustment of current feed time at end of braking

Factory setting :

Sets the current feed time. Adjustable from 20 to 100 (%).

Example : Dynamic braking = 10 seconds

The stop time can vary from 2 to 10 seconds

= corresponds to an injection time of 2 s

= corresponds to an injection time of 10 s

Configuration functions

A_{\square} : Assignment of analog output AO1

Factory setting : $A_{c r}$

A_{\square}	$\square F F$	Not assigned
	$A_{c r}$	Motor current
	$A_{t r}$	Motor torque
	$A_{t h}$	Thermal state
	$A_{c \square}$	Power factor
	$A_{\square P}$	Active power

This output can be configured to 0 - 20 mA or 4 - 20 mA using the parameter $\square - 4$ and can be scaled using $A_{5 c}$

$A_{5 c}$: Scale output A_{\square}

Factory setting : 200

Adjustable from 50 to 500 % of the selected value.
20 mA corresponds to full scale.

Example : Assignment of analog output AO1 to reading the motor current at 4 - 20 mA with an output scale corresponding to 50 % of I_n .

A_{\square}	=	$A_{c r}$	motor current
$\square - 4$	=	420	output at 4 - 20 mA
$A_{5 c}$	=	50	20 mA corresponds to 50 % of I_n

SSL: Test on low power motor

Factory setting: FF

To check the starter in a test or maintenance environment without using a motor corresponding to the starter rating (especially for high-power starters), set SSL to ON in this event, PhF phase fault is inhibited and the motor is not protected. The CLP parameter (torque control) is automatically deactivated.

SSL returns to the OFF state as the control voltage is cut off. To restart in torque control mode, CLP has to be reactivated in the ON position.

CS C: Starting in cascade

Factory set: FF

Permits the starting and stopping of several motors in cascade (maximum 255).

EFR : indicates the operating time in hours since the last reset. This is only operational through the serial link.

Adjustment functions

ILt: Motor limit current

Factory setting : normal
 heavy

This is used to set the starting current, which is adjustable from 150 to 700.

This parameter is expressed as a % of In. The limit current is peak limited according to the value of In by the formula $ILt \leq 500 \times \frac{IcL}{In}$

Value peak limited to 700 for $In \leq 0.7 IcL$

Example : ATS-46D17N4

for $In = 17 A$ $ILt = 500$
 for $In = 22 A$ $ILt = 500 \times \frac{17}{22} = 386$

for $In = 8.5 A$ (the lowest adjustable value of In) $ILt = 700$ (peak limited value)

Acc: Torque ramp during acceleration

Factory setting :

This is used to adjust the acceleration torque ramp. The adjustment range is between 1 and 60 seconds, for changing from zero torque to nominal torque. This makes the start more or less gradual by modifying the torque reference slope.

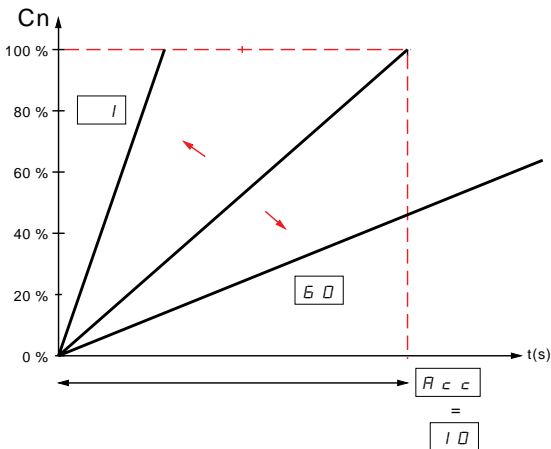

It is possible to optimize the start without modifying its gradual nature by defining an initial torque $tq0$. The torque reference can be peak limited by tLI.

Adjustment functions

$d E c$: Torque ramp during deceleration

Factory setting : 10

This is used to adjust the time taken to change from measured torque to zero torque from 1 to 60 seconds. This makes the deceleration gradual and prevents hydraulic shocks on pump applications by modifying the torque reference slope.

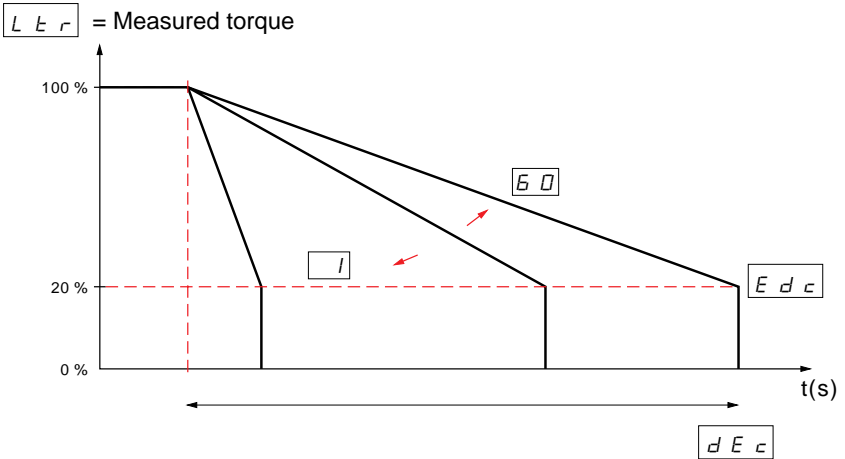

In pump type applications, it is not necessary to control deceleration below a load level set via $E d c$.

Note : If the torque $L t r$ is below 20 , that is 20 % of the measured torque, controlled deceleration is not activated, and the starter changes to freewheel stop.

$t b s$: Time before restart. (in seconds)

Factory set : 2

Minimum time between a stop command and a new start command when the stop is freewheel.

Minimum time between the end of ramp and a new start command when the stop is controlled by braking or ramp.

Adjustment functions

$E d c$: Threshold for change to freewheel at end of deceleration

Factory setting : 20

This is used to adjust the final torque level between 0 and 100 % of the motor nominal torque.

$b r c$: Braking torque level

Factory setting : 50

This is used to adjust the current level during dynamic braking, and can vary from 0 to 100. The braking time is not adjustable. It depends on the current level. The adjustment is made according to the application.

Dynamic braking is only active up to 20 % of the speed. The total stop of the motor is adjusted via **$E b A$** .

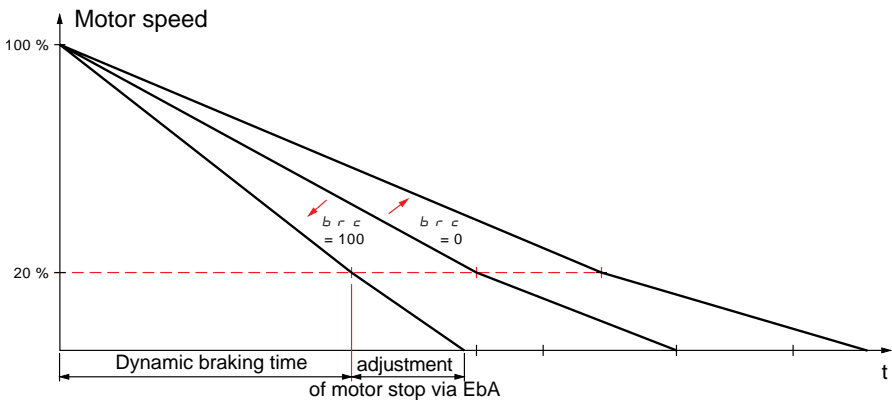

Adjustment functions

E 90: Initial torque on starting

Factory setting :

Adjustment of initial torque during the start phases. It varies from 0 to 100 % of nominal torque.

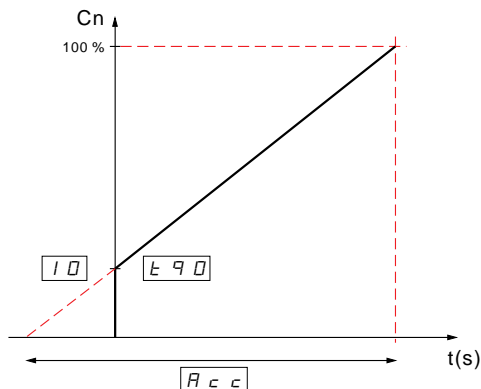

E L 1: Maximum torque limit

Factory setting :

Adjustment from 10 to 200 % of T_n .

Allows the torque reference to be clipped to avoid hypersynchronous operation on applications with a high inertia.

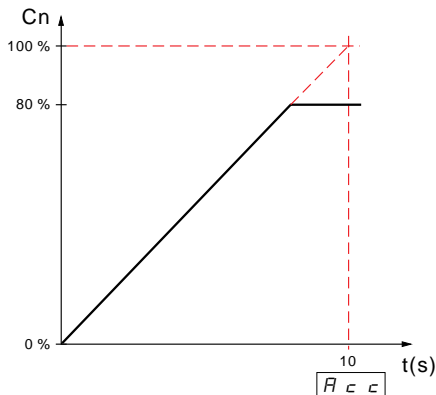

Example with

=

If $tL1 = tq0$: torque constant during acceleration.

Adjustment functions

I L : Current trip threshold

Factory setting : F F

Parameter adjustable from 50 to 300 % motor nominal current I_n .

This function is only enabled in steady state.

The overcurrent ratio to the regulated level must last a minimum of 10 s to de-energise (timer); if the overcurrent is of a short duration and returns below the 10% value of I_n (hysteresis), the timer is inhibited.

Set at 80 %

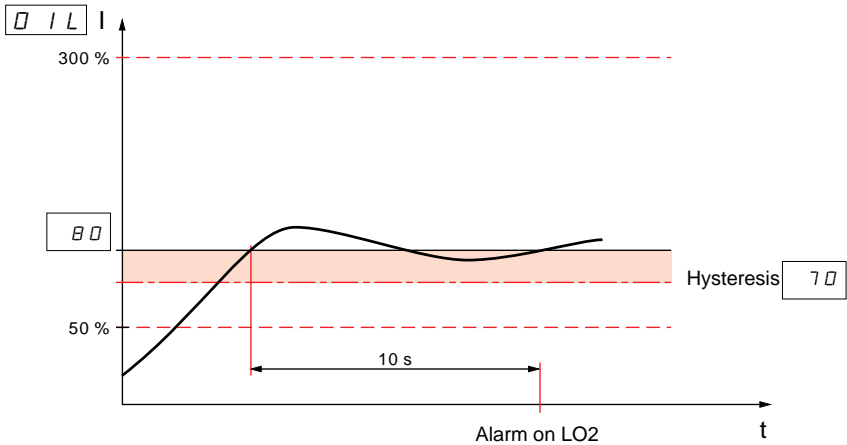

Set at 80 %

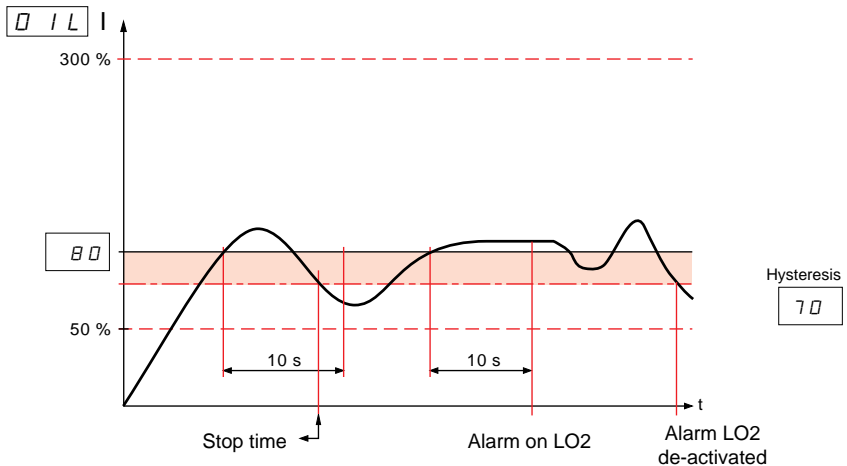

ENGLISH

Monitoring functions

rdy : **Starter state** (with no run command).

A run or stop command causes the display to change to **run** flashing during the acceleration, deceleration and braking phases. The display is steady after the acceleration phase.

The display returns to **rdy** at the end of deceleration or braking.

Note : If the power card is not supplied, the display indicates **nLP**.

Lcr : **Motor current**

For currents < 1 000 A, the display is in amp.

Example : 1.5 A - 15
20.4 A - 204
892 A - 892

For currents > 1 000 A, the display is in kiloamp.

Example : 1 233 A - 123

Ltr : **Motor load state**

As a % of Tn. Varies from 0 to 250 %.

Lth : **Motor thermal state**

From 0 to 250 %.

cos : **Motor cos φ** (power factor)

Varies from 0 to 1.

100 indicates cos φ = 1.

050 indicates cos φ = 0.5.

LPr : **Active motor power**

From 0 to 255 %.

100 indicates the power corresponding to the adjusted value of In.

Maintenance assistance

Fault codes

Code	Probable causes	Remedies	
OCF	Overcurrent - High impedance short-circuit at starter output - Internal short-circuit - Bypass contactor stuck	- Switch off the starter, check the connection cables and the motor insulation - Check the thyristors - Check the bypass contactor (contact stuck)	
INF	Recognition of rating - Internal connection fault	- Switch off the power supply and check the internal connections.	Non-resettable fault
PIF	Phase inversion Phase rotation of the mains supply does not match the selection made by Phr.	Invert two phases of the mains supply	
PHF	Phase fault - Mains supply phase failure ($t \geq 500$ ms) - Starter not supplied L1 - L2 - L3 - Blowing of fuse - Mains supply micro-break ($t \geq 200$ ms) - Mains supply subject to interference	Check : - The voltage - The upstream fuses or the circuit-breaker - The supply sequence - The connection of terminals L1 - L2 - L3	Type 1 Fault which can be automatically reset by 6 successive attempts and when the fault has disappeared in 2-wire control. After the sixth fault, the starter switches to non-resettable fault.
FRF	Frequency fault - Mains supply frequency outside limits	Check that mains supply frequency is between 50 Hz \pm 2.5 Hz (47,5 Hz - 52.5 Hz) 60 Hz \pm 3.6 Hz (56.4 Hz - 63.6 Hz)	
USF	Supply fault at a run request - Only with R1 as fault relay	Check : - The supply voltage - The upstream fuses or the circuit-breaker - The supply sequence	Type 2 Fault which can be automatically reset when the fault disappears in automatic reset position (2-wire control)

Maintenance assistance

Code	Probable causes	Remedies	
LrF	Jammed rotor fault - Detection of a steady-state current value in excess of 5 Ir ($t \geq 200$ ms)	Check - Mechanical section	The fault only exists when the Altistart is bypassed by a power relay
ULF	Motor underload - Load level below the set ULL or pump running dry - Pump with no flow	Check the hydraulic circuit	Type 3 Fault which can be reset on the request of a run command
StF	Start too long For changing to steady state, time previously set via tLS	Check the mechanism, wear, mechanical incident	
SLF	Internal serial link fault	Check the connection of A1 Check the VW3-G46101 option do not use option VW3-A16101 or 102	
EEF	External fault	Check the fault registered	
DLF	Motor thermal fault Thermal tripping caused by prolonged motor overload	Check - The duty for the thermal protection class - The current limit setting	
DHF	Starter thermal faults Thermal tripping caused by starter overload	Standby for thermal fault clearing	

