

**Accessories Multimode Relay MT**

- Snap-on mounting on DIN-rail
- Screw mounting
- Pozidrive screws with rising clamp terminals
- Logical layout of input-/output connections
- White marking area

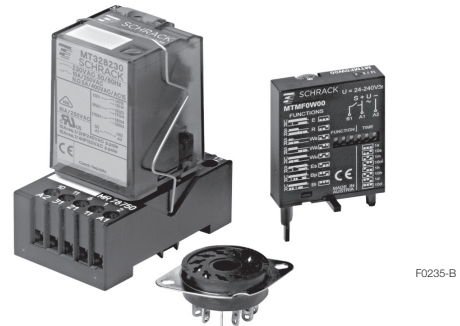

**MT DIN-rail sockets with screw-type terminals**

- MT 78 750** MT3 DIN-rail socket with screw-type terminals, 11-pin
- MT 78 755** MT2 DIN-rail socket with screw-type terminals, 8-pin

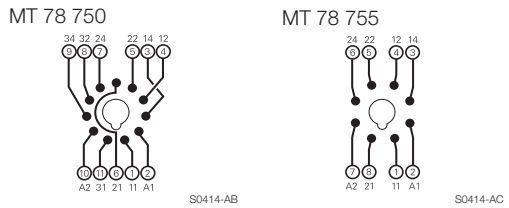
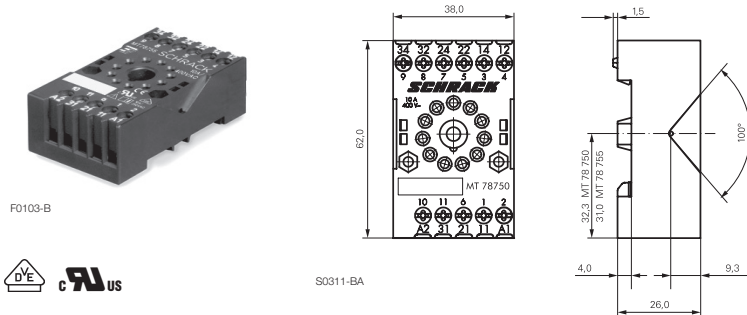

- MT78 760** MT3 DIN-rail socket with screw-type terminals, 11-pin

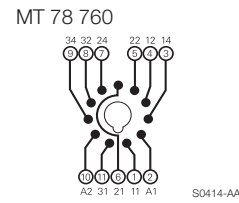
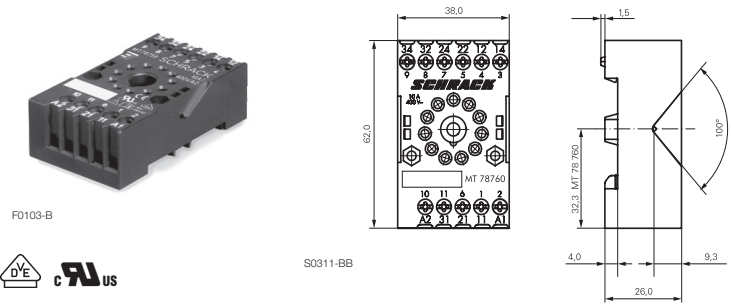

- MT 78 740** MT3 DIN-rail socket with screw-type terminals, 11-pin
- MT 78 745** MT2 DIN-rail socket with screw-type terminals, 8-pin

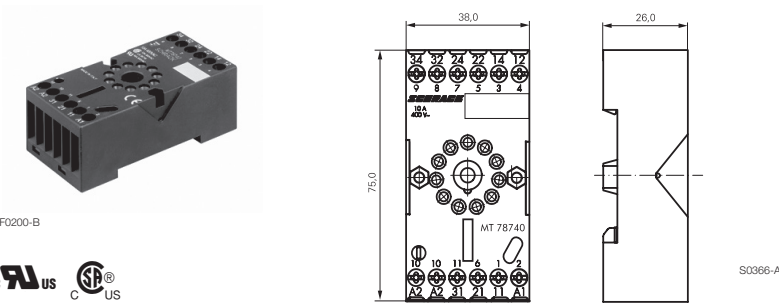

- Socket system MT 78 740 and MT 78 745
- 8/11 pin socket for MT2 / MT3
  - Double A2 screw for simple further connection of coil supply

**Accessories Multimode Relay MT (Continued)**

**Approvals**

VDE Cert. No. 40009096, cULus E135149

**Technical data MT78 750/755/760/740/745**

Rated voltage/Max. switching voltage AC	240/400 VAC
Rated current	10 A
Dielectric strength	
coil-contact circuit	2500 V <sub>rms</sub>
open contact circuit	1500 V <sub>rms</sub>
adjacent contact circuit	2500 V <sub>rms</sub>
Clearance / creepage coil-contact circuit	≥ 2.8/4 mm
Material group of insulation parts	IIIa
Insulation to IEC 60664-1	
Type of insulation coil-contact circuit	basic
open contact circuit	functional
adjacent contact circuits	basic
Rated insulation voltage	250 V
Pollution degree	2
Rated voltage system	230/400 V
Overvoltage category	III
Material compliance: EU RoHS/ELV, China RoHS, REACH, Halogen content refer to the Product Compliance Support Center at <a href="http://www.te.com/customer-support/rohssupportcenter">www.te.com/customer-support/rohssupportcenter</a>	
Ambient temperature range	-20...+80°C
Terminals	screw
Terminal screw torque acc. IEC 61984	0.5 Nm
max.	0.7 Nm
Wire cross section	
single wire	2 x 2.5 mm <sup>2</sup>
fine wire	2 x 2.5 mm <sup>2</sup>
with bootlace crimp (DIN 46228/1)	2 x 1.5 mm <sup>2</sup>
Insertion cycles	A (10)
Max. Insertion Force total	100 N
Mounting distance	≥ 0 mm, dense packing
Weight	
MT 78 750/760	54 g
MT 78 755	47 g
MT 78 740	62 g
MT 78 745	56 g
Packaging unit	25 pcs

**DIN-rail sockets with screw-type terminals**

Type	Part Number
<b>MT 78 750</b> DIN-rail socket with screw-type terminals, 11-pin	1415035-1
<b>MT 78 755</b> DIN-rail socket with screw-type terminals, 8-pin	3-1415035-1
<b>MT 78 760</b> DIN-rail socket with screw-type terminals, 11-pin	8-1415034-1
<b>MT 78 740</b> DIN-rail socket with screw-type terminals, 11-pin	8-1393163-3
<b>MT 78 745</b> DIN-rail socket with screw-type terminals, 8-pin	8-1393163-4

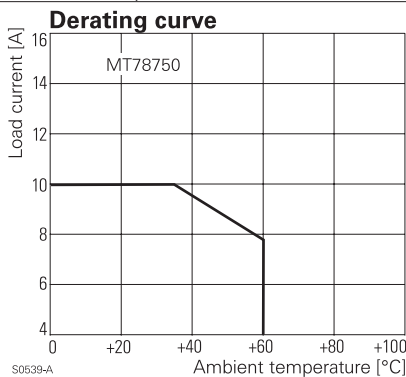

**Accessories for MT 78 750, MT 78 755, MT 78 760, MT 78 740, MT 78 745**

Type	Part Number
<b>MT 28 800</b> Metal retaining clip MT	8-1393163-0

**LED and Protection modules for MT 78 740, MT 78 745**

Type	Part Number
<b>MTM TO 0A0</b> Protection diode 1N4007 (A1+, A2-)	7-1393163-6
<b>MTM U0 730</b> RC-network 110...230 VAC	7-1393163-8
<b>MTM LO 024</b> red LED 24 VAC / VDC	7-1393163-4



F0201-B

**Function modules for MT 78 740, MT 78 745**

Type	Part Number
<b>MTM ZO W00</b> Delay ON	7-1393163-9
<b>MTM FO W00</b> Multifunction	7-1393163-3



F0203-B



F0204-B

**Technical data - Function modules**

Nominal voltage	24...240 VDC / VAC
Mains frequency	48...63 Hz
Precision of time setting	+ 0.5 %
Readiness for repetition	≤ 0.5 % or 5 ms
Influence of temperature	≤ 0.1 %/°C
Time range switchable	0.05s...240h in 8 ranges
Material compliance: EU RoHS/ELV, China RoHS, REACH, Halogen content refer to the Product Compliance Support Center at <a href="http://www.te.com/customer-support/rohssupportcenter">www.te.com/customer-support/rohssupportcenter</a>	
Ambient temperature range	-25...+55°C

**Accessories Multimode Relay MT (Continued)**

**Function modules for MT 78 740, MT 78 745**

Function Delay ON	
Delay OFF	
single shot leading edge	
single shot trailing edge	
Delay ON triggered by signal contact	
single shot	
flasher starting with pause	
flasher starting with pulse	

**MT Sockets for PCB and with solder terminals  
MT 78 602/603/612/613**

**MT 78 612** Socket 8-pin with solder terminals

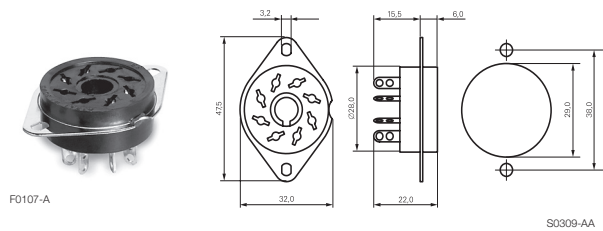

**MT 78 613** Socket 11-pin with solder terminals

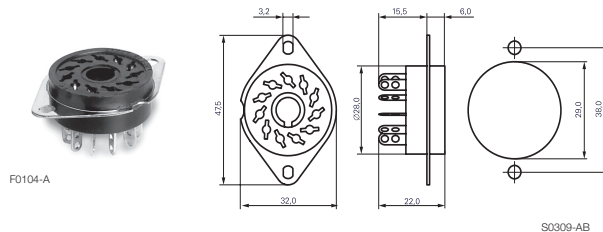

**MT Sockets for PCB and with solder terminals**

**MT 78 602/603/612/613 (continued)**

**MT 78 602** Socket 8-pin with PCB terminals

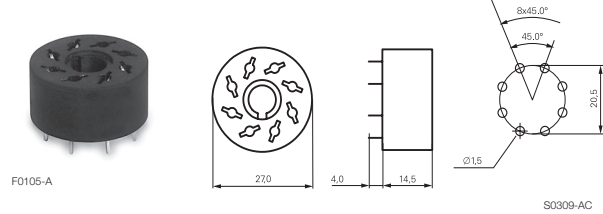

**MT 78 603** Socket 11-pin with PCB terminals

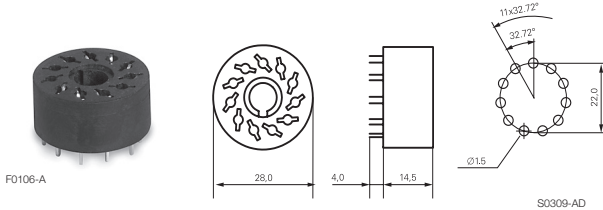

**Technical data MT78 602/603/612/613**

Rated voltage/Max. switching voltage AC	240/400 VAC
Rated current	10 A
Dielectric strength	
coil-contact circuit	2500 V <sub>rms</sub>
open contact circuit	1500 V <sub>rms</sub>
adjacent contact circuits	2500 V <sub>rms</sub>
Clearance / creepage coil-contact circuit	≥ 2.8/4 mm
Material group of insulation parts	IIIa
Insulation to IEC 60664-1	
Type of insulation coil-contact circuit	basic
open contact circuit	functional
adjacent contact circuits	basic
Rated insulation voltage	250 V
Pollution degree	2
Rated voltage system	230/400 V
Overvoltage category	III

Material compliance: EU RoHS/ELV, China RoHS, REACH, Halogen content refer to the Product Compliance Support Center at [www.te.com/customer-support/rohssupportcenter](http://www.te.com/customer-support/rohssupportcenter)

Ambient temperature range	-40...+70°C
Terminals	pcb, solder terminals
Insertion cycles	A (10)
Max. Insertion Force total	100 N
Mounting distance	≥ 0 mm, dense packing
Resistance to soldering heat	270°C/10s
Weight	7 g
Packaging unit	25 pcs

**Sockets with solder and PCB terminals**

Type	Part Number
<b>MT 78 612</b> Socket 8-pin with solder terminals	7-1415043-1
<b>MT 78 613</b> Socket 11-pin with solder terminals	8-1415043-1
<b>MT 78 602</b> Socket 8-pin with PCB terminals	9-1415043-1
<b>MT 78 603</b> Socket 11-pin with PCB terminals	1415044-1