

Photomicrosensor (Transmissive) EE-SX1235A-P2

⚠ Be sure to read *Precautions* on page 25.

■ Dimensions

Note: All units are in millimeters unless otherwise indicated.

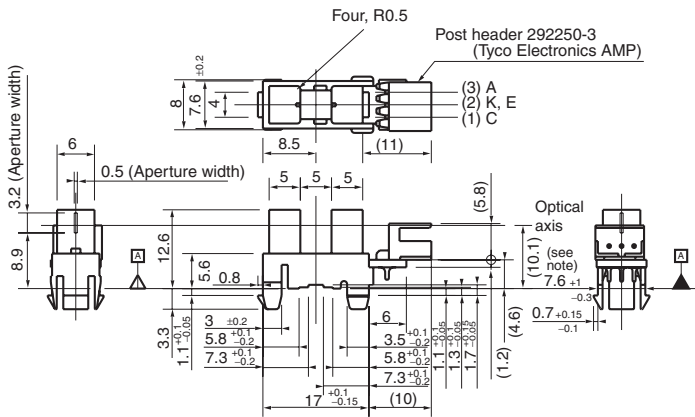

Internal Circuit

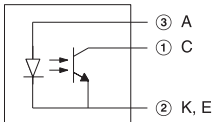

Note: The asterisked dimension is specified by datum A only.

Unless otherwise specified, the tolerances are as shown below.

Dimensions	Tolerance
3 mm max.	±0.3
3 < mm ≤ 6	±0.375
6 < mm ≤ 10	±0.45
10 < mm ≤ 18	±0.55
18 < mm ≤ 30	±0.65

Terminal No.	Name
A	Anode
C	Collector
K, E	Cathode, Emitter

Recommended Mating Connectors:
 Tyco Electronics AMP 173977-3 (press-fit connector)
 175778-3 (crimp connector)
 179228-3 (crimp connector)

■ Features

- Snap-in mounting model.
- Mounts to 1.0-, 1.2- and 1.6-mm-thick PCBs.
- High resolution with a 0.5-mm-wide aperture.
- 5-mm-wide slot.
- Connects to Tyco Electronics AMP's CT-series connectors.

■ Absolute Maximum Ratings (Ta = 25°C)

Item	Symbol	Rated value
Emitter	Forward current	I _F 50 mA (see note)
	Pulse forward current	I _{FP} ---
	Reverse voltage	V _R 4 V
Detector	Collector-Emitter voltage	V _{CEO} 30 V
	Emitter-Collector voltage	V _{ECO} 5 V
	Collector current	I _C 20 mA
	Collector dissipation	P _C 100 mW (see note)
Ambient temperature	Operating	T _{opr} -25°C to 95°C
	Storage	T _{stg} -40°C to 100°C
Soldering temperature	T _{sol}	---

Note: Refer to the temperature rating chart if the ambient temperature exceeds 25°C.

■ Electrical and Optical Characteristics (Ta = 25°C)

Item	Symbol	Value	Condition
Emitter	Forward voltage	V _F 1.2 V typ., 1.5 V max.	I _F = 30 mA
	Reverse current	I _R 0.01 μA typ., 10 μA max.	V _R = 4 V
	Peak emission wavelength	λ _p 940 nm typ.	I _F = 30 mA
Detector	Light current	I _L 0.6 mA min., 14 mA max.	I _F = 20 mA, V _{CE} = 5 V
	Dark current	I _D 200 nA max.	V _{CE} = 10 V, 0 lx
	Leakage current	I _{LEAK} ---	---
	Collector-Emitter saturated voltage	V _{CE (sat)} 0.1 V typ., 0.4 V max.	I _F = 20 mA, I _L = 0.3 mA
	Peak spectral sensitivity wavelength	λ _p 850 nm typ.	V _{CE} = 5 V
Rising time	t _r	8 μs typ.	V _{CC} = 5 V, R _L = 100 Ω, I _L = 1 mA
Falling time	t _f	8 μs typ.	V _{CC} = 5 V, R _L = 100 Ω, I _L = 1 mA

Engineering Data

Forward Current vs. Collector Dissipation Temperature Rating

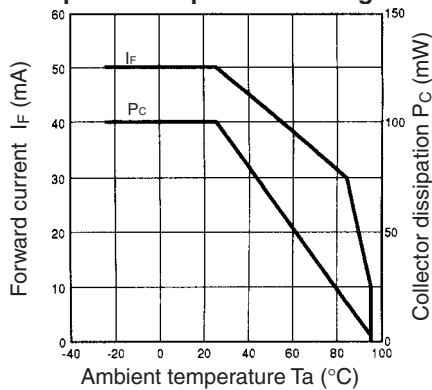

Forward Current vs. Forward Voltage Characteristics (Typical)

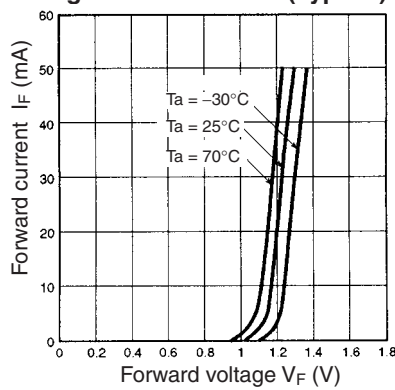

Light Current vs. Forward Current Characteristics (Typical)

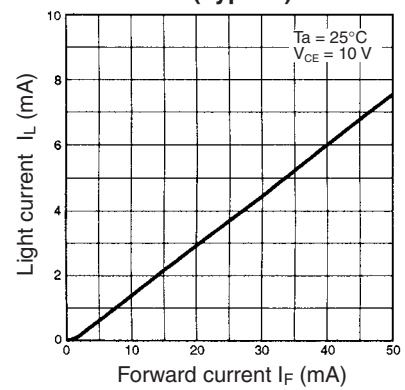

Light Current vs. Collector-Emitter Voltage Characteristics (Typical)

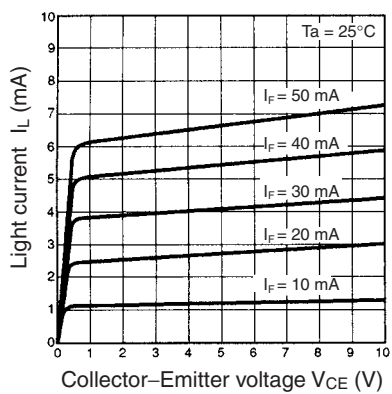

Relative Light Current vs. Ambient Temperature Characteristics (Typical)

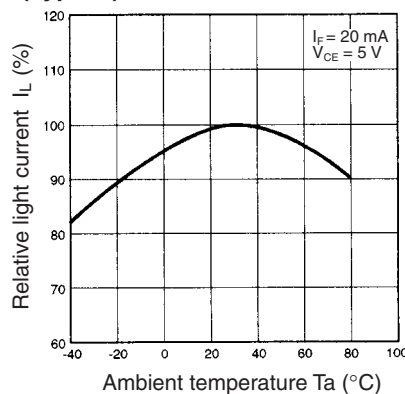

Dark Current vs. Ambient Temperature Characteristics (Typical)

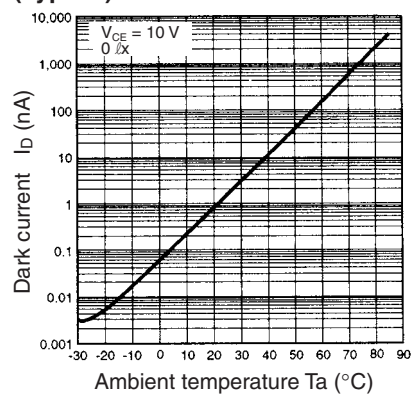

Response Time vs. Load Resistance Characteristics (Typical)

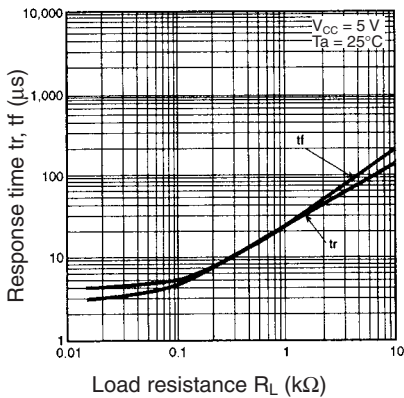

Sensing Position Characteristics (Typical)

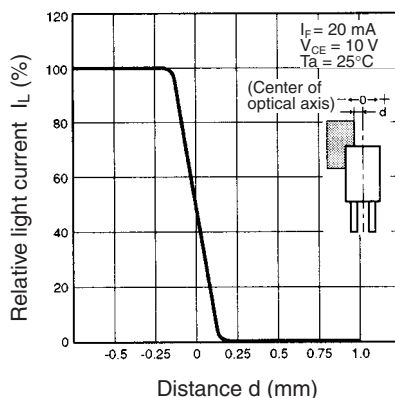

Sensing Position Characteristics (Typical)

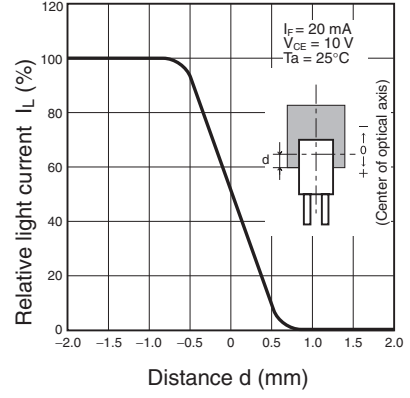

Response Time Measurement Circuit

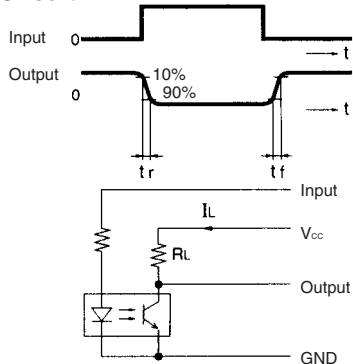

Refer to EE-SX4235A-P2 on page 140.