

RR Series — General Purpose Power Relays

Key features of the RR series include:

- High reliability and long service life
- Available in octal (8- and 11-pin) or square (11-blade) base
- Options include check button for test operation, indicator light, and side flange (contact IDEC for diodes)
- DIN rail, surface and panel type sockets available for a wide range of mounting applications



UL Recognized
File No. E66043



CSA Certified
File No. LR35144



File No. B020813332452*
* Pin Style Only
(does not apply to blade style)



* Pin Style Only

Contact Material	Silver
Contact Resistance	30mΩ maximum (initial value)
Minimum Applicable Load	24V DC/10mA, 5V DC/20mA (reference value)
Operating Time	25ms maximum
Release Time	25ms maximum
Maximum Continuous Applied Voltage (AC/DC) at 20°C	110% of the rated voltage
Minimum Operating Voltage (AC/DC) at 20°C	80% of the rated voltage
Drop-Out Voltage (AC) at 20°C	30% of the rated voltage
Drop-Out Voltage (DC) at 20°C	15% of the rated voltage
Power Consumption	AC: approximately 3VA (50Hz), 2.5VA (60Hz) DC: approximately 1.5W
Insulation Resistance	100MΩ minimum (measured with 500V DC megger)
Dielectric Strength	Pin (RR2P, RR3PA) Between live and dead parts: 1,500V AC, 1 minute Between contact circuit and operating coil: 1,500V AC, 1 minute Between contact circuits: 1,500V AC, 1 minute (1,000V AC between NO-NC contacts) Blade (RR1BA, RR2BA, RR3B) Between live and dead parts: 2,000V AC, 1 minute Between contact circuit and operating coil: 2,000V AC, 1 minute Between contact circuits: 2,000V AC, 1 minute Between contacts of same polarity: 1,000V AC, 1 minute
Frequency Response	1,800 operations/hour
Temperature Rise	Coil: 85°C maximum Contact: 65°C maximum
Vibration Resistance	0 to 6G (55Hz maximum)
Shock Resistance	100N (approximately 10G)
Life Expectancy	Electrical: over 500,000 operations (120V, 50/60Hz, 10A) Mechanical: over 10,000,000 operations
Operating Temperature	-30 to +70°C
Weight	RR2P: 90g, RR3PA: 96g (approximately) RR1BA/RR2BA/RR3B: 82g (approximately)

Ordering Information

Order standard voltages for fastest delivery. Allow extra delivery time for non-standard voltages.

Basic Part No.

RR3PA-U

Coil Voltage:

AC120V

Part Numbers

Part Numbers: RR Series with Options

Termination	Contact Configuration	Basic Part No.	Indicator Light	Check Button	Light and Check Button	Side Flange
P, PA (pin)	DPDT	RR2P-U	RR2P-UL	RR2P-UC	RR2P-ULC	—
	3PDT	RR3PA-U	RR3PA-UL	RR3PA-UC	RR3PA-ULC	—
B, BA (blade)	SPDT	RR1BA-U	RR1BA-UL	RR1BA-UC	RR1BA-ULC	RR1BA-US
	DPDT	RR2BA-U	RR2BA-UL	RR2BA-UC	RR2BA-ULC	RR2BA-US
	3PDT	RR3B-U	RR3B-UL	RR3B-UC	RR3B-ULC	RR3B-US



1. RR1BA, RR2BA, and RR3PA are U.S. standard terminal arrangements.
2. For diode option on DC coils please consult factory.

Ratings

Coil Ratings

Rated Voltage	Rated Current ±15% at 20°C		Coil Resistance ±10% at 20°C	Inrush Current	Inductance		
	60Hz	50Hz			Energizing	De-Energizing	
AC	6V	420mA	490mA	4.9Ω	720mA	0.04H	0.02H
	12V	210mA	245mA	18Ω	365mA	0.15H	0.08H
	24V	105mA	121mA	79Ω	182mA	0.57H	0.32H
	120V	20.5mA	24mA	2100Ω	35mA	15H	8.2H
	240V	10.5mA	12.1mA	8330Ω	18mA	57H	32H
DC	6V	240mA		25Ω	N/A		
	12V	120mA		100Ω			
	24V	60mA		400Ω			
	48V	30mA		1600Ω			
	110V	13mA		8460Ω			

E
Relays

Contact Ratings

Voltage	Resistive			Inductive			Motor Load
	Nominal	UL	CSA	Nominal	UL	CSA	UL
30V DC	10A	10A	10A	7.5A	7A	7.5A	—
110V DC	0.5A	—	—	0.3A	—	0.5A	—
120V AC	10A	10A	10A	7.5A	7.5A	7.5A	1/4 hp
240V AC	7.5A	10A	10A	5A	7A	7A	1/3 hp



Inductive load:
 $\cos \phi = 0.3, L/R = 7ms.$

Applicable Sockets

Part Numbers: Sockets

Relays	Standard DIN Rail Mount	Finger-Safe DIN Rail Mount	Panel Mount	Springs & Clips (optional)	
				Part Numbers	Use With Socket
RR2P	SR2P-05 SR2P-06	SR2P-05C	SR2P-51	SR2B-02F1	SR2P-05, -05C, -06
				SR3P-01F1	SR2P-51, SR3P-51
RR3PA	SR3P-05 SR3P-06	SR3P-05C	SR3P-51	SR3B-02F1	SR3P-05, -05C, -06 SR3B-05, -51
				SR3P-01F1	SR3P-51
RR1BA RR2BA RR3B	SR3B-05	—	SR3B-51	SR3B-02F1	SR3B-05 SR3B-51



See Section F for details on sockets. All DIN rail mount sockets listed can be mounted using DIN rail BNDN1000.

Internal Circuits

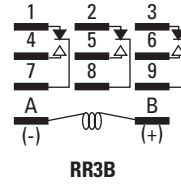
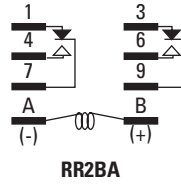
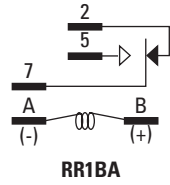
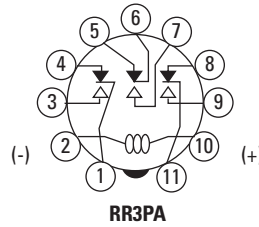
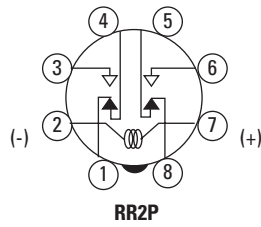
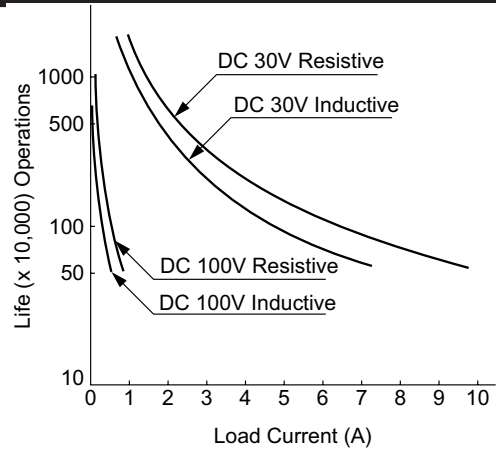
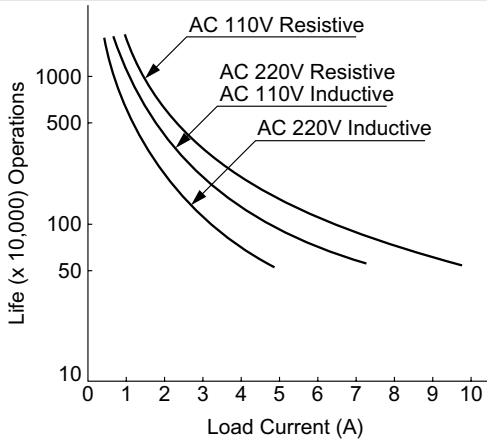
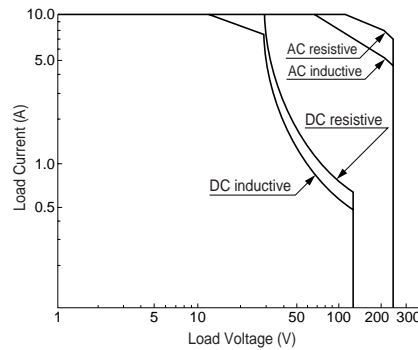

Image as viewed from bottom of relay. Refer to socket for exact wiring layout (Section F).

Electrical Life Curves



Maximum Switching Capacity



Dimensions

8-Pin RR2P

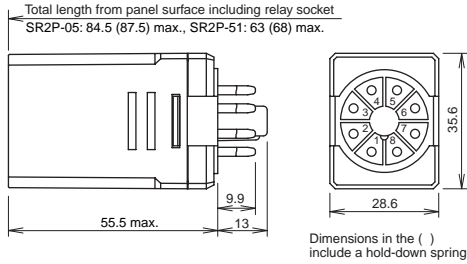

11-Pin RR3PA

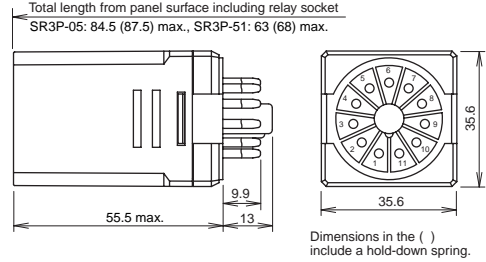

Blade RR1BA, RR2BA, RR3B

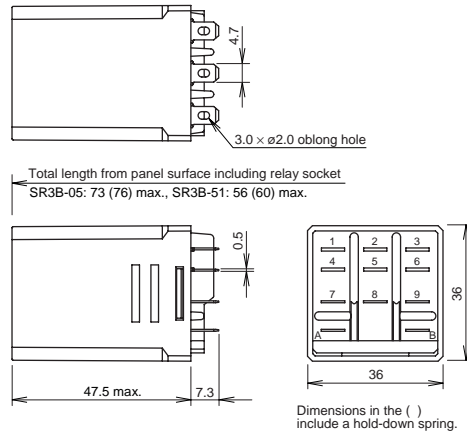

Side Flange RR1BA-US, RR2BA-US, RR3B-US

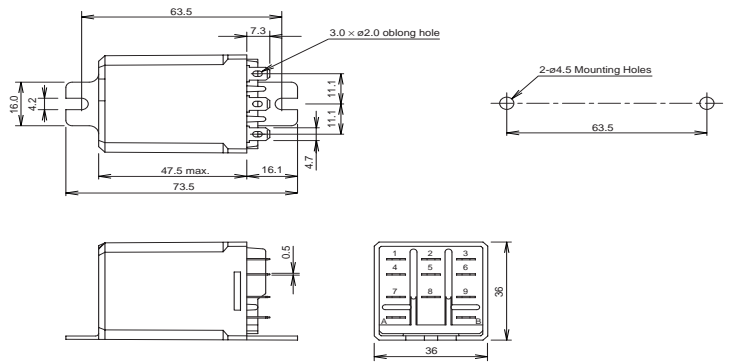

Note: Dimensions in [] include hold-down spring.

All dimensions in mm.