

FIBER SENSORS

LASER SENSORS

PHOTOELECTRIC SENSORS

MICRO PHOTOELECTRIC SENSORS

AREA SENSORS

LIGHT CURTAINS / SAFETY COMPONENTS

PRESSURE / FLOW SENSORS

INDUCTIVE PROXIMITY SENSORS

PARTICULAR USE SENSORS

SENSOR OPTIONS

SIMPLE WIRE- SAVING UNITS

WIRE- SAVING SYSTEMS

MEASUREMENT SENSORS

STATIC ELECTRICITY PREVENTION DEVICES

LASER MARKERS

PLC

HUMAN MACHINE INTERFACES

ENERGY CONSUMPTION VISUALIZATION COMPONENTS

FA COMPONENTS

MACHINE VISION SYSTEMS

UV CURING SYSTEMS

**Simplified systems using new operating modes**

**FX-305**

A window comparator mode and differential sensing mode have been added. These modes make it easy to carry out sensing tasks that previously required multiple sensors or involved complex threshold settings.

• **Window comparator mode**



<Sensing ICs in trays>

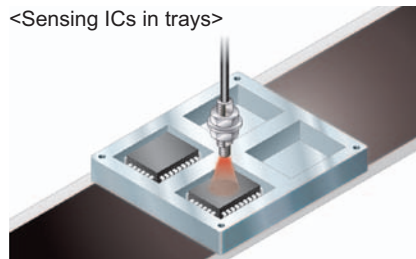

Tray absent	IC present	Tray present
OFF	ON	OFF

Upper and lower limits for threshold values can be set so that the incident light intensity can turn on and off within those ranges. Single output is used, so that only one cable is required, and no PLC processing is required either.

• **Differential sensing mode**



<Sensing of tiny moving objects>

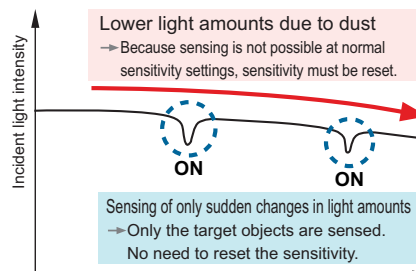
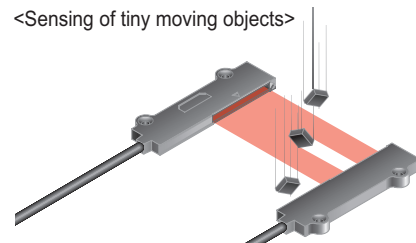

**Equipped with 5 types timers**

**FX-305**

The **FX-305** includes the same ON-delay / OFF-delay / ONE SHOT timer as the **FX-301(-HS)**, as well as an ON-delay • OFF-delay timer and an ON-delay • ONE SHOT timer. A wide variety of timer control operations can be carried out by these fiber sensors alone.

Timer period  
Output 1: 0.5 to 9,999 ms (variable)  
Output 2: 0.5 to 500 ms (variable)

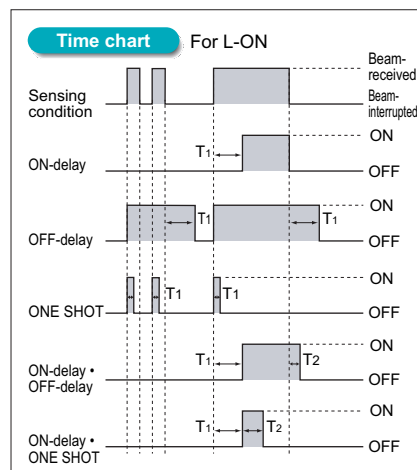

**Even beginners can quickly learn how to use the MODE NAVI**

**All models**

MODE NAVI uses six indicators to display the amplifier's basic operations. The current operating mode can be confirmed at a glance, so even a first time user can easily operate the amplifier without becoming confused.

RUN	TEACH	ADJ	<b>RUN</b> →	This is the sensing mode. Incident light level is displayed in the digital display.
RUN	TEACH	ADJ	<b>TEACH</b> →	This mode is for setting the threshold value.
RUN	TEACH	ADJ	<b>ADJ</b> →	In this mode, the threshold value, once set, may be fine-tuned.



L / D	TIMER	<b>L / D ON</b> →	This mode allows the selection of output operation as either Light-ON or Dark-ON.
L / D	TIMER	<b>TIMER</b> →	This mode permits the choice of using or not using the timer.
L / D	TIMER	<b>PRO</b> →	This mode allows the selection of further advanced functions, such as the copying of individual settings and the memory functions.

**Easy confirming of threshold value settings**

**FX-301 FX-301-HS FX-305**

The threshold value can be confirmed by turning the jog switch even during RUN mode.

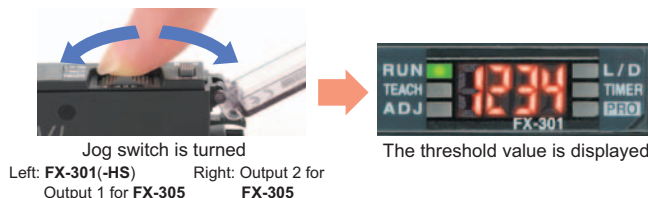

Selection Guide

Fibers

Fiber Amplifiers

**FX-500**

**FX-100**

**FX-300**

**FX-410**

**FX-311**

**FX-301-F7/ FX-301-F**

**The use of only two switches makes for very simple operations**

**All models**

Only two switches, the large jog switch and the large MODE key, are required for operation. You can operate it simply by the 3 steps shown on the right.

● **Large MODE key**



1

MODE Pressing the switch selects or cancels the operating mode

● **Large jog switch**

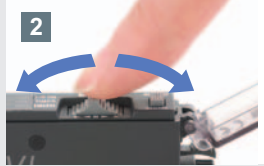

2

Moving the switch from side to side allows items to be selected



3

Pressing the switch then confirms the selected setting

**A quick-connection cable saves wiring and work-hours**

**Connector type**

**One unit can be used as either a main unit or sub unit**

The amplifier unit can be used as either a main unit or a sub unit. This feature allows for easy mounting in the side-by-side configuration. The main and sub unit functions are distinguished only by the proper use of the main cable and the sub cable. Moreover, inventory management and maintenance is simplified.

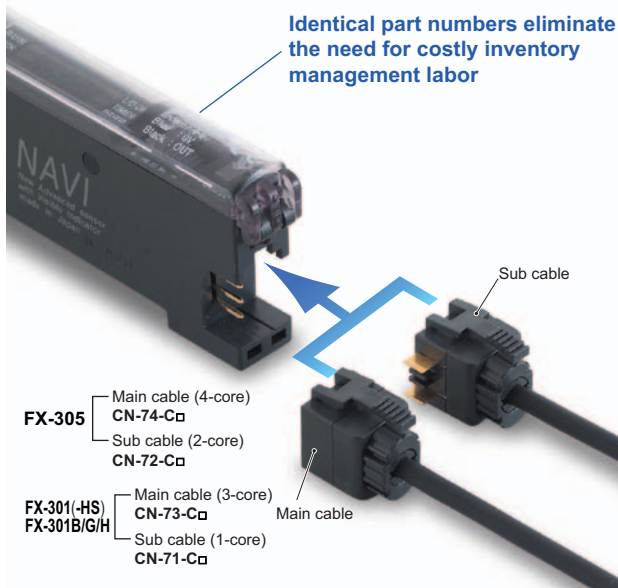

Identical part numbers eliminate the need for costly inventory management labor

<p><b>FX-305</b></p> <ul style="list-style-type: none"> <li>Main cable (4-core) CN-74-C□</li> <li>Sub cable (2-core) CN-72-C□</li> </ul>	<p>Sub cable</p> <p>Main cable</p>
<p><b>FX-301(-HS)</b> <b>FX-301B/G/H</b></p> <ul style="list-style-type: none"> <li>Main cable (3-core) CN-73-C□</li> <li>Sub cable (1-core) CN-71-C□</li> </ul>	

**An optical communication function allows up to \*16 sensors to be adjusted simultaneously**

**FX-301 FX-305**

The optical communication function allows the data that is currently set to be copied and saved all at once for all amplifiers connected together from the right side. This greatly reduces troublesome setup tasks and makes setup much smoother. In addition, troublesome adjustment operations at times such as when replacing sensors can also be carried out easily and data can also be copied and stored using the optical communication function.



\* Use the optical communication function for only the same types of sensors. Furthermore, the FX-301-HS is not equipped with optical communication function capability.

**Settings can be entered directly using numerical input**

**All models**

Every function can be directly set merely by the input of a four digit code (numbers) from the code table. This convenient feature is easy to set up. In the event that settings are accidentally changed at the operating site, merely entering the correct code can restore the original settings. This results in easy and quick maintenance.

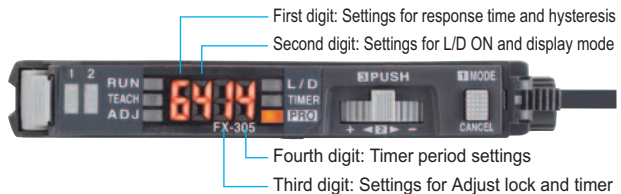

- First digit: Settings for response time and hysteresis
- Second digit: Settings for L/D ON and display mode
- Third digit: Settings for Adjust lock and timer
- Fourth digit: Timer period settings

**Communication unit improves equipment starting up and maintenance**

**FX-301 FX-305**

**External input unit for digital sensor**

**FX-CH2**

Teaching and changing settings can be performed by using the PLC and touch panel.

Various settings and switching of up to 16 units of digital fiber sensors can be accomplished at once without operating the actual sensors themselves, but via external signals, such as the PLC, touch panel, and push buttons.

**<Main functions>**

- Batch teaching
- Key lock setting
- Batch loading / saving of the data bank



Refer to our website for details

**Upper communication unit for digital sensor**

**SC-GU1-485**

**We now offer remote maintenance for digital sensors!**

The communication unit enables inputs to the digital fiber sensors (such as teaching and data bank switching) to be carried out via a PLC or a personal computer, and also allows confirming of the incident light intensity an output status for the fiber sensors. This greatly improves workability during equipment starting up and maintenance.

**<Communicable commands>**

- Sensor incident light intensity
- Sensor settings verification
- Sensor output status
- Threshold value settings, etc.

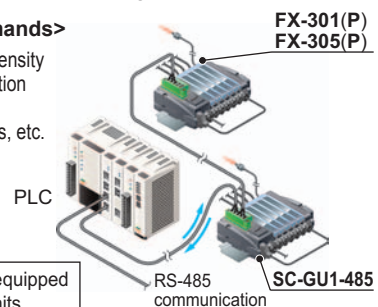

Compatible with all PLCs equipped with RS-485 compatible units

Refer to **SC-GU1-485** pages for details

**FIBER SENSORS**

LASER SENSORS

PHOTOELECTRIC SENSORS

MICRO PHOTOELECTRIC SENSORS

AREA SENSORS

LIGHT CURTAINS / SAFETY COMPONENTS

PRESSURE / FLOW SENSORS

INDUCTIVE PROXIMITY SENSORS

PARTICULAR USE SENSORS

SENSOR OPTIONS

SIMPLE WIRE-SAVING UNITS

WIRE-SAVING SYSTEMS

MEASUREMENT SENSORS

STATIC ELECTRICITY PREVENTION DEVICES

LASER MARKERS

PLC

HUMAN MACHINE INTERFACES

ENERGY CONSUMPTION VISUALIZATION COMPONENTS

FA COMPONENTS

MACHINE VISION SYSTEMS

UV CURING SYSTEMS

Selection Guide

Fibers

Fiber Amplifiers

**FX-500**

**FX-100**

**FX-300**

**FX-410**

**FX-311**

**FX-301-F7/**

**FX-301-F**