

# CR2330

## ■ Dimensions(mm)



## ■ Specification

Nominal voltage(V)	3
Nominal capacity(mAh)	265
Continuous drain(mA)	0.2
Operating temperature(°C)	-30 to +60

## ■ Discharge temperature characteristics



## ■ Operating voltage vs. load resistance(voltage at 50% discharge depth)



## ■ Capacity vs. load resistance



# CR2354

## ■ Dimensions(mm)

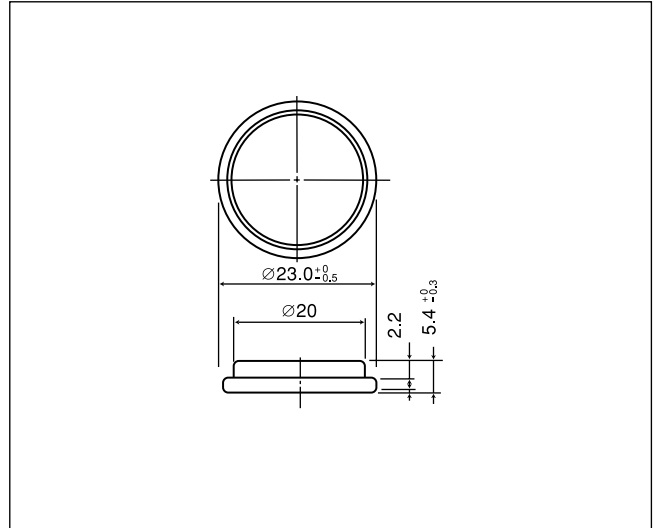

## ■ Specification

Nominal voltage(V)	3
Nominal capacity(mAh)	560
Continuous drain(mA)	0.2
Operating temperature(°C)	-30 to +60

## ■ Discharge temperature characteristics



## ■ Operating voltage vs. load resistance(voltage at 50% discharge depth)



## ■ Capacity vs. load resistance

