



Quick Reference Guide

DF6-340-... Frequency Inverters

02/02 AWB8230-1449GB

1st published 2002, edition 02/02

© Moeller GmbH, 53105 Bonn

Author: Holger Friedrich

Editor: Michael Kämper

Translator: Dominik Kreuzer

All brand and product names are trademarks or registered trademarks of the owner concerned.

All rights reserved, including those of the translation.

No part of this manual may be reproduced in any form (printed, photocopy, microfilm or any other process) or processed, duplicated or distributed by means of electronic systems without written permission of Moeller GmbH, Bonn.

Subject to alteration without notice.

Quick Reference Guide DF6 Frequency Inverter

Keypad

The following illustration shows the LCD keypad of the DF6.

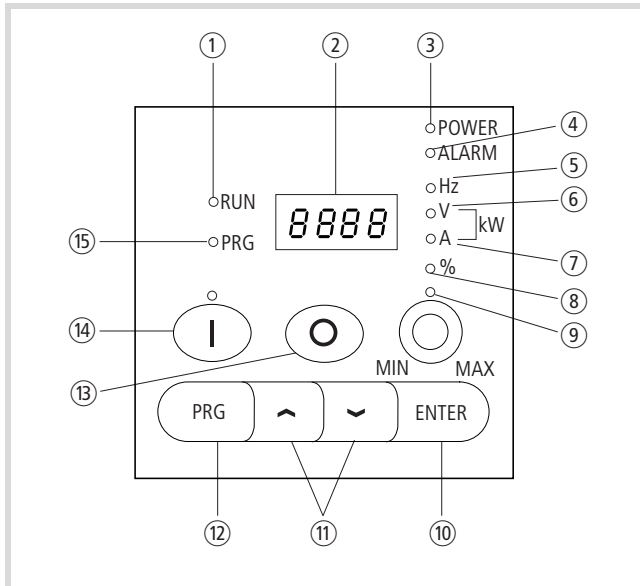









Figure 1: Keypad view

For an explanation of each of the elements, → table 1.

Table 1: Explanation of the operating and indication elements

Number	Name	Explanation
①	RUN LED	LED lights up in RUN mode if the frequency inverter is ready for operation or operational.
②	7 segment display	Display for frequency, motor current, fault messages, etc.
③	POWER LED	LED is lit when the frequency inverter has power.
④	Alarm LED	LED is lit when a fault has occurred
⑤	Hz LED	Indication in ②: Output frequency (Hz)
⑥, ⑦	V, A, kW LED	Indication in ②: Either output voltage (V) or output current (A) or a combined current and voltage factor (kW)
⑧	LED %	Indication in ②: Torque in %
⑨	Potentiometer and LED	Frequency setpoint setting LED is lit when the potentiometer is activated.
⑩	ENTER key 	This key is used for saving entered or changed parameters.
⑪	Arrow keys  	Selecting functions, changing numeric values  Increase  Reduce
⑫	PRG key 	For selecting and exiting the programming mode.
⑬	OFF key 	Stops the running motor and acknowledges a fault message. Active by default, also when actuation is through terminals.
⑭	On key and LED 	Starts the motor in the specified direction (not active by default).
⑮	PRG LED	LED is lit during parameterization.

Using the keypad

Example for changing over the control mode from control signal terminals (default) to the keypad.

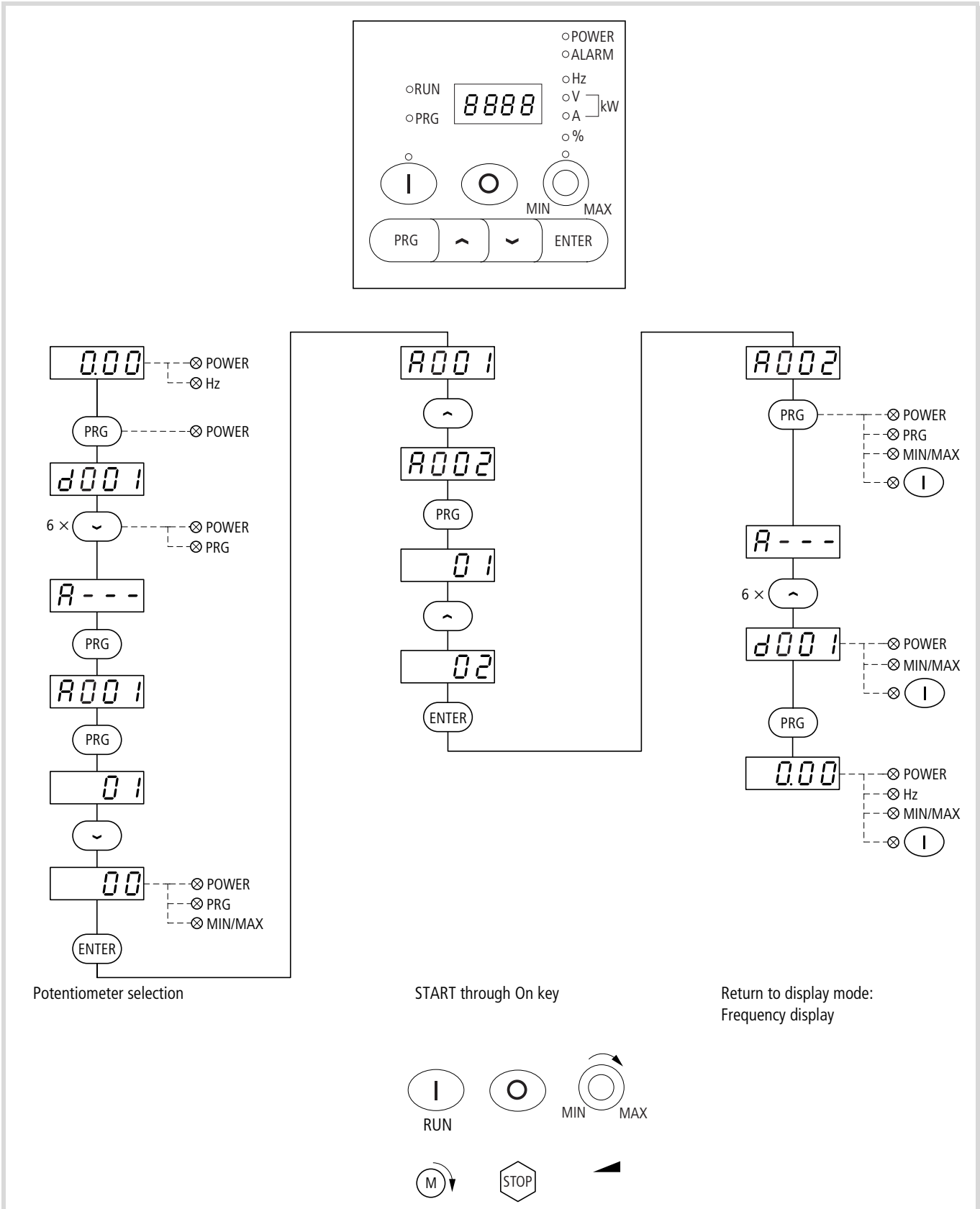

Figure 2: Specify setpoint definition through keypad

Restoring the Default Settings

Initialization

Two different types of initialization are available:

- Clearing the fault history register
- Restoring the default parameter settings

To delete the fault history register or to restore the default settings, proceed as follows:

- ▶ Make sure that PNU b085 holds the value.

- ▶ Under PNU b084 (initialization), enter 00, 01 or 02.
- ▶ Press the ENTER key to save the value.
- ▶ On the keypad, press both arrow keys and the PRG key at the same time and keep them pressed.
- ▶ While holding the arrow and PRG keys, briefly press the OFF key.
- ▶ Now release all keys again. The display shows $\text{d}001$.

Initialization is now complete.

PNU	Name	Adjustable in RUN mode		Value	Function	Def.
		Normal	Extended			
b084	Initialization	–	–	00	Clearing the fault history register	00
				01	Restoring the default parameter settings (default settings)	
				02	Deleting the fault history register and restoring the default settings	

Country version

Here, you define the country-specific parameter set which will be loaded during initialization (→ PNU b084).

PNU	Name	Adjustable in RUN mode		Value	Function	Def.
		Normal	Extended			
b085	Country version	–	–	00	Japan	01
				01	Europe	
				02	USA	

Fault messages

When an overcurrent, overvoltage or undervoltage occurs, the output of the DF6 frequency inverter is disabled to protect the DF6 from damage. The connected motor then coasts to a stop. The inverter remains in this condition until the fault message is acknowledged with the OFF key or the RST input.

State of frequency inverter on fault message

The frequency inverter's state when a fault occurs provides additional information to help rectify the fault.

Some fault messages indicate the status of the DF6 frequency inverter with a number after the point. E07.2, for example, means that fault 7 has occurred while the frequency inverter was in status 2.

The individual states are described in the table below



Status code	DF6 status
---.0	Reset
---.1	Stop
---.2	Deceleration
---.3	Static operation
---.4	Acceleration
---.5	f_0 stop
---.6	Start
---.7	DC braking
---.8	Current limit
---.9	Autotuning

Fault message indication

Display	Cause	Description
E01	Overcurrent in the output stage in static operation	<p>If the output current reaches an excessive level, the output voltage is switched off. This happens when</p> <ul style="list-style-type: none"> • the frequency inverter's output is short-circuited, • the motor is blocked, • an excessive load is suddenly applied to the output.
E02	Overcurrent in the output stage during deceleration	
E03	Overcurrent in the output stage during acceleration	
E04	Overcurrent in the output stage at standstill	
E05	Overload	The internal electronic motor protection has switched off the output voltage because the motor was overloaded.
E06	Overload	If the duty factor of the built-in braking transistor of the DF6 is too great, the braking transistor is switched off (the generated overvoltage disconnects the output voltage).
E07	Overvoltage	The output voltage has been switched off because the motor was operating regeneratively.
E08	EEPROM fault	<p>If the program memory does not operate reliably due to radio frequency interference or excessive temperature, the output voltage is switched off.</p> <p>If the supply voltage is switched off while the RST input is active, an EEPROM fault occurs when the supply voltage is reapplied.</p>
E09	Undervoltage	If the DC voltage is too low, the output voltage is switched off (fault-free function of electronics no longer possible; any problems, such as overheating of motor and insufficient torque).
E10	Fault in current transformer	The output voltage is disconnected when a fault occurs in the built-in current transformer of the DF6.
E11	Processor malfunction	The processor does not operate correctly. The output voltage is switched off.
E12	External fault message	The output voltage is switched off due to an external fault message which is present on a digital input configured as an EXT input.
E13	Restart inhibit activated	The mains voltage was switched on or an intermittent interruption in the supply voltage has occurred while unattended start protection (input USP) was active.
E14	Earth fault	Earth faults between the U, V or W terminals and earth are being reliably detected. A protective circuit prevents destruction of the frequency inverter, but does not protect the operating personnel.
E15	Mains overvoltage	If the supply voltage is higher than permitted, the output voltage is switched off 100 seconds after the voltage supply has been switched on.
E16	Intermittent mains failure	An intermittent mains failure of at least 15 ms has occurred. This message appears when the duration of the mains failure is longer than the time entered under PNU b002 (→ page 134)
E21	Overtemperature	If the temperature sensor installed in the power section records an operating temperature above the permissible limit value, the output voltage is switched off.
E23	Gate array fault	Internal communication error between CPU and gate array
E24	Mains phase failure	One of the three mains phases has failed.
E30	IGBT fault	If an excessive current is applied at an IGBT (transistor in the power end stage), the output voltage is switched off to protect the transistor.
E35	Thermistor fault signal	If the resistance of the external PTC thermistor connected to the PTC input (terminals TH and CM1) is too high, the output voltage is switched off.
----	Undervoltage	Because the input voltage is too low, the frequency inverter attempts a restart. If the restart fails, a fault message is triggered to save the undervoltage fault and the frequency inverter switches off.
E60 to E69	Fault, expansion module 1	A fault has occurred in expansion modules 1 or 2 and their connections. For further information, refer to the manuals for the affected expansion module.
E70 to E79	Fault, expansion module 2	

Other messages

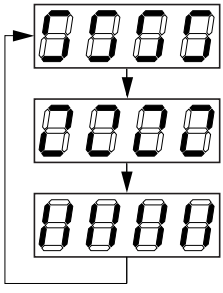
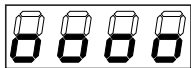
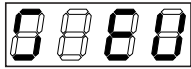
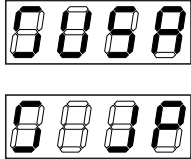
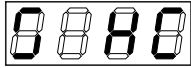
This section describes the messages issued by the DF6 frequency inverter, for example in standby mode when mains power is switched off.

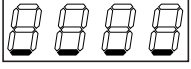
Display	Cause
	The frequency inverter is in standby mode or a reset signal is active.
	The mains voltage has been switched off.
	The waiting time before an automatic restart is counting down (PNU b001 and b003, → AWB8230-1413GB section "Automatic restart after a fault", page 132).
	The default settings have been selected and the frequency inverter is in the initialization phase (PNU b084 and b085, → AWB8230-1413GB section "Initialization", page 147). The values for the European market (EU) are being initialized. For non-European models, versions for North America (USA) and Japan (JP) are available.
	Initialization of the fault history register
	Copy station – copying in progress.
	No data available, e.g. display under PNU d081 and d086, when the fault history register is empty the display under PNU d004, when PID control is not active.

Standard form for user defined parameter settings

The DF6 frequency inverters have programmable parameters. For a detailed description of the parameters, see the specified page in the manual (AWB8230-1413GB). In the free Setpoint columns below, you can list the changes you have made from the default settings.

PNU	Meaning	Value range	Def.	Setpoint
A001	Frequency setpoint input	<ul style="list-style-type: none"> • 00: Potentiometer • 01: Analog inputs O, O2 or OI • 02: PNU F001 or A020 • 03: RS 485 serial interface • 04: Optional module in slot 1 • 05: Optional module in slot 2 	01	
A002	Start signal definition	<ul style="list-style-type: none"> • 01: Input FWD/REV • 02: ON key • 03: RS 485 serial interface • 04: Optional module in slot 1 • 05: Optional module in slot 2 	01	
A003	Base frequency	30 to 400 Hz	50	
A203	Base frequency (second parameter set)	30 to 400 Hz	50	
A004	Maximum end frequency	30 to 400 Hz	50	
A204	End frequency (second parameter set)	30 to 400 Hz	50	
A005	AT selection	<ul style="list-style-type: none"> • 00: AT input switches between analog input O and OI • 01: AT input switches between analog input O and O2 	00	
A006	O2 selection	<ul style="list-style-type: none"> • 00: O2 signal only • 01: Sum of signals at O2 and O/OI without direction reversal • 02: Sum of signals at O2/O or OI with direction reversal 	00	
A011	Frequency at minimum setpoint value (terminal O-L)	0.00 to 400 Hz	0.00	
A012	Frequency at maximum setpoint value (terminal O-L)	0.00 to 400 Hz	0.00	
A013	Minimum setpoint value (terminal O-L)	0 to 100 %	0	
A014	Maximum setpoint value (terminal O-L)	0 to 100 %	100	
A015	Starting frequency (terminal O-L)	<ul style="list-style-type: none"> • 00: Apply PNU A011 to motor • 01: Apply 0 Hz to motor 	01	
A016	Analog input filter time constant	1 to 30	8	
A019	Fixed frequency selection	<ul style="list-style-type: none"> • 00: Binary selection through digital inputs FF1 to FF4 • 01: Bitwise selection through digital inputs SF1 to SF7 	00	
A020	Frequency setpoint definition PNU A001 must be O2	0.00 to 400 Hz	0.00	
A220	Frequency setpoint definition; PNU A001 must be O2 (second parameter set)	0.00 to 400 Hz	0.00	

PNU	Meaning	Value range	Def.	Setpoint
A021	1st fixed frequency	0.00 to 400 Hz	0.00	
A022	2nd fixed frequency	0.00 to 400 Hz	0.00	
A023	3rd fixed frequency	0.00 to 400 Hz	0.00	
A024	4th fixed frequency	0.00 to 400 Hz	0.00	
A025	5th fixed frequency	0.00 to 400 Hz	0.00	
A026	6th fixed frequency	0.00 to 400 Hz	0.00	
A027	7th fixed frequency	0.00 to 400 Hz	0.00	
A028	8th fixed frequency	0.00 to 400 Hz	0.00	
A029	9th fixed frequency	0.00 to 400 Hz	0.00	
A030	10th fixed frequency	0.00 to 400 Hz	0.00	
A031	11th fixed frequency	0.00 to 400 Hz	0.00	
A032	12th fixed frequency	0.00 to 400 Hz	0.00	
A033	13th fixed frequency	0.00 to 400 Hz	0.00	
A034	14th fixed frequency	0.00 to 400 Hz	0.00	
A035	15th fixed frequency	0.00 to 400 Hz	0.00	
A038	Frequency in jog mode	0 to 9.99 Hz	1.00	
A039	Motor stop in jog mode through	<ul style="list-style-type: none"> • 00: Coasting • 01: Deceleration ramp • 02: DC braking • 03: Without prior stop signal, motor coasts to halt • 04: Without prior stop signal, stopping with deceleration ramp • 05: Without prior stop signal, stopping with DC braking 	00	
A041	Voltage boost characteristics	<ul style="list-style-type: none"> • 00: Manual • 01: Automatic 	00	
A241	Boost characteristic (second parameter set)	<ul style="list-style-type: none"> • 00: Manual • 01: Automatic 	00	
A042	Percentage voltage increase with manual boost	0.0 to 20 %	1.0	
A242	Percentage voltage increase on manual boost (second parameter set)	0.0 to 20 %	1.0	
A043	Maximum boost at x % of the base frequency	0.0 to 50 %	5.0	
A243	Maximum boost at x % of the base frequency (second parameter set)	0.0 to 50 %	5.0	
A044	<i>U/f</i> characteristic	<ul style="list-style-type: none"> • 00: Constant torque curve • 01: Reduced torque curve • 02: User-definable 	00	
A244	<i>U/f</i> characteristic (second parameter set)	<ul style="list-style-type: none"> • 00: Constant torque curve • 01: Reduced torque curve • 02: User-definable 	00	
A045	Output voltage	20 to 100 %	100	
A051	DC braking	<ul style="list-style-type: none"> • 00: Inactive • 01: Active 	00	
A052	DC braking starting frequency	0 to 60 Hz	0.5	
A053	DC braking waiting time on deceleration	0 to 5 s	0.0	

PNU	Meaning	Value range	Def.	Setpoint
A054	DC braking torque on deceleration	0 to 100 %	0	
A055	DC braking duration on deceleration	0 to 60 s	0.0	
A056	Behaviour on activation of the DB input	<ul style="list-style-type: none"> • 00: Starts on activation of the input, ends after PNU A055 • 01: Runs as long as input is active 	01	
A057	DC braking torque on acceleration	0 to 100 %	0	
A058	DC braking duration on acceleration	0 to 60 s	0.0	
A059	DC braking frequency	<ul style="list-style-type: none"> • To DV6-340-55K: 0.5 to 15 kHz • From DF6-340-75K: 0.5 to 10 kHz 	3.0	
A061	Maximum operating frequency	0.00 to 400 Hz	0.0	
A261	Maximum operating frequency (second parameter set)	0.00 to 400 Hz	0.0	
A062	Minimum operating frequency	0.00 to 400 Hz	0.0	
A262	Minimum operating frequency (second parameter set)	0.00 to 400 Hz	0.0	
A063	1st frequency jump	0.00 to 400 Hz	0.0	
A064	Jump width of the 1st frequency jump	0.00 to 10 Hz	0.5	
A065	2nd frequency jump	0.00 to 400 Hz	0.0	
A066	Jump width of the 2nd frequency jump	0.00 to 10 Hz	0.5	
A067	3rd frequency jump	0.00 to 400 Hz	0.0	
A068	Jump width of the 3rd frequency jump	0.00 to 10 Hz	0.5	
A069	Acceleration pause waiting frequency	0.00 to 400 Hz	0.0	
A070	Acceleration pause waiting duration	0 to 60 s	0.0	
A071	PID control	<ul style="list-style-type: none"> • 00: Inactive • 01: Active 	00	
A072	P component of the PID control	0.2 to 50	1.0	
A073	I component of the PID control	0 to 3600 s	1.0	
A074	D component of the PID control	0.0 to 100 s	0.0	
A075	Setpoint factor of the PID control	0.01 to 99.99	1.00	
A076	Input actual value signal for PID control	<ul style="list-style-type: none"> • 00: Input OI • 01: Input O 	00	
A081	AVR function	<ul style="list-style-type: none"> • 00: Active • 01: Inactive • 02: Inactive during deceleration 	02	
A082	Motor voltage for AVR function	380, 400, 415, 440, 460, 480	400	
A085	Energy-saving mode	<ul style="list-style-type: none"> • 00: Not active • 01: Active 	00	
A086	Response time in energy-saving mode	0 to 100 s	50	
A092	2. acceleration time	0.01 to 3600 s	15.0	
A292	2nd acceleration time (second parameter set)	0.01 to 3600 s	15.0	
A093	2nd deceleration time	0.01 to 3600 s	15.0	
A293	2nd deceleration time (second parameter set)	0.01 to 3600 s	15.0	

PNU	Meaning	Value range	Def.	Setpoint
A094	Changeover from 1st to 2nd time ramp	<ul style="list-style-type: none"> • 00: Input 2CH • 01: PNU A095 or A096 	00	
A294	Changeover from 1st to 2nd time ramp (second parameter set)	<ul style="list-style-type: none"> • 00: Input 2CH • 01: PNU A095 or A096 	00	
A095	Changeover frequency on changeover from first to second acceleration time	0.00 to 400 Hz	0.00	
A295	Changeover frequency on changeover from first to second acceleration time (second parameter set)	0.00 to 400 h	0.00	
A096	Changeover frequency on changeover from first to second deceleration time	0.00 to 400 Hz	0.00	
A296	Changeover frequency on changeover from first to second deceleration time (second parameter set)	0.00 to 400 h	0.00	
A097	Acceleration characteristic	<ul style="list-style-type: none"> • 00: Linear • 01: S curve • 02: U curve • 03: Inverted U curve 	00	
A098	Deceleration characteristic	<ul style="list-style-type: none"> • 00: Linear • 01: S curve • 02: U curve • 03: Inverted U curve 	00	
A101	Analog input O1 starting frequency	0.00 to 400 Hz	0.00	
A102	Analog input O1 end frequency	0.00 to 400 h	0.00	
A103	Analog input O1 starting current	0 to 100 %	20	
A104	Analog input O1 end current	0 to 100 %	100	
A105	Analog input O1 condition for starting frequency	00: Start at PNU A101 02: Start at 0 Hz	01	
A111	Analog input O2 starting frequency	-400 to 400 Hz	0.00	
A112	Analog input O2 end frequency	-400 to 400 Hz	0.00	
A113	Analog input O2 starting voltage	-100 to 100 %	-100	
A114	Analog input O2 end voltage	-100 to 100 %	100	
A131	Curvature of acceleration characteristic	01 to 10	02	
A132	Curvature of deceleration characteristic	01 to 10	02	

PNU	Meaning	Value range	Def.	Setpoint
b001	Restart mode	<ul style="list-style-type: none"> • 00: Fault message • 01: 0 Hz start • 02: Synchronization to current motor speed and acceleration • 03: Synchronization and deceleration 	00	
b002	Permissible power failure duration	0.3 to 1.0 s	1.0	
b003	Waiting time before restart	0.3 to 1.0 s	1.0	
b004	Fault message issued immediately	<ul style="list-style-type: none"> • 00: No fault on intermittent mains failure • 01: Fault on intermittent mains failure • 02: No fault on intermittent mains failure at standstill and deceleration 	00	
b005	Number of restart attempts	<ul style="list-style-type: none"> • 00: 16 restart attempts • 01: Unlimited number of restart attempts 	00	
b006	Mains phase failure detection	<ul style="list-style-type: none"> • 00: Inactive • 01: Active 	00	
b007	Synchronization frequency on return of mains power	0.00 to 400 Hz	0.00	
b012	Tripping current for electronic motor protection device	0.2 to $1.2 \times I_e$ [A]	I_e (inverter)	
b212	Tripping current for electronic motor protection device (second parameter set)	0.2 to $1.2 \times I_e$ [A]	I_e (inverter)	
b013	Characteristic for electronic motor protection device	<ul style="list-style-type: none"> • 00: Enhanced protection • 01: Normal protection • 03: User-definable protection 	01	
b213	Characteristic for electronic motor protection device (second parameter set)	<ul style="list-style-type: none"> • 00: Enhanced protection • 01: Normal protection • 03: User-definable protection 	01	
b015	Frequency 1 for user-definable motor protection characteristic	0.00 to 400 Hz	0	
b016	Tripping current 1 for user-definable motor protection characteristic	0.0 to 1000 A	0.0	
b017	Frequency 2 for user-definable motor protection characteristic	0.00 to 400 Hz	0	
b018	Tripping current 2 for user-definable motor protection characteristic	0.0 to 1000 A	0.0	
b019	Frequency 3 for user-definable motor protection characteristic	0.00 to 400 Hz	0	
b020	Tripping current 3 for user-definable motor protection characteristic	0.0 to 1000 A	0.0	
b021	Motor current limitation 1	<ul style="list-style-type: none"> • 00: Inactive • 01: Active in every operating status • 02: Inactive during acceleration, otherwise active 	01	
b022	Tripping current 1 for motor current limitation	0.5 to $1.5 \times I_e$ [A]	$I_e \times 1.2$	
b023	Time constant 1 of motor current limitation	0.1 to 30 s	1.00	
b024	Motor current limitation 2	<ul style="list-style-type: none"> • 00: Inactive • 01: Active in every operating status • 02: Inactive during acceleration, otherwise active 	1	
b025	Tripping current 2 for motor current limitation	0.5 to $1.5 \times I_e$ [A]	$I_e \times 1.2$	

PNU	Meaning	Value range	Def.	Setpoint
b026	Time constant 2 of motor current limitation	0.6 to 30 s	1.0	
b031	Software dependent parameter protection	<ul style="list-style-type: none"> • 00: Through SFT input; all functions inhibited • 01: Through SFT input; function F001 possible • 02: Without SFT input; all functions inhibited • 03: Without SFT input; function F001 possible • 10: Extended parameters adjustable in RUN mode 	01	
b034	Running time or Mains On time signal	0 to 65530 h	0	
b035	Inhibit direction	00: Motor can run in both directions 01: Motor can only run clockwise 02: Motor can only run anticlockwise	00	
b036	Voltage ramp to starting frequency	<ul style="list-style-type: none"> • 00: Start without voltage reduction. • 01: Minimum voltage reduction, approx. 6 ms • ... • 06: Maximum voltage reduction, approx. 36 ms 	06	
b037	Display mode	<ul style="list-style-type: none"> • 00: All parameters • 01: Relevant parameters • 02: Parameters saved under PNU U001 to U012 	00	
b080	Gain factor, analog output AM	0 to 255	180	
b081	Gain factor, analog output FM	0 to 255	60	
b082	Increased starting frequency (e.g. with high level of friction)	0.1 to 9.99 Hz	0.50	
b083	Pulse frequency	0.5 to 12 kHz	3.0	
b084	Initialization causes	<ul style="list-style-type: none"> • 00: Clearing the fault history register • 01: Selection of default settings • 02: Deleting the fault history register and restoring the default settings 	00	
b085	Country version	<ul style="list-style-type: none"> • 00: Japan • 01: Europe • 02: USA 	01	
b086	Frequency factor for display through PNU d007	0.1 to 99.9	1.0	
b087	OFF key	<ul style="list-style-type: none"> • 00: Always active • 01: Not active with control through the FWD/REV terminals 	00	
b088	Motor restart after removal of the FRS signal	<ul style="list-style-type: none"> • 00: At 0 Hz • 01: At current motor speed 	00	
b090	Permissible relative percentage duty factor for built-in braking transistor	0 to 100 %	0.00	
b091	Type of motor stop when Off button is pressed	<ul style="list-style-type: none"> • 00: Braking/deceleration ramp • 01: Free run stop (coasting) 	00	
b092	Configuration of fan operation	<ul style="list-style-type: none"> • 00: Fan always switched on • 01: Fan switched on only when motor running 	00	
b095	Enable built-in braking transistor	<ul style="list-style-type: none"> • 00: Not enabled • 01: Enabled in RUN mode • 02: Always enabled 	00	
b096	Voltage threshold for braking transistor	660 to 760 V	720	
b098	Selection of PTC or NTC	<ul style="list-style-type: none"> • 00: No temperature monitoring • 01: PTC • 02: NTC 	00	
b099	Resistance threshold for thermistor input	0 to 9999 Ω	3000	

PNU	Meaning	Value range	Def.	Setpoint
b100	User-definable U/f characteristics, frequency coordinates 1	0.00 to 400 Hz	0	
b101	User-definable U/f characteristics, voltage coordinates 1	0 to U_1 /PNU A082	0.0	
b102	User-definable U/f characteristics, frequency coordinates 2	0.00 to 400 Hz	0	
b103	User-definable U/f characteristics, voltage coordinates 2	0 to U_1 /PNU A082	0.0	
b104	User-definable U/f characteristics, frequency coordinates 3	0.00 to 400 Hz	0	
b105	User-definable U/f characteristics, voltage coordinates 3	0 to U_1 /PNU A082	0.0	
b106	User-definable U/f characteristics, frequency coordinates 4	0.00 to 400 Hz	0	
b107	User-definable U/f characteristics, voltage coordinates 4	0 to U_1 /PNU A082	0.0	
b108	User-definable U/f characteristics, frequency coordinates 5	0.00 to 400 Hz	0	
b109	User-definable U/f characteristics, voltage coordinates 5	0 to U_1 /PNU A082	0.0	
b110	User-definable U/f characteristics, frequency coordinates 6	0.00 to 400 Hz	0	
b111	User-definable U/f characteristics, voltage coordinates 6	0 to U_1 /PNU A082	0.0	
b112	User-definable U/f characteristics, frequency coordinates 7	0.00 to 400 Hz	0	
b113	User-definable U/f characteristics, voltage coordinates	0 to U_1 /PNU A082	0.0	

PNU	Meaning	Value range	Def.	Setpoint
C001	Function of digital input 1	Function of digital input 1 <ul style="list-style-type: none"> • 01: REV, anticlockwise operation • 02: FF1, first fixed frequency input • 03: FF2, second fixed frequency input • 04: FF3, third fixed frequency input • 05: FF4, fourth fixed frequency input • 06: JOG, jog mode • 07: DB, DC braking • 08: SET, second parameter set • 09: 2CH, second time ramp • 11: FRS, controller inhibit • 12: EXT, external fault • 13: USP, unattended start protection • 14: CS, heavy mains starting • 15: SFT, parameter protection • 16: AT, analog input selection • 18: RST, reset • 20: STA, three-wire control start signal • 21: STP, three-wire control stop signal • 22: STA, three-wire control direction • 23: PID, activate PID control • 24: PIDC, reset integral component of PID control • 27: UP, remote access, acceleration • 28: DWN, remote access, deceleration • 29: UDC, reset frequency with remote control • 31: OPE, setpoint value through keypad • 32 to 38: Bitwise fixed frequencies • 39: OLR, change over current limit • NO: no, no function 	18	
C002	Function of digital input 2	Values → PNU C001	16	
C003	Function of digital input 3	Values → PNU C001	03	
C004	Function of digital input 4	Values → PNU C001	02	
C005	Function of digital input 5	Values → PNU C001	01	
C011	Digital input 1	<ul style="list-style-type: none"> • 00: Make contact • 01: Break contact 	00	
C012	Digital input 2	Values → PNU C011	00	
C013	Digital input 3	Values → PNU C011	00	
C014	Digital input 4	Values → PNU C011	00	
C015	Digital input 5	Values → PNU C011	00	
C019	Digital input FW	Values → PNU C011	00	
C021	Signal at relay output K23-K24	<ul style="list-style-type: none"> • 00: RUN signal • 01: FA1, frequency reached • 02: FA2, frequency exceeded • 03: OL, Overload • 04: OD, PID deviation exceeded • 05: AL, fault • 06: FA3, frequency reached (1) • 08: IP, mains failure, immediate stop • 09: UV, undervoltage • 11: ONT, mains On time exceeded • 12: RNT, running time exceeded • 13: THM, motor thermal overload 	01	
C022	Signal at relay output K33-K34	Values → PNU C021	00	
C026	Signal at relay terminals K11-K12	Values → PNU C021	05	

PNU	Meaning	Value range	Def.	Setpoint
C027	Output, FM output	<ul style="list-style-type: none"> • 00: Output frequency, PWM signal • 01: Output current • 03: Output frequency, FM signal • 04: Output voltage • 05: Inverter input power • 06: Thermal load ratio • 07: Ramp frequency 	00	
C028	Output, AM output	<ul style="list-style-type: none"> • 00: Output frequency, PWM signal • 01: Output current • 04: Output voltage • 05: Inverter input power • 06: Thermal load ratio • 07: Ramp frequency 	00	
C029	Output, AMI output	Values → PNU C028	00	
C031	Relay output K23-K24	<ul style="list-style-type: none"> • 00: Make contact • 01: Break contact 	00	
C032	Relay output K33-K34	Values → PNU C031	00	
C036	Relay terminals K11-K12, signalling relay	Values → PNU C031	01	
C040	Overload alarm signal	<ul style="list-style-type: none"> • 00: Always • 01: Only at constant speed 	01	
C041	Overload alarm threshold at relay output K11 to K34	0 to $2 \times I_e$ [A]	I_e	
C042	Frequency from which FA2 is switched on during acceleration	0.00 to 400 Hz	0.00	
C043	Frequency from which FA2 is switched off during deceleration	0.00 to 400 Hz	0.00	
C044	PID control deviation (from the maximum set point value)	0 to 100 %	3.0	
C070	Serial interface, programming through:	<ul style="list-style-type: none"> • 02: Keypad • 03: RS 485 serial interface • 04: Optional module in slot 1 • 54: Optional module in slot 2 	02	
C071	Baud rate	<ul style="list-style-type: none"> • 03: 2400 bit/s • 04: 4800 bit/s • 05: 9600 bit/s • 06: 19200 bit/s 	04	
C072	Address	01 to 32	1	
C073	Data word length:	7 or 8-bit	7	
C074	Parity	<ul style="list-style-type: none"> • 00: None • 01: Even • 02: Odd 	00	
C075	Stop bits:	1 or 2	1	
C078	Transmission waiting time	0 to 1000 ms	0	
C081	Compensation of setpoint signal at terminal O	0 to 65530	Depending on inverter model	
C082	Compensation of setpoint signal at terminal OI	0 to 65530		
C083	Compensation of setpoint signal at terminal O2	0 to 65530		
C085	Thermistor matching	0 to 1000	105	
C086	Offset, AM terminal	0 to 10 V	0.0	

PNU	Meaning	Value range	Def.	Setpoint
C087	Gain, AMI terminal	0 to 255	80	
C088	Offset, AMI terminal	0 to 20 mA	0.0	
C091	Debug mode	<ul style="list-style-type: none"> • 00: Debug mode On • 01: Debug mode Off 	00	
C101	Use saved UP/DWN setting	<ul style="list-style-type: none"> • 00: Use PNU A020 • 01: Use saved UP/DWN frequency 	00	
C102	Reset signal	<ul style="list-style-type: none"> • 00: On rising edge • 01: On falling edge • 02: On rising edge, only on fault 	00	
C103	Behaviour on reset	<ul style="list-style-type: none"> • 00: 0 Hz start • 01: Synchronization to the motor speed 	00	
C121	Zero-point matching, terminal O	0 to 65530 (6553)	Depending on inverter model	
C122	Zero-point matching, terminal OI	0 to 65530 (6553)		
C123	Zero-point matching, terminal O2	0 to 65530 (6553)		

PNU	Meaning
d001	Output frequency display
d002	Output current display
d003	Direction of rotation display
d004	PID feedback display
d005	Status of digital inputs 1 to 8
d006	Status of digital outputs 11 to 15
d007	Scaled output frequency
d013	Output voltage
d014	Electrical input power
d016	Running time
d017	Mains On time
d080	Total number of malfunctions
d081	First (most recent) fault
d082	Second fault
d083	Third fault
d084	Fourth fault
d085	Fifth fault
d086	Sixth fault
d090	Warning

PNU	Meaning	Value range	Def.	Setpoint
F001	Frequency setpoint value	0.00 to 400 Hz	0.0	
F002	Acceleration time 1	0.01 to 3600 s	30.0	
F202	Acceleration time 1 (second parameter set)	0.01 to 3600 s	30.0	
F003	Deceleration time 1	0.01 to 3600 s	30.0	
F203	Deceleration time 1 (second parameter set)	0.01 to 3600 s	30.0	
F004	Direction of rotation	<ul style="list-style-type: none"> • 00: Clockwise operation • 01: Anticlockwise operation 	00	

PNU	Meaning	Value range	Def.	Setpoint
H003	Motor rating	0.2 to 160 kW	Depending on inverter model	
H203	Motor rating (second parameter set)	0.2 to 160 kW		
H004	Number of motor poles	2, 4, 6, 8	4	
H204	Number of motor poles (second parameter set)	2, 4, 6, 8	4	
H006	Motor stabilization constant	0 to 255	100	
H206	Motor stabilization constant (second parameter set)	0 to 255	100	

PNU	Meaning	Value range	Def.	Setpoint
U001	User-defined parameters	PNU A001 to H206	no	
U002			no	
U003			no	
U004			no	
U005			no	
U006			no	
U007			no	
U008			no	
U009			no	
U010			no	
U011			no	
U012			no	