

BECKHOFF New Automation Technology

Product Overview 2007

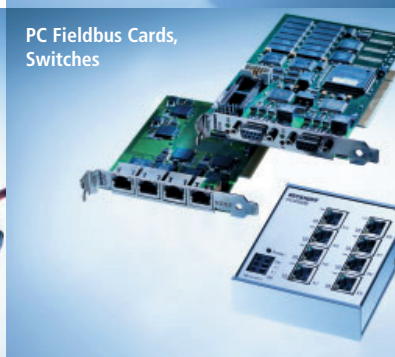

IPC

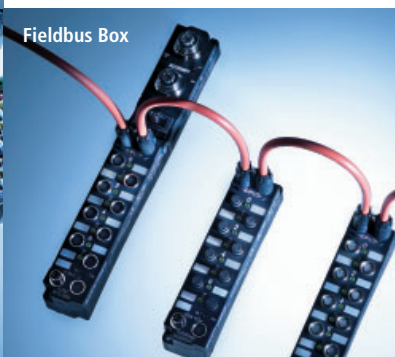
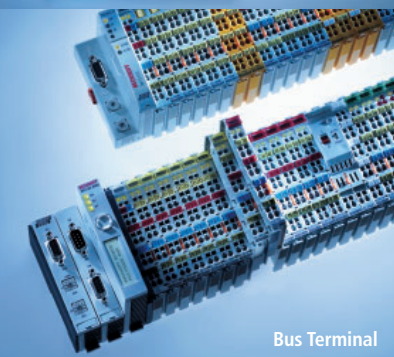
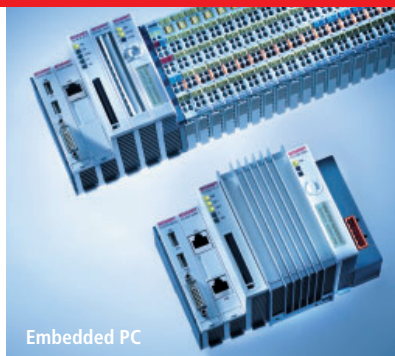

Automation

I/O

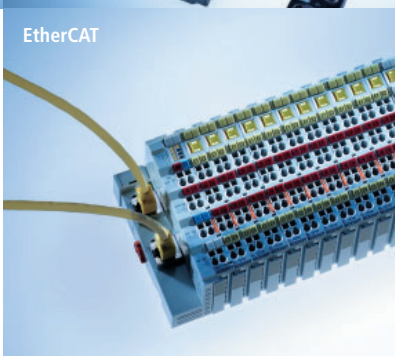

Motion



Beckhoff Product Overview 2007 | The product overview is a condensed summary of the components and system solutions for Industrial PCs, Fieldbus Components, Drive Technology and automation software. The main "New Automation Technology" catalog and the web pages at www.beckhoff.com contain detailed descriptions, technical data and information about accessories.

IPC		8	Beckhoff Industrial PC PC Control for all applications
		22	Beckhoff Embedded PC The modular Industrial PC for mid-range control
I/O		26	Beckhoff Fieldbus Components I/Os for all common fieldbus systems
		32	Beckhoff Bus Terminal The modular fieldbus system for automation
		42	Beckhoff EtherCAT Ultra high-speed I/O
		52	Beckhoff Fieldbus Box The compact IP 67 modules
		58	Beckhoff Lightbus The fast fibre optic fieldbus
		62	Beckhoff PC Fieldbus Cards, Switches The intelligent interface generation
Motion		66	Beckhoff Drive Technology The drive system for high dynamic positioning tasks
Automation		78	Beckhoff TwinCAT PLC and Motion Control on the PC

Beckhoff New Automation Technology

Beckhoff implements open automation systems based on PC Control technology. The product range covers Industrial PCs, I/O and Fieldbus Components, Drive Technology and automation software. Products that can be used as separate components or integrated into a complete and seamless control system are available for all industries. The Beckhoff "New Automation Technology" philosophy stands for universal and open control and automation solutions that are used worldwide in a wide variety of different applications, ranging from CNC-controlled machine tools to intelligent building automation.

Innovative products and a full range of services

Since the foundation of the company in 1980, continuous development of innovative products and solutions using PC-based control technology has been the basis for the continued success of Beckhoff. Many automation technology standards that are taken for granted today were conceptualised by Beckhoff at an early stage and successfully introduced to the market:

- 1982: P1000 – single-board motion controller
- 1986: PC Control – first PC-based machine controller
- 1989: Lightbus – high-speed fieldbus utilising optical fibre
- 1990: All-in-one PC motherboard
- 1995: Bus Terminal – fieldbus technology in terminal block format
- 1996: TwinCAT – real-time software package under Windows with PLC and Motion Control functions
- 1998: Control Panel – remote IPC Control Panels
- 2002: CX1000 – modular Embedded PCs for DIN rail mounting
- 2003: EtherCAT – real-time Ethernet fieldbus system
- 2005: TwinSAFE – safety solution for the Bus Terminal system
- 2005: AX5000 – EtherCAT Servo Drive

The Beckhoff PC Control philosophy and the invention of the Lightbus system, the Bus Terminals and TwinCAT automation software represent milestones in automation technology and have become accepted as high-performance alternatives to traditional control technology. EtherCAT, the real-time Ethernet solution, makes forward-looking, high-performance technology available for a new generation of leading edge control concepts.

World-wide presence on all continents

The central divisions of Beckhoff, such as development, production, administration, distribution, marketing, support and service are located at the Beckhoff Automation GmbH headquarters in Verl, Germany. Rapidly growing presence in the international market is taking place through subsidiaries in Austria, Belgium, Denmark, Finland, France, Italy, Lithuania, Poland, Russia, Spain, Sweden, Switzerland, as well as Australia, Brazil, China, Canada, South Africa and the USA. Through worldwide co-operation with partners, Beckhoff is represented in more than 60 countries.

Automation

Beckhoff | The Automation Company

Beckhoff offers comprehensive system solutions in different performance classes for all areas of automation. Beckhoff control technology is scalable – from high-performance Industrial PCs to mini PLCs – and can be adapted precisely to the respective application. TwinCAT automation software integrates real-time control with PLC, NC and CNC functions in a single package. All Beckhoff controllers are programmed using TwinCAT in accordance with the globally-recognised IEC 61131-3 programming standard.

IPC

Beckhoff | The IPC Company

Beckhoff supplies the right Industrial PC for every application. High-quality components based on open standards and the rugged construction of the device housings mean that the Industrial PCs are ideally equipped for all control requirements. Embedded PCs make modular IPC technology available in miniature format for DIN rail mounting. In addition to their application in automation, Beckhoff Industrial PCs are also ideally suited to other kinds of tasks – wherever reliable and robust PC technology is required.

I/O

Beckhoff | The I/O Company

Beckhoff has the right technology for every signal and every fieldbus. Beckhoff supplies a complete range of Fieldbus Components for all common I/Os and fieldbus systems. With the Bus Terminals in protection class IP 20, and the Fieldbus Box modules in IP 67, a complete range is available for all important signal types and fieldbus systems. In addition to classic fieldbus systems, high-performance EtherCAT technology opens up great, new potential for control technology.

Motion

Beckhoff | The Motion Company

In combination with the Motion Control solutions offered by the TwinCAT automation software, Beckhoff Drive Technology represents an advanced and complete drive system. PC-based control technology from Beckhoff is ideally suited for single and multiple axis positioning tasks with highly dynamic requirements. The AX5000 Servo Drive series with high-performance EtherCAT system communication offers maximum performance and dynamics.



BECKHOFF WORLDWIDE



Beckhoff System Overview

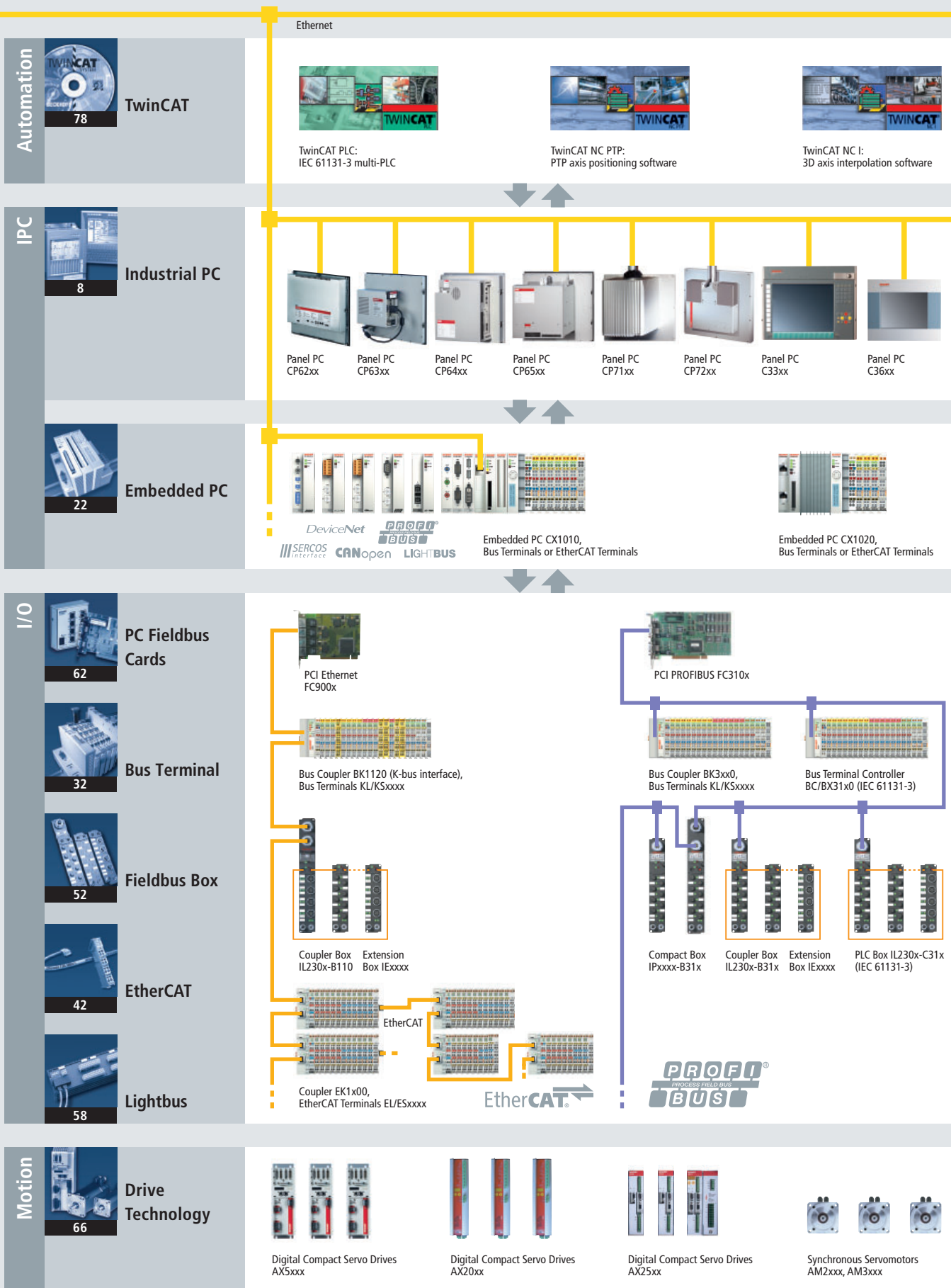



TwinCAT CNC:
CNC path control software



TwinCAT I/O:
I/O software interface



TwinCAT CP:
Control Panel driver



TwinCAT OPC:
Visualisation interface

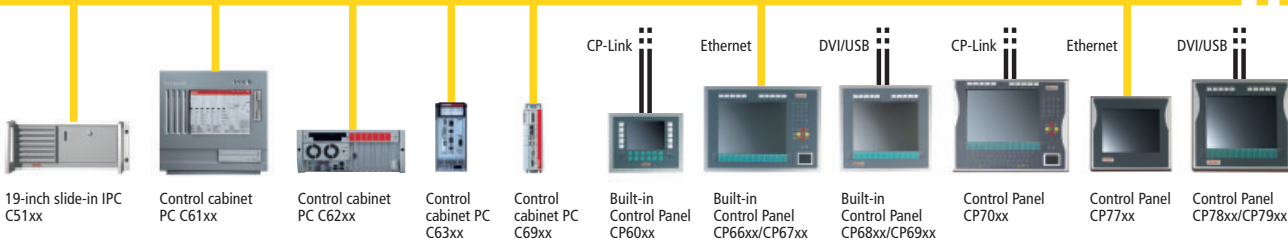

Embedded PC CX1030,
Bus Terminals or EtherCAT Terminals



Embedded PC CX90x0-0000,
EtherCAT Terminals



Embedded PC CX90x0-1000,
Bus Terminals

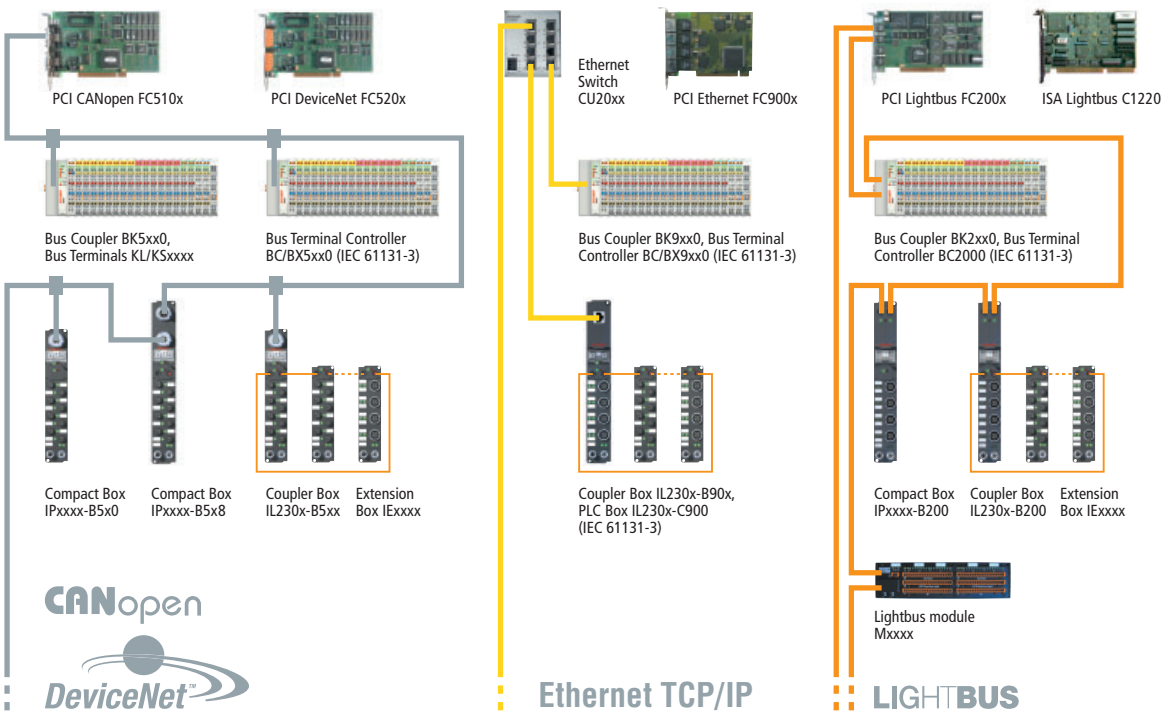

Linear Servomotors
AL2xxx, AL3xxx

Stepper Motors
AS1xxx

INDUSTRIAL PC

PC Control for all applications

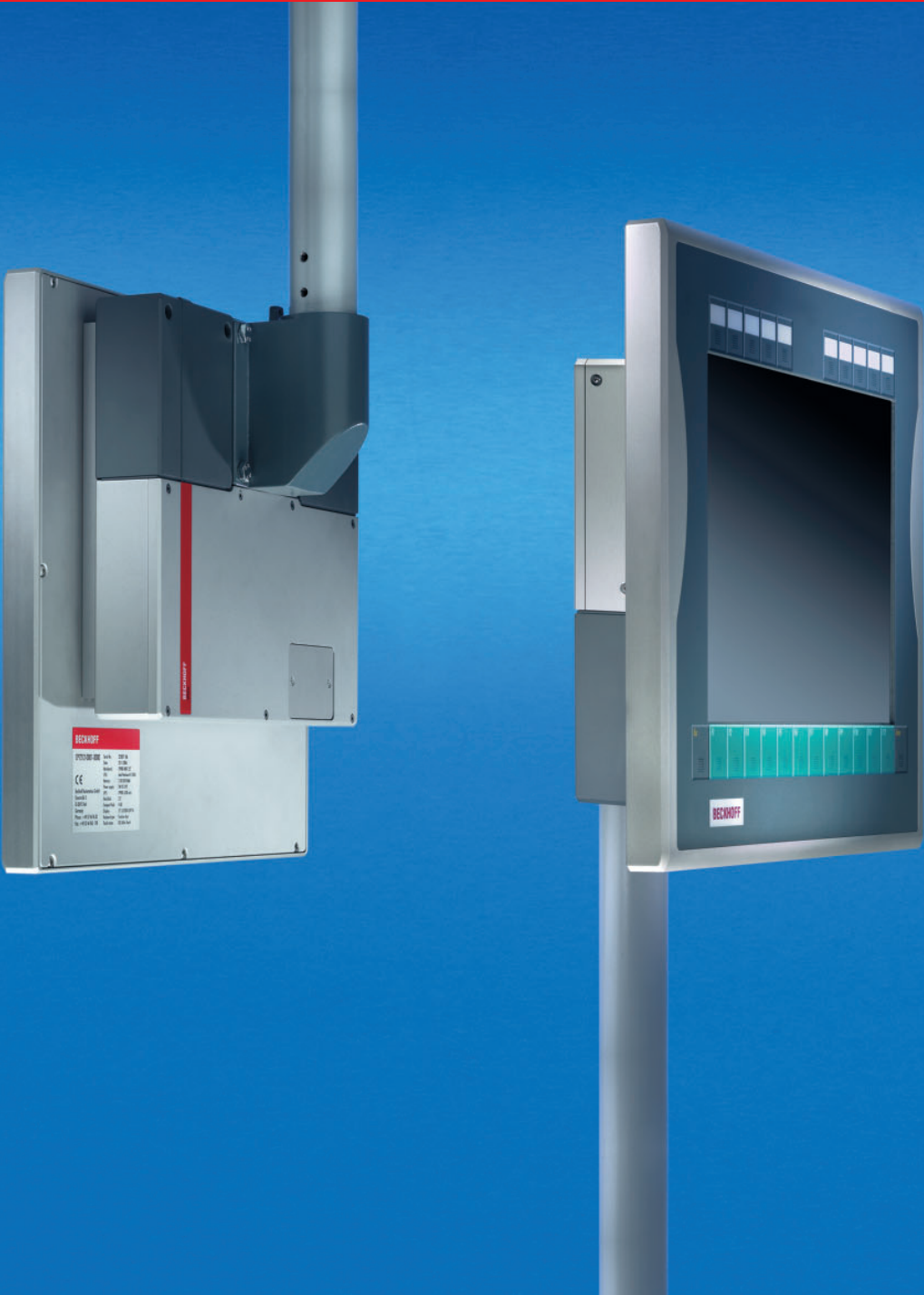

Robust industrial design PCs with highest performance components

Beckhoff Industrial PCs satisfy industry's demands:

- the right Industrial PC for every controller
 - highest performance PCs with Intel® Pentium® 4, Intel® Pentium® M and Core™ Duo processors
 - open standards following the ATX norm
 - components carefully tested to ensure appropriateness for industrial applications
- appealing industrial design housings
 - easy access to PC components
 - Individual housing construction allows optimum adaptation to controller requirements.
 - integration of electromechanical buttons, switches, scanner, handwheel and other components in the Control Panel



The personal computer has experienced an unprecedented success story and has become a firmly established part of everyday life, including industrial environments. Together with associated software, PCs in different shapes and forms are at the core of a wide range of diverse automation tasks such as control of machines, processes or logistics systems, networking of system components, data acquisition, or image processing. For classic control tasks, PC-based control technology offers excellent scalability and flexibility and is therefore increasingly being used in place of hardware PLCs.

Beckhoff is one of the pioneers of PC-based automation: The first PC control system was delivered as early as 1986. Beckhoff Industrial PCs are characterised by a wealth of technology know-how accumulated over recent years. In combination with the TwinCAT automation software, they offer a high-performance control system for PLC, NC and CNC functionalities.

An important feature of the Beckhoff product philosophy is the use of advanced,

high-performance components and processors for the development and design of Industrial PCs: They integrate the latest developments offered by the technology market and are used successfully worldwide.

In addition to long-standing experience, another factor driving the development of our comprehensive IPC product portfolio is customer-orientation. Six IPC series with a wide range of basic PC types form the basis of our product range. For any type of application, a suitable control computer can be configured from a large number of devices and options.

The PC housing is made from stainless steel and varies in size between paper-back format to 14-slot passive backplane, depending on the device type.

Elegant Control Panels

The IPC is complemented by an industrial display unit. The Beckhoff Control Panels are the visual front end for machines or plants. Spatial separation of display/control unit and control computer offers maximum

flexibility. Appealing design, robustness and suitability for industrial applications were important criteria in the development of the Control Panel series, which comes with display sizes between 6.5" and 19".

Careful selection of components

All IPC components are carefully selected to ensure compatibility, long-term availability, mechanical load-bearing capacity, and suitability for industrial applications. The development of Beckhoff all-in-one IPC motherboards, interface cards, low voltage supply units, keyboard and UPS controllers and other electronic modules is based on the stringent requirements for Industrial PC components, in order to ensure safe operation now and in future. International standards and experience in the application of PC systems under difficult industrial conditions provide the basis for Beckhoff system integration.





The built-in Control Panels are the front of the Panel PCs.



Four different Panel PCs with high performance components are available.



The Panel PCs CP6xxx are designed for installation in the front of a control cabinet.

CP6xxx | Built-in Panel PC



	CP62xx	CP63xx	CP64xx	CP65xx
Display	12-, 15- or 19-inch TFT display	10-, 12-, 15- or 19-inch LC display	10-, 12-, 15- or 19-inch LC display	10-, 12-, 15- or 19-inch LC display
Processor	Intel® Celeron® M or Pentium® M	Intel® Celeron® M or Pentium® M	Intel® Celeron® M or Pentium® M	Intel® Celeron®, Pentium® 4, Celeron® M, Pentium® M or Core™ Duo, Core™2 Duo*
Motherboard	3 1/2-inch	passive backplane	passive backplane	ATX
Slots	1	3	4	7
Free slots	1 Mini PCI	1 PCI	2 PCI	6 PCI
Memory	256 MB ... 2 GB DDR RAM	256 MB ... 2 GB DDR RAM	256 MB ... 2 GB DDR RAM	256 MB ... 2 GB DDR RAM
Graphic adapter	on-board	on-board	on-board	on-board
Ethernet	2 on-board	2 on-board	2 on-board	on-board
Max. card length	Mini PCI	1 x 190 mm	2 x 190 mm	7 x 190 mm
Hard disks	2 1/2-inch and/or CF card or 2 CF cards	1 x 2 1/2-inch	1 x 2 1/2-inch	1 x 3 1/2-inch
Possible disk drives		CD/DVD-ROM or multi DVD 4.7 GB	CD/DVD-ROM or multi DVD 4.7 GB	CD/DVD-ROM or multi DVD 4.7 GB
Power supply	24 V DC	24 V DC	100 ... 240 V AC or 24 V DC	100 ... 240 V AC or 24 V DC
Dimen. (W x H x D)	depending on built-in Control Panel (see main catalog)			

* The PCs with Core™ Duo or Core™2 Duo processors have 3 free PCI and 3 free PCIe slots as well as 512 MB ... 2 GB DDR RAM memory capacity.

The Panel PC has various drives that are easily accessible.



The CP71xx combines highest performance with compact design.

Panel PC CP71xx



The IP 65 Panel PC captivates by its compact design and sophisticated connection technology.

CP7xxx | Panel PC



	CP71xx	CP72xx
Display	10-, 12-, 15- or 19-inch LC display	12-, 15- or 19-inch TFT display
Processor	Intel® Celeron® M or Pentium® M	Intel® Celeron® M or Pentium® M
Motherboard	passive backplane	3 1/2-inch
Slots	4	1 Mini PCI
Free slots	1 PCI	1 Mini PCI
Memory	256 MB ... 2 GB DDR RAM	256 MB ... 2 GB DDR RAM
Graphic adapter	on-board	on-board
Ethernet	2 on-board	2 on-board
Max. card length	1 x 190 mm	
Hard disks	1 x 2 1/2-inch	1-2 x 2 1/2-inch or 1 x CF card and 1 x 2 1/2-inch
Possible disk drives	CD/DVD-ROM or multi DVD 4.7 GB	
Power supply	24 V DC	24 V DC
Dimen. (W x H x D)	depending on Control Panel (see main catalog/news catalog)	



CD/DVD drive under the lockable front flap



The mounting frame for withdrawal of the PC allows it to be mounted from the front.



If the front door is open, it is possible to access all the components.



Connection cables are accessible from the side, as soon as the computer core slides out.

C33xx | 19-inch Panel PC



	C3320	C3330	C3340	C3350
Display	12-inch TFT display, resolution 800 x 600	12-inch TFT display, resolution 800 x 600	15-inch TFT display, resolution 1024 x 768	15-inch TFT display, resolution 1024 x 768
Processor	Intel® Celeron®, Pentium® 4, Celeron® M, Pentium® M or Core™ Duo, Core™2 Duo*	Intel® Celeron®, Pentium® 4, Celeron® M, Pentium® M or Core™ Duo, Core™2 Duo*	Intel® Celeron®, Pentium® 4, Celeron® M, Pentium® M or Core™ Duo, Core™2 Duo*	Intel® Celeron®, Pentium® 4, Celeron® M, Pentium® M or Core™ Duo, Core™2 Duo*
Motherboard	ATX	ATX	ATX	ATX
Slots	7	7	7	7
Free slots	6 PCI	6 PCI	6 PCI	6 PCI
Memory	256 MB ... 2 GB DDR RAM	256 MB ... 2 GB DDR RAM	256 MB ... 2 GB DDR RAM	256 MB ... 2 GB DDR RAM
Graphic adapter	on-board	on-board	on-board	on-board
Ethernet	on-board	on-board	on-board	on-board
Max. card length	3 x fullsize, 4 x 240 mm	3 x fullsize, 4 x 240 mm	3 x fullsize, 4 x 240 mm	3 x fullsize, 4 x 240 mm
Hard disks	1 or 2 x 3 1/2-inch	1 or 2 x 3 1/2-inch	1 or 2 x 3 1/2-inch	1 or 2 x 3 1/2-inch
Possible disk drives	CD/DVD-ROM, multi DVD 4.7 GB	CD/DVD-ROM, multi DVD 4.7 GB	CD/DVD-ROM, multi DVD 4.7 GB	CD/DVD-ROM, multi DVD 4.7 GB
Power supply	100 ... 240 V AC or 24 V DC	100 ... 240 V AC or 24 V DC	100 ... 240 V AC or 24 V DC	100 ... 240 V AC or 24 V DC
Dimen. (W x H x D)	482.7 x 355 x 282 mm	482.7 x 400 x 282 mm	482.7 x 355 x 282 mm	482.7 x 444 x 282 mm

* The PCs with Core™ Duo or Core™2 Duo processors have 3 free PCI and 3 free PCIe slots as well as 512 MB ... 2 GB DDR RAM memory capacity.

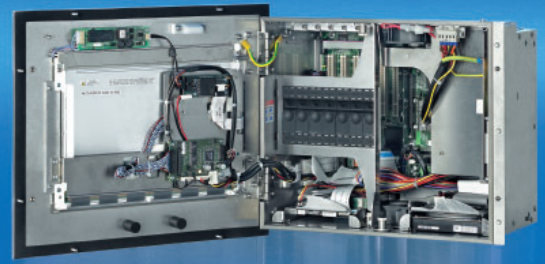

The built-in Industrial PC series C36xx is designed for installation into the front of a control cabinet.



The housing is opened from the back. All components are rapidly and easily accessible.



The built-in Industrial PCs are fitted with a 12- or 15-inch TFT touch display.

C36xx | Panel PC



	C3620	C3640
Display	12-inch TFT display, resolution 800 x 600	15-inch TFT display, resolution 1024 x 768
Processor	Intel® Celeron®, Pentium® 4, Celeron® M, Pentium® M or Core™ Duo, Core™2 Duo*	Intel® Celeron®, Pentium® 4, Celeron® M, Pentium® M or Core™ Duo, Core™2 Duo*
Motherboard	ATX	ATX
Slots	7	7
Free slots	6 PCI	6 PCI
Memory	256 MB ... 2 GB DDR RAM	256 MB ... 2 GB DDR RAM
Graphic adapter	on-board	on-board
Ethernet	on-board	on-board
Max. card length	7 x 220 mm	7 x 235 mm
Hard disks	1 x 3 1/2-inch	1 x 3 1/2-inch
Possible disk drives	CD/DVD-ROM, multi DVD 4.7 GB drive	slimline CD/DVD-ROM, multi DVD 4.7 GB drive
Power supply	100 ... 240 V AC or 24 V DC	100 ... 240 V AC or 24 V DC
Dimen. (W x H x D)	388 x 324 x 201 mm	470 x 348 x 199 mm

* The PCs with Core™ Duo or Core™2 Duo processors have 3 free PCI and 3 free PCIe slots as well as 512 MB ... 2 GB DDR RAM memory capacity.





The 19-inch slide-in Industrial PC series C51xx is designed for installation into 19-inch racks.



The 19-inch slide-in housing has plenty of internal space for extensions of any form.

All kinds of drives can be installed behind the lockable front door.

C51xx | 19-inch slide-in Industrial PC



	C5101	C5102
Processor	Intel® Celeron® M or Pentium® M	Intel® Celeron®, Pentium® 4, Celeron® M, Pentium® M or Core™ Duo, Core™2 Duo*
Motherboard	passive backplane	ATX
Slots	14	7
Free slots	11 PCI	6 PCI
Memory	256 MB ... 2 GB DDR RAM	256 MB ... 2 GB DDR RAM
Graphic adapter	on-board	on-board
Ethernet	2 on-board	on-board
Max. card length	8 x fullsize, 6 x 190 mm	7 x fullsize
Hard disks	1, 2 or 3 x 3 1/2-inch	1, 2 or 3 x 3 1/2-inch
Possible disk drives	CD/DVD-ROM, multi DVD 4.7 GB	CD/DVD-ROM, multi DVD 4.7 GB
Power supply	100 ... 240 V AC or 24 V DC	100 ... 240 V AC or 24 V DC
Dimen. (W x H x D)	483 x 177 x 500 mm	483 x 177 x 500 mm

* The PCs with Core™ Duo or Core™2 Duo processors have 3 free PCI and 3 free PCIe slots as well as 512 MB ... 2 GB DDR RAM memory capacity.



All connections on the top

Inner chassis can be removed for service purposes.

ATX norm motherboard

Plug-in cards quickly reached

Passive side wall: fitting possible immediately next to other devices

Fan with speed observation and double ball bearings, easily exchangeable from the front

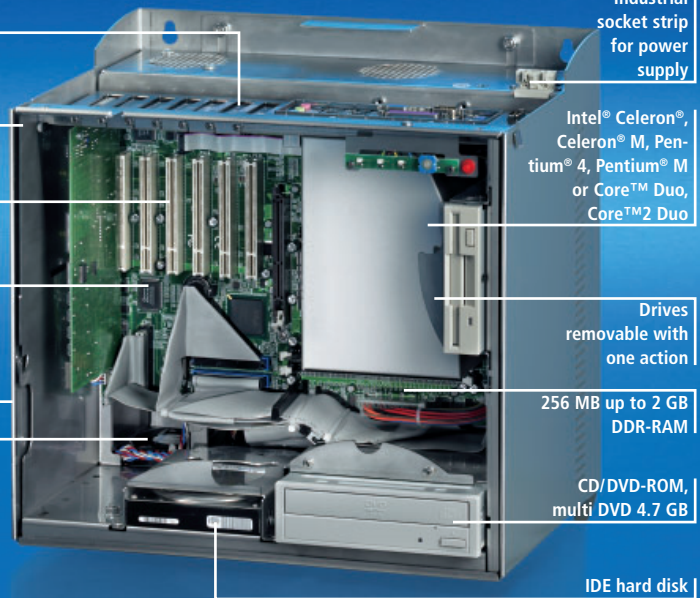

Industrial socket strip for power supply

Intel® Celeron®, Celeron® M, Pentium® 4, Pentium® M or Core™ Duo, Core™2 Duo

Drives removable with one action

256 MB up to 2 GB DDR-RAM

CD/DVD-ROM, multi DVD 4.7 GB

IDE hard disk

C61xx | Control cabinet Industrial PC



	C6110	C6120	C6130	C6140	C6150
Processor	Intel® Celeron® M or Pentium® M	Intel® Celeron® M or Pentium® M	Intel® Celeron® M or Pentium® M	Intel® Celeron®, Pentium® 4, Celeron® M, Pentium® M or Core™ Duo, Core™2 Duo*	Intel® Celeron®, Pentium® 4, Celeron® M, Pentium® M or Core™ Duo, Core™2 Duo*
Motherboard	passive backplane	passive backplane	passive backplane	ATX	ATX
Slots	4	5	8	7	7
Free slots	1 PCI	2 PCI	6 PCI	6 PCI	6 PCI
Memory	256 MB ... 2 GB DDR RAM	256 MB ... 2 GB DDR RAM	256 MB ... 2 GB DDR RAM	256 MB ... 2 GB DDR RAM	256 MB ... 2 GB DDR RAM
Graphic adapter	on-board	on-board	on-board	on-board	on-board
Ethernet	2 on-board	2 on-board	2 on-board	on-board	on-board
Max. card length	4 x 190 mm	5 x fullsize	4 x fullsize, 4 x 25 cm	3 x 270 mm and 4 x 240 mm	7 x fullsize
Hard disks	1 x 2 1/2-inch	1 x 3 1/2-inch	1–3 x 3 1/2-inch	1–3 x 3 1/2-inch	1–3 x 3 1/2-inch
Possible disk drives		CD/DVD-ROM, multi DVD 4.7 GB	CD/DVD-ROM, multi DVD 4.7 GB	CD/DVD-ROM, multi DVD 4.7 GB	CD/DVD-ROM, multi DVD 4.7 GB
Power supply	100 ... 240 V AC or 24 V DC	100 ... 240 V AC or 24 V DC	100 ... 240 V AC or 24 V DC	100 ... 240 V AC or 24 V DC	100 ... 240 V AC or 24 V DC
Dimen. (W x H x D)	180 x 287 x 250 mm	195 x 423 x 250 mm	295 x 423 x 250 mm	383 x 362 x 265 mm	383 x 423 x 265 mm

* The PCs with Core™ Duo or Core™2 Duo processors have 3 free PCI and 3 free PCIe slots as well as 512 MB ... 2 GB DDR RAM memory capacity.



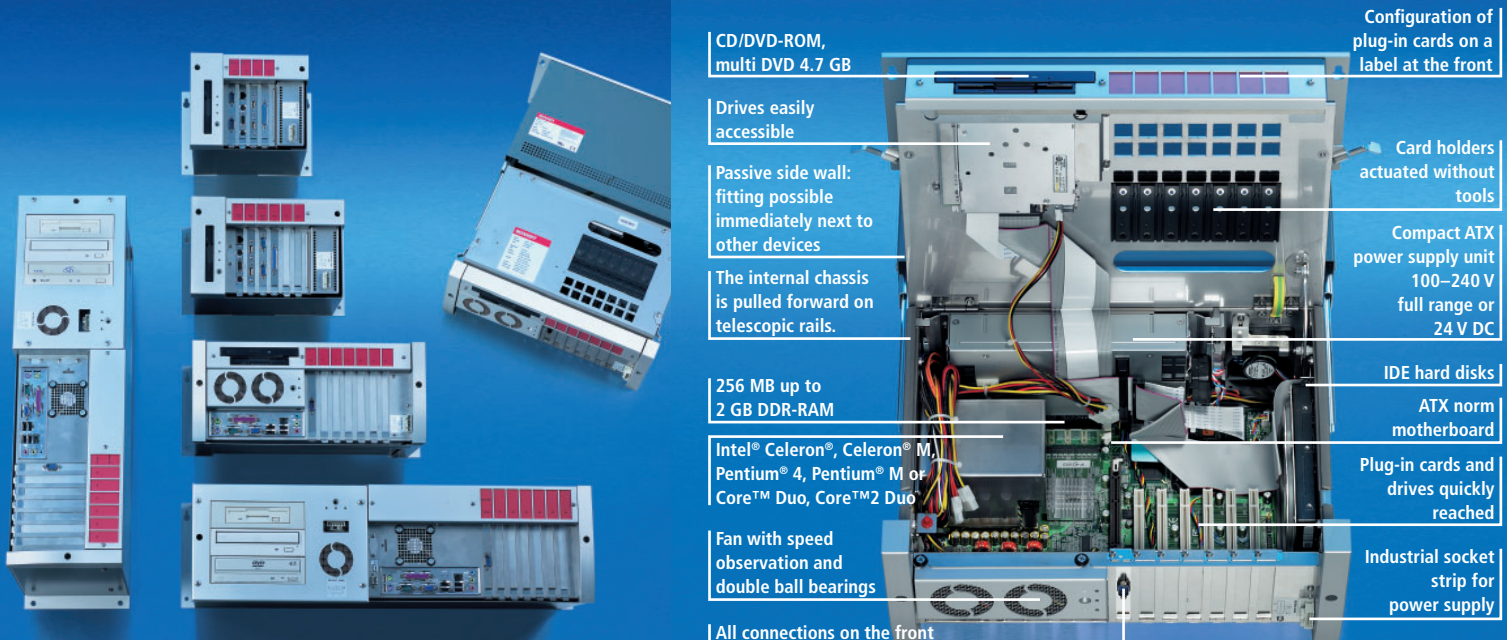

C62xx | Control cabinet Industrial PC



	C6210	C6220	C6240	C6250
Processor	Intel® Celeron® M or Pentium® M	Intel® Celeron® M or Pentium® M	Intel® Celeron®, Pentium® 4, Celeron® M, Pentium® M or Core™ Duo, Core™2 Duo*	Intel® Celeron®, Pentium® 4, Celeron® M, Pentium® M or Core™ Duo, Core™2 Duo*
Motherboard	passive backplane	passive backplane	ATX	ATX
Slots	4	6	7	7
Free slots	1 PCI	3 PCI	6 PCI	6 PCI
Memory	256 MB ... 2 GB DDR RAM	256 MB ... 2 GB DDR RAM	256 MB ... 2 GB DDR RAM	256 MB ... 2 GB DDR RAM
Graphic adapter	on-board	on-board	on-board	on-board
Ethernet	2 on-board	2 on-board	on-board	on-board
Max. card length	4 x 190 mm	6 x 190 mm	7 x 190 mm	7 x 190 mm
Hard disks	1 x 2 1/2-inch	1 x 2 1/2-inch	1 x 3 1/2-inch or 2 x 2 1/2-inch	1, 2 or 3 x 3 1/2-inch
Possible disk drives	CD/DVD-ROM, multi DVD 4.7 GB	CD/DVD-ROM, multi DVD 4.7 GB	CD/DVD-ROM, multi DVD 4.7 GB	CD/DVD-ROM and multi DVD 4.7 GB
Power supply	100 ... 240 V AC or 24 V DC	100 ... 240 V AC or 24 V DC	100 ... 240 V AC or 24 V DC	100 ... 240 V AC or 24 V DC
Dimen. (W x H x D)	257 x 170 x 286 mm	307 x 170 x 286 mm	430 x 170 x 274 mm	680 x 184 x 270 mm

* The PCs with Core™ Duo or Core™2 Duo processors have 3 free PCI and 3 free PCIe slots as well as 512 MB ... 2 GB DDR RAM memory capacity.

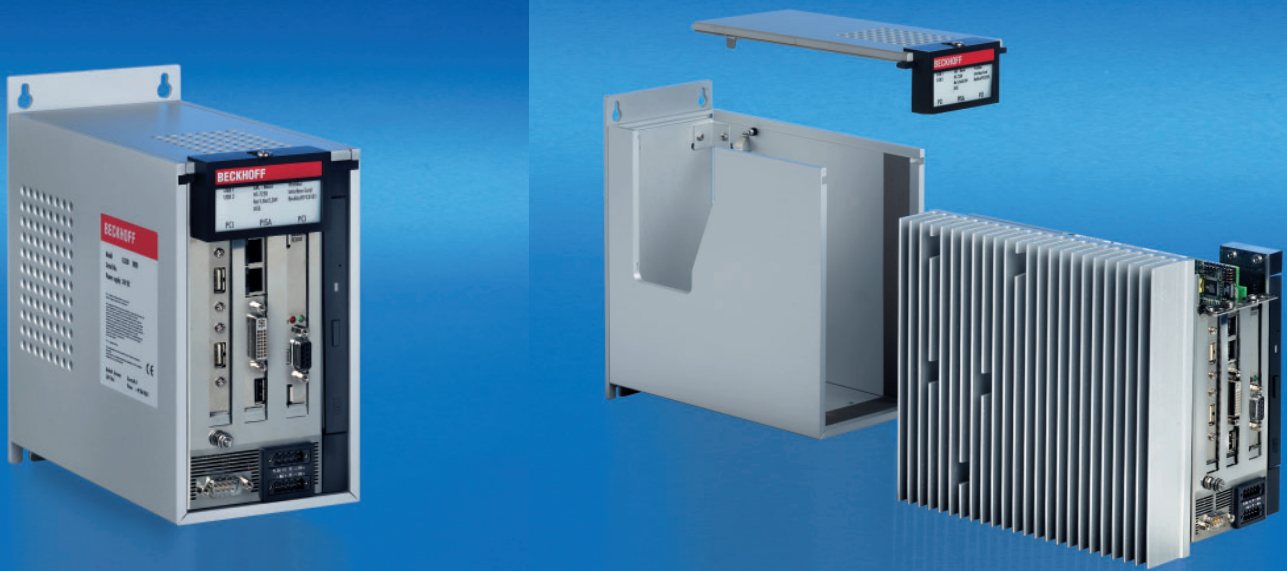

C63xx | Control cabinet Industrial PC



	C6320	C6325	C6330	C6335	C6340	C6350
Processor	Intel® Celeron® M or Pentium® M	Intel® Celeron® M or Pentium® M	Intel® Celeron® M or Pentium® M	Intel® Celeron® M or Pentium® M	Intel® Celeron® M or Pentium® M	Intel® Celeron® M or Pentium® M
Motherboard	passive backplane	passive backplane	passive backplane	passive backplane	passive backplane	passive backplane
Slots	3	3	3	3	5	5
Free slots	1 PCI	1 PCI	1 PCI	1 PCI	3 PCI	3 PCI
Memory	256 MB ... 2 GB DDR RAM	256 MB ... 2 GB DDR RAM	256 MB ... 2 GB DDR RAM	256 MB ... 2 GB DDR RAM	256 MB ... 2 GB DDR RAM	256 MB ... 2 GB DDR RAM
Graphic adapter	on-board	on-board	on-board	on-board	on-board	on-board
Ethernet	2 on-board	2 on-board	2 on-board	2 on-board	2 on-board	2 on-board
Max. card length	1 x 190 mm	1 x 190 mm	1 x 190 mm	1 x 190 mm	3 x 190 mm	3 x 190 mm
Hard disks	1 x 2 1/2-inch	1 x 2 1/2-inch	1 x 2 1/2-inch	1 x 2 1/2-inch	1 x 2 1/2-inch	1 x 2 1/2-inch
Possible disk drives			CD/DVD-ROM or multi DVD 4.7 GB	CD/DVD-ROM or multi DVD 4.7 GB		CD/DVD-ROM or multi DVD 4.7 GB
Power supply	24 V DC	24 V DC	24 V DC	24 V DC	24 V DC	24 V DC
Dimen. (W x H x D)	93 x 196 x 226 mm	133 x 196 x 226 mm	107 x 196 x 226 mm	147 x 196 x 226 mm	134 x 196 x 226 mm	148 x 196 x 226 mm





C69xx compact Industrial PC series for control cabinet installation

A free Mini PCI slot is available for extensions e. g. for fieldbus cards.



IPC without mechanically moving parts, due to a flash disk as mass storage

The C6920 has a fan underneath the housing; the C6925 is without fan.

C69xx | Control cabinet Industrial PC



	C6920	C6925
Processor	Intel® Celeron® M 1.5 GHz or Intel® Pentium® M 1.8 GHz	Intel® Celeron® M ULV 1 GHz
Motherboard	3 1/2-inch motherboard	3 1/2-inch motherboard
Free slots	1 Mini PCI	1 Mini PCI
Memory	256 MB ... 2 GB DDR RAM	256 MB ... 2 GB DDR RAM
Graphic system	on-board	on-board
Ethernet	2 on-board	2 on-board
Hard disks	2 1/2-inch and/or CF card or 2 CF cards	2 1/2-inch and/or CF card or 2 CF cards
Power supply	24 V DC	24 V DC
Dimen. (W x H x D)	65 x 231 x 116 mm	65 x 208 x 116 mm



DVI/USB panel
 Standard DVI technologies are used for image transfer and USB for touch screen, keyboard, push-button extensions, etc.; USB is only required for equipment with input devices such as touch screen or keyboard.



DVI-D interface

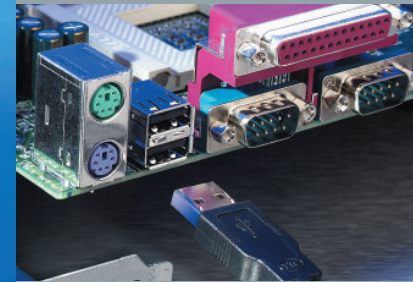

USB interface



Control Panels

CP-Link



CP60xx | Built-in Control Panel, distance Panel/PC = 100 m

Ethernet



CP67xx | Built-in Control Panel, Embedded PC (Pentium®-MMX-compatible CPU, 300 MHz)



CP66xx | "Economy" built-in Control Panel, Embedded PC (ARM CPU, 266 MHz)

DVI/USB



CP68xx | Built-in Control Panel, distance Panel/PC = 5 m (50 m with extension)



CP69xx | "Economy" built-in Control Panel, distance Panel/PC = 50 m



CP70xx | Control Panel, distance Panel/PC = 100 m



CP77xx | Control Panel, Embedded PC (Pentium®-MMX-compatible CPU, 300 MHz)



CP78xx | Control Panel, distance Panel/PC = 5 m (50 m with extension)

CP-Link

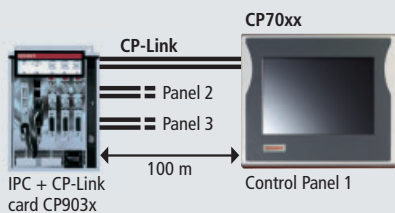
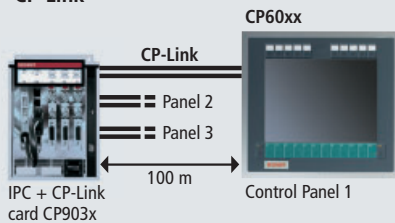

Ethernet

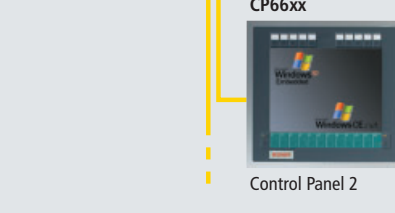
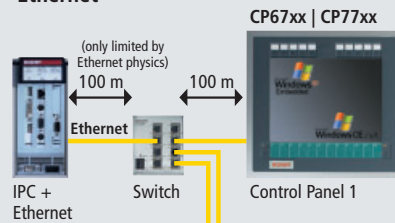

DVI/USB

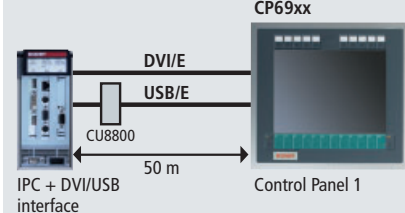
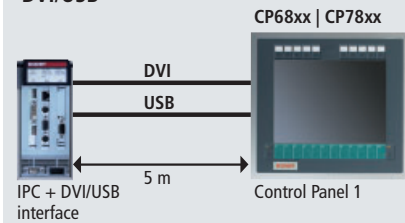

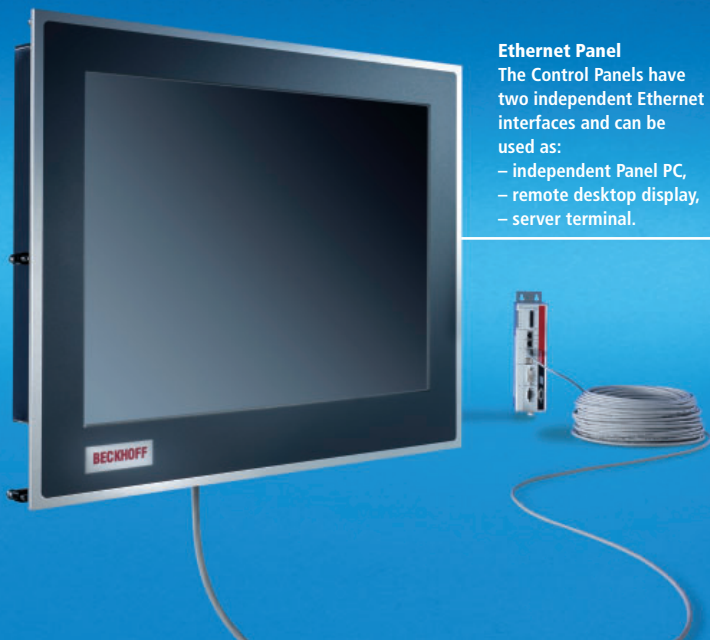

Ethernet Panel
 The Control Panels have two independent Ethernet interfaces and can be used as:

- independent Panel PC,
- remote desktop display,
- server terminal.



CP6xxx | Built-in Control Panel

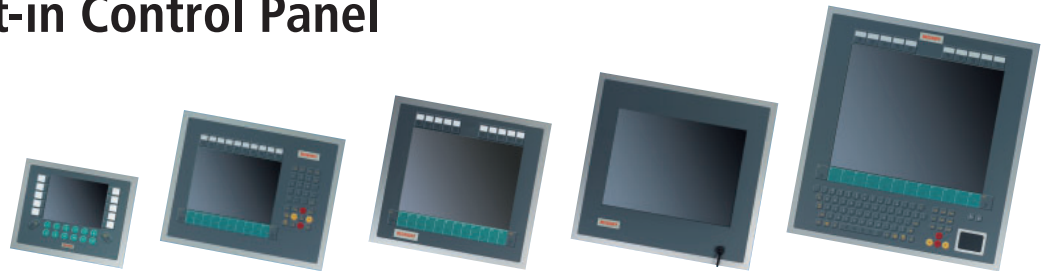

	Display Resolution	6.5-inch 640 x 480	10-inch 640 x 480	12-inch 800 x 600	15-inch 1024 x 768	19-inch 1280 x 1024
CP-Link interface	without keys	CP6009	CP6000	CP6001	CP6002	
	function keys	CP6019	CP6010	CP6011	CP6012	
	numeric	CP6029	CP6020	CP6021	CP6022	
	alphanumeric		CP6030	CP6031	CP6032	
Ethernet interface (Embedded PC) – Intel® IXP420 CPU, 266 MHz	without keys	CP6609		CP6601	CP6602	CP6603
	function keys	CP6619		CP6611	CP6612	CP6613
	numeric	CP6629		CP6621	CP6622	CP6623
	alphanumeric			CP6631	CP6632	CP6633
– Pentium®-MMX-compatible CPU, 300 MHz	without keys	CP6709	CP6700	CP6701	CP6702	
	function keys	CP6719	CP6710	CP6711	CP6712	
	numeric	CP6729	CP6720	CP6721	CP6722	
	alphanumeric		CP6730	CP6731	CP6732	
DVI/USB interface	without keys	CP6809	CP6800	CP6801	CP6802	CP6803
	function keys	CP6819	CP6810	CP6811	CP6812	CP6813
	numeric	CP6829	CP6820	CP6821	CP6822	CP6823
	alphanumeric		CP6830	CP6831	CP6832 CP6842	CP6833
DVI/USB Extended interface	without keys	CP6909		CP6901	CP6902	CP6903
	function keys	CP6919		CP6911	CP6912	CP6913
	numeric	CP6929		CP6921	CP6922	CP6923
	alphanumeric			CP6931	CP6932 CP6942	CP6933

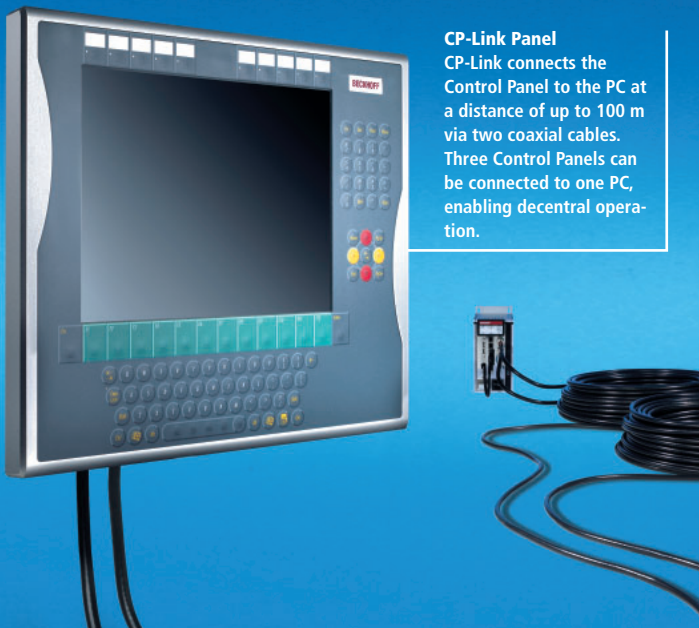

CP-Link Panel
 CP-Link connects the Control Panel to the PC at a distance of up to 100 m via two coaxial cables. Three Control Panels can be connected to one PC, enabling decentral operation.



CP7xxx | Control Panel

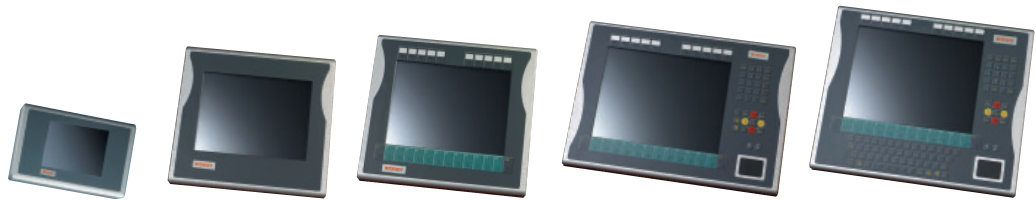

	Display Resolution	6.5-inch 640 x 480	10-inch 640 x 480	12-inch 800 x 600	15-inch 1024 x 768	19-inch 1280 x 1024
CP-Link interface	without keys	CP7009	CP7000	CP7001	CP7002	
	function keys	CP7019	CP7010	CP7011	CP7012	
	numeric	CP7029	CP7020	CP7021	CP7022	
	alphanumeric		CP7030	CP7031 CP7037	CP7032	
Ethernet interface (Embedded PC) – Pentium®-MMX-compatible CPU, 300 MHz	without keys	CP7709	CP7700	CP7701	CP7702	
	function keys	CP7719	CP7710	CP7711	CP7712	
	numeric	CP7729	CP7720	CP7721	CP7722	
	alphanumeric		CP7730	CP7731	CP7732	
DVI/USB interface	without keys	CP7809	CP7800	CP7801	CP7802	CP7803
	function keys	CP7819	CP7810	CP7811	CP7812	CP7813
	numeric	CP7829	CP7820	CP7821	CP7822	CP7823
	alphanumeric		CP7830	CP7831 CP7837	CP7832 CP7842	CP7833
DVI/USB extended interface	without keys	CP7909		CP7901	CP7902	CP7903
	function keys	CP7919		CP7911	CP7912	CP7913
	numeric	CP7929		CP7921	CP7922	CP7923
	alphanumeric			CP7931	CP7932 CP7942	CP7933

EMBEDDED PC

The modular Industrial PC for mid-range control

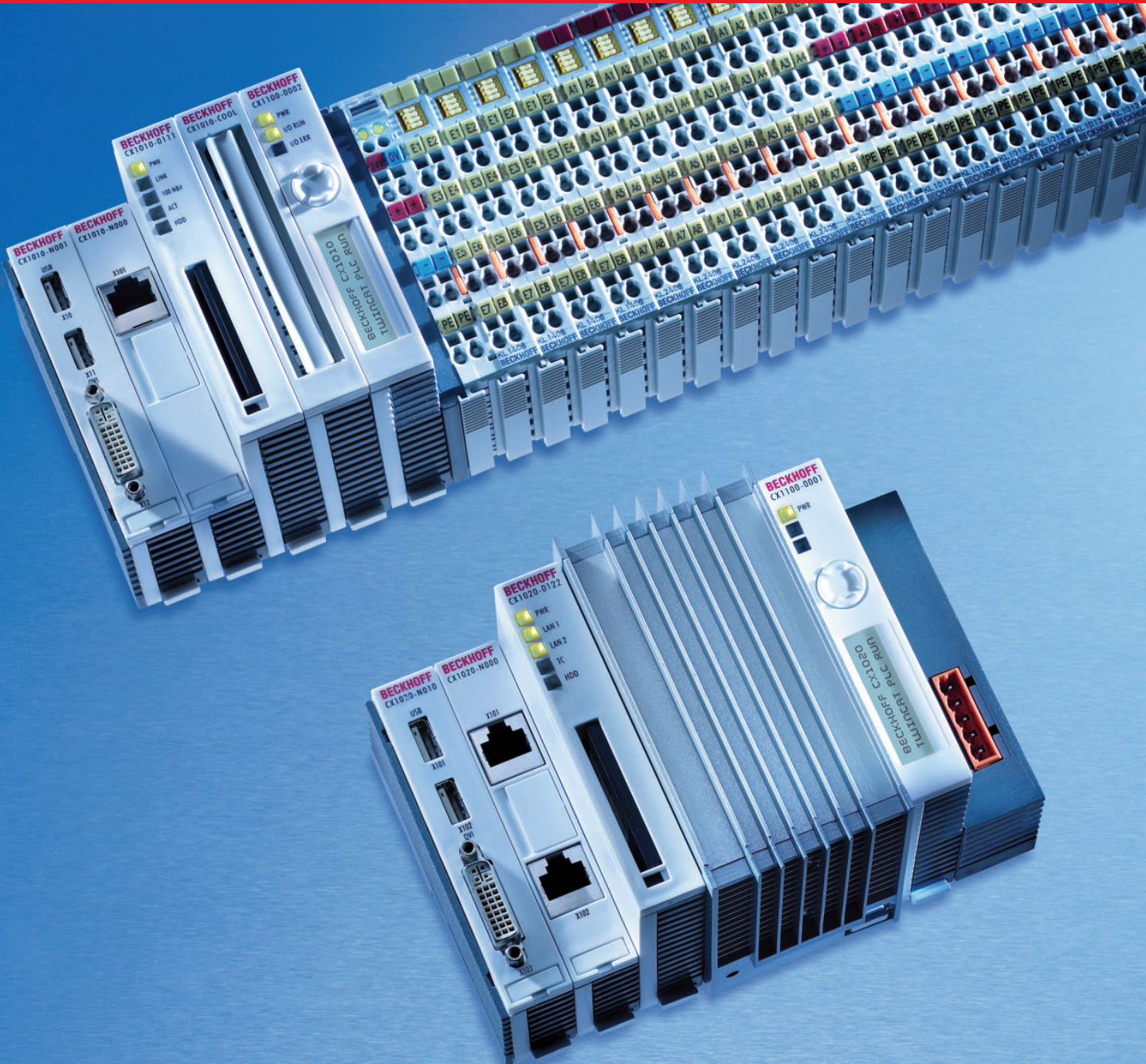

CX series: modular DIN rail Industrial PCs

With the CX series of Embedded PCs, Beckhoff has combined PC technology and modular I/O level to form a DIN rail unit in the control cabinet. The CX device series combines the worlds of Industrial PC and hardware PLC and is suitable for medium-performance control tasks. The modular control system can be configured to match the task in hand and can be installed in the control cabinet or the terminal box.

The CX system covers the whole range of Beckhoff control technology both in terms of price and performance: This product range is designed for tasks requiring the characteristics and computing capacity of Industrial PCs, but whose budget does not stretch to full-blown Industrial PCs. The system only uses the components that are actually required. For example, a CX can be operated in "headless" mode, i.e. without display or keyboard; in this case, the associated interface is not required.

Scalable performance classes

The CX family includes several basic CPU modules with different processors for optimum adaptation to the respective control task:

CX1030: high-performance CX with

Intel® Pentium® M CPU, 1.8 GHz processor

CX1020: high-performance CX with

Intel® Celeron® M ULV CPU, 1 GHz processor

CX1010: basic CX with Pentium® MMX-compatible CPU, 500 MHz processor

CX9010: Ethernet controller with Intel® IXP420 XScale® technology, 533 MHz processor

CX9000: Ethernet controller with Intel® IXP420 XScale® technology, 266 MHz processor

Apart from various CPUs, the individual CX types also have different system interfaces and power supply units. Via associated I/O interfaces the CX1030, CX1020, CX1010, CX9000 and CX9010 Embedded PCs support Beckhoff Bus Terminals and also EtherCAT Terminals as I/O system.

The components

The modules of the CX series system are connected with each other via the standardised PC/104 bus (16-bit). The individual system components come as modules with single (19 mm) or double width (38 mm)

that can be connected in series. The basic unit for the CX1030, CX1020 and CX1010 series consists of a CPU module and a power supply module. The CX9000 and CX9010 devices integrate CPU and power supply in a single unit. Depending on the CX type, the controllers can be expanded through further system interfaces. The range of optional modules is complemented by fieldbus connections for PROFIBUS, CANopen, DeviceNet, SERCOS interface and Lightbus, both as master or slave versions.

The software

In combination with the TwinCAT automation software, the CX Embedded PC becomes a powerful IEC 61131-3 PLC that can also handle Motion Control tasks. Depending on the required cycle time, it may be used to control several servo axes. With the CX1030, CX1020 or CX1010 even special functions such as "flying saw", "electronic gearbox" or "cam plate" can be realised. The CX thus becomes a controller that covers PLC, Motion Control and visualisation tasks with a single hardware. Under Windows CE, thanks to the real-time capability of the operating system, user tasks written in high-level languages can be processed in real-time in parallel with TwinCAT.

Wide range of applications

Due to the design and the features of an industrial PC Control, the Embedded PCs can be used in a wide range of applications. Existing applications include mechanical engineering (automatic sawing machines, automatic assembly machines, paper cutting machines, screwdriver control, packing machines, sheet metal processing, handling equipment), process technology (water treatment, power generation, consumption logging), building services (room control, access control) and many more.



System overview

UPS

CX1100-0900



CX1100-0910



CX1100-0920



Fieldbus interfaces

Masters CX1500-Mxxx



-M750 -M520 -M510 -M310 -M200



Slaves CX1500-Bxxx



-B520 -B510 -B310 -B200

PC interfaces

CX1030-N0xx



RS232 -N030 DVI/USB -N010

CX1020-N0xx



RS232 -N030 DVI/USB -N010

CX1010-N0xx



RS232 -N030 DVI/USB -N010

CPU

CX1030



CX1020

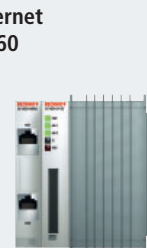

CX1010



Power supply

CX1100-000x

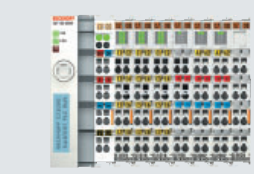

-0004 EtherCAT Terminals



-0003 Bus Terminals

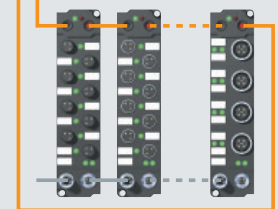

Fieldbus Box modules



-0002 Bus Terminals



-0001

PC interfaces

CX9000-xxxx/CX9010-xxxx

RS422/RS485 -N031 DVI/USB -N010



RS232 -N030 CF -A001

CPU + power supply + I/O interface

CX9000-0x0x/CX9010-0x0x

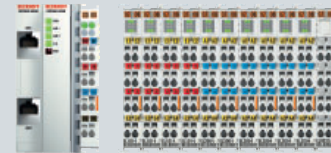

EtherCAT Terminals

CX9000-1x0x/CX9010-1x0x



Bus Terminals

PRODUCT OVERVIEW EMBEDDED PC

Embedded PC

Basic CPU	CX90x0-xx0x	CX1010-0xxx	CX1020-0xxx	CX1030-0xxx	Fieldbus interfaces
Processor	Intel® IXP420 with XScale® technology, clock frequ. 533 MHz	compatible with Pentium® MMX, clock frequency 500 MHz	Intel® Celeron® M ULV, 1 GHz clock frequency	Intel® Pentium® M, 1.8 GHz clock frequency	Lightbus CX1500-M200 master CX1500-B200 slave
Flash memory	32 MB Flash (internal, not expandable)	64 MB Compact Flash card	64 MB Compact Flash card	64 MB Compact Flash card	PROFIBUS CX1500-M310 master CX1500-B310 slave
Internal main memory	128 MB RAM (internal, not expandable)	256 MB RAM (not expandable) 512 MB, 1 GB)	256 MB DDR RAM (expandable to 512 MB, 1 GB)	256 MB DDR RAM (expandable to 512 MB, 1 GB)	CANopen CX1500-M510 master CX1500-B510 slave
Interfaces	2 x RJ 45 (Ethernet, internal switch), 10/100 Mbit/s	1 x RJ 45 (Ethernet), 10/100 Mbit/s	2 x RJ 45 (Ethernet, internal switch), 10/100 Mbit/s	2 x RJ 45 (Ethernet, internal switch), 10/100 Mbit/s	DeviceNet CX1500-M520 master CX1500-B520 slave
Operating system	Microsoft Windows CE	Microsoft Windows CE or Windows XP Embedded	Microsoft Windows CE or Windows XP Embedded	Microsoft Windows CE or Windows XP Embedded	SERCOS interface CX1500-M750 master
Control software	TwinCAT CE PLC run-time or CE NC PTP run-time	TwinCAT PLC run-time or NC PTP run-time	TwinCAT PLC run-time, NC PTP run-time, NC I run-time	TwinCAT PLC run-time, NC PTP run-time, NC I run-time	
Power supply	24 V DC (-15 %/+20 %)	via system bus (through CX1100 power supply module)	via system bus (through CX1100 power supply module)	via system bus (through CX1100 power supply module)	
System interfaces					
USB/DVI	CX9000-N010 CX9010-N010	CX1010-N010	CX1020-N010	CX1030-N010	
RS232	CX9000-N030 CX9010-N030	CX1010-N030 (COM1/2) CX1010-N040 (COM3/4)	CX1020-N030 (COM1/2) CX1020-N040 (COM3/4)	CX1030-N030 (COM1/2) CX1030-N040 (COM3/4)	
RS422/RS485	CX9000-N031 CX9010-N031	CX1010-N031 (COM1/2) CX1010-N041 (COM3/4)	CX1020-N031 (COM1/2) CX1020-N041 (COM3/4)	CX1030-N030 (COM1/2) CX1030-N041 (COM3/4)	
Audio		CX1010-N020	CX1020-N020	CX1030-N020	
Ethernet		CX1010-N060		CX1030-N060	
Compact Flash	CX9000-A001 CX9010-A001				
UPS					
24 V DC	CX1100-0900 charge = 20 As, max. 550 mA CX1100-0910 charge = 20 As, max. 1.1 A CX1100-0920 charge = 40 As, max. 1.1 A				
Power supply unit + I/O interfaces					
24 V DC	CX1100-0001 CX1100-0002 with K-bus interface (Bus Terminals) CX1100-0003 with K-bus/IP-Link interface (Bus Terminals, Fieldbus Box modules) CX1100-0004 with E-bus interface (EtherCAT Terminals)				



FIELDBUS COMPONENTS

I/Os for all common fieldbus systems

Bus Terminal

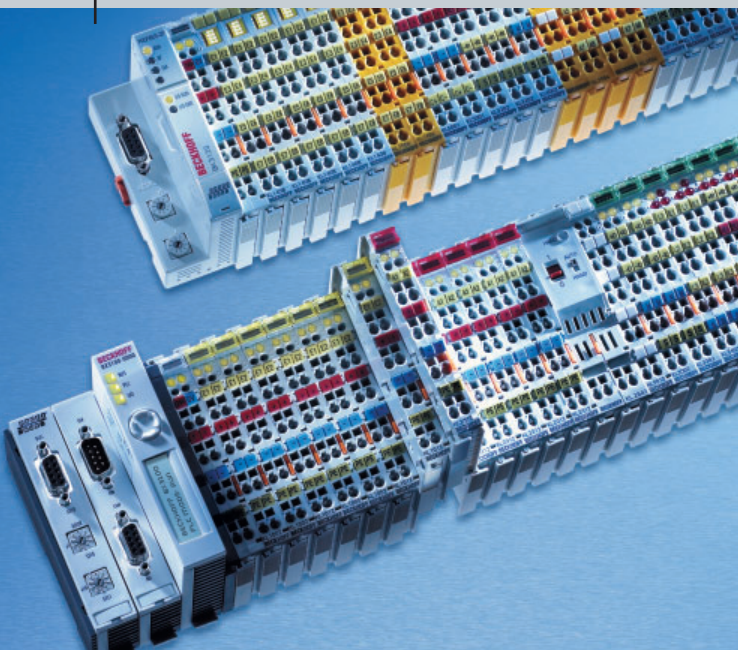

Fieldbus Box

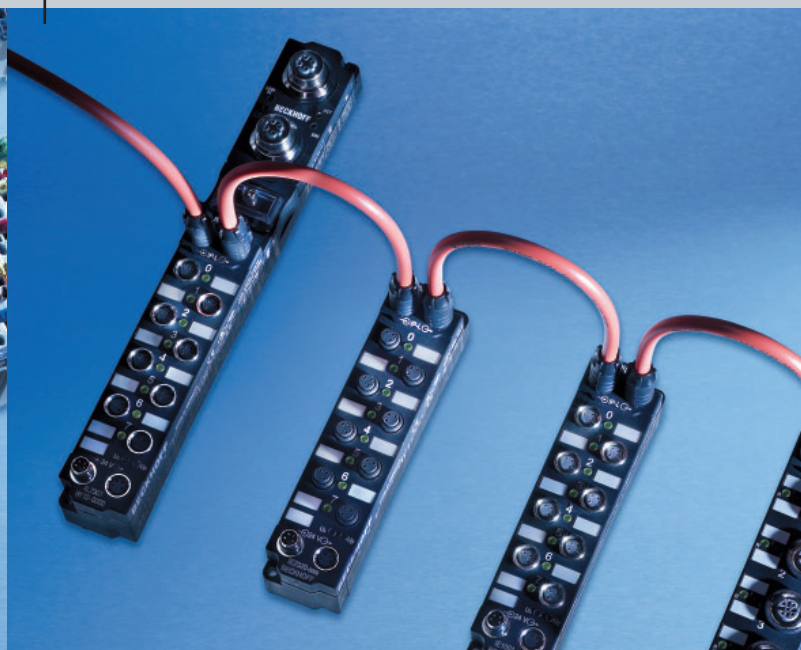

EtherCAT

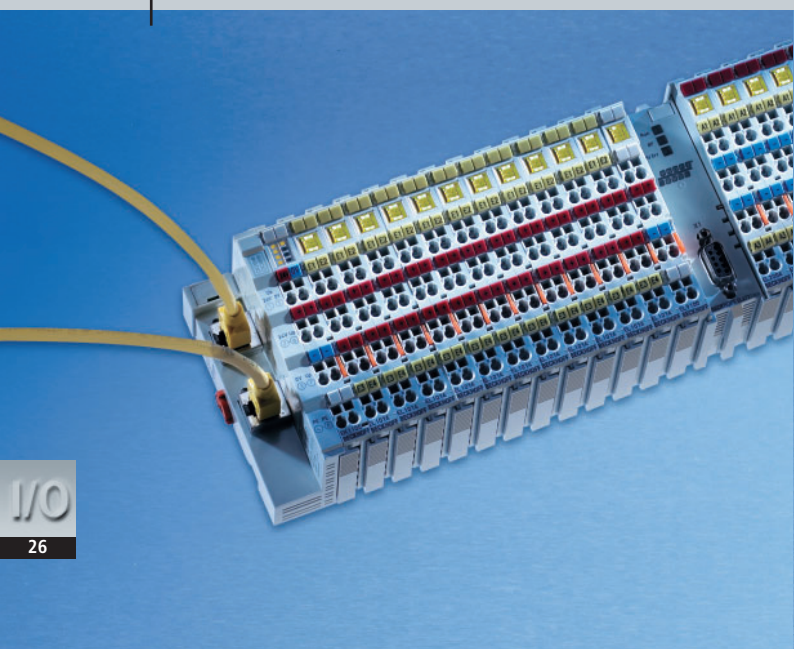

PC Fieldbus Cards, Switches

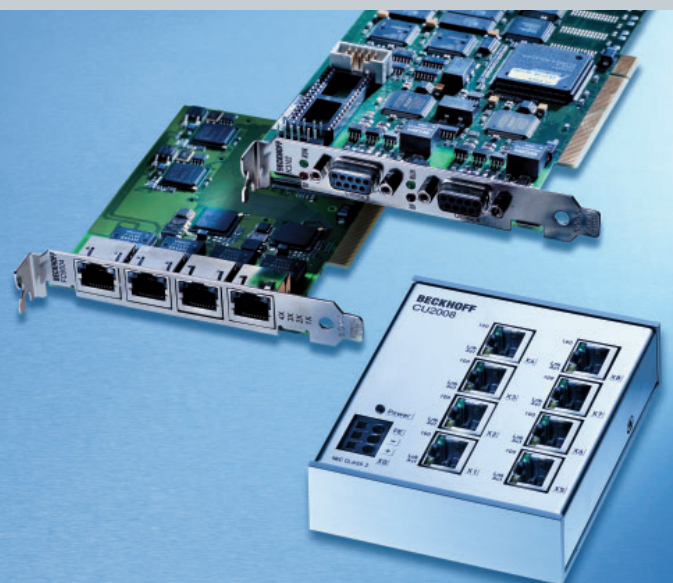

The fieldbus toolkit

Beckhoff provides an extensive range of fieldbus components for all common I/O and fieldbus systems. With the bus terminals in protection class IP 20, and the Fieldbus Box modules in protection class IP 67, the complete range is available for all relevant signal types and fieldbus systems. The Beckhoff Lightbus is the fast, secure fieldbus system, specially designed to meet the needs of automation technology. EtherCAT, the new real-time Ethernet fieldbus is a further development of the Lightbus

system. EtherCAT reaches new dimensions in network performance. The PC fieldbus cards have been particularly developed for fast control and for real-time tasks, and can therefore be used in a wide range of applications. The I/O range is completed with the appropriate cord sets, programming and configuration tools. The wide choice of I/O components means that the bus system best suited to the particular application can be chosen:

EtherCAT

EtherCAT (Ethernet for Control Automation Technology) is the Ethernet solution for industrial automation, characterised by outstanding performance and particularly simple handling.

Lightbus

This well proven fibre optics bus system from Beckhoff is characterised by particularly good immunity to EMI, easy installation and a very fast, cyclic and deterministic data flow.

PROFIBUS

PROFIBUS is widely used as a fast bus for decentralised peripheral components (PROFIBUS DP). In addition to PROFIBUS DP and FMS, Beckhoff also supports the standard for drive communication, PROFIBUS MC.

Interbus

Interbus is easy to configure, fast and reliable. The shift register protocol of the master/slave system offers high efficiency in cyclic communication.

CANopen

The effective utilisation of the bus bandwidth allows CANopen to achieve a short system reaction time at comparatively low data rates. The typical advantages of CAN, such as high data security and multi-master capability are retained.

DeviceNet

DeviceNet is a sensor/actuator bus system that originated in the USA, but which meanwhile is increasingly being used in Europe and Asia. DeviceNet is CAN based (Controller Area Net).

ControlNet

ControlNet is an open, standardised fieldbus system. The protocol allows both cyclic and acyclic data to be exchanged over the bus without affecting each other.

SERCOS interface

SERCOS was originally developed as a fast fibre optic bus system for drives. Thanks to the Beckhoff SERCOS interface Bus Coupler, the advantages such as high data rate and short cycle times can now be provided for the I/O peripherals too.

Ethernet

Ethernet is the dominant standard in the office world. The advantages of Ethernet, such as high data transmission rates, easy methods of integration into existing networks, and a wide range of services and interfaces are also found in the Beckhoff Ethernet products.

USB

USB has grown into a standard interface for PC technology. Thanks to its high transmission rate, flexible topology through integrated hubs and the Beckhoff USB Bus Coupler, this system can be used as a substitute for a fieldbus when distances are small.

Modbus

Modbus is an open, serial communications protocol based on the master/slave architecture. Since it is extremely easy to implement on all kinds of serial interface, it has gained wide acceptance.

Fipio

FIP complies with the European standard EN 50170 and receives manufacturer-independent support from the WorldFIP organisation. Through periodic and aperiodic exchange of variables and messages, the performance of the bus can be adjusted to the application.

CC-Link

CC-Link (Control & Communication Link) is an open bus system for communication between the control and fieldbus level. It is predominately used in Asia.

RS232/RS485

The "classic" serial interfaces, RS232 and RS485, continue in wide use. The Beckhoff RS485/RS232 I/O modules use a simple, published serial communication protocol that is easy to implement.

Fieldbus overview

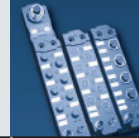
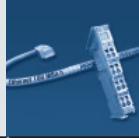
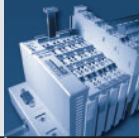

Fieldbus	Bus Terminal		EtherCAT Terminals	Fieldbus Box		
	Bus Couplers	PLC (IEC 61131-3)	Couplers/Gateways	Compact Box	Coupler Box	PLC Box (IEC 61131-3)
EtherCAT	BK1120 BK1250		EK1x00		IL230x-B110	
LIGHTBUS	BK2xx0	BC2000		IPxxxx-B200	IL230x-B200	
PROFIBUS	BK3xx0 LC3100	BC31x0 BX3100	EL6731 fieldbus terminal	IPxxxx-B31x	IL230x-B31x	IL230x-C31x
INTERBUS Certified No. 099	BK4xx0	BC4000		IPxxxx-B400	IL230x-B400	
CANopen	BK51xx LC5100	BC5150 BX5100	EL6751 fieldbus terminal	IPxxxx-B51x	IL230x-B51x	
DeviceNet	BK52x0 LC5200	BC5250 BX5200	EL6752 fieldbus terminal	IPxxxx-B52x	IL230x-B52x	
ControlNet	BK7000					
CC-Link	BK7150					
Modbus	BK73x0	BC7300		IPxxxx-B730	IL230x-B730	
Fipio	BK7420					
SERCOS interface	BK75x0					
RS485	BK8000	BC8000 BX8000		IPxxxx-B800	IL230x-B800	IL230x-C800
RS232	BK8100	BC81x0		IPxxxx-B810	IL230x-B810	IL230x-C810
Ethernet TCP/IP	BK9xx0	BC9xx0 BX9000	EL66xx Ethernet Switch terminal		IL230x-B90x	IL230x-C900
PROFINET	BK9103					
EtherNet/IP	BK9105					
USB	BK9500					
AS interface	KL/KS62x1 master terminal					
EIB	KL/KS6301 EIB Bus Terminal					
LON	KL/KS6401 LON Bus Terminal					
MP-Bus	KL/KS6771 master terminal					
DALI/DSI	KL/KS6811 master terminal					



Fieldbus Modules	PC Fieldbus Cards, Switches	Embedded PC	Drive Technology	Accessories
Modules	Interfaces	Master/Slave	Servo Drives	Connectors/Cables
	FC90xx CU20xx <small>Ethernet Switch</small>		AX5xxx AX20xx-B110	ZS1090-0003
FM33xx-B310	FC200x FC31xx	CX1500-M/B200 CX1500-M/B310	AX2xxx-B200 AX2xxx-B310	Z1xxx ZB3100 ZK/ZS1031 ZB4200
	FC51xx	CX1500-M/B510	AX20xx AX25xx-B510	ZS1052 ZK/ZS1052
	FC52xx	CX1500-M/B520	AX20xx-B520	ZS1052 ZK/ZS1052
				ZK/ZS1031
	FC75xx	CX1500-M750	AX2xxx-B750	Z1xxx
			AX20xx	ZK/ZS1031
			AX20xx	ZK/ZS1031
	FC90xx CU20xx <small>Ethernet Switch</small>		AX2xxx-B900	ZS1090 ZB90x0

Signal overview

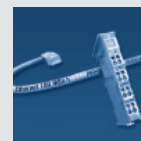

Signal	Bus Terminal				Terminal Modules	EtherCAT Terminals
	1-channel	2-channel	4-channel	8-channel	4-, 16-, 32-, 64-channel	1-channel
Digital input						
5 V DC			KL/KS1124			
12 V DC						
24 V DC		KL/KS1xx2	KL/KS1xx4	KL/KS1xx8	KM10xx	
48 V DC		KL/KS1032				
120 V AC/DC		KL/KS1712				
230 V AC		KL/KS17x2				
Safety			KL1904			
NAMUR		KL/KS1352				
Counter		KL/KS15xx				
Digital output						
5 V DC			KL/KS2124			
24 V DC		KL/KS2xx2	KL/KS2xx4	KL/KS24x8	KM200x	
120 V AC/DC		KL/KS2612				
230 V AC	KL2xx1	KL/KS2xx2			KM2xx4	
400 V AC	KL/KS2631					
Safety			KL2904			
PWM		KL/KS25xx				
Motion Control	KL/KS25x1	KL/KS25x2				EL/ES2521
Digital combi						
24 V DC						
Analog input						
0 ... 2 V, ±2 V		KL/KS31x2				
0 ... 10 V	KL/KS3061	KL/KS3x62	KL/KS3x64	KL/KS3468		EL/ES3x61
±10 V	KL/KS3001	KL/KS30x2	KL/KS3404	KL/KS3408		EL/ES3x01
0 ... 20 mA	KL/KS30x1	KL/KS3xx2	KL/KS3x44	KL/KS3448		EL/ES3xx1
4 ... 20 mA	KL/KS30x1	KL/KS3xx2	KL/KS3x54	KL/KS3458		EL/ES3xx1
Thermocouple	KL3311	KL3312	KL3314			EL3311
Resistance thermometer	KL/KS3201	KL/KS3202	KL/KS3204			EL/ES3201
Resistor bridge	KL/KS335x					EL/ES3356
Analog output						
0 ... 10 V	KL/KS4001	KL/KS4002	KL/KS4x04	KL/KS4408		EL/ES4001
±10 V	KL/KS4031	KL/KS4x32	KL/KS4xx4	KL/KS4438		EL/ES4031
0 ... 20 mA	KL/KS4011	KL/KS4x12	KL/KS4414	KL/KS4418		EL/ES4011
4 ... 20 mA	KL/KS4021	KL/KS4022	KL/KS4424	KL/KS4428		EL/ES4021
Special functions						
SSI encoder interface	KL/KS50x1					EL/ES5001
Incremental encoder in.	KL/KS51x1					EL/ES51x1
RS232	KL/KS60x1					EL/ES6001
RS485	KL/KS60x1					EL/ES6021
TTY	KL/KS6011					

KLxxxx/ELxxxx: Standard Terminals, KSxxxx/ESxxxx: Terminals with pluggable wiring level



			Fieldbus Box		Fieldbus Modules	Lightbus
2-channel	4-channel	8-channel	Compact Box Coupler/PLC Box	Extension Box	Modules	Modules
	EL/ES1124 EL/ES1144					
EL/ES1xx2	EL/ES1xx4 EL/ES1134	EL/ES10x8	IP10xx-Bxxx	IE10xx		M1110, 1400
EL/ES1712 EL/ES17x2	EL1904					
EL/ES15x2			IP1502-Bxxx	IE1502		
	EL/ES2124					
EL/ES2xx2	EL/ES20x4	EL/ES20x8	IP20xx-Bxxx	IE2xxx		M1110, 1400
EL/ES2xx2						
	EL2904					
EL/ES25xx			IP2512-Bxxx	IE2512		
			IP/IL2xxx-Bxxx IL230x-Cxxx	IE2xxx		M1400, 2400
EL/ES3x62	EL/ES3x64	EL/ES3068				M2510
EL/ES3x02	EL/ES3x04	EL/ES3008	IP3102-Bxxx	IE3102		M2510
EL/ES3xx2	EL/ES3xx4	EL/ES3048	IP3112-Bxxx	IE3112		
EL/ES3xx2	EL/ES3xx4	EL/ES3058				M2510
EL3312	EL3314		IP3312-Bxxx	IE3312	FM33xx-Bxxx	
EL/ES3202	EL/ES3204		IP3202-Bxxx	IE3202		
EL/ES4x02	EL/ES4x04	EL/ES4008				
EL/ES4x32	EL/ES4x34	EL/ES4038	IP4132-Bxxx	IE4132		M2510
EL/ES4x12	EL/ES4x14	EL/ES4018	IP4112-Bxxx	IE4112		
EL/ES4x22	EL/ES4x24	EL/ES4028				
			IP5009-Bxxx	IE5009		
			IP5109-Bxxx	IE5109		M31x0
			IP6002-Bxxx	IE6002		
			IP6022-Bxxx	IE6022		
			IP6012-Bxxx	IE6012		

BUS TERMINAL

The modular fieldbus system for automation

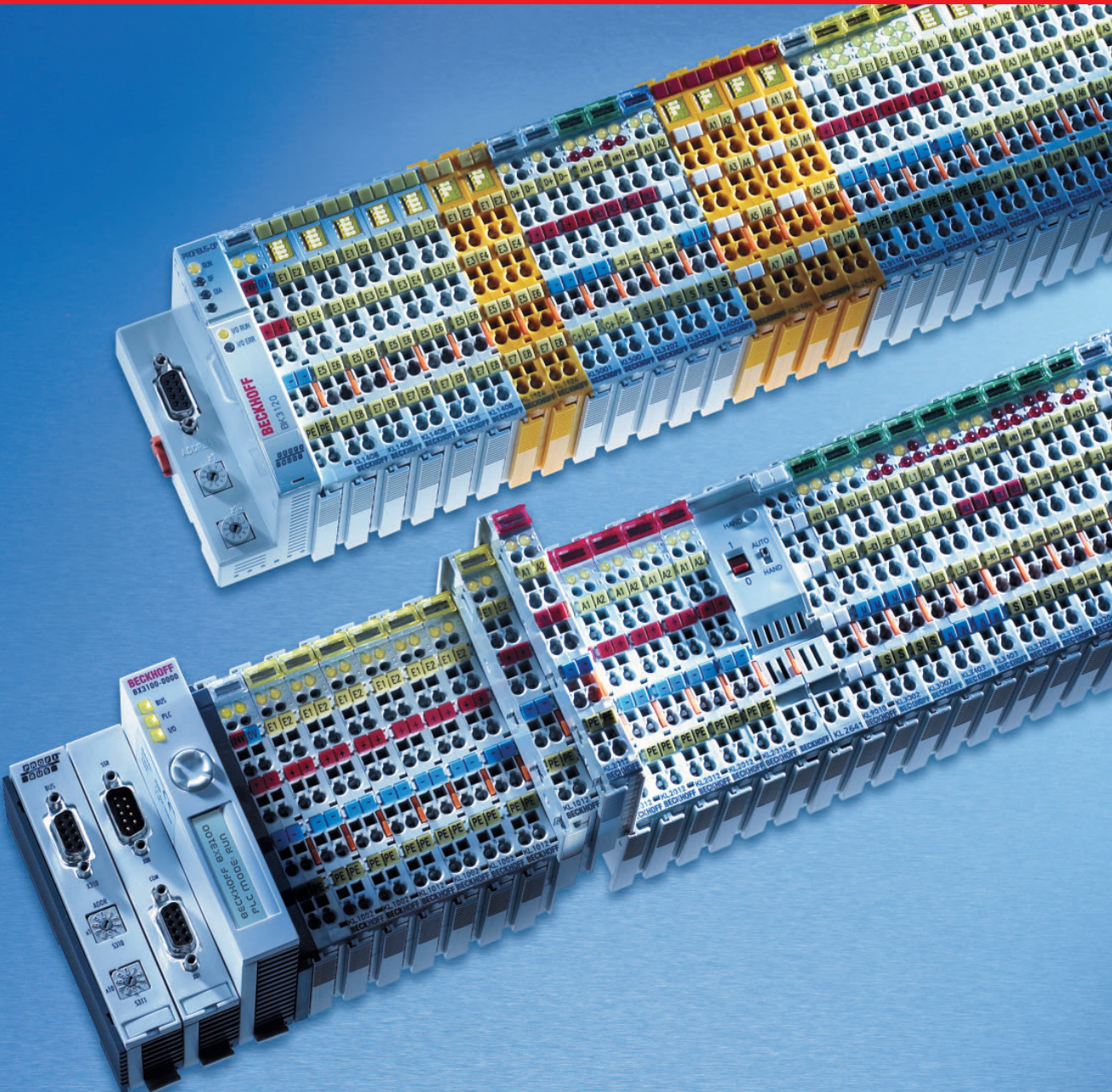

The Bus Terminal system

The Beckhoff Bus Terminal is an open and fieldbus-neutral I/O system consisting of electronic terminal blocks. The head of an electronic terminal block is the Bus Coupler with the interface to the fieldbus. Bus Couplers are available for all common bus systems.

With the master terminals, fieldbus functionalities are also available in form of a standard Bus Terminal. This is particularly advantageous for bus systems that are integrated as subsystems into a higher-level system.

The robust housing, secure contacts and the solidly built electronics are prominent features of our components. A station consists of one Bus Coupler and up to 64 electronic terminal blocks. With the K-bus extension it is possible to operate up to 255 Bus Terminals on one Bus Coupler. The electronic terminal blocks are clipped onto the Bus Coupler. They connect by simply latching together. This means that each electronic terminal block can be exchanged separately and can be mounted on a standard mounting rail. In addition to horizontal type mounting, all other mounting types are permitted.

Design

The Beckhoff Bus Terminal with its outside contour adjusts perfectly to the measurements of terminal boxes. The clear front panel of the terminal with light-emitting diodes for status display, plug-in contact labelling and detachable labelling fields guarantee clarity. The 3-wire system supplemented by a protective conductor terminal makes it possible to wire sensors/actuators directly.

Free mix of signals

The Beckhoff I/O system supports more than 200 Bus Terminals and is thus probably the most comprehensive system on the market. The components enable users to operate mixed signal configurations without restriction at each station. This means that a single non-central input/output node can map all the necessary signals.

Appropriate Bus Terminals are available for any digital or analog automation signal type, for currents and voltages with standardised signal levels and for PT100 and thermocouple signals. Intelligent devices can be connected via Bus Terminals with serial interfaces in accordance with RS232, RS485 or 20 mA TTY.

The fine granularity of the Bus Terminals enables bit-precise composition of the required I/O channels. The digital Bus Terminals are available as 2-, 4- or 8-channel terminals. The standard analog signals of

$\pm 10\text{ V}$, $0\text{ V} \dots 10\text{ V}$, $0 \dots 20\text{ mA}$ and $4 \dots 20\text{ mA}$ are all available as 1-, 2-, 4-, and 8-channel variants within a standard housing. In the 8-channel variant, analog input and output signals are arranged in an ultra-compact way within a standard Bus Terminal housing across a width of only 12 mm. The system is thus highly modular and can be projected cost-effectively with an accuracy down to a single channel.

Flexible connection system

The Bus Terminal system offers different connection options for optimum adaptation to the respective application. The standard KL type Bus Terminals include electronics and connection level in a single housing. The KS type Bus Terminals feature a pluggable connection level. The KS series Bus Terminals enable the complete wiring to be removed as a plug connector from the top of the housing for servicing.

As an alternative, the KM type terminal modules feature pluggable wiring, combining 16, 32 or 64 digital I/Os in a very small area with high packing density.

Automation standard

The Beckhoff Bus Terminal ensures that control cabinets and terminal boxes are constructed more economically. Using the 4-wire terminating system, all of the usual sensors and actuators with different types of signal can be connected directly without









other connection systems. It is no longer necessary to wire the field devices between the first terminal connection in the control cabinet or in the terminal box and the controller. This significantly reduces the costs involved in controller design and saves space, material, work, and money.

The field devices can be wired using the Beckhoff Bus Terminal system on site where the signals occur. Installation and wiring of the Beckhoff Bus Terminal is thus simple and compact like that of a standard terminal block. The Bus Terminal can be connected to the controller by connecting a Bus Coupler via the fieldbus as required.

The Beckhoff Bus Terminals have been tried and tested in a wide range of sectors worldwide, from machine construction to building management. Beckhoff Bus Terminal technology makes design, construction, wiring, commissioning and maintenance of equipment and machines very cost-effective.

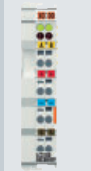

PRODUCT OVERVIEW BUS TERMINALS

System overview Bus Coupler						PLC		
Features	Standard BKxx00	Economy BKxx10	Economy plus BKxx20	Compact BKxx50	Low Cost LCxx00	Controller BCxx00	BCxx50	BXxx00
								
Function	fieldbus slave	fieldbus slave	fieldbus slave	fieldbus slave	fieldbus slave	fieldbus slave, with integrated IEC 61131-3 PLC	fieldbus slave, with integrated IEC 61131-3 PLC	fieldbus slave, with integrated IEC 61131-3 PLC
Program memory	–	–	–	–	–	32/96 kbyte	48 kbyte	256 kbyte
Power supply	1750 mA	500 mA	1750 mA	1000 mA	500 mA	1750 mA	1000 mA	1450 mA
Fieldbus connection	plug (design depends on the fieldbus)	plug (design depends on the fieldbus)	plug (design depends on the fieldbus)	plug (design depends on the fieldbus)	direct to the spring-loaded terminals	plug (design depends on the fieldbus)	plug (design depends on the fieldbus)	plug (design depends on the fieldbus)
Supported Bus Terminals	all	only digital I/Os (except KL1501, KL25x2)	all	all	only digital I/Os (except KL1501, KL25x2)	all	all	all
Max. number of Bus Terminals	64	64	64 (255 with terminal bus extension)	64 (255 with terminal bus extension)	64	64	64 (255 with terminal bus extension)	64 (255 with terminal bus extension)
Electrical isolation	between fieldbus/ power contacts/ supply voltage	between fieldbus/ power contacts/ supply voltage	between fieldbus/ power contacts/ supply voltage	between fieldbus/ power contacts/ supply voltage	PROFIBUS: yes, CANopen and DeviceNet: no	between fieldbus/ power contacts/ supply voltage	between fieldbus/ power contacts/ supply voltage	between fieldbus/ power contacts/ supply voltage



Fieldbus-independent:
Bus Coupler for
almost any fieldbus

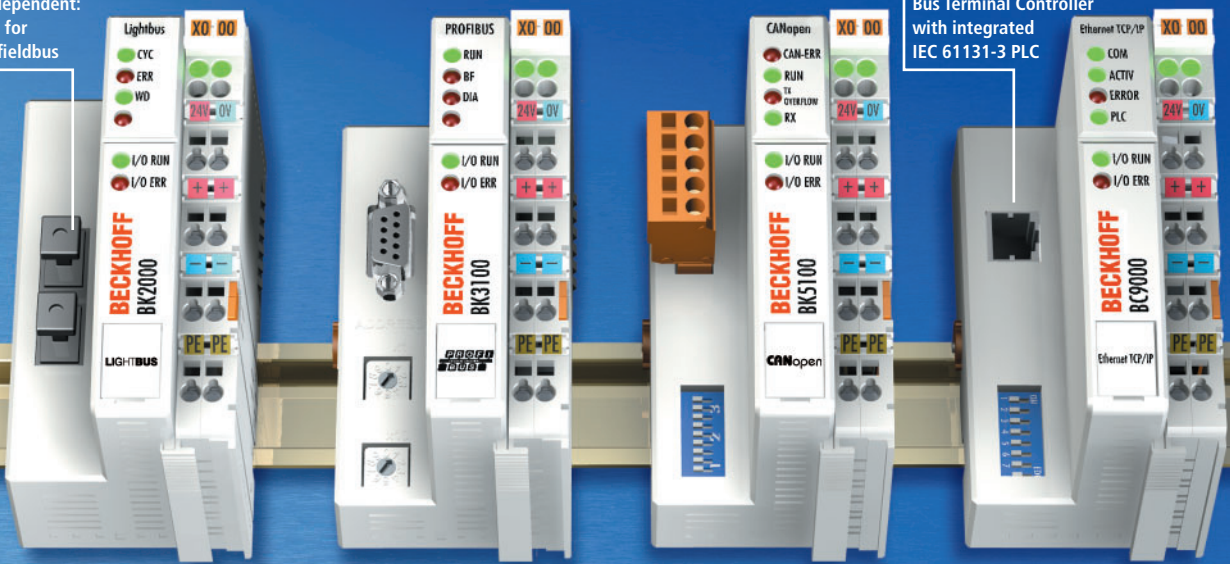

Bus Coupler

PLC

Fieldbus	Standard		Economy	Economy plus	Compact	Low Cost	Controller (IEC 61131-3)		
			only digital I/O			only digital I/O	32/96 kbyte	48 kbyte	256 kbyte
EtherCAT				BK1120	BK1250				
LIGHTBUS	BK2000	BK2010	BK2020				BC2000		
	BK2500								
	RS485 interface								
PROFIBUS	BK3000	BK3010							
	1.5 Mbaud	1.5 Mbaud							
	BK3100	BK3110	BK3120	BK3150	LC3100	BC3100	BC3150	BX3100	
	12 Mbaud	12 Mbaud	12 Mbaud	12 Mbaud	12 Mbaud	12 Mbaud	12 Mbaud	12 Mbaud	12 Mbaud
	BK3500		BK3520						
	1.5 Mbaud, fibre op.		12 Mbaud, fibre op.						
INTERBUS	BK4000	BK4010	BK4020				BC4000		
	BK4500								
	fibre optic								
CANopen		BK5110	BK5120	BK5150	LC5100		BC5150	BX5100	
				BK5151					
DeviceNet	BK5200	BK5210	BK5220	BK5250	LC5200		BC5250	BX5200	
ControlNet	BK7000								
CC-Link				BK7150					
Modbus	BK7300			BK7350		BC7300	BC8150		
Fipio			BK7420						
SERCOS	BK7500		BK7520						
RS485	BK8000						BC8000		BX8000
RS232	BK8100						BC8100	BC8150	
Ethernet TCP/IP	BK9000			BK9050		BC9000	BC9050	BX9000	
	BK9100					BC9100			
	2-channel switch					2-channel switch			
PROFIBUS	BK9103								
	2-channel switch								
EtherNet/IP	BK9105								
	2-channel switch								
USB	BK9500								
ASi	KL/KS62x1 master terminal								
EIB	KL/KS6301 EIB Bus Terminal								
LON	KL/KS6401 LON Bus Terminal								
MP-Bus	KL/KS6771 master terminal								
DALI/DSI	KL/KS6811 master terminal								



Potential feeder terminals enable to set up different potential groups

Bus Coupler:
the link between
Bus Terminals
and fieldbus

Bus Terminals in
1-, 2-, 4- and 8-channel
modularity with
combinations of
any desired types
of signal

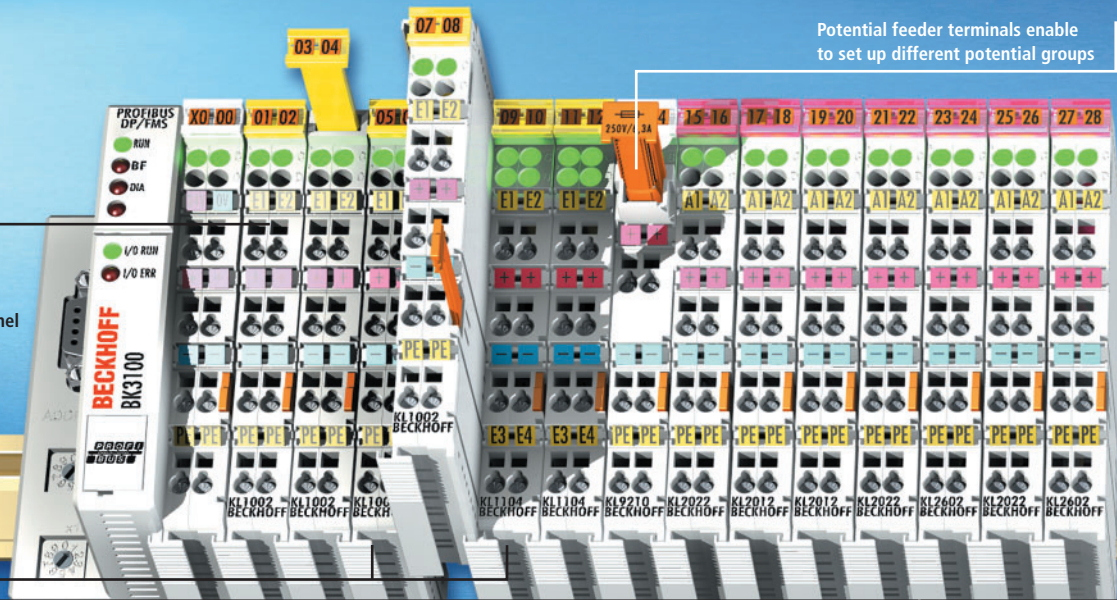

Digital input: KL1xxx | KS1xxx

KM1xxx

Signal	2-channel	4-channel	8-channel	16-/32-/64-channel
5 V DC		KL1124 KS1124 filter 0.2 ms		
24 V DC	KL1002 KS1002 filter 3.0 ms	KL1104 KS1104 filter 3.0 ms	KL1408 KS1408 filter 3.0 ms	KM1002 filter 3.0 ms, 16-channel
	KL1012 KS1012 filter 0.2 ms	KL1114 KS1114 filter 0.2 ms	KL1418 KS1418 filter 0.2 ms	KM1012 filter 0.2 ms, 16-channel
	KL1052 KS1052 filter 3.0 ms, p/n-switching	KL1154 KS1154 filter 3.0 ms, p/n-switching	KL1164 KS1164 filter 0.2 ms, p/n-switching	KM1004 filter 3.0 ms, 32-channel
	KL1212 KS1212 filter 3.0 ms, short circuit protected sensor supply	KL1184 KS1184 filter 3.0 ms, n-switching	KL1194 KS1194 filter 0.2 ms, n-switching	KM1014 filter 0.2 ms, 32-channel
	KL1302 KS1302 filter 3.0 ms, type 2 sensors	KL1304 KS1304 filter 3.0 ms, type 2 sensors	KL1498 KS1498 filter 0.2 ms, n-switching	KM1008 filter 3.0 ms, 64-channel
	KL1312 KS1312 filter 0.2 ms, type 2 sensors	KL1314 KS1314 filter 0.2 ms, type 2 sensors		KM1018 filter 0.2 ms, 64-channel
	KL1232 KS1232 pulse expansion	KL1404 KS1404 filter 3.0 ms, 4 x 2-wire connection	KL1414 KS1414 filter 0.2 ms, 4 x 2-wire connection	
	KL1362 KS1362 break-in alarm	KL1434 KS1434 filter 0.2 ms, type 2 sensors, 4 x 2-wire connection		
	KL1382 KS1382 thermistor	KL1904 TwinSAFE, 4 safe inputs	KL1528 multi-function I/O, fast inputs/outputs	
48 V DC	KL1032 KS1032 filter 3.0 ms			
120 V AC/DC	KL1712 KS1712 power contacts			
230 V AC	KL1702 KS1702 power contacts			
	KL1722 KS1722 no power contacts			
NAMUR	KL1352 KS1352			
Counter	KL1501 KS1501 up/down, 24 V DC, 100 kHz			
	KL1512 KS1512 up/down, 24 V DC, 1 kHz, 16 bit			

KLxxxx: Standard Bus Terminals, KSxxxx: Bus Terminals with pluggable wiring level

Operation of up to 64 Bus Terminals on one Bus Coupler (255 with K-bus extension KL9020 and KL9050)

Fast and secure data connections by means of a serial terminal bus

Power contacts for automatic transfer of supply voltage

Bus end terminal

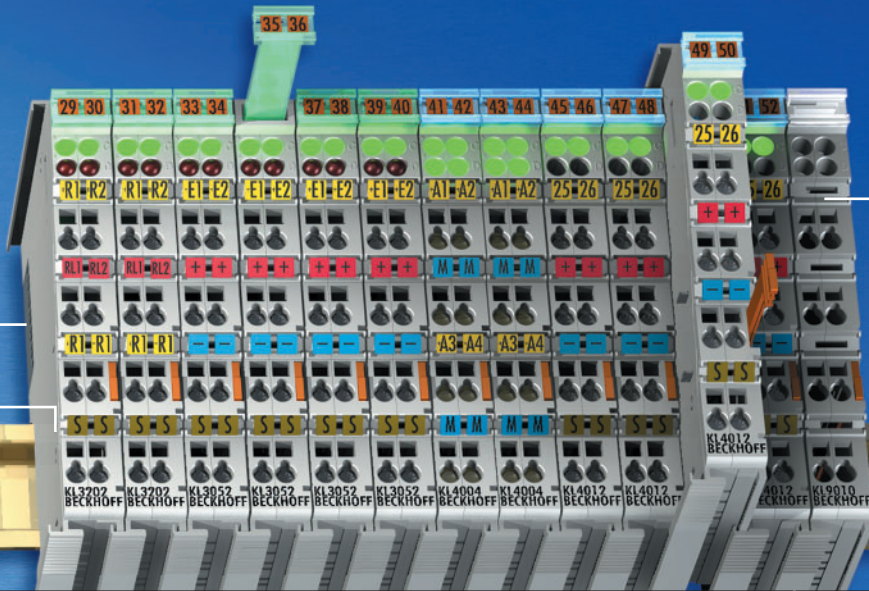

Digital output: KL2xxx | KS2xxx

KM2xxx

Signal	1-channel	2-channel	4-channel	8-channel	4-/16-/32-/64-ch.
5 V DC			KL2124 KS2124		
24 V DC		KL2012 KS2012 $I_{max} = 0.5 A$	KL2022 KS2022 $I_{max} = 2.0 A$	KL2114 KS2114 $I_{max} = 0.5 A$	KL2134 KS2134 $I_{max} = 0.5 A$, rev. volt. prot.
		KL2032 KS2032 $I_{max} = 0.5 A$, reverse voltage protection	KL2212 KS2212 $I_{max} = 0.5 A$, diagnostic, protected sensor supply	KL2184 KS2184 $I_{max} = 0.5 A$, n-switching	KL2904 TwinSAFE, 4 safe outputs $I_{max} = 2.0 A$, 4 x 2-wire
24 V AC/DC			KL2784 KS2784 $I_{max} = 1.0 A$, solid state	KL2794 KS2794 $I_{max} = 1.0 A$, solid state, potential-free contacts	
125 V AC		KL2612 KS2612 relay, change-over			
230 V AC	KL2641 relay, make contact, manual operation, 16 A	KL2602 KS2602 relay, make contact	KL2622 KS2622 relay, make contact, no power contacts		KM2604 relay, 16 A, 4-channel
		KL2652 KS2652 relay, change-over	KL2702 KS2702 solid state relay		
	KL2751 KS2751 universal dimmer terminal, 230 V, 300 W	KL2712 KS2712 triac	KL2722 KS2722 triac, mutually locked outputs		KM2774 triac output for 4 blind motors
		KL2732 KS2732 triac, mutually locked outputs, no power cont.	KL2692 KS2692 cycle monitoring (watchdog)		
400 V AC	KL2631 KS2631 relay, make contact				
PWM		KL2502 KS2502 24 V DC, 0.1 A	KL2512 24 V DC, 1.5 A, n-switch.		
		KL2535 KS2535 24 V DC, 1 A, current-controlled	KL2545 KS2545 50 V DC, 3.5 A, current-controlled		
Pulse train	KL2521 KS2521				
Stepper motor	KL2531 KS2531 $I_{max} = 1.5 A$				
	KL2541 KS2541 $I_{max} = 5 A$				
DC motor output stage		KL2532 KS2532 24 V DC, 1 A	KL2542 KS2542 50 V DC, 3.5 A		

KLxxxx: Standard Bus Terminals, KSxxxx: Bus Terminals with pluggable wiring level



Flexible connection system

KLxxxx | The standard KL type Bus Terminals include electronics and connection level in a single housing.

KSxxxx | The KS series Bus Terminals feature a pluggable connection level enabling the complete wiring to be removed as a plug connector from the top of the housing for servicing.

KMxxxx | The KM type terminal modules feature pluggable wiring, combining 16, 32 or 64 digital I/Os in a very small area with high packing density.

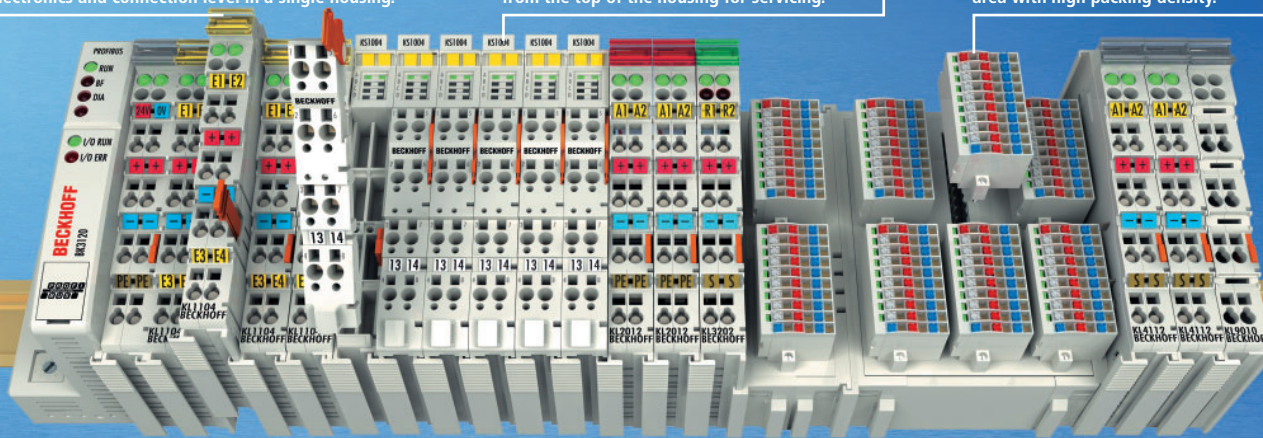

Analog input: KL3xxx | KS3xxx

Signal	1-channel	2-channel	4-channel	8-channel
0 ... 2 V		KL3172 KS3172 16 bit, 0.05%		
± 2 V		KL3182 KS3182 16 bit, 0.05%		
0 ... 10 V	KL3061 KS3061 single-ended, 12 bit	KL3062 KS3062 single-ended, 12 bit	KL3064 KS3064 single-ended, 12 bit	
		KL3162 KS3162 16 bit, 0.05%	KL3464 KS3464 4 x 2-wire connection, 12 bit	KL3468 KS3468 8 x 1-wire connection, 12 bit
± 10 V	KL3001 KS3001 differential input, 12 bit	KL3002 KS3002 differential input, 12 bit	KL3404 KS3404 4 x 2-wire connection, 12 bit	KL3408 KS3408 8 x 1-wire connection, 12 bit
		KL3102 KS3102 differential input, 16 bit		
		KL3132 KS3132 16 bit, 0.05%		
0 ... 20 mA	KL3011 KS3011 differential input, 12 bit	KL3012 KS3012 differential input, 12 bit	KL3444 KS3444 4 x 2-wire connection, 12 bit	KL3448 KS3448 8 x 1-wire connection, 12 bit
	KL3041 KS3041 terminal supply, 12 bit	KL3042 KS3042 terminal supply, 12 bit	KL3044 KS3044 12 bit	
		KL3112 KS3112 different. input, 16 bit		
		KL3142 KS3142 16 bit, 0.05%		
4 ... 20 mA	KL3021 KS3021 differential input, 12 bit	KL3022 KS3022 differential input, 12 bit	KL3454 KS3454 4 x 2-wire connection, 12 bit	KL3458 KS3458 8 x 1-wire connection, 12 bit
	KL3051 KS3051 terminal supply, 12 bit	KL3052 KS3052 terminal supply, 12 bit	KL3054 KS3054 12 bit	
		KL3122 KS3122 differential input, 16 bit		
		KL3152 KS3152 16 bit, 0.05%		
Thermocouples	KL3311 type J, K, L, ...U, 16 bit	KL3312 type J, K, L, ...U, 16 bit	KL3314 type J, K, L, ...U, 16 bit	
Resistance thermometer (RTD)	KL3201 KS3201 PT100...1000, Ni100, 16 bit	KL3202 KS3202 PT100...1000, Ni100, 16 bit	KL3204 KS3204 PT100...1000, Ni100, 16 bit	
Resistor bridge	KL3351 KS3351 strain gauge, 16 bit			
	KL3356 KS3356 strain gauge, 16 bit, self-calibration			
Oscilloscope	KL3361 KS3361 oscilloscope terminal, ±20 mV	KL3362 KS3362 oscilloscope terminal, ±10 V		
Power measurement		KL3403 KS3403 3-phase power measurement terminal		
Pressure measuring	KM3701 differential mea., 100 hPa	KM3702 absolute measuring, 10000 hPa		

KLxxxx: Standard Bus Terminals, KSxxxx: Bus Terminals with pluggable wiring level

Terminal bus extension

Via the K-bus extension, the Bus Coupler "Economy plus" enables the connection of up to 255 Bus Terminals.



Analog output: KL4xxx | KS4xxx

Signal	1-channel	2-channel	4-channel	8-channel
0 ... 10 V	KL4001 KS4001 12 bit	KL4002 KS4002 12 bit	KL4004 KS4004 12 bit	
			KL4404 KS4404 4 x 2-wire connection, 12 bit	KL4408 KS4408 8 x 1-wire connection, 12 bit
± 10 V	KL4031 KS4031 12 bit	KL4032 KS4032 12 bit	KL4034 KS4034 12 bit	
			KL4434 KS4434 4 x 2-wire connection, 12 bit	KL4438 KS4438 8 x 1-wire connection, 12 bit
		KL4132 KS4132 16 bit		
			KL4494 KS4494 2 x input, 2 x output, 12 bit	
0 ... 20 mA	KL4011 KS4011 12 bit	KL4012 KS4012 12 bit		
			KL4414 KS4414 4 x 2-wire connection, 12 bit	KL4418 KS4418 8 x 1-wire connection, 12 bit
		KL4112 KS4112 16 bit		
4 ... 20 mA	KL4021 KS4021 12 bit	KL4022 KS4022 12 bit		
			KL4424 KS4424 4 x 2-wire connection, 12 bit	KL4428 KS4428 8 x 1-wire connection, 12 bit

KLxxxx: Standard Bus Terminals, KSxxxx: Bus Terminals with pluggable wiring level



Power terminal system

The power terminal system provides fieldbus functionality for standard contactor technology.

Adapter terminal KL9060 for the connection of up to 10 power terminals KL8xxx

Signal transmission via ribbon cable

Power terminal KL8xxx with adapter for contactor connection

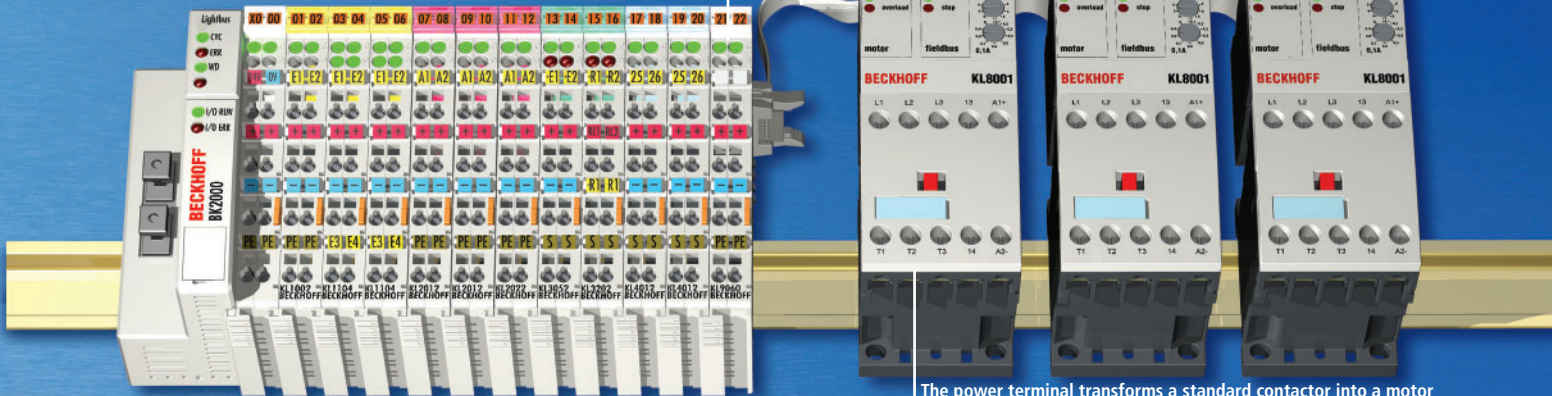

The power terminal transforms a standard contactor into a motor protection relay with comprehensive diagnostics functions.

Special functions: KL/KS5xxx, KL/KS6xxx

Signal	
Position measurement	<p>KL5001 KS5001 SSI encoder interface</p> <p>KL5051 KS5051 bidirectional SSI encoder interface</p> <p>KL5101 KS5101 incremental encoder interface, diff. input</p> <p>KL5111 KS5111 incremental encoder interface</p> <p>KL5151 KS5151 incremental encoder interface, 32 bit</p> <p>KL5121 KS5121 4-channel, incremental encoder interface with programmable outputs</p>
Communication	<p>KL6001 KS6001 serial interface RS232, 19.2 kbaud</p> <p>KL6031 KS6031 serial interface RS232, 115.2 kbaud</p> <p>KL6011 KS6011 serial interface TTY, 20 mA current loop</p> <p>KL6021 KS6021 serial interface RS422/RS485, 19.2 kbaud</p> <p>KL6041 KS6041 serial interface RS422/RS485, 115.2 kbaud</p> <p>KL6023 wireless adapter for EnOcean radio technology</p> <p>KL6051 KS6051 data exchange terminal, 32 bit</p> <p>KL6201 KS6201 AS-Interface master terminal</p> <p>KL6211 KS6211 AS-Interface master terminal with power contacts</p> <p>KL6301 KS6301 EIB Bus Terminal</p> <p>KL6401 KS6401 LON Bus Terminal</p> <p>KL6771 KS6771 MP-Bus master terminal</p> <p>KL6811 KS6811 DALI/DSI master and power supply terminal</p>

Power terminals: KL8xxx

Signal	
400 V AC 3~	<p>KL8001 switching capacity 5.5 kW, nominal current 0.9 to 9.9 A, connection mechanism for Siemens contactors (Sirius 3R series)</p> <p>KL8601 communication module for Schneider TeSys model U</p> <p>KL8610 adapter terminal for Schneider TeSys model U</p>

TwinSAFE terminals: KLx904

Signal	
24 V DC	<p>KL1904 4-channel digital input terminal, IEC 61508 SIL 3 and EN 954 Cat. 4</p> <p>KL2904 4-channel digital output terminal, IEC 61508 SIL 3 and EN 954 Cat. 4</p>
Controller	<p>KL6904 TwinSAFE Logic Bus Terminal with 4 digital outputs, IEC 61508 SIL 3 and EN 954 Cat. 4</p>

KLxxxx: Standard Bus Terminals, KSxxxx: Bus Terminals with pluggable wiring level

TwinSAFE

The TwinSAFE Bus Terminals enable the connection of all common safety sensors and actuators.

Certification: All TwinSAFE devices are subjected to a prototype test according to IEC 61508 and EN 954.

The TwinSAFE Logic Bus Terminal KL6904 enables communication with up to 31 TwinSAFE devices. The Bus Terminal features certified safety blocks for functions such as emergency stop, safety door monitoring, etc. In addition, the TwinSAFE Logic Bus Terminal has four safe digital 24 V DC outputs.

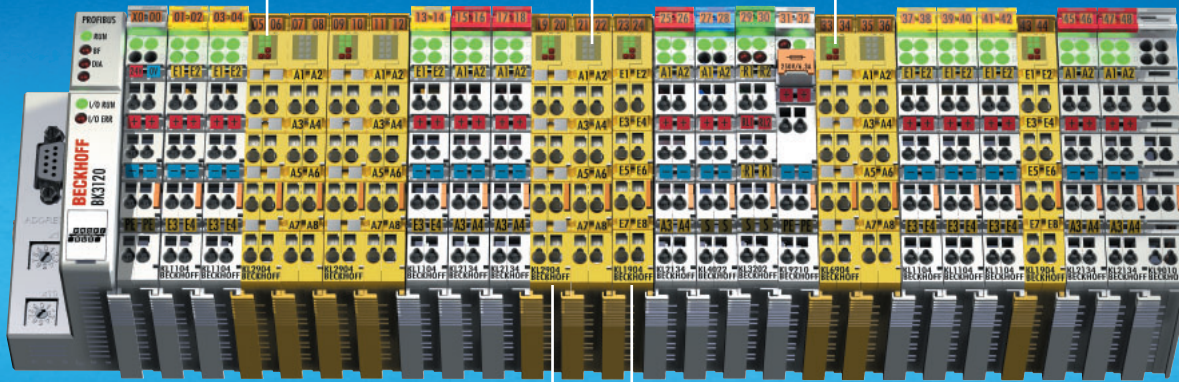

The Safety Bus Terminal KL2904 is a digital output terminal with four channels. The terminal switches 24 V DC actuators with up to 2 A total current.

The digital input terminal KL1904 for sensors with potential-free contacts for 24 V DC: The Safety Bus Terminal has 4 fail-safe inputs.

System terminals: KL9xxx | KS9xxx

Signal	System	Signal	Potential supply	Power supply
System	KL9010 bus end terminal KL9020 terminal bus extension end terminal KL9050 terminal bus extension coupler terminal KL9060 adapter terminal for power terminal KL8xxx KL9080 isolation terminal KL9180 KS9180 potential distribution terminal KL9185 KS9185 potential distribution terminal, only 2 power contacts KL9186 KS9186 potential distribution, 8 x 24 V KL9187 KS9187 potential distribution, 8 x 0 V KL9195 KS9195 shield terminal	24 V DC	KL9100 KS9100 KL9110 KS9110 diagnostic KL9200 with fuse KL9210 diagnostic, with fuse	KL9400 KS9400 input 24 V DC, K-bus power supply, 2 A KL9505 KS9505 input 24 V DC, output 5 V DC, 1 A KL9508 KS9508 input 24 V DC, output 8 V DC, 0.5 A KL9510 KS9510 input 24 V DC, output 10 V DC, 0.5 A KL9512 KS9512 input 24 V DC, output 12 V DC, 0.5 A KL9515 KS9515 input 24 V DC, output 15 V DC, 0.5 A KL9528 KS9528 AS-Interface potential supply KL9560 KS9560 input 24 V DC, output 24 V DC, 0.1 A
Filter	KL9540 KS9540 surge filter terminal for field supply KL9550 KS9550 surge filter terminal for system/field supply	120 ... 230 V AC	KL9150 KS9150 KL9160 KS9160 diagnostic KL9250 with fuse KL9260 diagnostic, with fuse	
Diode array	KL9300 KS9300 4 diodes, potential-free KL9301 KS9301 7 diodes, common cathode KL9302 KS9302 7 diodes, common anode	up to 400 V AC	KL9190 KS9190 KL9290 with fuse	

KLxxx: Standard Bus Terminals, KSxxx: Bus Terminals with pluggable wiring level



ETHERCAT

Ultra high-speed I/O



EtherCAT 

Ethernet for Control and Automation Technology

EtherCAT (Ethernet for Control Automation Technology) is the Ethernet solution for industrial automation, characterised by outstanding performance and particularly simple handling. EtherCAT enables the Ethernet star topology to be replaced with a simple line structure. Optionally, EtherCAT may also be wired in the "classic" way using switches, in order to integrate further Ethernet devices. The master requires no special plug-in card and can be implemented on any existing Ethernet controller using a

very simple interface. EtherCAT is therefore also well suited to small and medium control technology, where it will also open up new areas of application for distributed I/Os. The extremely high performance of the EtherCAT technology enables control concepts that could not be realised with classic fieldbus systems. With EtherCAT, a communication technology is available that matches the superior computing capacity of modern Industrial PCs.

Principle of operation

From an Ethernet point of view, an EtherCAT segment is simply a single large Ethernet device, which receives and sends Ethernet frames. However, the device does not contain an Ethernet controller with downstream microprocessor, but a large number of EtherCAT slaves. These slaves process the incoming telegrams directly and extract the relevant user data, or they insert them and transfer the telegram to the next EtherCAT slave. The last EtherCAT slave sends the fully processed telegram back, so that it is returned by the first slave to the master as a kind of response telegram. The telegrams are only delayed by a few nanoseconds.

Naturally, like for any other Ethernet device, direct communication without switch may be established using a "cross-over" Ethernet cable, thereby creating a pure EtherCAT system.

Telegrams are processed directly "on the fly". While the telegrams (delayed by only a few bits) are already passed on, the slave recognizes relevant commands and executes them accordingly.

Topology

Line, tree or star: EtherCAT supports almost any topology. The bus or line structure known from the fieldbuses thus also becomes available for Ethernet. Particularly useful for system wiring is the combination of lines and branches or stubs: The required

interfaces exist on the couplers; no additional switches are required. Naturally, the classic switch-based Ethernet star topology can also be used. Wiring flexibility is further maximised through the choice of different cables. Flexible and inexpensive standard Ethernet patch cables transfer the signals optionally in Ethernet mode (100Base-TX) or in E-bus signal representation. The Fast Ethernet physics enables a cable length of 100 m between two devices, the E-bus line is intended for distances of up to 10 m.

For each cable distance, the signal variant can be selected individually. Since up to 65,535 devices can be connected, the size of the network is almost unlimited.

EtherCAT components

On the hardware side, EtherCAT technology is located in EtherCAT Terminals, for example. The I/O system in protection class IP 20 is based on the housing of the tried and tested Beckhoff Bus Terminal system. In contrast to Bus Terminals, where the fieldbus protocol data is converted within the Bus Coupler to the internal, fieldbus-independent terminal bus, the EtherCAT protocol remains fully intact down to the individual terminal. In addition to EtherCAT Terminals with E-bus connection, the proven standard Bus Terminals with K-bus connection can also be connected via the BK1120 EtherCAT Bus Coupler. This ensures compatibility and continuity

with the prevalent system. Existing and future investments are protected. The Beckhoff Servo Drives are also available with EtherCAT interface.

EtherCAT will be integrated in further Beckhoff components, such as the Fieldbus Box in protection class IP 67. The Beckhoff Industrial PCs, the Embedded PCs of the CX series, the Control Panels with control functionality, and the Ethernet PCI cards already offer inherent EtherCAT capability.

Openness

The EtherCAT technology is not only fully Ethernet-compatible, but also characterised by particular openness "by design": The protocol tolerates other Ethernet-based services and protocols on the same physical network – usually even with minimum loss of performance. Any Ethernet device can be connected within the EtherCAT segment via a switchport terminal without influencing the cycle time. Devices with fieldbus interface are integrated via EtherCAT fieldbus master terminals.



PRODUCT OVERVIEW ETHERCAT

EtherCAT Coupler		Digital input: EL1xxx ES1xxx			
		Signal	2-channel	4-channel	8-channel
Coupler	EK1100 E-bus interface (EtherCAT Terminals ELxxxx)	5 V DC		EL1124 ES1124 filter 10 µs	
		12 V DC		EL1144 ES1144 filter 10 µs	
		24 V DC	EL1002 ES1002 filter 3.0 ms, type 1, p-switching	EL1004 ES1004 filter 3.0 ms, type 1, p-switching	EL1008 ES1008 filter 3.0 ms, type 1, p-switching
	BK1120 K-bus interface (Bus Terminals KLxxxx)		EL1012 ES1012 filter 10 µs, type 1, p-switching	EL1014 ES1014 filter 10 µs, type 1, p-switching	EL1018 ES1018 filter 10 µs, type 1, p-switching
	EK1000 E-bus interface for operation at the switch (EtherCAT Terminals ELxxxx) UDP, MAC-ID			EL1024 ES1024 filter 3.0 ms, type 2, p-switching	
				EL1034 ES1034 filter 10 µs, potential-free inputs	
				EL1104 ES1104 filter 3.0 ms, ± sensor supply	
			EL1202 ES1202 T _{on} /T _{off} 1 µs, fast input	EL1114 ES1114 filter 10 µs, ± sensor supply	
			EL1252 ES1252 filter 10 µs, time stamp	EL1084 ES1084 filter 3.0 ms, n-switching	EL1088 ES1088 filter 3.0 ms, n-switching
			EL1262 ES1262 filter 10 µs, oversampling	EL1094 ES1094 filter 10 µs, n-switching	EL1098 ES1098 filter 10 µs, n-switching
Extension system	EK1110 extension end terminal (EtherCAT)			EL1904 TwinSAFE, 4 safe inputs	
		48 V DC		EL1134 ES1134 filter 10 µs	
		120 V AC/DC	EL1712 ES1712 power contacts		
		230 V AC	EL1702 ES1702 power contacts		
			EL1722 ES1722 no power contacts		
		Counter	EL1502 ES1502 up/down, 24 V DC, 100 kHz, 32 bit		
			EL1512 ES1512 up/down, 24 V DC, 1 kHz, 16 bit		

ELxxxx: Standard EtherCAT Terminals, ESxxxx: EtherCAT Terminals with pluggable wiring level

EtherCAT Technology Group

The EtherCAT Technology Group (ETG) is an association of automation users and manufacturers aiming to support the development of the EtherCAT technology. The consortium represents a wide range of sectors and application areas. This ensures that the EtherCAT technology functions and interfaces are ideally prepared for a wide range of applications. The organisation ensures that EtherCAT can easily and cost-effectively be

integrated in a wide range of automation devices, and it also ensures interoperability of the implementations. The EtherCAT Technology Group is the official IEC partner organisation for fieldbus standardisation. Membership is open to all companies.

For further information see www.ethercat.org



Digital output: EL2xxx | ES2xxx

Signal	1-channel	2-channel	4-channel	8-channel
5 V DC			EL2124 ES2124	
24 V DC		EL2002 ES2002 <i>I</i> _{MAX} = 0.5 A	EL2004 ES2004 <i>I</i> _{MAX} = 0.5 A	EL2008 ES2008 <i>I</i> _{MAX} = 0.5 A
		EL2022 ES2022 <i>I</i> _{MAX} = 2.0 A	EL2024 ES2024 <i>I</i> _{MAX} = 2.0 A	
		EL2032 ES2032 <i>I</i> _{MAX} = 2.0 A, with diagnostic	EL2034 ES2034 <i>I</i> _{MAX} = 2.0 A, with diagnostic	
		EL2252 ES2252 <i>I</i> _{MAX} = 0.5 A, time stamp	EL2084 ES2084 <i>I</i> _{MAX} = 0.5 A, n-switching	EL2088 ES2088 <i>I</i> _{MAX} = 0.5 A, n-switching
		EL2262 ES2262 <i>I</i> _{MAX} = 0.5 A, oversampling		
		EL2202 ES2202 <i>T</i> _{on} / <i>T</i> _{off} 1 µs, push-pull outputs	EL2904 TwinSAFE, 4 safe outputs	
Relay (up to 230 V AC)		EL2602 ES2602 <i>I</i> _{MAX} = 2.0 A, make contact, power contacts		
		EL2622 ES2622 <i>I</i> _{MAX} = 2.0 A, make contact, no power contacts		
		EL2612 ES2612 <i>I</i> _{MAX} = 1.0 A, change-over, no power contacts		
Triac (up to 230 V AC)		EL2712 ES2712 12 ... 230 V, 0.5 A, power contacts		
		EL2732 ES2732 12 ... 230 V, 0.5 A, no power contacts		
		EL2722 ES2722 12 ... 230 V, 1.0 A, mutually locked outputs		
PWM		EL2502 ES2502 PWM output, 24 V DC, 1.0 A		
		EL2535 ES2535 24 V DC, 1.0 A, current-controlled		
		EL2545 ES2545 50 V DC, 3.5 A, current-controlled		
Pulse train	EL2521 ES2521 1 ... 500 kHz			

ELxxxx: Standard EtherCAT Terminals, ESxxxx: EtherCAT Terminals with pluggable wiring level

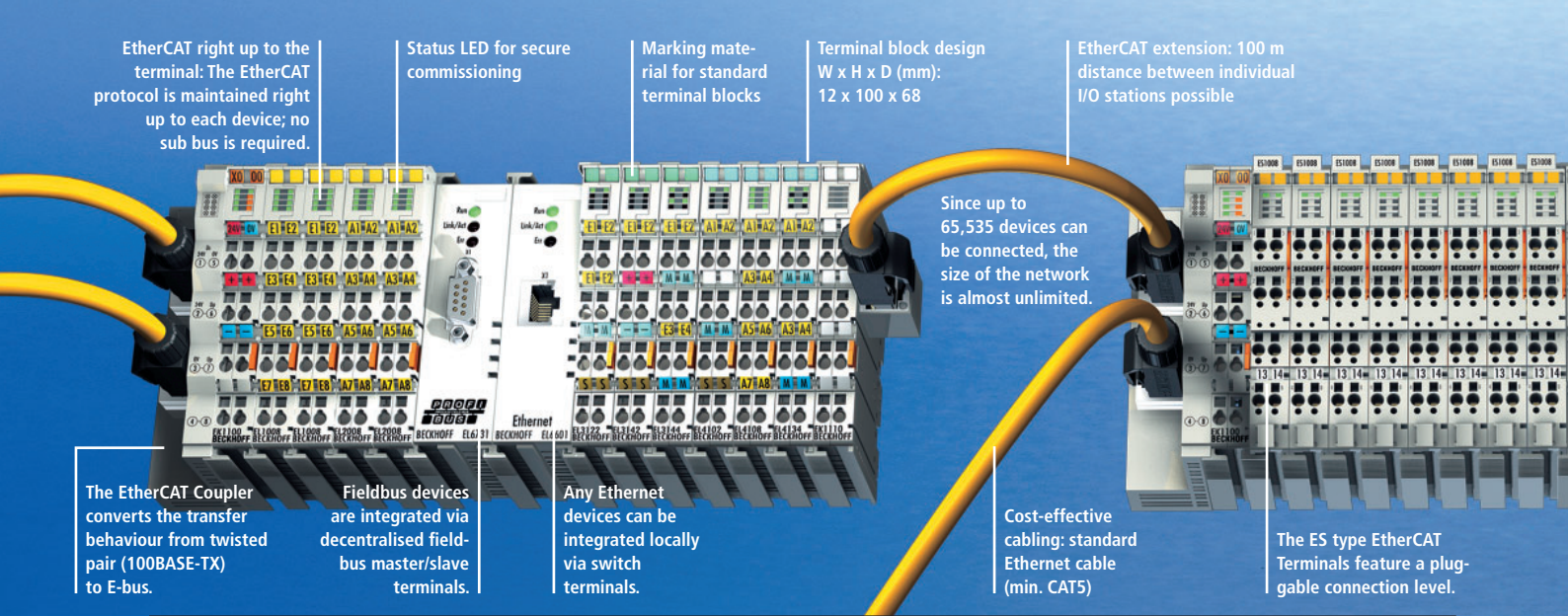

EtherCAT right up to the terminal: The EtherCAT protocol is maintained right up to each device; no sub bus is required.

Status LED for secure commissioning

Marking material for standard terminal blocks

Terminal block design
W x H x D (mm):
12 x 100 x 68

EtherCAT extension: 100 m distance between individual I/O stations possible

Since up to 65,535 devices can be connected, the size of the network is almost unlimited.

The EtherCAT Coupler converts the transfer behaviour from twisted pair (100BASE-TX) to E-bus.

Fieldbus devices are integrated via decentralised fieldbus master/slave terminals.

Any Ethernet devices can be integrated locally via switch terminals.

Cost-effective cabling: standard Ethernet cable (min. CAT5)

The ES type EtherCAT Terminals feature a pluggable connection level.

Analog input: EL3xxx | ES3xxx

Signal	1-channel	2-channel	4-channel	8-channel
0 ... 10 V	EL3061 ES3061 single-ended, 12 bit	EL3062 ES3062 single-ended, 12 bit	EL3064 ES3064 single-ended, 12 bit	EL3068 ES3068 single-ended, 12 bit
	EL3161 ES3161 single-ended, 16 bit	EL3162 ES3162 single-ended, 16 bit	EL3164 ES3164 single-ended, 16 bit	
± 10 V	EL3001 ES3001 single-ended, 12 bit	EL3002 ES3002 single-ended, 12 bit	EL3004 ES3004 single-ended, 12 bit	EL3008 ES3008 single-ended, 12 bit
	EL3101 ES3101 differential input, 16 bit	EL3102 ES3102 differential input, 16 bit	EL3104 ES3104 differential input, 16 bit	
		EL3702 ES3702 differential input, 16 bit, oversampling		
0 ... 20 mA	EL3041 ES3041 single-ended, 12 bit, terminal supply	EL3042 ES3042 single-ended, 12 bit, terminal supply	EL3044 ES3044 single-ended, 12 bit	EL3048 ES3048 single-ended, 12 bit
	EL3141 ES3141 single-ended, 16 bit, terminal supply	EL3142 ES3142 single-ended, 16 bit, terminal supply	EL3144 ES3144 single-ended, 16 bit	
	EL3011 ES3011 differential input, 12 bit	EL3012 ES3012 differential input, 12 bit	EL3014 ES3014 differential input, 12 bit	
	EL3111 ES3111 differential input, 16 bit	EL3112 ES3112 differential input, 16 bit	EL3114 ES3114 differential input, 16 bit	
		EL3742 ES3742 differential input, 16 bit, oversampling		
4 ... 20 mA	EL3051 ES3051 single-ended, 12 bit, terminal supply	EL3052 ES3052 single-ended, 12 bit, terminal supply	EL3054 ES3054 single-ended, 12 bit	EL3058 ES3058 single-ended, 12 bit
	EL3151 ES3151 single-ended, 16 bit, terminal supply	EL3152 ES3152 single-ended, 16 bit, terminal supply	EL3154 ES3154 single-ended, 16 bit	
	EL3021 ES3021 differential input, 12 bit	EL3022 ES3022 differential input, 12 bit	EL3024 ES3024 differential input, 12 bit	
	EL3121 ES3121 differential input, 16 bit	EL3122 ES3122 differential input, 16 bit	EL3124 ES3124 differential input, 16 bit	
Thermocouples	EL3311 type J, K, L, ... U, 16 bit	EL3312 type J, K, L, ... U, 16 bit	EL3314 type J, K, L, ... U, 16 bit	
Resistance thermometer (RTD)	EL3201 ES3201 PT100...1000, Ni100, 16 bit	EL3202 ES3202 PT100...1000, Ni100, 16 bit	EL3204 ES3204 PT100...1000, Ni100, 16 bit	
Resistor bridge	EL3356 ES3356 strain gauge, 16 bit, self-calibration			
Power measurement		EL3403 ES3403 3-phase power measurement terminal		

ELxxxx: Standard EtherCAT Terminals, ESxxxx: EtherCAT Terminals with pluggable wiring level

Screwless connection using the proven Cage Clamp® system with vertical cable feed

Flexible wiring: Line or tree topologies can be freely selected and combined. Addresses are assigned automatically.

Integrated safety: The TwinSAFE Bus Terminals enable the connection of safety sensors and actuators.

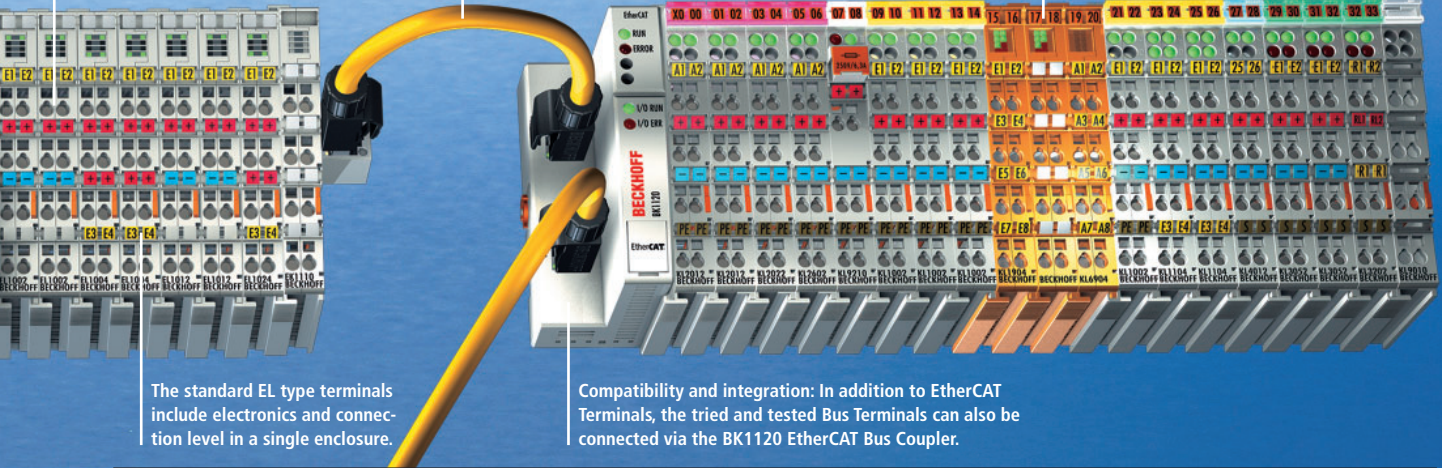

The standard EL type terminals include electronics and connection level in a single enclosure.

Compatibility and integration: In addition to EtherCAT Terminals, the tried and tested Bus Terminals can also be connected via the BK1120 EtherCAT Bus Coupler.

Analog output: EL4xxx | ES4xxx

Signal	1-channel	2-channel	4-channel	8-channel
0 ... 10 V	EL4001 ES4001 12 bit	EL4002 ES4002 12 bit	EL4004 ES4004 12 bit	EL4008 ES4008 12 bit
		EL4102 ES4102 16 bit	EL4104 ES4104 16 bit	
± 10 V	EL4031 ES4031 12 bit	EL4032 ES4032 12 bit	EL4034 ES4034 12 bit	EL4038 ES4038 12 bit
		EL4132 ES4132 16 bit	EL4134 ES4134 16 bit	
		EL4732 ES4732 16 bit, oversampling		
0 ... 20 mA	EL4011 ES4011 12 bit	EL4012 ES4012 12 bit	EL4014 ES4014 12 bit	EL4018 ES4018 12 bit
		EL4112 ES4112 16 bit	EL4114 ES4114 16 bit	
		EL4712 ES4712 16 bit, oversampling		
4 ... 20 mA	EL4021 ES4021 12 bit	EL4022 ES4022 12 bit	EL4024 ES4024 12 bit	EL4028 ES4028 12 bit
		EL4122 ES4122 16 bit	EL4124 ES4124 16 bit	
± 10 mA		EL4112-0010 ES4112-0010 16 bit		

ELxxxx: Standard EtherCAT Terminals, ESxxxx: EtherCAT Terminals with pluggable wiring level



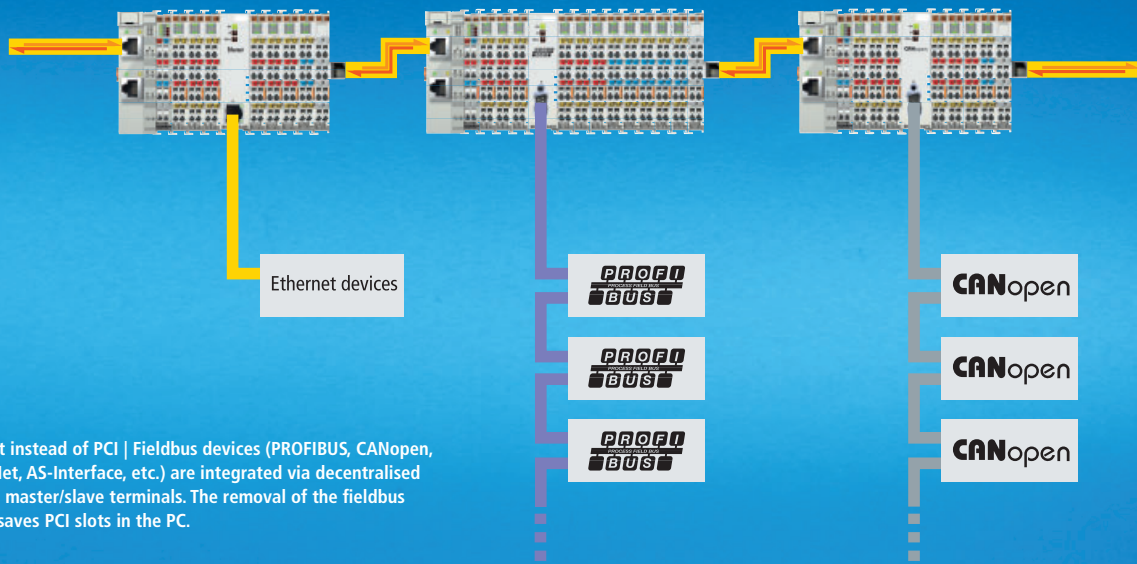

Ethernet instead of PCI | Fieldbus devices (PROFIBUS, CANopen, DeviceNet, AS-Interface, etc.) are integrated via decentralised fieldbus master/slave terminals. The removal of the fieldbus master saves PCI slots in the PC.

Special functions: EL5xxx | ES5xxx, EL6xxx | ES6xxx, EL7xxx | ES7xxx

Signal	1-channel	2-channel	4-channel
Position measurement	EL5001 ES5001 SSI encoder interface		
	EL5101 ES5101 incremental encoder interface, differential inputs		
	EL5151 ES5151 incremental encoder interface, 32 bit		
Communication	EL6001 ES6001 RS232, 115.2 kbaud		
	EL6021 ES6021 RS422/RS485, 115.2 kbaud		
	EL6201 ES6201 AS-Interface master terminal		EL6224 ES6224 IO link
	EL6601 switch port	EL6692 EtherCAT bridge terminal	EL6614 switch port
	EL6731 PROFIBUS DP master terminal		
	EL6731-0010 PROFIBUS DP slave terminal		
	EL6740-0010 Interbus slave terminal		
	EL6751 CANopen master terminal		
	EL6751-0010 CANopen slave terminal		
	EL6752 DeviceNet master terminal		
	EL6752-0010 DeviceNet slave terminal		EL6904 TwinSAFE logic terminal, with 4 digital outputs
Motion	EL7031 ES7031 stepper motor terminal, $I_{MAX} = 1.5 A, 24 V$	EL7332 ES7332 DC motor output stage, 24 V DC, 1.0 A	EM7004 4 incremental encoder, 16 digital inputs 24 V DC,
	EL7041 ES7041 stepper motor terminal, $I_{MAX} = 5.0 A, 50 V$, incremental encoder interface	EL7342 ES7342 DC motor output stage, 50 V DC, 3.5 A, incremental encoder interface	16 digital outputs 24 V DC, 4 analog inputs $\pm 10 V$

System terminals: EL9xxx | ES9xxx

Signal	System
System	EL9011 bus end cap
	EL9080 isolation terminal
	EL9180 ES9180 potential distribution terminal, 2 clamping units per power contact
	EL9185 ES9185 potential distribution terminal, 4 clamping units at 2 power contacts
	EL9186 ES9186 potential distribution, 8 x 24 V
	EL9187 ES9187 potential distribution, 8 x 0 V
	EL9195 ES9195 shield terminal

ELxxxx: Standard EtherCAT Terminals, ESxxxx: EtherCAT Terminals with pluggable wiring level

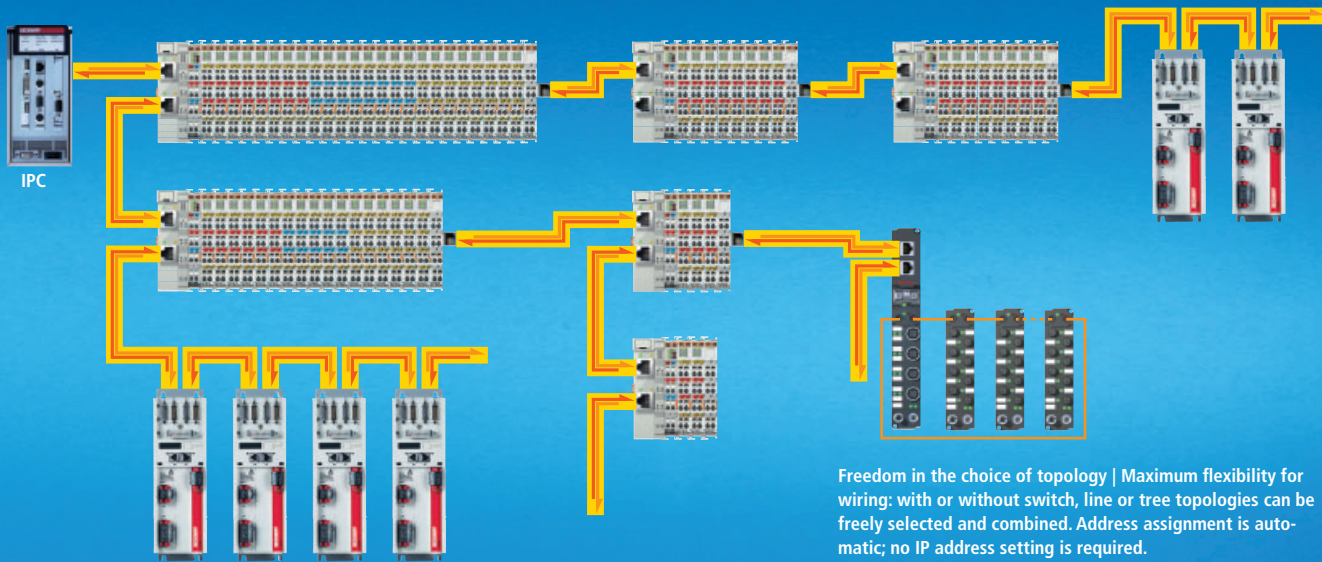

Freedom in the choice of topology | Maximum flexibility for wiring: with or without switch, line or tree topologies can be freely selected and combined. Address assignment is automatic; no IP address setting is required.

EtherCAT

Signal	Potential supply	Power supply
24 V DC	EL9100 ES9100	EL9400 ES9400 input 24 V DC, E-bus power supply, 2 A
	EL9110 ES9110 diagnostic	EL9505 ES9505 input 24 V DC, output 5 V DC, 0.5 A
	EL9200 with fuse	EL9508 ES9508 input 24 V DC, output 8 V DC, 0.5 A
	EL9210 diagnostic, with fuse	EL9510 ES9510 input 24 V DC, output 10 V DC, 0.5 A
		EL9512 ES9512 input 24 V DC, output 12 V DC, 0.5 A
		EL9515 ES9515 input 24 V DC, output 15 V DC, 0.5 A
	EL9520 ES9520 AS-Interface potential supply with filter	EL9560 ES9560 input 24 V DC, output 24 V DC, 0.5 A with electrical isolation
	120 ... 230 V AC	EL9150 ES9150
EL9160 ES9160 diagnostic		
EL9190 ES9190 any voltage up to 230 V without LED		
EL9250 with fuse		
EL9260 diagnostic, with fuse		

Drive Technology

Servo Drives	AX5101
	$I_N=1 \times 1 \text{ A}$, $P_N=0.8 \text{ kVA}$
	AX5103
	$I_N=1 \times 3 \text{ A}$, $P_N=2.5 \text{ kVA}$
	AX5106
	$I_N=1 \times 6 \text{ A}$, $P_N=5 \text{ kVA}$
	AX5112
	$I_N=1 \times 12 \text{ A}$, $P_N=10 \text{ kVA}$
	AX5201
	$I_N=2 \times 1 \text{ A}$, $P_N=1.6 \text{ kVA}$
	AX5203
	$I_N=2 \times 3 \text{ A}$, $P_N=5 \text{ kVA}$
	AX5206
	$I_N=2 \times 6 \text{ A}$, $P_N=10 \text{ kVA}$
	AX20xx-B110
	Servo Drive with EtherCAT interface

Servomotors	AM2000
	Synchronous Servomotors
	AM3000
	Synchronous Servomotors
	ALxxxx
	Linear Servomotors

Components/Interfaces

Embedded PC	CX1020
	Embedded PC, EtherCAT Terminal integration via power supply CX1100-0004
	CX1010
	Embedded PC, EtherCAT Terminal integration via power supply CX1100-0004
	CX9000/CX9010
	Embedded PC, with directly integrated E-bus interface
Fieldbus Box	IL230x-B110
	IP 67 Coupler Box with EtherCAT interface
PCI Ethernet	FC9001
	1-channel PCI Ethernet card
	FC9002
	2-channel PCI Ethernet card
	FC9004
4-channel PCI Ethernet card	
	FC9051/FC9151
	1-channel Mini PCI Ethernet card
Switch	CU2008
	Ethernet Switch with 8 ports
	CU2016
	Ethernet Switch with 16 ports

EtherCAT system overview

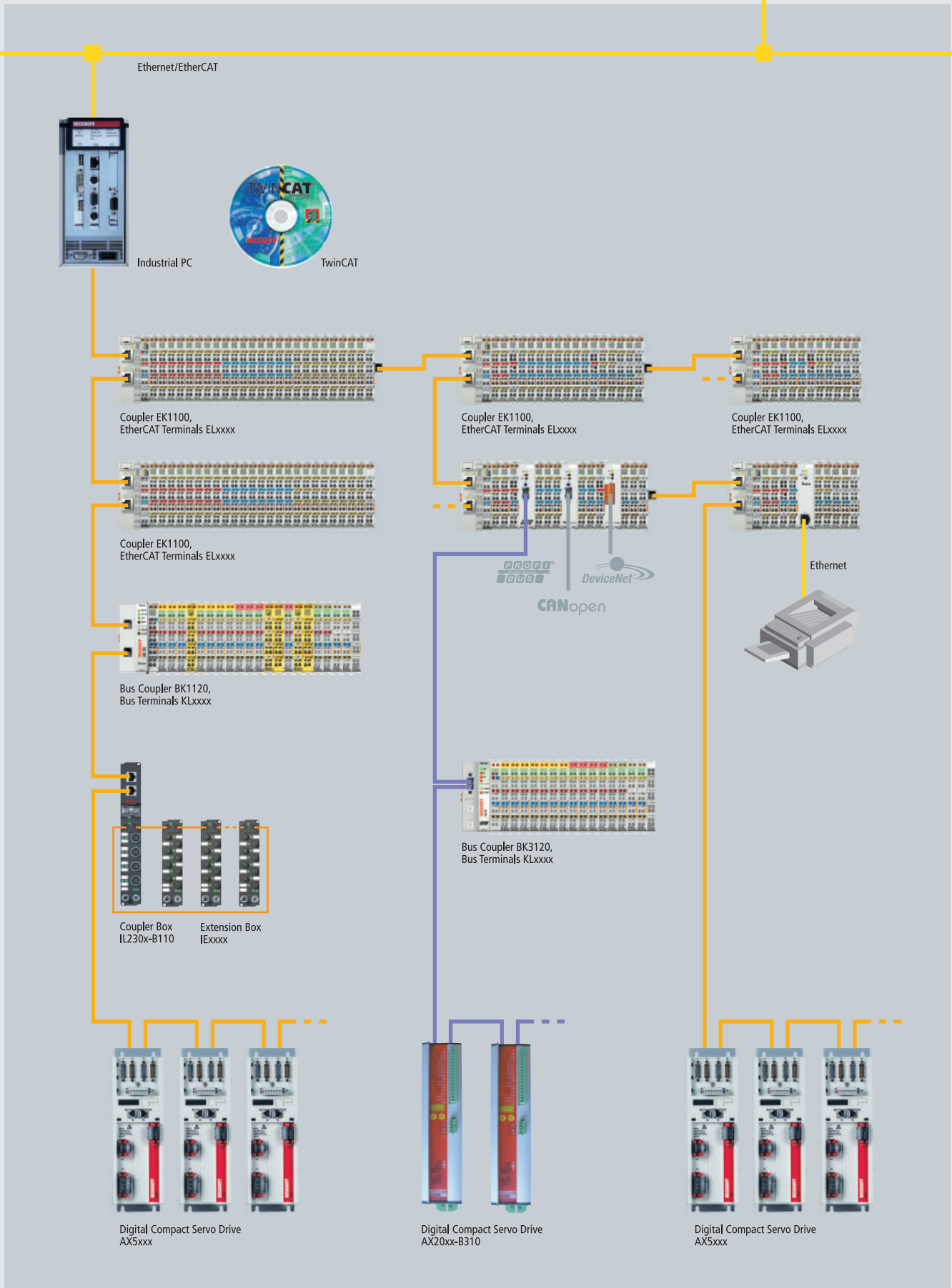



Embedded PC CX1030/CX1020/CX1010,
EtherCAT Terminals ELxxxx



Coupler EK1100,
EtherCAT Terminals ELxxxx



Coupler EK1100,
EtherCAT Terminals ELxxxx



Coupler EK1100,
EtherCAT Terminals ELxxxx



Coupler EK1100,
EtherCAT Terminals ELxxxx



Bus Coupler BK1120,
Bus Terminals KLxxxx

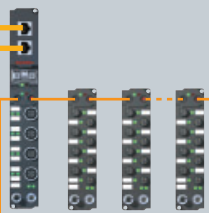

Coupler Box
IL230x-B110 Extension Box
IExxxx

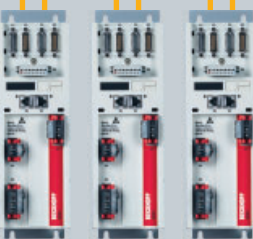

Digital Compact Servo Drive
AX5xxx



Industrial PC



Ethernet Switch



Embedded PC CX1020/CX1030,
EtherCAT Terminals ELxxxx



Ethernet Controller CX90x0,
EtherCAT Terminals ELxxxx



Coupler EK1000 for operation
at the switch



Coupler EK1100,
EtherCAT Terminals ELxxxx



Coupler EK1100,
EtherCAT Terminals ELxxxx



Coupler EK1100,
EtherCAT Terminals ELxxxx



Digital Compact Servo Drive
AX5xxx



FIELDBUS BOX

The compact IP 67 modules



The Fieldbus Box

A number of considerations led, years ago, to the introduction of the fieldbus systems: The first target was a reduction in the quantity of wiring. Simplified system diagnostics, enabled by intelligent field devices that could send detailed information

about malfunctions and errors quickly to the controller, came later. Finally the field devices were given controller functionality for distributed data pre-processing and for simple control tasks.

The Beckhoff Fieldbus Box system is the culmination of the fieldbus concept:

Robust

Robust construction allows fieldbus modules to be fitted directly to machines. Control cabinets and terminal boxes are now no longer required.

Sealed

The modules meet the protection class IP 65, IP 66 or IP 67, are fully casted and thus ideally prepared for use in wet, dirty and dusty working environments.

Small

The modules are extremely small, and are thus suitable for use in applications where there is very little space available. The low weight of the Fieldbus Box modules makes them useful in applications where the I/O interface is in motion (e.g. on a robot arm).

Open

All the most important fieldbus systems are supported. This substantially frees electrical design from the particular bus system in use. Fast, flexible reactions to customers' requirements are possible. The Fieldbus Box modules are, of course, certified by the respective

fieldbus user organisations, and can be combined with Beckhoff Bus Terminals and with devices from third-party manufacturers.

Modular

Extension modules allow the Coupler Box modules to be inexpensively extended.

Quickly wired

The wiring of the fieldbus and of signals is significantly simplified through the use of pre-assembled cables. Wiring errors are minimised, and the system setup is finished quickly.

Flexible

In addition to the pre-assembled cables, field wireable connectors and cables are also available for maximum flexibility.

Economical

Combined I/O modules and fine signal granularity lead to low system costs – you only have to buy what you really need.

Complete

The wide variety of signal types allows the connection of almost any kind of sensor. The communication modules enable decentralised connection of, e.g., label printers, identification systems or special equipment. The

Fieldbus Box range also includes encoder interfaces for displacement and angle measurement.

Fitting

Sensors and actuators are connected through 8 mm diameter snap type or through screw type connectors (M8 or M12). The snap type connectors lock in place positively, forming a vibrationproof connection, while the screw type connectors offer the advantage of high resistance to being pulled out.

Compatible

The Fieldbus Box devices behave very much like the Beckhoff Bus Terminals – this means that the ideal distributed peripheral device can be used, whatever the particular application.

Intelligent

Even the standard modules are intelligent fieldbus devices – with self-diagnosis and versatile functions. The Fieldbus Box is furthermore available as a small local controller – the PLC Box. Programmable in all five languages in accordance with IEC 61131-3, with floating point arithmetic and with sufficient performance and memory for the majority of decentralised control and regulation tasks.



PRODUCT OVERVIEW FIELDBUS BOX

The Fieldbus Box: 4 device classes, 9 fieldbuses, 24 signal types, 3 connection options

Compact Box

Coupler Box

PLC Box

Extension Box

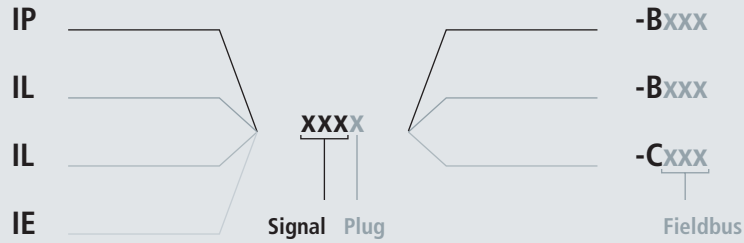

The system is composed of 4 device classes:



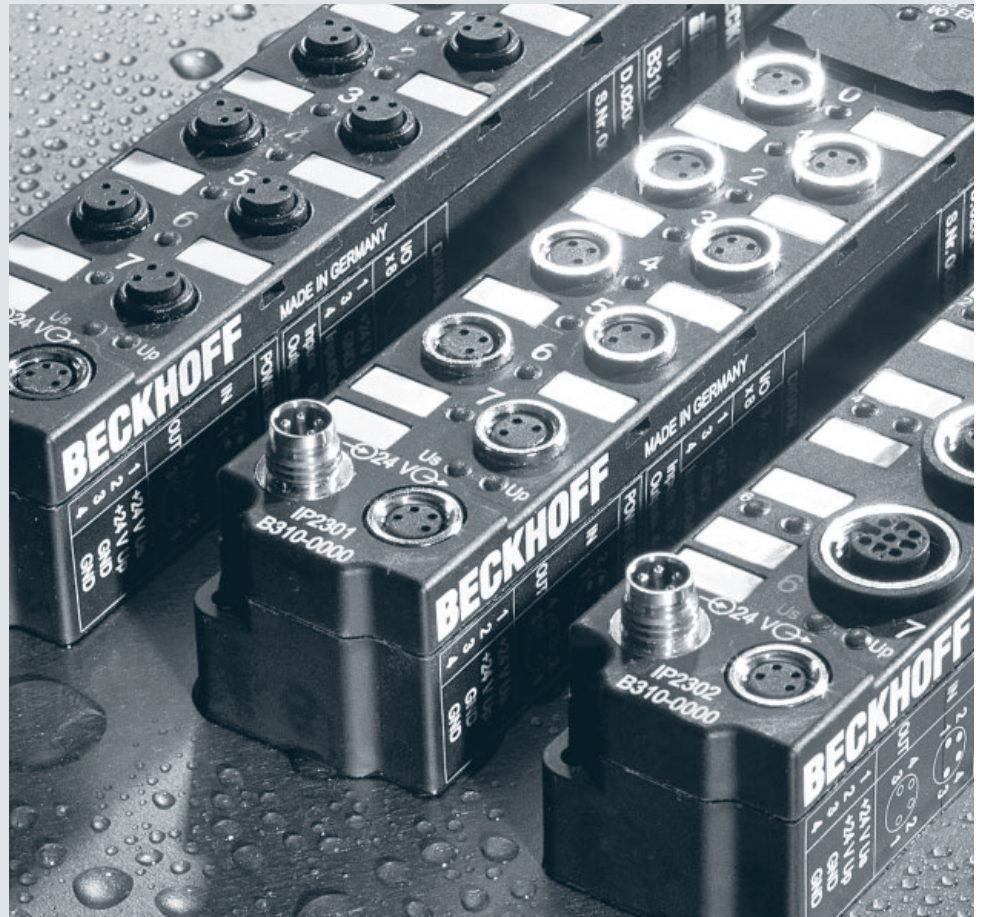

- **Compact Box:**
rugged signal variety for almost any bus system (IPxxx-Bxxx)
- **Coupler Box:**
bus module with IP-Link extension interface (IL230x-Bxxx)
- **PLC Box:**
IEC 61131-3 intelligence in the smallest amount of space, with IP-Link (IL230x-Cxxx)
- **Extension Box:** for all signal types, connectable over IP-Link (IExxxx)

3 connection options:

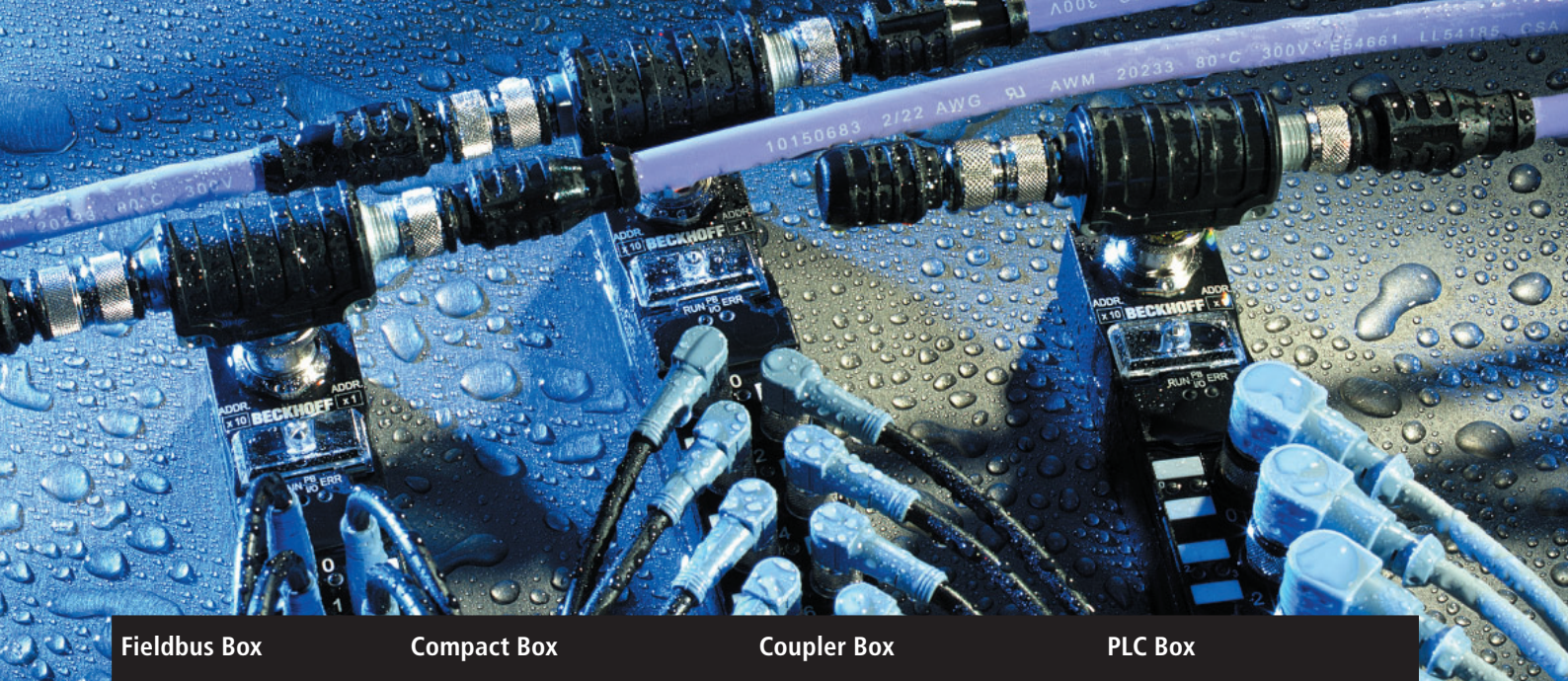
- **8 mm:** connector 8 mm, snap type, 3 pins
- **M8:** connector M8, screw type, 3 pins
- **M12:** connector M12, screw type, 5 pins





Fieldbus Box	Compact Box	Coupler Box	PLC Box
Fieldbus	Fieldbus Box without IP-Link interface	Fieldbus Box with IP-Link interface	Controller IEC 61131-3 with IP-Link interface
EtherCAT 		IL230x-B110	
LIGHTBUS	IPxxxx-B200	IL230x-B200	
PROFINET 	IPxxxx-B310	IL230x-B310	IL230x-C310
	IPxxxx-B318 with integrated tee-connector	IL230x-B318 with integrated tee-connector	IL230x-C318 with integrated tee-connector
INTERBUS  Certified! No. 099	IPxxxx-B400	IL230x-B400	
CANopen	IPxxxx-B510	IL230x-B510	
	IPxxxx-B518 with integrated tee-connector	IL230x-B518 with integrated tee-connector	
DeviceNet 	IPxxxx-B520	IL230x-B520	
	IPxxxx-B528 with integrated tee-connector	IL230x-B528 with integrated tee-connector	
Modbus	IPxxxx-B730	IL230x-B730	
RS485	IPxxxx-B800	IL230x-B800	
RS232	IPxxxx-B810	IL230x-B810	IL230x-C810
Ethernet TCP/IP		IL230x-B900	IL230x-C900
		IL230x-B901	



Fieldbus independent:
Modules for almost any fieldbus

Tilting window, diagnostic interface
and address selector switch

Water- and dustproof with protection
class IP 67 (resin filled)

Power supply input:
control voltage, output supply voltage

Compact Box

Ultra compact dimensions
175 x 30 x 27 mm (H x W x D)

Power supply extension

Digital I/O

Input		8 mm	M8	M12
24 V DC	8-channel filter 3.0 ms	IP1000-Bxxx IE1000	IP1001-Bxxx IE1001	IP1002-Bxxx IE1002
	8-channel filter 0.2 ms	IP1010-Bxxx IE1010	IP1011-Bxxx IE1011	IP1012-Bxxx IE1012
Counter	2-channel up/down counter 24 V DC, 100 kHz			IP1502-Bxxx IE1502
Output		8 mm	M8	M12
24 V DC	8-channel $I_{MAX} = 0.5 A$	IP2000-Bxxx IE2000	IP2001-Bxxx IE2001	IP2002-Bxxx IE2002
	8-channel $I_{MAX} = 2 A, \sum 4 A$	IP2020-Bxxx IE2020	IP2021-Bxxx IE2021	IP2022-Bxxx IE2022
	8-channel $I_{MAX} = 2 A, \sum 12 A$	IP2040-Bxxx IE2040	IP2041-Bxxx IE2041	IP2042-Bxxx IE2042
	16-channel $I_{MAX} = 0.5 A, \sum 4 A, D\text{-sub socket}$			IE2808
PWM	2-channel PWM, 24 V DC, $I_{MAX} = 2.5 A$			IP2512-Bxxx IE2512
Combi		8 mm	M8	M12
24 V DC	8-channel 4 input + 4 output filter 3.0 ms, $I_{MAX} = 0.5 A$	IP2300-Bxxx IL2300-Bxxx IL2300-Cxxx IE2300	IP2301-Bxxx IL2301-Bxxx IL2301-Cxxx IE2301	IP2302-Bxxx IL2302-Bxxx IL2302-Cxxx IE2302
	8-channel, 4 input + 4 output filter 0.2 ms, $I_{MAX} = 0.5 A$	IP2310-Bxxx IE2310	IP2311-Bxxx IE2311	IP2312-Bxxx IE2312
	8-channel, 4 input + 4 output filter 3.0 ms, $I_{MAX} = 2 A, \sum 4 A$	IP2320-Bxxx IE2320	IP2321-Bxxx IE2321	IP2322-Bxxx IE2322
	8-channel, 4 input + 4 output filter 0.2 ms, $I_{MAX} = 2 A, \sum 4 A$	IP2330-Bxxx IE2330	IP2331-Bxxx IE2331	IP2332-Bxxx IE2332
	16-channel, combi input/output filter 3.0 ms, $I_{MAX} = 0.5 A$	IP2400-Bxxx IE2400	IP2401-Bxxx IE2401	
	16-channel, combi input/output filter 3.0 ms, $I_{MAX} = 0.5 A$	IE2403 (IP 20, snap type)		

Coupler/PLC Box

IP-Link interface for the direct access of up to 120 extension modules

Sensor/actuator connection via M8 (screw type), M12 (screw type) or Ø 8 mm (snap type) connectors

Fieldbus Box Coupler also available with PLC functionality

Extension Box

IP-Link in interference-free fibre optic

Analog I/O

Input

	4-channel	M12
±10 V	4-channel differential input, 16 bit	IP3102-Bxxx IE3102
0/4 ... 20 mA	4-channel differential input, 16 bit	IP3112-Bxxx IE3112
Resistance thermometer	4-channel resistance thermometer (RTD), PT100, PT200, PT500, PT1000, Ni100, 16 bit	IP3202-Bxxx IE3202
Thermocouples	4-channel thermocouple, type J, K, L, B, E, N, R, S, T, U, 16 bit	IP3312-Bxxx IE3312

Output

	4-channel	M12
±10 V	4-channel 16 bit	IP4132-Bxxx IE4132
0/4 ... 20 mA	4-channel 16 bit	IP4112-Bxxx IE4112

Special functions

Function		M12	M23
Position measurement	1-channel SSI encoder interface		IP5009-Bxxx IE5009
	1-channel incremental encoder interface, 1 MHz		IP5109-Bxxx IE5109
	1-channel SinCos encoder interface		IP5209-Bxxx (1 V _{SS}) IP5209-Bxxx-1000 (11 μA _{SS})
Communication	1-channel serial interface, RS232	IP6002-Bxxx IE6002	
	1-channel serial interface, 0 ... 20 mA (TTY)	IP6012-Bxxx IE6012	
	1-channel serial interface, RS422/RS485	IP6022-Bxxx IE6022	

Valve terminal

16-channel Festo valve terminal with IP-Link connection, size 10 mm	CPV10-VI-IP-8*
16-channel Festo valve terminal with IP-Link connection, size 14 mm	CPV14-VI-IP-8*
16-channel SMC valve terminal with IP-Link interface	EX250*

* The CPV1x-VI-IP-8 valve terminals can be ordered only from Festo AG & Co. (www.festo.com); the EX250 valve terminals can be ordered only from SMC (www.smceu.com).

LIGHTBUS

The fast fibre optic fieldbus

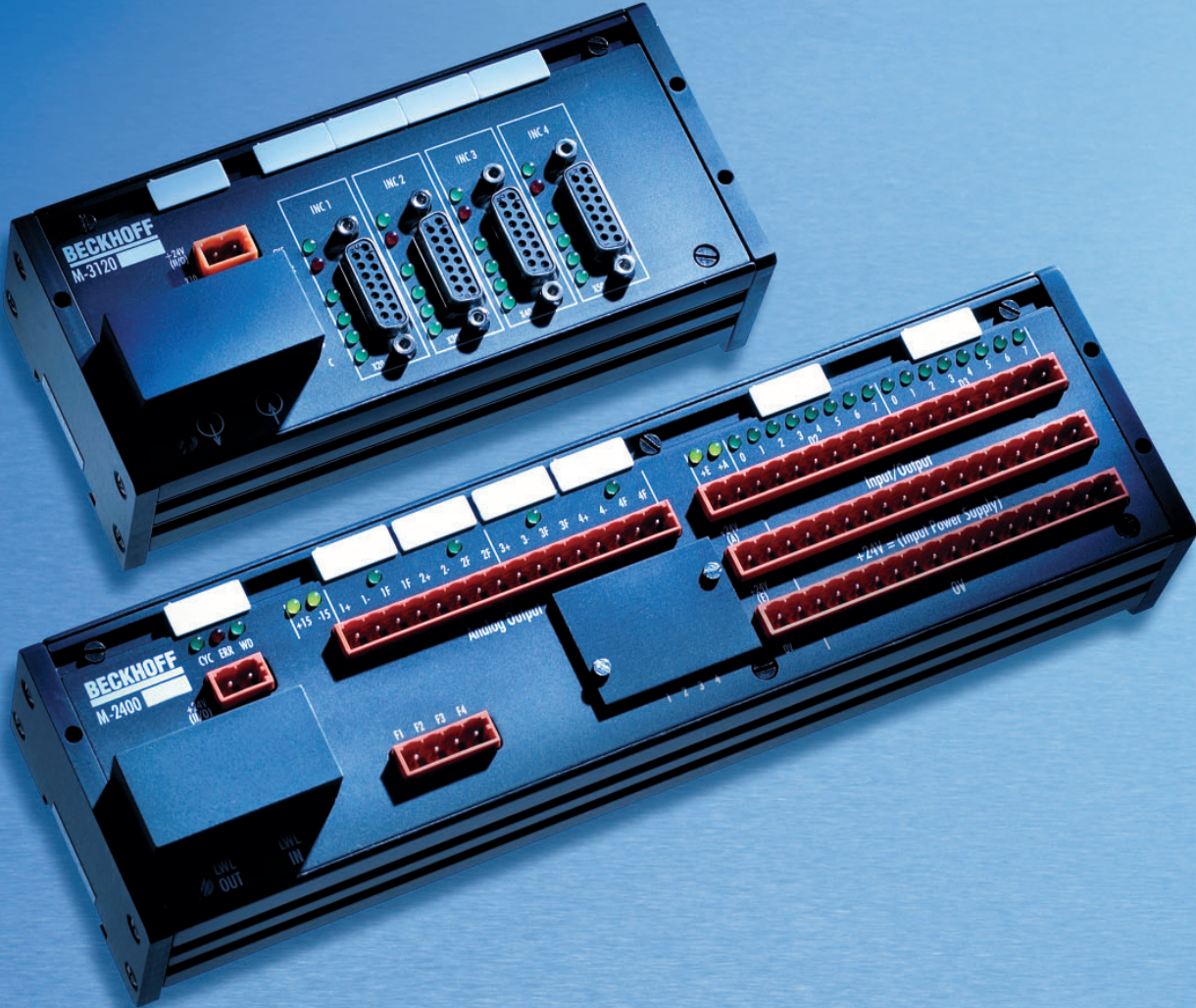

Interference-free fieldbus communication for fast machine controls

Increasing automation, increasingly complex production equipment, rising demands on speed and communication – this is where conventional cabling and installation technology reaches its limits.

Light up the dark with the Beckhoff Lightbus system by replacing complete cable routes with one single fibre optic conductor. Instead of extensive I/O interfacing units, only one

intelligent Beckhoff Lightbus interface board is integrated in the control computer and the decentralised Lightbus modules are directly situated locally.

Installation effort and costs are reduced drastically, handling and maintenance are simplified, and interference immunity and performance are increased.

New ways for control technology with light

The Lightbus was introduced as far back as 1989 as the Beckhoff system bus for fast machine controllers, and has become the market leader in many sectors. These include, for instance, production machines for windows, wood processing machines, presses, packaging machines, machine tools, and applications in metrology and technical building services.

Fast and failsafe industrial communication

The Beckhoff Lightbus system is a fast and failsafe serial fieldbus system that was conceived for the needs of automation technology. Low-cost and easy-to-process standard fibre optic conductor technology is used for transmission. The crucial advantages of the fibre optic conductor are interference immunity to electromagnetic influences, complete electrical isolation of connected modules from one another and a high data transfer rate. In conjunction with an optimised, compact telegram structure, the Lightbus permits a very high user information data transfer rate of up to 2.5 Mbits/s.

With one Lightbus interface board, up to 255 decentralised modules can be operated with a maximum distance of up to 300 m between two modules.

Reliability and flexibility

Reliability is a must – with efficient test and diagnostic functions, functioning of the individual Lightbus modules and communication in the entire Lightbus ring are monitored cyclically and automatically.

Changes or additions to a system configuration can be realized easily and reliably by means of configuration programs in the Lightbus system.

Lightbus features

- 2.5 Mbaud data rate
- 25 µs transmission time for 32 bits of user information
- intelligent commands for read, write, address initialisation, configuration and line test, communication is executed automatically
- up to 255 I/O modules in one ring with up to 65,280 I/O points (e. g. 64 x 4-channel Bus Terminals x 255)
- up to 300 m transmission distance between two I/O modules with HCS fibre, 45 m using PMMA fibre

Lightbus – a system for the future

The Lightbus system is open and universally applicable. Lightbus interfaces are available for common bus and computer architectures, from the standard PC up to VME computers, and for control systems in use around the world.

The wide range of distributed Lightbus components cover the requirements found in automation technology for items from displacement sensors, through universal Bus Terminals up to drive controllers:

- **Interface Cards**
for all common bus standards
- **Embedded PC**
the system for control tasks in the medium performance range
- **Bus Terminal**
the modular fieldbus system for automation
- **Modules**
the robust modules for fast, interference-free communication
- **Fieldbus Box**
the compact modules in protection class IP 67
- **Drive Technology**
Digital Compact Servo Drives for dynamic positioning tasks
- **TwinCAT**
the automation software for PLC and Motion Control tasks



PRODUCT OVERVIEW LIGHTBUS

Lightbus



Interface Cards

PCI bus	FC2001 1-channel
	FC2002 2-channel
ISA bus	C1200
	C1220 with communication processor
VME bus	C1300

Embedded PC

Master	CX1500-M200
Slaves	CX1500-B200

Bus Terminal

Bus Coupler	BK2000 Standard
	BK2010 "Economy"
	BK2020 "Economy plus"
	BK2500 Standard, RS485
PLC	BC2000
Bus Terminals	
Digital I/O	KL1xxx KS1xxx digital input
	KL2xxx KS2xxx digital output
Analog I/O	KL3xxx KS3xxx analog input
	KL4xxx KS4xxx analog output
Special functions	KL5xxx KS5xxx angle and displacement measurement
	KL6xxx KS6xxx communication
Power terminals	KL8xxx power terminals
System terminals	KL9xxx KS9xxx system terminals



Fieldbus Box

Modules

Drive Technology

Compact Box	IPxxxx-B200
Coupler Box	IL230x-B200
Extension Box	IExxxx

Interface module	M1200, M1210 CMOS interface
Digital I/O	M1110 16-channel digital I/O (configurable), 24 V DC, 0.5 A, IP 65
	M1400, M1410 16/32-channel digital I/O (configurable), 24 V DC, 0.5 A
Combi I/O	M2400 16-channel digital I/O, 24 V DC, 0.5 A, 4-channel analog output, 12 bits
Analog input	M2510 4-channel analog input, 12 bits
Special functions	M3000 absolute encoder, 24 bits
	M3100 incremental encoder interface, 24 bits, IP 65
	M3120 incremental encoder interface, 1–4-channel, 24 bits
	M3200 incremental encoder, 24 bits, IP 65
Operation panels	M63x0 built-in panel, aluminium or plastic housing

Servo Drive with Lightbus interface	AX2003-B200 I _N = 3 A, P _N = 2 kVA
	AX2006-B200 I _N = 6 A, P _N = 4.2 kVA
	AX2010-B200 I _N = 10 A, P _N = 7 kVA
	AX2020-B200 I _N = 20 A, P _N = 14 kVA
	AX2040-B200 I _N = 40 A, P _N = 30 kVA
	AX2070-B200 I _N = 70 A/80 A, P _N = 50 kVA
	AX2503-B200 master module I _N = 3 A, P _N = 7 kVA
	AX2506-B200 master module I _N = 6 A, P _N = 7 kVA
	AX2513-B200 master module I _N = 3 A, P _N = 12 kVA
	AX2516-B200 master module I _N = 6 A, P _N = 12 kVA
	AX2523-B200 axes module I _N = 3 A
	AX2526-B200 axes module I _N = 6 A
Servomotors	AM2000 Synchronous Servomotors
	AM3000 Synchronous Servomotors
	AL2000 Linear Servomotors

PC FIELDBUS CARDS, SWITCHES

The intelligent interface generation

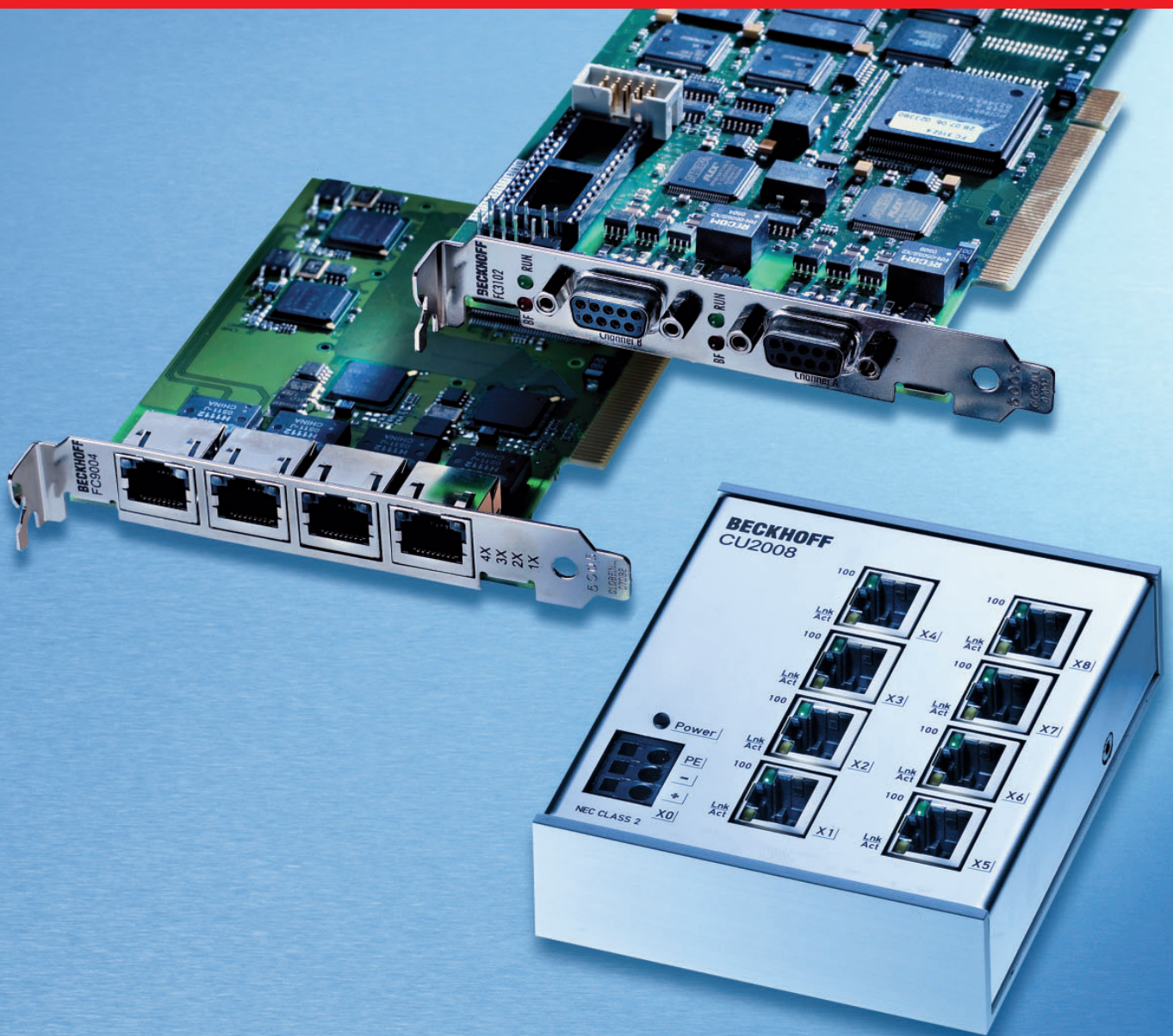

PC Fieldbus Cards with PCI interface and Ethernet Switches

Beckhoff completes the company's offer of fieldbus components with the PCI-based PC Fieldbus Cards for Lightbus, PROFIBUS, CANopen, DeviceNet, SERCOS interface and Ethernet. The cards have been particularly developed for fast controls and for real-time tasks such as drive position control, and can therefore be applied to a wide range of applications. To enable universal application, the interface cards are fitted with either one or two fieldbus channels. The Ethernet variant FC9004 contains four channels altogether.

Ethernet is a standard communication medium for automation technology. Beckhoff expands this segment with powerful PCI Ethernet cards and Ethernet Switches. The Ethernet components supplement the Beckhoff system solutions, for example for EtherCAT applications, but they can also be used wherever robust industrial technology is required, independent of the automation of IT applications.

Maximum performance from fieldbus to PCI bus

The power of the Fieldbus Cards can be most easily seen in combination with the TwinCAT software PLC and NC. But other applications also benefit from the intelligent PCI cards that handle the fieldbus protocol efficiently on their own processors. The process image is available in the DPRAM interface to the PC. Drivers for Windows NT/2000/XP and convenient configuration tools are included in the TwinCAT I/O software package. High-level language programs use the DLL, Visual Basic applications the ActiveX interface. Applications with OPC interface can access process data and parameters via an OPC server.

All cards are characterised by concentrated fieldbus know-how in the form of the following features:

- fast data exchange through short cycle times (e. g. Lightbus: to 100 µs)
- process data communication is either free running, synchronised, synchronised with delay or equidistant
- powerful parameter and diagnostics interfaces
- freely configurable bus management for every device

Consolidated fieldbus know-how

New Mini PCI cards for PROFIBUS, CANopen, DeviceNet, SERCOS interface and Ethernet enhance the Beckhoff PC Fieldbus Card range. Like the standard PCI cards from Beckhoff, the interfaces are optimised for fast controllers and real-time tasks.

The new generation of Beckhoff Industrial PCs, including the C69xx control cabinet PCs and the CP62xx/CP66xx Control Panel PCs, are extremely compact. With each device featuring two Ethernet ports, they represent high-performance Industrial PCs for Ethernet and EtherCAT-based control applications. The IPCs can optionally be extended with Mini PCI cards, or with fieldbus technology.

Ethernet Switches

The Beckhoff Ethernet Switches offer 8/16 RJ 45 Ethernet ports. Switches relay incoming Ethernet frames to the destination ports. In full duplex mode, they prevent collisions. They can be used universally in automation and office networks. User-friendly installation via integrated DIN rail adapter.

The switches meet the special requirements of real-time-capable industrial

Ethernet solutions through several outstanding features:

- optional broadcast filtering supports the integration of any Ethernet devices in real-time environments
- optional packet-based or port-based prioritisation (QoS, VLAN)

Further benefits underline the particular suitability for the application in industrial environments:

- compact design in stainless steel housing
- 10/100 Mbaud, half or full duplex, with automatic baud rate detection
- cross-over detection: automatic detection and correction of crossover and straight-through Ethernet cables
- clear LED field for quick diagnosis, 3 LEDs for each Ethernet port
- fast DIN rail mounting
- industrial design



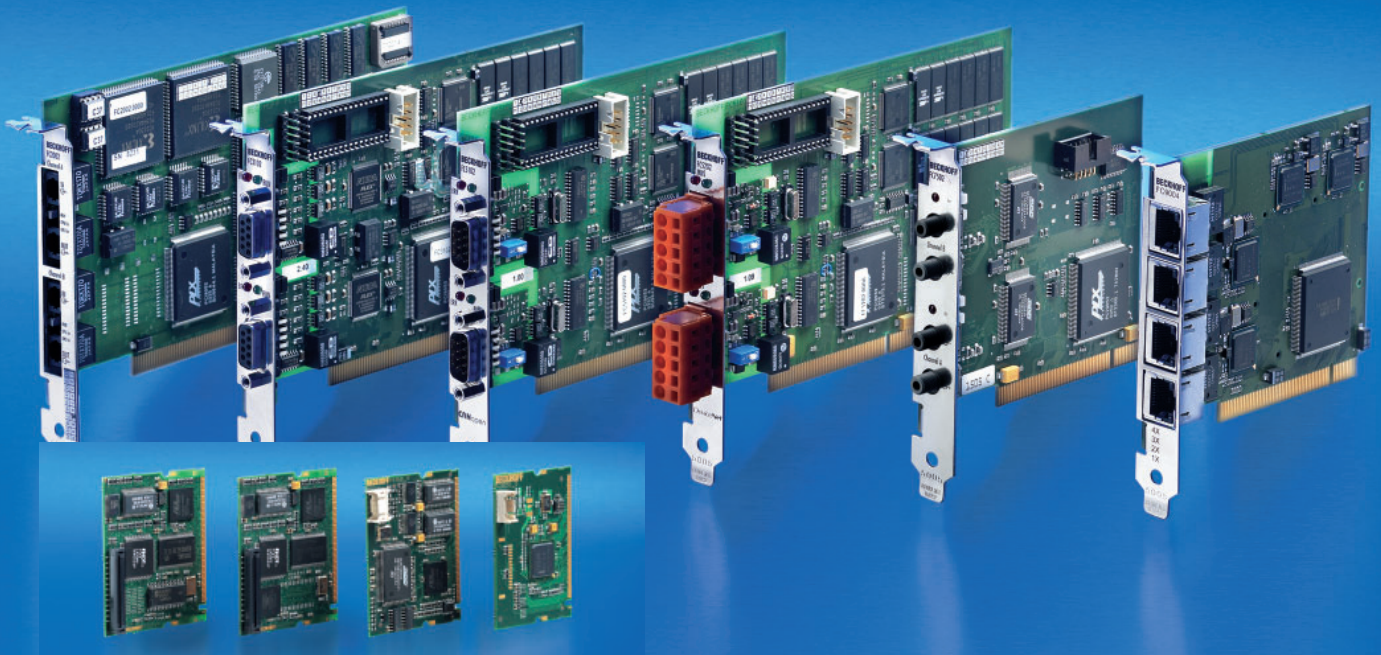

FCxxx | PC Fieldbus Cards

PC Fieldbus Cards			
Fieldbus	1-channel	2-channel	4-channel
LIGHTBUS	FC2001-0000 (PCI interface)	FC2002-0000 (PCI interface)	
PROFINET	FC3101-0000 (PCI interface)	FC3102-0000 (PCI interface)	
	FC3101-0002 (PCI interface) configuration with 32 kbytes NOVRAM	FC3102-0002 (PCI interface) configuration with 32 kbytes NOVRAM	
	FC3151-0000 (Mini PCI interface)		
	FC3151-0002 (Mini PCI interface) configuration with 128 kbytes NOVRAM		
CANopen	FC5101-0000 (PCI interface)	FC5102-0000 (PCI interface)	
	FC5101-0002 (PCI interface) configuration with 32 kbytes NOVRAM	FC5102-0002 (PCI interface) configuration with 32 kbytes NOVRAM	
	FC5151-0000 (Mini PCI interface)		
	FC5151-0002 (Mini PCI interface) configuration with 128 kbytes NOVRAM		
DeviceNet	FC5201-0000 (PCI interface)	FC5202-0000 (PCI interface)	
	FC5201-0002 (PCI interface) configuration with 32 kbytes NOVRAM	FC5202-0002 (PCI interface) configuration with 32 kbytes NOVRAM	
	FC5251-0000 (Mini PCI interface)		
	FC5251-0002 (Mini PCI interface) configuration with 128 kbytes NOVRAM		
SERCOS interface	FC7501-0000 (PCI interface)	FC7502-0000 (PCI interface)	
	FC7551-0000 (Mini PCI interface)		
	FC7551-0002 (Mini PCI interface) configuration with 128 kbytes NOVRAM		
Ethernet	FC9001-0000 (PCI interface)	FC9002-0000 (PCI interface)	FC9004-0000 (PCI interface)
	FC9051-0000 (Mini PCI interface)		
	FC9151-0000 (Mini PCI interface)		

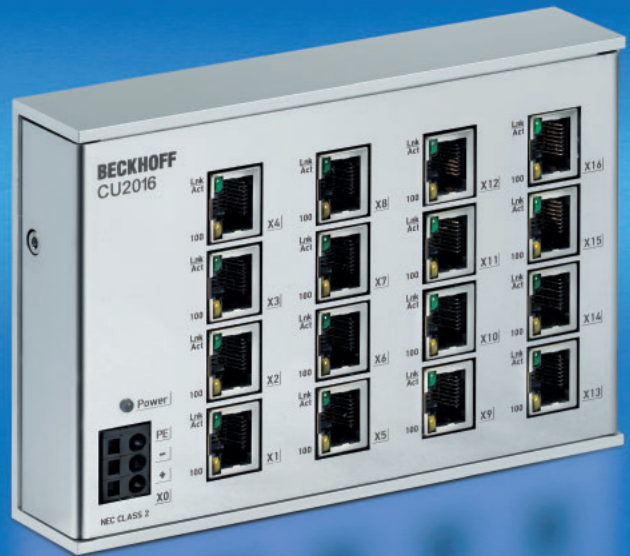

CU20xx | Ethernet Switches

Switches

Technical data	CU2008	CU2016
Bus system	all Ethernet (IEEE 802.3) based protocols, store-and-forward switching mode	all Ethernet (IEEE 802.3) based protocols, store-and-forward switching mode
Number of Ethernet ports	8	16
Ethernet interface	10BASE-T/100BASE-TX Ethernet with 8 x RJ 45	10BASE-T/100BASE-TX Ethernet with 16 x RJ 45
Cable length	up to 100 m twisted pair	up to 100 m twisted pair
Baud rate	10/100 Mbit/s, IEEE 802.3u auto-negotiation, half or full duplex at 10 and 100 Mbit/s possible, automatic settings	10/100 Mbit/s, IEEE 802.3u auto-negotiation, half or full duplex at 10 and 100 Mbit/s possible, automatic settings
Hardware diagnostics	2 LEDs per channel (link/activity, 10/100 Mbit)	2 LEDs per channel (link/activity, 10/100 Mbit)
Operating temperature	0 °C ... +55 °C	0 °C ... +55 °C
Dimensions (W x H x D)	approx. 85 mm x 100 mm x 30 mm	approx. 146 mm x 100 mm x 30 mm
Power supply	24 (18...30) V DC, 100 mA, 3-pin cage clamp® connection (+,-,PE)	24 (18...30) V DC, 150 mA, 3-pin cage clamp® connection (+,-,PE)



DRIVE TECHNOLOGY

The drive system for high dynamic positioning tasks

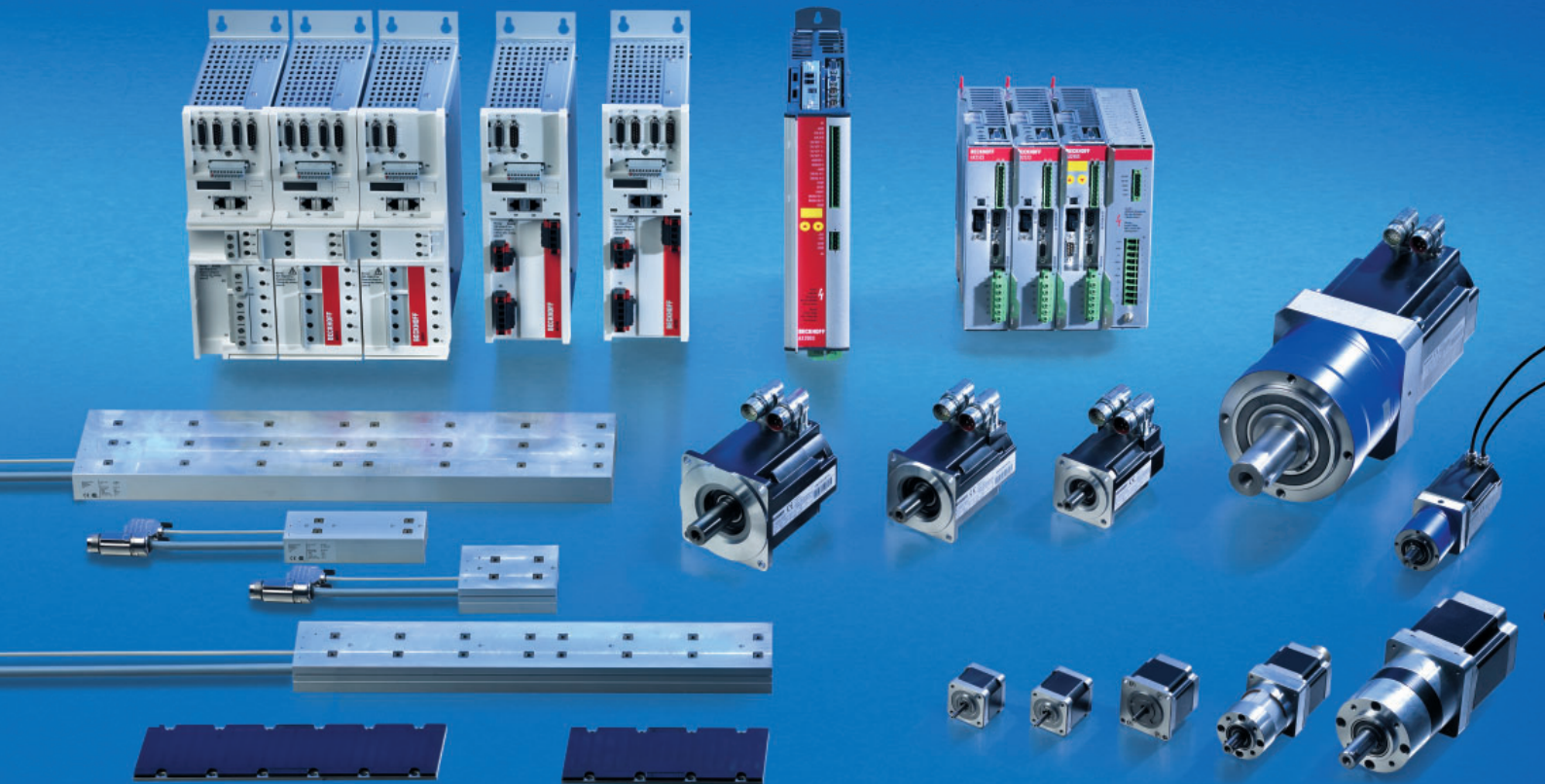

Beckhoff Drive Technology

In combination with the Motion Control solutions offered by the TwinCAT automation software, Beckhoff Drive Technology represents an advanced complete drive system. PC-based control technology from Beckhoff is ideally suited for single and multiple axis positioning tasks with highly dynamic requirements. The AX5000 Servo Drive series with high-performance EtherCAT system communication offers maximum performance and dynamics.

TwinCAT offers comprehensive NC and CNC functionalities. Associated PLC libraries and engineering tools round off the software solution.

The complete Drive Technology solution from Beckhoff consists of:

- Compact Servo Drives AX5000, AX2000, AX2500,
- Synchronous Servomotors AM2000, AM3000,
- Linear Servomotors AL2000, AL2400, AL2800, AL3800,
- Stepper Motors AS1000,
- and a comprehensive range of accessories.

Beckhoff's open control technology is consistently continued into the drive unit. Fieldbus standards such as EtherCAT, Ethernet, PROFIBUS, CANopen, DeviceNet, SERCOS interface or Lightbus enable the drives to be integrated into complex systems.

AX5000 – the new drive generation

The AX5000 Servo Drive product line from Beckhoff sets new standards in Drive Technology. The AX5000 series is available in single- or multi-channel form and is optimised in terms of function and cost-effectiveness. The integrated, fast control technology with a current control cycle of up to 31.25 µs supports fast and highly dynamic positioning tasks. EtherCAT as high-performance system communication enables ideal interfacing with PC-based control technology and supports coupling with other communication systems.

The AX51xx 1-channel Servo Drives are designed for rated motor currents up to 12 A (further variants up to 75 A are in preparation). The AX52xx 2-channel Servo Drive enables operation of two motors with identical or even with different capacity, up to a total current of 12 A. The multi-axis drives with variable motor output allocation optimise packaging density and the cost per drive channel.

The AX5000 is very flexible with regard to motor types: A wide range of motor sizes and types can be connected without additional measures. Examples include synchronous, linear, torque or asynchronous motors. The multi-feedback interface supports all common standards. Several AX5000 devices can be connected easily and quickly to form a multi-axis system using the "AX-Bridge" quick connection system.

AX5000 features:

- high-speed EtherCAT system communication
- 1- or 2-channel Servo Drive
 - optimised for multi-axis applications
 - variable motor output allocation in 2-channel drives
- active DC link and brake energy management
- variable motor interface with:
 - multi-feedback interface
 - flexible motor type selection
 - scalable, wide range motor current measurement
- high-speed capture inputs
- wide voltage range 100 ... 480 V AC ±10 % (class C3)
- integrated mains filter
- integration of safety functions (optional):
 - restart lock
 - TwinSAFE: intelligent safety functions for Motion Control
- compact design for simple control cabinet installation (300 mm depth)
- AX-Bridge – the quick connection system for power supply, DC link and control voltage
- variable cooling concept (fanless, forced cooling, cold plate)

Servo Drives AX2000/AX2500

The AX2000 and AX2500 series complement the compact Servo Drive segment with two types: The AX2000 series is a powerful variant designed for a nominal current of up to 20 A. The AX2500 series Servo Drives are modularly expandable and are optimised for applications where space is tight. The maximum nominal current is 6 A.

Servomotors AM2000, AM3000

The Synchronous Servomotors are brushless, three-phase motors meeting DIN 42950, and are equipped with permanent magnets in the rotor. This high quality neodymium magnetic material makes a significant contribution to the motors' exceptional dynamic properties. The AM2000 motors feature angled connectors (up to 90°) for the power supply and the feedback signals. The AM3000 features continuously rotatable connectors. Beckhoff offers resolver, encoder and power leads as ready-assembled accessories in different lengths.

Linear Servomotors ALxxxx

The three-phase Linear Servomotors from the AL2000, AL2400, AL2800 and AL3800 series complement the motor range. The linear motors can be used wherever the rotary design reaches mechanical limits during installation or where special drive characteristics in terms of dynamics, synchronism or acceleration are required.





AX51xx | Digital Compact Servo Drives

Technical data	AX5101	AX5103	AX5106	AX5112
Rated output current	1 x 1 A	1 x 3 A	1 x 6 A	1 x 12 A
Min. rated motor current at full current resolution	0.35 A	1 A	1 A	6 A
Rated supply voltage	1 x 100 ... 3 x 480 V AC ±10%, 50 ... 60 Hz	1 x 100 ... 3 x 480 V AC ±10%, 50 ... 60 Hz	1 x 100 ... 3 x 480 V AC ±10%, 50 ... 60 Hz	1 x 100 ... 3 x 480 V AC ±10%, 50 ... 60 Hz
DC link voltage	0 ... 790 V DC	0 ... 790 V DC	0 ... 790 V DC	0 ... 790 V DC
Peak output current ⁽¹⁾	3 A	9 A	13 A	26 A
Rated connected load for S1 operation	0.8 kVA	2.5 kVA	5 kVA	10 kVA
Continuous braking power ⁽²⁾	50 W	50 W	150 W	50 W
Max. braking power ⁽²⁾	2.8 kW	2.8 kW	2.8 kW	2.8 kW
System bus	EtherCAT	EtherCAT	EtherCAT	EtherCAT
Height without plugs	266 mm	266 mm	266 mm	266 mm
Width	92 mm	92 mm	92 mm	92 mm
Depth without plugs	233 mm	233 mm	233 mm	233 mm
Weight	4.0 kg	4.0 kg	5.0 kg	5.0 kg

⁽¹⁾ RMS for max. 7 seconds

⁽²⁾ internal brake resistor



AX52xx | Digital Compact Servo Drives

Technical data	AX5201	AX5203	AX5206
Rated output current	2 x 1 A	2 x 3 A	2 x 6 A
Min. rated motor current at full current resolution	0.35 A	1 A	1 A
Max. rated channel current at full current resolution	2 A	6 A	9 A
Rated supply voltage	1 x 100 ... 3 x 480 V AC \pm 10 %, 50 ... 60 Hz	1 x 100 ... 3 x 480 V AC \pm 10 %, 50 ... 60 Hz	1 x 100 ... 3 x 480 V AC \pm 10 %, 50 ... 60 Hz
DC link voltage	0 ... 790 V DC	0 ... 790 V DC	0 ... 790 V DC
Peak output current⁽¹⁾	2 x 3 A	2 x 9 A	2 x 13 A
Rated connected load for S1 operation	1.6 kVA	5 kVA	10 kVA
Continuous braking power⁽²⁾	50 W	150 W	50 W
Max. braking power⁽²⁾	2.8 kW	2.8 kW	2.8 kW
System bus	EtherCAT	EtherCAT	EtherCAT
Height without plugs	318 mm	318 mm	318 mm
Width	92 mm	92 mm	92 mm
Depth without plugs	266 mm	266 mm	266 mm
Weight	5.0 kg	6.0 kg	6.0 kg

⁽¹⁾ RMS for max. 7 seconds

⁽²⁾ internal brake resistor



AX20xx | Digital Compact Servo Drives

Technical data	AX2003	AX2006	AX2010	AX2020	AX2040	AX2070
Rated output current	3 A	6 A	10 A	20 A	40 A	70 A/80 A
Rated supply voltage	3x (230 ... 480) V AC ±10%, 50 ... 60 Hz	3x (230 ... 480) V AC ±10%, 50 ... 60 Hz	3x (230 ... 480) V AC ±10%, 50 ... 60 Hz	3x (230 ... 480) V AC ±10%, 50 ... 60 Hz	3x (230 ... 480) V AC ±10%, 50 ... 60 Hz	3x (230 ... 480) V AC ±10%, 50 ... 60 Hz
Rated installed load for S1 operation	2 kVA	4.2 kVA	7 kVA	14 kVA	30 kVA	50 kVA
Rated intermediate circuit DC voltage	(310–675) V DC	(310–675) V DC	(310–675) V DC	(310–675) V DC	(310–675) V DC	(310–675) V DC
Rated output current (rms value 3%)	3 A _{rms}	6 A _{rms}	10 A _{rms}	20 A _{rms}	40 A _{rms}	70 A _{rms} /80 A _{rms}
Peak output current (max. approx. 5 s 3%)	6 A _{rms}	12 A _{rms}	20 A _{rms}	40 A _{rms}	80 A _{rms}	140 A _{rms} /160 A _{rms}
Continuous output of regen circuit (RBint)	80 W	200 W	200 W	200 W	–	–
Continuous output of regen circuit (RBext) max.	250 W	750 W	750 W	750 W	6 kW	6 kW
Weight	4 kg	4 kg	5 kg	7.5 kg	19.5 kg	21 kg
Height without connectors	275 mm	275 mm	275 mm	275 mm	495 mm	495 mm
Width	70 mm	70 mm	70 mm	120 mm	250 mm	250 mm
Depth without connectors	265 mm	265 mm	265 mm	265 mm	300 mm	300 mm

Fieldbus-Connectivity	EtherCAT	LIGHTBUS	PROFIBUS	CANopen	DeviceNet	SERCOS interface	RS232 RS485	Ethernet
Interface AX2000	-B110	-B200	-B310	on-board	-B520	-B750	on-board	-B900



AX25xx | Digital Compact Servo Drives

Technical data	AX2503	AX2506	AX2513	AX2516	AX2523	AX2526
Function	master module	master module	master module	master module	axis module	axis module
Rated output current	3 A	6 A*	3 A	6 A*	3 A	6 A*
Rated supply voltage	1 x 115 ... 1/3 x 230 V AC ±10 %, 50 ... 60 Hz	1 x 115 ... 1/3 x 230 V AC ±10 %, 50 ... 60 Hz	3 x (230 ... 400) V AC ±10 %, 50 ... 60 Hz	3 x (230 ... 400) V AC ±10 %, 50 ... 60 Hz	–	–
Maximum installed power for S1 operation multi-axis systems	7 kVA	7 kVA	12 kVA	12 kVA	–	–
Rated DC-link voltage	(160 – 310) V DC	(160 – 310) V DC	(310 – 560) V DC	(310 – 560) V DC	(160 – 560) V DC	(160 – 560) V DC
Rated output current (rms value 3%)	3 A _{rms}	6 A _{rms} *	3 A _{rms}	6 A _{rms} *	3 A _{rms}	6 A _{rms} *
Peak output current (max. approx. 5 s 3%)	9 A _{rms}	12 A _{rms} *	9 A _{rms}	12 A _{rms} *	9 A _{rms}	12 A _{rms} *
Continuous output of regen circuit (RBint)	40 W	40 W	40 W	40 W	–	–
Height without connectors	230 mm	267 mm*	230 mm	267 mm*	230 mm	267 mm*
Width	100 mm	100 mm	100 mm	100 mm	50 mm	50 mm
Depth without connectors	240 mm	240 mm	240 mm	240 mm	240 mm	240 mm

* with attached fan

Fieldbus-Connectivity	LIGHTBUS	PROFIBUS	CANopen	DeviceNet	SERCOS interface	RS232 RS485	Ethernet
Interface AX2500	-B200	-B310	-B510	on request	-B750	on-board	-B900





AM2xxx | Synchronous Servomotors

AM2000-wxyz	Standstill torque	Standstill current	Rated speed at rated supply voltage		Rotor moment of inertia	Weight
			230 V AC	400/480 V AC		
AM217S-0000	0.1 Nm	0.6 A	6000 min ⁻¹	–	0.06 kg cm ²	0.7 kg
AM217M-0000	0.2 Nm	0.93 A	6000 min ⁻¹	–	0.12 kg cm ²	0.8 kg
AM217S-2000	0.1 Nm	0.6 A	6000 min ⁻¹	–	0.06 kg cm ²	0.7 kg
AM217M-2000	0.2 Nm	0.93 A	6000 min ⁻¹	–	0.12 kg cm ²	0.8 kg
AM227M-0000	0.32 Nm	0.8 A	–	4000 min ⁻¹	0.08 kg cm ²	1.1 kg
AM227M-0001	0.32 Nm	0.8 A	–	4000 min ⁻¹	0.15 kg cm ²	1.4 kg
AM227L-0000	0.8 Nm	0.83 A	–	4500 min ⁻¹	0.13 kg cm ²	1.5 kg
AM227L-0001	0.8 Nm	0.83 A	–	4500 min ⁻¹	0.2 kg cm ²	1.8 kg
AM237S-0000	0.5 Nm	1 A	–	6000 min ⁻¹	0.45 kg cm ²	1.9 kg
AM237S-0001	0.5 Nm	1 A	–	6000 min ⁻¹	0.83 kg cm ²	2.3 kg
AM237M-0000	1 Nm	1.6 A	–	6000 min ⁻¹	0.7 kg cm ²	2.3 kg
AM237M-0001	1 Nm	1.6 A	–	6000 min ⁻¹	1.08 kg cm ²	2.7 kg
AM237L-0000	1.5 Nm	1.6 A	–	4000 min ⁻¹	1 kg cm ²	2.9 kg
AM237L-0001	1.5 Nm	1.6 A	–	4000 min ⁻¹	1.38 kg cm ²	3.3 kg
AM247M-0000	2.5 Nm	1.78 A	–	3000 min ⁻¹	1.4 kg cm ²	3.3 kg
AM247M-0001	2.5 Nm	1.78 A	–	3000 min ⁻¹	1.78 kg cm ²	3.7 kg
AM247L-0000	3 Nm	2.3 A	–	3000 min ⁻¹	1.6 kg cm ²	3.5 kg
AM247L-0001	3 Nm	2.3 A	–	3000 min ⁻¹	1.98 kg cm ²	3.9 kg
AM257K-0000	2.6 Nm	1.9 A	–	3000 min ⁻¹	2.1 kg cm ²	4.5 kg
AM257K-0001	2.6 Nm	1.9 A	–	3000 min ⁻¹	3.16 kg cm ²	5.25 kg

AM2000-wxyz	Standstill	Standstill	Rated speed at rated supply voltage		Rotor moment of inertia	Weight
	torque	current	230 V AC	400/480 V AC		
AM257S-0000	4.6 Nm	2.8 A	–	3000 min ⁻¹	3.1 kg cm ²	5.7 kg
AM257S-0001	4.6 Nm	2.8 A	–	3000 min ⁻¹	4.16 kg cm ²	6.3 kg
AM257M-0000	8 Nm	4.3 A	–	3000 min ⁻¹	4.5 kg cm ²	7.6 kg
AM257M-0001	8 Nm	4.3 A	–	3000 min ⁻¹	5.56 kg cm ²	8.2 kg
AM257L-0000	9.5 Nm	6.1 A	–	3000 min ⁻¹	6.5 kg cm ²	8.7 kg
AM257L-0001	9.5 Nm	6.1 A	–	3000 min ⁻¹	7.56 kg cm ²	9.45 kg
AM277K-0000	11 Nm	6 A	–	3000 min ⁻¹	12 kg cm ²	9.8 kg
AM277K-0001	11 Nm	6 A	–	3000 min ⁻¹	15.6 kg cm ²	11.3 kg
AM277S-0000	17 Nm	10 A	–	3000 min ⁻¹	18 kg cm ²	14 kg
AM277S-0001	17 Nm	10 A	–	3000 min ⁻¹	21.6 kg cm ²	15.5 kg
AM277M-0000	22 Nm	13.7 A	–	3000 min ⁻¹	13.1 kg cm ²	17 kg
AM277M-0001	22 Nm	13.7 A	–	3000 min ⁻¹	16.7 kg cm ²	18.5 kg
AM297K-0000	26 Nm	16 A	–	3000 min ⁻¹	82 kg cm ²	28 kg
AM297K-0001	26 Nm	16 A	–	3000 min ⁻¹	91.5 kg cm ²	31.3 kg
AM297S-0000	32 Nm	20 A	–	3000 min ⁻¹	104 kg cm ²	32.5 kg
AM297S-0001	32 Nm	20 A	–	3000 min ⁻¹	113.5 kg cm ²	35.8 kg
AM297M-0000	40 Nm	23.4 A	–	3000 min ⁻¹	139.4 kg cm ²	40 kg
AM297M-0001	40 Nm	23.4 A	–	3000 min ⁻¹	148.9 kg cm ²	43.3 kg

Option w = 0: smooth shaft

w = 1: shaft with groove and feather key according to DIN 6885, w = 2: connection cable with plug (only for AM217x)

Option x = 0: standard winding

x = 1: special winding

Option y = 0: resolver, 2-pin

y = 1: single-turn absolute encoder, Heidenhain EnDAT

absolute position within one revolution, electronic identification plate

AM227x: 512 sine periods per revolution

AM237x...AM297x: 2048 sine periods per revolution

y = 2: multi-turn absolute encoder, Heidenhain EnDAT

absolute position within 4096 revolutions, electronic identification plate

AM227x: 512 sine periods per revolution

AM237x...AM297x: 2048 sine periods per revolution

Option z = 0: without stopping brake

z = 1: with stopping brake

special flange, special shaft and other accessories on request



AM30xx | Synchronous Servomotors

AM30uv-wxyz	Stand- still torque	Stand- still current	Rated speed at rated supply voltage			Rotor moment of inertia	Weight	Stores type	
			230 V AC	400 V AC	480 V AC			Resol- ver	BiSS SingleTurn
AM3011-wB00	0.18 Nm	1.16 A	8000 min ⁻¹	–	–	0.017 kg cm ²	0.35 kg		
AM3012-wC00	0.31 Nm	1.51 A	8000 min ⁻¹	–	–	0.031 kg cm ²	0.49 kg	L	
AM3013-wC00	0.41 Nm	1.48 A	8000 min ⁻¹	–	–	0.045 kg cm ²	0.63 kg		
AM3021-wCyz	0.48 Nm	1.58 A	8000 min ⁻¹	8000 min ⁻¹	8000 min ⁻¹	0.107 kg cm ²	0.82 kg	L	L
AM3022-wCyz	0.84 Nm	1.39 A	3500 min ⁻¹	8000 min ⁻¹	8000 min ⁻¹	0.161 kg cm ²	1.10 kg	L	L
AM3023-wCyz	1.13 Nm	1.41 A	2500 min ⁻¹	5500 min ⁻¹	7000 min ⁻¹	0.216 kg cm ²	1.38 kg	L	L
AM3023-wDyz	1.16 Nm	2.19 A	5000 min ⁻¹	8000 min ⁻¹	8000 min ⁻¹	0.216 kg cm ²	1.38 kg		
AM3024-wCyz	1.38 Nm	1.42 A	2000 min ⁻¹	4500 min ⁻¹	5500 min ⁻¹	0.270 kg cm ²	1.66 kg		
AM3024-wDyz	1.41 Nm	2.21 A	4000 min ⁻¹	8000 min ⁻¹	8000 min ⁻¹	0.270 kg cm ²	1.66 kg		
AM3031-wCyz	1.15 Nm	1.37 A	2500 min ⁻¹	5000 min ⁻¹	6000 min ⁻¹	0.330 kg cm ²	1.55 kg	L	L
AM3031-wEyz	1.20 Nm	2.99 A	6000 min ⁻¹	6000 min ⁻¹	6000 min ⁻¹	0.330 kg cm ²	1.55 kg		L
AM3032-wCyz	2.00 Nm	1.44 A	1500 min ⁻¹	3000 min ⁻¹	3500 min ⁻¹	0.590 kg cm ²	2.23 kg	L	L
AM3032-wDyz	2.04 Nm	2.23 A	2500 min ⁻¹	5500 min ⁻¹	6000 min ⁻¹	0.590 kg cm ²	2.23 kg	L	L
AM3033-wCyz	2.71 Nm	1.47 A	1000 min ⁻¹	2000 min ⁻¹	2500 min ⁻¹	0.850 kg cm ²	2.90 kg		
AM3033-wEyz	2.79 Nm	2.58 A	2000 min ⁻¹	4500 min ⁻¹	5000 min ⁻¹	0.850 kg cm ²	2.90 kg	L	L
AM3041-wCyz	1.95 Nm	1.46 A	1200 min ⁻¹	3000 min ⁻¹	3500 min ⁻¹	0.810 kg cm ²	2.44 kg	L	L
AM3041-wEyz	2.02 Nm	2.85 A	3000 min ⁻¹	6000 min ⁻¹	6000 min ⁻¹	0.810 kg cm ²	2.44 kg		
AM3042-wEyz	3.42 Nm	2.74 A	1800 min ⁻¹	3500 min ⁻¹	4000 min ⁻¹	1.450 kg cm ²	3.39 kg		
AM3042-wGyz	3.53 Nm	4.80 A	3500 min ⁻¹	6000 min ⁻¹	6000 min ⁻¹	1.450 kg cm ²	3.39 kg	L	L
AM3043-wEyz	4.70 Nm	2.76 A	1500 min ⁻¹	2500 min ⁻¹	3000 min ⁻¹	2.090 kg cm ²	4.35 kg		
AM3043-wGyz	4.80 Nm	4.87 A	2500 min ⁻¹	5000 min ⁻¹	6000 min ⁻¹	2.090 kg cm ²	4.35 kg	L	L
AM3044-wEyz	5.76 Nm	2.90 A	1200 min ⁻¹	2000 min ⁻¹	2500 min ⁻¹	2.730 kg cm ²	5.30 kg		
AM3044-wGyz	5.88 Nm	5.00 A	2000 min ⁻¹	4000 min ⁻¹	5000 min ⁻¹	2.730 kg cm ²	5.30 kg	L	L
AM3044-wJyz	6.00 Nm	8.80 A	4000 min ⁻¹	6000 min ⁻¹	6000 min ⁻¹	2.730 kg cm ²	5.30 kg	L	L
AM3051-wEyz	4.70 Nm	2.75 A	1200 min ⁻¹	2500 min ⁻¹	3000 min ⁻¹	3.420 kg cm ²	4.20 kg	L	
AM3051-wGyz	4.75 Nm	4.84 A	2500 min ⁻¹	5000 min ⁻¹	6000 min ⁻¹	3.420 kg cm ²	4.20 kg	L	L
AM3052-wGyz	8.43 Nm	4.72 A	1500 min ⁻¹	2500 min ⁻¹	3000 min ⁻¹	6.220 kg cm ²	5.80 kg	L	
AM3052-wKyz	8.60 Nm	9.30 A	3000 min ⁻¹	5500 min ⁻¹	6000 min ⁻¹	6.220 kg cm ²	5.80 kg	L	L
AM3053-wGyz	11.37 Nm	4.77 A	1000 min ⁻¹	2000 min ⁻¹	2400 min ⁻¹	9.120 kg cm ²	7.40 kg		
AM3053-wKyz	11.60 Nm	9.40 A	2000 min ⁻¹	4000 min ⁻¹	4500 min ⁻¹	9.120 kg cm ²	7.40 kg	L	L

AM30uv-wxyz	Stand- still torque	Stand- still current	Rated speed at rated supply voltage			Rotor moment of inertia	Weight	Stores type	
			230 V AC	400 V AC	480 V AC			Resol- ver	BiSS SingleTurn
AM3054-wKyz	14.40 Nm	9.70 A	1800 min ⁻¹	3500 min ⁻¹	4000 min ⁻¹	11.92 kg cm ²	9.00 kg		
AM3062-wKyz	12.20 Nm	9.60 A	2000 min ⁻¹	3500 min ⁻¹	4500 min ⁻¹	16.90 kg cm ²	8.90 kg	L	L
AM3062-wMyz	12.20 Nm	13.40 A	3000 min ⁻¹	6000 min ⁻¹	6000 min ⁻¹	16.90 kg cm ²	8.90 kg		
AM3063-wKyz	16.80 Nm	9.90 A	1500 min ⁻¹	3000 min ⁻¹	3500 min ⁻¹	24.20 kg cm ²	11.1 kg		
AM3063-wMyz	17.00 Nm	13.80 A	2000 min ⁻¹	4000 min ⁻¹	4500 min ⁻¹	24.20 kg cm ²	11.1 kg		
AM3063-wNyz	17.00 Nm	17.40 A	3000 min ⁻¹	5000 min ⁻¹	6000 min ⁻¹	24.20 kg cm ²	11.1 kg		
AM3064-wKyz	20.80 Nm	9.20 A	1200 min ⁻¹	2000 min ⁻¹	2500 min ⁻¹	31.60 kg cm ²	13.3 kg		
AM3064-wLyz	21.00 Nm	12.80 A	1500 min ⁻¹	3000 min ⁻¹	3500 min ⁻¹	31.60 kg cm ²	13.3 kg		L
AM3064-wPyz	20.40 Nm	18.60 A	2500 min ⁻¹	4500 min ⁻¹	5500 min ⁻¹	31.60 kg cm ²	13.3 kg		L
AM3065-wKyz	24.80 Nm	9.80 A	1000 min ⁻¹	2000 min ⁻¹	2200 min ⁻¹	40.00 kg cm ²	15.4 kg		
AM3065-wMyz	25.00 Nm	13.60 A	1500 min ⁻¹	2500 min ⁻¹	3000 min ⁻¹	40.00 kg cm ²	15.4 kg		
AM3065-wNyz	24.30 Nm	17.80 A	2000 min ⁻¹	3500 min ⁻¹	4000 min ⁻¹	40.00 kg cm ²	15.4 kg	L	L
AM3072-wKyz	29.70 Nm	9.30 A	–	1500 min ⁻¹	1800 min ⁻¹	64.50 kg cm ²	19.7 kg		
AM3072-wMyz	30.00 Nm	13.00 A	–	2000 min ⁻¹	2500 min ⁻¹	64.50 kg cm ²	19.7 kg		
AM3072-wPyz	29.40 Nm	18.70 A	1800 min ⁻¹	3000 min ⁻¹	3500 min ⁻¹	64.50 kg cm ²	19.7 kg		L
AM3073-wMyz	42.00 Nm	13.60 A	–	1500 min ⁻¹	1800 min ⁻¹	92.10 kg cm ²	26.7 kg		
AM3073-wPyz	41.60 Nm	19.50 A	1300 min ⁻¹	2400 min ⁻¹	2800 min ⁻¹	92.10 kg cm ²	26.7 kg		
AM3074-wLyz	53.00 Nm	12.90 A	–	1200 min ⁻¹	1400 min ⁻¹	119.7 kg cm ²	33.6 kg		
AM3074-wPyz	52.50 Nm	18.50 A	–	1800 min ⁻¹	2000 min ⁻¹	119.7 kg cm ²	33.6 kg		L

u: flange code

v: motor length

Option w = 0: smooth shaft

w = 1: shaft with groove and feather key according to DIN 6885

Option x = winding code A ... P

Option y = 0: resolver, 2-pin

y = 1: single-turn absolute encoder, Heidenhain EnDAT

absolute position within one revolution, electronic identification plate

AM301x...AM304x: 512 sine periods per revolution

AM305x...AM307x: 2048 sine periods per revolution

y = 2: multi-turn absolute encoder, Heidenhain EnDAT

absolute position within 4096 revolutions, electronic identification plate

AM301x...AM304x: 512 sine periods per revolution

AM305x...AM307x: 2048 sine periods per revolution

y = 3: single-turn absolute encoder, Hengstler BiSS

absolute position within one revolution,

electronic identification plate, 2048 sine periods per revolution

y = 4: multi-turn absolute encoder, Hengstler BiSS

absolute position within 4096 revolutions,

electronic identification plate, 2048 sine periods per revolution

Option z = 0: without stopping brake

z = 1: with stopping brake

special flange, special shaft and other accessories on request



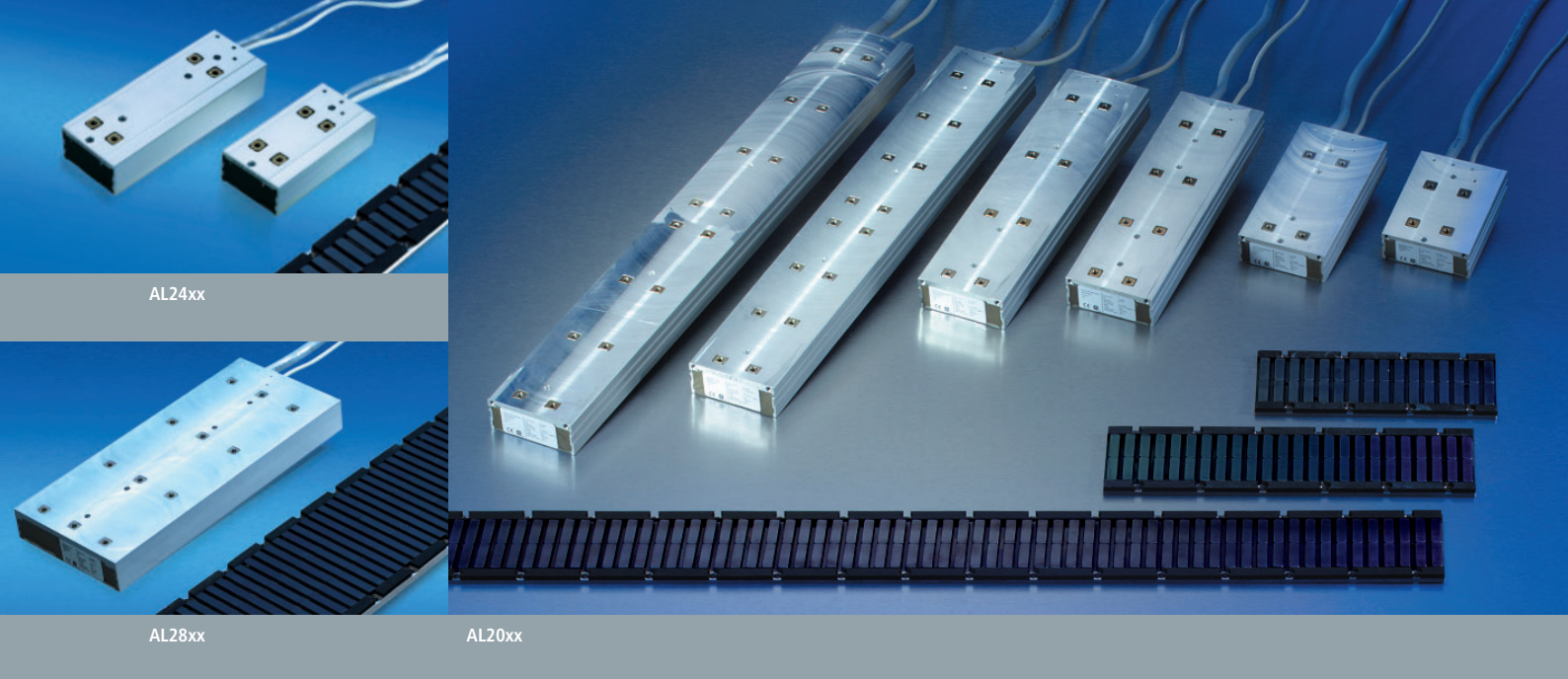

AL24xx

AL28xx

AL20xx

AL20xx, AL24xx, AL28xx | Linear Servomotors, iron core

AL20xx	Peak force	Peak current	Thermal	Weight	Motor length	Motor width
	3 sec. (F_{peak})	(I_{peak})	resistance (R_{th})	of the coil (M_p)		
AL2003 (primary sec.)	225 N	5 A	0.96 °C/W	0.9 kg	98 mm	77 mm
AL2006 (primary sec.) N S	450 N	5 A 10 A	0.48 °C/W	1.5 kg	146 mm	77 mm
AL2012 (primary sec.) N S	900 N	10 A 20 A	0.24 °C/W	2.6 kg	244 mm	77 mm
AL2015 (primary sec.) N S	1125 N	10 A 25 A	0.20 °C/W	3.2 kg	290 mm	77 mm
AL2024 (primary sec.) N S	1800 N	20 A 40 A	0.12 °C/W	5.1 kg	468 mm	77 mm
AL2030 (primary sec.) N S	2250 N	20 A 50 A	0.10 °C/W	6.3 kg	562 mm	77 mm

AL2110 (secondary section)	magnetic assembly 192 mm (magnetic path width 80 mm)
AL2120 (secondary section)	magnetic assembly 288 mm (magnetic path width 80 mm)

AL24xx	Peak force	Peak current	Thermal	Weight	Motor length	Motor width
	3 sec. (F_{peak})	(I_{peak})	resistance (R_{th})	of the coil (M_p)		
AL2403 (primary sec.)	120 N	3.9 A	1.4 °C/W	0.55 kg	93 mm	51 mm
AL2406 (primary sec.)	240 N	7.9 A	0.7 °C/W	0.9 kg	143 mm	51 mm

AL2510 (secondary section)	magnetic assembly 96 mm (magnetic path width 50 mm)
AL2520 (secondary section)	magnetic assembly 144 mm (magnetic path width 50 mm)
AL2530 (secondary section)	magnetic assembly 384 mm (magnetic path width 50 mm)

AL28xx	Peak force	Peak current	Thermal	Weight	Motor length	Motor width
	3 sec. (F_{peak})	(I_{peak})	resistance (R_{th})	of the coil (M_p)		
AL2815 (primary sec.) N S	2250 N	13 A 33 A	0.13 °C/W	6 kg	290 mm	130 mm
AL2830 (primary sec.) N S	4500 N	26 A 66 A	0.065 °C/W	12 kg	568 mm	130 mm
AL2845 (primary sec.) N S	6750 N	39 A 99 A	0.043 °C/W	19 kg	847 mm	130 mm

AL2910 (secondary section)	magnetic assembly 192 mm (magnetic path width 130 mm)
AL2920 (secondary section)	magnetic assembly 288 mm (magnetic path width 130 mm)

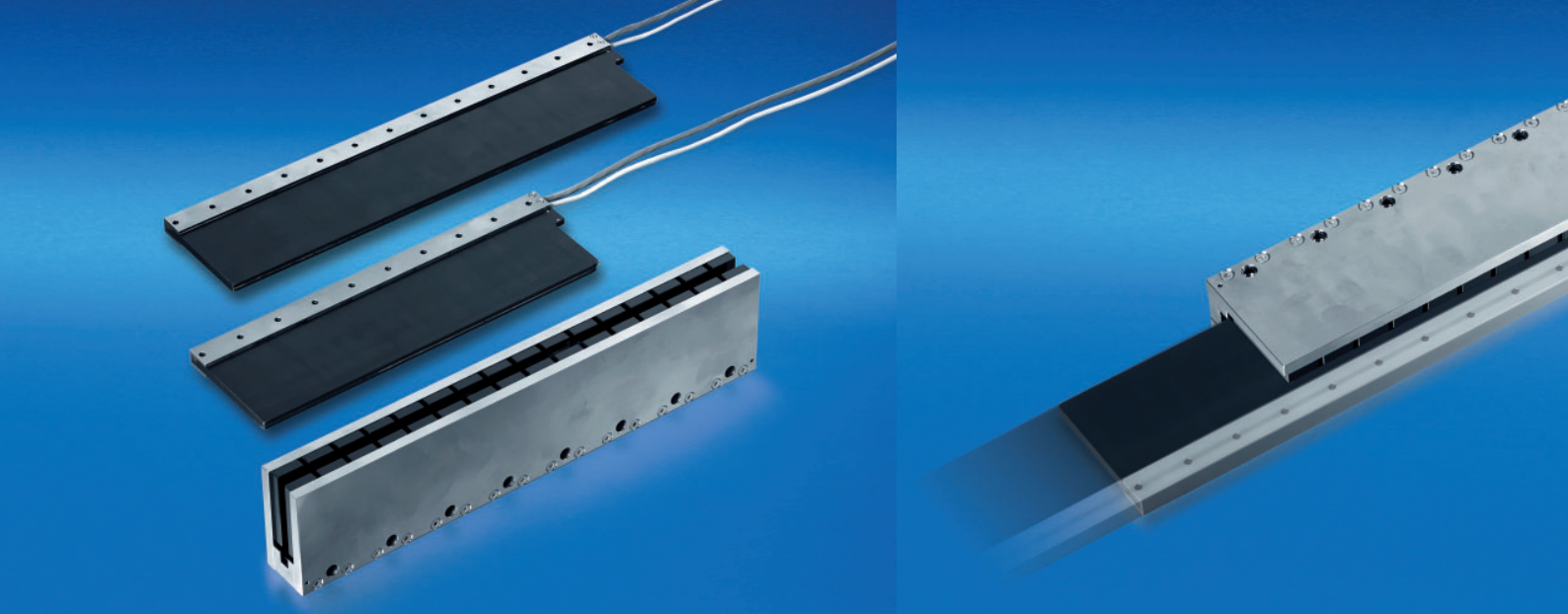

AL38xx

AL38xx | Linear Servomotors, ironless

AL38xx	Peak force	Peak current	Thermal	Weight	Motor length	Motor width
	3 sec. (F_{peak})	(I_{peak})	resistance (R_{th})	of the coil (M_p)		
AL3803 (primary sec.) N S	700 N	5.6 A 13.9 A	1.04 °C/W	1.5 kg	134 mm	15 mm
AL3806 (primary sec.) N S	1400 N	11.3 A 28 A	0.52 °C/W	2.6 kg	248 mm	15 mm
AL3809 (primary sec.) N S	2100 N	16.9 A 42 A	0.35 °C/W	3.2 kg	362 mm	15 mm
AL3812 (primary sec.) N S	2800 N	22.6 A 56 A	0.26 °C/W	5.1 kg	476 mm	15 mm
AL3818 (primary sec.) N	4200 N	34 A	0.17 °C/W	6.3 kg	704 mm	15 mm

AL3910 (secondary section)	magnet yoke 114 mm (magnet yoke width 48 mm)
AL3920 (secondary section)	magnet yoke 171 mm (magnet yoke width 48 mm)
AL3930 (secondary section)	magnet yoke 456 mm (magnet yoke width 48 mm)

TWINCAT®

PLC and Motion Control on the PC



The Windows Control and Automation Technology

The TwinCAT Software System turns any compatible PC into a real-time controller with a multi-PLC system and NC/CNC axis control. At the same time, TwinCAT integrates the programming environment for all Beckhoff controllers: from high-end Industrial PC control to embedded controller.

TwinCAT replaces conventional PLC and NC/CNC controllers as well as operating devices with:

- open, compatible PC hardware
- embedded IEC 61131-3 software PLC, software NC and software CNC in Windows NT/2000/XP, NT/XP Embedded, CE
- programming and run-time systems optionally together on one PC or separated
- connection to all common fieldbuses
- PC interfaces are supported
- data communication with user interfaces and other programs by means of open Microsoft standards (OPC, ActiveX, DLL, etc.)

TwinCAT architecture

The TwinCAT system consists of run-time systems that execute control programs in real-time and the development environments for programming, diagnostics and system configuration. Any Windows programs, for instance visualisation programs or Office programs, can access TwinCAT data via Microsoft interfaces or can execute commands.

TwinCAT PLC – the central pillar of automation software

Conceived as a pure software PLC, TwinCAT PLC allows up to four virtual “PLC CPUs”, each running up to four user tasks, on one PC. The PLC program can be written in one or more of the languages provided for in the IEC 61131-3 standard:

- IL (Instruction List),
- LD (Ladder Diagram),
- FBD/CFC (Function Block Diagram),
- SFC (Sequential Function Chart) and
- ST (Structured Text).

TwinCAT PLC running under the Windows NT/2000/XP operating systems includes both the programming environment and the run-time system, so that an additional programming device is not required. Under the CE operating system and the embedded operating systems for the series BX and BC controllers, only

TwinCAT PLC run-time is available. Program modifications are implemented via network-capable powerful communication with the run-time system. Programming can be done

- locally,
- via TCP/IP or
- via the fieldbus (BXxxxx and BCxxxx).

TwinCAT NC – Motion Control on the PC

A software NC consists of:

- positioning (set value generation and position control)
- integrated PLC with NC interface
- operating programs for commissioning purposes
- I/O connection for axes via fieldbus

With TwinCAT NC, the position controller is calculated on the PC processor as standard. It exchanges data cyclically with drives and measurement systems via the fieldbus.

TwinCAT NC I – axis interpolation in 3 dimensions



TwinCAT NC I (interpolation) is the NC system for linear and circular interpolated path movements of axis groups each involving two or three drives.



The system includes interpreter, set value generation and position controller. PLC functionality is integrated, as is the connection of the axes with the fieldbus.

TwinCAT CNC – the software CNC for toughest requirements

TwinCAT CNC expanded TwinCAT NC I with classic CNC features: Up to 32 interpolating axes and comprehensive coordinate and kinematic transformations are possible. Parts programming is carried out according to DIN 66025 using high-level language extensions. TwinCAT CNC can operate with up to 64 axes or 32 path axes and controlled spindles that can be distributed across up to 10 CNC channels. In a CNC channel, up to 32 axes can be interpolated simultaneously, enabling even the most difficult motion tasks to be solved. Apart from the classic linear, circular and helical interpolations, TwinCAT CNC offers convenient spline interpolation, optionally based on Akima or B-splines. Real-time transformations enable complex machine kinematics to be realised without problem.

PRODUCT OVERVIEW TWINCAT

Software PLC	
 TwinCAT PLC	
PC hardware	standard PC/IPC hardware, no extras
Operating systems	Windows NT/2000/XP, NT/XP Embedded, CE
Real-time	Beckhoff real-time kernel
I/O system	EtherCAT, Lightbus, PROFIBUS DP/MC, Interbus, CANopen, DeviceNet, SERCOS, Ethernet and PC hardware
Run-time system	4 multi-tasking PLCs each with 4 tasks in each PLC run-time system, development and run-time systems on one PC or separately (CE: only run-time)
Memory	process image size, flags area, program size, POU size, number of variables only limited by the size of the user memory (max. 2 GB with NT/2000/XP)
Cycle time	adjustable from 50 µs
Link-time	1 µs (Pentium® 4 2.8 GHz) for 1,000 PLC commands
Programming	IEC 61131-3: IL, FBD, LD, SFC, ST, powerful library management, convenient debugging
 TwinCAT PLC Libraries	
Libraries	<ul style="list-style-type: none"> TwinCAT PLC Controller Toolbox TwinCAT PLC Temperature Controller TwinCAT PLC Hydraulic Positioning TwinCAT PLC Modbus RTU TwinCAT PLC Serial Communication TwinCAT PLC Building Automation TwinCAT PLC IEC 60870-5-101/4

Software NC PTP	
 TwinCAT NC PTP	
TwinCAT PLC	inclusive
PC hardware	standard PC/IPC hardware, no extras
Operating systems	Windows NT/2000/XP, NT/XP Embedded, CE
Real-time	Beckhoff real-time kernel
I/O system	EtherCAT, Lightbus, PROFIBUS DP/MC, Interbus, CANopen, DeviceNet, SERCOS, Ethernet and PC hardware
Programming	performed using function blocks for TwinCAT PLC according to IEC 61131-3 (standardised PLCopen Motion Control libraries), convenient axis commissioning menus in the System Manager
Run-time system	NC point-to-point including TwinCAT PLC
Number of axes	up to 255
Axis types	electrical and hydraulic servo drives, frequency converter drives, stepper motor drives, switched drives (fast/crawl axes)
Cycle time	50 µs upwards, typically 1 ms (selectable)
Axis functions	standard axis functions: start/stop/reset/reference, speed override, special functions: master/slave cascading, cam plates, electronic gearings, online distance compensation of segments, "flying saw"
 TwinCAT NC PTP Libraries	
Libraries	<ul style="list-style-type: none"> TwinCAT NC Camming TwinCAT NC FIFO Axes TwinCAT NC Flying Saw TwinCAT PLC Remote Synchronisation

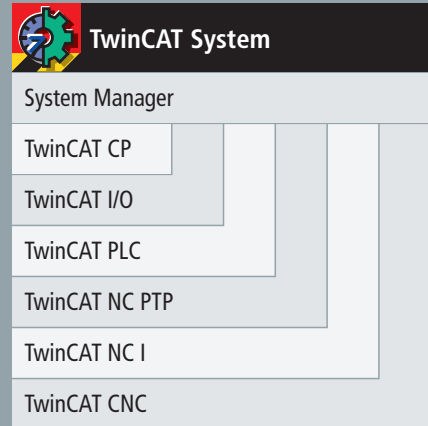

Software NC I

TwinCAT NC I	
TwinCAT PLC	inclusive
TwinCAT NC PTP	inclusive
PC hardware	standard PC/IPC hardware, no extras
Operating systems	Windows NT/2000/XP, NT/XP Embedded, CE
Real-time	Beckhoff real-time kernel
I/O system	EtherCAT, Lightbus, PROFIBUS DP/MC, Interbus, CANopen, DeviceNet, SERCOS, Ethernet and PC hardware
Programming	DIN 66025 programs for NC interpolation, access via function blocks from TwinCAT PLC according to IEC 61131-3
Run-time system	NC interpolation, including TwinCAT NC PTP and PLC
Number of axes	max. 3 axes and up to 5 auxiliary axes per group, 1 group per channel, max. 31 channels
Axis types	electrical servo axes, stepper motor drives
Interpreter functions	subroutines and jumps, programmable loops, zeroshifts, tool compensations, M and H functions
Geometries	straight lines and circular paths in 3D space, circular paths in all main planes, helices with base circles in all main planes
Axis functions	online reconfiguration of axes in groups, path override, slave coupling to path axes, auxiliary axes

Software CNC

TwinCAT CNC	
TwinCAT PLC	inclusive
TwinCAT NC PTP	inclusive
TwinCAT NC I	inclusive
PC hardware	standard PC/IPC hardware, no extras
Operating systems	Windows NT/2000/XP, Windows NT/XP Embedded
Real-time	Beckhoff real-time kernel
I/O system	EtherCAT, Lightbus, PROFIBUS DP/MC, Interbus, CANopen, DeviceNet, SERCOS, Ethernet and PC hardware
Programming	DIN 66025 programming language with high-level language extensions, mathematical functions, programming of parameters/variables, user macros, subroutine techniques, spindle and help functions, tool functions, zero offset shifts
Run-time system	CNC, including TwinCAT NC I, NC PTP, PLC
Number of axes/spindles	8 path axes/6 controlled spindles, max. of 64 axes/12 controlled spindles (optional)
Axis types	electrical servo-axes, analog/encoder interface via fieldbus, digital interface via fieldbus (EtherCAT, Lightbus, PROFIBUS MC, SERCOS)
Geometries	linear, circular, helical interpolation in the main planes and freely definable planes, 8 interpolating path axes per channel, look-ahead function
Axis functions	coupling and gantry axis function, override, axis error and sag compensation, measuring functions
Operation	automatic operation, manual operation (jog/ inching), single block operation, referencing, block search, handwheel operation (motion/ superposition)

TwinCAT CNC Options

Options	TwinCAT CNC Axes Pack
	TwinCAT CNC Channel Pack
	TwinCAT CNC Transformation
	TwinCAT CNC Spline Interpolation

PRODUCT OVERVIEW TWINCAT

TwinCAT Level



TwinCAT I/O

PC hardware	standard PC/IPC hardware, no extras
Operating systems	Windows NT/2000/XP, NT/XP Embedded, CE (only run-time)
Real-time	Beckhoff real-time kernel

Multi-purpose I/O interface for all common fieldbus systems, PC Fieldbus Cards and interfaces with integrated real-time driver



TwinCAT CP

PC hardware	standard PC/IPC hardware, no extras
Operating systems	Windows NT/2000/XP, NT/XP Embedded
Real-time	Beckhoff real-time kernel

Windows driver for Beckhoff Control Panel

System software

TwinCAT ECAD Import

tool for importing XML files from ECAD systems

TwinCAT Engineering Interface Server

for coordination of programming tasks via a source code management system

TwinCAT Eventlogger

Alarm and diagnosis system that can be used in all TwinCAT controllers with very little programming effort.

TwinCAT XML Data Server

PLC data can be written directly into an XML file or read from an XML file.

TwinCAT Backup

tool for backing up and restoring of files, operating system and TwinCAT settings

TwinCAT Simulation Manager

simplifies preparation and configuration of a simulation environment

System software | Motion

TwinCAT Cam Design Tool

tool for designing electronic cam plates, fully integrated in the TwinCAT System Manager

TwinCAT Digital Cam Server

fast camshaft controller as software implementation in TwinCAT, freely configurable via the TwinCAT System Manager

TwinCAT DriveTop Server

communication server for connecting the Indramat DriveTop tool with TwinCAT

TwinCAT DriveCom OPC Server

for communication of drive setup tools right into DriveCom compatible drives

TwinCAT Valve Diagram Editor

graphics-oriented editor for designing the characteristic curves of a hydraulic valve

System software | Connectivity

TwinCAT ADS

set of different ADS communication components

TwinCAT OPC Server

for access to TwinCAT variables through OPC clients, for connection to all common visualisation packages

TwinCAT SMS/SMTP Server

enables sending of SMS messages from the TwinCAT PLC to a mobile phone

TwinCAT Modbus TCP Server

for communication with Modbus TCP devices (server and client functionality)

TwinCAT TCP Server

Server and PLC library for communication via generic TCP server (client functionalities included)

INFORMATION MEDIA

Main catalog	News catalog	Product CD	Internet
Order no. DK110x	Order no. DK130x	Order no. DK4000	www.beckhoff.com
			

Ordering information	Description
DK1101	Main catalog, German
DK1102	Main catalog, English
DK1301	News catalog, German
DK1302	News catalog, English
DK1401	Product overview, German
DK1402	Product overview, English
DK1405	Product overview, French
DK1406	Product overview, Italian
DK1407	Product overview, Russian
DK4000	Main catalog and software products on CD, German, English, Italian
DK6001	Company magazine PC-Control, German
DK6002	Company magazine PC-Control, English

Beckhoff™ and TwinCAT™ are registered trademarks of Beckhoff. Other designations used in this publication may be trademarks whose use by third parties for their own purposes could violate the rights of the owners. © Beckhoff 2007, subject to change without prior notice.

The information provided in this brochure contains merely general descriptions or characteristics of performance with in case of actual application do not always apply as described or which may change as a result of further development of the products. An obligation to provide the respective characteristics shall only exist if expressly agreed in the terms of contract.

Headquarters

Beckhoff Automation GmbH
Eiserstraße 5
33415 Verl
Germany
Phone: +49(0)5246/963-0
Fax: +49(0)5246/963-198
info@beckhoff.de
www.beckhoff.de

Europe

Germany
Office Balingen
Beckhoff Automation GmbH
Karlstraße 19
72336 Balingen
Germany
Phone: +49(0)7433/26024-0
Fax: +49(0)7433/26024-22
balingen@beckhoff.de

Office Berlin
Beckhoff Automation GmbH
Fasanenstraße 81
10623 Berlin
Germany
Phone: +49(0)30/887116-0
Fax: +49(0)30/887116-19
berlin@beckhoff.de

Office Frankfurt
Beckhoff Automation GmbH
Torhaus Westhafen
Speicherstraße 59
60327 Frankfurt am Main
Germany
Phone: +49(0)69/680988-0
Fax: +49(0)69/680988-11
frankfurt@beckhoff.de

Office Hannover
Beckhoff Automation GmbH
Würrburger Straße 13
30880 Laatzen
Germany
Phone: +49(0)511/875758-0
Fax: +49(0)511/875758-20
hannover@beckhoff.de

Office Lübeck
Beckhoff Automation GmbH
Wahmstraße 56
23552 Lübeck
Germany
Phone: +49(0)451/203988-0
Fax: +49(0)451/203988-20
luebeck@beckhoff.de

Office Munich
Beckhoff Automation GmbH
Industriestraße 31
82194 Gröbenzell/Munich
Germany
Phone: +49(0)8142/41059-0
Fax: +49(0)8142/41059-13
muenchen@beckhoff.de

Office Nuremberg
Beckhoff Automation GmbH
Ostendstraße 196
90482 Nuremberg
Germany
Phone: +49(0)911/54056-0
Fax: +49(0)911/54056-29
nuernberg@beckhoff.de

Technical Office Ravensburg
Beckhoff Automation GmbH
Zwergstraße 15
88214 Ravensburg
Germany
Phone: +49(0)751/3541550
Fax: +49(0)751/3541552
ravensburg@beckhoff.de

Office Rhein/Ruhr
Beckhoff Automation GmbH
Eurotec-Ring 40
47445 Moers
Germany
Phone: +49(0)2841/90816-6
Fax: +49(0)2841/90816-88
rhein-ruhr@beckhoff.de

Austria
Headquarters
Beckhoff Automation GmbH
Hauptstraße 4
6706 Burs
Austria
Phone: +43(0)5552/68813-0
Fax: +43(0)5552/68813-18
info@beckhoff.at
www.beckhoff.at

Sales Office
Oberösterreich
Beckhoff Automation GmbH
Softwarepark 35
4232 Hagenberg
Austria
Phone: +43(0)7236/20925-0
Fax: +43(0)7236/20926
oberoesterreich@beckhoff.at

Sales Office
Niederösterreich
Beckhoff Automation GmbH
Leobersdorferstraße 42
2560 Berndorf
Austria
Phone: +43(0)2672/81975-980
Fax: +43(0)2672/81975-915
niederoesterreich@beckhoff.at

Sales Office Tirol
Beckhoff Automation GmbH
Klammstraße 66/39
6020 Innsbruck
Austria
Phone: +43(0)512/236 043
Fax: +43(0)512/236 045
tirol@beckhoff.at

Belgium
Beckhoff Automation BVBA
Kempische Steenweg 305 bus 202
3500 Hasselt
Belgium
Phone: +32(0)11/240800
Fax: +32(0)11/240801
info@beckhoff.be
www.beckhoff.be

Multiprox N.V.
Lion d'Orweg 12
Pb. 71
9300 Aalst
Belgium
Phone: +32(0)53/765666
Fax: +32(0)53/783977
info@multiprox.be
www.multiprox.be

Bulgaria
Kastiva GmbH
68-72 Ami Bue Str., 4. Floor
1612 Sofia
Bulgaria
Phone: +359(2)9504431
Fax: +359(2)9515980
office@kastiva.com
www.kastiva.com

Croatia
Genera d.o.o.
Bosiljevska 18
10000 Zagreb
Croatia
Phone: +385 1 3647849
Fax: +385 1 3636662
genera@genera.hr
www.genera.hr

Czech Republic, Slovak Republic
Dyger s.r.o.
Vystaviste 1
648 59 Brno
Czech Republic
Phone: +4205/41321004
Fax: +4205/41249208
info@dyger.cz
www.dyger.cz

Denmark
Headquarters
Beckhoff Automation Aps
Naverland 2
2600 Glostrup
Denmark
Phone: +45 43/46 7620
Fax: +45 43/46 6335
info@beckhoff.dk
www.beckhoff.dk

Sales Office
Beckhoff Automation Aps
Centervej 2
6000 Kolding
Denmark
Phone: +45 76/31 2072
Fax: +45 76/31 2013
info@beckhoff.dk

Finland, Estonia
Headquarters
Beckhoff Automation Oy
P.O. Box 23
Kankurinkatu 4-6
05801 Hyvinkää
Finland
Phone: +358(0)20/7423800
Fax: +358(0)20/7423801
info@beckhoff.fi
www.beckhoff.fi

Sales Office Seinäjoki
Beckhoff Automation Oy
Kampusranta 9
60320 Seinäjoki
Finland
Phone: +358(0)20/7423850
Fax: +358(0)20/7423851
info@beckhoff.fi

Sales Office Tampere
Beckhoff Automation Oy
Hatanpään valtatie 24
33100 Tampere
Finland
Phone: +358(0)20/7423870
Fax: +358(0)20/7423871
info@beckhoff.fi

France
Beckhoff Automation Sarl
Immeuble "Le Montréal"
ZA de Courtabouff
19 bis, avenue du Québec
91951 Courtabouff Cedex
France
Phone: +33(0)169298370
Fax: +33(0)169284055
info@beckhoff.fr
www.beckhoff.fr

Germany
Beckhoff Automation GmbH
Ul. Nizhnaya Krasnoselskaya 40/12
kor. 20A, office 501
105066 Moscow
Russia
Phone: +7 495/411 8882
Fax: +7 495/411 8883
Support: +7 495/411 8884
info@beckhoff.ru
www.beckhoff.ru

Greece, Cyprus
J. Skourgiolos
Industrial Automation Systems
241 EL Venizelou
176 73 Kallithea/Athens
Greece
Phone: +30/2109510260
Fax: +30/2109510408
ias@otenet.gr

Hungary
Controrg Kft.
Pajta u. 14
8200 Veszprem
Hungary
Phone: +36/88424075
Fax: +36/88425601
info@controrg.hu
www.controrg.hu

Italy
Headquarters
Beckhoff Automation S.r.l.
Via E. Majorana, 1
20054 Nova Milanese (MI)
Italy
Phone: +39 0362/365164
Fax: +39 0362/40990
info@beckhoff.it
www.beckhoff.it

Great Britain, Ireland
Hayes Control Systems
The Boathouse
Station Road
Henley-on-Thames
Oxon RG9 1AZ
Great Britain
Phone: +441491/41 05 39
Fax: +441491/57 72 67
sales@hayescontrols.co.uk
www.hayescontrols.co.uk

Slovenia
Genera d.o.o.
Podmilščakova 18
1000 Ljubljana
Slovenia
Phone: +3861/4393050
Fax: +3861/4393090
genera@genera.si
www.genera.si

Spain
Headquarters
Beckhoff Automation S.A.
Edificio Testa Sant Cugat
Avda. Alcalde Barnils, 64-68
08174 Sant Cugat (Barcelona)
Spain
Phone: +3493/5844997
Fax: +3493/5844084
info@beckhoff.es
www.beckhoff.es

Sweden, Norway
Headquarters
Beckhoff Automation AB
Stenåldersgatan 2B
21376 Malmö
Sweden
Phone: +46(0)40/6808160
Fax: +46(0)40/6808161
info@beckhoff.se
www.beckhoff.se

Switzerland
Headquarters
Beckhoff Automation AG
Rheinweg 9
8200 Schaffhausen
Switzerland
Phone: +41(0)52/6334040
Fax: +41(0)52/6334055
info@beckhoff.ch
www.beckhoff.ch

Poland
Beckhoff Automation Sp. z o.o.
Stara Iwiczna 116A
05-500 Piaseczno
Poland
Phone: +4822/7572610
Fax: +4822/7572607
info@beckhoff.pl
www.beckhoff.pl

Portugal
Bresimar – Sociedade de Equipamentos Eléctricos, Lda.
Quinta do Simão –
EN109 – Esgueira
Apartado 3080
3801-101 Aveiro
Portugal
Phone: +351 234/303320
Fax: +351 234/303328
bresimar@bresimar.pt
www.bresimar.pt

Romania
Kreatron Automation S.R.L.
str. Bucuresti nr. 51, ap. 57
400148 Cluj-Napoca
jud. Cluj
Romania
Phone: +40264/484708
Fax: +40264/484708
office@kreatron.ro
www.kreatron.ro

Russia
Representation of
Beckhoff Automation GmbH
Ul. Nizhnaya Krasnoselskaya 40/12
kor. 20A, office 501
105066 Moscow
Russia
Phone: +7 495/411 8882
Fax: +7 495/411 8883
Support: +7 495/411 8884
info@beckhoff.ru
www.beckhoff.ru

Turkey
Siskon Endüstriyel Otomasyon
Sistemleri
153. Sok. 23/A Nokta
35280 Izmir
Turkey
Phone: +90232/2450076
Fax: +90232/2449453
mail@siskon.com.tr
www.siskon.com.tr

USA
Headquarters
Beckhoff Automation LLC
12150 Nicollet Avenue South
Burnsville, MN 55337
USA
Phone: +1952/8900000
Fax: +1952/8902888
beckhoff.usa@beckhoff.com
www.beckhoff.com

North America
North Sales
Beckhoff Automation LLC
12150 Nicollet Avenue South
Burnsville, MN 55337
USA
Phone: +1952/8086513
Fax: +1952/8902888
north.usa@beckhoff.com

South America
Headquarters
Beckhoff Automation LLC
12150 Nicollet Avenue South
Burnsville, MN 55337
USA
Phone: +1952/8902888
Fax: +1952/8902888
west.application@beckhoff.com

West Coast
Technical Center
Beckhoff Automation LLC
5820 Oberlin Drive
Suite 111
San Diego, CA 92121
USA
Phone: +1858/5461111
Fax: +1858/5461112
west.application@beckhoff.com

West Sales
Beckhoff Automation LLC
8175-A Sheridan Blvd # 141
Arvada, CO 80003-1928
Colorado, USA
Phone: +1303/4290758
Fax: +1303/4290758
colorado@beckhoff.com

Canada
Headquarters
Application Development
Beckhoff Automation
Canada Ltd.
130 Research Lane, Unit 11
Guelph, ON N1G 5G3
Canada
Phone: +1905/8521534
Fax: +1905/8521535
canada@beckhoff.com
www.beckhoff.com

Mexico
Mexico Sales and
Application Development
Integra Automation, SA de CV
Av. Industrias 325-A
78399 Fracc. Talleres
San Luis Potosí, S.L.P.
Mexico
Phone: +52444/8222615
Fax: +52444/8222616
mexico@beckhoff.com

South America
Argentina
eFALCOM
Alcorta 2411
CPA B1744HFM
Moreno/Buenos Aires
Argentina
Phone: +54237/4631151
Fax: +54237/4631150
info@efalcom.com
www.efalcom.com

Brazil
Beckhoff Automação Industrial
Lda.
Rua Continental, 146 – Jd. do Mar
São Bernardo do Campo
São Paulo 09750-060
Brazil
Phone: +55(11)4126-3232
Fax: +55(11)4330-3701
info@beckhoff.com.br
www.beckhoff.com.br

Chile
Rocel S.A.
Panamericana Norte Km 15 1/2,
Post Office: Santiago
Santiago
Chile
Phone: +562/6408000
Fax: +562/7471320
info@rocel.cl
www.rocel.cl

Africa
Egypt
Industrial Control Systems ICS
29 Dr. Mohamed El Harouny
Street
Nasr City, Cairo 11371
Egypt
Phone: +202/72755031
Fax: +202/72755031
info@ics-me.com
www.ics-me.com

South Africa
Beckhoff Automation (Pty) Ltd
Unit 8, Boskruijn Business Park,
Randpark Ridge
Randburg 2188
South Africa
Phone: +27(0)117923374
Fax: +27(0)117925453
info@beckhoff.co.za
www.beckhoff.co.za

Asia
Headquarters
Beckhoff Automation GmbH
5th Floor,
No. 163 Jiang Chang San Road
Shanghai Shibei
Industrial New Zone
Shanghai, 200436
P. R. China
Phone: +8621/66312666
Fax: +8621/66315696
info@beckhoff.com.cn
www.beckhoff.com.cn

Representation Beijing
Beckhoff Automation GmbH
Room 1608, Tower B,
Investment Plaza,
No. 27 Financial Street
Xicheng District
Beijing, 100032
P. R. China
Phone: +8610/66210991
Fax: +8610/66210992
beijing@beckhoff.com.cn

Representation Guangzhou
Beckhoff Automation GmbH
Citic Plaza
Room 1418
233 Tianhe North Road
Guangzhou, 510620
P. R. China
Phone: +8620/38773571
Fax: +8620/38773573
guangzhou@beckhoff.com.cn

India
Inteltek Automation Pvt. Ltd.
Sr.no.1005, Ambeegaon
Pune 411 046
Maharashtra
India
Phone: +9120/24318121
Fax: +9120/24318124
info@inteltekindia.com
www.inteltekindia.com

Japan
K.MECES Co., Ltd.
Yusen Iwamotocho Bldg. 3F
2-3-3 Iwamotocho, Chiyoda-City,
Tokyo 100-0032
Japan
Phone: +81358255333
Fax: +81358258550
info@kmecs.co.jp
www.kmecs.com

Singapore, Malaysia, Thailand, Philippines, Vietnam, Indonesia
TDS Technology (S) Pte Ltd.
64 Sungei Kadut Loop
(Hogen Building)
Singapore 729493
Singapore
Phone: +65 63661661
Fax: +65 63621661
sales@tdstech.com
www.tdstech.com

Tri-TEK Korea
Tri-TEK Corp.
717 DaeRyong TechnoTown III
448 KasanDong Kumcheongu
Seoul 153-803
Korea
Phone: +822/2107-3242
Fax: +822/2107-3969
tritek@tritek.co.kr
www.tritek.co.kr

Taiwan
JI-DIEN Co., Ltd.
9F, No. 22, Sec. 1, Jhongshan Rd.
Sinhjuang City
Taipeli County 24250
Taiwan (R.O.C.)
Phone: +886(2)85223237
Fax: +886(2)85223168
jidienn@chrgroup.com.tw
www.chrgroup.com.tw

Australia
Beckhoff Automation Pty. Ltd.
Level 16, 10 Queens Road
Melbourne, Victoria, 3004
Australia
Phone: +61(3)99125430
Fax: +61(3)83204730
info@beckhoff.com.au
www.beckhoff.com.au

New Zealand
W. Arthur Fisher
P.O. Box 12747
Penrose
Auckland
New Zealand
Phone: +649/2700900
Fax: +649/2700900
waf@waf.co.nz
www.waf.co.nz