

637+



EUROTHERM
DRIVES

Digital Servodrive the 4th Generation



637+_komp_S_B_01.jpg

PRODUCT
MANUAL



Further descriptions, that relate to this document.

UL:07-02-01



Product - manual Rack 6 U and EMV

UL:07-02-02-01



Product - manual Power supply plug-in module NE B

UL: 07-02-09-02



Feedbacksystem HIPERFACE®

UL:07-05-02-03



Product - manual SUCOnet K

UL:07-05-03-02



Product - manual Bus interface CAN for 635 637 637+

UL:07-05-04-02



Product - manual Bus interface DP for 635 637 637+

UL:07-05-05-02



Product - manual Bus interface Interbus S for 635 637 637+

UL:07-05-07-02



Product - manual I/O Interface for 635 637 637+

UL:07-05-08-02



Product - manual Bus interface DeviceNet for 635 637 637+

Further descriptions, that relate to this document.

UL:07-09-04-02



Product - manual Supression aids EH

UL:10-06-03



Product - manual Serial transfer protocol 635 637 637+
EASY-serial

UL: CD



EASYRIDER® Windows - Software

UL:10-06-05



Product - manual Software BIAS®

UL: 12-01



Product - manual Accessories - Plugs

UL:12-02



Product - manual Accessories - Cable

UL:12-03



Product - manual Accessories - Brake resistances

© **EUROTHERM** Drives Limited.

All rights reserved. No portion of this description may be produced or processed in any form without the consent of the company.

Changes are subject to change without notice.

EUROTHERM has registered in part trademark protection and legal protection of designs.
The handing over of the descriptions may not be construed as the transfer of any rights.

Made in Germany, 2002



CONTENTS

Page

The most important thing first.....	7
Safety precautions	8
1 General	10
1.1 System description	10
1.1.1 Digital communication.....	11
1.1.2 Operation configurations.....	11
1.1.3 Compatibility to 637 servodrives	12
1.2 Key to the models.....	13
1.2.1 Example.....	13
1.3 Range data.....	14
1.3.1 Insulation concept	14
1.3.2 General data	14
1.3.3 Compact units 637+/K D6R.....	15
1.3.4 Plug-in modules 637+/D6R.....	16
1.3.5 Single- and three-phase supply	17
1.3.6 Output power.....	18
1.4 Dimensions and layout.....	19
1.4.1 Dimensions for compact device and plug-in module.....	19
1.4.2 EMC-Clip (optional).....	20
1.4.3 Layout	21
2 Connector assignment and functions	22
2.1 General view of connections of the compact device 637+/ K D6R 02 - 10 <u>Width 14HP</u> 22	
2.1.2 General view of connections of the compact device 637+/K D6R 16...30 <u>Width 20 HP</u> 23	
2.2 Connector pin assignments and contact functions	24
2.2.1 Power connections for plug-in module 637+/D6R	24
2.3.1 Signal connections	25
2.3.2 Control signal plug X10 SUB D25 socket	25
2.4 Feedback-Sensor-Connection X30.....	28
2.4.1 Function-Module X300.....	28
2.4.2 Resolver connection X30 SUB D 09 socket	29
2.5 Multi-function X40	30
2.5.1 Incremental <u>output</u>	31
2.5.2 Incremental <u>input</u>	32
2.5.3 Stepper motor <u>input</u>	33
2.5.4 Stepper motor <u>input</u>	34
2.5.5 SSI-Encoder Interface (under preparation).....	35
2.6 Digital interfaces	36
2.6.1 Service interface COM1 (RS232).....	36
2.6.2 Fieldbus interface <u>COM2</u>	37

CONTENTS

	Page
3 Operating modes	43
3.1 Operating modes and pin functions.....	44
3.2 Configurable pin-functions (depending on the operating mode)	45
3.3 Function diagrams from inputs and outputs.....	46
4 Mechanical installation	47
4.1 Mounting.....	47
4.2 Control cabinet - mounting	47
4.3 Cooling.....	47
5 Electrical installation	48
5.1 Safety.....	48
5.2 The danger of electric shocks.....	48
5.3 Danger areas.....	48
5.4 Grounding, safety grounding	48
5.4.1 Ground connections	48
5.5 Short-circuit capability and discharge currents.....	48
5.6 Fuses, contactors, filters.....	49
5.7 Correction of supply current	50
5.8 Brake resistor	51
5.8.1 Selection of the brake resistor.....	51
5.8.2 Configuration of the brake resistor	52
5.8.3 Additional informations	53
6 Wiring instructions	54
6.1 General Information	54
6.2 Control cabling.....	54
6.3 Power cabling.....	54
6.4 Installation of the rack.....	54
6.5 Analog setpoint	54
6.6 Safety rules.....	54
6.7 Electromagnetic compatibility (EMC).....	54
6.7.1 Hints for mounting	55
6.7.2 Example for mounting.....	56
6.7.3 Achievable specifications and conditions	57
7.1 Jumper	58
All jumpers are set to a standard position in production !	58
7.2 Digital communication.....	58
8 Commissioning	59
8.1 Preparation	59
8.2 Commissioning in steps	60



CONTENTS

	Page
9	Diagnosis and trouble shooting..... 63
9.1	7-segment display..... 63
9.2	Reset of a regulator trouble 65
9.3	Trouble shooting 66
10	Block circuit diagram..... 67
11	General technical data 68
11.1	Power circuit 68
11.2	Control circuit 68
11.3	Signal inputs and outputs, connection X10 68
11.4	Digital control 69
11.5	Digital communication..... 69
11.6	Resolverauswertung / Transmitterprinzip 69
11.7	Controllersystem 70
11.8	Analog-Outps 70
11.9	Thermal data..... 70
11.10	Mechanical data 70
12	Disposal..... 71
13	Software..... 72
13.1	EASYRIDER® Windows - Software 72
13.2	Eurotherm programming language BIAS 73
13.3	BIAS-commands 75
13.4	Extended BIAS-commands 76
14	Certificates 77
15	Index 84
16	Notes 85
17	Modification Record 86

The most important thing first

We thank you for the trust that you have shown in our product.

The operating instructions presented hereserves as an overview of the technical data and features.

Please read the operating instructions before putting the product to use.

If you have any questions, please contact your nearest Eurotherm representative.

Improper application of the product in connection with dangerous voltage, can lead to injuries.

In addition, damage can also occur to motors or other products.

Therefore please observe strictly our safety precautions.

Topic: Safety precautions

We assume that as an expert, you are familiar with the relevant safety regulations, especially in accordance with VDE 0100, VDE 0113, VDE 0160, EN 50178, the accident prevention regulations of the employers liability insurance company and the DIN regulations and that you can use and apply them. Also the CE - regulations are to be observed and guaranteed.

Depending on the kind of application, additional norms e.g. UL, DIN are to be observed.

If our products are employed in connection with components from other manufacturers, their operating instructions are also to be strictly observed.



Safety precautions



Attention !

The digital servo drives are in the sense of EN 50178/VDE 0160 power electronic equipments for regulating the flow of energy in electrical power installations.

They are exclusively for supplying Eurotherm (or Eurotherm approved) servomotors.

Handling, installation, operation, and maintenance are only permitted under the conditions of and in keeping with the effective and/or legal regulations, regulation publications and this technical document.

The operator must make sure that these regulations are strictly followed.

Concept of the galvanic separation and insulation:

Galvanically separation and insulation correspond to EN 50178/VDE 0160, amplified insulation.

In addition all digital signal inputs and outputs are galvanically separated either as a relay or via opto coupler. In this way an increased interference security and the limitation of damages in case of external incorrect connections is given.

The voltage level must not exceed the low safety voltage 60V DC or 25V AC, respectively in accordance with EN 50178/VDE 0160.

The operator must make sure that these regulations are strictly followed.



Danger !

**High contact voltage !
Danger of getting shocked !
Danger to your life !**



Caution !

**Opening the servo drive by the operator is prohibited due to reasons of safety and guarantee.
The requirement for problem-free operation of the servo drive is the expert configuring !**

Safety precautions

Please observe !

Especially to be complied with:

The class of protection which is permitted: protective grounding; operation is only permitted when the protective conductor is connected according to regulations.

The operation of servo drives is not allowed under the sole use of a residual current operated protective device as protection against indirect touching.

The servo drive may only be used in the rack or in its compact enclosure. Furthermore the regulator is designed solely for control cabinet operation.

Work on or with the servo drive may only be carried out with insulated tools.

Installation work may only be done in a deenergized state. When working on the drive, do not only block the Aktiv-input but separate the complete drive from the mains.

CAUTION - risk of electrical shock, wait 3 minutes after switching off, for discharging the capacitors.

Screws sealed with varnish fulfill an important protection function and may not be moved or removed.

It is prohibited to penetrate the inside of the unit with objects of any kind.

Protect the unit from falling parts (pieces of wire, flay, metal parts, etc.) during installation or other work in the control cabinet. Metal parts can lead to a short in the servo drive.

Before putting into operation, remove additional covers so that the unit does not overheat. With measurements at the servo drive it is absolutely necessary to observe the potential separation!



Eurotherm Drives Limited is not liable for damages which occur by not following the instructions or the applicable regulations !!



1 General

1.1 System description

The digital servo drive serves the 4 th generation to regulate the current, speed and position of **AC servo motors**,(standard: with resolver)

All servo controls and functions are realized digitally.

System variants

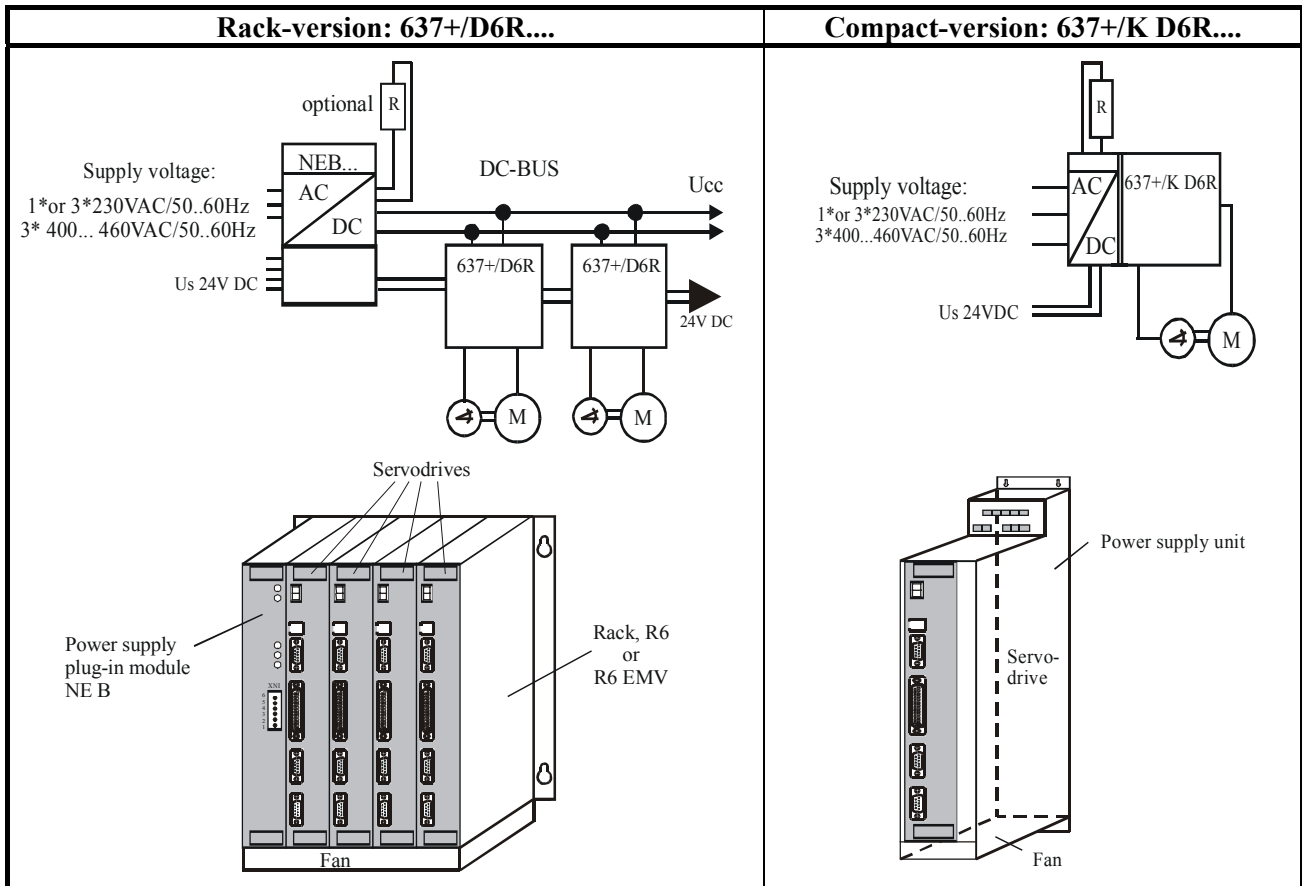

Explanations to rack and power supply modules are documented in separate description.

If required, the returned braking energy can be drawn off into additional external ballast resistors.

The AC-supply voltage is fed directly or via transformer to the associated power supply module.

The devices are designed to be operated on networks which are grounded on centre point (TN networks) !

System description

1.1.1 Digital communication

Diagnose / Setup

General: by 7-segment display

Comfortable: via PC by EASYRIDER® Windows - Software
(serial interface RS232)

Communication

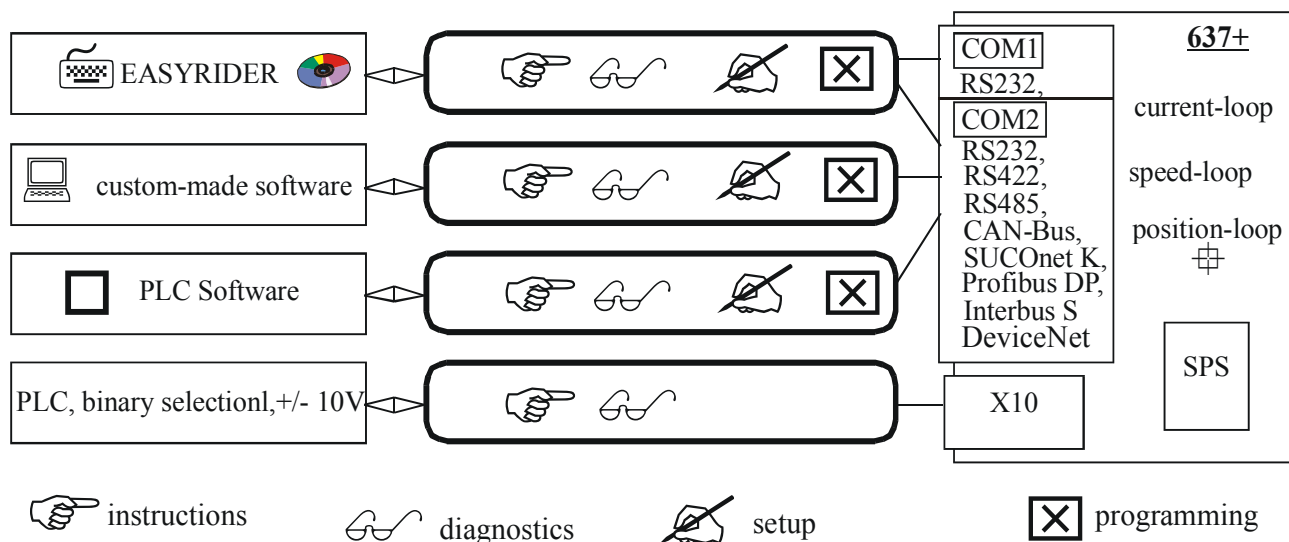

The serial-communication-protocol is free documented.

(Explanation see separate documentation)

Every user has unrestricted access to all functions and parameters.

1.1.2 Operation configurations

There are opportunities ranging from simple current and speed control to programmable position control processes (PLC), supported by the 1500 BIAS- command blocks.

"BIAS" User shell for intelligent drive controls

see:

chapter 3 Operating modes

chapter 13.2 BIAS - commands

chapter 13.3 Extended BIAS – commands



System description

1.1.3 Compatibility to 637 servodrives (Not required for new projects)

The 637+ series servo controllers are essentially pin- and functionally compatible with the servo controllers 637. However at replacement of a 637 for a 637+ controller, the existing application must be checked and carefully tested under compliance with the corresponding safety precautions.

The following points should be checked in any case and eventually be adjusted before function test:

1. Motor direction parameter and limit switch setting (please see Release note 637+ V6.12)
2. Position setpoints and comparison values have to be quadrupled, resp. Octal (low encoder resolution at 637)
3. Coupling factors in synchronous applications have to be quadrupled, resp. octal (low encoder resolution at 637)
4. Execution of BIAS- and PLC programs is 2.25 times quicker than at 637. This can cause Timing problems at unfavourable programming (e.g. Wait times with NOPs)

Function	637	637+
PC-Operating-Software	EASYRIDER® DOS-Version or Windows-Version	EASYRIDER® Windows -Version
PC-Connection-Cable see: chapter 2.6.2.3	SUBD-9 to LEMO-Connector (COM1)	SUBD-9 to 4-pol Module-Connector (COM1)
Powerpart, Powerdata and Powerconnectors	Unchanged	
Control-Singals, Connector X10 see: chapter 2.3.2	unchanged pinning and function	
Analog Setpoint X10.5/18, Resolution	12 bit	14 bit
Resolversignals, Connector X30 see: chapter 2.4.2	pin – compatible 12/14 bit resolution	extended functionality 16 bit
Feedback – Interface - Module X300 see: chapter 2.4.1	-	New, extended flexibility (HIPERFACE etc)
Multifunction, Connector X40 see: chapter 2.5	compatible	extended functionality
Interface, Connector COM2 see: chapter 2.6.2 – 2.6.2.9	unchanged	
Optionsmodule see: chapter 2.6.2 – 2.6.2.10	unchanged	
Operating Modes, BIAS – Functions see: chapter 3 and 13.2	command set compatible position value 12/14 bit ≈ 1revolution	future extensions possible position value 16 bit ≈ 1 revolution
PROG-Key		not available
Analog-Output-Testsginals MP1/MP2: > connector X 10	X 10.6 / X 10.17	
> Front-Testconnectors	yes	no
Tecnical Data Analog Out MP1 / X10.17 MP2 / X10.6	7 bit , Rout = 10 kOhm 7 bit , Rout = 10 kOhm	8 bit , Rout = 1,8 kOhm 10 bit , Rout = 1,8 kOhm
Control-Loops see: chapter 11.4		Performance increased: Cycle times are double speed now
Control-Loop Parameters		Generally compatible, possibly optimisation required
Jumper see: chapter 7.1		JP2.2, JP2.3, JP2.7, JP2.8

1.2 Key to the models

Marking	Standard					optional			
	a	b	c	d	e	f	g	h	
Model:	XXX/	X	D6R	XX	.S4	-X	-X	-XXX	-XXx

Marking	Description
	XXX/ = 637+ ≅ Eurotherm-design (blue)
a	K = 1 axis compact digital servo drive system = (is not used with model plug-in device)
b	D6R = Digital 6U Regulator
c	Rated current: 02 = 2 amperes 04 = 4 amperes 06 = 6 amperes 10 = 10 amperes 16 = 16 amperes 22 = 22 amperes 30 = 30 amperes
d	.S4 = Digital drive 4 th generation
e	Intermediate circuit rated voltage: -3 = 325V (230V AC) 16..30A only as racksystem -7 = 650V (460V AC)
f	-E = with EMC-Clip unit -0 = without EMC-Clip unit
g	additional optionmodules on the drive for communication via <u>COM2</u> -232 = RS 232 interface -422 = RS 422 interface -485 = RS 485 interface -CAN = CAN - bus -DEV = CAN - bus / DeviceNet -SUC = SUCOnet K -PDP = Profibus DP -IBS = Interbus S (Attention: changed front plate) -EA5 = I/O - interface (5E, 2A) <u>COM2</u> -EAE = I/O - Interface (14E, 10A) <u>X200</u> (Attention: changed front plate) -XXE = Combination of communication interface and I/O interface EAE (the first two places of com.-interface + E for I/O-interface EAE)
h	X300 – Funktionsmodules = no information = standard <u>X30</u> Resolver (-RD2) -HF2 = HIPERFACE – Module 2. Version

1.2.1 Example

Typical example of an order of a 1-axis- compact device in Eurotherm-design

Model: 637+/K D6R 02.S4-7-CAN

- 637+/ = Eurotherm-design (blue)
- K = 1 axis compact device
- D6R = **D**igital **6**U Regulator
- 02 = **2** amperes Regulator rated current
- .S4 = Digital drive **4** th generation
- 7 = 650V UCCN
- CAN = CAN-Bus – Optionsmodule insertion

1.3 Range data

1.3.1 Insulation concept

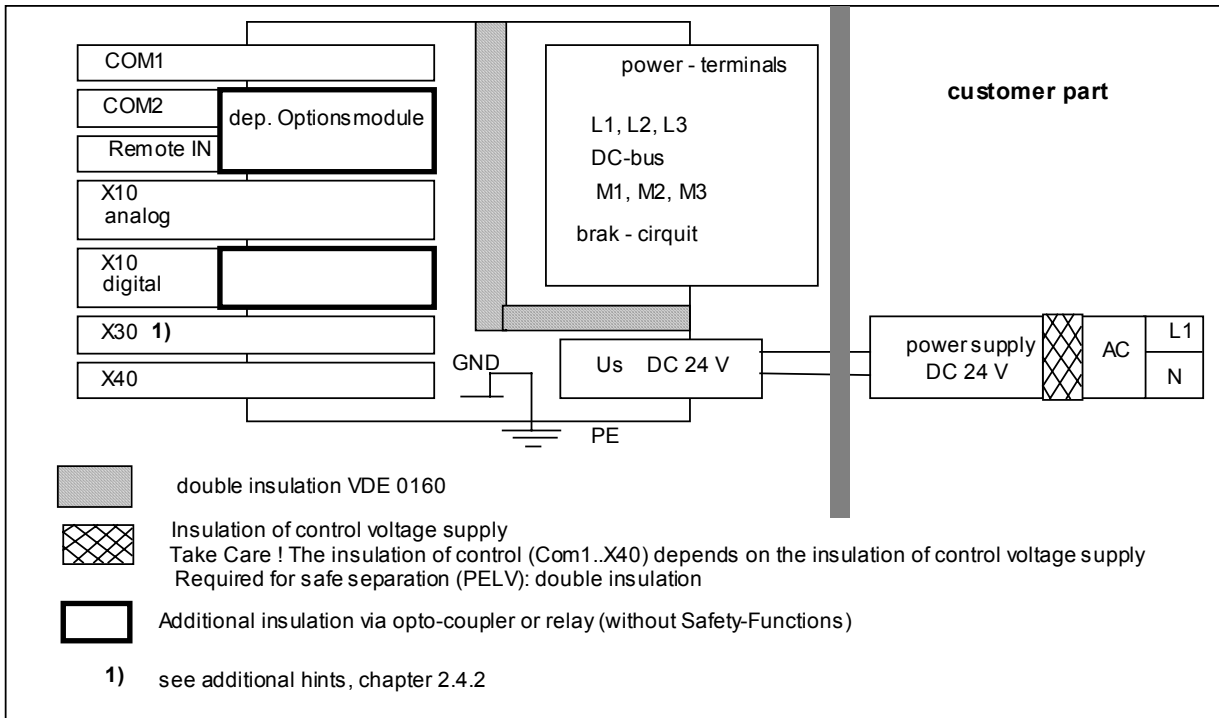

1.3.2 General data

Enclosure Rating (for mounting in cubicle)		IP20
operating temperature range		EN 50178 / VDE 0160, class 3K3
storage temperature range		-25°...+55° C
air pressure		86 kPa - 106 kPa
Humidity		5 % - 85% 40°C
Operating Temp		0...40°C
reduced operation derating of the output current	1)	>40°...< 50°C 2% / °C
Altitude h		h ≤ 1000m
reduced operation Derating of the output current	1)	h > 1000...≤ 4000m 1% / 100m
Safety Overvoltage-category of power circuit		EN 50178 / VDE 0160, UL, cUL III,
Pollution degree for mounting in cubicle		VDE / UL: 2
Vibration test in accordance with DIN IEC 68-2-6, test FC Condition for testing Frequency range Amplitude Acceleration Test time per axis Frequency sweep speed		10...57Hz 57...150Hz 0,075 mm 1g 10 sweep cycle 1 Oktave/min

¹⁾ Use only fan-cooled devices. For reduced operating conditions, no UL-Approbation are available.

Range data

1.3.3 Compact units 637+/K D6R

Compact units	637+ /		K D6R 02		K D6R 04		K D6R 06		K D6R 10		K D6R 16		K D6R 22		K D6R 30		
			.S4		.S4		.S4		.S4		.S4		.S4		.S4		
				-3	-7	-3	-7	-3	-7	-3	-7	-7	-7	-7	-7		
Input																	
supply voltage	min.	[V]	14														
50..60 Hz	Un	[V]	230	460	230	460	230	460	230	460	460	460	460	460	460		
	max.	tolerance	+ 10%														
phases			1;3	3	1;3	3	1;3	3	1;3	3	3	3	3	3	3		
supply-preparation			Fuses, contactors, filters see chapter 5.6														
power-on current limit	model		NTC 4 Ohm									NTC 2 Ohm					
control voltage	¹⁾ Us	[V]	21,5....24....29, attention: insulation-concept chapter 1.3.1														
control current incl. Fan	Is DC	[A]	Continuous: max. 1,2A Power-On-Peak: nom. 3A; max.. 6A / 0,8 mS, 2,5A / 25 mS									Continuous: max 1,5A Power-On-Peak: nom. 3A; max. 6A / 0,8 mS, 3A / 25 mS					
Output																	
sine-wave volt. At Un	Unr	[Veff]	220	447	220	447	220	447	220	447	447	447	447	447	447	447 ³⁾	
derating of Unr			depending on load and single or 3-phase supply. (see chapter 1.3.5)														
rated current RMS	Inr	[A]	2	4	4	6	10	16	22	30 ³⁾							
max. current RMS	Imaxr	[A]	4	8	8	12	20	32	44	60							
time for Imax	⁴⁾ min.	Sec	5	5	5	5	5	5	5	5							
min. motor inductance (terminal / terminal)	Lph/ph	[mH]	6,0	12,0	3,0	6,0	2,0	4,0	1,2	2,4	2,0	1,1	0,8				
Brake circuit																	
Setpoint DC	Ub	[V]	375	730	375	730	375	730	375	730	730	730	730	730	730		
max. power	Pbmax	[kW]	4,5	8,7	4,5	8,7	6,7	13,0	11,2	21,7	29,0	34,8	34,8	34,8	34,8		
continuous power	Pbnenn	[W]	≤ 560														
internal resistor	Rbint Pd Pmax	[Ω] [W] [kW]	100 30 1,4	300 30 1,7	100 30 1,4	300 30 1,7	100 30 1,4	300 30 1,7	100 30 1,4	300 30 1,7	-----						
min. external resistor	²⁾ Rbextmin	[Ω]	47	82	47	82	27	47	15	27	20	15	15				
General																	
power loss fan, electronic	PE loos	[W]	29	29	29	29	29	29	29	29	36	36	36				
fan models 24V DC		[V]	2 Piece L 024 / (12TE * 25) 1 Piece L 024 / (12TE * 15)									2 Piece L 024 / (16TE x 25) 1 2 Piece L 024 / (16TE x 20)					
power stage per A		[W/A]	9	12	9	12	9	12	9	12	12	12	12	12	12		
weight		[kg]	5,0									8,8					
further data			see: chapter 11														

- 1) suggested: transformer-based supply
- 2) use only Eurotherm-released types
- 3) max. continuous performance derated to 80%, see chapter 1.3.6
- 4) References chapter 1.3.6



Range data

1.3.4 Plug-in modules 637+/D6R

Plug-in modules			637+/		D6R 02		D6R 04		D6R 06		D6R 10		D6R 16		D6R 22		D6R 30	
			.S4		.S4		.S4		.S4		.S4		.S4		.S4		.S4	
			-3	-7	-3	-7	-3	-7	-3	-7	-3	-7	-3	-7	-3	-7	-3	-7
Input																		
DC-BUS rated	min.	[V]	20															
	U _g	[V]	325	650	325	650	325	650	325	650	325	650	325	650	325	650	325	650
	max.	tolerance	+ 10%															
control voltage	U _s	[V]	24V DC +20% -10%, attention: insulation-concept chapter 1.3.1															
control current	¹⁾ I _s DC	[A]	Continuous: max 0,8A Power-On-Peak: nom. 2A; max 5A / 0,8 mS, 2A / 25mS															
Fan	²⁾ Typ		---	L220 K	---	L220K						L220G						
Output																		
sine-wave volt. at U _n	Unr	[V _{eff}]	220	447	220	447	220	447	220	447	220	447	220	447	220	447	220	447 ³⁾
derating of Unr			depending on load and single or 3-phase supply (see chapter 1.3.5)															
rated current RMS	I _{nr}	[A]	2		4		6		10		16		22		30 ³⁾			
max. current RMS time for I _{max}	I _{maxr}	[A] min.	4 5 Sec		8 5 Sec		12 5 Sec		20 5 Sec		32 5 Sec		44 5 Sec		60 5 Sec			
min. motor inductance (terminal / terminal)	L _{ph/ph}	[mH]	6,0	12,0	3,0	6,0	2,0	4,0	1,2	2,4	1,0	2,0	0,55	1,1	0,4	0,8		
Brake-Circuit																		
setpoint DC	U _b	[V]	375	730	375	730	375	730	375	730	375	730	375	730	375	730	375	730
max. power	P _{bmax}	[kW]	4,5	8,7	4,5	8,7	6,7	13,0	11,2	21,7	15,0	29,0	18,0	34,8	18,0	34,8		
continuous rating	P _{bnenn}	[W]	≤ 560															
min. external resistor	²⁾ R _{bextmin}	[Ω]	33	63	33	63	22	43	12	24	10	20	8,2	15	8,2	15		
General																		
power loss electronic output stage per A	PE loss	[W]	20	20	20	20	20	20	20	20	20	20	20	20	20	20	20	
		[W/A]	9	12	9	12	9	12	9	12	9	12	9	12	9	12	9	12
weight		[kg]	1,5									4,0						
further data			see chapter 11															

- 1) suggested: transformer-based supply
- 2) use only Eurotherm-released types
- 3) max. continuous performance derated to 80%, see chapter 1.3.6
- 4) References chapter 1.3.6

Range data

1.3.5 Single- and three-phase supply

Due to the line-ripple of DC-Bus, the rate of usable output voltage is derated like follows. This deration effects the max. reachable speed of the applied motor.

Three-phase-supply:

the unloaded output voltage will be derated to approx. 90%, maximum 85 %

Single-phase: supply: 50 – 60Hz

only drive 637+ / ..02 up to 06

see following diagram:

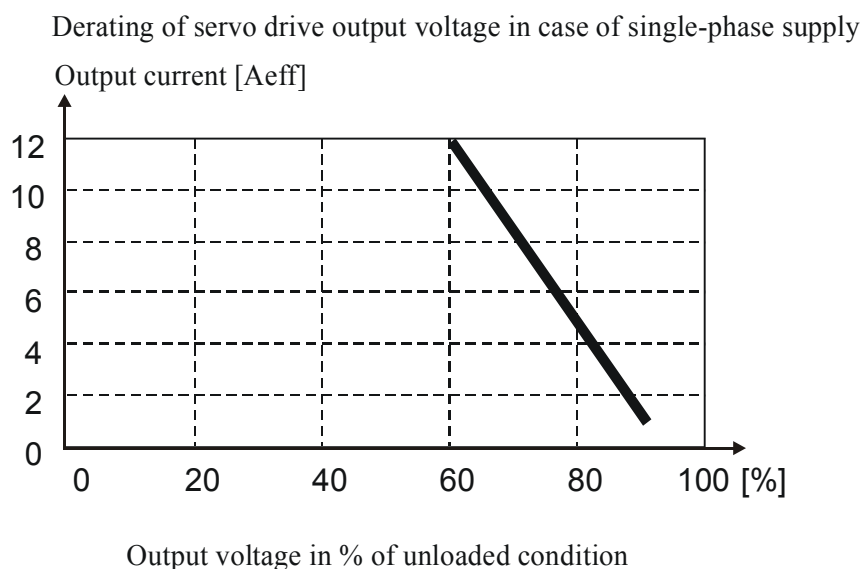

Hints for setup:

To avoid unexpected tripping of undervoltage threshold (EASYRIDER® Windows - Software), this value should be set to default.

Required motor-terminal-voltage for specified speed.

Approximation: (up to 3000RPM)

$$U_{kl} = 1,2 * (EMF * n / 1000) + I * (R_{ph} + R_L) [V]$$

U_{kl} required motorvoltage [V RMS]

EMF Back-EMF of motor [V RMS] / 1000 RPM

R_{ph} resistance of motor (between terminals) [Ω]

R_L line resistance of motor cable [Ω]

I motor-current [A RMS]



Range data

1.3.6 Output power

In case of continuous operation in the range of full-load the limits like shown in the diagram have to be respected.

Typical servo applications are not effected by this restriction. (S3-operation: Start/Stop)

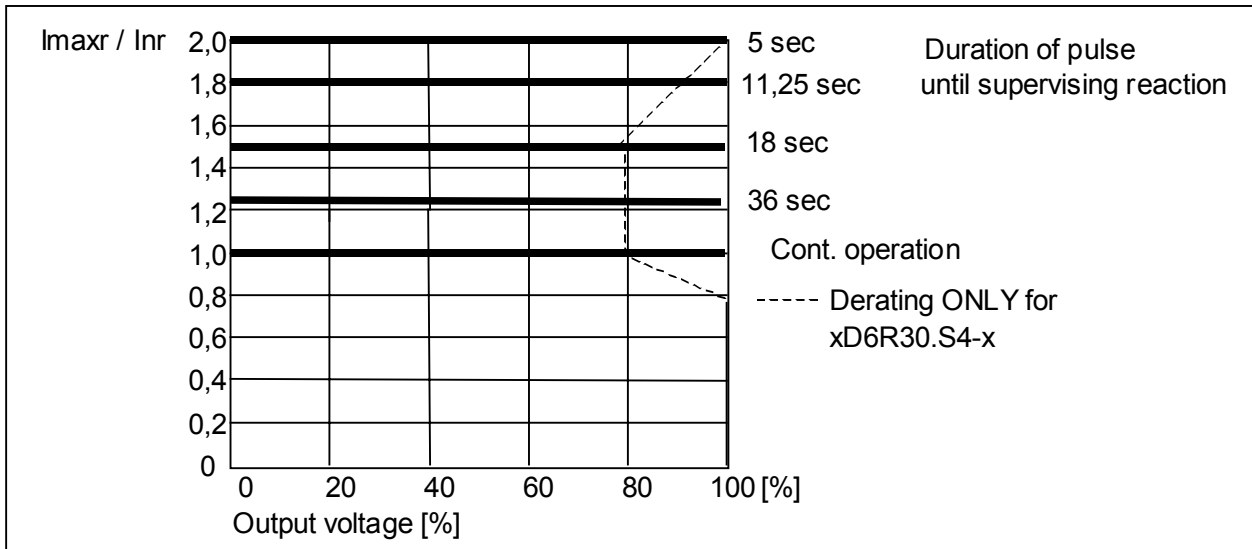

1.4 Dimensions and layout

1.4.1 Dimensions for compact device and plug-in module

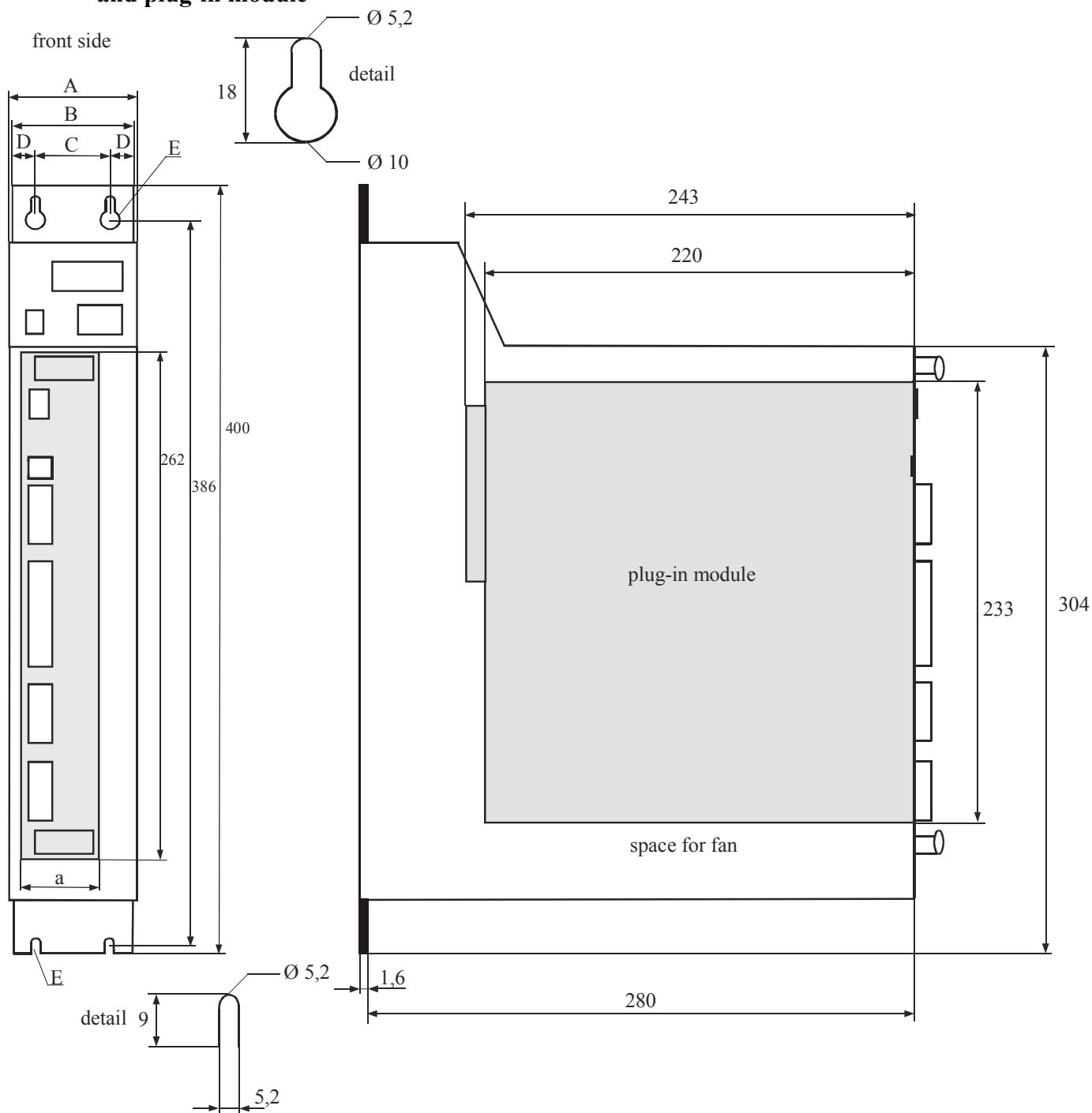

	637+/K D6R 02...10	width	637+/K D6R 16...30	width
A	65,0 mm	14 HP	104,6 mm	20 HP
B	60,0 mm		100,0 mm	
C	30,0 mm		71,0 mm	
D	14,5 mm		14,5 mm	
a	40,2 mm	8 HP	80,4 mm	16 HP

1 HP ≈ 5,08mm

Important:

Make sure you need an additional space of approx. 70 mm on the front side for the signal mating plugs !



Dimensions and layout

1.4.2 EMC-Clip (optional)

1.4.2.1 for 8 HP drive

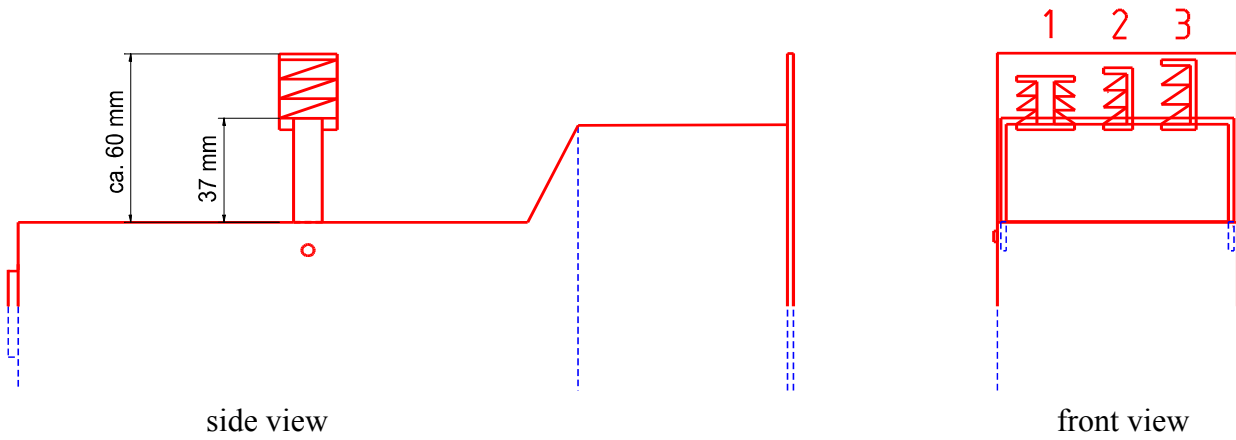

1.4.2.2 for 16 HP drive

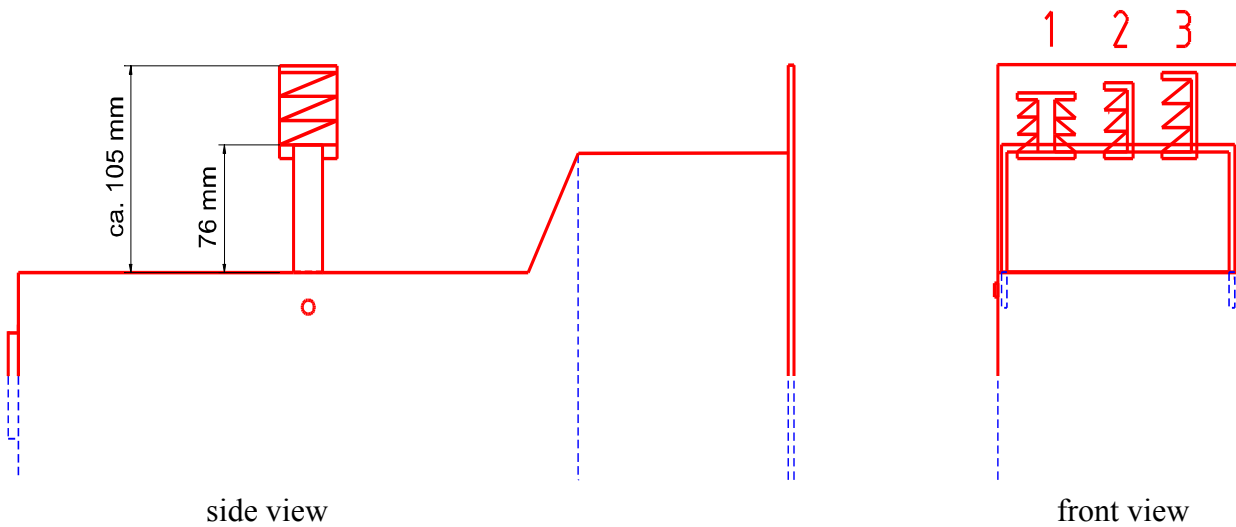

EMC-Clip for	
Feedback- cable (e.g. Resolver)	1
net cable	2
Motor cable	3

meaning:

1,2,3 = cage clamp terminal

Dimensions and layout

1.4.3 Layout

1.4.3.1 Layout of controller board

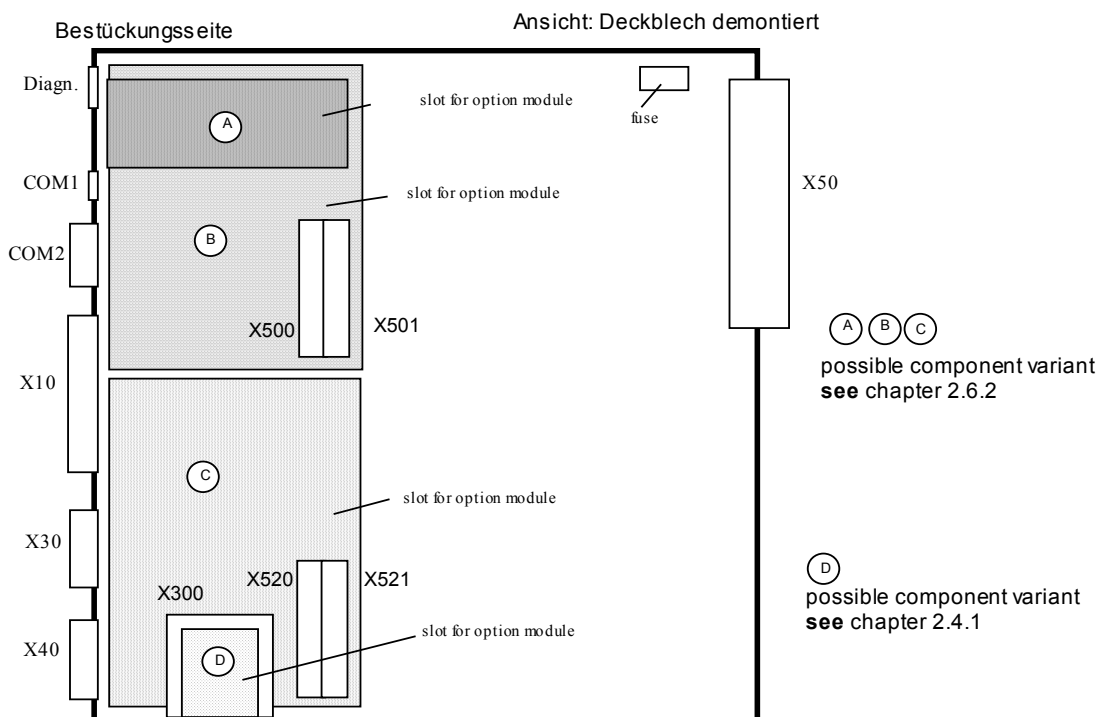

Note: The option modules for the slots A / B / C can only be reached after removing the cooling plate.

1.4.3.2 Layout of power board

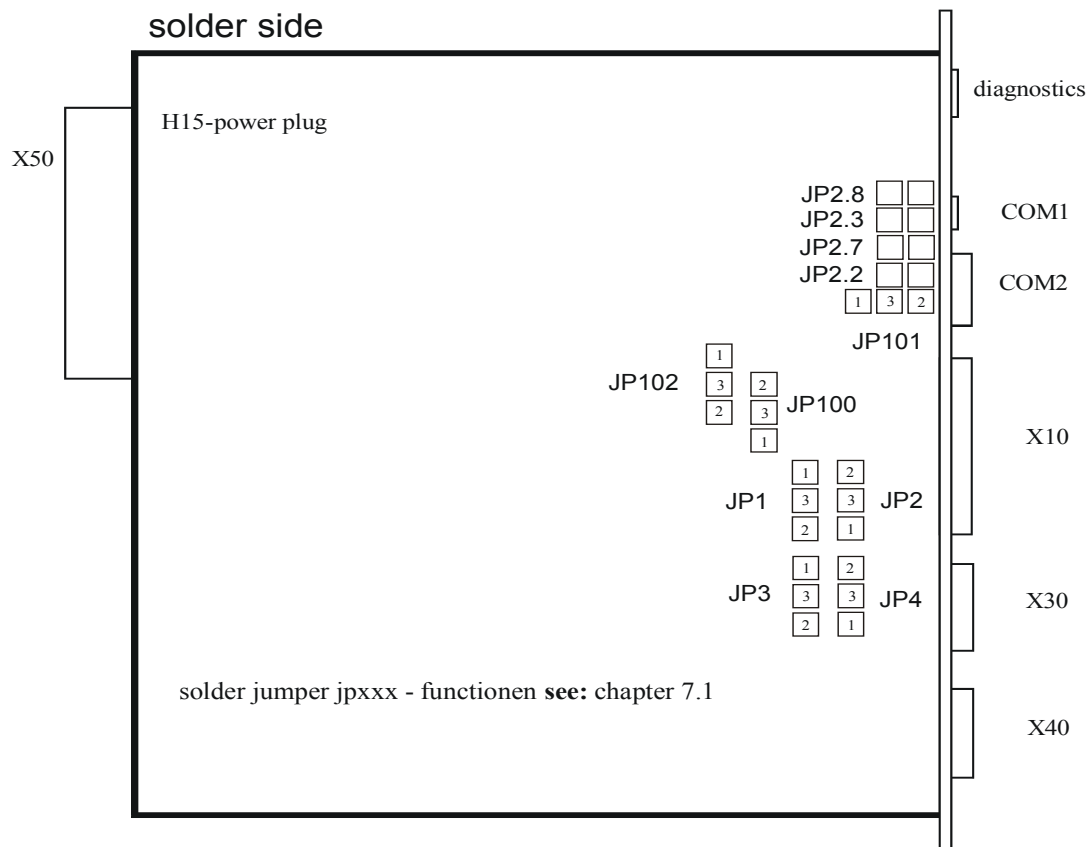

2 Connector assignment and functions

2.1 General view of connections of the compact device 637+/ K D6R 02 - 10 Width 14 HP

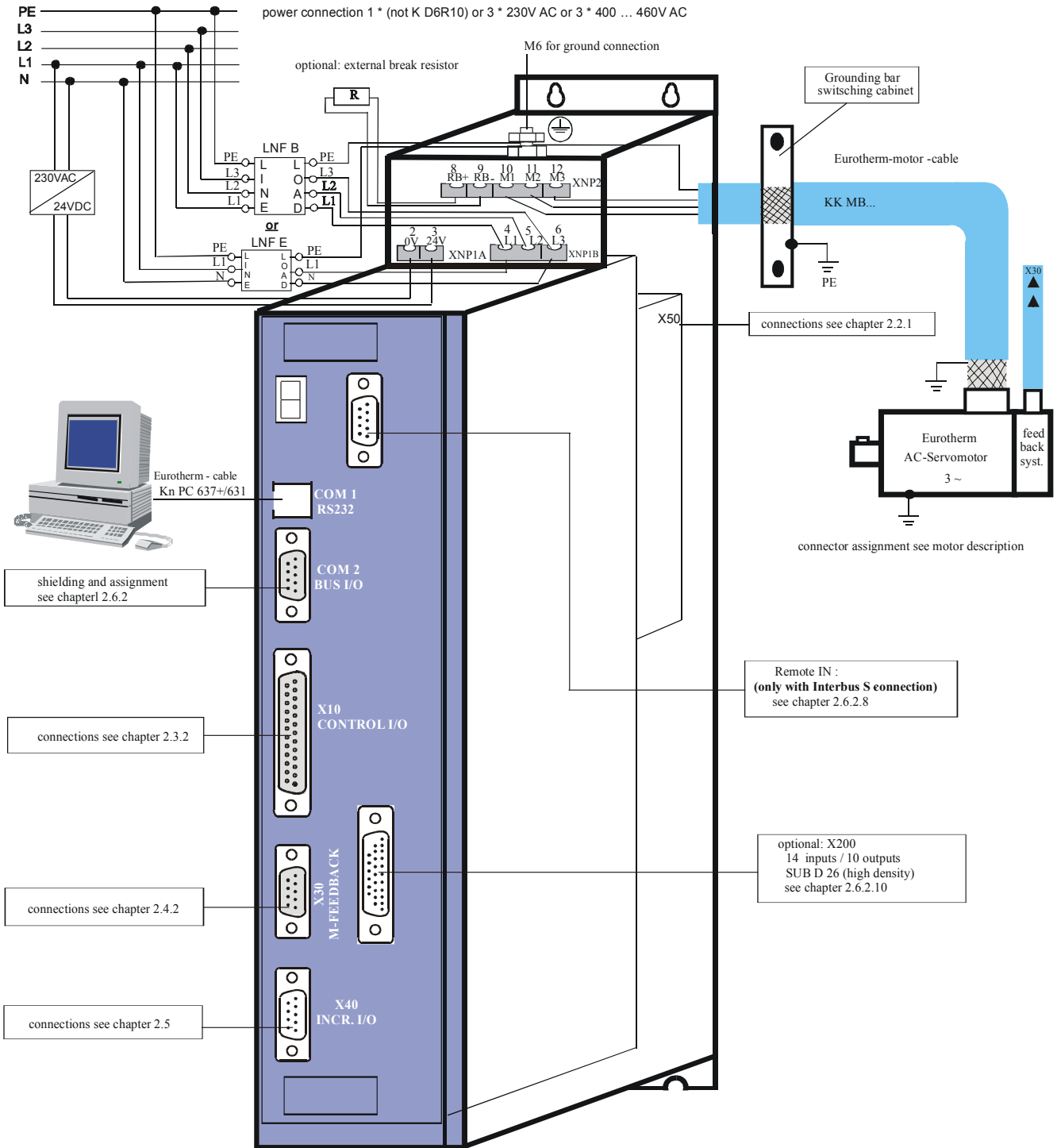

Connector assignment and functions

2.1.2 General view of connections of the compact device 637+/K D6R 16...30 Width 20 HP

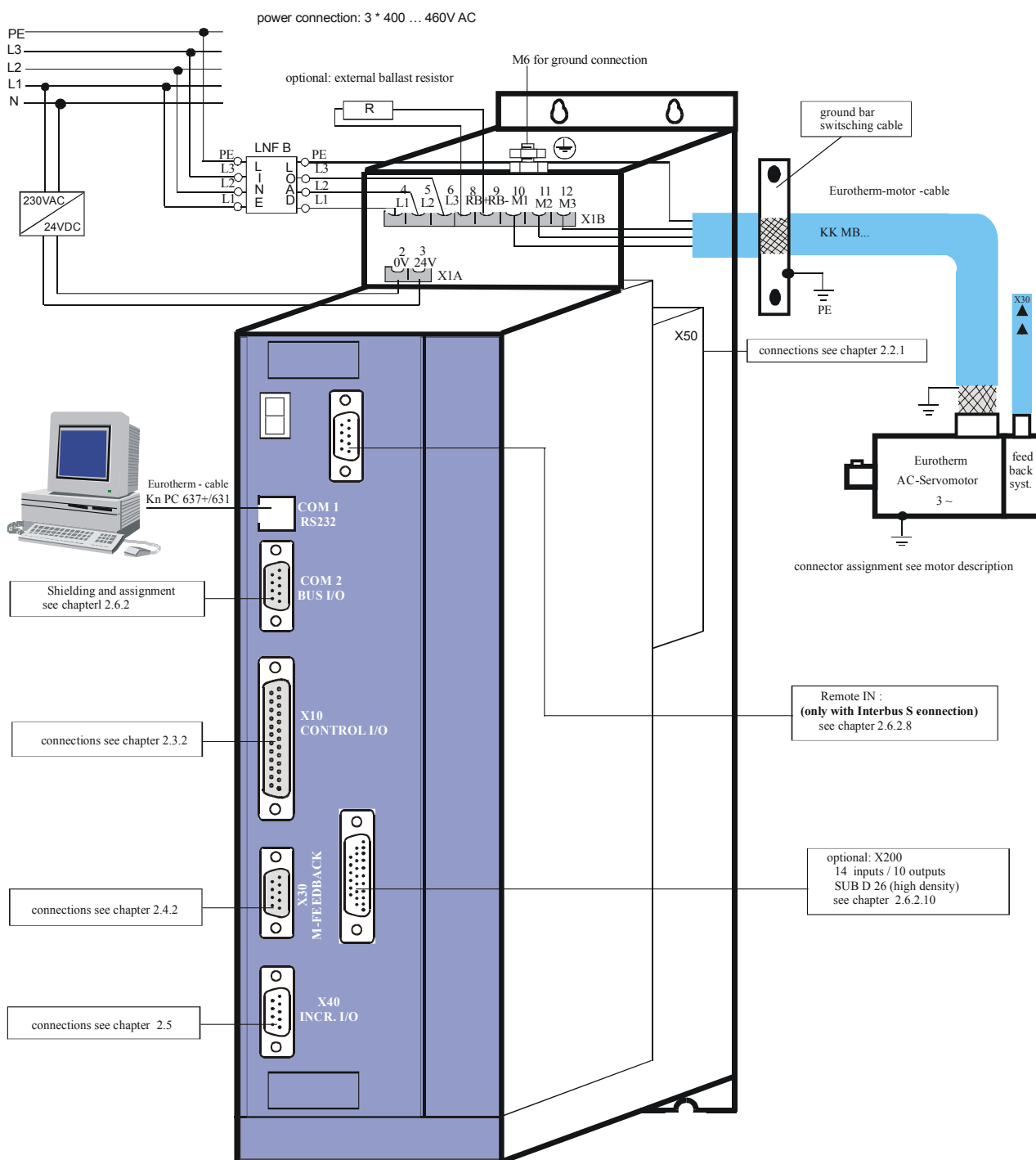

Connector assignment and functions

2.2 Connector pin assignments and contact functions

2.2.1 Power connections for plug-in module 637+/D6R

(at the rear of the rack)

(H15-multiple pin strip according to DIN 41612)

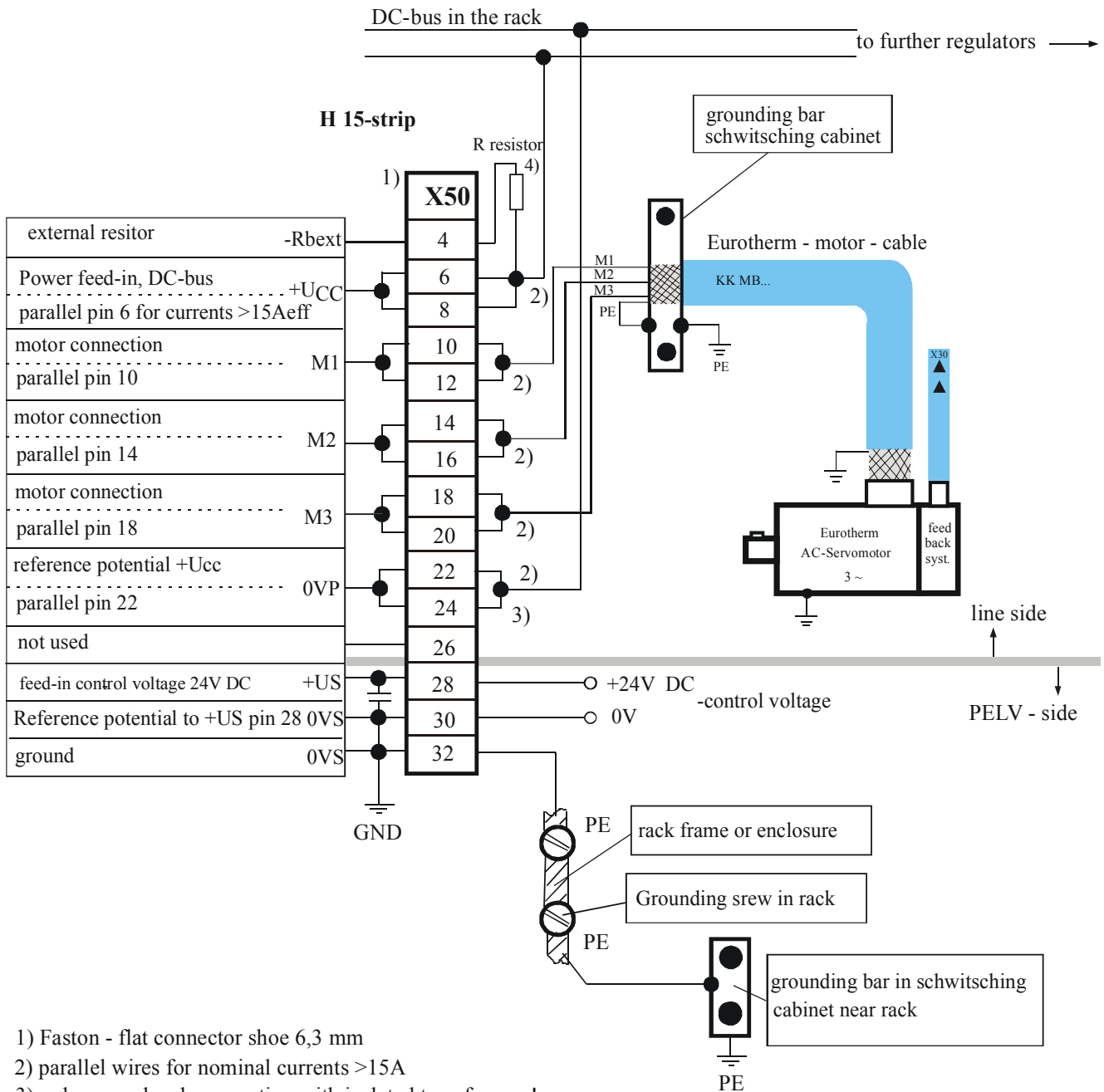

1) Faston - flat connector shoe 6,3 mm

2) parallel wires for nominal currents >15A

3) only ground wehn operating with isolated transformer !

Do not ground wehn operating with autotransformer or directly on mains!

4) resistor, provided that not from power unit NEB ... accessed

Connector assignment and functions

2.3.1 Signal connections

2.3.2 Control signal plug X10 SUB D25 socket

Complete representation X10

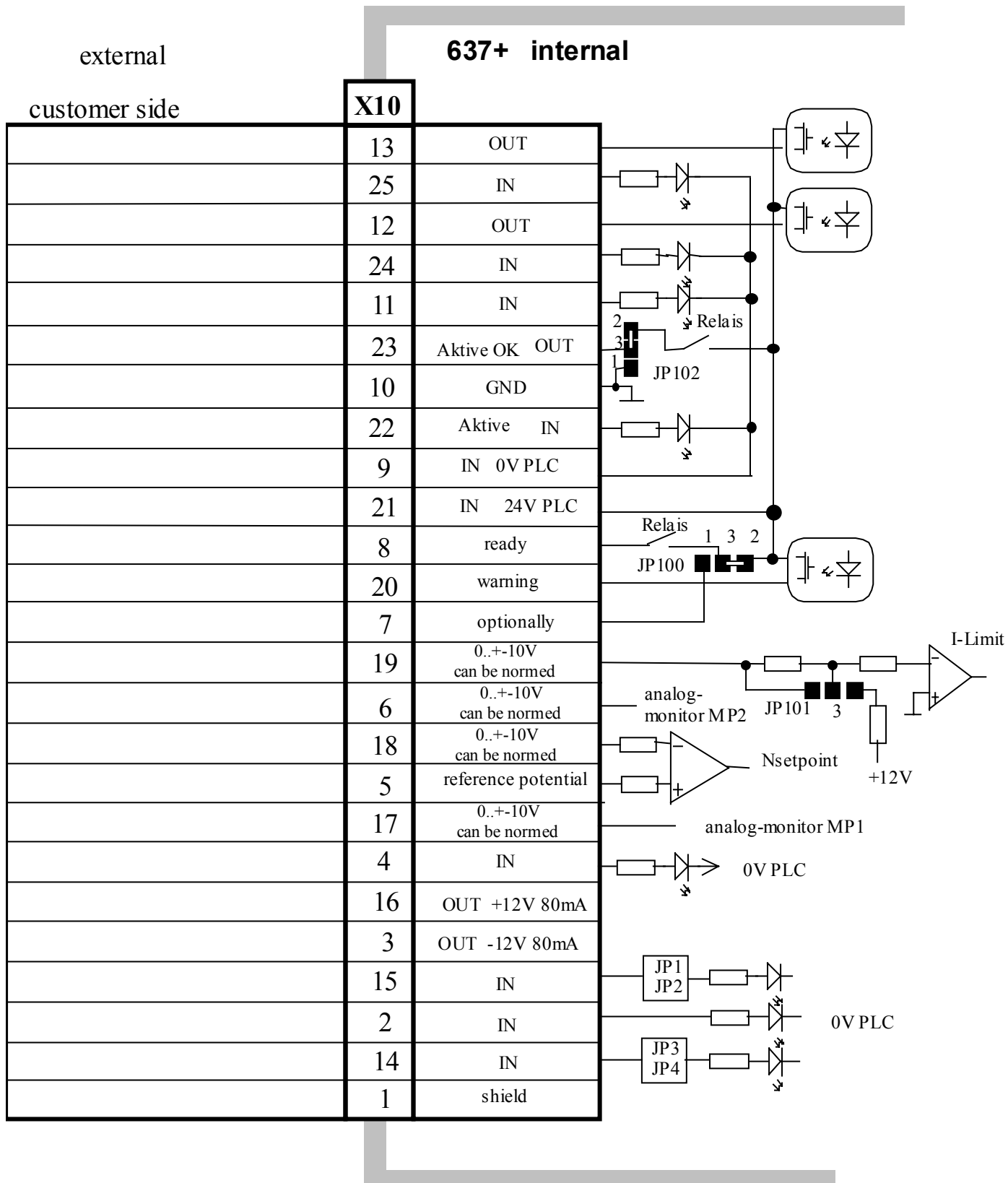

Connector assignment and functions

Signal connections

Control signal plug X10
SUB D25 socket

Connection example

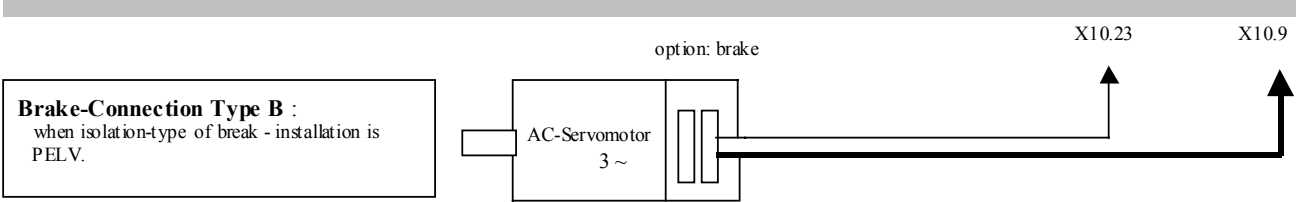
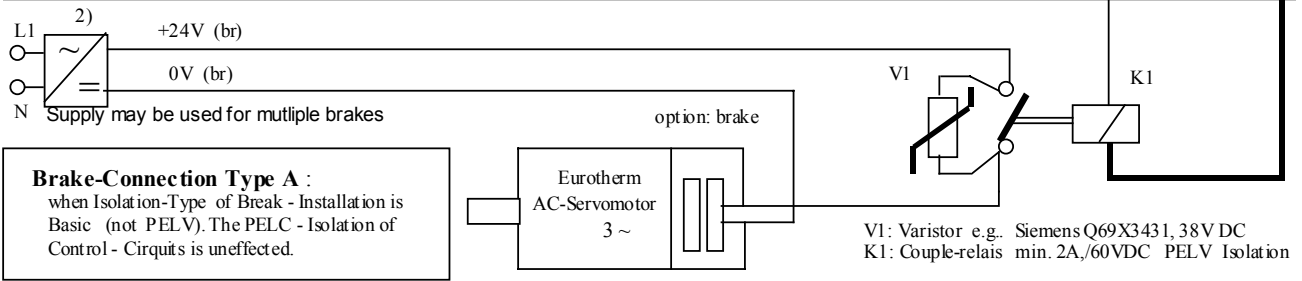
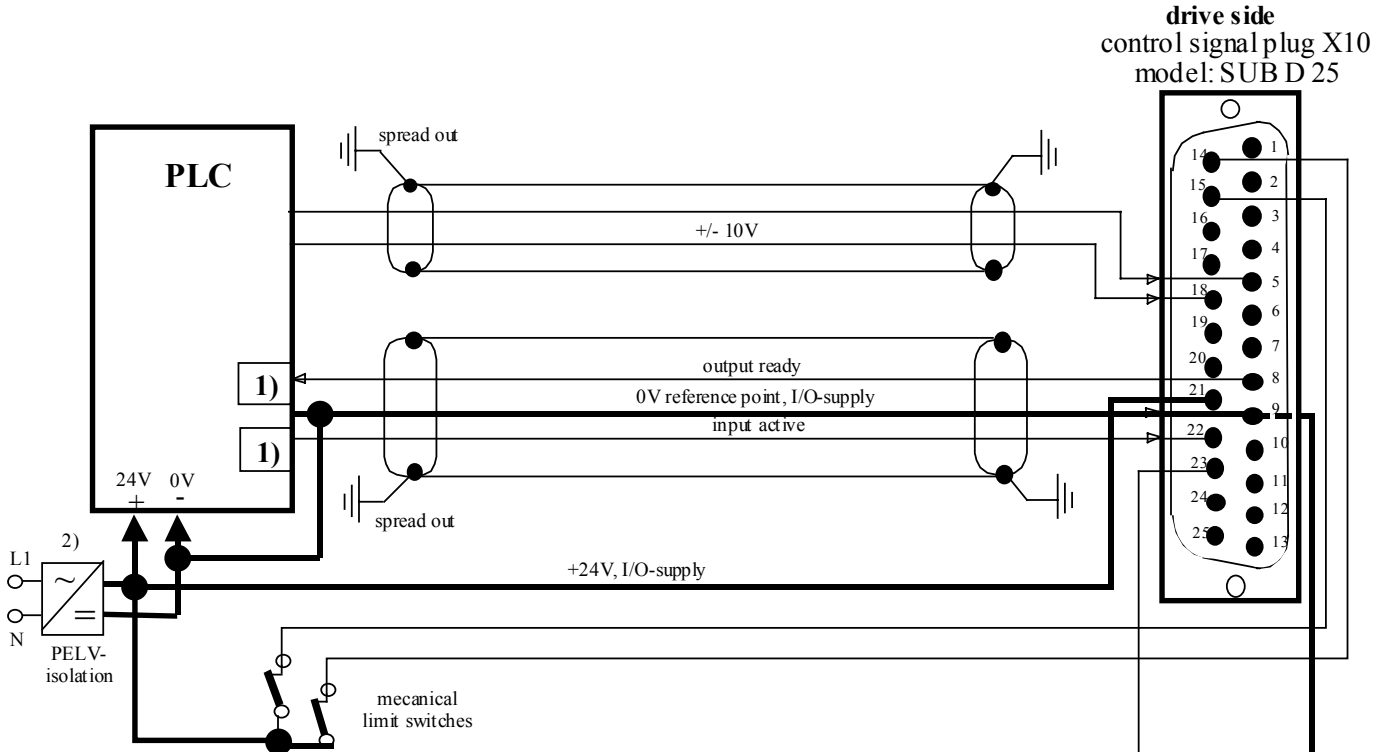

1) Security- and supervising logic, to be programmed by user !

2) **IMPORTANT:**

The Power-Supply for the Motor-Brake has to be adapted to the type of Brake. Voltage-Drops caused by long cables also may effect malfunctions of the Brake

Connector assignment and functions

Signal connections

Control signal plug X10

SUB D25 socket

Inputs / outputs

PIN	Function	Model	In- / output
1	shield connector		Shield
2	configurable (chapter 3)	OPTO	Input
3	stabilized auxiliary voltage -12VDC; max. 80 mA		output auxiliary voltage
4	configurable (chapter 3)	OPTO	Input
5	Reference point to X10.18		analog input 0...+-10V Ri = 10 kOhm
6	Current monitor can be scaled in the speed controller menu		MP2 analog output, 0...+-10V
7	via JP100 (solder jumper) can be assigned as free and loopable potential of the READY contact		Optional
8	ON: regulator without fault OUT: regulator fault or supply voltage off	Relay	Output fixed: ready
9	Reference point for digital inputs		Reference point for digital inputs
10	Reference potential for analog signals		Ground
11	configurable (chapter 3)	OPTO	Input
12	configurable (chapter 3)	OPTO	Output
13	configurable (chapter 3)	OPTO	Output
14	configurable (chapter 3)	OPTO	Input
15	configurable (chapter 3)	OPTO	Input
16	stabilized auxiliary voltage +12V DC; max 80 mA		output auxiliary voltage
17	actual speed value monitor, scalable		MP1 analog output, 0...+-10V
18	nominal speed value; scalable differential referenced to X10.5		Analog input 0...+-10V Ri = 10 kOhm
19	Setting of the current limit can be activated and scaled (0..+10V for 0.. I _{max})		analog input 0..+10V Ri = 10 kOhm
20	configurable (chapter 3)	OPTO	Output
21	Nominal: 24V DC		Supply for outputs
22	H = output stage is active L = output stage inactive	OPTO	input fixed: active
23	configurable (chapter 3)	Relay	output
24	configurable (chapter 3)	OPTO	input
25	configurable (chapter 3)	OPTO	input

Data of the digital inputs and outputs see chapter 11 General technical data



Connector assignment and functions

2.4 Feedback-Sensor-Connection X30

The Feedback-System generates a digital value, representing the rotor-position

Derivated from this value:

- commutation according to pole pair number
- actual speed value
- position value for position regulation

2.4.1 Function-Module X300

The Connector X30 is directly related to the Function-Module X300. This Plug-In – Module (see chapter 1.4.3.1) determines the type of usable Feedback-System.

The 637+ - Drive-System receives flexibility and is adaptable to future requirements.

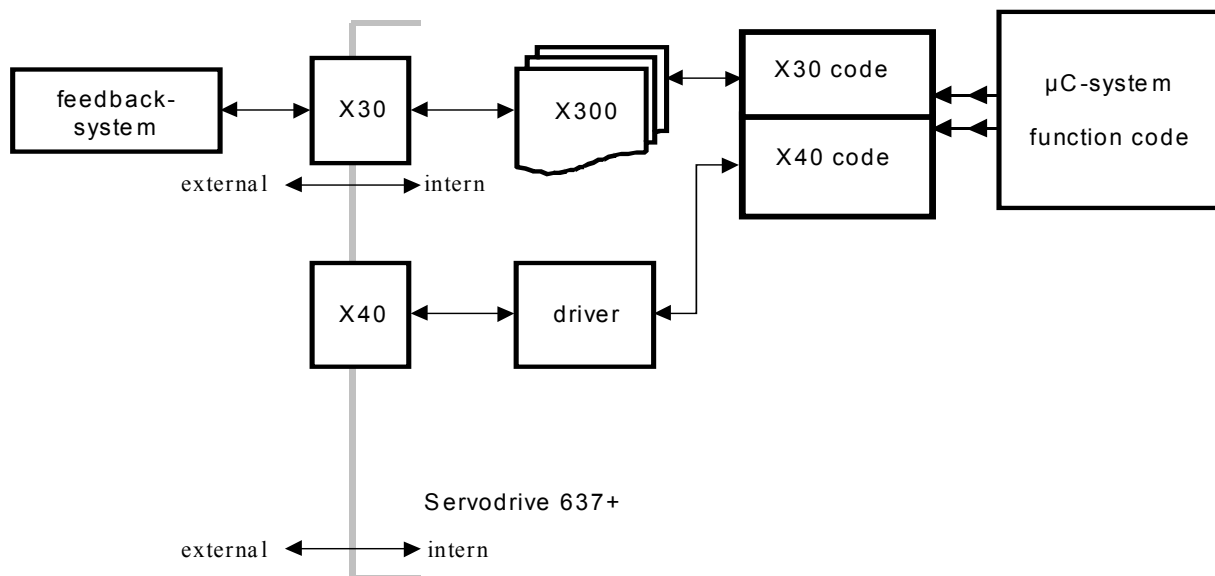

Typen X300:

X300_RD2: standard Resolver

X300_HF2: option HIPERFACE®

Further models on request

Plug and Play

The 637+ identify the model of the module's X300.

The EASYRIDER® Windows – Software loadet the corrcet function code.

You follow the instruction into EASYRIDER® Windows – Software

At function modul RD2 is the fuction code installet (factory default).

Hints:

The application with the function – modul X300_HF2 (HIPERFACE®) please observe Documentation 07-02-09-02-D-V0002.

Connector assignment and functions

Feedback-Sensor-Connection X30

2.4.2 Resolver connection X30

SUB D 09 socket

Required Function-Module: X300_RD2 (Standard)

Use only Eurotherm approved resolvers

Resolver connector

<p style="text-align: center;">motor side</p> <p>Eurotherm - motor size 0...4</p> <p>Model: AC <u>G</u>, AC <u>R</u>, AC <u>M_n</u>, AC <u>M_{2n}</u></p>	<p style="text-align: center;">regulator side</p> <p>Eurotherm - servo drives</p> <p>Model: 631/635 and 637/637+</p>
--	---

view solderside

view solderside

SIR ST.0200.0001	KIR-B KA.0003.6301			SUB - D 09 S/M ST.1002.2001
PIN - Nr.	colour	function		PIN - Nr.
1	white	sin +		4
2	brown	sin -		8
3	green	cos +		3
4	yellow	cos -		7
5	red	PTC optional	¹⁾	2
6	blue	PTC optional	¹⁾	6
7	pink	carrier -		9
8	gray	carrier +		5
case		screen		1 and case

¹⁾ **Attention ! Security and insulation:**
The temperature sensor in the motor winding must be insulated for secure division (PELV). Otherwise, the insulation class of the drive becomes reduced or the effort of an additional galvanic separation is required.

 EUROTHERM ANTRIEBE				Maßstab / scale: Typ / model: KK RT GMR-xx.x/B	
		Bear.	09.05.01	DL	Bezeichnung / designation: Blue resolver cable for Eurotherm standard motors and servo drives
		Gep.	10.05.01	EH	
		Norm			
				Zeichnungsnummer / drawing No: Z-RK.6300.xxxx	
				Blatt sheet 1	
Zust.	Änderung	Datum	Name	Ursprung	Dateiname / File name: Z-RK.6300.xxxx_E.cdr



Connector assignment and functions

2.5 Multi-function X40

Description X40

Via a programmable I/O processor, the X40 – Connection can be configured different.
(EASYRIDER® Windows - Software)

Standard functions:

- Incremental output
- Incremental input
- Stepper motor - pulse input
- SSI – Interface (under preparation)

The different configuration creates e.g. ideal conditions for synchronous applications.

General data	X40
Plug model:	SUB D 09 male plug
maximum input or output frequency:	200 kHz
maximum cable length connected to galvanical insulated terminals (Encoder, controls)	25 m; for extended distances please contact our engineer
maximum cable length connected to ground-related terminals (other drives, controls)	2 m, take care for good common grounding !
maximum number of signal inputs to one as incremental-output configured device	8
output signals:	driver model MC34C87 or compatible, RS422
differential logic level:	$L \leq 0,5V$ $H \geq 2,5V$
nominal range:	0,0 ... 5,0V
input signals:	receiver model MC34C86 or compatible, RS422
differential input level:	diff min = 0,2V
nominal range:	0,0 ... 5,0V
nominal signal difference:	1,0V
current consumption:	1...4 mA (depending on frequency)

Notice:

Master / Slave operation

1 Master maximum 8 Slaves

Condition: Devices directly side by side !

Connector assignment and functions

Multi-function X40

2.5.1 Incremental output

Connector pin assignment X40

EASYRIDER® Windows - Software X40 Modus = 0

- Incremental encoder simulation for processing in positioning modules
- Standard: 1024 increments
further selectable pulse numbers: 2048, 512, 256, 128, 64, 4096 (ab Firmware 6.15)

Pin	Function	Designation
1	Channel B	B
2	Channel B inverted	/B
3	Shield connector	Shield
4	Channel A	A
5	Channel A inverted	/A
6	Reference *	GND
7	Channel Z inverted zero impulse	/Z
8	Channel Z, zero impulse	Z
9	Supply voltage output max. 150 mA	+ 5 VDC

Design rule:

The capability of input-frequency of any connected device must meet at least the value of pulse outputs on X40..

n = max. speed (rpm)

x = increments e.g. 1024

f = output frequency at X40.1,2,4,5

$$\text{Formula: } f = \frac{1,2 * (n * x)}{60} = [\text{Hz}]$$

Example: n = 4000 1/min

$$f = \frac{1,2 * (4000 * 1024)}{60} = 81920 \text{ Hz}$$

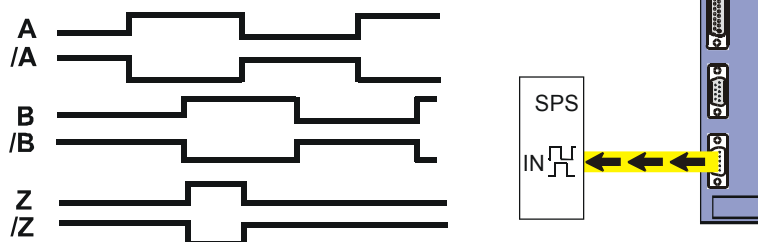

Incremental outputs



Connector assignment and functions

Multi-function X40

2.5.2 Incremental input

EASYRIDER[®] Windows - Software X40 Modus = 1

Parameter area of the input signals:

10...1000000 increments

Pin	Function	Designation
1	Channel B	B
2	Channel B inverted	/B
3	Shield connector	Shield
4	Channel A	A
5	Channel A inverted	/A
6	Reference potential *	GND
7	Channel Z inverted zero impulse	/Z
8	Channel Z, zero impulse	Z
9	Supply voltage output max. 150 mA	+5 VDC

Note:

The operation of incremental encoders via long cables may cause a voltage drop of the encoder power supply. We suggest the use of external supply if necessary.

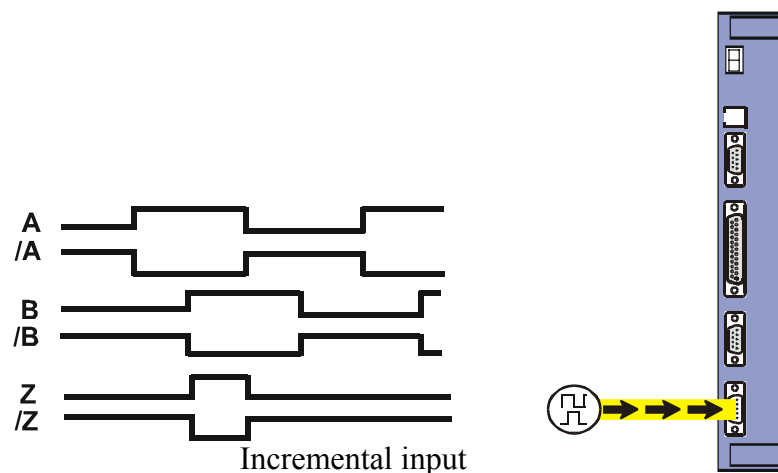

Connector assignment and functions

Multi-function X40

2.5.3 Stepper motor input

pulse / direction

EASYSRIDER® Windows - Software X40 Modus = 2

Pin	Function	Designation
1	output: drive active inverted	/READY
2	output: drive active	READY
3	Shield connector	Shield
4	Pulse inverted	/P
5	Pulse	P
6	Reference potential	GND
7	Direction inverted	/R
8	Direction	R
9	Supply voltage output max. 150 mA	+5 VDC

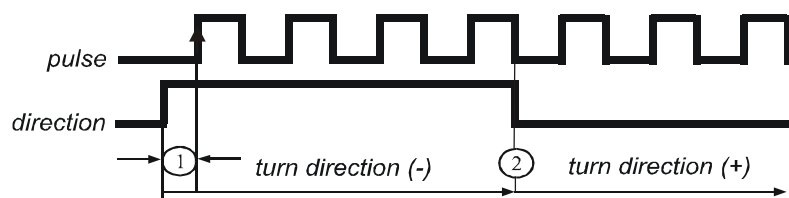

① set-up time $\geq 2,5 \mu\text{s}$

② hold time = 0

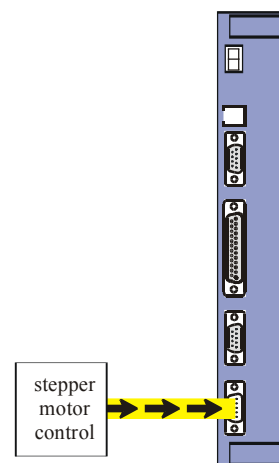



Connector assignment and functions

Multi-function X40

2.5.4 Stepper motor input

pulse positive / negative

EASYSRIDER® Windows - Software X40 Modus = 3

Pin	Function	Designation
1	output: drive active inverted	/READY
2	output: drive active	READY
3	Shield connector	Shield
4	Pulse direction (-) inverted	/P-
5	Pulse direction (-)	P-
6	Reference potential	GND
7	Pulse direction (+) inverted	/P+
8	Pulse direction (+)	P+
9	Supply voltage output max. 150 mA	+5 VDC

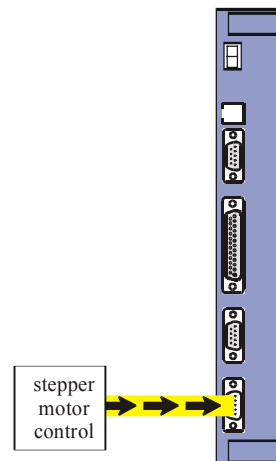
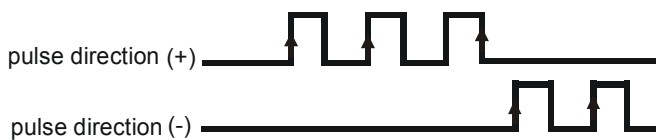

Connector assignment and functions

Multi-function X40

2.5.5 SSI-Encoder Interface (under preparation)

EASYRIDER® Windows - Software X40 Modus = 4 (13 bit)

EASYRIDER® Windows - Software X40 Modus = 5 (25 bit)

PIN	Function	Designation
1	serial Data from SSI-Encoder, GRAY-Code up to 25 bit Inverted	/DATA
2	serial Data from SSI-Encoder GRAY-Code up to 25 bit	DATA
3	Shield connector	Shield
4	Clock-Output, inverted Standard-Frequency: 208 kHz	/TAKT
5	Clock-Output Standard-Frequency: 208 kHz	TAKT
6	Reference potential	GND
7	do not connect	
8	Output to Encoder: Countdirection, Low = Clockwise	CCW
9	Supply voltage output max. 150 mA If other Data required: a) Use of X300-Module b) External Supply	+5 VDC

TAKT and /TAKT twisted pair

DATA and /DATA twisted pair

Cable screened, Screen connected to Ground at both sides

max Cable-Length: 250m

Note:

For further informations about SSI (Synchronous Serial-Interface), please refer to the documetations of appropriate suppliers.

(e.g.: Stegmann or TWK)

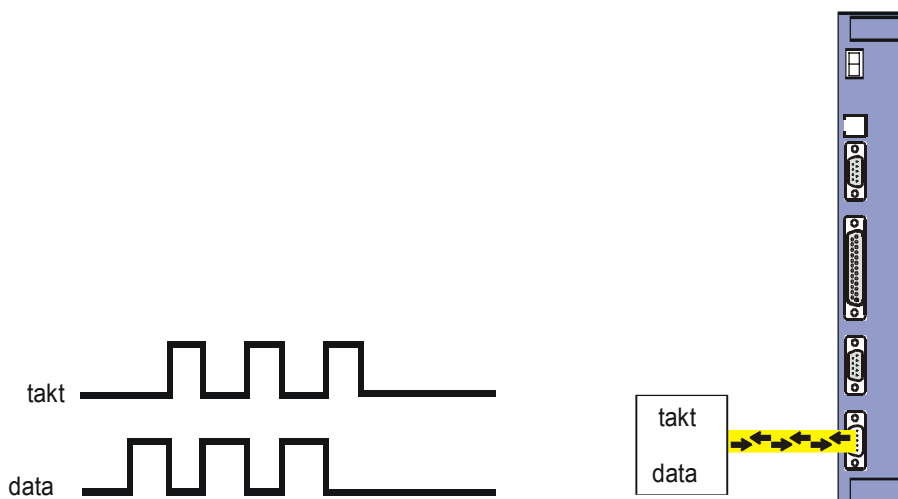



Connector assignment and functions

2.6 Digital interfaces

2.6.1 Service interface COM1 (RS232) standard

Functions:

- Supporting all diagnosis and setup tasks
- Connection to your PC is made with the Eurotherm communication cable KnPC/D
- Communication is made via the Eurotherm operating program (EASYRIDER® Windows - Software)

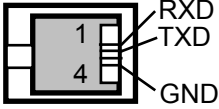
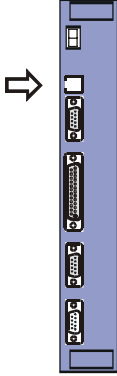
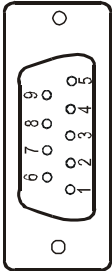
Com RS232	PIN	Function drive side	PIN	RS232 PC-Side
4-pole Modular-Jack 				SUB D 09- socket (View to solder-side) 
RXD	1	Receive Serial Data	3	TXD
TXD	2	Transmit Serial Data	2	RXD
	3	Do not connect		
GND	4	GND	5	GND

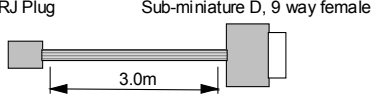
Cable Ready for Use: RS232 Service- Connector	model	Order Number.	
Drive → PC	Kn PC 637+/631 – 03.0	KK.5004.0003	

Notice:

The service interface RS232 is not galvanically separated and should not be planned for this reason as a operating interface ("firm wiring")!

The Line-Connection of the PC must be close to the Drive to achieve operation related to a common ground.

Connector assignment and functions

Digital interfaces

2.6.2 Fieldbus interface COM2

Option module (SUB D09 socket)

Many different functions can be implemented using optional option module.

Layout, see chapter 1.4.3

Overview:

modul- designation	interface	galvanic seperation	design
RP 232	RS 232	-	A
RP 422	RS 422/485	-	A
RP 485	RS 422/485	X	A
RP CAN	CAN	X	A
RP PDP	Profibus DP	X	B
RP SUC	SUCOnet K	X	B
RP IBS	¹⁾ Interbus S	X	B
RP DEV	DeviceNet	X	B

¹⁾ additional plug Interbus Rem. IN (SUB D)

2.6.2.1 additional In-/Outputs

modul- designation	Inputs	Outputs	connection via	design
RP EA5	²⁾ 5	2	COM2	B
RP EAE	14	10	X200	C

²⁾ no Fieldbus possibility (Interface)

Caution:

The connections COM2 and X30 are implemented via SUB D09 socket.

The customer have to be guaranteed that an interchanging is not possible!

The solderring jumper JP2.8, 2.3, 2.7, 2.2 have to switched dependent on Configuration Interface.
See chapter 7.1 (in plant adjusted)



Connector assignment and functions

Digital interfaces

2.6.2.2 Modul – design

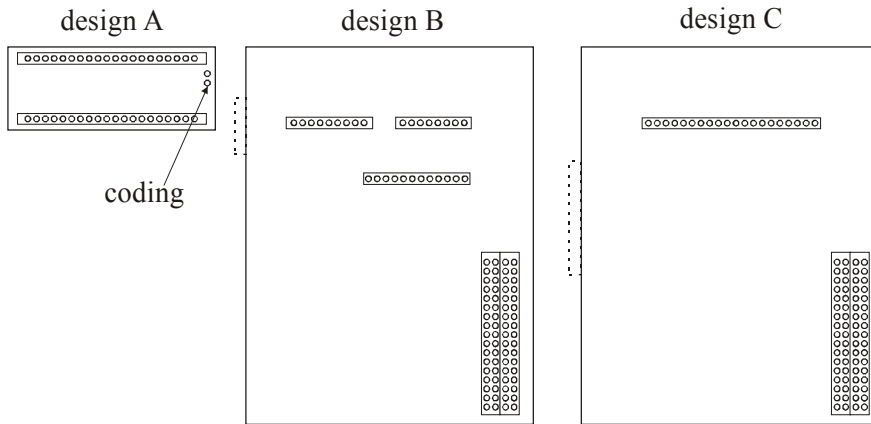

2.6.2.3 Pin assignment for RS232 with option modul RP 232

pin	assignment as RS232
1	-
2	RXD
3	TXD
4	-
5	GND
6	-
7	-
8	-
9	-

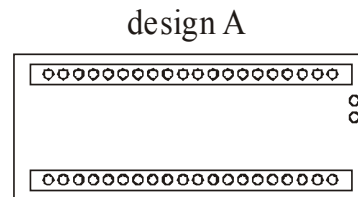

2.6.2.4 Pin assignment for RS422/485 with option modul RP 422, without galvanic separation with option modul RP 485, with galvanic separation

pin	assignment as RS422/485
1	-
2	-
3	-
4	Data In
5	GND
6	Data In inverted
7	Data Out inverted
8	Data Out
9	-

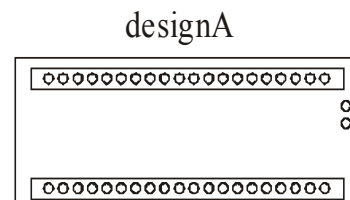

Daisy-chain wiring up to 16 devices

Connector assignment and functions

Digital interfaces

2.6.2.5 Pin assignment for CAN/DeviceNet with option modul **RP CAN**, with galvanic separation

pin	description	designation
1	-	-
2	CAN_L bus line (dominant low)	CAN_L
3	Ground	GND
4	-	-
5	-	-
6	optional ground	GND
7	CAN_H bus line (dominant high)	CAN_H
8	-	-
9	-	-

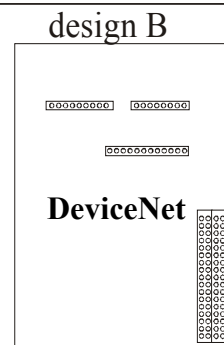
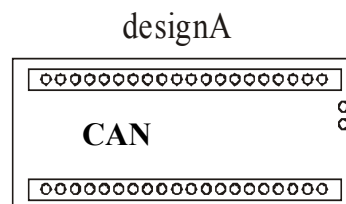

2.6.2.6 Pin assignment for Profibus DP with option modul **RP PDP**, with galvanic separation

pin	description	designation
1	-	-
2	-	-
3	Line B	B
4	Request to send	RTS
5	Ground	GND
6	Potential +5V	+5V
7	-	-
8	Line A	A
9	-	-

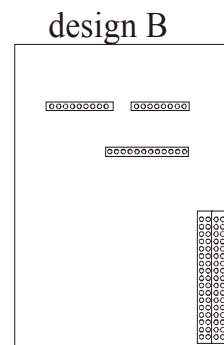

2.6.2.7 Pin assignment for SUCOnet K with optionsmodul **RP SUC**, with galvanic separation

pin	description	designation
1	-	-
2	-	-
3	Data line +	TA/RA
4	-	-
5	Signal ground	SGND
6	-	-
7	Data line -	TB/RB
8	-	-
9	-	-

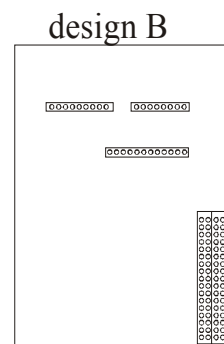

Connector assignment and functions

Digital interfaces

2.6.2.8 Pin assignment for Interbus S

with option modul RP IBS, with galvanic separation

Remote OUT (COM2)

Remote OUT (SUB D09 socket)

com 2	description	designation
1	Data line OUT forward (error voltage A)	DO2
2	Data line IN backward (error voltage A)	DI2
3	Reference potential	GND I
4	-	-
5	VCCI	+5V
6	Data line OUT forward (error voltage B)	/DO2
7	Data line IN backward (error voltage B)	/DI2
8	-	-
9	Reporting input *	RBST

design B

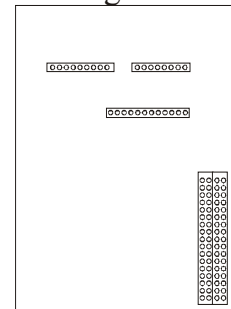

* to forward Interbus-S interface

Remote IN

Remote IN (SUB D09 plug)

≅ additional plug

remote IN	description	designation
1	Data line IN forward (error voltage A)	DO1
2	Data line OUT backward (error voltage A)	DI1
3	Reference potential	GND I
4	-	-
5	-	-
6	Data line IN forward (error voltage B)	/DO1
7	Data line OUT backward (error voltage B)	/DI1
8	-	-
9	-	-

design B

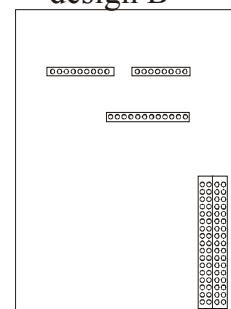

Attention: specific front panel is required !

Connector assignment and functions

Digital interfaces

2.6.2.9 Pin assignment for I/O interface

with option modul RP EA5, with galvanic separation

Digitale I/O Option

COM2 SUB D09 socket

(I = input; O = output)

com 2	designation	comment	status
1	BIAS input 101	standard	E
2	BIAS input 102	standard	E
3	BIAS input 107	standard	E
4	BIAS input 108	standard	E
5	0VSPS	ground reference 0VSPS	B
6	BIAS input 106	standard	E
7	BIAS output 109	standard	A
8	BIAS output 110	standard	A
9	+24VSPS	ext. +24V feed-in	UB

design B

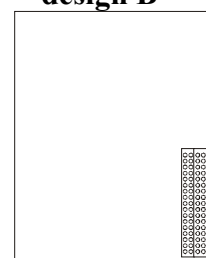

Notice !!

The input's with the internal number 107 and 108 must be connected to the pin's with number 3 and 4.
The output's with the internal number 109 and 110 must be connected to the pin's with number 7 and 8.



Connector assignment and functions

Digital interfaces

2.6.2.10 Pin assignment for I/O interface

with option modul RP EAE, with galvanic separation

Digital I/O option

X200 SUB D26 high density socket

(I = input; O = output)

X200	Designation	comment	status
1	Bias input 201	standard	E
2	Bias input 202	standard	E
3	Bias input 203	standard	E
4	Bias input 204	standard	E
5	Bias input 205	standard	E
6	Bias input 206	standard	E
7	Bias input 207	standard	E
8	Bias input 208	standard	E
9	Bias output 209	standard	A
10	Bias output 210	standard	A
11	Bias input 211	standard	E
12	Bias input 212	standard	E
13	Bias input 213	standard	E
14	Bias input 214	standard	E
15	Bias input 215	standard	E
16	Bias input 216	standard	E
17	Bias output 217	standard	A
18	Bias output 218	standard	A
19	Bias output 219	standard	A
20	Bias output 220	standard	A
21	Bias output 221	standard	A
22	Bias output 222	standard	A
23	Bias output 223	standard	A
24	Bias output 224	standard	A
25	+24 V SPS	Ext. +24 V feed-in	Ub
26	0 V SPS	Ground reference 0 V SPS	B

design C

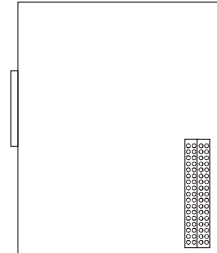

3 Operating modes

The preselection of the device functions is carried out by choosing the operating modes 0...5 according to the following table, see **chapter 3.1**, (EASYRIDER® Windows - Software).

Each operating mode allows the assignment of different in- and output functions (F0..F5).

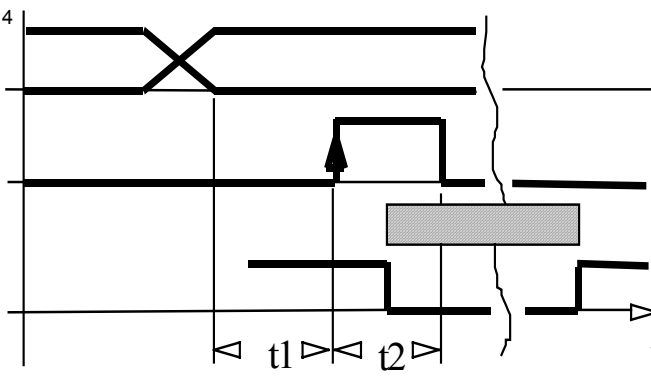
Betriebsart	Sollwertquelle	Hinweise zur Auswahl der Betriebsart
0 1 2	analog (X10.5/18)	switchable the operating modes 1 and 2 by input X10.24 speed control analog torque controller analog
3	analog (X10.5/18) / digital	simple applications with requirement of switching between position and speed control position controller (input X10.24) handling like operating mode 4
4	digital or analog in acc. to parameter set	general position-controlled systems. Up to 10 positions can be stored under identifier-numbers and activated like shown.
pos. selection (Nr 0..9)	function F2 datd 2 ⁰ ...2 ⁴	 <p>The diagram shows a sequence of events: 1. pos. selection (Nr 0..9) changes from 0 to 4. 2. input start (function F2 X10.2) goes high. 3. axis moves to selected position-number, indicated by a shaded box. 4. output position reached (function F0 X10.12) goes high. Delays t1 and t2 are marked between the start of the axis movement and the output position reached signal.</p>
input start	function F2 X10.2	
axis moves to selected position-number		
output position reached	function F0 X10.12	
t1 = 2 ms minimum	t2 = 2 ms minimum	
5	digital or analog in acc. to programming or via digital communication (e.g. fieldbus)	simple to complex systems using instructions BIAS (up to 1500 command blocks) PLC - functions for further informations: see chapter 13.1 and 13.2



Operating modes

3.1 Operating modes and pin functions

	operating modes					
Available pins number	0 torque / speed-control	1 speed control	2 torque control	3 position / speed-control	4 position control	5 position control + BIAS functions
input X10.14	F0, F1	F0, F1	F0, F1	F0, F1, F2, F3	F0, F1, F2, F3	F0, F1, F2
input X10.15	F0, F1	F0, F1	F0, F1	F0, F1, F2, F3	F0, F1, F2, F3	F0, F1, F2
input X10.4	---	---	---	---	F2	F0, F2, F3
input X10.25	---	---	---	---	F2	F0, F2, F3
input X10.11	F1	F1	F1	F1	F1, F2	F0, F1, F2, F3
input X10.24	F0 L = torque- H = speed control	---	---	F0 L = torque- H = speed control	F1, F2	F1, F2, F3
input X10.2	---	---	---	---	F0	F2, F3

output X10.12	F0, F2, F5	F0, F2, F5	F0, F2, F5	F0, F1, F3, F5	F0, F1, F3, F5	F0, F1, F2, F3, F4, F5
output X10.13	F0, F2, F5	F0, F2, F5	F0, F2, F5	F0, F1, F3, F5	F0, F1, F3, F5	F0, F1, F2, F3, F4, F5
output X10.20	F0, F2, F5	F0, F2, F5	F0, F2, F5	F0, F1, F3, F5	F0, F1, F3, F5	F0, F1, F2, F3, F4, F5
output X10.23	F0, F2, F5	F0, F2, F5	F0, F2, F5	F0, F1, F3, F5	F0, F1, F3, F5	F0, F1, F2, F3, F4, F5

The assignment of the functions F0..F5 is listed in the following table

Operating modes

3.2 Configurable pin-functions (depending on the operating mode)

	Input functions (depending on the operating modes)					
input Nr.	function F0	function F1	function F2	function F3	function F4	function F5
input X10.14	☒	limit switch +	*) set selection data 2^0	move manually +	☒	☒
input X10.15	☒	limit switch -	*) set selection data 2^a	move manually -	☒	☒
input X10.4	⏏	extended latch	*) set selection data 2^b	☒	☒	☒
input X10.25	⏏	☒	*) set selection data 2^c	☒	☒	☒
input X10.11	start (slope 0-->1) for BIAS -move commands	regulator trouble reset	*) set selection data 2^d	☒	☒	☒
input X10.24	operating mode selection (0) – 1 or 2 (3) – 1 or 4	reference sensor	*) set selection data 2^{\max}	☒	☒	☒
input X10.2	start (slope 0-->1) with position set selection in position control (4)	☒	strobe (slope 0-->1) for BIAS-set selection	☒	☒	☒

output X10.12	position reached	reference output	☒	tracking window exceeded	synchron-format trigger	non regulator trouble
output X10.13	temperature monitoring	reference output	☒	tracking window exceeded	start offset trigger	non regulator trouble
output X10.20	warning	reference output	☒	tracking window exceeded	☒	non regulator trouble
output X10.23	active ok (motor brake)	reference output	☒	tracking window exceeded	☒	non regulator trouble

☒ BIAS-function, free programmable.(in operating mode 5) resp. no function in operating mode 0 at 4.

*) With every row (from the top to the bottom) in which the function F2 is assigned to an input, the binary value (2^n) increases by 1. (see example)

Operating mode 4: only permissible set number 0 - 9 !

⏏ fast input for optimal timing



Operating modes

3.3 Function diagrams from inputs and outputs

Fault signal / protection function	Protection mode switching off in acc. with EASYRIDER config.- menu	Protection mode limiting acc. with EASYRIDER config. menu
I²t regulator protection output Warning(F0) X10.20 output Ready X10.8 Warning display fault signal display		
I²t motor protection output Warning(F0) X10.20 output Ready X10.8 Warning display fault signal display		
NTC-output stage protection output Warning(F0) X10.20 output Ready X10.8 Warning display fault signal display		
assume motor temperature curve		
NTC-motor protection output Temp.(F0) X10.13 output Ready X10.8 Warning display fault signal display		
PTC-motor protection output Temp.(F0) X10.13 output Ready X10.8 Warning display fault signal display		<div style="border: 1px solid black; padding: 5px; text-align: center;"> no limiting function with PTC </div>
Function Passive -Delay (recommended by use of motor brake) input ACTIVE X10.22 setpoint internally to zero output stage Active output AKTIVE -OK(F0) X10.23 (holding brake)		

4 Mechanical installation

4.1 Mounting

Eurotherm digital servo drives may be installed only in a vertical position to guarantee the best air circulation for the cooling ribs of the heat sink. Vertical installation above other drive racks or above other heat producing devices can lead to overheating. In addition the drives are to be operated exclusively in Eurotherm racks or the compact enclosure respectively.

4.2 Control cabinet - mounting

Installation should be carried out only in a control cabinet in which the inside must be free from dust, corrosive fumes, gases, and all liquids.

Make absolutely sure that the condensing of evaporating liquids including atmospheric moisture, is avoided. Should the digital servo drive be installed in a place where condensation is likely, a suitable anticondensation heater must be installed. The heater must be SWITCHED OFF during normal operation.

Automatic switch off is recommended

Eurotherm-digital servo drives should not be installed in areas which have been classified as dangerous, if they have not been installed in an approved enclosure in accordance with regulations and checked.

Make sure, there is enough cooling and space ! (see sketch)

- only horizontal !
- on the side
no distance is required

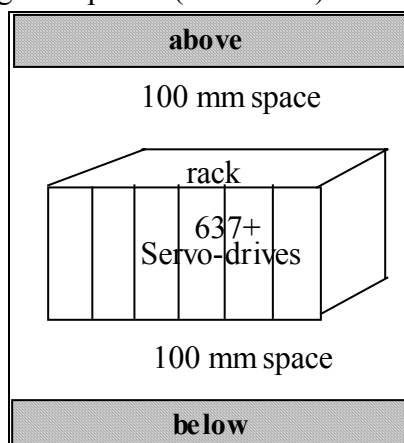

General rule:

It is better to place heat-producing devices low in an enclosure to support internal convection and to spread the heat. If placing such devices up high is unavoidable, enlarging the upper dimensions at the expense of height or installing fans should be considered.

4.3 Cooling

The digital servo drives are protected against damages caused by overheating.

There is a thermal sensor installed on the heat sink. When the temperature rises to $>95^{\circ}\text{C}$, the drive is automatically switched off. This setting cannot be changed.

Make sure a cabinet of proper size is selected for adequate air circulation

If the device becomes operated in a not ventilated device, the case volume of the specified control cabinet must be calculated in accordance with the following table !

Gerät	Volumen/Schaltschrank
637+/D6R02...D6R10	0,12 m ³
637+/D6R16...D6R30	0,25 m ³

For more exact information, please, address to the control-cabinet manufacture



5 Electrical installation

5.1 Safety

The voltages carried by power supply cables, motor cables, connectors, and certain parts of the drive can cause serious electric shocks and even death

5.2 The danger of electric shocks



CAUTION !

Risk of electrical shock, wait 3 minutes after switching off, for discharging the capacitors.

Disconnect Eurotherm plug-in units from mains before working on them. A period of **three** minutes **must** pass after switching off so that the internal capacitors can discharge completely. Until the discharge time is over, there can be dangerous voltages in the module !

Persons, which monitoring or carrying out electrical installation and maintenance must be adequately qualified and schooled in these activities.

5.3 Danger areas

The use of variable speed drives of all kinds can invalidate the certification for dangerous areas (apparatus group and/or temperature class) of explosion-protected motors. Inspection and certification for the complete installation of servo motors and electronic components **must** be obtained.

5.4 Grounding, safety grounding

The grounding impedance must meet the requirements of local industrial safety regulations and should be inspected and checked at appropriate and regular intervals

5.4.1 Ground connections

It is recommended to attach a ground bus of high conductivity copper as near as possible to the servo-rack or regulator modules in order to minimize the length of the cable connections.

The recommended dimensions are:

Thickness: $d = 5$ to 6 mm

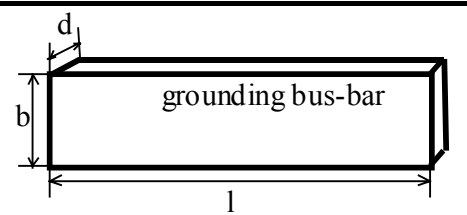
Length (m)	Width (mm)	
< 0,5	20	
0,5 < 1,0	40	
1,0 < 1,5	50	

Ways of raised discharge currents > DC 10mA resp. > AC 3,5mA the PE-Bolt of the drive has to be connected to PE using copper-cable minimum 10mm² !

5.5 Short-circuit capability and discharge currents

Due to the working-principle of servo drives there may discharge currents to PE exceeding DC 10mA resp. AC 3,5mA.

Suitable for use on a circuit capable of delivery not more than 5000 RMS symmetrical amperes 505V maximum. (Note according to UL508C)

Electrical installation

5.6 Fuses, contactors, filters

Compact units		637+/ KD6R 02	KD6R 04	KD6R 06	KD6R 10	KD6R 16	KD6R 22	KD6R 30
		.S4	.S4	.S4	.S4	.S4	.S4	.S4
		-3 -7	-3 -7	-3 -7	-3 -7	-7	-7	-7
Fuses, Contactors	4)							
RCD-switch		not recommended. Required setpoint: 300 mA, no protection against life danger						
mains input currents	[A]	3,5	5	7,5	12	19	26	30
mains protection	1) model	T10A	T10A	T10A	T20A	T25A	(T32A) 35A	(T32A) 35A
protector-switch	2) model	PKZM0-16	PKZM0-16	PKZM0-16	PKZM0-16	PKZM0-25	PKZ2/ZM32	PKZ2/ZM32
mains fuse	2) model	DIL 00M	DIL 00M	DIL 00M	DIL 00M	DIL 0M	DIL 0M	DIL 0M
Line filters	4)							
generall		only for use in earth referenced supplies(TN). Current drain to PE !						
single-phase								
industrial env. max. motor cable 50m (EN55011 A)	model	LNF E 1*230/012 up to AC 230V !! + ferrite core FR 3			not possible			
residential env. max. motor cable 20m (EN55011 B)	model	LNF E 1*230/012 up to AC 230V !! + ferrite core FR 3			not possible			
3-phase								
industrial env. max. motor cable 50m (EN55011 A)	model	LNF B 3*480/008 + ferrite core FR 3		LNF B 3*480/018 + ferrite core FR 6		LNF B 3*480/033 + ferrite core FR 6		
residential env. max motor cable 20m (EN55011 B)	model	LNF B 3*480/008 + ferrite core FR 3		LNF B 3*480/018 + ferrite core FR 3		LNF B 3*480/033 + ferrite core FR 3		
3-phasen, max. 3 Geräte versorgt durch einen gemeinsamen Filter								
industrial env. max. motor cable 20m (EN55011 A)	model	LNF B 3*480/018; LNF B *480/033 + ferrite core FR other models upon request (according to ref.measurements with 3 units, supplied by common line)						
residential env. max motor cable 20m (EN55011 B)	3) model	LNF B 3*480/018; LNF B 3*480/033 + ferrite core FR other models upon request (according to ref.measurements with 3 units, supplied by common line)						

Plug-in modules		637+ / D6R 02	D6R 04	D6R 06	D6R 10	D6R 16	D6R 22	D6R 30
		.S4	.S4	.S4	.S4	.S4	.S4	.S4
		-3 -7	-3 -7	-3 -7	-3 -7	-3 -7	-3 -7	-3 -7
Fuses, contactors, filters	4) 1)							
generall		Orientation: Table for compact units and the addition of rated currents of used units on the DC-Bus. Depending on the application, energy sharing effects by DC-link may reduce the required supply current considerable.						
fuses		Rule of the thumb: single-phase operation: 2...3 times of added rated currents Rule of the thumb: 3-phase operation: 1,5...2 times of added rated currents						
peak making currents		Depending on power-supply unit, limiting equipment is required (delay contactor)						
filters		only for use in earth referenced supplies(TN). Current drain to PE !						
filter models		Orientation: Table of compact units. Further models: see separate manual						

1) recommended for UL-requirements: Bussmann Type FRS-R, 600V, use only UL-approved fuse-holders !

2) recommended, Klöckner Moeller for instance

3) Measurement of conducted emissions only

4) for applications with continuous load: see notes in chapter 5.7



Electrical installation

5.7 Correction of supply current

Attention in case of continuous load:

Due to the capacitive input impedance of DC-Bus, the input current is deformed.

This guides to RMS -values higher than the sinus-based calculated values. Fuses, contactors and line filters have to be selected in respect to this effect.

In typical servo application with Stop/Go-operation (S3-Operation), the rating to nominal data will be sufficient.

In other cases, the value has to be corrected using the following diagram.

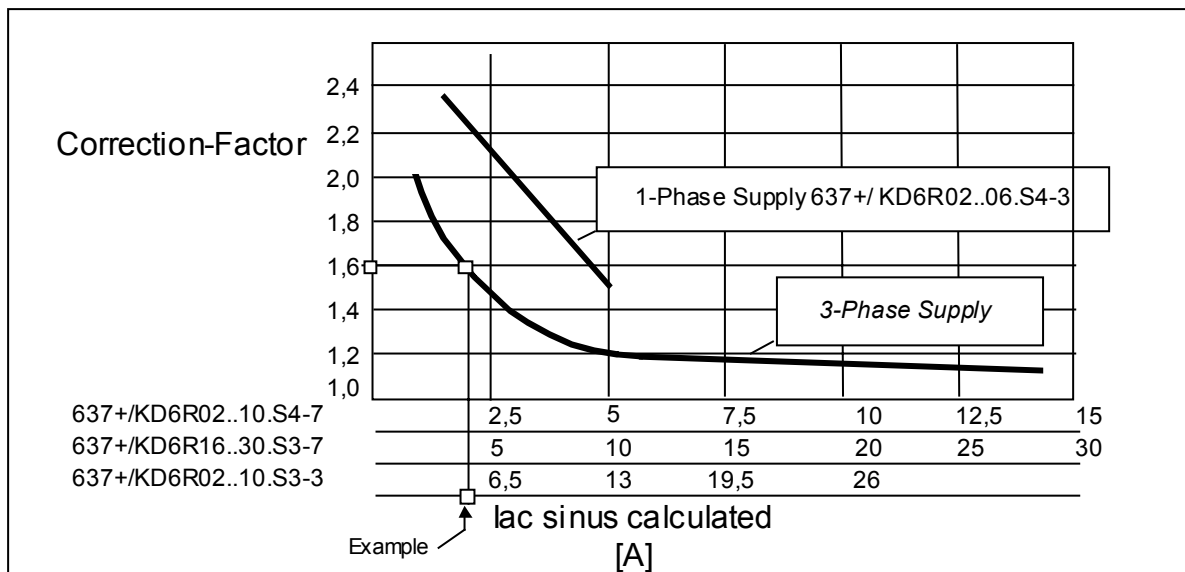

Example:

Drive type 637+/KD6R16.S4-3 is supplied by AC 230V 3-ph.

Output data to the motor: AC 200V 16A

Output-power: $P_{out} = 200V \times 16A \times 1,73 = 5,54\text{ kW}$

This output-power must be generated by:

calculated supply-current $I_{ac\ sinus} = 5,54\text{ kW} / (230V \times 1,73) = 13,9\text{ A}$

Correction-Factor from diagram: 1,6

RMS. Supply-Current $I_{eff} = I_{ac\ sinus} \times 1,6 = 22,3\text{ A}$

Result:

All supply-equipment has to be selected in respect to the enhanced current.

Electrical installation

5.8 Brake resistor

5.8.1 Selection of the brake resistor

The energy of a moving system flows back to the Drive. The DC-Bus capacitors are able to take a small value. The rest has to be converted to heat by a resistor.

Switching of this brake resistor depends on the DC-Bus voltage.

The load of the resistor is simulated and supervised electronically (EASYSRIDER® Windows - Software). Peak power (Pmax) and continuous power (Pd) ratings have to be sufficient to meet the requirements of the application.

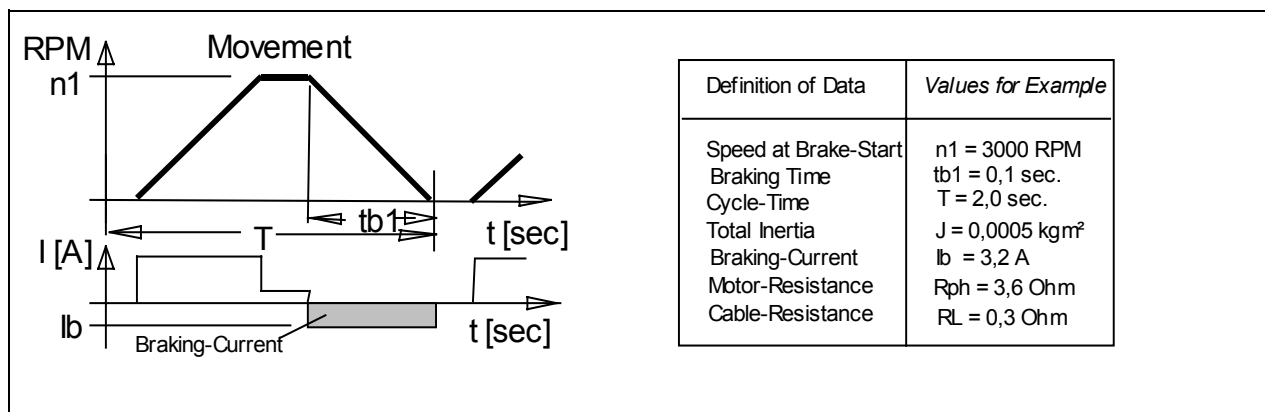

Calculation	
Step 1	example
Calculation of brake-power (Approximation. Capacitor-load, friction-and drive-losses neglected)	
Power of motion: $P_{kin} = 0,0055 * J * n1^2 / tb1$ [W]	$P_{kin} = 0,0055 * 0,0005 * 3000^2 / 0,1$ $P_{kin} = 247$ W
Motor-losses: $P_{vmot} = Ib^2 * (Ri + RL)$ [W]	$P_{vmot} = 3,2^2 * (3,6 + 0,3)$ $P_{vmot} = 40$ W
Cont. Power: $Pd = 0,9 * (P_{kin} - P_{vmot}) * tb1 / T$ [W]	$Pd = 0,9 * (247 - 40) * 0,1 / 2$ $Pd = 9,3$ W
Peak-Power: $Pmax = (1,8 * P_{kin}) - P_{vmot}$ [W]	$Pmax = (1,8 * 247) - 40$ $Pmax = 405$ W
used units: J total inertia [kgm ²] n1 speed at Brake-Start [RPM] tb1 braking time [Sec] T cykle time [Sec] Ib brake-current [A] Rph resistance of motor (between terminals) [Ω] RL line resistance of motor cable [Ω]	



Electrical installation

Brake resistor

Selection of the brake resistor

<p>Step 2 Internal / external Brake-resistor required ? see data in chapter 1.3.3 / 1.3.4</p>	<p>Example-Drive model 637+/K D6R04-7</p>																																									
<p>In case of insufficient capability or not included internal Brake-Resistor, a type may be selected from the following list</p> <p>External and internal Brake-Resistors will be switched in parallel. The internal and external performance-Data may be added in this case.</p>	<p>acc. to data in 1.3.3: internal resistor: Cont. Power Pd = 30W Peak Power Pmax = 1700W Required: Pd = 9,3W Pmax = 405W Result: The internal capability is sufficient</p>																																									
<table border="1"> <thead> <tr> <th style="text-align: left;">Selection guide</th> <th>Drive -Type</th> <th>Ub-Setpoint</th> <th>Pmax ext [W]</th> <th>Pd ext [W]</th> <th>Rb ext [Ohm]</th> <th>Eurotherm-model</th> </tr> </thead> <tbody> <tr> <td rowspan="3" style="vertical-align: middle;">external Brake-resistors</td> <td rowspan="3" style="text-align: center;">xD6Rxx.S3-3</td> <td>DC 375 V</td> <td style="text-align: center;">4260</td> <td style="text-align: center;">100</td> <td style="text-align: center;">33</td> <td>B100/33-3</td> </tr> <tr> <td>DC 375 V</td> <td style="text-align: center;">17150</td> <td style="text-align: center;">300</td> <td style="text-align: center;">8,2</td> <td>B300/8,2-3</td> </tr> <tr> <td>DC 375 V</td> <td style="text-align: center;">17800</td> <td style="text-align: center;">560</td> <td style="text-align: center;">7,9</td> <td>B560/7,9-3</td> </tr> <tr> <td rowspan="3"></td> <td rowspan="3" style="text-align: center;">xD6Rxx.S3-7</td> <td>DC 730 V</td> <td style="text-align: center;">5330</td> <td style="text-align: center;">100</td> <td style="text-align: center;">100</td> <td>B100/100-6</td> </tr> <tr> <td>DC 730 V</td> <td style="text-align: center;">16150</td> <td style="text-align: center;">300</td> <td style="text-align: center;">33</td> <td>B300/33-6</td> </tr> <tr> <td>DC 730 V</td> <td style="text-align: center;">20400</td> <td style="text-align: center;">560</td> <td style="text-align: center;">26</td> <td>B560/26-6</td> </tr> </tbody> </table> <p>Overload-Capability: approx. 5000% / 0,5 Sec</p>		Selection guide	Drive -Type	Ub-Setpoint	Pmax ext [W]	Pd ext [W]	Rb ext [Ohm]	Eurotherm-model	external Brake-resistors	xD6Rxx.S3-3	DC 375 V	4260	100	33	B100/33-3	DC 375 V	17150	300	8,2	B300/8,2-3	DC 375 V	17800	560	7,9	B560/7,9-3		xD6Rxx.S3-7	DC 730 V	5330	100	100	B100/100-6	DC 730 V	16150	300	33	B300/33-6	DC 730 V	20400	560	26	B560/26-6
Selection guide	Drive -Type	Ub-Setpoint	Pmax ext [W]	Pd ext [W]	Rb ext [Ohm]	Eurotherm-model																																				
external Brake-resistors	xD6Rxx.S3-3	DC 375 V	4260	100	33	B100/33-3																																				
		DC 375 V	17150	300	8,2	B300/8,2-3																																				
		DC 375 V	17800	560	7,9	B560/7,9-3																																				
	xD6Rxx.S3-7	DC 730 V	5330	100	100	B100/100-6																																				
		DC 730 V	16150	300	33	B300/33-6																																				
		DC 730 V	20400	560	26	B560/26-6																																				

5.8.2 Configuration of the brake resistor

Possible ballast circuit configurations at digital devices

a) Compact design

The plug-in modules of servo-control series 635 / 637 are provided with an on board ballast electronics. It is intended for application as compact unit KDER resp. KD6R. These compact units contain the necessary ballast resistor incl. fuse for the ballast circuit. Except KD6R 16..30-7 (external resistor only).

b) Rack design

While the plug-in modules are used in a rack, the NEB power supply module takes dissipation of the braking energy (adjustment of ballast monitoring: please see NEB manual). In this case the ballast electronics of the plug-in module will be deactivated with the configuration parameter "Ballast aktiviert = N". All further ballast parameters are no longer relevant then.

r.g. a) Adjustment of ballast circuit for compact units:

In this case the ballast electronics of the plug-in module will be activated. "Ballast aktiviert = J".

The operating point has to be adjusted dependent on the voltage variant.

"Ucc Ballast Ein = 375 V" for 230 V AC supply

"Ucc Ballast Ein = 720 V" for 400..460 V AC supply

As resistance value, the parallel resistance from internal and external resistance has to be adjusted.

e.g. "Ballastwiderstand = 300 Ohm" for KD6R-10-7 (internal resistance only)

"Ballastwiderstand = 75 Ohm" for KD6R-10-7 (+ external 100 Ohm / 100 W)

As ballast power (braking energy), the sum total of internal and external resistor power has to be adjusted.

e.g. "Ballastleistung = 30 Watt" for KD6R-10-7 (internal resistance only)

"Ballastleistung = 130 Watt" for KD6R-10-7 (+ external 100 Ohm / 100 W)

Precondition for correct monitoring of shunted ballast resistors is the nearly same ratio of P - cont. power to P - pulse power. This is guaranteed with the Eurotherm standard combinations.

KD6R 16..30-7 units do not contain an internal ballast resistor.

At these versions the values of the external resistor can be feeded directly.

Electrical installation

Brake resistor

5.8.3 Additional informations

Adjustment of load-supervision

used brake resistor		EASYRIDER- data adjustment acc. to...
R intern	R extern	
X		R intern
X	X	R extern
	X	R extern

Paralleling of resistors:

possible in respect of the limits in accordance to chapter 1.3.3 / 1.3.4

General rule for resistor data:

$$P_{max} / P_d \leq 59$$



Caution !

Placing of external brake resistors

Brake-resistor are dissipating heat !

Make sure, that there will be no fire-danger in case of operating the resistor in nominal- or fail-conditions



6 Wiring instructions

6.1 General Information

Digital servo drives are designed for **operation in metallic grounded enclosures**. For perfect operation as well as for observance of all regulations the **front board must be connected with the enclosure electrically and fixed**.

6.2 Control cabling

Recommended cross section 0,25 mm². The control signal lines must be laid separate from the power signal lines. (see chapter 6.7.1)

The resolver cable should contain three shielded pairs **and** be shielded as a whole. The shielding should be connected to the ground spread out on the regulator side. We recommend using Eurotherm resolver cable **KIR**. Cable for transmitting data are always to be laid shielded !

6.3 Power cabling

Recommended section according to rated current. Use only 75° Cu-cables.

6.4 Installation of the rack

When the rack is secured not in a hinged bay but on a mounting plate, it is recommended to do the wiring of the connections for the power connector X50 on the rear of the rack before installing. With hinged-bay installation, the customer must ensure that the parts sensitive to voltage such as the Ucc bus, mains supply lines, etc., are protected against electric shock.

6.5 Analog setpoint

The setpoint input is a differential input. Therefore the poling can be done depending on the requirements.

Important: the setpoint voltage must be galvanically connected to the reference potential of the control connections (plug X10). It is possible to connect one pole directly to GND.

6.6 Safety rules



CAUTION !

Plug / unplug all modules only when

Ucc (DC-BUS) is off, that is, the green LED on the power supply module is off and the discharge time > 3 minutes has elapsed.

The user must ensure protection against accidental touching.

6.7 Electromagnetic compatibility (EMC)

Conformity in accordance with the EEC Directive 89/336/EEC has been evaluated using a reference-system, consisting of a compact type drive and a line-filter on mounting-plate, connected to an AC-synchronous motor.

Mainly responsible for EMC-emissions is the motor cable. So this has to be installed exceptional carefully.

The layout of grounding is very important. Grounding has to be low-impedant for high frequencies. That means, all ground-connecting parts have to use area.

The measurements made are valid under the use of Eurotherm - cables, suppression aids and line filters and by application of the following wiring instructions:

Wiring instructions

Electromagnetic compatibility (EMC)

6.7.1 Hints for mounting

A	All components are mounted inside of a steel control cubicle on a mounting plate (thickness min. 3mm). Recommended: Galvanizing	
B	The connection between drive housing filter-housing and mountig-plate must be blank and not reduced by varnish. All screws must be well fixed !	
C	Use only Eurotherm-filters and cables for motor and resolver	
D	Place all wires and cables as close as possible to any grounded metal planes	
E	Separate power- and control cables. Minimum distance: 0,3m Crosspoints: 90°	
F	Avoid cable-loops. Especially the line between line-filter and drive has to be as close and short as possible (drilled)	
G	Maintain screen as close as possible to the cable-end (max distance 8 cm)	
H	Connect screen-connections according to general view of connetions, see chapter 2.1. Ground screens on both sides, shortest way. For long cables: Connect additional screen-area along the way	
I	Connect screens area-contacted to good grounded points	
K	Connect unused wires in cables to ground	
L	Install control cables directly close to grounded metal-parts or screend when leaving the control-cubicle	
M	Take care for good grounding of control-transformer (DC 24V). Use transformer with metal-socket and take care for conductive contact to mounting-plate	
N	Take care for good general grounding of the complete system. Interconnect several mounting-plates with copper-rails or copperband. Take care for ground connection between conrol-cubicle and machine !	

Wiring instructions

Electromagnetic compatibility (EMC)

6.7.2 Example for mounting

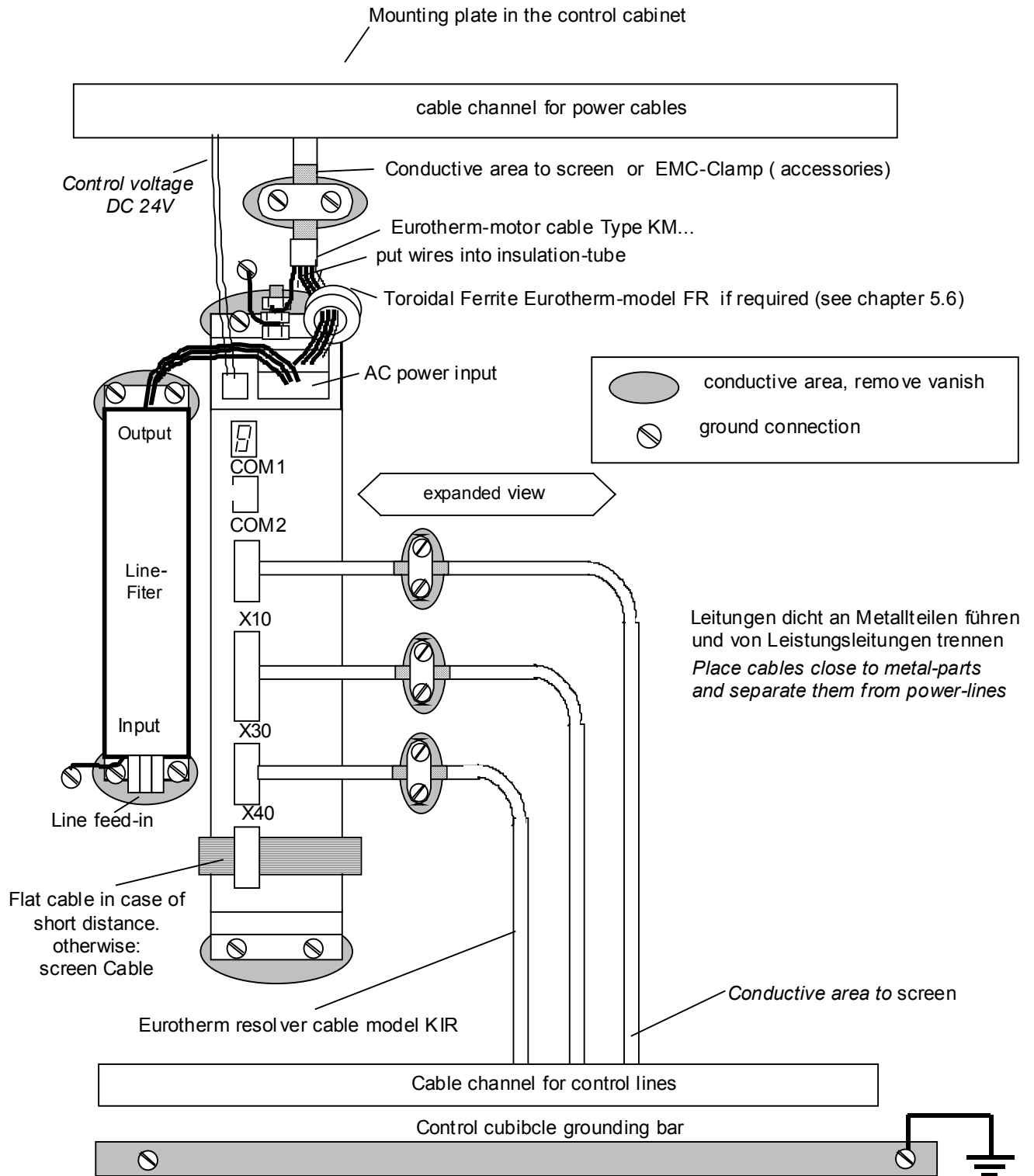

Wiring instructions

Electromagnetic compatibility (EMC)

6.7.3 Achievable specifications and conditions

			Standard	conditions		additional conditions	
	Area	Class		Motor-cable length	Eurotherm line filters	mounting in	additional
Emissions: transmitted by cable or by air	Industrial	A	EN50081-2/ EN55011 Klasse A	see chapter 5.6	LNF S/E LNF B	closed cabinet with ≥ 15 dB attenuation	toroidal ferrite cores see chapter 5.6
	Residential	B	EN50081-1/ EN55011 Klasse B	see chapter 5.6	LNF S/E LNF B		
Interference immunity: (≅ radiation) transmitted by cable or by air	Industrial	A	EN50082-2	-	-	-	-
	Residential	B		-	-	-	-



7 Setting and programming

7.1 Jumper

All jumpers are set to a standard position in production !

JP100, bridged pad...	
2 and 3 (standard)	READY contact with reference to common output supply voltage on X10.21
1 and 3	READY contact can be wired freely

JP101, bridged pad...	
2 and 3 (standard)	Analog input X10.19 without internal Pull-up.
1 and 3	Analog input X10.19 with internal Pull-up to +12 V (FRR compatible)

JP102, bridged pad...	
2 and 3 (standard)	X10.23 = active ok. output
1 and 3	X10.23 = GND internal (FRR compatible)

JP1, JP2 bridged pad...	adjust identically !
2 and 3 (standard)	X10.15 = high-active
1 and 3	X10.15 = low-active

JP3, JP4 bridged pad...	adjust identically !
2 and 3 (standard)	X10.14 = high-active
1 and 3	X10.14 = low-active

JP2.8, JP2.3 JP2.7, JP2.2	
open	Default, RP CAN,RP DEV, RP PDP
close	RP 232, RP 422, RP 485, RP IBS,RP EA5, RP SUC

7.2 Digital communication

see chapter 1.1.1

8 Commissioning



CAUTION !

**Wiring errors or incompatible operation may cause unpredictable motions.
Avoid danger for men and machine !**



8.1 Preparation

- For PC-link use the Eurotherm communication software EASYRIDER® Windows - Software. For the start, we suggest exercises in simulation mode to get familiar with EASYRIDER. This chapter presumes the knowledge how to handle EASYRIDER. Suggestions: Use test equipment to train yourself. EASYRIDER® Windows - Software contains interactive HELP - functions.
- For security-reasons the access to several functions is blocked by password. Commissioning has to be executed by trained staff only.
- Users may have their application-adapted commissioning method when familiar with the product, on their own responsibility.
- The system must be in accordance with all valid safety specifications. The function of all safety equipment (limit-switches for example) have to be checked.
- To activate the power-stage of the drive, the "ACTIVE"-signal (X10.22 against X10.9) has to be exited.



Commissioning

8.2 Commissioning in steps

Step	Action	Remark
1	Before switching on Check the wiring, especially: Filterpolarity, supply motor wiring, motor polarity resolver wiring, polarity (or other feedback systems)	
2	with critical mechanical parts: remove motor shaft from application	avoid danger
3	Connect PC by RS232 link to the drive service port COM1 and start EASYRIDER®	
4	Switch on control voltage Us (DC 24V) EASYRIDER® communicates (see diagnosis F9)	7-Segment-display 
5	Set up state NOT ACTIVE (X10.22 against X10.9) Power ON	7-Segment-display 
6	Are parameters already evaluated ? yes: load parameter file *.WDD. Store parameters in the drive. If existent: load BIAS-file *.WBD and store it in the drive. proceed with 10 or 15 (experts) no: continue with 7	
7	Menue Comissioning: Select the used motor from the EASYRIDER®- Library Adjust max. current to nominal motor current or smaller	reduced torque
8	When leaving that menue: Tuning-parameters for current loop will be calculated and offered to the user. Normally, these values give dynamic servo motion.	confirm acceptance of offered parameters
9	store data power-fail-save in the drive (F7)	
10	Menue: Tuning speed loop	

Commissioning

Commissioning in steps

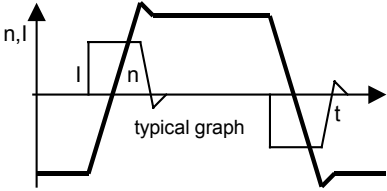
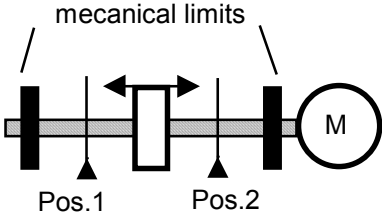
Step	Action	Remark
11	"ACTIVE" switched	7-Segment-display 
12	Adjust test generator as required. Activate test generator with "START Motor". Activate graph to display motor current or speed. can be optimized manually (P- and I-gain)	
13	Is the result ok? yes: continue with 14 no: continue with U1	
14	Preparation to the position controller The commissioning of the position controller is first recommended without linked up mechanics. In the case of secure functions, the mechanics can then be linked up.	
15	Power OFF. connect motor-shaft to the application Move application to a free area between mechanical limits. Power ON Menu: Tuning position loop	
16	Adjust testgenerator. Select Pos.1 and Pos .2 to uncritical values. Select slow speed and slow acceleration first, rise up later.	mind: reaction-time to Emergency Stop
17	"ACTIVE" - switched. Every activation of "START Motor" exits a motion from Pos. 1 to Pos.2 and, with the next activation, from Pos 2 to Pos. 1	
18	Observe the behavior of application and graph. Optimize tuning-parameters (P-, I- andV gain)	
19	Is the result ok? yes: continue with 20 no: continue with 9	
20	Basic power-up is done now. Further functions (Interfaces, fieldbus functions, synchronizing and so on may be done adapted to the selected equipment.	
21	Select the menu File "store parameters" and store the data in the regulator, protected against loss, with the F7-key.	data save

Commissioning

Commissioning in steps

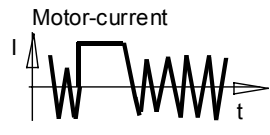
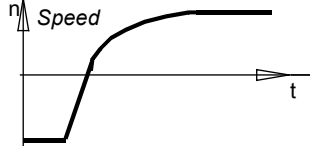
Step	Action	Remark
U1.1	<p>Menu: Tuning Speed Loop</p> <p>Stable parameters are calculated bases on the system data; and can be called up with F5. Sometimes it is recomanded to make further manual tuning.</p> <p>Rated values can be sourced either digital by the internal generator or analog by using +/-10V at X10.5/18.</p> <p>ATTENTION !</p> <p>Too hard tuning will cause current-ripple and high power-dissipation.</p>	 <p>Motor-current</p> <p><i>P-Gain too high or I-time constant too small Motor-noise</i></p>
U1.2	<p>Too weak adjustment causes slow loop-reactions, that may cause problems for the tuning of position loops.</p>	 <p><i>P-Gain too smal I or I-time constant too high</i></p>
U1.3	<p>Is the result ok? yes: continue with 9 no: continue with U2.1</p>	
U2.1	<p>Menu: Tuning Current Loop</p> <p>Stable parameters are calculated bases on the system data and can be called up with F5. Manual tuning may be sensfull.</p> <p>Rated values can be sourced either digital by the internal generator or analog by using +/-10V at X10.5/18.</p> <p>ATTENTION !</p> <p>Tuning of current loop should be only done after consultation of Eurotherm experts.</p> <p>continue with 9</p>	

9 Diagnosis and trouble shooting

9.1 7-segment display

Many sources of faults can be narrowed down with the diagnosis display.

display	explanation	output ready	output ²⁾ warning	Comment
/	no display	off	off	any control voltage? external fuses ok?
-	system ready for operate	on	off	regulator ready not activ
•	drive ready for operate ! system active	on	off	DC-bus within the boundaries
=	internal STOP with serial deactivating	off	off	activate drive via serial interface
=	regulator of serial interface COM2 deactivated !	off	off	only if bus interface is integrated or the BIAS-command deactivated !
-	deactivated with delay time for the brake	on	off	deactivated via input.
		off	off	deactivated via serial command.
=	Activ input is activated with switching on	off	off	switch enable X10.22 low and then high
U	undervoltage of control voltage	off	off	control voltage < 17 V.
/	undervoltage in DC-bus <U _a low threshold	off	off	power supply switched on? power supply unit ok? internal fuses ok? Error signal disappears, if DC-bus voltage over the threshold. EASYRIDER® Windows – Software.
2	fault in feedback system (e.g. resolver)	off	off	wiring to encoder system ok? encoder system ok? encoder system supply ok?
3	I ² t-overload of the regulator	1)	1)	does the control loop oscillate? P-amplification too high mechanics stiff? requirements too high? is warning /8/ evaluated?
4	overload of the motor I ² t	1)	1)	does the control loop oscillate? P-amplification too high mechanics stiff? requirements too high? is warning /8/ evaluated?
5	overtemperature of the output stage (> 95°C)	1)	1)	adequate cooling of the regulator? ambient temperature too high?

- 1) Reaction to these errors see chapter 3.3
 2) With configuration corresponding chapter 3.1
 * Only warning and/or status indicator



Diagnosis and trouble shooting

7-segment display

display	explanation	output ready	output ²⁾ warning	Comment
b	overvoltage on DC bus	1)	1)	ballast module ok? adequate ballast module?
7	chassis shorting and short circuit due to hardware	off	off	motor cabling ok? digital-loops setup ok? short circuit to chassis in the motor? braking resistor: ohm- value too low? try to start fresh! send in for repair
* g	WARNING! overload of the regulator I ² t or motor I ² t or temp.-output stage too high. If no reaction within approx. 3sec.it switches off with signals /3/, /4/ or /5/. Signal /8/ clears when there is no more danger or it is switched off	off	1)	mechanics stiff? defective bearings; cold grease? reduce requirements and creep to next possible STOP
g	overtemperature motor(NTC/PTC)	off		check overload of the motor / cooling etc.
* h	motor temperature too high	on	1)	check overload of the motor / cooling etc.
-	ballast active			Brake energy is removed
u	warning I ² t ballast too high	on	1)	ballast resistance usage >90%
U	switch off ballast	on	1)	ballast resistance overloaded
H	X 300 – Modul not inserted or wrong inserted or defect	off	off	X 300 testing Chapter1.4.3.1 Layout
H	X 300 – setting wrong	off	off	X 30 / X40 Counter-Configuration test in the EASYRIDER® Windows – Software
* L	tracking window exceeded			only in operation mode position control, will be deleted with the next run-command
L	tracking error with switch off			only in operation mode "position control"
y	memory-checksum-error	off	off	try new start

- 1) Reaction to these errors see chapter 3.3
 2) With configuration corresponding chapter 3.1
 * Only warning respect. status indicator

The error signals are shown as long as there is control voltage (Us), also when the power (DC-Bus) is switched off for safety reasons.

Diagnosis and trouble shooting

9.2 Reset of a regulator trouble

The error signals 2 - 7, 9, \mathcal{L} , U, u, Y, II, H of the drive can be reset via:

1. Control voltage OFF/ON,

2. the serial command “Drive Reset“ 0x02

The host login must be occurred.

The drive must be deactivated via the serial command “deactivate Drive“ 0x00.

3. the fieldbus-command “ Drive Reset“ 0x16 (22 decimal)

The host login must be occurred via the BUS command 0x01. The drive must be deactivated via the BUS command “deactivate Drive“ 0x14.

The fieldbus command “Drive Reset“ with constant repetition of the fieldbus command 0x16 will be works-off only once.

For further processing, it is necessary, meanwhile to send another control word (e.g. 0 status order).

4. a 0 – 1 flank on input X10.11

Precondition:

- The input X10.11 is with function 1 “Reset drive fault“ configured (EASYSRIDER[®] Windows – Software)
- There is no host login.
- The input Active,(X10.22) is inactive (0V)
- The signal must be present min. 250 ms

A general precondition for correct execution of the Reset is the elimination of the error cause

Notice !!

After remove of the tracking error deactivation “ \mathcal{L} “, the warning message “L“ (tracking error) is active up to the next move command.

The error signal “ \equiv “ (releasing before ready) can be reset by deactivation the drive.



Diagnosis and trouble shooting

9.3 Trouble shooting

The following list refers to faults which can occur during operation.

Display: / 3./

Error	Explanation and remedy	
no motor run despite current flow	motor mechanically blocked? motor brake released?	1)
motor runs unevenly	check setpoint wiring check grounding and shielding too high P-amplification in the speed controller reduce value (with EASYRIDER [®] setting/speed controller) too small I-time in the speed controller? reduce value (with EASYRIDER [®] setting/speed controller)	
no reaction of setpoint progression, despite torque in standstill	Limit switch functions effective (BIAS)	
no current flow; no torque despite activating the regulator correctly	motor cables interrupted? Is input "I extern" (X10.19) activated (config. menu) and not notched up? limit switch - input activated and not notched up?	
Interference symptoms with power frequency	Ground loops in setpoint or actual value wiring? Shieldings laid on both sides? Signal cables near high voltage cables?	
Motor takes up preferred positions after activation	Position encoder or motor cables with reversed poles? Resolver or Feedback- encoder incorrectly adjusted? Number of motor poles wrong matching? (config. menu)	1)
Motor runs up immediately after activation although there is no setpoint	Motor cables or feedback- cables reversed? Encoder incorrectly adjusted? (e.g. Resolver)	1)
Motor reaches in idling cycle very different speed when running to the right or to the left	Feedback-Encoder incorrectly adjusted (e.g. Resolver)	

1) Display /3./ or /4./ mostly short after activating; before warning /8./

10 Block circuit diagram

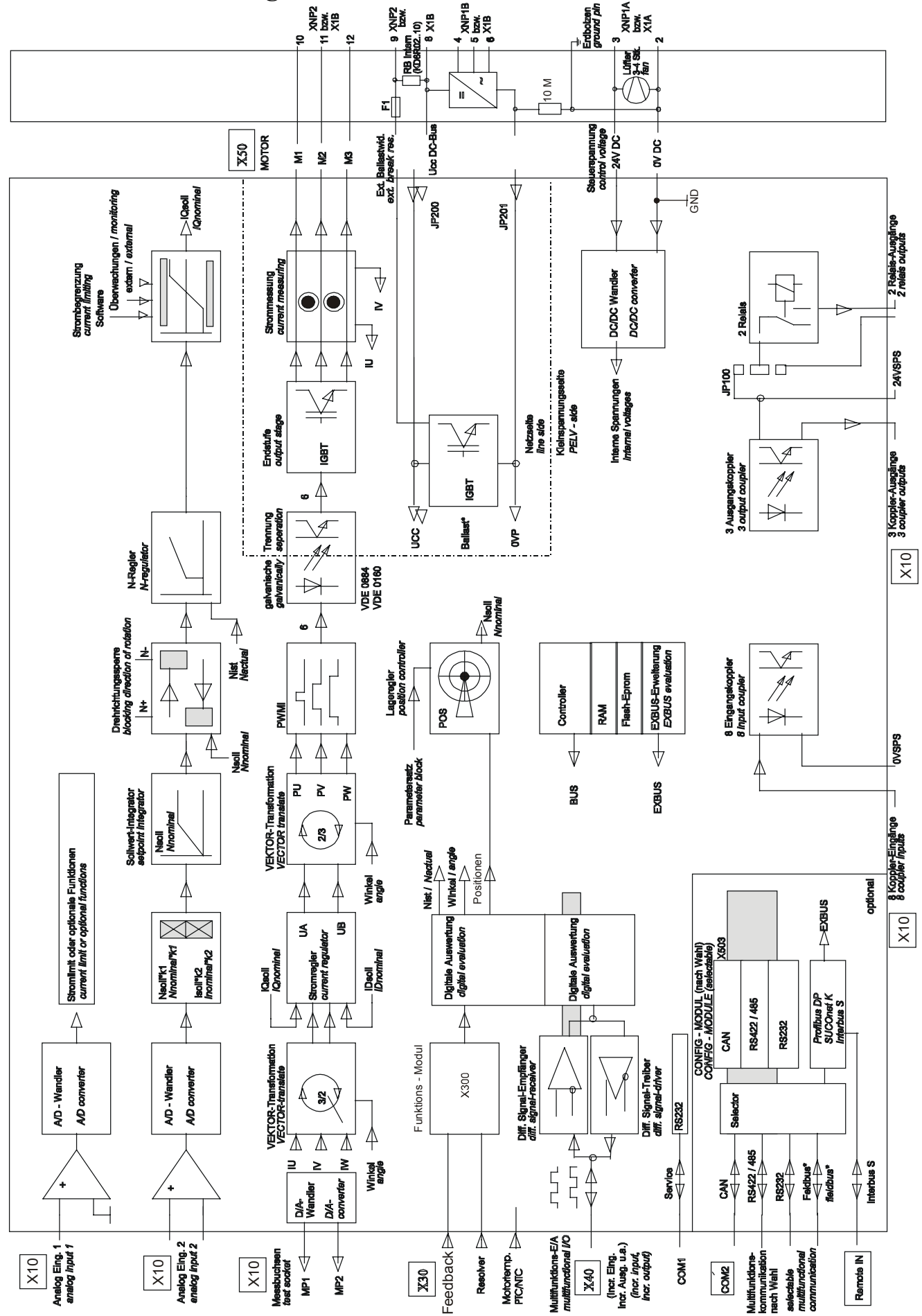



11 General technical data

11.1 Power circuit

galvanic separation from control circuit	in acc. with EN 50178 / VDE 0160
specification in accordance with	UL 508C and cUL
short circuit and to frame proof for	Min. 2000 releasings
overvoltage monitoring D6R..-3	Max. 400V DC $\pm 5V$ DC
overvoltage monitoring D6R..-7	Max. 765V DC $\pm 10V$ DC
undervoltage monitoring	min. 15V DC; configurable
overtemperature switch off at	95 ° C +/- 5%
clock frequency	4,75 kHz
frequency of current ripple	9,5 kHz

11.2 Control circuit

galvanic separation from power circuit	in acc. with EN 50178 / VDE 0160
further informations:	see concept of insulation chapter 1.3.1
	see data compact units chapter. 1.3.3
	see data plug-in modules chapter 1.3.4

11.3 Signal inputs and outputs, connection X10

additional galvanic separation from power and control circuit	
nominal voltage of the in- and outputs	24 V DC
number of outputs signal outputs via OPTO coupler	5 $U_{max} = 45V$ DC; $I = 0..60$ mA; short circuit proof, resistive load
signal outputs via RELAY contact protection with inductive load	$U_{max} = 45V$ DC; $I = 1\mu A...1,2A$ internal varistor
number of inputs signal outputs via OPTO coupler	8 $L = 0...7$ V DC or open $H = 15...30$ V DC $I_{in} 24VDC @ 8$ mA
reaction time of the inputs X10.2, X10.4, X10.11, X10.14, X10.15, X10.24	> 1 ms
reaction time of the inputs X10.4, X10.25 (configured as latch input "see chapter 3")	0,2 ms
Effect of cycle-time	$\leq 0,02$ ms

General technical data

11.4 Digital control

current control	
Loop-Cycle-Time	105 μ s
settings	according to factory specifications or motor data
current limits, Adjustment by:	speed control -Menue
	Analog Input 0..10V = 0..100%; can be normed, 10Bit

speed control	
Loop-Cycle-Time	210 μ s
settings	speed control menu
differential setpoint input analog resolution (including sign)	$U_{soll} = 10$ V, can be normed; $R_i = 10k$ 14 bit
digital setpoint input	via interfaces

position control	
Loop-Cycle-Time	840 μ s

11.5 Digital communication

RS232 - service interface	COM1 19200 baud, 8 databits, 1 startbit, 1 stopbit, parity: even
<u>Optional</u> RS232 / RS 422 / RS 485 on SUB D – socket	COM2
CAN, Profibus DP, SUCOnet K on SUB D - socket Interbus S on SUB D - socket (OUT) Interbus S (Remote IN)	additional SUB D plug

11.6 Resolverauswertung / Transmitterprinzip

<u>General:</u> The specified data refer to the combination of the standard resolver interface with Function-Module X300_RD2; operated with the Eurotherm resolver R 21-T05, R15-T05	
carrier frequency	$f_t = 4,75$ kHz
ripple of the speed actual value signal	2% ¹⁾
max. position resolution for one revolution	65536 / 16 bit
absolute position accuracy	+/- 0,7 ° ¹⁾
relative position accuracy	+/- 0,08 ° ¹⁾

¹⁾ Data under check, Reality: Quality improved

General technical data



11.7 Controllsystem

system run-up time after switching on the control voltage	max. 6 sec.
data memory / organization	Flash Eprom 256 KB RAM 64 KB; EEPROM 32 kByte

11.8 Analog-Outps

measuring pin X10.17

signal range	-10V.....0.....+10V magnifier function can be normed
resolution	8 bit, independend of norming
internal resistance	1,8 kOhm

measuring pin X10.6

signal range	-10V.....0.....+10V magnifier function can be normed
resolution	10 bit, independend of norming
internal resistance	1,8 kOhm

11.9 Thermal data

thermal data	see chapter 1.3
--------------	-----------------

11.10 Mechanical data

dimensions	see chapter 1.4
weight	see chapter 1.3

Further data you will find in chapter 1.3

12 Disposal

The digital servo drive consists of different materials.

The following table shows, which materials can be recycled and which have to be disposed of in a special way.

material	recycle	disposal
Metal	yes	no
plastics material	yes	no
printed board assembly	no	yes

Dispose of the appropriate materials in accordance with the valid environmental control laws.



13 Software

13.1 EASYRIDER® Windows - Software

EASYRIDER® Windows - Software is an comfortable tool to use all drive functions. Detailed Online-Help-infomations and instructons are available..

EASYRIDER® Instructions: (extract)

- Autopilote-function as interactive tutorial
- System identification
- BIAS - instruction-set editor
- Oszilloscope-function
- start-up and comissioning-tools
- Setting of parameters
- Setting of configurations
- Servo-diagnostics
- Interface diagnostics
- Fieldbus diagnostics
- Motor library
- save system data in file
- load system data from file
- send system data to servodrive
- save system data in servodrive
- load system data from servodrive

Important:

Edited data in EASYRIDER® are transmitted to the RAM of the servodrive and **active after** use of the instruction **SEND**. **Only the instruction SAVE in EEPROM** writes data into a nonvolatile memory. Data are stored there power-fail save.

Software

13.2 Eurotherm programming language BIAS

In **Operating mode 5** – Position control with BIAS, three user-defined programs can be executed parallel. The BIAS-program and the PLC-program (sequence cascades, 1 command per position controller sampling = 844 uSec) as well as the Mathematics program (cyclic execution in remaining time of processor).

The BIAS-program is primary intended for administration of travel commands. If application permits, also simple calculations can be performed and analog/digital I/O's can be serviced in this task.

The PLC-task is conceived to perform I/O logic, sequence control, monitoring and CAN-Bus communication.

The Mathematics program is designed for complex calculations, e.g. computing of a cam, executed by the BIAS-program afterwards. But it is also possible to store the same tasks here, as basically defined for PLC-task, which can increase PLC performance of the 637+ controller approx. twenty times.

While the BIAS-program will be executed from the start block directly after activation of **operating mode 5**, the PLC-program will be first started by BIAS-command "PLC-program" and the Mathematics program by command "Mathematics program". At reaching the command "End of program" (Mode = 0) the respective execution pointer re-jumps to his start label.

Within the command set the following command groups are provided:

Program flow control

- Fixing start/end of main- and sub-programs
- Conditional and unconditional jump commands

Travel relevant commands

- Positioning commands
- Parameter commands
- Technology functions
 - >Register positioning
 - >PID-control
 - >Synchronous applications

Logic commands

- Logic commands for coils and internal relays

Variable commands

- Writing and reading of parameters
- Fundamental operations of arithmetic with long integer
- Type-conversions long integer <=> double float (Math.task only)
- Fundamental operations of arithmetic with double float (Math.task only)
- SIN(x),COS(x),SQRT(x) with double float (Math.task only)
- Writing and reading of synchronous profile tables.

CAN-Bus commands

- Communication with other Eurotherm products



Software

Eurotherm programming language BIAS

The user has the possibility to program his sequence himself from this set of commands.

Available program area	
Set number	
0000 -	
...	
...	can be selected via
...	data inputs X10.xx
...	max. to block no. 63 and
...	and Strobe X10.2
...	
0063 -	
...	
...	
1499 last block	

The BIAS operation set is listed on the next page.

You can read the exact function of the individual commands in the help function of the EASYRIDER® Windows -Software in the BIAS editor or in the BIAS command description (UL:10.06.05).



13.3 BIAS-commands

	0	1	2	3	4	5	6	7	8
0	move position	move position + parameter	position =	position = [variable X]	[variable X] = position	NOP	flag X =	If input X ?	[variable X] =
1	move incremental position	move incremental position + parameter	speed =	speed = [variable X]	[variable X] = speed	end of program	If flag X = ?	If output X ?	If [variable X] ? const.
2	move datum	move datum + parameter	acceleration =	acceleration = [variable X]	[variable X] = acceleration	sub-program	flag X = flag Y	output X =	[variable X] = [variable Y] + const.
3	move infinite positive	move infinite positive + parameter	deceleration =	deceleration = [variable X]	[variable X] = deceleration	end of sub-program	flag X = input Y	output X = flag Y	[variable X] = [variable Y] - const.
4	move infinite negative	move infinite negative + parameter	gear factor =	gear factor = [variable X]	[variable X] = gear factor	PLC-program	flag X = output Y		[variable X] = [variable Y] * const.
5	move synchron	move synchron + parameter	"position reached" window =	"position reached" window = [variable X]	[variable X] = block-number	jump	flag X = flag Y & flag Z		[variable X] = [variable Y] / const.
6	move cam-profile	move analogue value + integrator	remaining position =	remaining position = [variable X]	[variable X] = actual position Y	jump [variable X]	flag X = flag Y flag Z		[variable X] = flag Y, number Z
7	synchronous settings 1	move speed + integrator	ramp filter =	maximal current = [variable X]	[variable X] = analogue input Y	BIAS execution pointer	flag X = flag Y ^ flag Z		
8	synchronous settings 2		actual position X =	actual position X = [variable Y]	[variable X] = latchposition Y	wait for "position reached"	flag X = !flag Y	IBT-masknumber =	[variable X] = [variable Y]
9	move PID ; speed		If actual position X ? const.	analogue output = [variable X] (*)	[variable X] = actual speed Y	wait time	flag X = status Y	IBT-notification number =	If [variable X] ? [variable Y]
A	move PID ; torque	cycle length =	If actual position X ? [var.Y]	PID scaling	[variable X] = latchstatus Y	wait time [variable X]	If status X ?	CAN-command = [variable X]	[variable X] = [var.Y] + [var.Z]
B		cycle length = [variable X]	sensor window	sensor window = [variable X]	[variable X] = position Y	BIAS execution pointer = [var. X]	mode X =	IBT data-transfer	[variable X] = [var. Y] - [var. Z]
C			sensor position	sensor position = [variable X]	[variable X] = value Y		flag X = [variable Y], number Z		[variable X] = [var. Y] * [var. Z]
D			sensor adjustment 1	sensor adjustment 1 = [variable X]					[variable X] = [var. Y] / [variable Z]
E	start axis		sensor adjustment 2	sensor adjustment 2 = [variable X]					[teachvar. X] = [variable Y]
F	stop axis	stop axis + parameter	update parameter	PID parameter		virtual program			[variable X] = [teachvar. Y]

start axis	only defined in BIAS-program	stop axis	defined in BIAS- and PLC-program	BIAS-execution pointer	defined in PLC- and Math.-program	flag X =	defined in BIAS-, PLC- and Math.-program
------------	------------------------------	-----------	----------------------------------	------------------------	-----------------------------------	----------	--



13.4 Extended BIAS-commands

	9	10	11
0	mathematics-program	table [variable X] =	[D_variable X] = [D_variable Y] + [D_variable Z]
1	profil-initialization	table [variable X] = [y variable Z]	[D_variable X] = [D_variable Y] - [D_variable Z]
2	profil-cycle lenght	[x_variable Y] = table [variable Z]	[D_variable X] = [D_variable Y] * [D_variable Z]
3	[variable X] = profil value	[w_variable X] = [y_variable Z]	[D_variable X] = [D_variable Y] / [D_variable Z]
4	profil value = [variable X]	[x_variable Y] = const.	Wenn [D_variable X] ? [D_Variable Y]
5		[variable [X]] = const.	[D_variable X] = SIN [D_variable Y]
6		[variable [X]] = [variable Y]	[D_variable X] = COS [D_variable Y]
7	save table	[variable X] = [variable [Y]]	[D_variable X] = SQRT [D_variable Y]
8			
9			
A			
B			
C			
D			
E			
F			

mathematics-program defined in BIAS and PLC-program

table [Variable X] = only defined in math.-program

Merker X = defined in BIAS, PLC and mathematics-program

14 Certificates

Testing and Certification

The 637+ Servodrive is based on the construction of Type 637. Essential changes are only effecting the control-cirquits of the device. Following our technical point of view, this fact enables to apply all certificates related to Type 637 (see next pages) to the type 637+ as well.



VDE Prüf- und Zertifizierungsinstitut

ZEICHENGENEHMIGUNG MARKS LICENCE

**Eurotherm Antriebstechnik GmbH
Im Sand 14
76669 Bad Schönborn-Langenbrücken**

ist berechtigt, für ihr Produkt /
is authorized to use for their product

**Geräte, sonstige
Other appliances
Kompakt-Servoregler**

die hier abgebildeten markenrechtlich geschützten Prüfzeichen für die
ab Blatt 2 aufgeführten Typen zu benutzen /
the legally protected Certification Marks as shown below for the types referred to on page 2 ff.



Geprüft und zertifiziert nach /
Tested and certified according to

DIN EN 50178 (VDE 0160):1998-04 EN 50178:1997

VDE Prüf- und Zertifizierungsinstitut
VDE Testing and Certification Institute
Zertifizierungsstelle
Certification

Aktenzeichen: 19235-3990-0003 / 22WYD F17 / EN

File ref.:

Ausweis-Nr.: 108336

Licence No.:

Weitere Bedingungen siehe Rückseite und Folgeblätter /
further conditions see overleaf and following pages

Offenbach, 1998-07-02

(letzte Änderung/updated 1999-03-22)

Blatt 1
page



Certificates

VDE Prüf- und Zertifizierungsinstitut Zeichengenehmigung

Ausweis-Nr. / Licence No.	Blatt / page
108336	2

Name und Sitz des Zeichengenehmigungs-Inhabers / Name and registered seat of the Marks Licence holder

Eurotherm Antriebstechnik GmbH, Im Sand 14
76669 Bad Schönborn-Langenbrücken

Aktenzeichen / File ref.

19235-3990-0003 / 22WYD F17 / EN

letzte Änderung / updated

1999-03-22

Datum / Date

1998-07-02

Dieses Blatt gilt nur in Verbindung mit Blatt 1 des Zeichengenehmigungsausweises Nr. 108336.
This supplement is only valid in conjunction with page 1 of the Marks Licence No. 108336.

Jahresgebühren-Einheiten /
Annual fee units

**Geräte, sonstige
Other appliances**

30,00

Typ(en) / Type(s):

637/K D6R02.S3-3
637/K D6R02.S3-7
637/K D6R04.S3-3
637/K D6R04.S3-7
637/K D6R06.S3-3
637/K D6R06.S3-7
637/K D6R10.S3-3
637/K D6R10.S3-7
637/K D6R16.S3-3
637/K D6R16.S3-7
637/K D6R22.S3-3
637/K D6R22.S3-7
637/K D6R30.S3-3
637/K D6R30.S3-7

Nennspannung
Nominal Voltage

1/N/PE 230 V oder 3PE AC 230 V;
50/60 Hz (S3-3 Typen)
3/PE AC 460 V; 50/60 Hz (S3-7 Typen)

Nennstrom
Nominal input

siehe Anlage Nr. 1
see Appendix No. 1

zulässige
Umgebungstemperatur
Ambiant temperature

0...40°C

Schutzmaßnahme
Protection against electric shock

Schutzklasse I
Class I

Schutzart
Degree of protection

Einbaugerät, die Servoregler sind ausschließlich zur Speisung von Eurotherm (oder von Eurotherm freigegeben) Servomotoren bestimmt.
Built in devise, the servo controller are used only for Eurotherm servo motors or released from Eurotherm if others.

Fortsetzung siehe Blatt 3 /
continued on page 3



Certificates

VDE Prüf- und Zertifizierungsinstitut Zeichengenehmigung

Ausweis-Nr. /
Licence No.
108336

Blatt /
page
3

Name und Sitz des Zeichengenehmigungs-Inhabers / Name and registered seat of the Marks Licence holder

Eurotherm Antriebstechnik GmbH, Im Sand 14
76669 Bad Schönborn-Langenbrücken

Aktenzeichen / File ref.

19235-3990-0003 / 22WYD F17 / EN

letzte Änderung / updated

1999-03-22

Datum / Date

1998-07-02

Dieses Blatt gilt nur in Verbindung mit Blatt 1 des Zeichengenehmigungsausweises Nr. 108336.
This supplement is only valid in conjunction with page 1 of the Marks Licence No. 108336.

Jahresgebühren-Einheiten /
Annual fee units

Überspannungskategorie
overvoltage category

III

Kurzschlußfestigkeit
Short-circuit with stand capability

bedingt kurzschlußfest
conditionally short-circuit-proof

Transformator
Transformer

Fa. J. Lasslop, Typ TIV2DER
Az.: 19235-3990-0002
conditionally short-circuit-proof
Fa. Pulse FEE Typ MTA 12358

2,00

Weitere Angaben
Further information

vergleiche Anlagen Nr. 1 und 2.
see Appendix No. 1 and 2.

des genehmigten Erzeugnisses, der entsprechend der zugehörigen Installations- anleitung zu erfolgen hat, ist darauf zu achten, daß alle Anforderungen gemäß der oben genannten Bestimmung(en) eingehalten sind.
When the certified product is build in, installation must be in accordance to the provided installation instructions and requirements of the referenced standards must be assured

Summe der Jahresgebühren-Einheiten
Sum of annual fee units

32,00
=====

Dieser Zeichengenehmigungs-Ausweis bildet die Grundlage für die EG-Konformitätserklärung und CE-Kennzeichnung durch den Hersteller oder dessen Bevollmächtigten und bescheinigt die Konformität mit den genannten Normen im Sinne der **EG-Niederspannungsrichtlinie 73/23/EWG** mit ihren Änderungen.

This Marks Licence is the basis for the EC Declaration of Conformity and the CE Marking by the manufacturer or his agent and shows the conformity with the said standards as defined by the EC Low-Voltage Directive 73/23/EEC including amendments.

VDE Prüf- und Zertifizierungsinstitut
VDE Testing and Certification Institute
Fachgebiet F17
Section F17

i.A. Kerber

VDE Testing and Certification Institute * Institut VDE d'Essais et de Certification



Merianstraße 28, D-63069 Offenbach

Telefon (+49) (69) 8306-0
Telefax (+49) (69) 8306-555



Certificates

VDE Prüf- und Zertifizierungsinstitut Zeichengenehmigung

Ausweis-Nr. /
Licence No.
108336

Beiblatt /
Supplement

Name und Sitz des Zeichengenehmigungs-Inhabers / Name and registered seat of the Marks Licence holder

Eurotherm Antriebstechnik GmbH, Im Sand 14
76669 Bad Schönborn-Langenbrücken

Aktenzeichen / File ref.

19235-3990-0003 / 22WYD F17 / EN

letzte Änderung / updated

1999-03-16

Datum / Date

1998-07-02

Dieses Beiblatt ist Bestandteil des Zeichengenehmigungsausweises Nr. 108336.
This supplement is part of the Marks Licence No. 108336.

**Geräte, sonstige
Other appliances**

**Fertigungsstätte(n)
Place(s) of manufacture**

AA Eurotherm Antriebstechnik GmbH, Im Sand 14, 76669 Bad Schönborn-Langenbrücken

VDE Prüf- und Zertifizierungsinstitut
VDE Testing and Certification Institute
Fachgebiet F17
Department F17

i. A. Jank

i. A. Herberich

VDE Testing and Certification Institute * Institut VDE d'Essais et de Certification



Merianstraße 28, D-63069 Offenbach

Telefon (+49) (69) 8306-0
Telefax (+49) (69) 8306-555



Certificates

Northbrook, Illinois • (847) 272-8800
 Melville, New York • (516) 271-6200
 Santa Clara, California • (408) 985-2400
 Research Triangle Park,
 North Carolina • (919) 549-1400
 Camas, Washington • (360) 817-5500



EUROTHERM ANTRIEBSTECHNIK GMBH
 MR W HOOK, MANAGING DIRECTOR
 BEREICH SERVOANTRIEBSSYSTEME
 IM SAND 14
 76669 BAD SCHOENBORN
 LANGENBRUECKEN FED REP GERMANY



RE: Project Number(s) - 98-2224

Your most recent listing is shown below. Please review this information and report any inaccuracies to the UL Engineering staff member who handled your project.

For information on placing an order for UL Listing Cards in a 3 x 5 inch format, please refer to the enclosed ordering information.

**NMMS
Power Conversion Equipment**

January 5, 2000

**EUROTHERM ANTRIEBSTECHNIK GMBH
 BEREICH SERVOANTRIEBSSYSTEME IM SAND 14 76669 BAD
 SCHOENBORN, LANGENBRUECKEN FED REP GERMANY**

E178235

Power conversion equipment, Series K D6RXX3-Y where Y can be 02, 04, 06, 10, 16, 22 or 30, Y can be 3 or 7; Model KDER followed by 03, 05, 07 or 10; 635 Series followed by 03, 05, 07, 10.

LOOK FOR LISTING MARK ON PRODUCT

Certificates

EG-Konformitätserklärung

Name/Anschrift des Ausstellers: Eurotherm Antriebstechnik GmbH
Im Sand 14
76669 Bad Schönborn-Langenbrücken

Produktbezeichnung: Geräte, sonstige

Typenbezeichnung: 637/K D6R02.S3-3, 637/K D6R02.S3-7, 637/K D6R04.S3-3, 637/K D6R04.S3-7, 637/K D6R06.S3-3, 637/K D6R06.S3-7, 637/K D6R10.S3-3, 637/K D6R10.S3-7, 637/K D6R16.S3-3, 637/K D6R16.S3-7, 637/K D6R22.S3-3, 637/K D6R22.S3-7, 637/K D6R30.S3-3, 637/K D6R30.S3-7

Das bezeichnete Produkt erfüllt die Bestimmungen der Richtlinie:

73/23/EWG
mit Änderungen

"Richtlinie des Rates zur Angleichung der Rechtsvorschriften der Mitgliedstaaten betreffend elektrische Betriebsmittel zur Verwendung innerhalb bestimmter Spannungsgrenzen".

Die Übereinstimmung des bezeichneten Produktes mit den Bestimmungen der Richtlinie wird durch die vollständige Einhaltung folgender Normen nachgewiesen:

DIN EN 50178 (VDE 0160):1998-04 EN 50178:1997

Das VDE Prüf- und Zertifizierungsinstitut (EU-Kenn-Nr. 0366), Merianstr. 28, D-63069 Offenbach, hat das Produkt geprüft und zertifiziert. Der Zeichengenehmigungsausweis berechtigt zum Führen des untenstehenden Zeichens des VDE.



Zeichengenehmigungsausweis: 108336

Aktenzeichen: 19235-3990-0003 / 22WYD F17 / EN

Bad Schönborn, 07.06.99

(Ort, Datum)

J. Wierst

(Rechtsverbindliche Unterschrift des Ausstellers)



15 Index

7	
7-segment display	63, 64
A	
Achievable specifications and conditions	57
additional In-/Outputs	37
Analog setpoint	54
Analog-Outps	70
B	
BIAS- command blocks	11
BIAS commands	73
BIAS-commands	74
Block circuit diagram	67
Brake resistor	51
C	
Certificates	76, 77, 78, 79, 80, 81, 82
Commissioning	59, 60, 61, 62
Commissioning in steps	60, 61, 62
Connector pin assignment X40	31
Control cabling	54
Control circuit	68
Controllersistem	70
Cooling	47
D	
Danger areas	48
Description X40	30
Diagnosis and trouble shooting	63, 64, 65, 66
Digital communication	69
Digital control	69
Disposal	71
E	
EASYRIDER	72
EASYRIDER Instructions	72
Electrical installation	48, 49, 50, 51, 52, 53
Electromagnetic compatibility (EMC)	54
Eurotherm programming language	73
Example for mounting	56
Extended BIAS-commands	75
F	
Feedback-Sensor-Connection X30	28
Fieldbus interface COM2	37
G	
General technical data	68, 69, 70
Ground connections	48
Grounding, safety grounding	48
H	
Hints for mounting	55
I	
Incremental <u>input</u>	32
Incremental <u>output</u>	31
Installation of the rack	54
M	
measuring pin X10.17	70
measuring pin X10.6	70
Mechanical data	70
Mechanical installation	47
Modification Record	85
Modul – design	38
Mounting	47
O	
Operating modes	44, 45, 46
option modul RP 232	38
option modul RP 422	38
option modul RP 485	38
option modul RP CAN	39
option modul RP EA5	41
option modul RP EAE	42
P	
Power cabling	54
Preparation	59
R	
Reset of a regulator trouble	65
Resolver connection X30	29
Resolvertauswertung / Transmitterprinzip	69
S	
Safety	48
Safety precautions	8
Safety rules	54
Schaltzschrank-Einbau	47
Selection of the brake resistor	51
Setting and programming	58
Signal inputs and outputs	68
Software	72, 73
SSI-Encoder Interface	35
Steckerbelegung für SUCOnet K	39
Stepper motor <u>input</u>	33
Stepper motor <u>input</u>	34
T	
The danger of electric shocks	48
Trouble shooting	66
W	
Wiring instructions	54
Wiring instructions	55, 56, 57
X	
X200	42

16 Notes



17 Modification Record

Version	Modification	Chapter	Date	Name	Comment
Initial				PL	Based on Manual V01.41PL00
V02.49DL00	corrections	-	12.12.2000	N.Dreilich	
V0301	corrections	-	26.04.2001	N.Dreilich	
V0402	compl. modification separation german / english		28.05.2002	N.Dreilich	

AUSTRALIA Eurotherm Pty Ltd.	Unit 10 40 Brookhollow Avenue Baulkham Hills New South Wales 2153	Tel.: +61 (2) 9634 8444 Fax: +61 (2) 96348555	http://www.eurotherm.com.au eurotherm@eurotherm.com.au
AUSTRIA Eurotherm GmbH	Geiereckstrasse 18/1 A1110 Vienna	Tel.: +43 (1) 798 7601 Fax: +43 (1) 798 7605	http://www.eurotherm.at eurotherm@eurotherm.at
BELGIUM Eurotherm BV	Rue du Val-Notre-Dame 384 B-4520 Moha	Tel.: +32 85274080 Fax: +32 85274081	sales@eurotherm-belgium.be
CANADA Eurotherm Drives	530 Seaman Street Unit 3 Stoney Creek Ontario L8E 3X7	Tel.: +1 (905) 664 8911 Fax: +1 (905) 6645869	andy.wright@eurothermdrives.com
DENMARK Eurotherm Drives Danmark	Enghavevej 9D DK-7100 Vejele	Tel.: +45 (70) 201311 Fax: +45 (70) 201312	leif.tangaa@eurotherm.se
FRANCE Eurotherm Vitesse Variable SA	15 Avenue de Norvège Villebon / Yvette 91953 Courtaboeuf Cedex Paris	Tel.: +33 1 (69) 185151 Fax: +33 1 (69) 185159	
GERMANY Eurotherm Antriebstechnik GmbH	Von-Humboldt-Strasse 10 64646 Heppenheim	Tel.: +49 (6252) 798200 Fax: +49 (6252) 798205	http://www.eurotherm.de info@eurotherm.de
HONG KONG Eurotherm Ltd.	Unit D 18/F Gee Chang Hong Centre 65 Wong Chuk Hang Road Aberdeen	Tel.: +852 2873 3826 Fax: +852 2870 0148	eurotherm@eurotherm.com.hk
INDIA Eurotherm India Ltd.	152 Developed Plots Estate Perungudi Chennai 600 096	Tel.: +91 (44) 496 1129 Fax: +91 (44) 496 1831	svs@euromds.rpgms.ems.vsnl.net.in
IRELAND Eurotherm Ireland Ltd.	I.D.A. Industrial Estate Monread Road Naas Co. Kildare	Tel.: +353 (45) 879937 Fax: +353 (45) 875123	
ITALY Eurotherm Drives SPA	Via Gran Sasso 9 20030 Lentate Sul Seveso Milano	Tel.: +39 (0362) 557308 Fax: +39 (0362) 557312	http://www.eurothermdrives.it info@eurothermdrives.it
JAPAN Nemic-Lambda KK Eurotherm Division	Denpa Building 1-11-15 Higahi Gotanda Shinagawa-Ku Tokyo 141-0022	Tel.: +81 (3) 3447 6441 Fax: +81 (3) 3447 6442	http://www.eurotherm.com/japan.htm II9K-IWM@asahi-net.or.jp
KOREA Eurotherm Korea Ltd.	3F J-Building 402-3 Poongnab-Dong Songpa-Ku Seoul 138 040	Tel.: +82 (2) 478 8507 Fax: +82 (2) 488 8508	
NETHERLANDS Eurotherm BV	Genielaan 4 2404CH Alpen aan den Rijn Holland	Tel.: +31 (172) 411 752 Fax: +31 (172) 417 260	http://www.eurotherm.nl sales@eurotherm.nl
NORWAY Eurotherm Drives Norge	Postboks 650 1411 Koltbotn Oslo	Tel.: +47 (66) 992550 Fax: +47 (66) 803131	eurotherm@online.no
SPAIN Eurotherm Espana SA	Calle La Granja 74 Pol. Ind. Alcobendas 28108 Madrid	Tel.: +34 (91) 6616001 Fax: +34 (91) 6619093	eurotherm@teleline.es
SWEDEN Eurotherm Drivteknik AB	Box 9084 S-30013 Halmstad	Tel.: +46 (35) 177300 Fax: +46 (35) 108407	http://www.eurotherm.se info.drives@eurotherm.se
SWITZERLAND Eurotherm Produkte (Schweiz) AG	Schwerzistrasse 20 CH 8807 Freienbach	Tel.: +41 (55) 4154400 Fax: +41 (55) 4154415	epsag@eurotherm.ch
UK Eurotherm Drives Ltd.	New Courtwick Lane Littlehampton West Sussex BN17 7RZ	Tel.: +44 (0) 1903 737000 Fax: +44 (0) 1903 737100	http://www.eurotherm.co.uk info@eurotherm.co.uk
U.S.A. Eurotherm Drives Inc.	9225 Forsyth Park Drive Charlotte North Carolina 28273	Tel.: +1 (704) 588 3246 Fax: +1 (704) 588 3249	http://www.eurothermdrives.com russ.fulle@eurothermdrives.com

Eurotherm Antriebstechnik GmbH

Im Sand 14 • D-76669 Bad Schönborn • Telefon 07253-940 40 • Fax 07253-940 499

E-Mail: info@eurotherm.de • Internet <http://www.eurotherm.de>