

$V_{RSM}$	$V_{RRM}$	(dv/dt) <sub>cr</sub>	$I_{TRMS}$ (maximum value for continuous operation)			
	$V_{DRM}$		180 A			
			$I_{TAV}$ (sin. 180; $T_{case} = 80\text{ °C}$ )			
V	V	V/ $\mu$ s	115 A			
500	400	500	–	–	SKKH 105/04 D	–
700	600	500	SKKT 105/06 D	SKKT 106/06 D	–	SKKH 106/06 D
900	800	500	SKKT 105/08 D	SKKT 106/08 D <sup>1)</sup>	SKKH 105/08 D	SKKH 106/08 D
1300	1200	1000	SKKT 105/12 E	SKKT 106/12 E <sup>1)</sup>	SKKH 105/12 E	SKKH 106/12 E
1500	1400	1000	SKKT 105/14 E	SKKT 106/14 E <sup>1)</sup>	SKKH 105/14 E	SKKH 106/14 E
1700	1600	1000	SKKT 105/16 E	SKKT 106/16 E <sup>1)</sup>	SKKH 105/16 E	SKKH 106/16 E
1900	1800	1000	SKKT 105/18 E	SKKT 106/18 E <sup>1)</sup>	SKKH 105/18 E	SKKH 106/18 E

## SEMIPACK® 1 Thyristor / Diode Modules

**SKKT 105**      **SKKH 105**  
**SKKT 106**      **SKKH 106**  
**SKKT 106B**



Symbol	Conditions	SKKT 105 SKKH 105	SKKT 106 SKKT 106B SKKH 106	Units
$I_{TAV}$	sin. 180; $T_{case} = 85\text{ °C}$		106	A
$I_D$	B2/B6   $T_{amb} = 35\text{ °C}$ ; P 3/180 F P 16/200 F		145 / 180 190 / 260	A
$I_{RMS}$	W1/W3   $T_{amb} = 35\text{ °C}$ ; P 3/180 F		200 / 3 x 140	A
$I_{TSM}$	$T_{vj} = 25\text{ °C}$ ; 10 ms $T_{vj} = 130\text{ °C}$ ; 10 ms		2 250 1 900	A
$i^2t$	$T_{vj} = 25\text{ °C}$ ; 8,3 ... 10 ms $T_{vj} = 130\text{ °C}$ ; 8,3 ... 10 ms		25 000 18 000	A <sup>2</sup> s
$t_{gd}$	$T_{vj} = 25\text{ °C}$ ; $I_G = 1\text{ A}$ $di_G/dt = 1\text{ A}/\mu\text{s}$		1	$\mu\text{s}$
$t_{gr}$	$V_D = 0,67 \cdot V_{DRM}$		2	$\mu\text{s}$
(di/dt) <sub>cr</sub>	$T_{vj} = 130\text{ °C}$		150	A/ $\mu\text{s}$
$t_q$	$T_{vj} = 130\text{ °C}$		typ. 100	$\mu\text{s}$
$I_H$	$T_{vj} = 25\text{ °C}$ ; typ./max.		150 / 250	mA
$I_L$	$T_{vj} = 25\text{ °C}$ ; $R_G = 33\ \Omega$ ; typ./max.		300 / 600	mA
$V_T$	$T_{vj} = 25\text{ °C}$ ; $I_T = 300\text{ A}$		max. 1,65	V
$V_{T(TO)}$	$T_{vj} = 130\text{ °C}$		0,9	V
$r_T$	$T_{vj} = 130\text{ °C}$		2	m $\Omega$
$I_{DD}$ ; $I_{RD}$	$T_{vj} = 130\text{ °C}$ ; $V_{RD} = V_{RRM}$ $V_{DD} = V_{DRM}$		max. 20	mA
$V_{GT}$	$T_{vj} = 25\text{ °C}$ ; d.c.		3	V
$I_{GT}$	$T_{vj} = 25\text{ °C}$ ; d.c.		150	mA
$V_{GD}$	$T_{vj} = 130\text{ °C}$ ; d.c.		0,25	V
$I_{GD}$	$T_{vj} = 130\text{ °C}$ ; d.c.		6	mA
$R_{thjc}$	cont. } sin. 180 } per thyristor / rec. 120 } per module		0,28 / 0,14 0,30 / 0,15 0,32 / 0,16	$^{\circ}\text{C}/\text{W}$
$R_{thch}$			0,2 / 0,1	$^{\circ}\text{C}/\text{W}$
$T_{vj}$			- 40 ... + 130	$^{\circ}\text{C}$
$T_{stg}$			- 40 ... + 125	$^{\circ}\text{C}$
$V_{isol}$	a. c. 50 Hz; r.m.s.; 1 s/1 min		3600 / 3000	V~
$M_1$	to heatsink } to terminals } SI (US) units		5 (44 lb. in.) $\pm 15\%$ <sup>2)</sup>	Nm
$M_2$			3 (26 lb. in.) $\pm 15\%$ <sup>2)</sup>	Nm
a			5 · 9,81	m/s <sup>2</sup>
w	approx.		95	g
Case	→ page B 1 – 95	SKKT 105: A 5 SKKH 105: A 6	SKKT 106: A 46 SKKT 106B: A 48 SKKH 106: A 47	



**SKKT 105**      **SKKH 105**



**SKKT 106**      **SKKH 106**  
**SKKT 106B**

### Features

- Heat transfer through aluminium oxide ceramic isolated metal baseplate
- Hard soldered joints for high reliability
- UL recognized, file no. E 63 532

### Typical Applications

- DC motor control (e.g. for machine tools)
- AC motor soft starters
- Temperature control (e.g. for ovens, chemical processes)
- Professional light dimming (studios, theaters)

<sup>1)</sup> Also available in SKKT 106 B configuration (case A 48)

<sup>2)</sup> See the assembly instructions

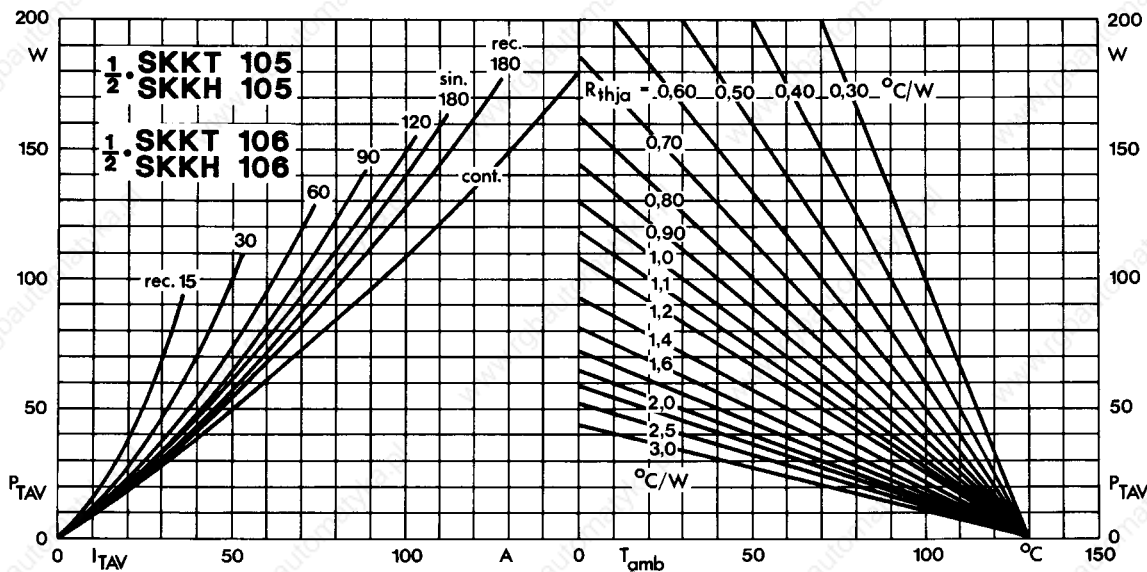

Fig. 1 Power dissipation per thyristor vs. on-state current and ambient temperature

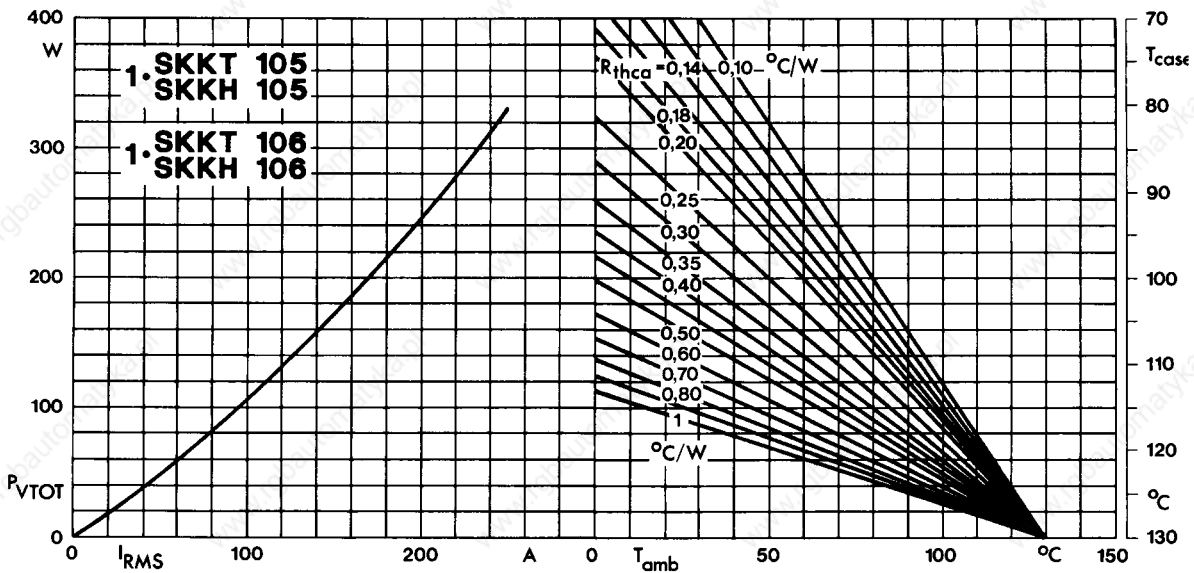

Fig. 2 Power dissipation per module vs. rms current and case temperature

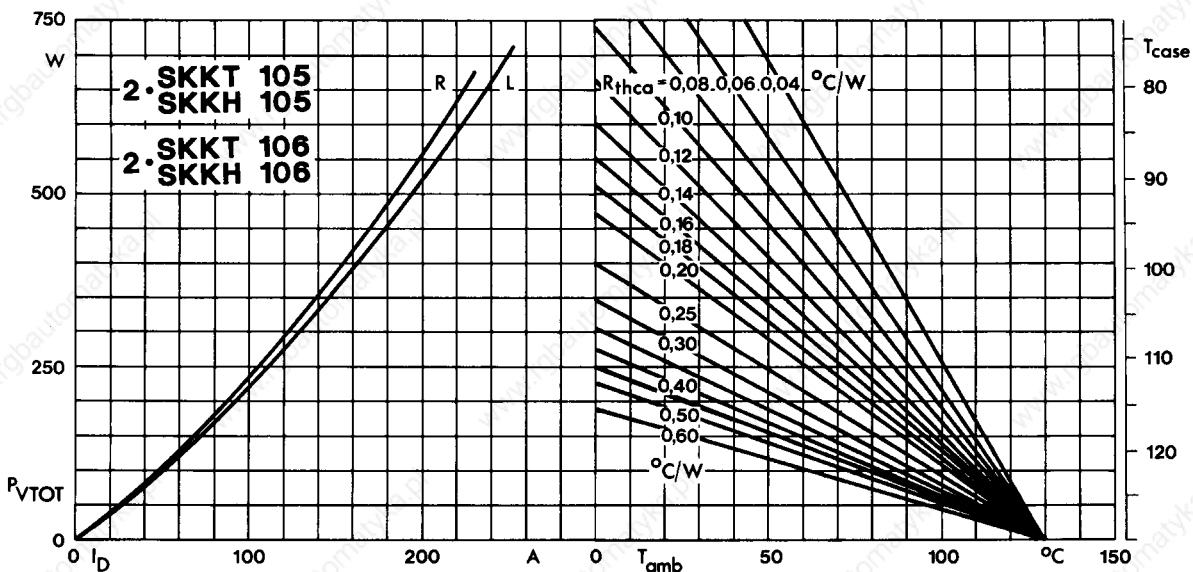

Fig. 3 Power dissipation of two modules vs. direct current and case temperature

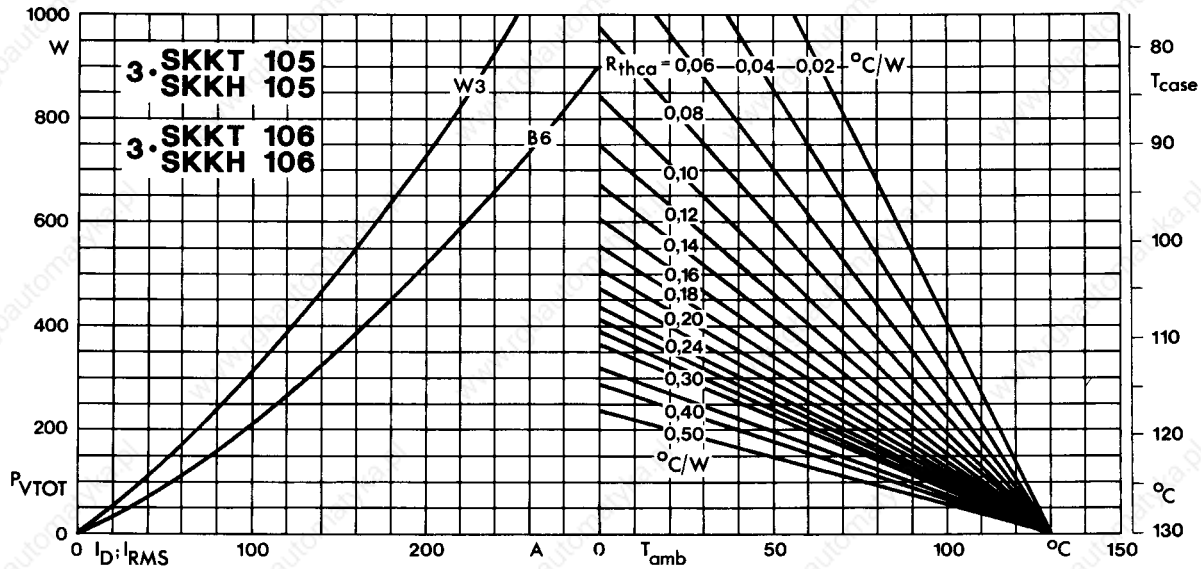

Fig. 4 Power dissipation of three modules vs. direct and rms current and case temperature

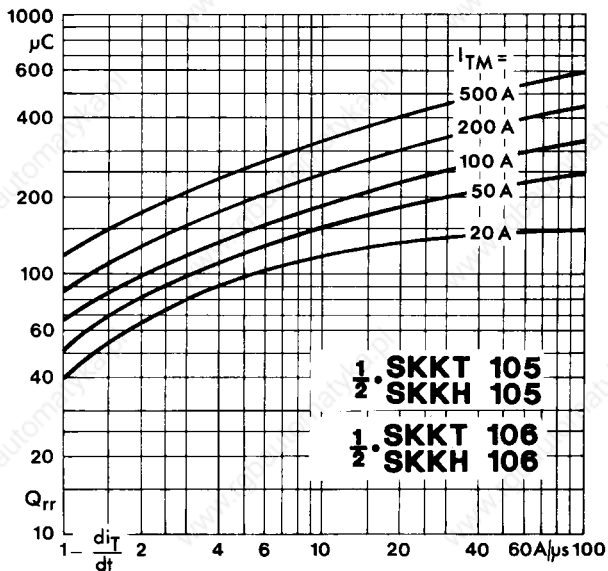

Fig. 5 Recovered charge vs. current decrease

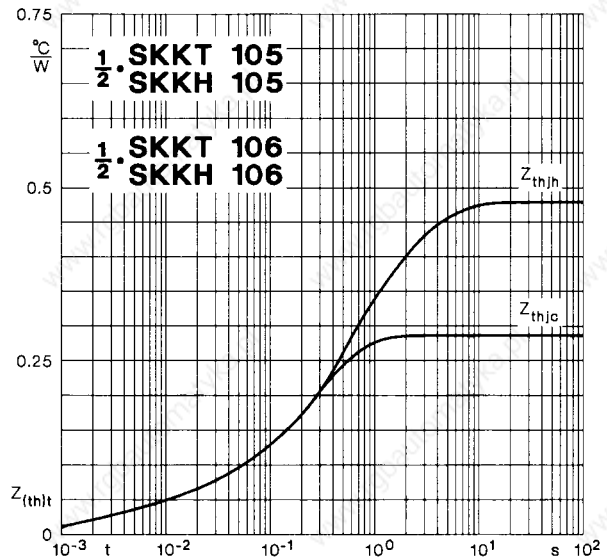

Fig. 6 Transient thermal impedance vs. time

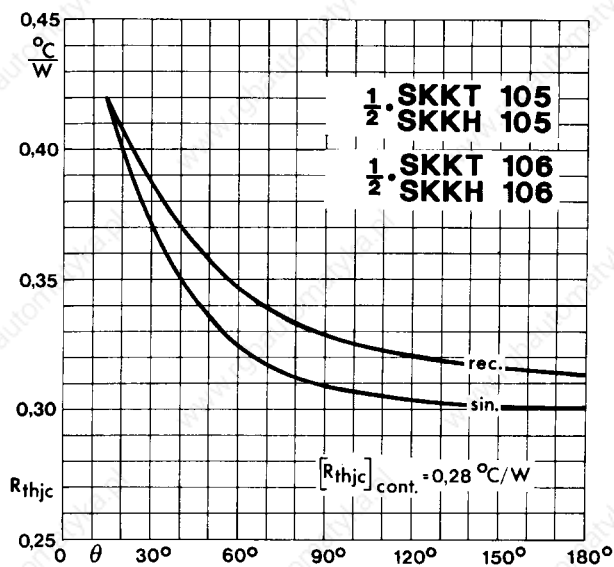

Fig. 7 Thermal resistance vs. conduction angle

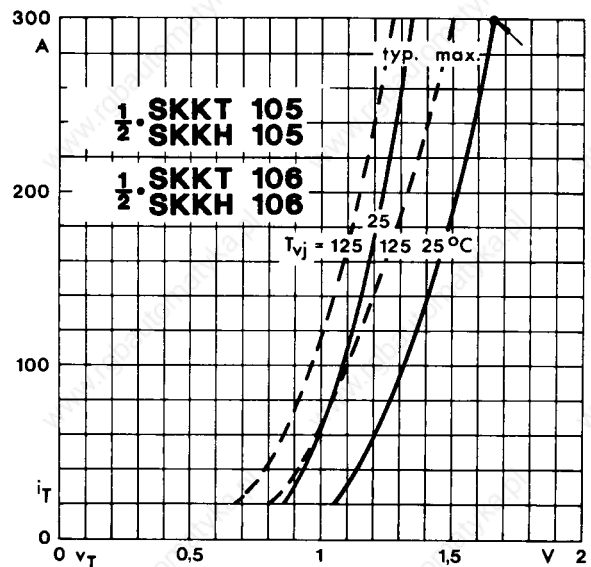

Fig. 8 On-state characteristics

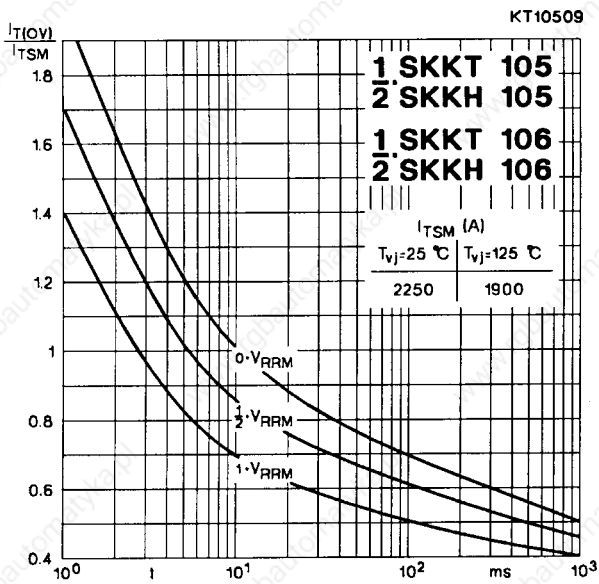

Fig. 9 Surge overload current vs. time

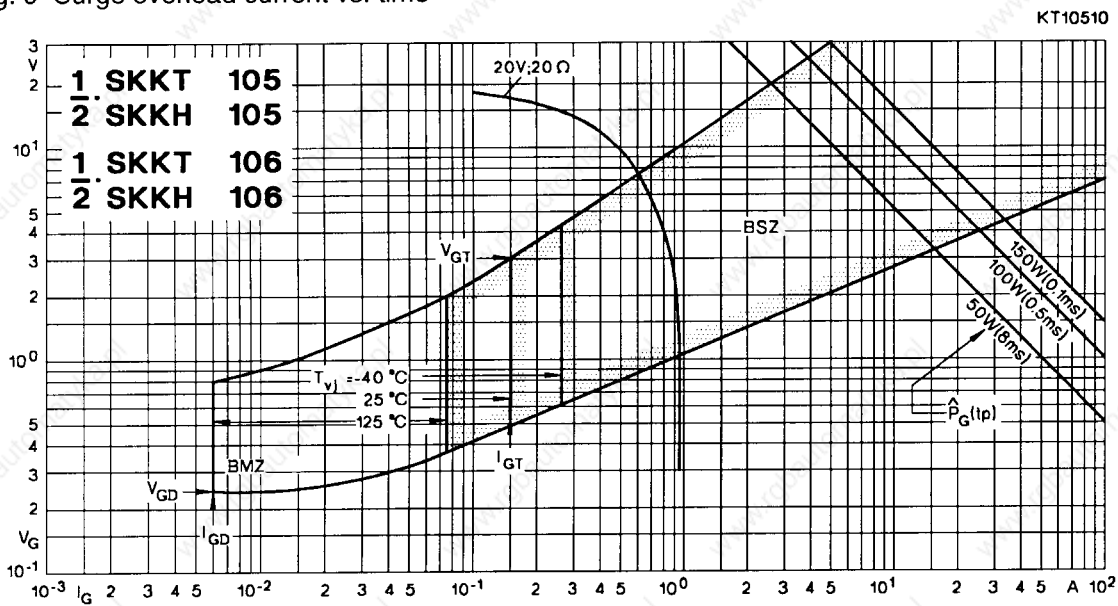

Fig. 10 Gate trigger characteristics

## SKKT 19 ... 105

Case A 5

IEC 192-2: A 77 A

JEDEC: TO-240 AA

SEMIPACK® 1

UL recognized, file no. E 63 532

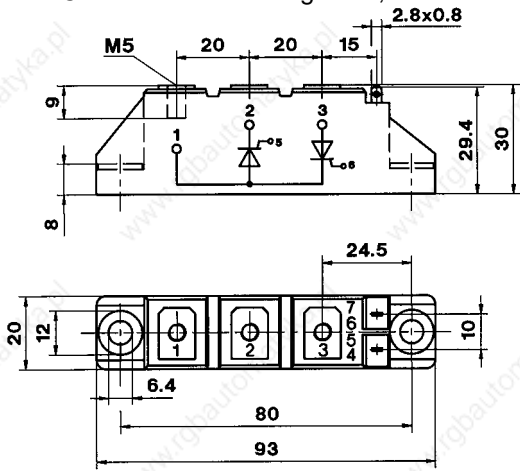

Dimensions in mm

## SKKT 20/ ... 106/

Case A 46

IEC 192-2: A 77 A

JEDEC: TO-240 AA

SEMIPACK® 1

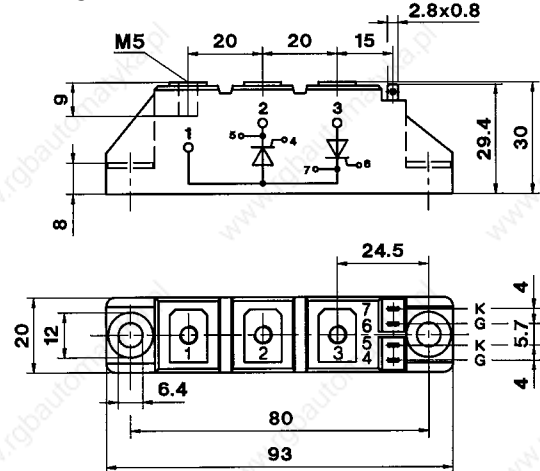

Dimensions in mm

## SKKH 26 ... 105

Case A 6

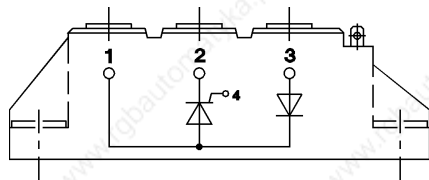

## SKKD 26 ... 100

Case A 10

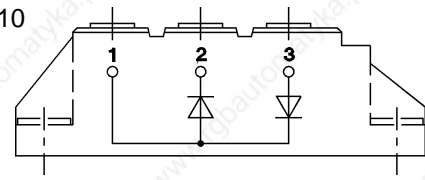

## SKNH 56 ... 91

Case A 7

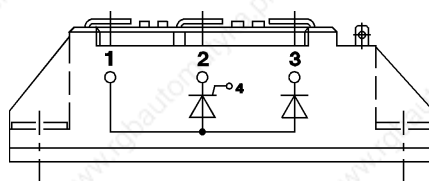

## SKKE 81

Case A 12

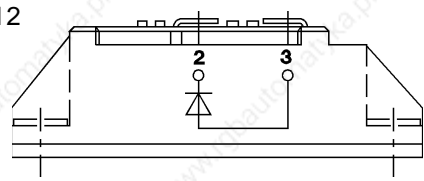

## SKKL 56 ... 105

Case A 9

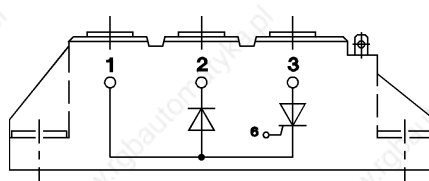

## SKKH 27 ... 106

Case A 47

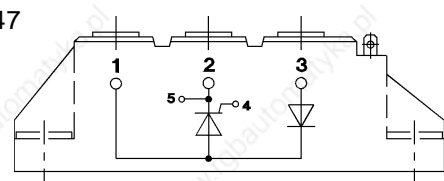

## SKND 46 ... 81

Case A 19

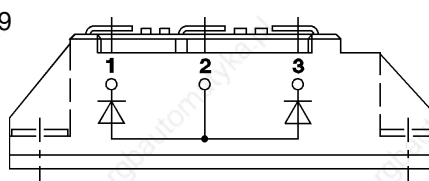

## SKKT 20 B ... 106 B

Case A 48

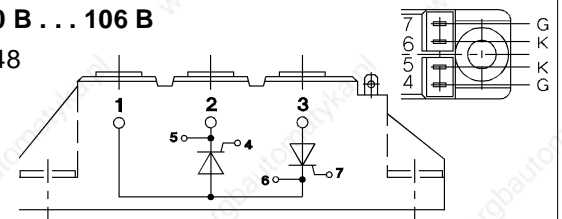

## SKMT 92

Case A 72

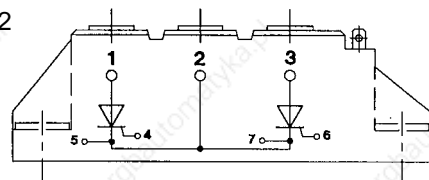

## SKKL 42 ... 106

Case A 59

