



11/91 AWA 27-772

## SUCOS PS 316

### Allgemeine Hinweise

#### Transport, Lagerung, Austausch

Zur Verhinderung elektrostatischer Entladungen empfehlen wir, die Baugruppen nur am Griff und/oder an der Frontplatte anzufassen.



**Die Baugruppen nur bei spannungsloser PS ziehen oder stecken.  
Baugruppencodierung beachten!**

### General notes

#### Transport, storage, exchange

In order to prevent cards being damaged, we recommend that you hold the cards only by the handle and/or the front plate.



**Switch off PS316 before inserting or removing the cards.  
Note the coding of the cards!**

### Remarques générales

#### Transport, stockage, remplacement

Afin d'éviter les décharges électrostatiques, il est recommandé de ne saisir les modules que par la poignée et/ou le plastron.



**Avant d'embrocher ou de débrocher un module, mettre toujours l'automate  
hors tension.  
Attention au codage des modules!**

### Istruzioni generali

#### Trasporto, montaggio, sostituzione

Per evitare che le schede vengano danneggiate si raccomanda di prenderle solo per l'impugnatura e/o sulla piastra frontale.



**Togliere tensione al PS 316 prima di inserire o rimuovere i moduli.  
Fare attenzione alla codifica della scheda!**

### Indicaciones generales

#### Transporte, almacenamiento, sustitución

Para evitar daños en la tarjeta, recomendamos sujetarla solo desde la maneta y/o de la placa frontal.



**Las tarjetas deben insertarse o extraerse sólo con el PS desconectado.  
¡Atención a la codificación de las tarjetas!**

## Baugruppenträgeranordnung

## Rack arrangement

## Disposition des racks

## Disposizione dei rack

## Disposición de los racks

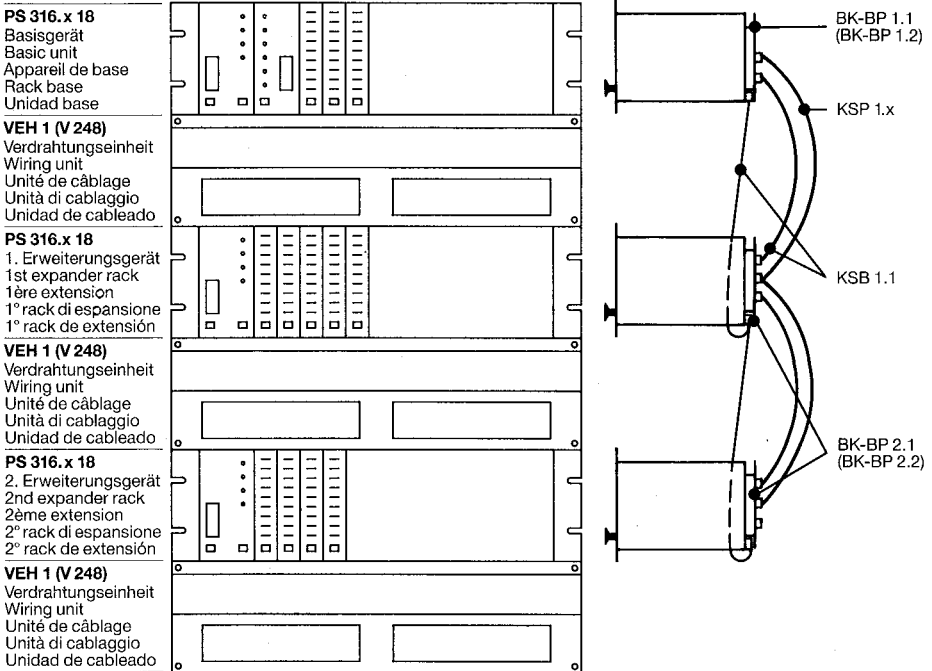

### Achtung:

Typen BK-BPx.1 und BK-BPx.2 nicht gemischt in einem Aufbau verwenden.

### Attention:

Types BK-BPx.1 and BK-BPx.2 cannot be mixed.

### Attention:

Les types BK-BPx.1 et BK-BPx.2 ne doivent pas être combinés.

### Attenzione:

I tipi BK-BPx.1 e BK-BPx.2 non possono essere utilizzati assieme.

### Atención:

Los tipos BK-BPx.1 y BK-BPx.2 no deben mezclarse.

### Montage der Basisgeräte PS 316.x 08 und PS 316.x 12

Kabelklammern aufkleben, Klebestellen vorher mit fettlösendem Reinigungsmittel säubern.

### Fitting the PS 316.x 08 and PS 316.x 12 basic units

Stick the cable clamp in place after cleaning area with a degreasing agent.

### Montage des appareils de base PS 316.x 08 et PS 316.x 12

Coller les attaches de câbles après avoir nettoyé les emplacements avec un solvant de graisses.

### Montaggio dei rack base PS 316.x 08 e PS 316.x 12

Incollare il guida cavo dopo aver pulito la superficie con un solvente per grassi.

### Montaje de las unidades base PS 316.x 08 y PS 316.x 12

Pegar los sujetacables después de limpiar el área con un desengrasante.

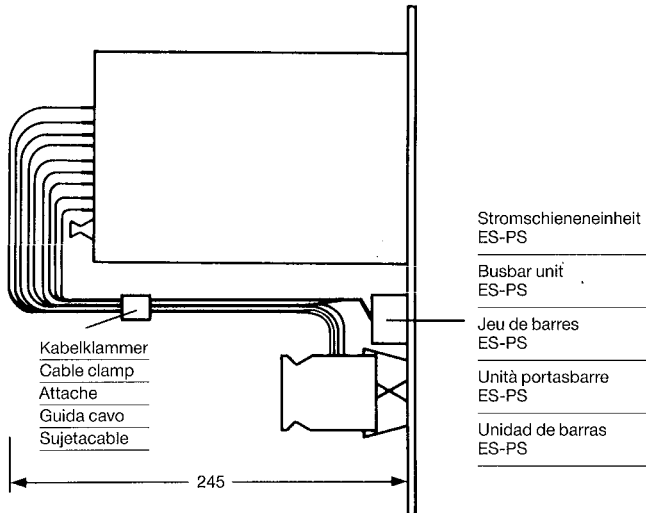

### Verdrahtung

110V-/220V- AC-Leitungen sind getrennt von 24V-DC-Leitungen zu verlegen.

### Wiring

110V/220V a.c. cables are to be laid separately from 24V d.c. cables.

### Câblage

Les lignes 110V/220V CA doivent être posées séparément des lignes 24V CC.

### Cablaggio

Le linee a 110V/220V AC devono essere separate dalle linee a 24V DC

### Conexión

Los cables de 110V/220V AC deben quedar separados de los cables de 24V DC.

# Steckplatzbelegung des Basisgerätes

## Module location of the basic unit

## Affectation des postes d'enchâfrage de l'appareil de base

## Inserimento dei moduli sul rack base

## Ubicación de las tarjetas en la unidad base

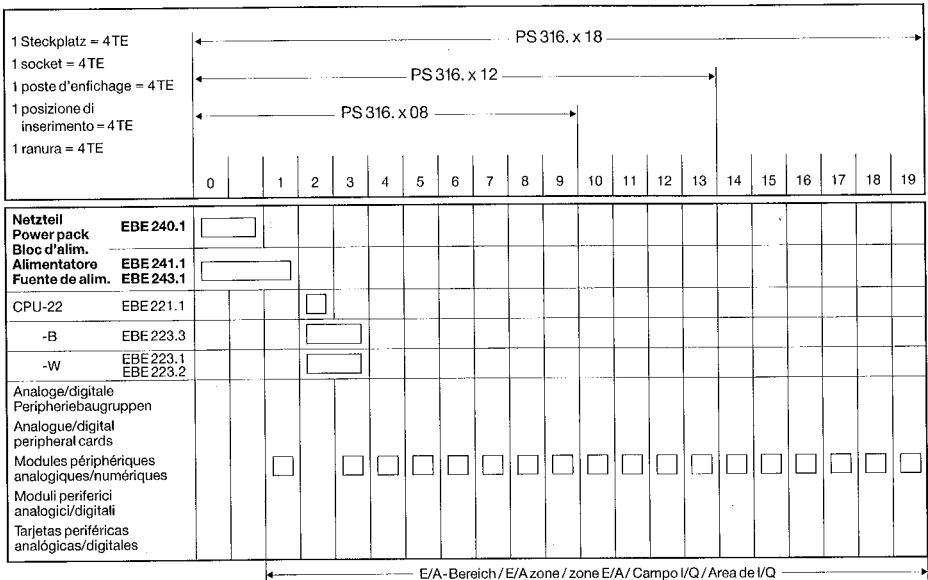

## Systemausbau

Maximal 1 Basisgerät + 4 Erweiterungsgeräte mit BK-BP x. 1  
maximal 1 Basisgerät + 7 Erweiterungsgeräte mit BK-BP x.2  
Bei mehr als 2 Erweiterungsgeräten muß ein Netzfilter FIL-PS vor die Netzteile EBE 241.1 geschaltet werden.

**ACHTUNG:**  
Bei Aufbauten mit mehr als 4 Erweiterungsgeräten müssen für alle Geräte die Buskoppeleinheiten BK-BP x.2 verwendet werden.

---

## System Expansion

Max. 1 basic unit + 4 expander racks with BK-BP x.1  
Max. 1 basic unit + 7 expander racks with BK-BP x.2  
An FIL-PS mains filter must be connected in front of the EBE 241.1 power supply units if more than 2 expander racks are used.

**CAUTION:**  
The BK-BP x.2 bus coupling units must be used for all systems involving more than 4 expander racks.

---

## Extension du système

Max. 1 appareil de base + 4 appareils d'extension avec BK-BP x.1  
Max. 1 appareil de base + 7 appareils d'extension avec BK-BP x.2  
S'il y a plus de 2 appareils d'extension, un filtre d'alimentation doit être connecté en série avec les blocs d'alimentation EBE 241.1

**ATTENTION:**  
Pour les systèmes avec plus de 4 appareils d'extension, les unités de couplage pour bus BK-BP x.2 doivent être utilisés pour tous les appareils.

---

## Espansione del sistema

Max. 1 rack base + 4 rack espansione con BK-BP x.1  
Max. 1 rack base + 7 rack espansione con BK-BP x.2  
Se vengono utilizzati più di 2 rack di espansione deve essere montato un filtro di alimentazione sul lato frontale dell'alimentatore EBE 241.1.

**ATTENZIONE:**  
Per i sistemi con più di 4 rack di espansione devono essere utilizzate le unità di accoppiamento bus BK-BP x.2.

---

## Configuración del sistema

1 unidad base + 4 racks de extensión con BK-BP x.1 como máximo  
1 unidad base + 7 racks de extensión con BK-BP x.2 como máximo  
En sistemas con más de 2 racks de extensión debe utilizarse un filtro FIL-PS para las fuentes de alimentación EBE 241.1

**ATENCION:**  
En sistemas con más de 4 racks de extensión deben utilizarse en todos los racks las tarjetas de acoplamiento de bus BK-BP x.2.

# Buskopplung zu Erweiterungsgeräten

## Bus coupling for expander racks

### Couplage des bus pour appareils d'extension

### Collegamento bus per rack di espansione

### Acoplamiento de bus a racks de extensión

#### Montage

#### Installation

#### Montage

#### Montaggio

#### Montaje

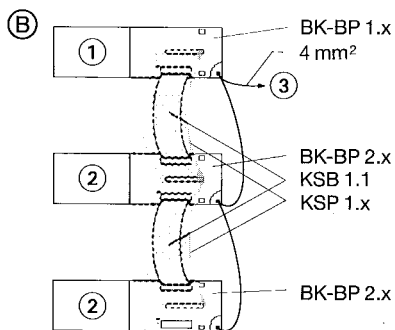
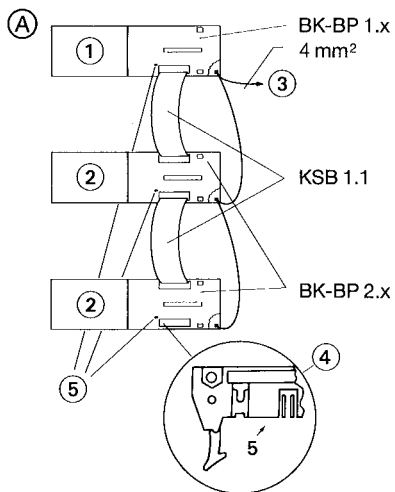
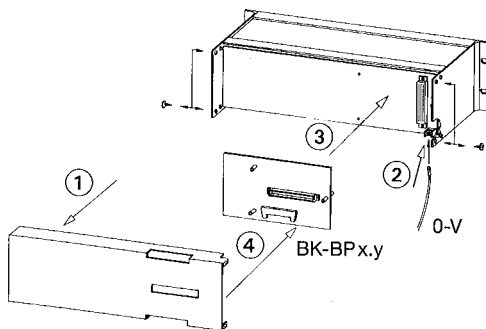

## Kodierung / Kabelanschluß

- Ⓐ Bit-I/O-Buskopplung
  - Ⓑ Parallelbuskopplung
- ① Basisgerät (Rückseite)
  - ② Erweiterungsgerät (Rückseite)
  - ③ Bei Betrieb mit potentialgebundenen Baugruppen (z. B. EBE 200, EBE 250): 0-V-Brücke zur Spannungsversorgung der potentialgebundenen Baugruppe.
  - ④ Jumper auf Stiftpaar Nr. 5 (von links)
  - ⑤ Kodierbrücke: immer offen
- 

## Coding / Cable connection

- Ⓐ Bit-I/O-Bus coupling
  - Ⓑ Parallel bus coupling
- ① Basic unit (rear)
  - ② Expander unit (rear)
  - ③ For potential-dependent modules, e. g. EBE 200 and EBE 250, connect the 0V-bridge to the power supply of the potential-dependent module concerned.
  - ④ Jumper on pin pair No. 5 (from left)
  - ⑤ Coding: always open
- 

## Codage / Raccordement des câbles

- Ⓐ Couplage de bus bit E/S
  - Ⓑ Couplage de bus parallèle
- ① Appareil de base (face arrière)
  - ② Appareil d'extension (face arrière)
  - ③ Pour opération sous potentiel (EBE 200, EBE 250): Pont 0V pour bloc d'alimentation des modules sous potentiel.
  - ④ Shunt sur paire de broches no. 5 (vu de gauche)
  - ⑤ Codage: toujours ouvert
- 

## Codifica / collegamento cavi

- Ⓐ Collegamento del bus a bit I/O
  - Ⓑ Collegamento del bus parallelo
- ① Rack di base (retro)
  - ② Rack di espansione (retro)
  - ③ Per il funzionamento con moduli non separati galvanicamente (p. es. EBE 200, EBE 250) ponte 0V per l'alimentazione dei moduli non separati galvanicamente.
  - ④ Jumper su coppia di spine N° 5 (da sinistra)
  - ⑤ Ponte di codifica: sempre aperto.
- 

## Codificación / Conexión de cables

- Ⓐ Acoplamiento del bus de I/Q de bit
  - Ⓑ Acoplamiento del bus paralelo
- ① Unidad base (parte posterior)
  - ② Rack de extensión (parte posterior)
  - ③ Al usar tarjetas con potencial (p. e. EBE 200, EBE 250): puente 0V a la alimentación de la tarjeta con potencial.
  - ④ Puente en pins N° 5 (desde la izquierda)
  - ⑤ Codificación: siempre abierto
-

## Stromversorgungen

Eine Kombination der Typen EBE241.1 und EBE243.1 in einem Aufbau ist unzulässig. EBE 240.1 nur für Einzelgeräte verwenden.

### Kodierung der EBE 241.1 / EBE 243.1

- ① Überwachungsfunktionen (BUS aktiv und LOOP)

---

## Power supplies

A combination of types EBE 241.1 and EBE 243.1 is not permissible. Use type EBE 240.1 only for basic units without expander racks.

### Coding of EBE 241.1 / EBE 243.1

- ① Monitoring functions (BUS ACTIVE with LOOP)

---

## Alimentations

L'utilisation simultanée des EBE 241.1 et EBE 243.1 est interdite. Utiliser EBE 240.1 seulement pour appareils de base sans appareils d'extension.

### Codage de l'EBE 241.1 / EBE 243.1

- ① Fonctions de surveillance (BUS ACTIVE et LOOP)

---

## Alimentazione

Non è possibile la combinazione dei moduli EBE 241.1 e EBE 243.1 nella stessa configurazione. Utilizzare il tipo EBE 240.1 solo per rack base senza rack espansione.

### Codifica dell'EBE 241.1 / EBE 243.1

- ① Funzioni di controllo (BUS ATTIVO e LOOP)

---

## Fuentes de alimentación

Una combinación de las tarjetas EBE 241.1 y EBE 243.1 en el mismo sistema no está permitido. La tarjeta EBE 240.1 debe utilizarse solo en unidades base (sin racks de extensión).

### Codificación de la EBE 241.1 / EBE 243.1

- ① Función de supervisión (BUS ACTIVO y LOOP)



EBE 241.1/  
EBE 243.1

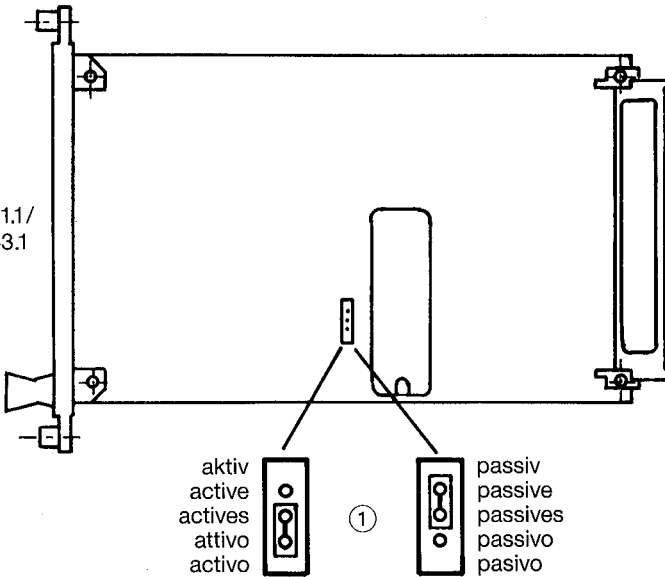

**Achtung!**

Bei Parallelbusbetrieb ist nur die Kodierung „aktiv“ erlaubt!

**Caution!**

Only “active” coding permissible with parallel bus operation.

**Attention!**

En cas de fonctionnement avec bus parallèle, seul le codage «actives» est admis.

**Attenzione!**

In caso di funzionamento con bus parallelo è ammessa soltanto una codifica “attiva”.

**¡Atención!**

En caso de funcionamiento con el bus paralelo, sólo se permite la codificación “activo”.

# Maßtabellen / Dimensions / Encombres / Dimensioni / Dimensiones

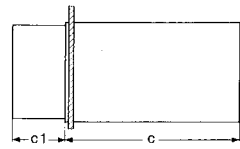
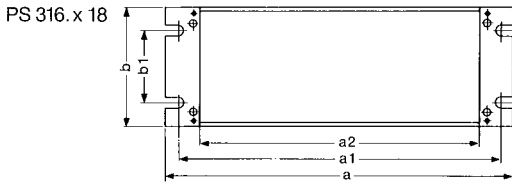

PS 316. x 18

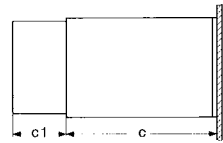
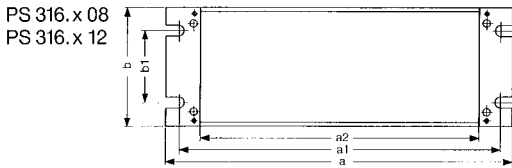

PS 316. x 08/ . x 12

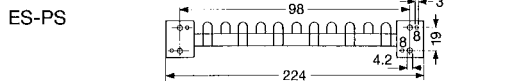
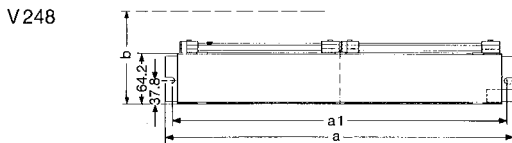
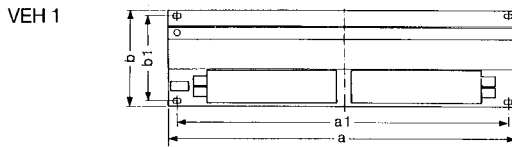

**Typ/Type/Référence**

Tipo/Tipo	a	a1	a2	b	b1	c	c1
<b>PS 316. x 08</b>	288	275	255	132,5	100	205	—
<b>dito +SAM</b>						—	50
<b>dito +SEM</b>						—	68
<b>dito +S2...</b>						—	70
<b>PS 316. x 12</b>	362	350	336	132,5	100	205	—
<b>dito +SAM</b>						—	50
<b>dito +SEM</b>						—	68
<b>dito +S2...</b>						—	70
<b>PS 316. x 18</b>	483	465	427	132,5	57	230	—
<b>dito +SAM</b>						—	50
<b>dito +SEM</b>						—	68
<b>dito +S2...</b>						—	70
<b>VEH 1</b>	483	465	—	132,5	120,5	—	—
<b>V248</b>	483	465	—	88	—	—	—
<b>MBP 3</b>	483	465	—	132,5	120,5	—	—
<b>MBP 1</b>	483	465	—	43,6	31,7	—	—

<b>Codierung</b>	Alle Baugruppen dürfen nur bei ausgeschalteter Versorgungsspannung ausgetauscht werden.	<b>Schalter</b>	0 = off/open	1 = on
<b>Coding</b>	Cards must be exchanged only while the supply voltage is disconnected.	<b>Switches</b>		
<b>Codage</b>	Les modules doivent tous être remplacés hors tension.	<b>Codeurs</b>		
<b>Codifica</b>	Togliere tensione prima di inserire o rimuovere i moduli.	<b>Interruttori</b>		
<b>Codificación</b>	Las tarjetas deben insertarse o extraerse sólo con la alimentación desconectada.	<b>Codificador</b>		

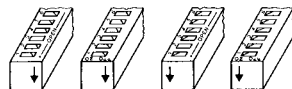

Baugruppentyp / Module Type / Type de module /  
Tipi di moduli / Tipo de tarjeta

Schalternummer / Switch Number / No. de microrrupteur /  
N° interruttore / N° de codificador

A				1 2 3 4 5								
EBE 261		B		1 2 3 4 5 6								
		C		S8								
				1 2 3 4 5 6 7								
				D								
		EBE 253		1 2 3 4 5 6 7 8								
0.0...1.15	0.0...0.15	0.0...0.7	0.0...0.3	1	1	1	1	1	1	1	1	
			0.4...0.7	0	1	1	1	1	1	1		
			0.8...0.15	1	0	1	1	1	1	1		
	1.0...1.15	1.0...1.7	0.12...0.15	0	0	1	1	1	1	1		
			1.0...1.3	1	1	0	1	1	1	1		
			1.4...1.7	0	1	0	1	1	1	1		
			1.8...1.11	1	0	0	1	1	1	1		
			1.12...1.15	0	0	0	1	1	1	1		
			2.0...2.7	1	1	1	0	1	1	1		
	2.0...3.15	2.0...2.15	2.4...2.7	0	1	1	0	1	1	1		
			2.8...2.11	1	0	1	0	1	1	1		
			2.12...2.15	0	0	1	0	1	1	1		
3.0...3.15		3.0...3.7	1	1	0	0	1	1	1			
		3.4...3.7	0	1	0	0	1	1	1			
		3.8...3.11	1	0	0	0	1	1	1			
4.0...5.15	4.0...4.15	3.12...3.15	0	0	0	0	1	1	1			
		4.0...4.7	1	1	1	1	0	1	1			
		4.4...4.7	0	1	1	1	0	1	1			
		4.8...4.11	1	0	1	1	0	1	1			
		4.12...4.15	0	0	1	1	0	1	1			
		5.0...5.7	1	1	0	1	0	1	1			
	5.0...5.15	5.0...5.7	5.4...5.7	0	1	0	1	0	1	1		
			5.8...5.11	1	0	0	1	0	1	1		
			5.12...5.15	0	0	0	1	0	1	1		
			6.0...7.15	6.0...6.15	6.0...6.3	1	1	1	0	0	1	1
					6.4...6.7	0	1	1	0	0	1	1
					6.8...6.11	1	0	1	0	0	1	1
7.0...7.15	6.12...6.15	0		0	1	0	0	1	1			
	7.0...7.7	1		1	0	0	0	1	1			
	7.4...7.7	0		1	0	0	0	1	1			
7.0...7.15	7.8...7.15	7.8...7.11	1	0	0	0	0	1	1			
		7.12...7.15	0	0	0	0	0	1	1			
		8.0...9.15	8.0...8.15	8.0...8.3	1	1	1	1	1	0	1	
				8.4...8.7	0	1	1	1	1	0	1	
				8.8...8.11	1	0	1	1	1	0	1	
				8.12...8.15	0	0	1	1	1	0	1	
9.0...9.3	1			1	0	1	1	0	1			
9.4...9.7	0			1	0	1	1	0	1			
9.0...9.15	9.8...9.15		9.8...9.11	1	0	0	1	1	0	1		
			9.12...9.15	0	0	0	1	1	0	1		

**Codierung** Alle Baugruppen dürfen nur bei ausgeschalteter Versorgungsspannung ausgewechselt werden.

**Coding** Cards must be exchanged only while the supply voltage is disconnected.

**Codage** Les modules doivent tous être remplacés hors tension.

**Codifica** Togliere tensione prima di inserire o rimuovere i moduli.

**Codificación** Las tarjetas deben insertarse o extraerse sólo con la alimentación desconectada.

**Schalter** 0 = off/open      1 = on

**Switches**

**Codeurs**

**Interruttori**

**Codificador**

**Baugruppentyp / Module Type / Type de module /**  
**Tipi di moduli / Tipo de tarjeta**

**Schalternummer / Switch Number / No. de microrupteur /**  
**N° interruptores / N° de codificador**

A	B	C	D									
			1 2 3 4 5 6 7 8									
			1	2	3	4	5	6	7	8		
10.0...11.15	10.0...10.15	10.0...10.7	10.0...10.3	1	1	1	0	1	0	1	1	
			10.4...10.7	0	1	1	0	1	0	1	1	
			10.8...10.15	1	0	1	0	1	0	1	1	
		11.0...11.15	11.0...11.7	10.12...10.15	0	0	1	0	1	0	1	1
				11.0...11.3	1	1	0	0	1	0	1	1
				11.4...11.7	0	1	0	0	1	0	1	1
	11.8...11.15		11.8...11.11	1	0	0	0	1	0	1	1	
			11.12...11.15	0	0	0	0	1	0	1	1	
			12.0...12.15	1	1	1	1	0	0	1	1	
	12.0...13.15	12.0...12.15	12.0...12.7	12.0...12.3	1	1	1	1	0	0	1	1
				12.4...12.7	0	1	1	1	0	0	1	1
				12.8...12.15	1	0	1	1	0	0	1	1
13.0...13.15			12.12...12.15	0	0	1	1	0	0	1	1	
			13.0...13.7	1	1	0	1	0	0	1	1	
			13.4...13.7	0	1	0	1	0	0	1	1	
		13.8...13.15	13.8...13.11	1	0	0	1	0	0	1	1	
			13.12...13.15	0	0	0	1	0	0	1	1	
			14.0...14.15	1	1	1	0	0	0	1	1	
14.0...15.15		14.0...14.15	14.0...14.7	14.0...14.3	1	1	1	0	0	0	1	1
				14.4...14.7	0	1	1	0	0	0	1	1
				14.8...14.15	1	0	1	0	0	0	1	1
	15.0...15.15		14.12...14.15	0	0	1	0	0	0	1	1	
			15.0...15.7	1	1	0	0	0	0	1	1	
			15.4...15.7	0	1	0	0	0	0	1	1	
		15.8...15.15	15.8...15.11	1	0	0	0	0	0	1	1	
			15.12...15.15	0	0	0	0	0	0	1	1	
			16.0...16.15	1	1	1	1	1	1	0	1	
	16.0...17.15	16.0...16.15	16.0...16.7	16.0...16.3	0	1	1	1	1	1	0	1
				16.4...16.7	1	0	1	1	1	1	0	1
				16.8...16.15	0	0	1	1	1	1	0	1
17.0...17.15			16.12...16.15	0	0	1	1	1	1	0	1	
			17.0...17.7	1	1	0	1	1	1	0	1	
			17.4...17.7	0	1	0	1	1	1	0	1	
		17.8...17.15	17.8...17.11	1	0	0	1	1	1	0	1	
			17.12...17.15	0	0	0	1	1	1	0	1	
			18.0...18.15	1	1	1	0	1	1	0	1	
18.0...19.15		18.0...18.15	18.0...18.7	18.0...18.3	0	1	1	0	1	1	0	1
				18.4...18.7	1	0	1	0	1	1	0	1
				18.8...18.15	0	0	1	0	1	1	0	1
	19.0...19.15		18.12...18.15	0	0	1	0	1	1	0	1	
			19.0...19.7	1	1	0	0	1	1	0	1	
			19.4...19.7	0	1	0	0	1	1	0	1	
		19.8...19.15	19.8...19.11	1	0	0	0	1	1	0	1	
			19.12...19.15	0	0	0	0	1	1	0	1	
			20.0...20.15	1	1	1	1	0	1	0	1	
	20.0...21.15	20.0...20.15	20.0...20.7	20.0...20.3	0	1	1	1	0	1	0	1
				20.4...20.7	1	0	1	1	0	1	0	1
				20.8...20.15	1	0	1	1	0	1	0	1
21.0...21.15			20.12...20.15	0	0	1	1	0	1	0	1	
			21.0...21.7	1	1	0	1	0	1	0	1	
			21.4...21.7	0	1	0	1	0	1	0	1	
		21.8...21.15	21.8...21.11	1	0	0	1	0	1	0	1	
			21.12...21.15	0	0	0	1	0	1	0	1	
			22.0...22.15	1	1	1	0	0	1	0	1	
22.0...23.15		22.0...22.15	22.0...22.7	22.0...22.3	0	1	1	0	0	1	0	1
				22.4...22.7	1	0	1	0	0	1	0	1
				22.8...22.15	1	0	1	0	0	1	0	1
	23.0...23.15		22.12...22.15	0	0	1	0	0	1	0	1	
			23.0...23.7	1	1	0	0	0	1	0	1	
			23.4...23.7	0	1	0	0	0	1	0	1	
		23.8...23.15	23.8...23.11	1	0	0	0	0	1	0	1	
			23.12...23.15	0	0	0	0	0	1	0	1	

<b>Codierung</b>	Alle Baugruppen dürfen nur bei ausgeschalteter Versorgungsspannung ausgetauscht werden.	<b>Schalter</b>	0 = off/open	1 = on
<b>Coding</b>	Cards must be exchanged only while the supply voltage is disconnected.	<b>Switches</b>		
<b>Codage</b>	Les modules doivent tous être remplacés hors tension.	<b>Codeurs</b>		
<b>Codifica</b>	Togliere tensione prima di inserire o rimuovere i moduli.	<b>Interruttori</b>		
<b>Codificación</b>	Las tarjetas deben insertarse o extraerse sólo con la alimentación desconectada.	<b>Codificador</b>		

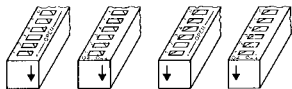

Baugruppentyp / Module Type / Type de module /  
 Tipi di moduli / Tipo de tarjeta

Schalternummer / Switch Number / No. de microrrupteur /  
 N° interruttore / N° de codificador

A	B	C	D										
			1		2		3		4				
			1	2	3	4	5	6	7	8			
			1	2	3	4	5	6	7	8			
24.0...25.15	24.0...24.15	24.0...24.7	24.0...24.3	1	1	1	1	1	0	0	0	1	
			24.4...24.7	0	1	1	1	1	0	0	0	1	
			24.8...24.15	1	0	1	1	1	0	0	0	1	
	25.0...25.15	25.0...25.7	24.12...24.15	0	0	1	1	1	0	0	0	1	
			25.0...25.3	1	1	0	1	1	0	0	0	1	
			25.4...25.7	0	1	0	1	1	0	0	0	1	
26.0...27.15	26.0...26.15	26.0...26.7	25.8...25.15	1	0	0	1	1	0	0	0	1	
			26.0...26.3	1	1	1	0	1	0	0	0	1	
			26.4...26.7	0	1	1	0	1	0	0	0	1	
	27.0...27.15	26.8...26.15	26.8...26.11	1	0	1	0	1	0	0	0	1	
			26.12...26.15	0	0	1	0	1	0	0	0	1	
			27.0...27.7	1	1	0	0	1	0	0	0	1	
28.0...29.15	27.0...27.15	27.0...27.7	27.4...27.7	0	1	0	0	1	0	0	0	1	
			27.8...27.11	1	0	0	0	1	0	0	0	1	
			27.12...27.15	0	0	0	0	1	0	0	0	1	
	28.0...28.15	28.0...28.15	28.0...28.7	28.0...28.3	1	1	1	1	0	0	0	0	1
				28.4...28.7	0	1	1	1	0	0	0	0	1
				28.8...28.15	1	0	1	1	0	0	0	0	1
29.0...29.15		28.12...28.15	28.12...28.15	0	0	1	1	0	0	0	0	1	
			29.0...29.7	1	1	0	1	0	0	0	0	1	
			29.4...29.7	0	1	0	1	0	0	0	0	1	
30.0...31.15	29.0...29.15	29.8...29.15	29.8...29.11	1	0	0	1	0	0	0	0	1	
			29.12...29.15	0	0	0	1	0	0	0	0	1	
			30.0...30.7	1	1	1	0	0	0	0	0	1	
	31.0...31.15	30.0...30.15	30.0...30.7	30.4...30.7	0	1	1	0	0	0	0	0	1
				30.8...30.11	1	0	1	0	0	0	0	0	1
				30.12...30.15	0	0	1	0	0	0	0	0	1
31.0...31.15		31.0...31.7	31.0...31.3	1	1	0	0	0	0	0	0	1	
			31.4...31.7	0	1	0	0	0	0	0	0	1	
			31.8...31.11	1	0	0	0	0	0	0	0	1	
32.0...33.15	31.8...31.15	31.12...31.15	31.12...31.15	0	0	0	0	0	0	0	0	1	
			32.0...32.7	1	1	1	1	1	1	1	0		
			32.4...32.7	0	1	1	1	1	1	1	0		
	33.0...33.15	32.0...32.15	32.8...32.15	32.8...32.11	1	0	1	1	1	1	1	0	
				32.12...32.15	0	0	1	1	1	1	1	0	
				33.0...33.7	1	1	0	1	1	1	1	0	
33.0...33.15		33.0...33.7	33.4...33.7	0	1	0	1	1	1	1	0		
			33.8...33.11	1	0	0	1	1	1	1	0		
			33.12...33.15	0	0	0	1	1	1	1	0		
34.0...35.15	33.8...33.15	34.0...34.7	34.0...34.3	1	1	1	0	1	1	1	0		
			34.4...34.7	0	1	1	0	1	1	1	0		
			34.8...34.11	1	0	1	0	1	1	1	0		
	35.0...35.15	34.12...34.15	34.12...34.15	0	0	1	0	1	1	1	0		
			35.0...35.7	1	1	0	0	1	1	1	0		
			35.4...35.7	0	1	0	0	1	1	1	0		
36.0...37.15	35.0...35.15	35.8...35.15	35.8...35.11	1	0	0	0	1	1	1	0		
			35.12...35.15	0	0	0	0	1	1	1	0		
			36.0...36.7	1	1	1	0	1	1	1	0		
	36.0...36.15	36.4...36.7	36.4...36.7	0	1	1	1	0	1	1	0		
			36.8...36.11	1	0	1	1	0	1	1	0		
			36.12...36.15	0	0	1	1	0	1	1	0		
37.0...37.15	36.8...36.15	37.0...37.7	37.0...37.3	1	1	0	1	0	1	1	0		
			37.4...37.7	0	1	0	1	0	1	1	0		
			37.8...37.11	1	0	0	1	0	1	1	0		
	37.0...37.15	37.4...37.7	37.4...37.7	0	1	0	0	1	0	1	1		
			37.8...37.11	1	0	0	1	0	1	1	0		
			37.12...37.15	0	0	0	1	0	1	1	0		

**Codierung** Alle Baugruppen dürfen nur bei ausgeschalteter Versorgungsspannung ausgetauscht werden.

**Coding** Cards must be exchanged only while the supply voltage is disconnected.

**Codage** Les modules doivent tous être remplacés hors tension.

**Codifica** Togliere tensione prima di inserire o rimuovere i moduli.

**Codificación** Las tarjetas deben insertarse o extraerse sólo con la alimentación desconectada.

**Schalter** 0 = off/open      1 = on

**Switches**

**Codeurs**

**Interruttori**

**Codificador**

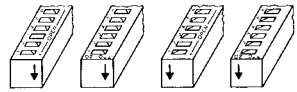

**Baugruppentyp / Module Type / Type de module /  
Tipi di moduli / Tipo de tarjeta**

**Schalternummer / Switch Number / No. de microrrupteur /  
N° interruttore / N° de codificador**

A	B	C	D									
				1				2				
				1	2	3	4	5	6	7	8	
				1	2	3	4	5	6	7	8	
38.0...39.15	38.0...38.15	38.0...38.7	38.0...38.3	1	1	1	0	0	1	1	0	
			38.4...38.7	0	1	1	0	0	1	1	0	
			38.8...38.15	1	0	1	0	0	1	1	0	
	39.0...39.15	39.0...39.7	38.12...38.15	0	0	1	0	0	1	1	0	
			39.0...39.3	1	1	0	0	0	1	1	0	
			39.4...39.7	0	1	0	0	0	1	1	0	
40.0...41.15	40.0...40.15	40.0...40.7	39.8...39.15	1	0	0	0	0	1	1	0	
			39.12...39.15	0	0	0	0	0	1	1	0	
			40.0...40.3	1	1	1	1	1	0	1	0	
	41.0...41.15	41.0...41.7	40.4...40.7	0	1	1	1	1	0	1	0	
			40.8...40.15	1	0	1	1	1	0	1	0	
			40.12...40.15	0	0	1	1	1	0	1	0	
42.0...43.15	42.0...42.15	42.0...42.7	41.0...41.3	1	1	0	1	1	0	1	0	
			41.4...41.7	0	1	0	1	1	0	1	0	
			41.8...41.15	1	0	0	1	1	0	1	0	
	43.0...43.15	43.0...43.7	41.12...41.15	0	0	0	1	1	0	1	0	
			42.0...42.3	1	1	1	0	1	0	1	0	
			42.4...42.7	0	1	1	0	1	0	1	0	
44.0...45.15	44.0...44.15	44.0...44.7	42.8...42.15	1	0	1	0	1	0	1	0	
			42.12...42.15	0	0	1	0	1	0	1	0	
			43.0...43.3	1	1	0	0	1	0	1	0	
	45.0...45.15	45.0...45.7	43.4...43.7	0	1	0	0	1	0	1	0	
			43.8...43.15	1	0	0	0	1	0	1	0	
			43.12...43.15	0	0	0	1	0	1	0	1	
46.0...47.15	46.0...46.15	46.0...46.7	44.4...44.7	1	1	1	1	0	0	1	0	
			44.8...44.15	0	1	1	1	0	0	1	0	
			44.12...44.15	1	0	1	1	0	0	1	0	
	47.0...47.15	47.0...47.7	45.0...45.3	0	0	1	1	0	0	1	0	
			45.4...45.7	0	1	0	1	0	0	1	0	
			45.8...45.15	1	0	0	1	0	0	1	0	
48.0...49.15	48.0...48.15	48.0...48.7	45.12...45.15	0	0	0	1	0	0	1	0	
			46.0...46.3	1	1	1	0	0	0	1	0	
			46.4...46.7	0	1	1	0	0	0	1	0	
	49.0...49.15	49.0...49.7	46.8...46.15	1	0	1	0	0	0	1	0	
			46.12...46.15	0	0	1	0	0	0	1	0	
			47.0...47.3	1	1	0	0	0	0	1	0	
50.0...51.15	50.0...50.15	50.0...50.7	47.4...47.7	0	1	0	0	0	0	1	0	
			47.8...47.15	1	0	0	0	0	0	1	0	
			47.12...47.15	0	0	0	0	0	0	1	0	
	51.0...51.15	51.0...51.7	48.0...48.3	1	1	1	1	1	1	0	0	
			48.4...48.7	0	1	1	1	1	1	0	0	
			48.8...48.15	1	0	1	1	1	1	0	0	
51.8...51.15	49.8...49.15	49.0...49.7	48.12...48.15	0	0	1	1	1	1	0	0	
			49.0...49.3	1	1	0	1	1	1	0	0	
			49.4...49.7	0	1	0	1	1	1	0	0	
	51.8...51.15	49.8...49.15	49.12...49.15	49.8...49.11	1	0	0	1	1	1	0	0
				49.12...49.15	0	0	0	1	1	1	0	0
				50.0...50.3	1	1	1	0	1	1	0	0
51.8...51.15	50.4...50.7	50.8...50.15	50.4...50.7	0	1	1	0	1	1	0	0	
			50.8...50.11	1	0	1	0	1	1	0	0	
			50.12...50.15	0	0	1	0	1	1	0	0	
	51.8...51.15	51.0...51.7	51.0...51.7	51.0...51.3	1	1	0	0	1	1	0	0
				51.4...51.7	0	1	0	0	1	1	0	0
				51.8...51.11	1	0	0	0	1	1	0	0
51.8...51.15	51.8...51.15	51.8...51.15	51.12...51.15	0	0	0	0	1	1	0	0	
			51.12...51.15	0	0	0	0	1	1	0	0	

<b>Codierung</b>	Alle Baugruppen dürfen nur bei ausgeschalteter Versorgungsspannung ausgetauscht werden.	<b>Schalter</b>	0 = off/open	1 = on
<b>Coding</b>	Cards must be exchanged only while the supply voltage is disconnected.	<b>Switches</b>		
<b>Codage</b>	Les modules doivent tous être remplacés hors tension.	<b>Codeurs</b>		
<b>Codifica</b>	Togliere tensione prima di inserire o rimuovere i moduli.	<b>Interruttori</b>		
<b>Codificación</b>	Las tarjetas deben insertarse o extraerse sólo con la alimentación desconectada.	<b>Codificador</b>		

**Baugruppentyp / Module Type / Type de module /  
Tipi di moduli / Tipo de tarjeta**

**Schalternummer / Switch Number / No. de microrrupteur /  
N° interruttore / N° de codificador**

A	B	C	D										
			1			2							
			1	2	3	4	5	6	7	8			
			1	2	3	4	5	6	7	8			
52.0...53.15	52.0...52.15	52.0...52.7	52.0...52.3	1	1	1	1	0	1	0	0	0	
			52.4...52.7	0	1	1	1	0	1	0	0	0	
			52.8...52.15	1	0	1	1	0	1	0	0	0	
	53.0...53.15	53.0...53.7	53.0...53.3	53.0...53.3	1	1	0	1	0	1	0	0	0
				53.4...53.7	0	1	0	1	0	1	0	0	0
				53.8...53.15	1	0	0	1	0	1	0	0	0
54.0...55.15	54.0...54.15	54.0...54.7	54.0...54.3	1	1	1	0	0	1	0	0	0	
			54.4...54.7	0	1	1	0	0	1	0	0	0	
			54.8...54.15	1	0	1	0	0	1	0	0	0	
	55.0...55.15	55.0...55.7	55.0...55.3	55.0...55.3	1	1	0	0	0	1	0	0	0
				55.4...55.7	0	1	0	0	0	1	0	0	0
				55.8...55.15	1	0	0	0	0	1	0	0	0
56.0...57.15	56.0...56.15	56.0...56.7	56.0...56.3	1	1	1	1	1	0	0	0	0	
			56.4...56.7	0	1	1	1	1	0	0	0	0	
			56.8...56.15	1	0	1	1	1	0	0	0	0	
	57.0...57.15	57.0...57.7	57.0...57.3	57.0...57.3	1	1	0	1	1	0	0	0	0
				57.4...57.7	0	1	0	1	1	0	0	0	0
				57.8...57.15	1	0	0	1	1	0	0	0	0
58.0...59.15	58.0...58.15	58.0...58.7	58.0...58.3	1	1	1	0	1	0	0	0	0	
			58.4...58.7	0	1	1	0	1	0	0	0	0	
			58.8...58.15	1	0	1	0	1	0	0	0	0	
	59.0...59.15	59.0...59.7	59.0...59.3	59.0...59.3	1	1	0	0	1	0	0	0	0
				59.4...59.7	0	1	0	0	1	0	0	0	0
				59.8...59.15	1	0	0	0	1	0	0	0	0
60.0...61.15	60.0...60.15	60.0...60.7	60.0...60.3	1	1	1	1	0	0	0	0	0	
			60.4...60.7	0	1	1	1	0	0	0	0	0	
			60.8...60.15	1	0	1	1	0	0	0	0	0	
	61.0...61.15	61.0...61.7	61.0...61.3	61.0...61.3	1	1	0	1	0	0	0	0	0
				61.4...61.7	0	1	0	1	0	0	0	0	0
				61.8...61.15	1	0	0	1	0	0	0	0	0
62.0...63.15	62.0...62.15	62.0...62.7	62.0...62.3	1	1	1	0	0	0	0	0	0	
			62.4...62.7	0	1	1	0	0	0	0	0	0	
			62.8...62.15	1	0	1	0	0	0	0	0	0	
	63.0...63.15	63.0...63.7	63.0...63.3	63.0...63.3	1	1	0	0	0	0	0	0	0
				63.4...63.7	0	1	0	0	0	0	0	0	0
				63.8...63.15	1	0	0	0	0	0	0	0	0
63.8...63.15	63.8...63.15	63.8...63.15	63.8...63.15	1	0	0	0	0	0	0	0	0	
			63.12...63.15	0	0	0	0	0	0	0	0	0	