

Drive System Rexroth IndraDrive

Complete, intelligent and safe



Bosch Rexroth AG dominates in all relevant drive, control and motion technologies worldwide. We offer that vitally important added value in electric drive and control systems – regardless of where you are located and what you want to automate!



Contents

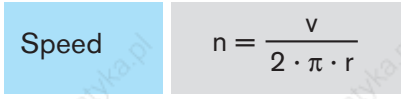
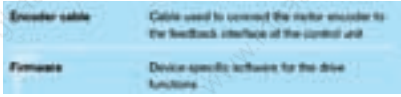
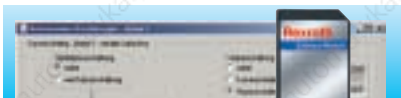

Drive expertise	4
System overview	10
Selection guide	12
Power units	14
Control units	32
Motor-integrated drives	46
Firmware	52
Motion-Logic	54
Safety technology	56
Engineering and operating	60
Motors and gearboxes	64
Auxiliary components	96
Glossary	118
Formulas	120
Additional information	122

Speed

$$n = \frac{v}{2 \cdot \pi \cdot r}$$

4

01

10

02

12

03

14

04

32

05

46

06

52

07

54

08

56

09

60

10

64

11

96

12

118

13

120

14

122

15

Innovative drives – driving innovation

Rexroth drives have played a pioneering role in the automation industry for many years. Motivation and commitment continue to drive our efforts to maintain our technology leadership.

We keep our ears to the ground to constantly stay in tune with the latest trends in production automation. Based on the information we collect, we develop tomorrow's drive solutions for the production floor. An uncompromising focus on the needs of our customers enables us to drive innovation forward in the machine building and mechanical engineering industry.

We have repeatedly played a pioneering role in the industry. One example of the contributions which we have made to drive technology is the maintenance-free servo motor. The advantages of this technology are so fundamental that it ushered in a new generation of products throughout the mechanical engineering industry starting with transfer machines in the automotive industry. Other milestones include the first main spindle drive with positioning capability and distributed automation solutions with intelligent digital drives for modular machine design.

Linear motor technology is another ultra-modern and innovative field where Rexroth is a leader and can demonstrate more experience than any other company in the world.

Currently, one issue of vital importance is drive-integrated safety technology.

Rexroth has proven time and again that, in the long run, innovation and market success go hand in hand. Over one million Rexroth drives are in use around the world in a wide and diverse range of applications.

Rexroth IndraDrive, the latest generation of drives, and Rexroth IndraDyn, the complete range of motors, are the result of Rexroth's

dedication to innovation in drive technology.

With their fully-integrated platform, innovative safety technology and intelligent functions, Rexroth IndraDrive and IndraDyn are predestined for both intelligent single-axis and complex multiple-axis applications. This innovation in drive technology will set market trends again – to benefit all users.



Innovative integration – Rexroth Automation House

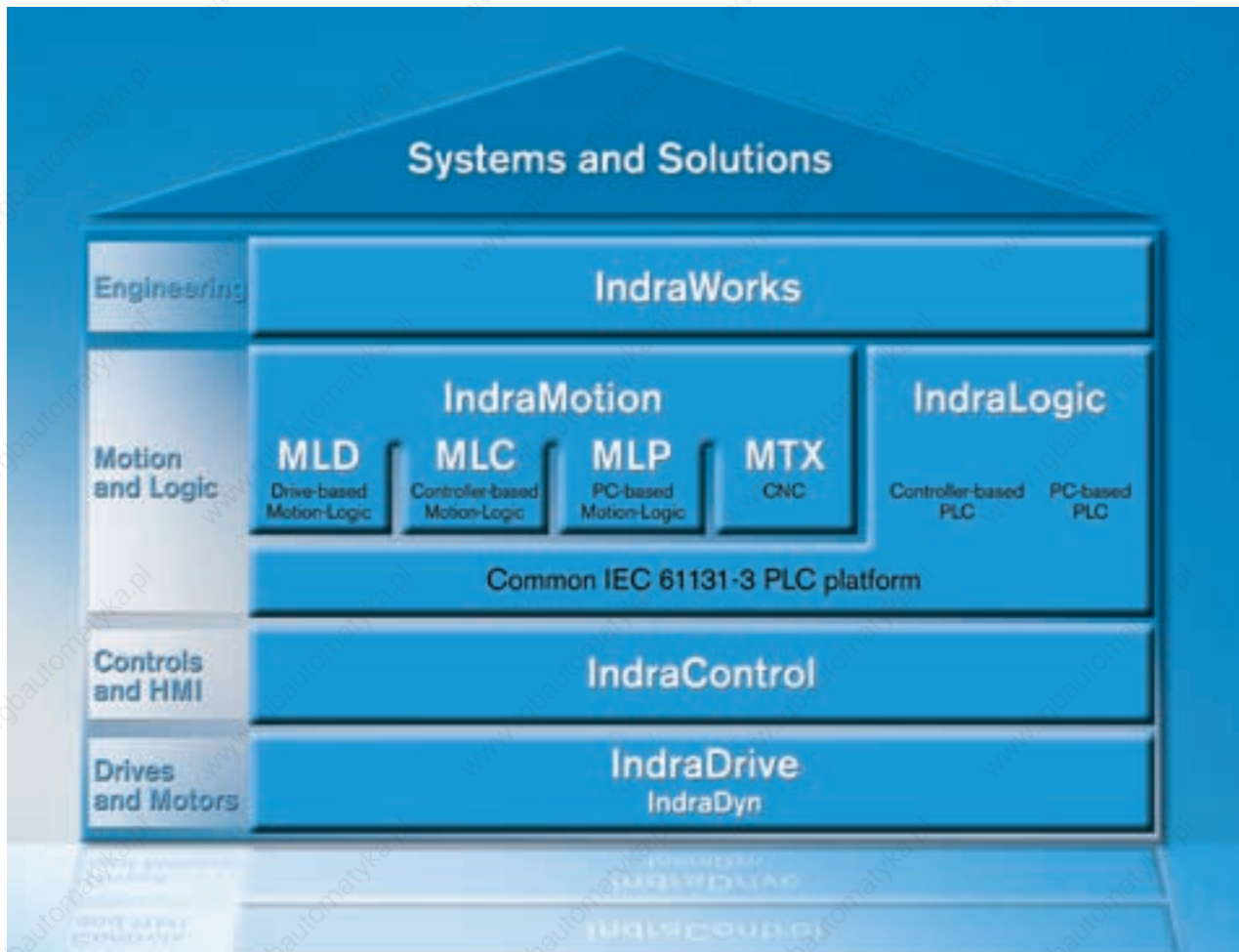

Our Automation House is a unique modular toolkit which gives you everything you need to create leading-edge automation solutions. From drive and control systems to the high-performance software framework for standardized engineering and user-friendly operation. This innovation gives you all the privileges associated with modern automation technology – integration, intelligence and investment for the future.

IndraDrive and IndraDyn

The intelligent drive solution and comprehensive range of motors for maximum dynamics

IndraControl

The standardized control and visualization hardware platform for increased transparency in production

IndraLogic

The IEC-compliant PLC solution for intelligent automation

IndraMotion

The scalable system software platform for high-performance motion control applications

IndraWorks

The integrated engineering software package for project planning, programming, visualization and diagnostics

Rexroth IndraDrive and Rexroth IndraDyn cause a stir in the drive market

This new design is redefining standards in drive technology.

Complete in terms of hardware and software, safe in terms of application and intelligent in terms of functionality:

With IndraDrive and IndraDyn you will benefit from the economic, intelligent and future-assured approach to your automation tasks – regardless of your industry!

It is the combination of three features which gives IndraDrive its unique and pioneering edge:

- Inclusive platform
- Integrated intelligence
- Innovative safety concept

When it comes to practical applications, IndraDrive offers many advantages such as:

- Safety on Board conforming to EN 954-1, Category 3, for safe stop and safe motion
- Wide power range from 1 kW to 120 kW

- Internationally standardized interfaces
- Integrated Motion Logic, with IEC 61131-3 compliant PLC
- Highest performance and precision
- Scalable power and functionality
- Direct mains connection
- Energy-saving power recovery

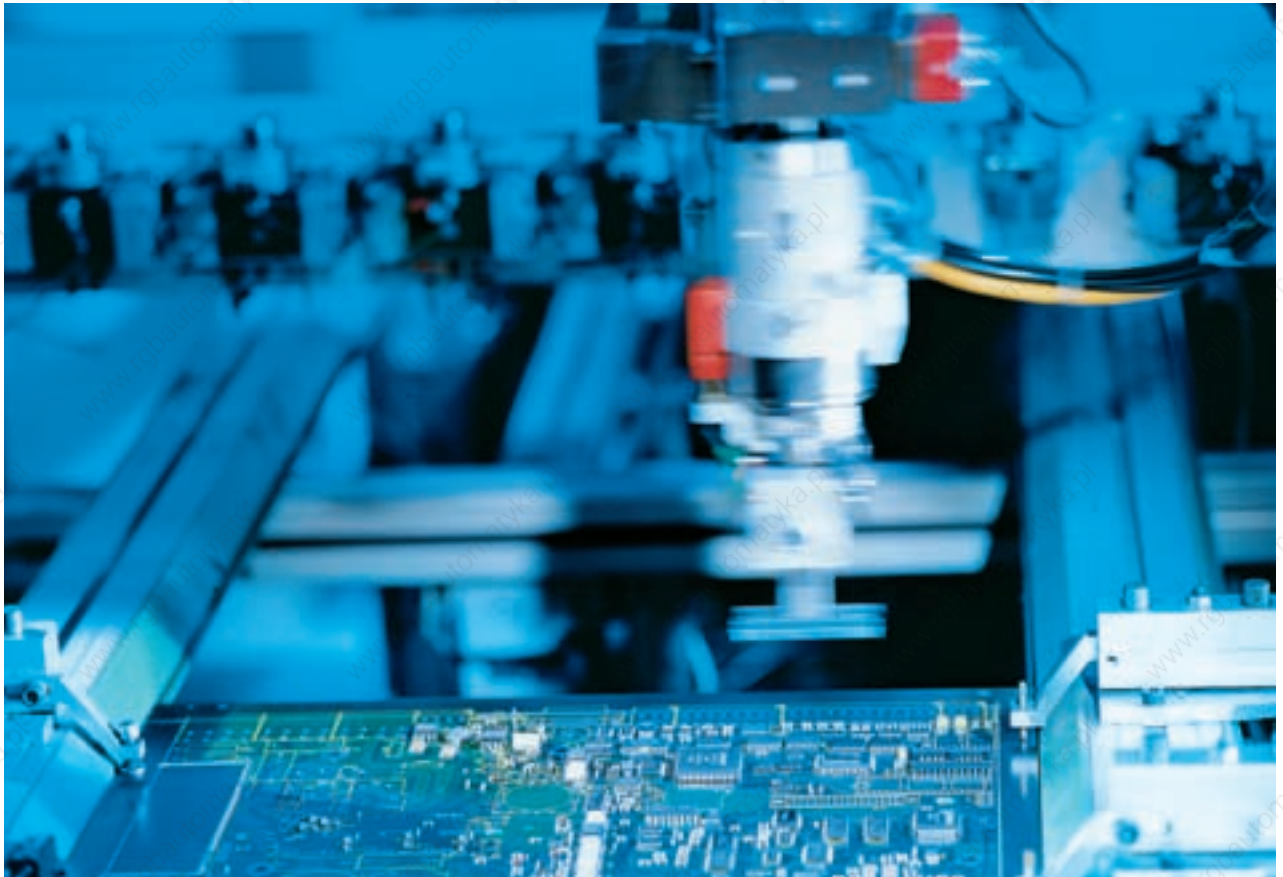



IndraDrive has the power to convince

No matter what demands you make on your drive – IndraDrive offers an impressive array of key benefits:

- Integrated hardware platform
- Scalable functionality
- Unique safety concept

Your benefits

Safety on board

Safety technology certified to EN 954-1, Category 3, protects machine operators while the drives are in motion. In contrast to conventional safety designs, there is no longer any need for motor contactors, additional speed monitors or frequent power shutdown using the line contactor.

Integrated Motion Logic with IEC 61131-3 compliant PLC

Motion Logic with IEC 61131-3 compliant PLC can be integrated as an optional feature that consistently applies open standards. This makes it easier to bring in customer know-how and saves on higher-level control systems and personnel training courses.

Integrated technology functions

The technology functions can be configured on the basis of Motion Logic to perform a wide and diverse range of process-oriented tasks. This does not require any programming knowledge whatsoever on the user's part.

Open interfaces

Internationally recognized interfaces are available for communicating with higher-level machine control systems: SERCOS, PROFIBUS DP, PROFINet IO, CANopen, DeviceNet, analog and parallel.

A single software for all tasks

The engineering software framework, IndraWorks, carries you through all the steps involved in project planning, programming, parameterization, operation and diagnostics.

A unique platform

In the interests of meeting your individual requirements, we have developed two versions of IndraDrive:

- IndraDrive C – Compact converters
- IndraDrive M – Modular inverters

Particularly economic drive solutions can be derived from the common control units and the combination of different versions.

A complete range of motors

The newly developed generation of IndraDyn motors meets all the requirements of modern factory automation through its diversity of design and unique performance:

- Synchronous and asynchronous servo motors which are more compact and more powerful
- Servo motors designed for potentially explosive areas – conforming to ATEX and UL/CSA
- Synchronous and asynchronous motors for high-speed applications such as motor spindles

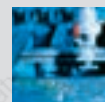

Automation



Printing and converting machines



Conveying and storage systems



Glass processing machines



Handling and assembly systems

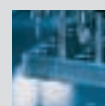

Woodworking machines



Plastics processing machines

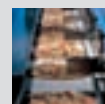

Food processing and packaging machines

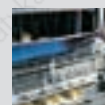

Textile machines

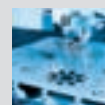

Metal forming

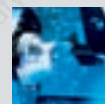

Machine tools

Introducing the new IndraDrive system

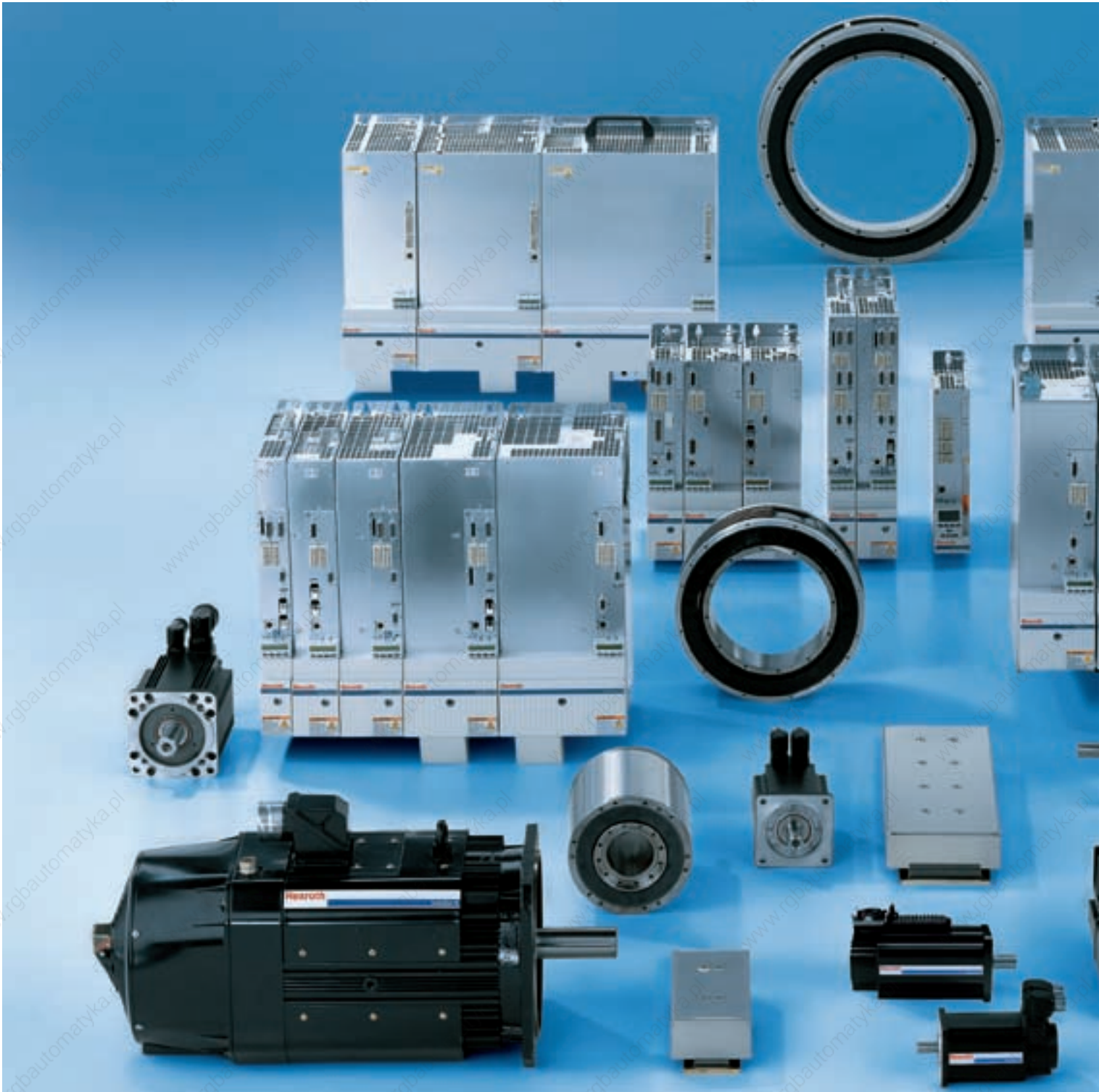

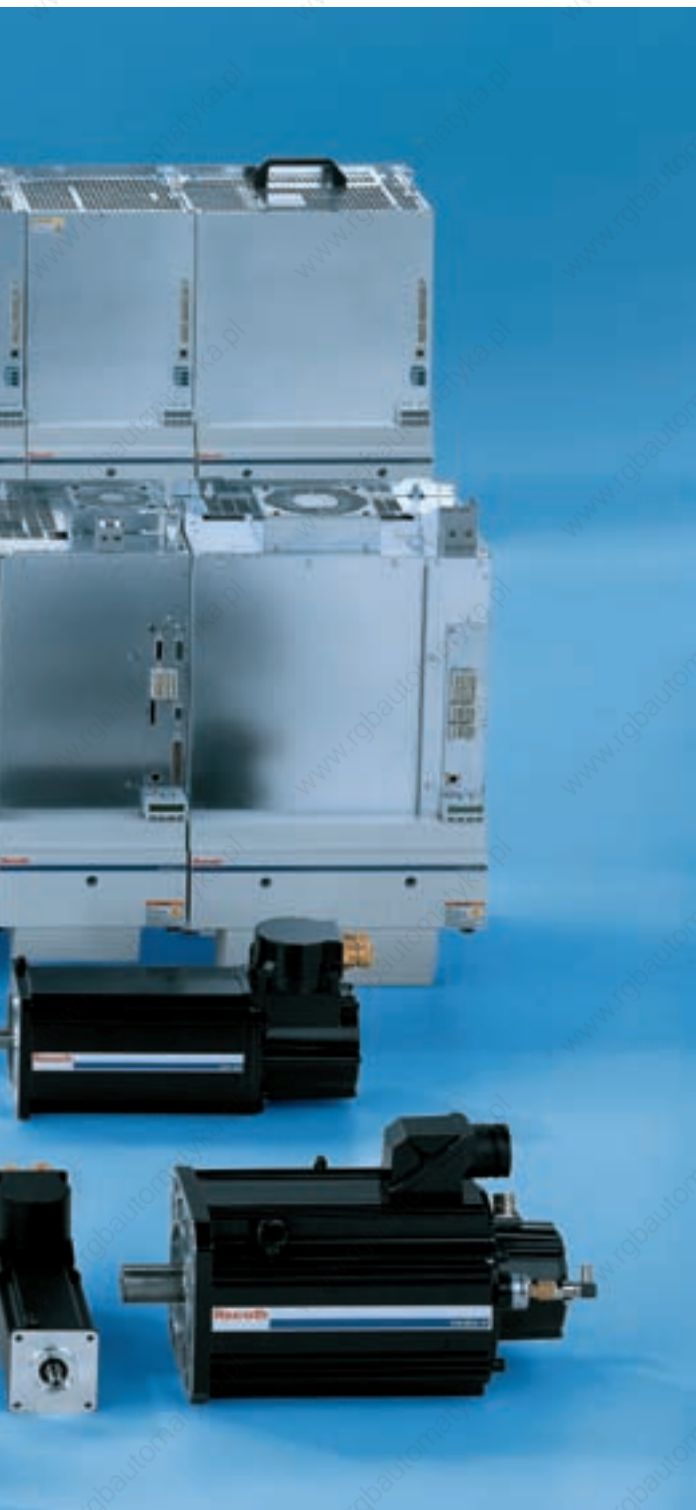











IndraDrive stands for innovation all along the line. Therefore, choosing the new drive generation from Rexroth means that your every wish will be fulfilled.

Main features of the IndraDrive:

- Compact converters and modular inverters on one platform
- Ultra-compact drive unit consisting of control unit and servo motor
- Integrated Motion Logic with IEC-compliant PLC
- Drive-integrated safety technology
- Intelligent technology functions
- Integrated engineering framework for project planning, programming, operation and diagnostics
- Complete range of synchronous and asynchronous motors

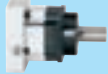
Leaving nothing to be desired: Rexroth IndraDrive – the complete system

Motors and gearboxes	Power units	Control units
 <p>Synchronous servo motors IndraDyn S MSK, MKE Pages 66–71</p>	<p>Converters HCS02 Pages 18/19 HCS03 Pages 20/21</p> 	<p>Complete solutions for standard applications</p> <p>BASIC OPEN LOOP CSB...FC Page 36</p> <p>BASIC ANALOG CSB...AN Page 37</p> <p>BASIC PROFIBUS CSB...PB Page 38</p> <p>BASIC SERCOS CSB...SE Page 39</p>
 <p>Asynchronous servo motors IndraDyn A MAD, MAF Pages 72–79</p>	<p>Converters and inverters can be combined</p>	<p>Individually configurable for standard and high-end applications</p> <p>BASIC UNIVERSAL CSB (single-axis control unit) Page 40</p> <p>BASIC UNIVERSAL CDB (dual-axis control unit) Page 37</p> <p>ADVANCED CSH Page 42</p>
 <p>Synchronous linear motors IndraDyn L MLP/MLS Pages 80/81</p>	<p>Inverters HMS (single-axis unit) Pages 22/23 HMD (dual-axis unit) Pages 24/25</p> 	<p>For converters and inverters</p>
 <p>Synchronous torque motors IndraDyn T MST/MRT Pages 82/83</p>	<p>Power supplies and inverters can be combined</p>	
 <p>Synchronous high-speed motors IndraDyn H MSS/MRS Pages 84/85</p>	<p>Power supply units HMV Pages 26–29</p> 	
 <p>Asynchronous frameless (kit) motors 1MB Pages 86/87</p>		
 <p>Gearboxes for servo motors GTE, GTM Pages 88–91</p>		
 <p>Standard motors, geared motors Pages 92–95</p>		
 <p>Motor-integrated drives KSM, KCU Pages 46–51</p>		

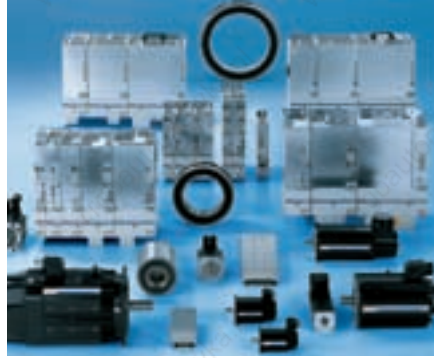

Seamlessly coordinated

- ▮ Integrated system
- ▮ Scalable power
- ▮ Flexible function blocks
- ▮ Open communications standards
- ▮ Future-proof

Your benefits

Firmware

Basic package

**OPEN LOOP /
CLOSED LOOP**

The basic package contains all the functions for standard applications.

Extension packages

SERVO

Frictional torque compensation and compensation for backlash on reversal, axis and encoder error correction, touch probe, etc.

SYNCHRONIZATION

Electronic gears, electronic cam plate, etc.

MAIN SPINDLE

Spindle positioning, gear change, etc.

IndraMotion MLD

Motion Logic conforming to IEC 61131-3

**Technology packages
based on IndraMotion MLD**

Productivity Agent (predictive maintenance), function blocks, demand processing, special cam groups, extended drive function, PLCopen library, etc.

Pages 52/53

Engineering and operation

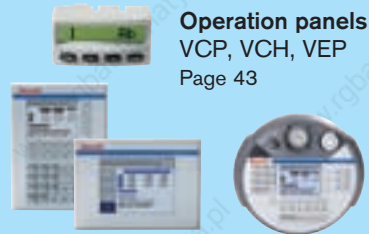

Operation panels
VCP, VCH, VEP
Page 43

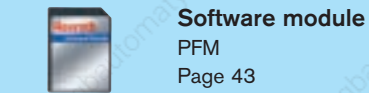

Software module
PFM
Page 43

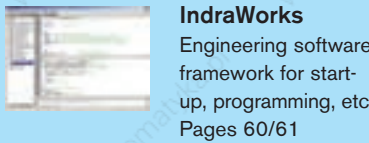

IndraWorks
Engineering software framework for start-up, programming, etc.
Pages 60/61

Cables



Power cables
RKL
Page 116

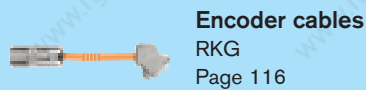

Encoder cables
RKG
Page 116



Fiber optic cables, bus connectors, etc.



Hybrid cable, terminal connector
RKH
Page 51

Auxiliary components

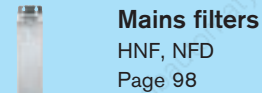

Mains filters
HNF, NFD
Page 98

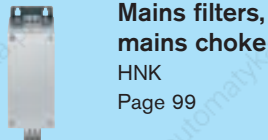

Mains filters, mains choke
HNK
Page 99

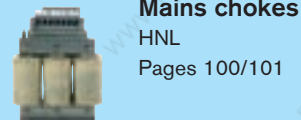

Mains chokes
HNL
Pages 100/101

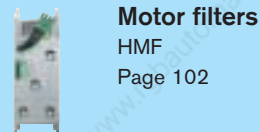

Motor filters
HMF
Page 102

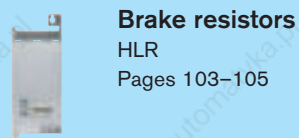

Brake resistors
HLR
Pages 103–105

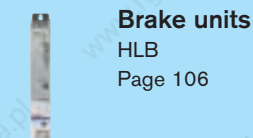

Brake units
HLB
Page 106

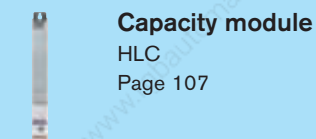

Capacity module
HLC
Page 107

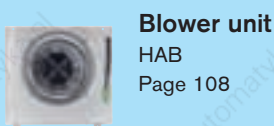

Blower unit
HAB
Page 108

Five steps to your drive solution

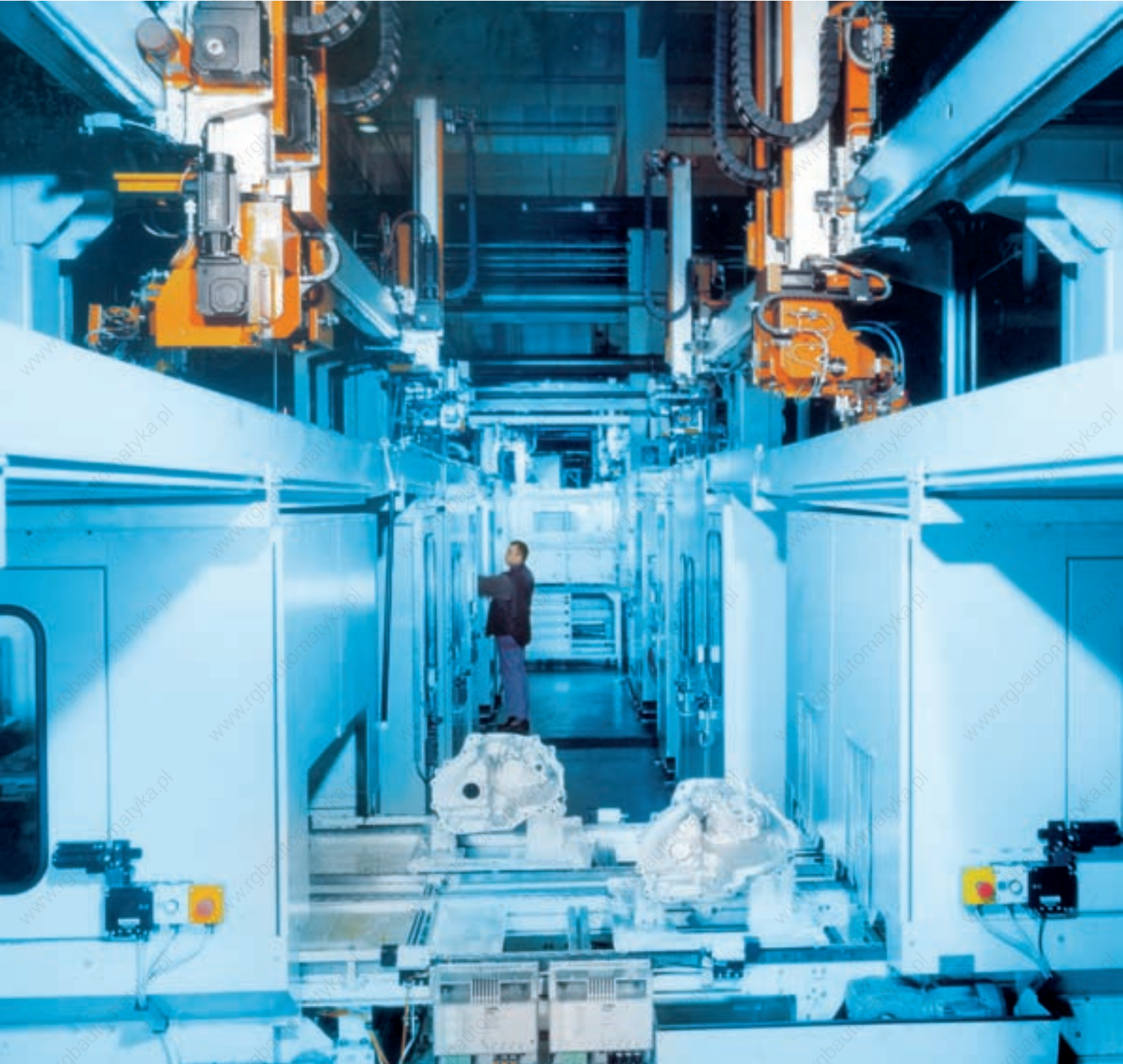

Step	Example	Help
1 Determine your drive requirements <ul style="list-style-type: none"> • Torque, speed, power ... • Performance (control quality ...) • Interfaces, functions • Single-axis or multi-axis drive 	 Servo drive for a handling axis <ul style="list-style-type: none"> • RMS torque 4.5 Nm • Maximum torque 8 Nm • Speed 2,500 rpm • PROFIBUS interface • Simple servo functionality 	Drive sizing program IndraSize Pages 62/63
2 Select the power unit/motor combination	 IndraDrive C with IndraDyn S HCS02.1E-W0028-A-03-NNNN MSK050C-0300-NN-S1-UG0-NNNN <ul style="list-style-type: none"> • Standstill torque 5 Nm • Maximum torque 9 Nm • Maximum speed 3,000 rpm 	Power units Pages 14–31 Motors Pages 64–95 Motor-integrated drives Pages 46–51
3 Identify the control unit performance and interfaces <ul style="list-style-type: none"> • Higher-level control system • Encoder • Inputs and outputs • Safety technology 	 BASIC PROFIBUS CSB01.1N-PB-ENS-NNN-NN-S-NN-FW <ul style="list-style-type: none"> • Standard performance • PROFIBUS • IndraDyn standard encoder • Standard operator panel • No additional options 	Control units Pages 32–45
4 Define the firmware function <ul style="list-style-type: none"> • Basic OPEN LOOP or CLOSED LOOP package • Extension packages • Motion Logic • Technology functions 	 Basic CLOSED LOOP package FWA-INDRV*-MPB-03VRS-D5-1-NNN-NN <ul style="list-style-type: none"> • No extension packages 	Firmware Pages 52/53
5 Select the accessories <ul style="list-style-type: none"> • Mains filters and mains chokes • Brake resistors, brake units • Capacity modules • Cables • Software 	 Mains filter NFD03.1-480-016 Power cable RKL4302/005,0 Encoder cable RKG4200/005,0 Basic accessories HAS01.1-065-NNN-CN Shield connection HAS02.1-002-NNN-NN Software SWA-IWORKS-D**-xxVRS-D0-CD650-COPY	Auxiliary components Pages 96–117 Engineering software toolkit IndraWorks Pages 60/61

Rexroth IndraDrive – power units





Customized for the desired number of axes and performance level

- Wide power range – for all applications
- Converters and inverters can be combined – ideal for small axis groups
- Power supplies and inverters can be combined – ideal for large axis groups

Your benefits

IndraDrive C – compact converters

- Power range from 1.5 kW to 75 kW with maximum current from 12 A to 210 A
- High overload capacity
- Compact design for single-axis applications
- Can be connected to inverters for cost-effective solutions
- Direct mains connection from 200 V to 500 V

IndraDrive M – modular inverters

- Single-axis inverter with maximum current from 20 A to 350 A
- Dual-axis inverter with maximum current from 12 A to 36 A
- Space-saving design for multi-axis applications
- Can be powered via power supply unit or converter
- Energy exchange via common DC bus
- Can be connected to converters for cost-effective solutions

IndraDrive M – modular power supplies

- Power range from 15 kW to 120 kW
- Direct mains connection from 400 V to 480 V
- Energy-saving line regeneration
- Integrated mains contactor
- Integrated brake resistor

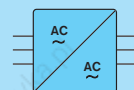

Converters and inverters can be combined

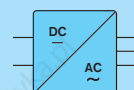

Power supplies and inverters can be combined

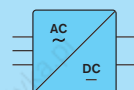

IndraDrive – the clever combination of power units

Single-axis solution with a converter

3 AC 200 V ... 500 V

The IndraDrive C series of converters integrate inverter and power supply in one unit. The compact construction contains additional mains connection components, making it particularly suitable for single-axis applications.



Multi-axis solution with converters and inverters

3 AC 400 V ... 500 V

A combination of IndraDrive C converters and modular IndraDrive M inverters is a particularly cost-effective solution for small axis groups.

The converter for the first axis supplies the inverters of the other axes at the same time. In this case, a converter with sufficient power reserve must be selected in order to be able to supply the smaller inverters as well.

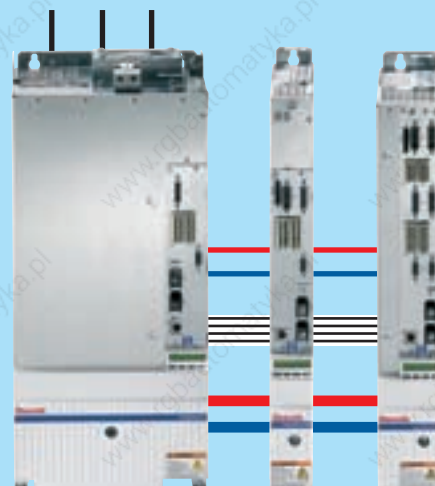

Multi-axis solution with power supplies and inverters

3 AC 400 V ... 480 V

Multi-axis applications are the domain of the modular system IndraDrive M. Power supplies provide the necessary DC bus voltage for the inverters. Compact single-axis or dual-axis inverters and power supplies with integrated mains connection components enable compact solutions for large axis groups.

Maximum energy efficiency can be achieved with power supplies that are capable of mains regeneration. Besides the power recovery encountered in regenerative operation of the drives, another outstanding feature of these devices is the closed-loop DC bus.

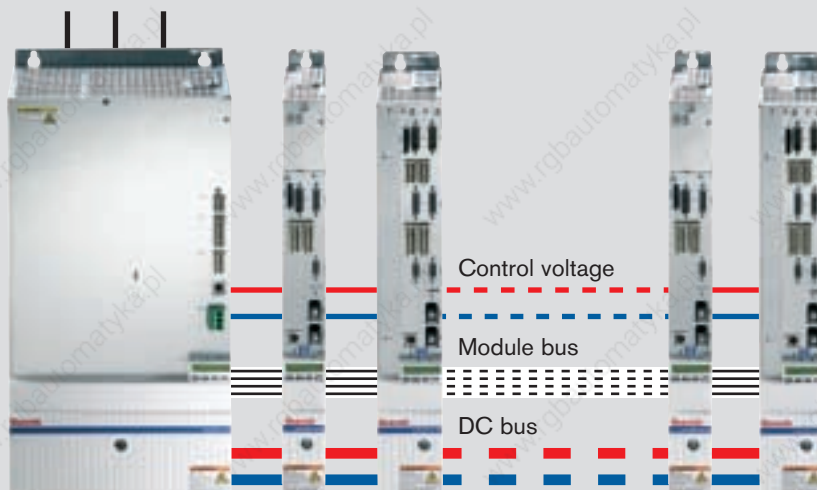

Power units		IndraDrive C		IndraDrive M		
		Converter	Converter	Inverter	Power supply units	
		HCS02	HCS03	HMS01/HMS02 HMD01	infeed HMV01.1E	regenerative HMV01.1R HMV02.1R
Mains voltage	V	1 AC 200 ... 250 V 3 AC 200 ... 500 V (±10 %)	3 AC 400 ... 500 V (+10 %/-15 %)	-	3 AC 400 ... 480 V (+10 %/-15 %)	
Supply frequency	Hz	48 ... 62		-	48 ... 62	
DC bus continuous power	kW	2.1 ... 14	13 ... 85	-	18 ... 120	
Continuous mechanical power ¹⁾	kW	1.5 ... 11	11 ... 75	1.5 ... 75	-	
Overload capacity		2.5x	1.5 ... 2x	1.5 ... 2.5x	1.5x	1.5 ... 2.5x
Switching frequency/ max. output frequency	kHz/Hz	-		-	-	
		4/400		4/400	-	
		8/800		8/800	-	
		12/1,200		12/1,200 ²⁾	-	
		16/1,600		16/1,600 ²⁾	-	
Output voltage	V	0 ... 335 (at DC bus voltage DC 475 V) 0 ... 400 (at DC bus voltage DC 570 V) 0 ... 530 (at DC bus voltage DC 750 V)		-		
Suitable for cabinet depth	mm	300	400	HMx01: 400/HMx02: 300		
Mains contactor		external		-	internal ³⁾	
Brake chopper		internal		-	internal ³⁾	
Brake resistor		internal (optional external)	external	-	internal ³⁾	
Converter/inverter combination		yes	yes	yes	-	
Control voltage DC 24 V		external (optional internal)	internal or external	external		
Protection mode		IP20				
Installation height	m	1,000 over NN, with derating to 4,000				
Ambient temperature	°C	0 ... +40, with derating to +55				
Relative air humidity	%	5 ... 95 (as per EN 61800-5-1), condensation not permitted				
Degree of contamination		2 (as per EN 61800-5-1)				
Cooling system		Air cooling				
CE-mark		Complies with the low voltage directive 73/23/EEC and the EMC directive 89/336/EEC				
Certification		UL, cUL				
EMC		as EN 61800-3				

All data for nominal rating at 3 AC 400 V mains voltage and 4 kHz switching frequency

¹⁾ applies to S1 mode on 4-pole standard motors 3 AC 400 V/50 Hz at 4 kHz switching frequency and a rotary frequency > 4 Hz

²⁾ HMD01 and HMS02.1N-W0028 up to 8 kHz/800 Hz only

³⁾ not applicable for HMV01.1R-W0120

IndraDrive C – compact converters HCS02

Models with integrated control voltage supply no additional options	Converters				
	HCS02.1E-W0012	HCS02.1E-W0028	HCS02.1E-W0054	HCS02.1E-W0070	
	-A-03-NNNV	-A-03-NNNV	-A-03-NNNV	-A-03-NNNV	
Performance data					
Continuous current	A	4.5	11.3	20.6	28.3
Maximum current	A	11.5	28.3	54	70.8
DC bus continuous power without/with choke	kW	2.1/2.1	5.1/5.1	7/10	9/14
Maximum output without/with choke	kW	5/5	8/10	12/16	14/19
Mains voltage	V	3 AC 200 ... 500, 1 AC 200 ... 250 ($\pm 10\%$)			
Continuous input mains current	A	6	13	19	30
Dependence of output on mains voltage		at $U_{LN} < 400$ V: 1 % power reduction per 4 V at $U_{LN} > 400$ V: 1 % power gain per 5 V			
DC bus terminal ¹⁾		–	●	●	●
DC bus capacity	μ F	135	270	405	675
Brake resistor					
Brake resistor		internal	internal	internal/external	internal/external
Maximum braking energy consumption	kWs	1	5	9	13
Continuous braking power	kW	0.05	0.15	0.35/3.8	0.5/5.5
Maximum braking power	kW	4	10	18	25
Control voltage data					
Control voltage, internal	V	DC 24 (not for supply of motor holding brake)			
Control voltage, external	V	DC 24 $\pm 20\%$ (DC 24 $\pm 5\%$ when supplying motor holding brake)			
Power consumption without control unit and motor brake	W	12	14	23	23
Continuous current without control unit and motor brake	A	0.5	0.6	1.0	1.0
Mechanical data					
Width W	mm	65	65	105	105
Height H	mm	290	352		
Depth D (incl. plug)	mm	265			
Mass	kg	2.9	3.8	6.7	6.8

All data apply to nominal rating at 3 AC 400 V mains voltage and 4 kHz switching frequency

¹⁾for the connection of additional units, such as HMS, HCS, HLB, HLC

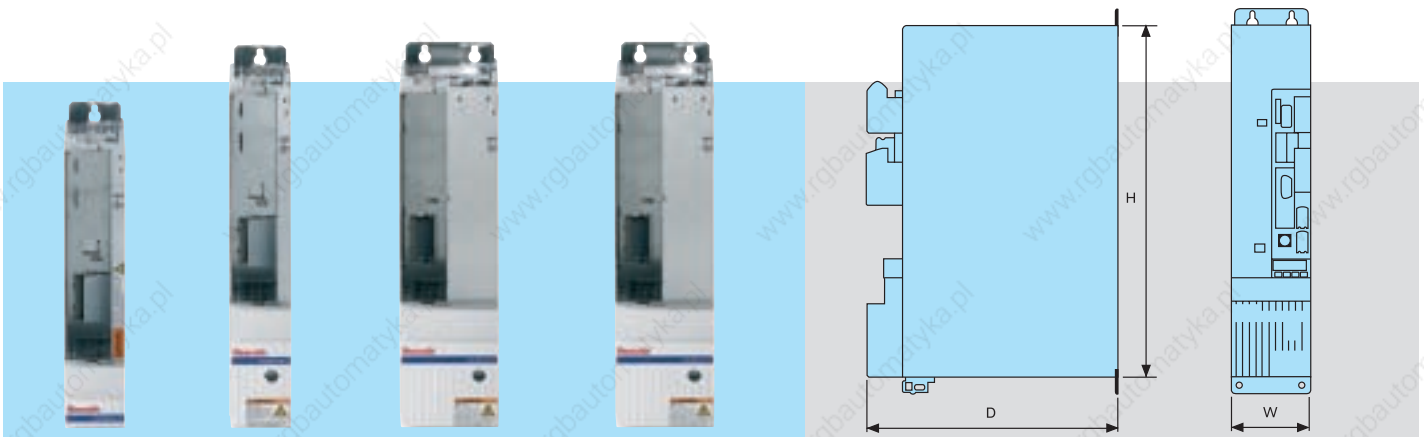

HCS02

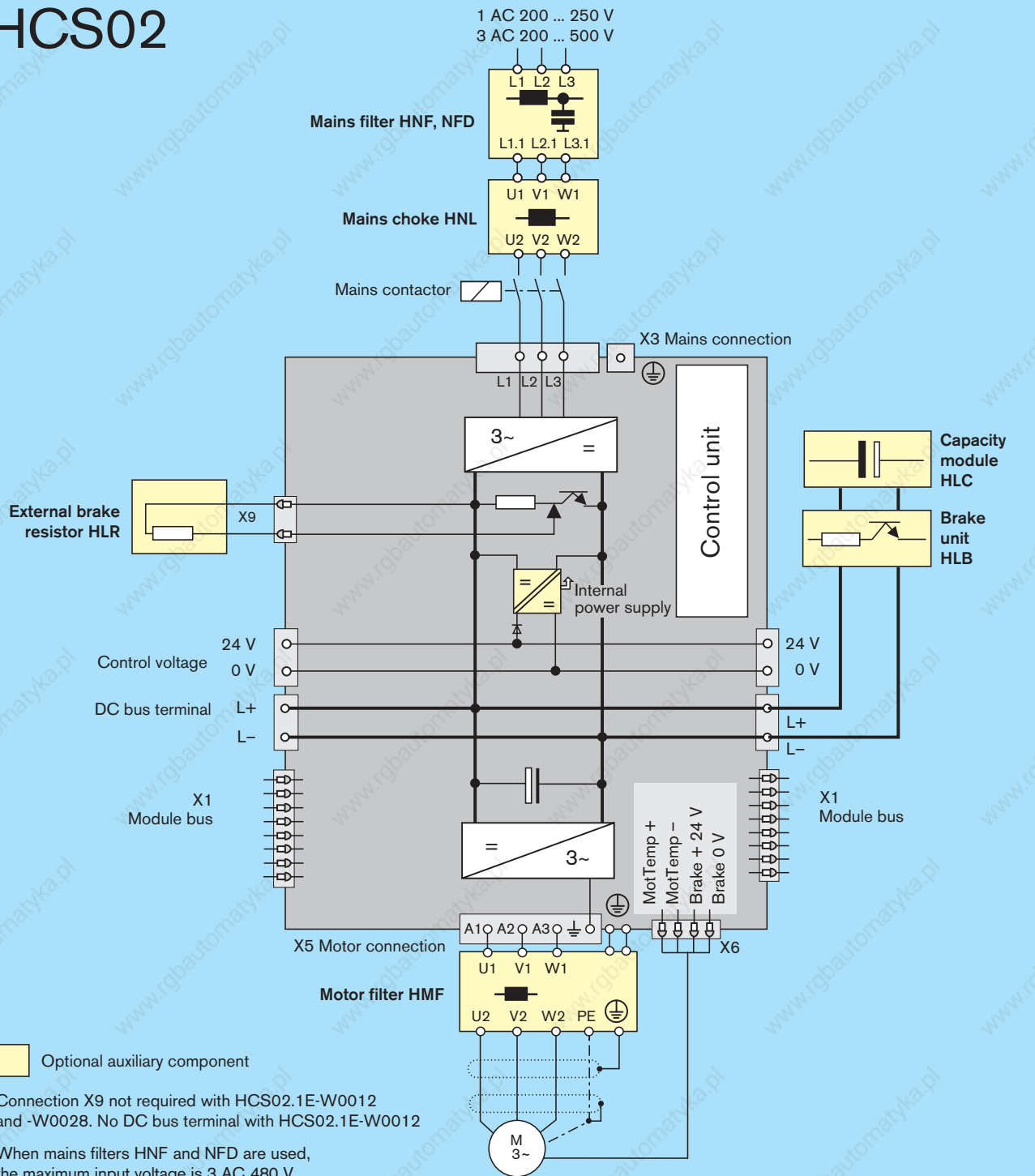

Optional auxiliary component

Connection X9 not required with HCS02.1E-W0012 and -W0028. No DC bus terminal with HCS02.1E-W0012

When mains filters HNF and NFD are used, the maximum input voltage is 3 AC 480 V.

IndraDrive C – compact converters HCS03

Models	Converters			
	HCS03.1E- W0070	HCS03.1E- W0100	HCS03.1E- W0150	HCS03.1E- W0210
with integrated control voltage supply	-A-05-NNNV	-A-05-NNNV	-A-05-NNNV	-A-05-NNNV
with integrated brake chopper and integrated control voltage	-A-05-NNBV	-A-05-NNBV	-A-05-NNBV	-A-05-NNBV

Performance data					
Continuous current	A	45	73	95	145
Maximum current	A	70	100	150	210
DC bus continuous power without/with choke	kW	13/25	24/42	34/56	42/85
Maximum output without/with choke	kW	20/40	33/59	54/89	68/124
Mains voltage	V	3 AC 400 ... 500 (+10 %/-15 %)			
Continuous inout mains current	A	50	80	106	146
Dependence of output mains voltage		at $U_{LN} < 400$ V: 1 % power reduction per 4 V decrease in voltage			
DC bus terminal ¹⁾		●	●	●	●
DC bus capacity	μF	940	1,440	1,880	4,700
Brake chopper					
Continuous brake power	kW	13.2	18.9	25.2	42.6
Maximum brake power	kW	42	63	97	137
Control voltage data					
Control voltage, internal	V	DC 24 (not for supply of motor holding brake)			
Control voltage, external	V	DC 24 ± 20 % (DC 24 ± 5 % when supplying motor holding brake)			
Power consumption without control unit and motor brake	W	22.5	25	25	30
Continuous current without control unit and motor brake	A	0.9	1.0	1.0	1.3
Mechanical data					
Width W	mm	125	225	225	350
Height H	mm	440	440	440	440
Depth D	mm	309			
Mass	kg	13	20	20	38

All data apply to nominal rating at 3 AC 400 V mains voltage and 4 kHz switching frequency

¹⁾for the connection of additional units, such as HMS, HCS, HLB, HLC

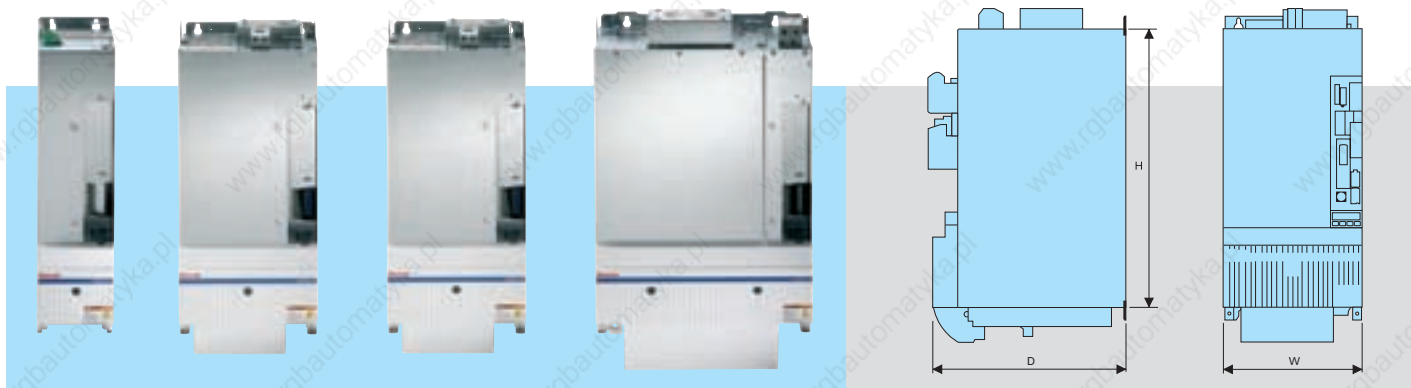

HCS03

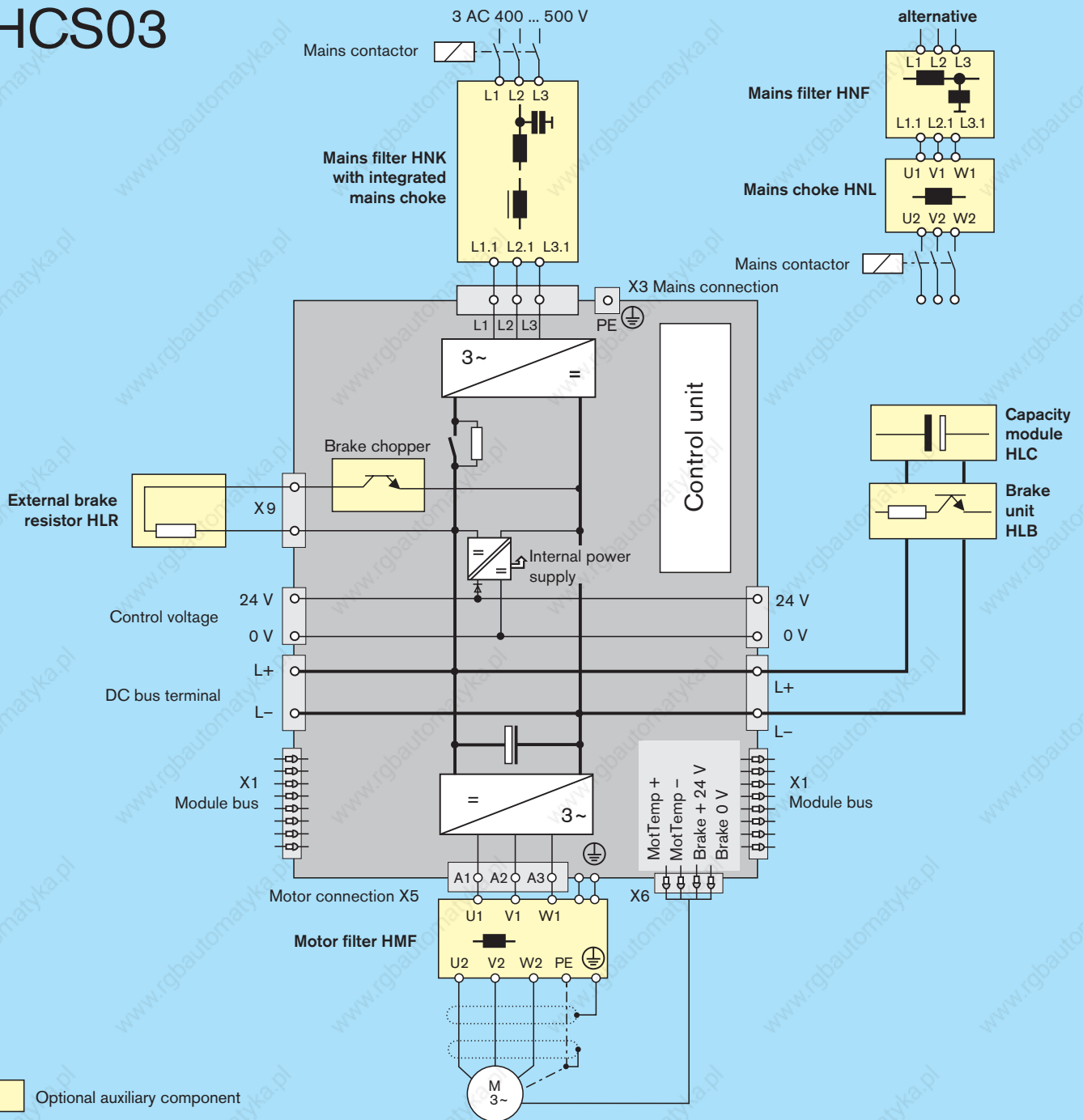

 Optional auxiliary component

Mains choke always required with HCS03.1E-W0210

When HNF mains filters are used, the maximum input voltage is 3 AC 480 V.

IndraDrive M – modular single-axis inverter HMS01 and HMS02

		Single-axis inverters										
Models		HMS01.1N- W0020-A- 07-NNNN	HMS01.1N- W0036-A- 07-NNNN	HMS01.1N- W0054-A- 07-NNNN	HMS01.1N- W0070-A- 07-NNNN	HMS01.1N- W0110-A- 07-NNNN	HMS01.1N- W0150-A- 07-NNNN	HMS01.1N- W0210-A- 07-NNNN	HMS01.1N- W0350-A- 07-NNNN	HMS02.1N- W0028-A- 07-NNNN	HMS02.1N- W0054-A- 07-NNNN	
no additional options												
Performance data												
Continuous current	A	12.1	21.3	35	42.4	68.5	100	150	250	13.8	25	
Maximum current	A	20	36	54	70	110	150	210	350	28	54	
Control voltage data												
Control voltage external	V	DC 24 ± 20 % (DC 24 ± 5 % when supplying motor holding brake)										
Power consumption without control unit and motor brake	W	10	16	10	16	34	23	75	218 ¹⁾	13	17	
Continuous current without control unit and motor brake	A	0.4	0.7	0.4	0.7	1.4	1.0	3.1	9.1	0.5	0.7	
Mechanical data												
Width W	mm	50	50	75	100	125	150	200	350	50	75	
Height H	mm	440									352	
Depth D	mm	309									265	
Mass	kg	5.3	5.3	6.7	7.9	11.0	12.7	18.4	31.7	3.5	5.0	

All data apply to nominal rating at 3 AC 400 V mains voltage and 4 kHz switching frequency

¹⁾including auxiliary filter HAB



HMS01

HMS02

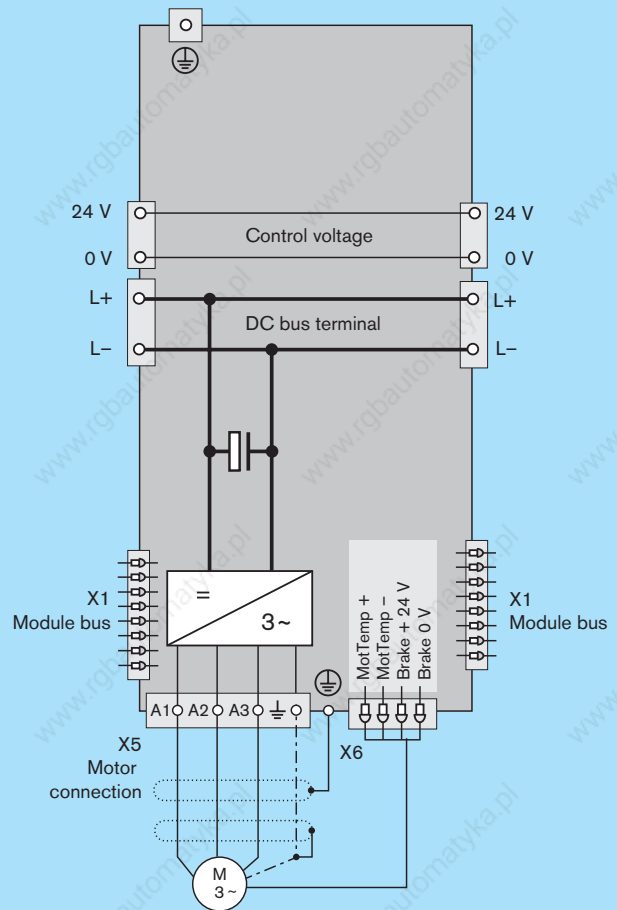
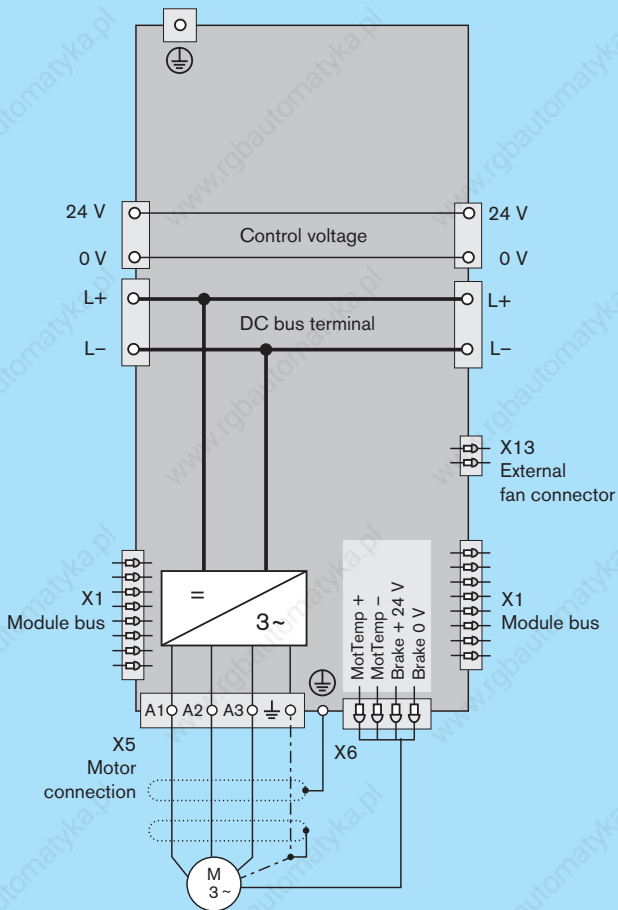

Connection X13 on HMS01.1N-W350 only

IndraDrive M – modular double-axis inverter HMD01

		Double-axis inverter		
Model		HMD01.1N- W0012-A- 07-NNNN	HMD01.1N- W0020-A- 07-NNNN	HMD01.1N- W0036-A- 07-NNNN
no additional options				
Performance data				
Continuous current	A	7	10	20
Maximum current	A	12	20	36
Control voltage data				
Control voltage external	V	DC 24 ± 20 % (DC 24 ± 5 % when supplying motor holding brake)		
Power consumption without control unit and motor brake	W	17	17	11
Continuous current without control unit and motor brake	A	0.7	0.7	0.5
Mechanical data				
Width W	mm	50	50	75
Height H	mm	440		
Depth D	mm	309		
Mass	kg	5.5	5.7	7.5

All data apply to nominal rating at 3 AC 400 V mains voltage and 4 kHz switching frequency

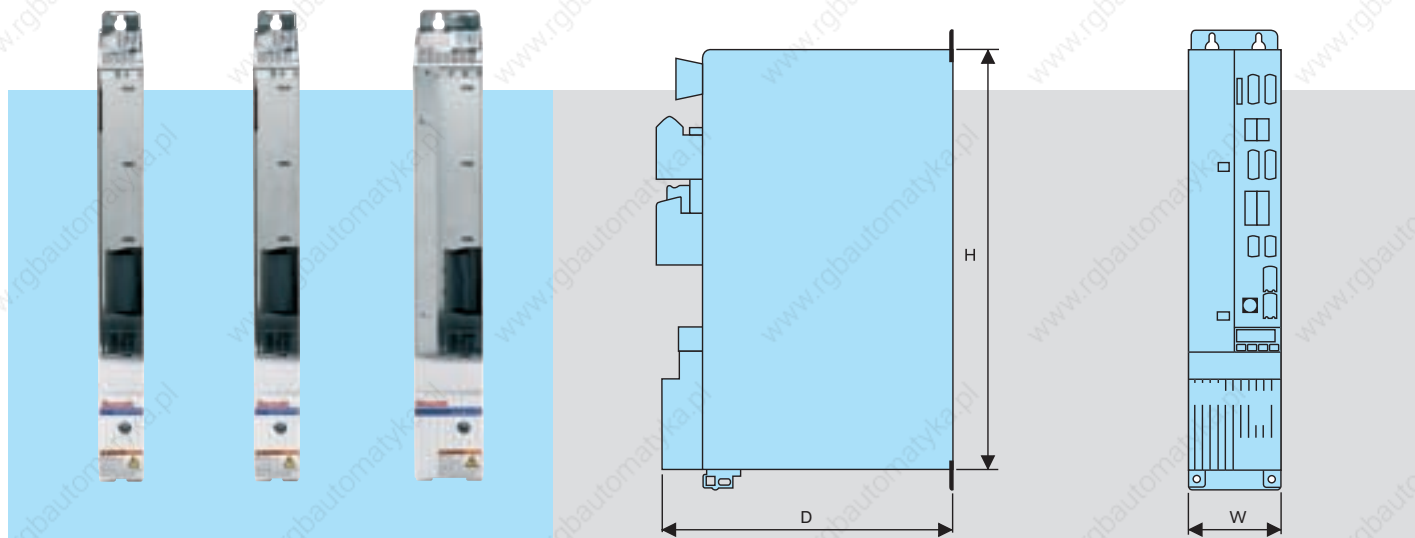

HMD01

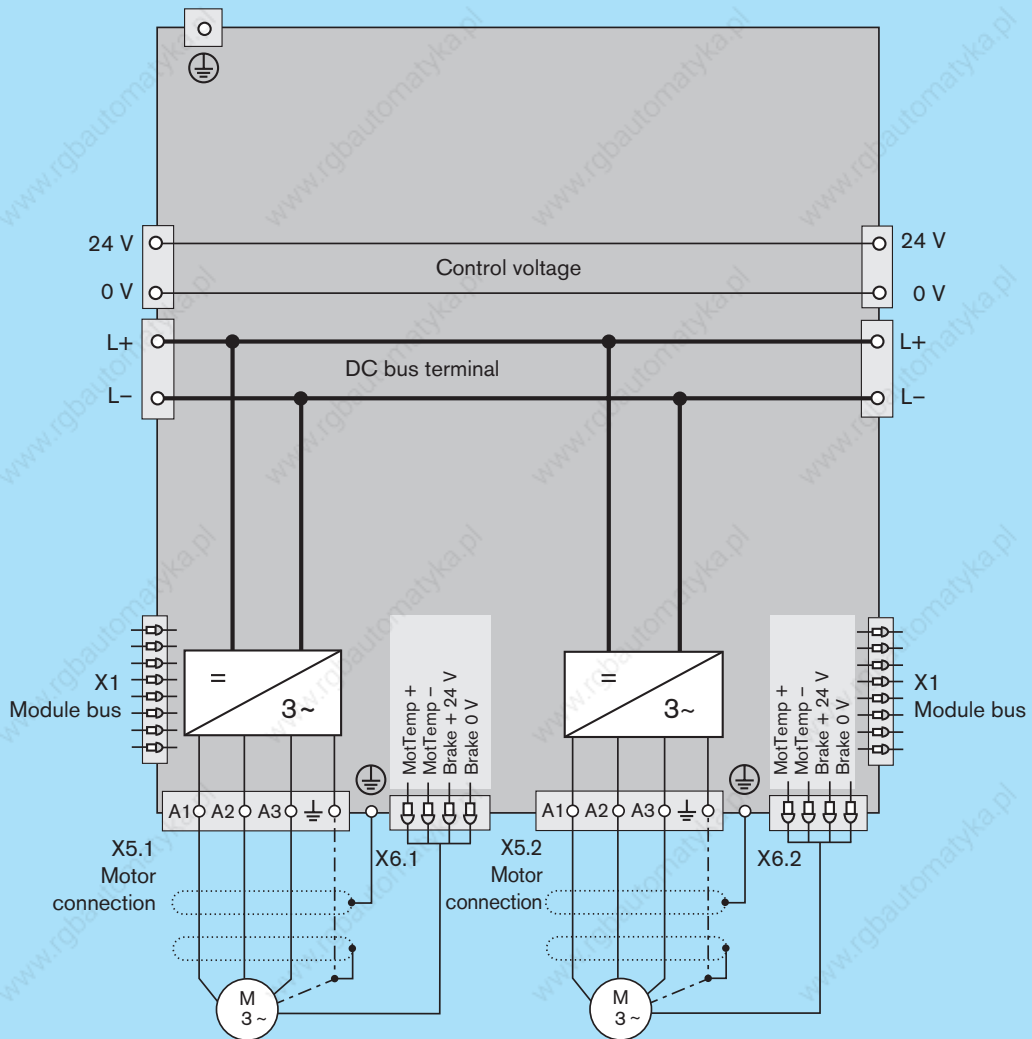

IndraDrive M – modular power supplies HMV01

Models	Infeed modules			Regenerative modules					
	HMV01.1E-W0030-A-07	HMV01.1E-W0075-A-07	HMV01.1E-W0120-A-07	HMV01.1R-W0018-A-07	HMV01.1R-W0045-A-07	HMV01.1R-W0065-A-07	HMV01.1R-W0120-A-07	HMV02.1R-W0015-A-07	
no additional options	-NNNN	-NNNN	-NNNN	-NNNN	-NNNN	-NNNN	-NNNN	-NNNN	
Performance data									
DC bus continuous power without/with choke	kW	18/30	45/75	72/120	-/18	-/45	-/65	-/120	-/15
Maximum output	kW	45	112	180	45	112	162	180	29
Mains voltage	V	3 AC 400 ... 480 (+10/-15 %)							
Continuous input mains current	A	51	125	200	26	65	94	181	23
Dependence of output on mains		at $U_{LN} < 400$ V: 1 % power reduction per 4 V							
		at $U_{LN} > 400$ V: 1 % power gain per 4 V			at $U_{LN} > 400$ V: no power gain				
DC bus capacity	μ F	1,410	3,760	5,640	705	1,880	2,820	4,950	700
DC bus voltage range	V	DC 435 ... 710			DC 750 (regulated)				
Brake resistor									
Brake resistor		internal						external	internal
Maximum braking energy consumption	kWs	100	250	500	80	100	150	-	40
Continuous braking power	kW	1.5	2.0	2.5	0.4	0.4	0.4	-	0.3
Maximum braking power	kW	36	90	130	36	90	130	-	33
Control voltage data									
Control voltage, external	V	DC 24 \pm 5 %							
Power consumption	W	25	30	55	31	41	108	224 ¹⁾	27
Continuous current	A	1.0	1.3	2.3	1.3	1.9	4.5	13.0 ¹⁾	1.1
Mechanical data									
Width W	mm	150	250	350	175	250	350	350	150
Height H	mm	440 ²⁾						352	
Depth D (incl. plug)	mm	309						265	
Mass	kg	13.5	22	32	13.5	20	31	34.5	9.5

In the case of the HMV01.1R the continuous output and maximum output data also apply feedback mode.

All data apply to nominal rating at 3 AC 400 V mains voltage

Connection option for auxiliary components, such as HLB, HLC etc.

¹⁾ including auxiliary filter HAB

²⁾ overall height HMV01.1R-W0120 with auxiliary fan HAB: 748 mm



HMV01

HMV01.1E-W0030
 HMV01.1E-W0075
 HMV01.1E-W0120
 HMV01.1R-W0018
 HMV01.1R-W0045
 HMV01.1R-W0065

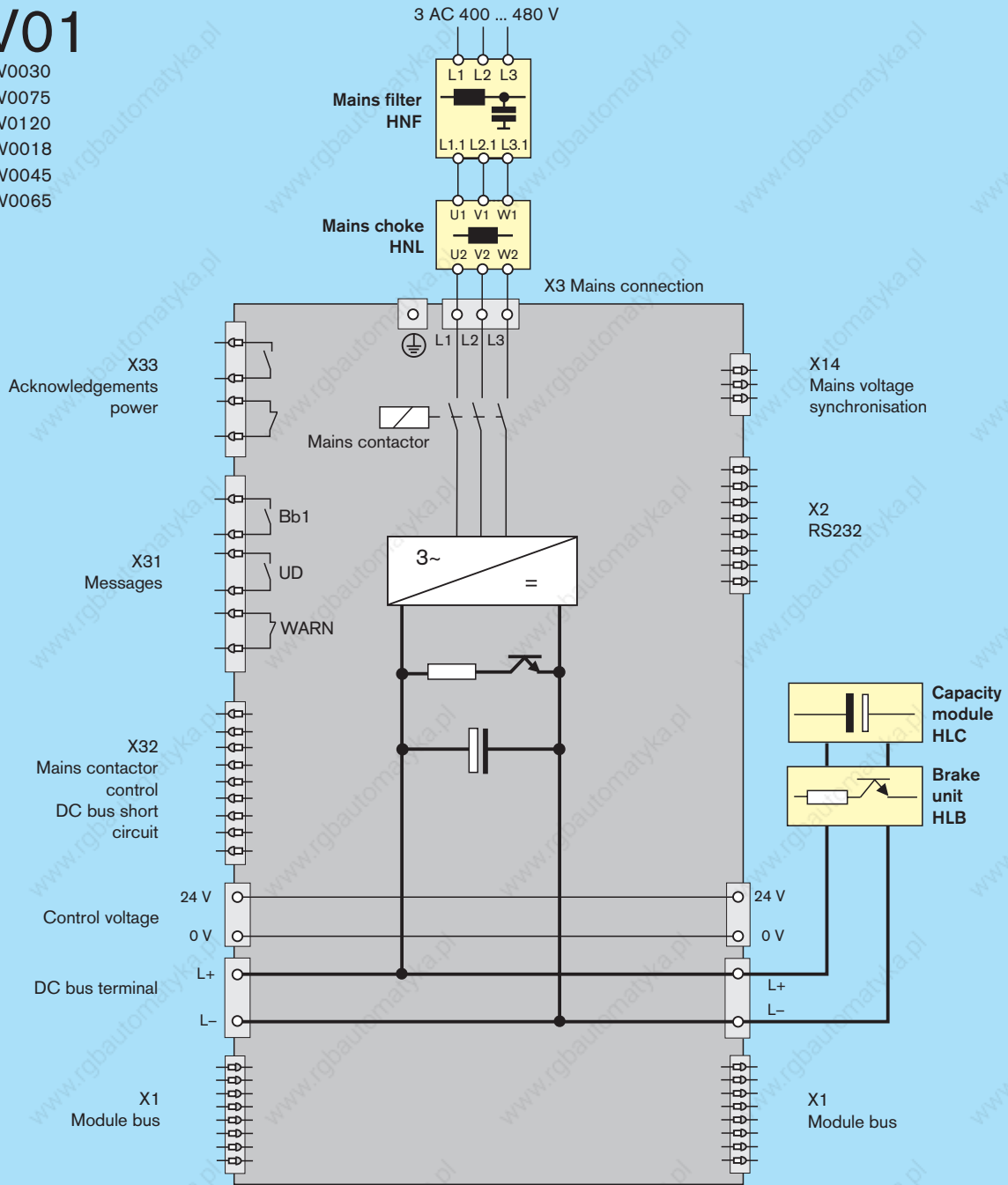

 Optional auxiliary component
 Mains choke HNL always required with HMV01.1R
 Connection X14 on HMV01.1R only

HMV01

HMV01.1R-W0120

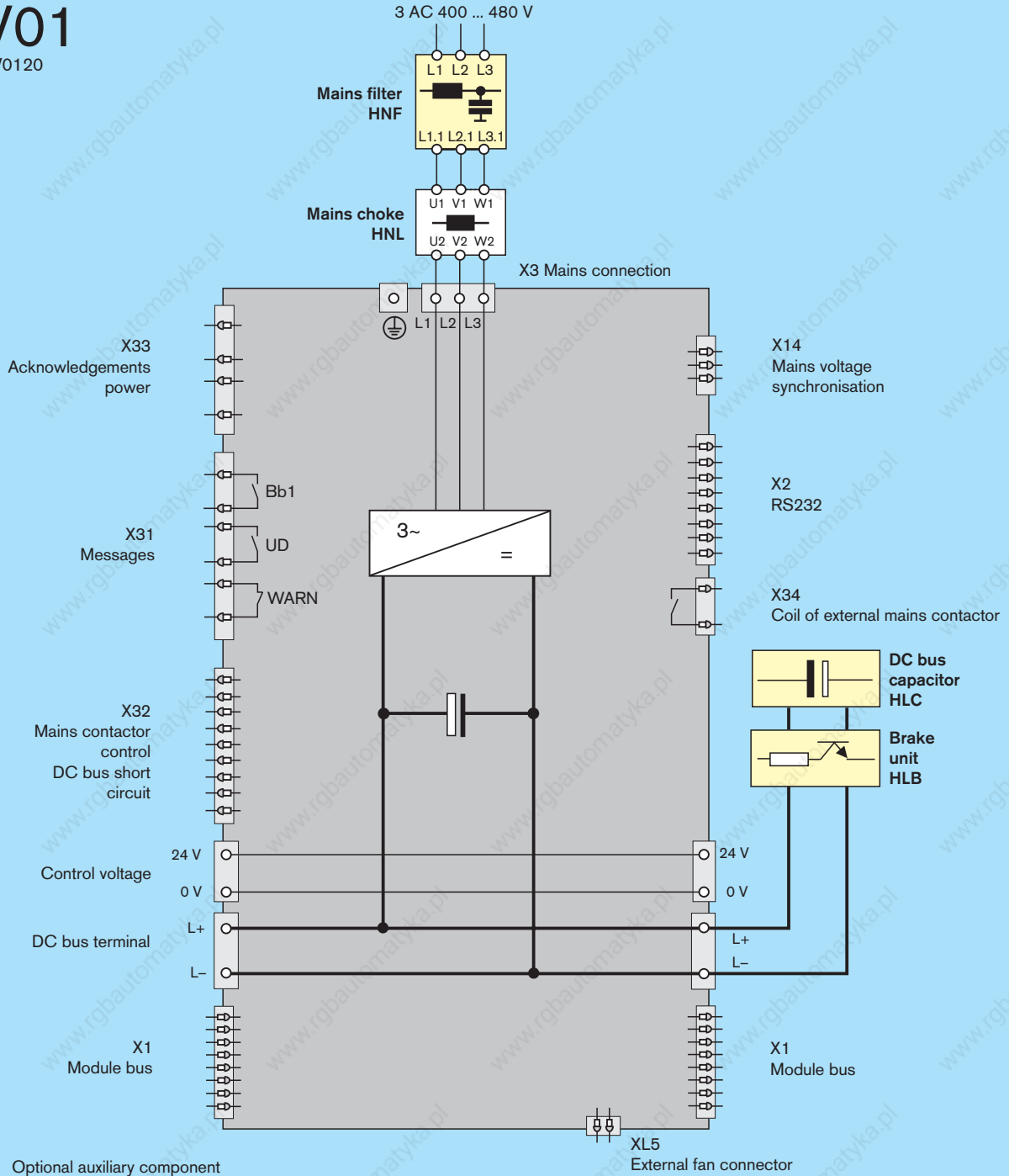

 Optional auxiliary component

HMV02

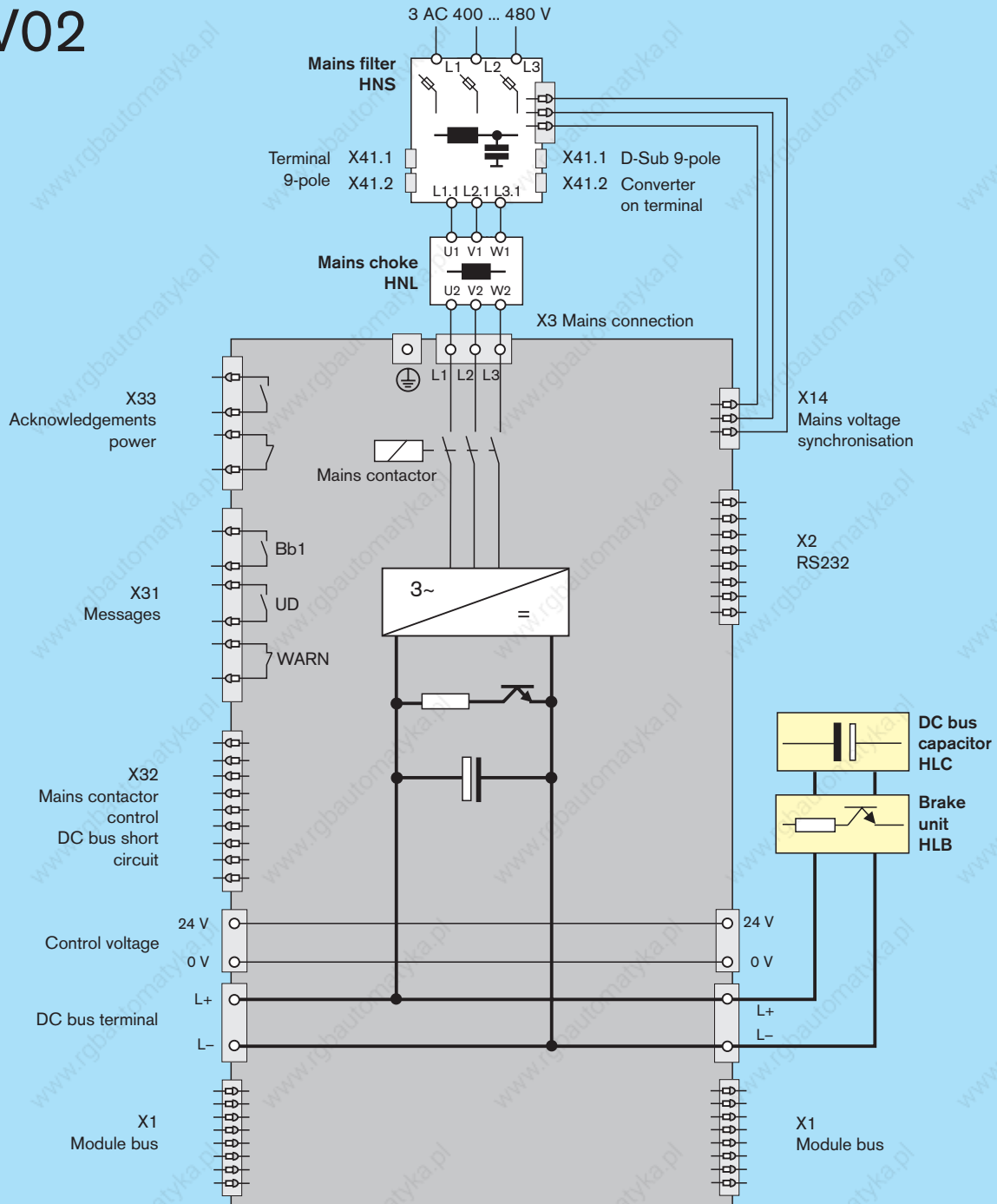

 Optional auxiliary component

Derating under differing operating conditions

Where installation conditions differ, the performance data of the power units decrease according to the capacity utilization factors for:

- Continuous current
- DC bus continuous output
- Continuous braking power

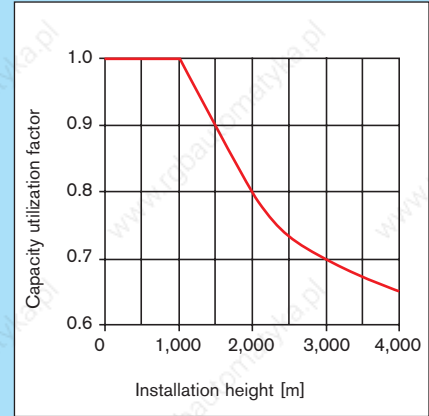
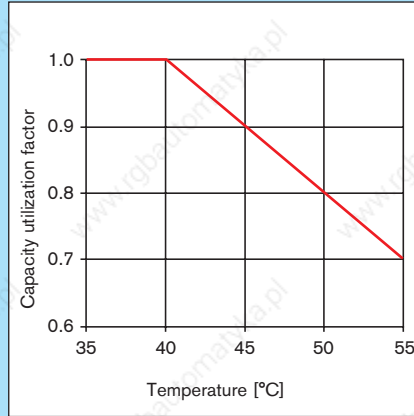

Compared with operation at 4 kHz switching frequency, the output currents of the power units decrease at higher switching frequencies. Please refer to these diagrams for the capacity utilization factors relevant for your application.

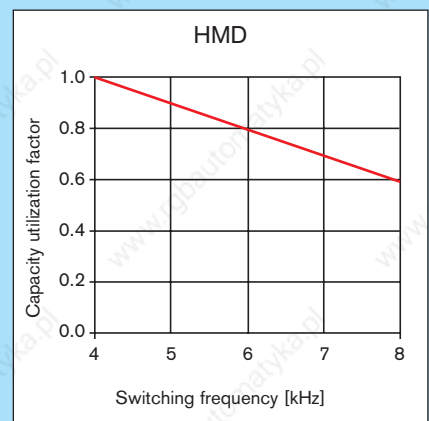
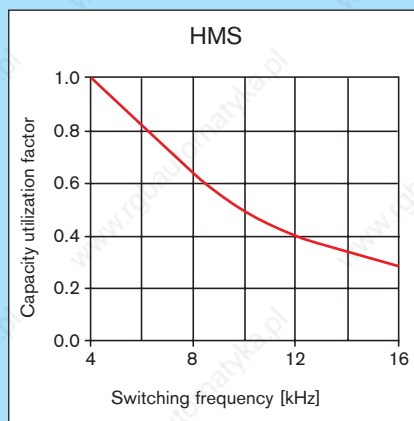
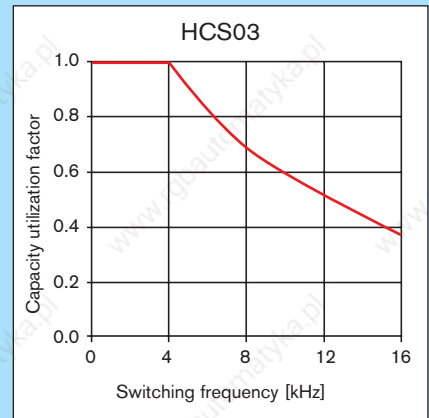
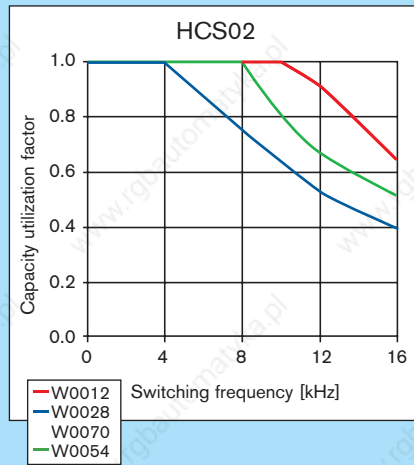



Rexroth IndraDrive – control units





Scalable performance and functionality

- Individual solutions for standard to high-end applications
- Integrated Motion Logic with innovative technology functions
- Open interfaces for international use
- Certified safety technology

Your benefits

We can supply control units tailored to your specific application, ranging from standard to high-end applications. Integrated Motion Logic, numerous technology functions, certified safety technology and standardized interfaces leave nothing to be desired.

BASIC control units – standard performance and functionality

These control units constitute the economic solution for all standard applications with moderate requirements in terms of performance and interface flexibility.

A standard encoder interface for IndraDyn motors is already featured among the BASIC control units. The BASIC UNIVERSAL control units have an additional expansion slot available.

The following BASIC control units are available to choose from:

- BASIC OPEN LOOP
- BASIC ANALOG
- BASIC PROFIBUS
- BASIC SERCOS
- BASIC UNIVERSAL – single-axis
- BASIC UNIVERSAL – dual-axis

ADVANCED control units – maximum flexibility and performance

These control units meet the highest requirements in terms of performance.

Virtually any application can be tackled with the wide range of communication and encoder interfaces as well as analog or digital inputs and outputs.



IndraDrive – scalable performance and functionality

All IndraDrive control units – from the simple frequency converter to the high-end servo drive with integrated Motion Control – are compatible with all IndraDrive C converters and IndraDrive M inverters.

The control units differ in performance, function and configuration. When combined with the various firmware versions and operating panels, every conceivable requirement can be met. This flexible system concept opens up the full range of options when it comes to tackling your individual application – always providing the optimum technical and economical solution.

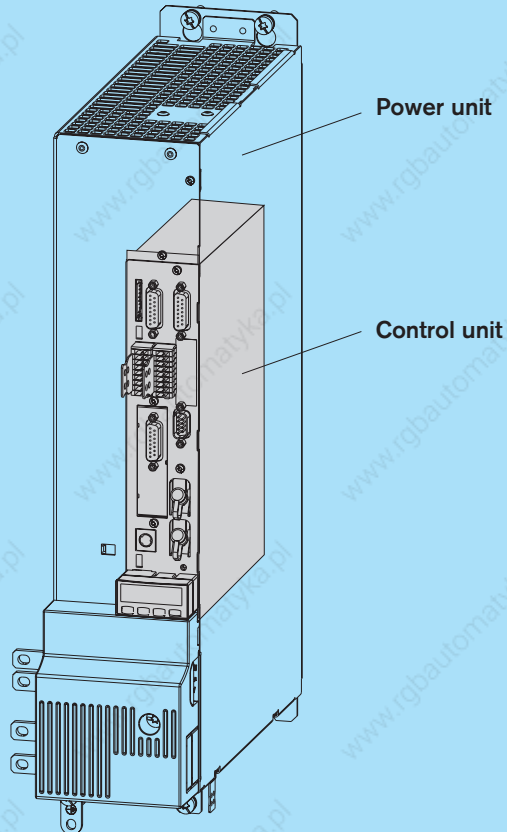

Overview	Single-axis	Single-axis	Single-axis	Single-axis	Single-axis	Dual-axis	Single-axis
	BASIC OPEN LOOP	BASIC ANALOG	BASIC PROFIBUS	BASIC SERCOS	BASIC UNIVERSAL	BASIC ⁵⁾ UNIVERSAL	ADVANCED
Control communication							
Analog/digital for OPEN LOOP operation	●	–	–	–	–	–	–
Analog Interface	–	●	–	–	–	–	○ ¹⁾
Parallel Interface	–	–	–	–	○	○	○
PROFIBUS DP	–	–	●	–	○	○	○
SERCOS interface	–	–	–	●	○	○	○
SERCOS III	–	–	–	–	○	○	○
PROFINet IO (in prep.)	–	–	–	–	○	○	○
CANopen	–	–	–	–	○	–	○
DeviceNet	–	–	–	–	○	–	○
Configurations							
Option 1	–	● ²⁾	● ²⁾	● ²⁾	● ²⁾	●/●	●
Option 2	–	–	–	–	●	●/●	●
Option 3	–	–	–	–	–	–	●
Safety option	–	●	●	●	●	●/●	●
Slot for MultiMedia Card	–	–	–	–	●	●	●

Options	Single-axis	Single-axis	Single-axis	Single-axis	Single-axis	Dual-axis	Single-axis
	BASIC OPEN LOOP	BASIC ANALOG	BASIC PROFIBUS	BASIC SERCOS	BASIC UNIVERSAL	BASIC ⁵⁾ UNIVERSAL	ADVANCED
Encoder interfaces							
IndraDyn motors MSK, MAD and MAF Hiperface, 1 V _{SS} and 5 V TTL ³⁾	-	●	●	●	●	○	○
MHD, MKD and MKE motors	-	-	-	-	○	○	○
EnDat 2.1, 1 V _{SS} and 5 V TTL ⁴⁾	-	-	-	-	○	○	○
Safety options compliant with EN 954-1							
Starting lockout compliant with EN 954-1, Cat. 3 for the prevention of unintentional restart	-	○	○	○	○	○	○
Safety technology conforming to EN 954-1, Cat. 3	-	-	-	-	-	○	○
Expansions							
Encoder emulation	-	●	-	-	○	○	○
Analog I/O extension	-	-	-	-	○	○	○
Digital I/O extension	-	-	-	-	-	-	○
Digital I/O with SSI encoder interface	-	-	-	-	-	-	○
Cross communication	-	-	-	-	-	-	○
Software module							
MultiMedia Card	-	-	-	-	○	○	○
Operation panel							
Standard	●	●	●	●	●	●	●
Comfort	○	○	○	○	○	○	○

Technical data		Single-axis	Single-axis	Single-axis	Single-axis	Single-axis	Dual-axis	Single-axis
		BASIC OPEN LOOP	BASIC ANALOG	BASIC PROFIBUS	BASIC SERCOS	BASIC UNIVERSAL	BASIC ⁵⁾ UNIVERSAL	ADVANCED
Cycle times								
Current control	μs	125						62.5
Speed control	μs	250						125.0
Position control	μs	500						250.0
PWM frequency								
4/8 kHz		●/●	●/●	●/●	●/●	●/●	●/●	●/●
12/16 kHz		-/-	-/-	-/-	-/-	-/-	-/-	●/●
Inputs/outputs								
Digital inputs/of which utilizable for touch probes		8/-	5/-	5/1	5/1	5/1	18/2	7/2
Digital inputs/outputs (user-defined settings)		-	4	3	3	3	4	4
Analog inputs		2	2	-	-	-	1	1
Analog outputs		2	-	-	-	-	2	2
Relay outputs		3	1	1	1	1	1	1
Interfaces								
RS232		●	●	●	●	●	●	●
Control voltage data								
Control voltage	V	DC 24						
Power consumption without options	W	7.5	8.0	7.5	7.5	6.5	7.5	6.0
Continuous current without options	A	0.31	0.33	0.31	0.31	0.27	0.31	0.25

● Standard ○ Optional ¹⁾ in conjunction with additional options ²⁾ encoder interface for IndraDyn motors ³⁾ supply voltage 12 V ⁴⁾ supply voltage 5 V
⁵⁾ only in connection with power unit HMD

BASIC OPEN LOOP – for all applications without an encoder

Interfaces

Digital inputs and outputs
Analog inputs and outputs

Interfaces

Relay outputs

Interfaces

Analog inputs and outputs

Serial interface

RS232

Operation panel

Standard operation panel

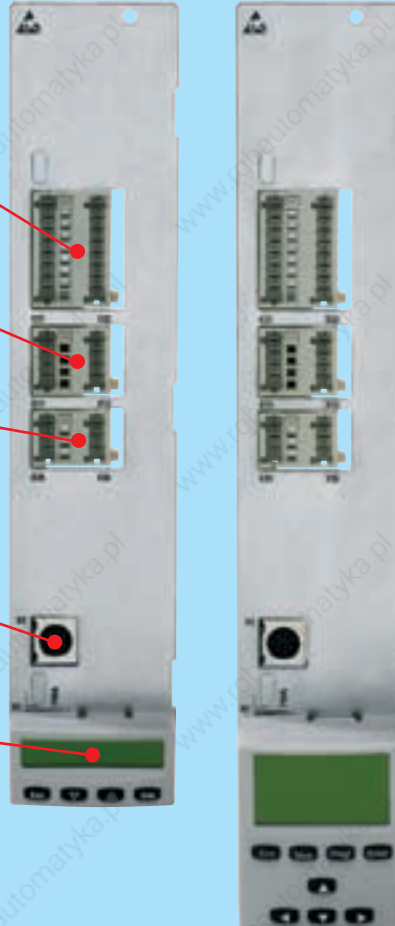

This control unit is specifically designed for frequency converter applications without a encoder.

The target speed can be set via analog or digital inputs.

Status signals and diagnostic messages are output via digital outputs or isolated relay contacts.

For an easy start-up use either the optional VCP 01 operating panel or a PC with the Rexroth IndraWorks software.

The simple step-by-step guide to ordering your BASIC OPEN LOOP control unit:

CSB01.1N-FC-NNN-NNN-NN-S-NN-FW

Single-axis BASIC

Control communication
FC = Frequency Converter Interface

Operation panel
S = Standard

BASIC ANALOG – cost-effective, proven technology

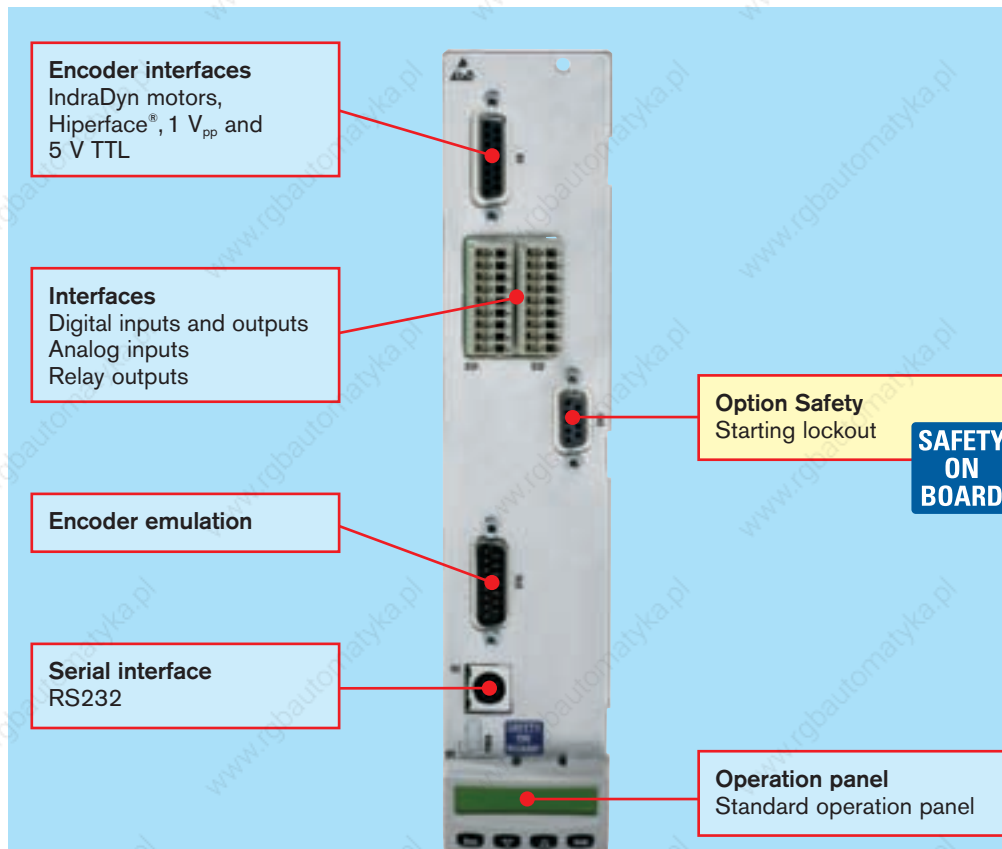

This control component allows you to enjoy the many benefits of digital drive technology on controls with the conventional ± 10 V analog interface. In addition, it gives you the added option of expanding your control equipment at any time to include other communication interfaces by exchanging the control component while retaining the control cabinet setup.

The default speed is set via the analog input. Signals, such as “Control enable” or “Drive stop”, are exchanged by the control system and control unit via digital inputs and outputs. The encoder emulation inside the drive systematizes the actual positions for the control system. There is a choice between the straightforward incremental encoder signal or SSI format.

The correct interface for connecting the IndraDyn motors or other standardized encoders, such as Hiperface, is already integrated.

The simple step-by-step guide to ordering your BASIC ANALOG control unit:

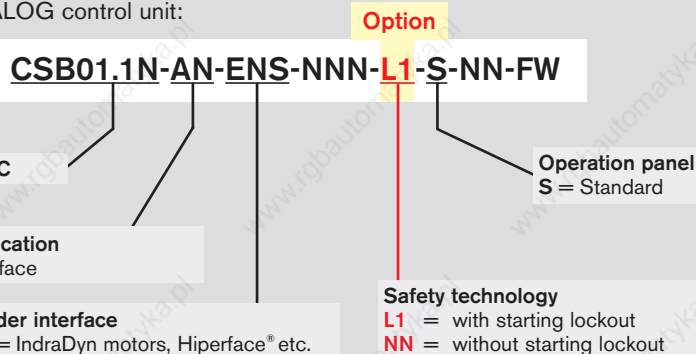

BASIC PROFIBUS – ideal for factory automation

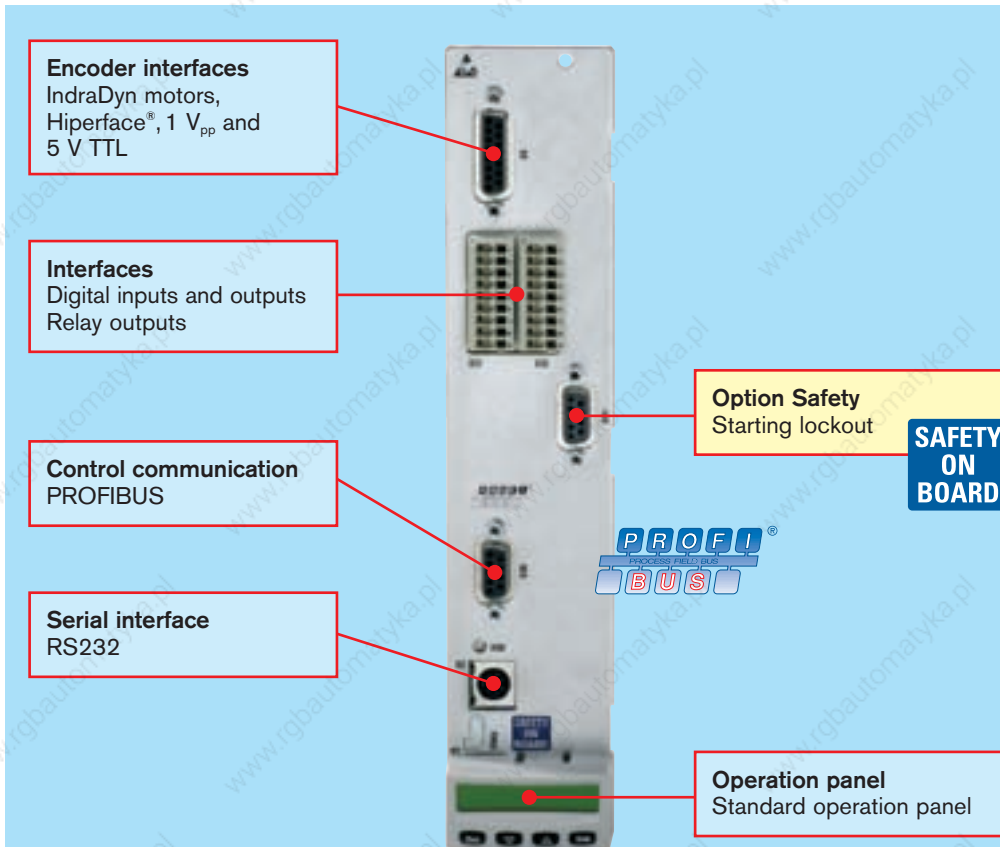

The PROFIBUS fieldbus interface has been used successfully for many years in automated manufacturing technology and process automation.

This bus system is the means by which the control system cyclically exchanges with the bus users all the specified and actual values, including status signals and diagnostic messages.

The correct interface for connecting the IndraDyn motors or other standardized encoders, such as Hiperface, is already integrated.

Start-up with the IndraWorks engineering tool is a convenient option via PROFIBUS. Alternatively, the drive can also be started up via the optional VCP 01 operating panel.

The simple step-by-step guide to ordering your BASIC PROFIBUS control unit:

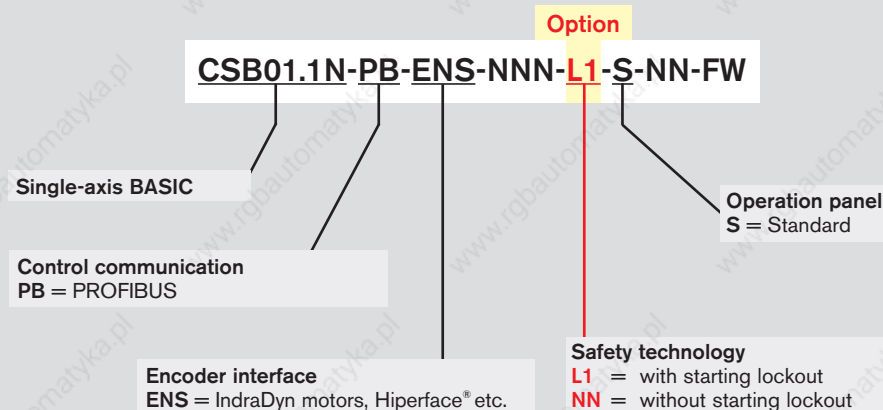

BASIC SERCOS – precise and cost-effective

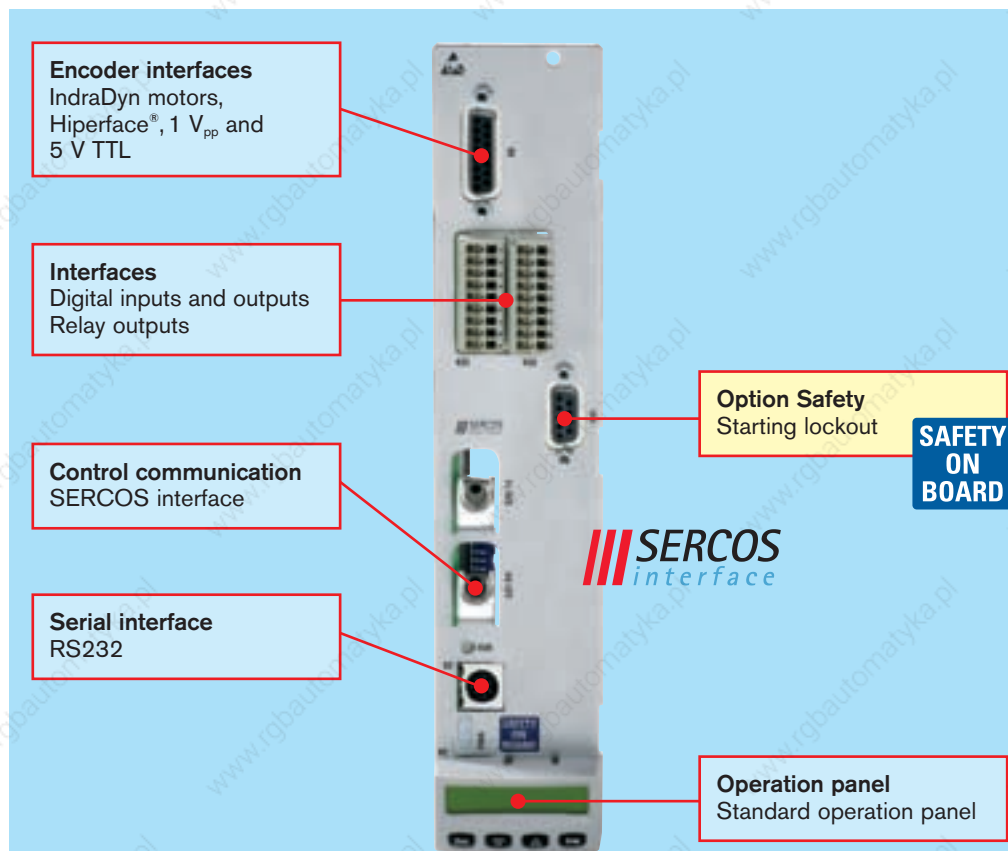

Only with the SERCOS interface¹⁾ can you benefit from all the advantages of digital intelligent drive technology. One distinguishing feature of SERCOS is its extremely short cycle time with which all target and actual values are transferred between the control system and control units. In conjunction with the exact synchronization of all drives, the SERCOS interface guarantees maximum dynamics and precision.

Signal transfer via fiber optics guarantees the secure exchange of real-time data with minimal wiring.

The correct interface for connecting the IndraDyn motors or other standardized encoders, such as Hiperface, is already integrated.

With the engineering tool, IndraWorks, one convenient start-up option is via the SERCOS service channel and the other is via the RS232 interface.

The simple step-by-step guide to ordering your BASIC SERCOS control unit:

CSB01.1N-SE-ENS-NN-L1-S-NN-FW

Single-axis BASIC

Control communication
SE = SERCOS interface

Encoder interface
ENS = IndraDyn motors, Hiperface® etc.

Option

Safety technology
L1 = with starting lockout
NN = without starting lockout

Operation panel
S = Standard

¹⁾ SERCOS interface, the internationally standardized drive interface (IEC 61491/ EN 61491) facilitates optimum compatibility of digital drives and controls made by different manufacturers while exploiting the respective product attributes to maximum effect.

BASIC UNIVERSAL single-axis – flexible for customized solutions

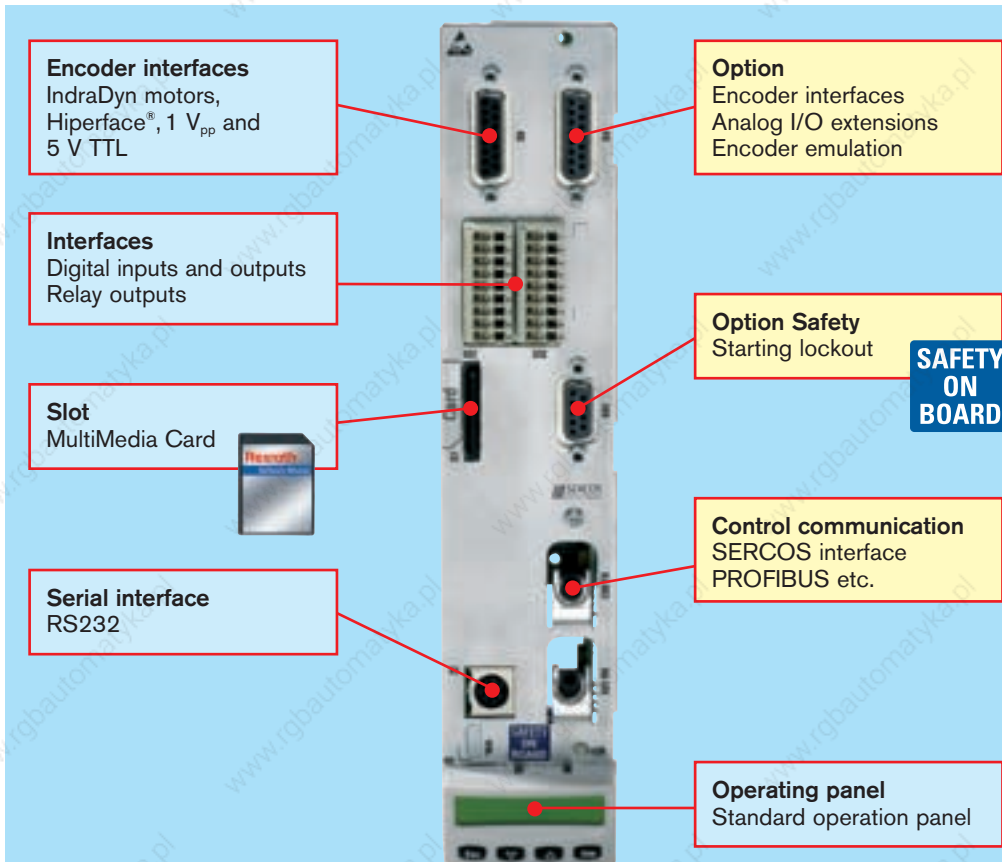

Regardless of your preferred type of control communication, BASIC UNIVERSAL offers you a wide range of industry-standard interfaces. As a result, this control unit is well suited for a variety of applications – including those in your industry.

The correct interface for connecting the IndraDyn motors or other standardized encoders, such as Hiperface, is already integrated. In addition, this control unit has an empty slot for the connection of another encoder, connection of the analog I/O extension or for the emission of emulated encoder signals.

An additional plug-in MultiMedia Card gives you the option of simple transmission or duplication of your drive parameters. This card can also be used to expand the memory for the Motion Logic integrated in the drive (firmware option).

For an easy start-up use either the optional VCP 01 operating panel or a PC with the Rexroth IndraWorks software.

The simple step-by-step guide to ordering your BASIC UNIVERSAL single-axis control unit:

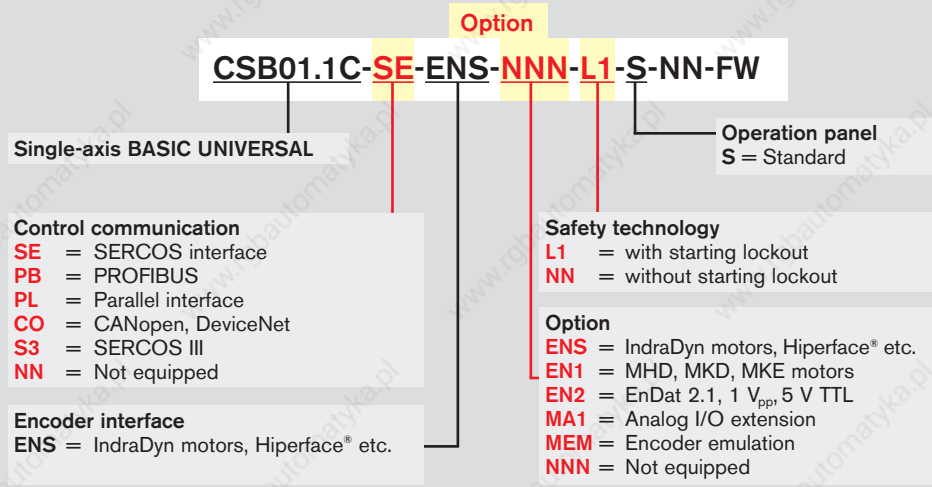

BASIC UNIVERSAL dual-axis – flexible, reliable, space-saving

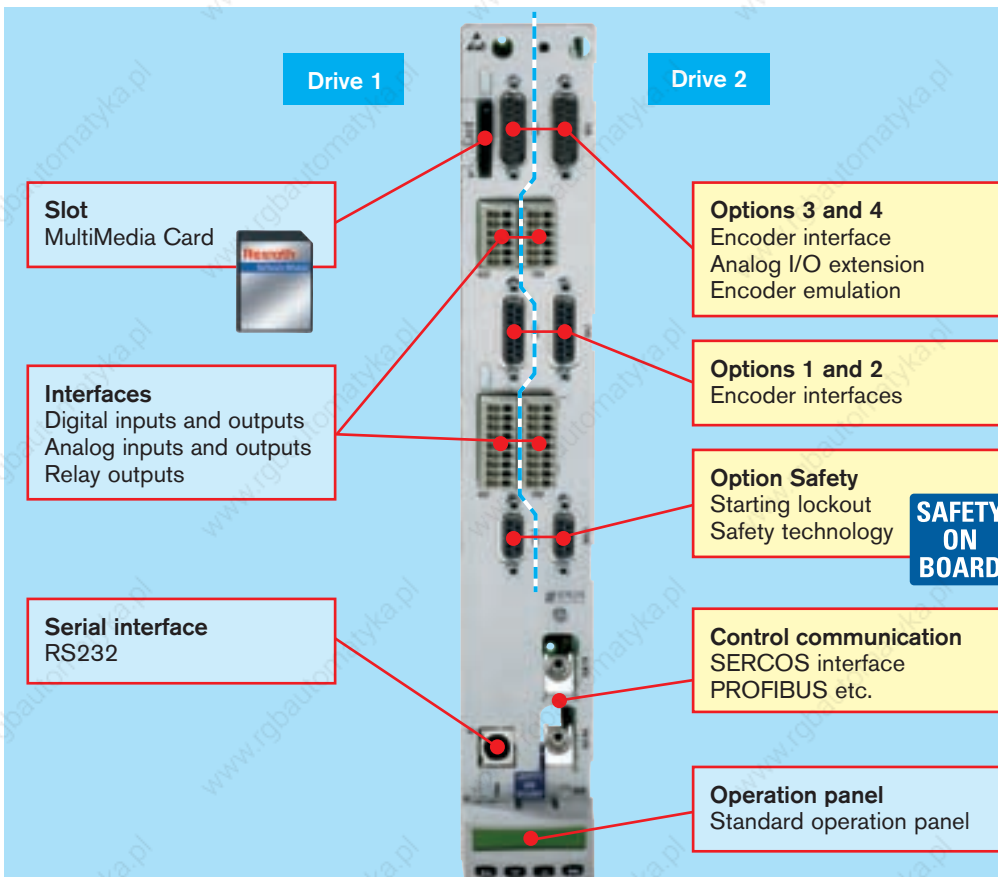

Many axes and limited installation space – these are typical requirements that can be met competently and economically with the BASIC UNIVERSAL dual-axis control unit. With the BASIC UNIVERSAL dual-axis, we have implemented all the functionality for two digital axes in a single control unit. The benefit for you is that, even if there are severe space constraints, you can integrate a number of drives thus minimizing your control cabinet footprint.

With certified safety technology conforming to EN 954-1, Category 3, you are providing effective protection for both the machine and operator. Indeed, we have integrated a number of different safety functions, such as “Safe stop” and “Safe motion”, directly in the drive. This increases reliability while saving on monitoring components and minimizing installation work.

In terms of control communication you can choose between SERCOS interface, PROFIBUS, SERCOS III and PROFInet IO. In the interests of meeting the specific demands of your individual application, IndraDrive offers additional options for the connection of various encoder systems, the connection of an analog I/O extension or for the emission of emulated encoder signals.

The dual-axis control unit offers the ability of storing the axis-oriented drive parameters of both axes on the optional MultiMedia Card.

For an easy start-up use either the optional VCP 01 operating panel or a PC with the Rexroth IndraWorks software.

The simple step-by-step guide to ordering your BASIC UNIVERSAL dual-axis control component:

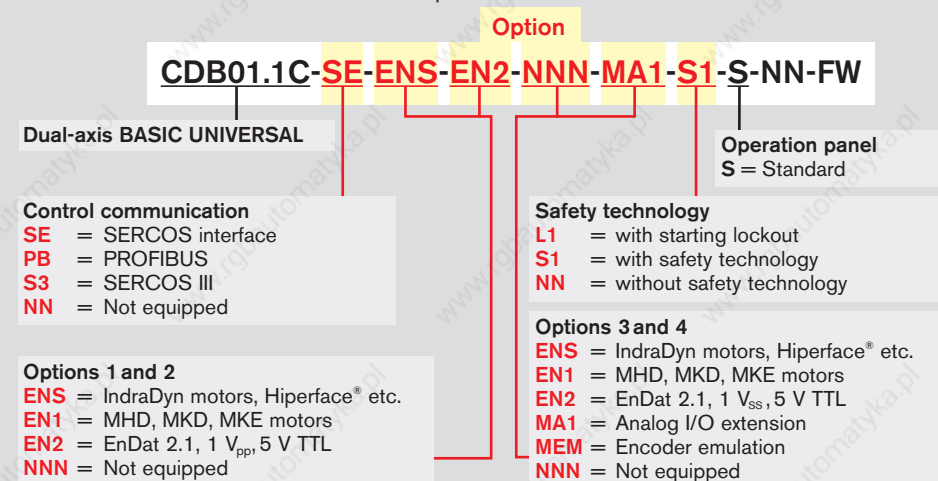

ADVANCED – the security of maximum performance and flexibility

Slot MultiMedia Card

Option 1
Encoder interface

Option 2
Encoder interface
Analog I/O extension
Encoder emulation

Option Safety
Starting lockout
Safety technology

Option 3
Encoder interfaces
Analog I/O extension
Encoder emulation
Digital I/O extension
Cross communication

Control communication
SERCOS interface
PROFIBUS etc.

Interfaces
Digital inputs and outputs
Analog inputs and outputs
Relay outputs

Serial interface
RS232

Operation panel
Standard operation panel

SAFETY ON BOARD

ADVANCED control units meet the highest demands in performance and dynamics.

In addition to top performance, they support a wide and diverse range of control communication and encoder interfaces. Digital and analog inputs and outputs are already permanently integrated for communication with higher level control systems. These can also be expanded by digital or analog I/O extensions or by encoder emulation outputs. This high-performance control unit can be optionally equipped with safety technology certified as conforming to EN 954-1, Category 3. The ADVANCED control unit is the ideal platform for the drive-integrated PLC, IndraMotion MLD.

All that is required to start up the drive is a PC and the engineering tool IndraWorks or a connected comfort operating panel.

The simple step-by-step guide to ordering your ADVANCED control component:

Option
CSH01.1C-SE-ENS-EN2-NNN-S1-S-NN-FW

Single-axis ADVANCED

Operation panel
S = Standard

Control communication

- SE** = SERCOS interface
- PB** = PROFIBUS
- PL** = Parallel interface
- CO** = CANopen, DeviceNet
- S3** = SERCOS III
- NN** = Not equipped

Option 1 (encoder interface)

- ENS** = IndraDyn motors, Hiperface® etc.
- EN1** = MHD, MKD, MKE motors
- EN2** = EnDat 2.1, 1 V_{pp}, 5 V TTL
- NNN** = Not equipped

Option 2

- ENS** = IndraDyn motors, Hiperface® etc.
- EN1** = MHD, MKD, MKE motors
- EN2** = EnDat 2.1, 1 V_{pp}, 5 V TTL
- MA1** = Analog I/O extension
- MEM** = Encoder emulation
- NNN** = Not equipped

Safety technology

- L1** = with starting lockout
- S1** = with safety technology
- NN** = without safety technology

Option 3

- ENS** = IndraDyn motors, Hiperface® etc.
- EN1** = MHD, MKD, MKE motors
- EN2** = EnDat 2.1, 1 V_{pp}, 5 V TTL
- MA1** = Analog I/O extension
- MEM** = Encoder emulation
- MD1** = Digital I/O extension
- MD2** = Digital I/O with SSI encoder interface
- CCD** = Cross communication
- NNN** = Not equipped

Accessories – advantages for your control unit

These components can help you to capitalize on your drive – during start-up, operation and diagnostics.

Operation panels

All control units are equipped with a standard plug-in operating panel. An optional comfort operating panel with graphics capabilities. This will guide you quickly and confidently through all the start-up steps – no PC is required. Moreover, the comfort operating panel offers the capability of transmitting the drive parameters from one drive to another – quickly and easily.



Separate control terminals

For complex applications, especially in conjunction with the drive-integrated Motion Logic, we recommend the use of our compact control terminals IndraControl VCP. Connection is via the drive's serial interface.

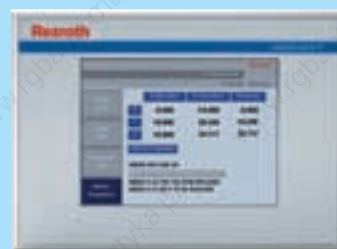
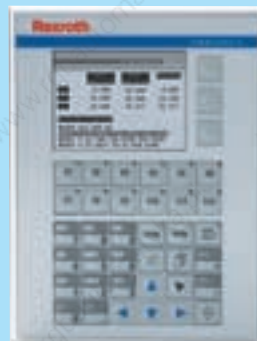

From the simple text display right through to the graphics-capable touch screen, it always provide a particularly cost-effective solution for operation and visualization.

For more detailed information, please refer to the product catalog "Automation Systems and Control Components" (R911320438).



Software module

The optional MultiMedia Card allows you to transmit or duplicate your axis-oriented drive parameters quickly and easily – without a PC.



This software module comes in two versions:

- PFM02.1-016-NN-FW with drive firmware
- PFM02.1-016-NN-NW preformatted for simple parameter transfer

Interface cable

For start-up or operation connect your PC or a separate control terminal directly to the RS232 serial interface of the control unit.

The pre-assembled PC interface cable IKB0041 is available in lengths of 2, 5, 10 or 15 m.

The RKB0004 operator terminal cable is available in lengths of 2, 5 and 10 m.



Overview of interfaces

Control communication

Analog/digital for OPEN LOOP operation

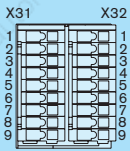

- 2 x 9-pin plug-in terminals
- 8 digital inputs

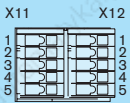

- 2 x 5-pin plug-in terminals
- 3 relay outputs (24 V DC and 230 V AC)

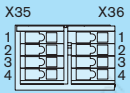

- 2 x 4-pin plug-in terminals
- 2 analog inputs
 - 2 analog outputs

Analog interface

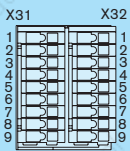

- 2 x 9-pin plug-in terminals
- Analog inputs ± 10 V
 - Digital inputs/outputs
 - Relay output

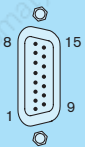

- D-SUB, 15-pin, male version
- Encoder emulation, incremental or absolute (SSI)
 - Output frequency max. 1 MHz

Parallel interface

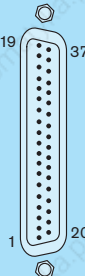

- D-SUB, 37-pin, male version
- 16 inputs, reverse polarity protected
 - 16 outputs, short-circuit proof
 - DC-isolated

Also suitable for input/output expansion in conjunction with IndraMotion MLD

SERCOS interface



- 2 x fiber optic cable connections



- Choice of transfer rates
2, 4, 8 or 16 Mbaud

PROFIBUS DP

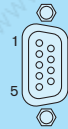

- D-SUB, 9-pin, female version

CANopen/DeviceNet



- Open-style connector, 5-pin

- Selector switch for CANopen or DeviceNet

SERCOS III



- 2 x RJ45 plug-in connection

Encoder interfaces

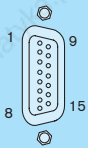

ENS encoder interface for IndraDyn motors, Hiperface®, 1 V_{pp}, 5 V TTL

D-SUB, 15-pin, female version
 • Encoder supply: 11.6 V/300 mA

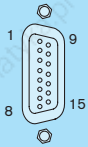

EN1 encoder interface for MHD, MKD and MKE motors

D-SUB, 15-pin, female version
 • Encoder supply I²C: 8 V/250 mA
 or resolver: 18.2 V/70 mA

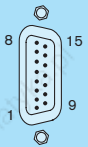

EN2 encoder interface for EnDat 2.1, 1 V_{pp}, 5 V TTL

D-SUB, 15-pin, male version
 • Encoder supply: 5 V/300 mA

Encoder emulation

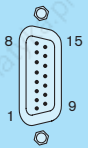

Encoder emulation **MEM**

D-SUB, 15-pin, male version
 • Internal voltage supply
 • Encoder signals DC-isolated
 • Incremental or
 • Absolute (SSI format)
 • Output frequency max. 1 MHz

Cross communication

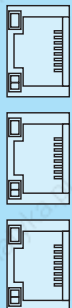

Cross communication **CCD**

3 x RJ45 plug-in connection
 • Master for connection of up to 7 Slaves (SERCOS III)
 • Ethernet engineering interface

Input/output extensions

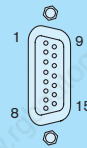

Analog I/O extensions **MA1**

D-SUB, 15-pin, female version
 • 2 analog input ports ± 10 V
 • 14 bit incl. 8-time oversampling
 • 2 analog 12 bit output ports

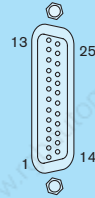

Digital I/O extensions **MD1**

D-SUB, 25-pin, male version
 • External voltage supply from 19 V to 30 V
 • 12 inputs, reverse polarity protected
 • 8 outputs, short-circuit proof

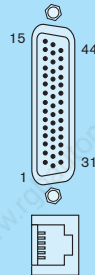

Digital I/O with SSI interface **MD2**

D-SUB, 44-pin, male version
 • External voltage supply from 19 V to 30 V
 • 16 inputs, reverse polarity protected
 • 16 outputs, short-circuit proof



RJ11 plug-in connection for SSI measuring encoder interface

Safety

Starting lockout **L1**

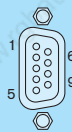

D-SUB, 9-pin, female version
 • Supply voltage 24 V DC
 • Drive signals A, B and inverse
 • Acknowledgement
 • Acknowledgement, inverse

Safety technology **S1**

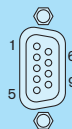

D-SUB, 9-pin, female version
 • Supply voltage 24 V DC
 • Mode selection panel inputs
 • Acknowledgement, forced dormant error detection and diagnostics/safety door lock

IndraDrive Mi – motor-integrated drive system



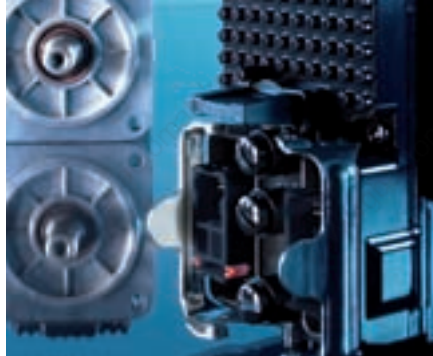

Compact and economically efficient:

- ! Maximum torques of up to 35 Nm
- ! Flexible extension options
- ! Easy project planning
- ! Less wiring
- ! Smaller control cabinet size

Your benefits

IndraDrive Mi – highest performance, smallest space requirements

With IndraDrive Mi, Rexroth introduces another milestone in drive technology – electronic control system and servo motor combined in one ultra-compact unit.

This makes IndraDrive Mi the ideal solution for all applications where maximum flexibility and economic efficiency should come along with minimum space requirements.

In addition to its compact design, IndraDrive Mi combines the best characteristics of an IndraDrive and MSK servo motor – from the drive-integrated PLC according to IEC 61131-3 up to protection category IP65.

Adaption box KCU

The adaption box KCU allows all required connections for a daisy chain of up to 20 IndraDrive Mi – This reduces the installation workload to a minimum.

Accessories

- Hybrid cable – for communication and power supply
- Terminal connector – for terminating the drive chain
- Interface cable – for connection to a PC
- Software module – for data transfer without a PC



IndraDrive Mi – the ultra-compact drive system

The compact control electronics of the IndraDrive Mi uses the lateral surface of the servo motor as a cooling element. This reduces the total unit size by more than 50 % compared to classical servo drive solutions and by up to 30 % compared to other integrated solutions.

Another advantage of the IndraDrive Mi is the significantly reduced installation work – a single cable is sufficient for power supply and communication via SERCOS interface.

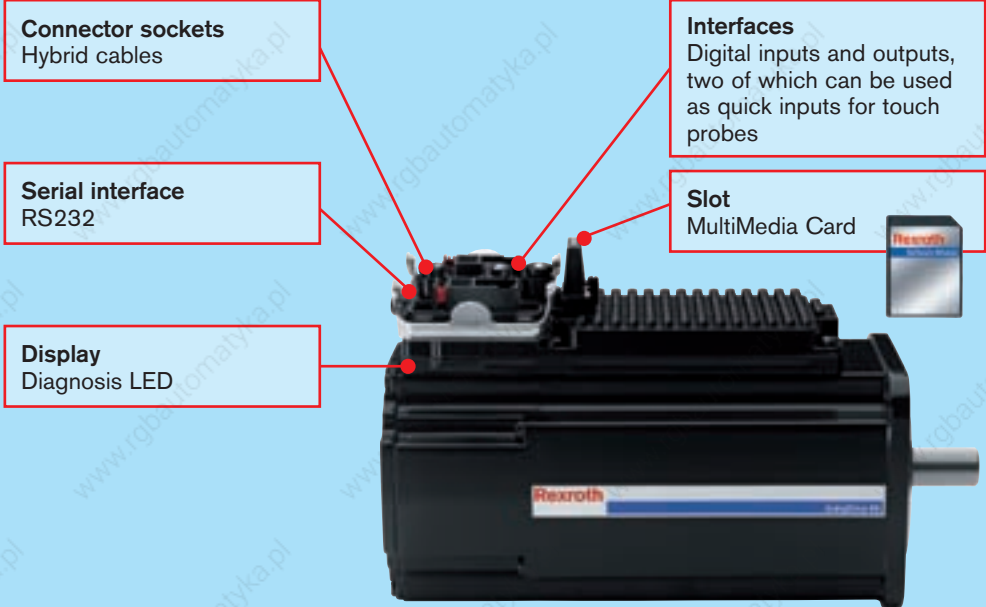

The simple step-by-step guide ordering your motor-integrated drive system – IndraDrive Mi:

Option
KSM01.2B-061C-35N-M1-HP0-SE-NN-D7-NN-FW

Control unit version
B = BASIC

Basic motor

- Overall size (e. g. "061")
- Overall length (e. g. "C")
- Winding (e. g. "35")

Cooling system
N = Natural convection

Encoder

- S1** = Singleturn encoder (Hiperface) 128 increments
- M1** = Multiturn encoder (Hiperface) 128 increments with 4096 revolutions absolute

Electrical connection
H = Connector, hybrid

Supply voltage
D7 = DC 750 V

Safety technology
NN = without safety technology (in preparation: CIP safety on SERCOS)

Control communication
SE = SERCOS interface (RS422)

Shaft

- G** = Plain shaft with shaft sealing ring
- P** = Keyway conforming to DIN 6885-1 and shaft sealing ring

Holding brake

- 0** = without holding brake
- 2** = with electrically released holding brake (DC 24 V)

Servo drive		Maximum speed	Continuous torque at standstill	Maximum torque	Continuous current at standstill	Maximum current	Moment of inertia	Dimensions							Mass ¹⁾	
		n_{Max} [rpm]	M_0 [Nm]	M_{Max} [Nm]	I_0 [A]	I_{Max} [A]	J_R [kgm ²]	A [mm]	B [mm]	C [mm]	$\varnothing D$ [mm]	$\varnothing E$ [mm]	$\varnothing F$ [mm]	$\varnothing G$ [mm]	H [mm]	m [kg]
KSM01.2B-041	C-42	5,500	2.2	9.4	1.4	6.8	0.000170	82	252	30	14	50	95	6.6	201	5.5/6.0
KSM01.2B-061	C-35	4,300	6.0	25.0	3.3	14.9	0.000870	115	271	40	19	95	130	9.0	216	9.5/10.3
	C-61	6,000	5.5	18.0	5.0	17.7										
KSM01.2B-071	C-24	3,400	10.5	35.0	4.4	17.7	0.001730	140	307	58	32	130	165	11.0	248	14.0/15.1
	C-35	4,700	10.0	28.0	5.7	17.7										
KSM01.2B-076	C-35	4,700	8.7	29.0	5.7	17.7	0.004300	140	290	50	24	110	165	11.0	248	14.5/15.6

All data refer to the operation with 750 V DC bus voltage

¹⁾ values without/with holding brake

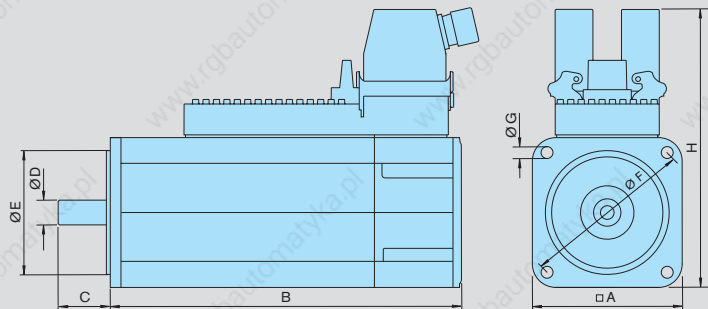
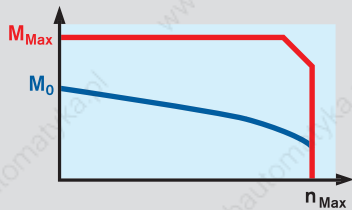

All advantages of IndraDrive Mi at one glance:

- Significant reduction of the cabinet size by up to 70 %
- Drastic reduction of wiring work by up to 85 %
- Significant increase of flexibility and modularity of machines and plants

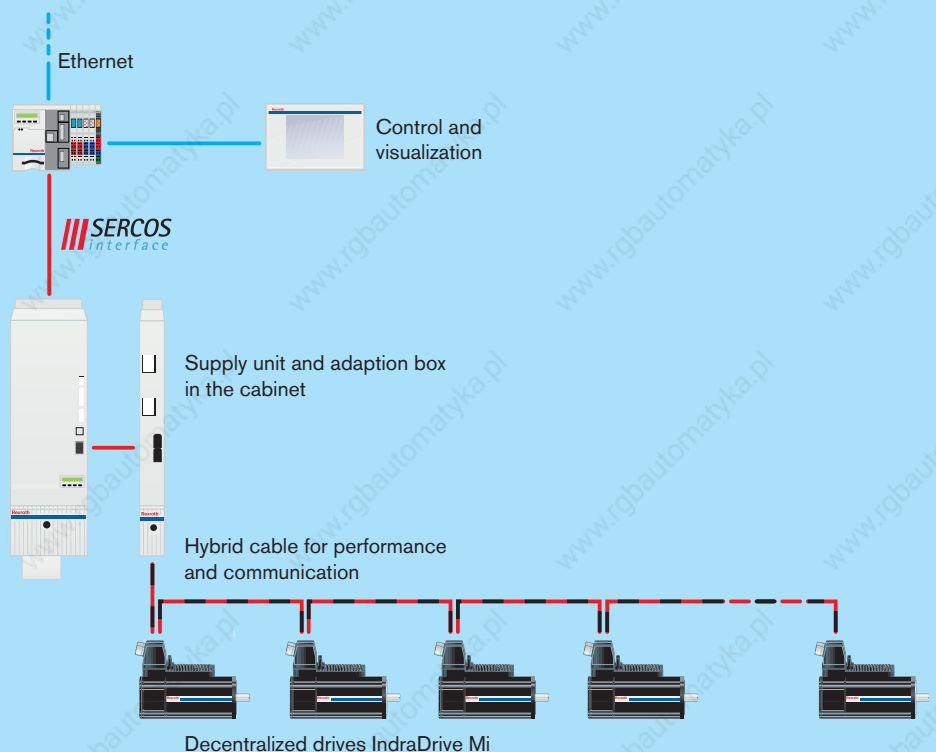

IndraDrive Mi – adaption box KCU

Adaption box	Nominal voltage input	Nominal current input	Width W	Height H	Depth D	Mass
	V	A	mm	mm	mm	kg
KCU01.2N-SE-SE*-025-NN-S-NN-NW	DC 540 ... 750	25	50	352	252	3.8

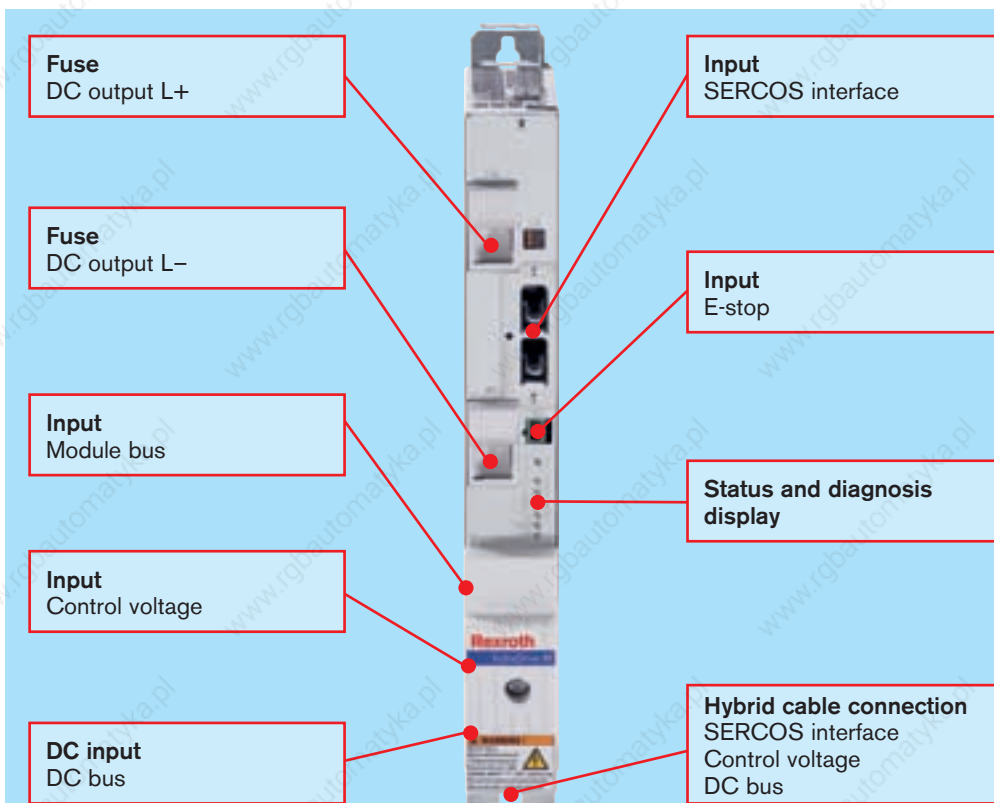

Adaption box KCU

In addition to its function as a signal converter for SERCOS interface, the compact adaption box KCU allows all necessary connections to the IndraDrive Mi at a common coupling.

- Conversion of SERCOS interface from the fiber optics cable to RS422
- Routing of the power supply from the DC bus of an IndraDrive converters or supply unit
- Exchange of status and diagnostic messages between IndraDrive Mi and supply unit
- Supply of control voltage to the IndraDrive Mi
- Protection of the DC bus connection with integrated fuses

Up to 20 IndraDrive Mi units can be flexibly connected in series in one drive chain – without any modifications to the cabinet or additional splitting boxes.

If required, it is also possible to operate several drive chains in parallel at one supply unit.

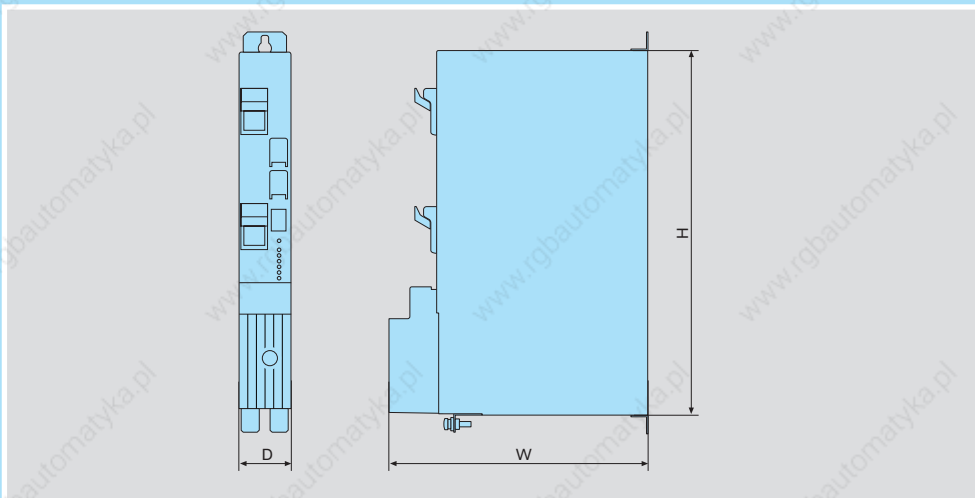

IndraDrive Mi – accessories

Hybrid cable RKH and terminal connector RHS

The significant reduction of installation work is one of the big advantages of the IndraDrive Mi – a single cable is sufficient for power supply and communication via SERCOS interface.

The hybrid cable RKH is supplied pre-assembled with plug-in connectors. Coded connectors ensure that the hybrid cable is connected with the correct polarity. From the wide range of connecting cables, select the suitable outgoing direction for your application.

Each cable with one or several IndraDrive Mi is connected with a terminal connector RHS0004.



Interface cable

For start-up or operation, connect your PC directly to the serial interface of the IndraDrive Mi.

The cable RKB0006 for connection of a PC to the IndraDrive Mi is available pre-assembled with a length of 5 m.



Software module ¹⁾

The MultiMedia Card provides an easy transmission or duplication of your drive parameters without PC.

¹⁾ included in the delivery



Rexroth IndraDrive – firmware

The firmware can be tailored to your specific application in a number of flexible configurations:

- Basic OPEN LOOP package (frequency converter applications)
- Basic CLOSED LOOP package (servo and frequency converter applications)
- Extension packages (optional)
- Motion Logic (IndraMotion MLD optional)

The basic package is already sufficient to perform the majority of standard drive functions – from simple V/f control right through to positioning block mode.

Various extension packages provide you with the options of electronic synchronization, additional servo functions or main spindle operation.

The freely-programmable Motion Logic with integrated PLC conforming to IEC 61131-3 and ready-to-use technology functions enable simple execution of complex machine processes.

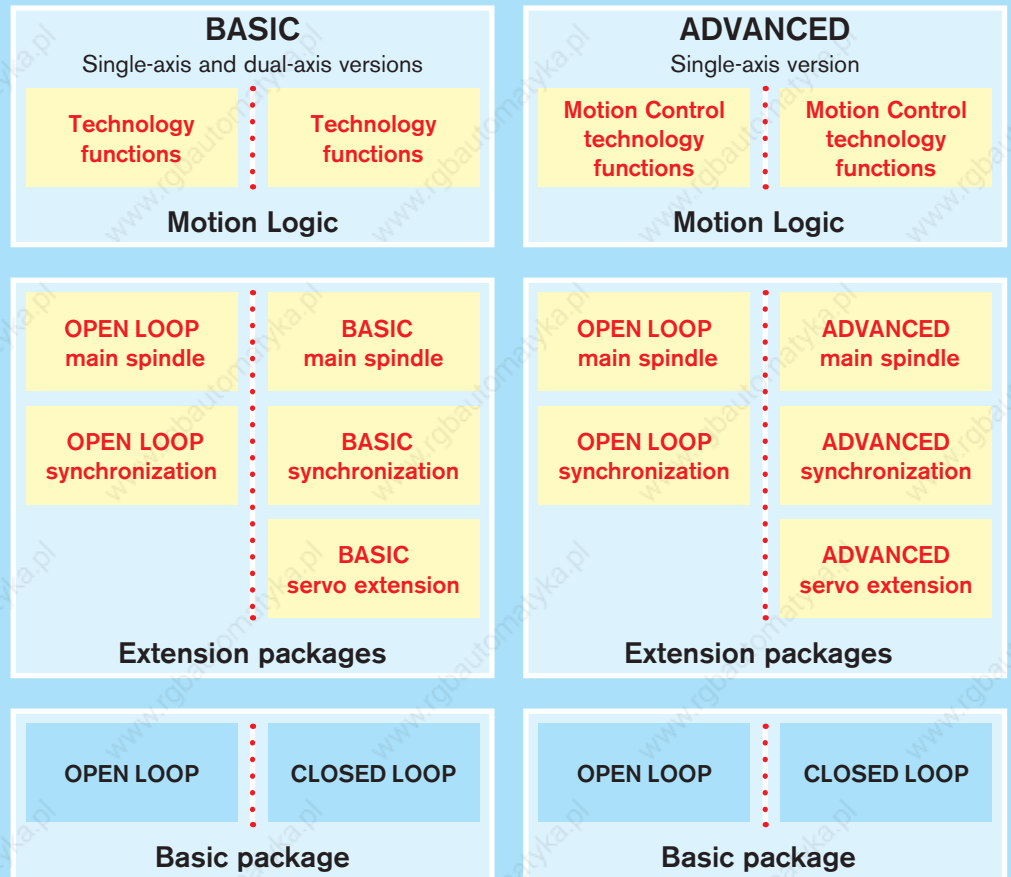

The simple step-by-step guide to ordering your IndraDrive firmware:

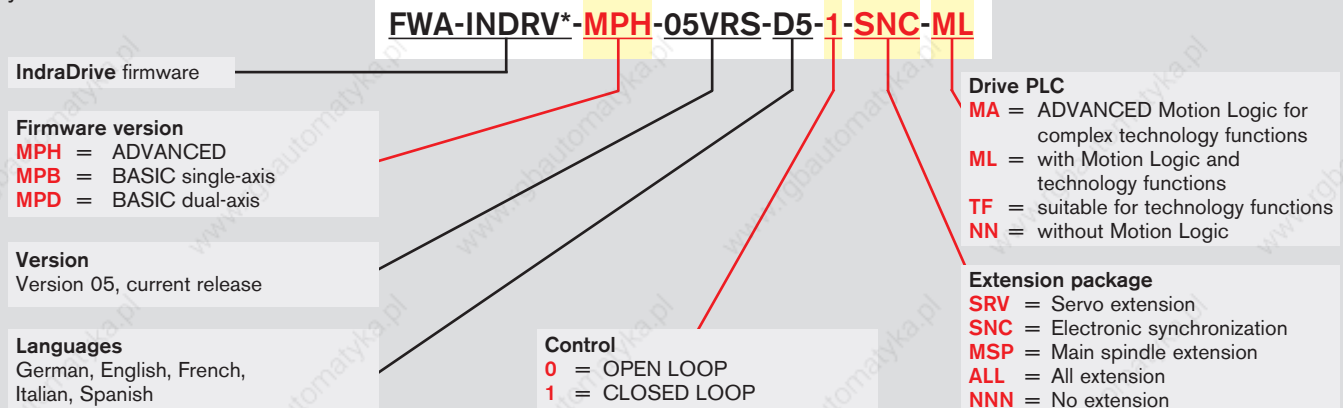



Customized functionality

- ! All standard functions already included in basic package
- ! Individual function extensions
- ! Industry-specific technology functions
- ! Integrated IEC-compliant Motion Logic

Your benefits

Basic package	BASIC		ADVANCED	
	OPEN LOOP	CLOSED LOOP	OPEN LOOP	CLOSED LOOP
Basic functions				
General motor with V/f-Curve, incl. slip compensation				
I x R compensation and stall protection				
Field-oriented control circuit adjustment				
Electronic type plate				
Automatic control circuit adjustment	●	●	●	●
Setpoint generator for control optimization				
Travel to fixed stop				
Adjustable error response				
Brake control				
Oscilloscope function				
Basic functions OPEN LOOP				
Speed ramp generator	●	●	●	●
Motorized potentiometer function				
Basic functions CLOSED LOOP				
Position, speed and torque control				
Drive-controlled referencing				
Drive-controlled positioning				
Interpolation inside drive				
Positioning block mode				
Position, speed and torque limit				
Automatic commutation adjustment	-	●	-	●
Travel to fixed stop				
Path switching point with ON and OFF switching threshold				
Encoder emulation, incremental or absolute (SSI format)				

Extension packages	BASIC		ADVANCED	
	OPEN LOOP	CLOSED LOOP	OPEN LOOP	CLOSED LOOP
Servo extension				
Easy compensation of backlash on reversal	-	●	-	●
Axis error correction	-	-	-	●
Quadrant error correction	-	-	-	●
Frictional torque compensation	-	●	-	●
Touch probe with fast stop	-	1	-	2
Dynamic cam group	-	●	-	●
Main spindle				
Parameter block changeover	●	●	●	●
Spindle positioning mode	-	●	-	●
Drive-controlled gear changes	-	-	-	●
Synchronization				
Speed synchronization	●	●	●	●
Angle synchronization	-	●	-	●
Measuring wheel mode	-	●	-	●
Real and virtual leading axis	●	●	●	●
Cam plate (tabular value)	-	●	-	●
Cam plate (analytical value)	-	-	-	●
Touch probe with time measurement	1	-	1	-
Touch probe with synchronization function	-	1	-	2
Dynamic cam group	-	●	-	●

Motion Logic	BASIC		ADVANCED	
	OPEN LOOP	CLOSED LOOP	OPEN LOOP	CLOSED LOOP
IndraMotion MLD				
Freely programmable in compliance with IEC 61131-3				
Programming system for IL, ST, FBD, LD, SFC and CFC				
4 user tasks (periodic, unsolicited or event-controlled)	● ¹⁾	● ¹⁾	●	●
Libraries: system-specific, drive-specific, PLCopen				
Support of customer libraries				
Process-oriented technology packages				

¹⁾ BASIC control units are restricted in terms of performance

Rexroth IndraMotion MLD – integrated Motion Logic

The world's first open drive

With IndraMotion MLD drive functions, motion control and processing logic merge to form a modern open automation platform for modular machine concepts. The drive-integrated Motion Logic reduces or even eliminates the need for higher-level control systems.

Open standards

Standardized programming languages and the integrated engineering framework IndraWorks simplify project planning, programming, operation and diagnostics. At the same time you are directly investing your valuable know-how in the drive and thereby safeguarding your competitive edge. Programming is in compliance with IEC 61131-3 in the following languages:

- Instruction list (IL)
- Structured text (ST)
- Functional block diagram (FBD)
- Ladder diagram (LD)
- Sequential function chart (SFC)
- Continuous function chart (CFC)

The availability of standardized modules in the PLCopen-compliant function library gives you access to a multitude of motion functions.

Flexible programming

With user-definable programming you have the freedom and flexibility to configure your application to your requirements. Indeed, you have the latitude to combine innovative drive functions, extensive function libraries and process-oriented technology packages into one perfect automation solution.

Achieve your goals faster

Even large-scale and complex applications can be handled with ease with our ready-to-use function blocks and predefined technology packages. Combine them to form your own user program or simply use them as configurable functions.

Examples of items:

- PLCopen modules
- Cam group
- Print-mark control
- Register control
- Tension control
- Loop control
- Winder
- Demand processing
- Extended drive functions:
 - Variable retraction motion
 - Adaptive feedrate control
 - Analog force control
 - and much more

Selected function blocks and technology packages for IndraMotion MLD are available on CD-ROM:

- Order number:
SWA-IM*MLD-LTE-02VRS-D0-CD650-COPY

Innovative modules for any application

- Functions library:
Collection of function blocks conforming to IEC or PLCopen
- User library:
Collection of function blocks developed by the user
- Technology packages:
Process-oriented function blocks, e.g. tension control
- User program:
Application-specific combination of different function blocks and technology packages

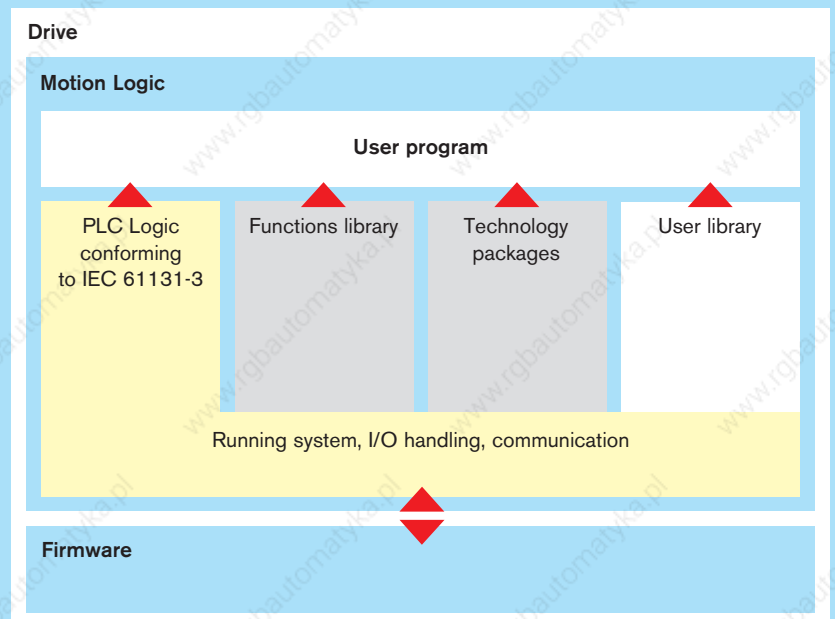

Drive and control system seamlessly coordinated

- Highly-economic solution for single-axis and multi-axis applications without additional hardware
- Minimized engineering thanks to IEC- and PLCopen-compliant configuration
- Predefined technology packages for faster implementation of system solution

Your benefits

Single-axis solution

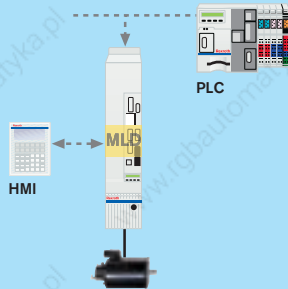

IndraMotion MLD-S
Integrated Motion Logic

Multi-axis solution

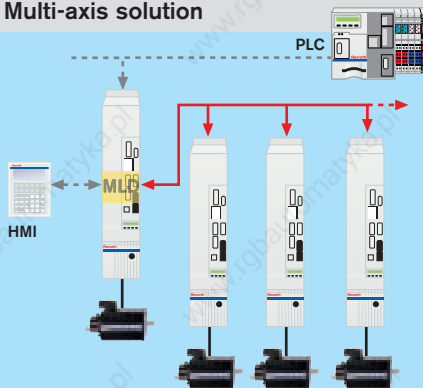

IndraMotion MLD-M
Integrated Motion Logic with cross communication

Achieve your goals faster with standards

The drive-based Motion Logic eliminates the need for higher-level control systems. Standardized programming languages and interfaces also help keep training and engineering costs to a minimum.

By employing ready-to-use function libraries and technology packages you can benefit from available know-how to further reduce engineering costs. You can contribute your own valuable know-how directly to the drive, thereby singling yourself out from your competitors.

IndraMotion MLD	MLD-S BASIC	MLD-S ADVANCED	MLD-M ADVANCED
Number of axes	1	1	up to 8
Hardware requirement (master)	BASIC control unit CSB	ADVANCED control unit CSH	ADVANCED control unit CSH with option CCD
Firmware option	TF	ML	ML
Performance			
	Depends on the utilization of the BASIC drive	100 µs per 1,000 instructions in IL using bit and word processing	
Tasks			
Number of tasks	4		
Types of tasks	Periodic, unsolicited or event-controlled		
Cycle times	ms	2	1
Program memory			
Firmware 03VRS	kB	192	
from firmware 04VRS	kB	approx. 350	
Retain data memory			
on control component	Byte	248	248
with option MD1 using firmware 03VRS	kB	-	32
with option MD1, MD2 or CCD using firmware 04VRS	kB	-	32
Programming			
Programming system	Rexroth IndraWorks MLD		
Programming languages	Instruction list (IL), Structured text (ST), Functional block diagram (FBD), Ladder diagram (LD), Ladder function (LDF), Sequential function chart (SFC), Continuous function chart (CFC)		
Programming interfaces	RS232 (Ethernet under development)		
Program debug functions	Breakpoint, single-step, single cycle, write/force, monitoring, sampling trace, simulation, online change		
Libraries supplied	System-specific, drive-specific and PLCopen		
Control communication			
	SERCOS interface, PROFIBUS, PROFINET IO, DeviceNet, CANopen, parallel interface, analog interface, analog/digital for OPEN LOOP mode, IndraMotion MLD		
Digital inputs and outputs			
Inputs	5 ¹⁾	7	Depends on the number and type of control units and option used
Inputs/outputs (user defined settings)	3 ¹⁾	4	
Option MD1	-	12 I/8 O	
Option MD2	-	16 I/16 O	
Parallel interface	16 I/16 O	16 I/16 O	
Analog inputs and outputs			
on control unit	-	1 I/2 O	Depends on the number and type of control units and option used
with option MA1	2 I/2 O	2 I/2 O	

¹⁾ applies to control unit CSB01.1C

Safety on Board – integrated safety technology

Whether for machine tools, printing and packaging or mounting, handling and robotics applications – protecting people from uncontrolled machine movements is top priority.

Clear guidelines issued by the EU

All machine manufacturers are obliged to carry out a hazard evaluation and risk analysis prior to construction. This is stipulated in the European Machinery Directive 98/37/EC. Moreover, any potential hazards detected must be eliminated step by step. Safety should be integrated in the machinery and meet current standards in technology.

How safe can you get?

IndraDrive is redefining current standards in technology because IndraDrive integrates the safety directly in the drive, resulting in ultra-short response times. IndraDrive therefore demonstrates the current capacities and requirements of safety technology – IndraDrive is faster because the movement is monitored directly where it is generated. This is the critical advantage, especially when it comes to monitoring direct drives or other high-dynamic drives, for example.

Quickest reaction time with highest drive dynamics

With the new IndraDrive generation from Rexroth, a variety of safety functions are available right inside the drive – without any detours through the control. This increases reliability, saves on additional monitoring components and reduces installation cost and effort.

It is all made possible by redundant software and hardware components in the drive. The non-contacting monitoring of all set limit values enables very short response times of less than 2 ms. As soon as a fault is detected, all the drives are automatically stopped depending on the stop category selected (0, 1 or 2).

Axis movements minimized thanks to ultra-short response times

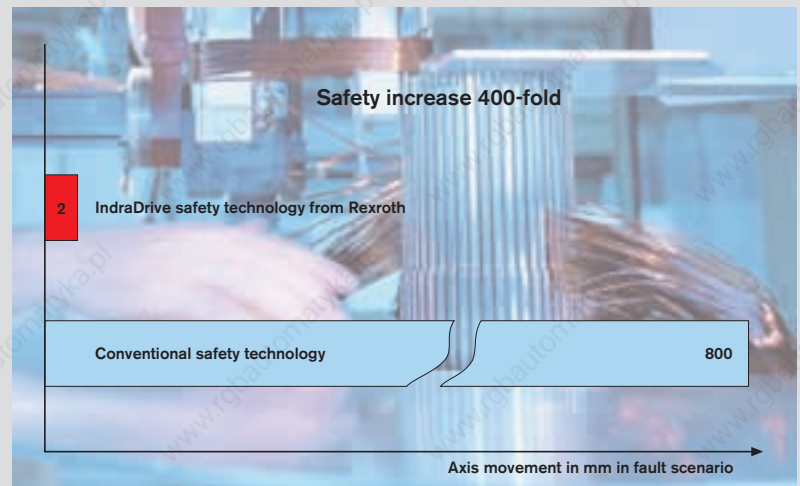

Before a user in the protected area reacts to an error with an acknowledgment linked to contacts, a linear axis with a ball screw has already traveled 100 to 200 mm, linear motors have

already traveled 400 to 800 mm. IndraDrive safety technology finds the error within 2 ms and the axis moves only 2 mm.

Safety functions inside the drive effectively protect people and machines

- High reliability due to certified integrated safety functions according to EN 954-1, Category 3
- Extremely fast reaction times (< 2 ms) for communication with internal monitors
- No need for additional measuring systems or sensors
- Online dynamic sampling of the inputs and shutoff paths while work is in progress
- PROFIsafe interface with reduced configuration and installation effort and safe, de-centralizes I/Os
- Reduced certification effort and short series start-up times



Our safety technology is verified by an accredited organization and certified as conforming to EN 954-1, Category 3.



Intelligent and safe

- | Safety category 3 certified as conforming to EN 954-1
- | Extensive safety functions
- | Minimum response times
- | Independent of the control system
- | Straightforward integration in the machine

Your benefits

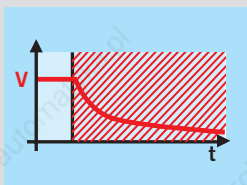

Safe start lockout

(Stop category 0 as per EN 60204-1)
Torque cut-off for drives; drives are safely disconnected from the power supply.

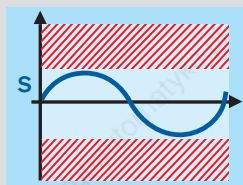

Safe absolute position range and safe software limit switches

In addition to the safely reduced speed and/or safe direction of rotation, it is also possible to select a safe absolute position range.

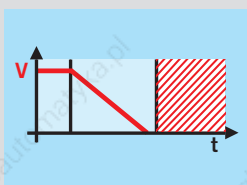

Safe stop

(Stop category 1 as per EN 60204-1)
Monitored shutdown – controlled by controller or drive, torque-free shutdown of drives, drives are safely disconnected from the power supply.

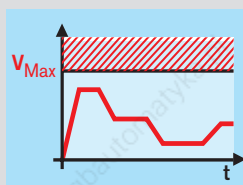

Safe maximum speed limit

The maximum speed is safely monitored regardless of the mode of operation.

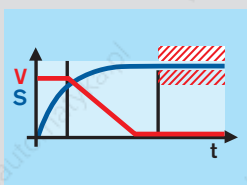

Safe operation stop

(Stop category 2 as per EN 60204-1)
Monitored shutdown – controlled by controller or drive. Shuts down the drives while maintaining all the control functions.

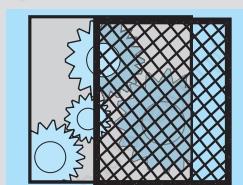

Safe guard door lock

When all the drives in one zone are in safe state, the guard door lock is released.

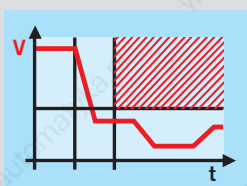

Safe speed reduction

When acknowledgement is given, a safely reduced speed can be used for travel in a special operating mode.

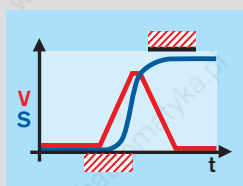

Safe increment limit

When acknowledgement is given, a safely limited increment can be used for travel in a special operating mode.

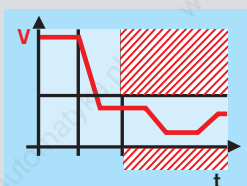

Safe direction of rotation

In addition to a safely reduced speed it is also possible to define a safe direction of rotation.

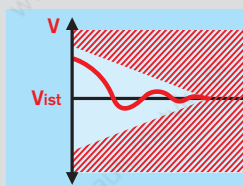

Safely monitored shutdown

This function can be parameterized with safely monitored shutdown time and safely monitored delay time on the basis of the actual velocity.

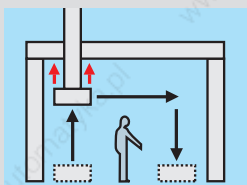

Safe brake and holding system

The safe brake and holding system is based on two independent brakes that are separately activated and monitored by the redundant, diverse channels in the drive.

Safety on Board – be on the safe side

Safe starting lockout

The starting lockout is the most cost-effective solution for preventing the drive from restarting unintentionally. The power supply is cut off electronically.

usually on two channels. The starting lockout is activated via two redundant 24 V signals.

This function can be selected with all control units except BASIC OPEN LOOP.

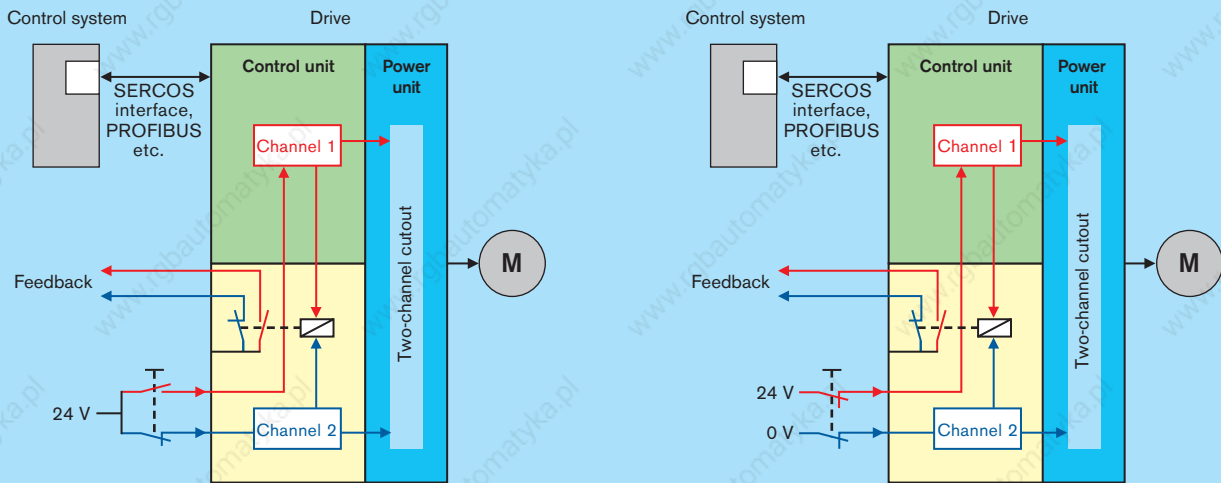

Starting lockout selected via NC/NO contacts or via two NC contacts

Safe stop and safe motion

The ADVANCED and BASIC UNIVERSAL dual-axis control units offer you all the available safety functions – including safe motion and safe absolute position.

This safety is guaranteed by two redundant, diverse processor systems which carry out all the relevant calculations separately and monitor each other.

The two-channel selection of the required safety function can be executed differently.

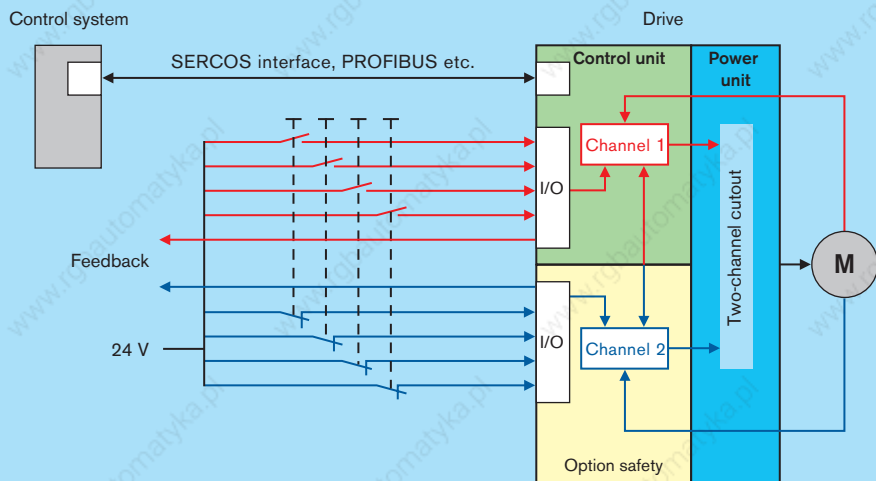

Selection and feedback via 24 V signals – the simplest way

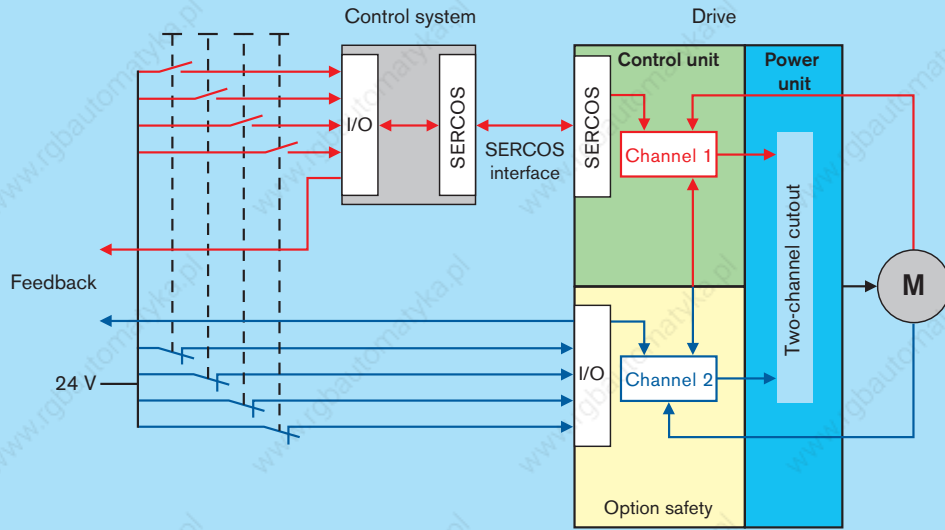

Selection and feedback signal via control communication (channel 1) and 24 V signals (channel 2) – for simpler wiring

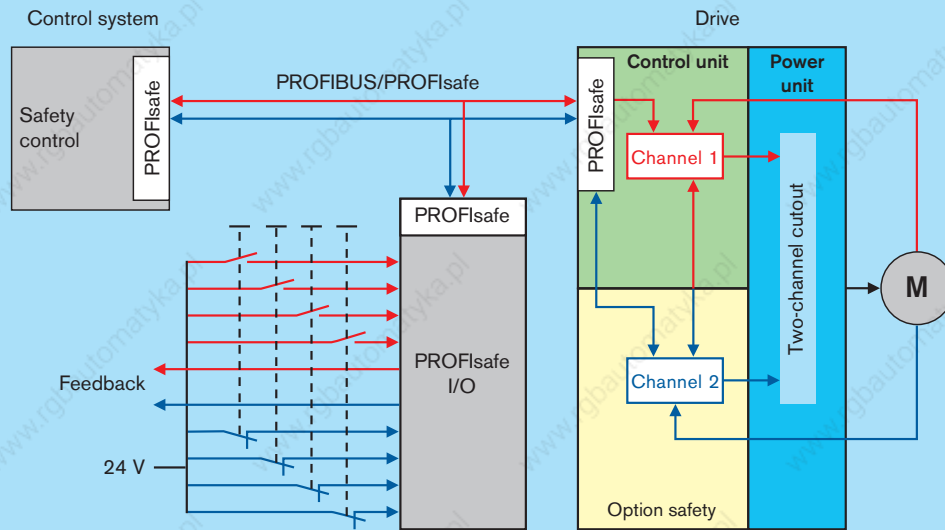

Selection and feedback signal via PROFIsafe – the user-friendly solution

Rexroth IndraWorks – a tool for all engineering tasks

Simple and user-friendly, Rexroth IndraWorks is the ideal engineering environment for all Rexroth electrical control and drive systems. This engineering framework brings together in one integrated interface all the tools required for:

- Configuration
- Programming
- Parameterization
- Operation
- Visualization
- Diagnostics

Advantages

- Integrated software framework for all engineering tasks
- Application-oriented tools
- Intelligent user guidance
- User-friendly, menu-driven operation
- Standardized programming according to IEC 61131-3
- PLCopen-compliant module library
- Open-architecture through integrated FDT/DTM technology
- Microsoft .NET technology

IndraWorks for IndraDrive can be supplied on CD-ROM

- IndraWorks D – for drive engineering:
SWA-IWORKS-D**-xxVRS-D0-CD650-COPY
- IndraWorks MLD – additionally supporting IndraLogic and IndraMotion MLD:
SWA-IWORKS-MLD**-xxVRS-D0-CD650-COPY

Cam editor CamBuilder for IndraWorks (as an option)

- SWA-IWORKS-CAM-xxVRS-D0

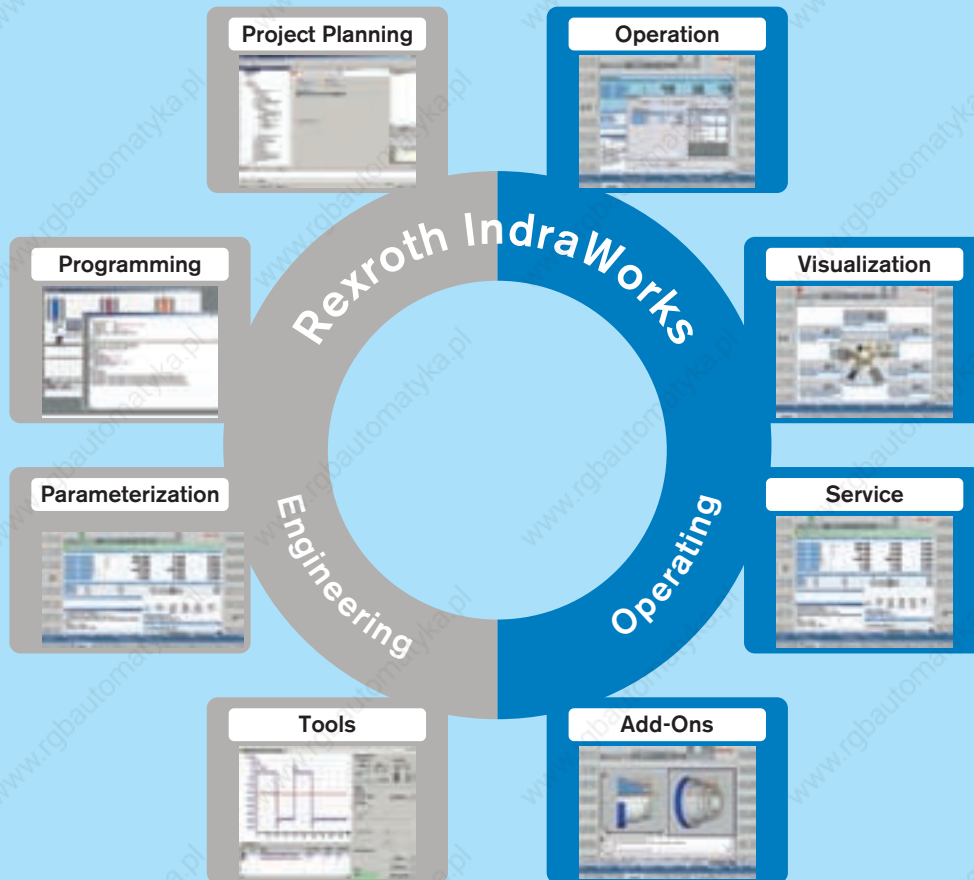

Rexroth IndraWorks – the integrated engineering framework for project planning, programming, parameterization, operation and monitoring

IndraWorks – the universal engineering framework

- ! One tool for all automation tasks
- ! Guided start-up for rapid achievement of results
- ! Offline configuration of projects
- ! User-friendly programming environment

Your benefits

Start-up wizard

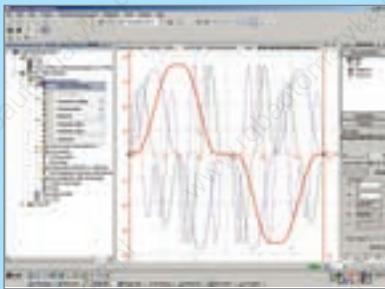

IndraWorks interactively guides you through all the steps of the startup process and only requires you to input the relevant data. All values to be input are directly related to the mechanics of the machine. This simplifies the input of data, along with allowing you to freely select measurement units.

You individually assemble the required sequence of movements from a large selection of positioning modes presented in graphic form. Once compiled, the set of parameters is saved in a file and can be easily transmitted to other machines via fieldbus or the RS232 serial interface.

Offline mode

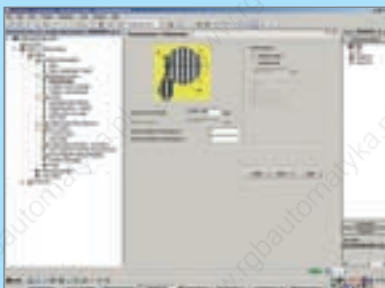

The machine-related modes of operation and the corresponding parameters can be set in advance offline and later transferred to the machine.

Programming



All functionality and programming modes according to IEC 61131-3 are available for the drive-integrated PLC.

With PLCopen function blocks, you can quickly and transparently integrate drive functionality into your PLC program.

Integrated technology functions

The configurable Motion Logic-based technology functions allow you to perform the full range of different process-oriented tasks – and require no programming skills.

Auto-tuning

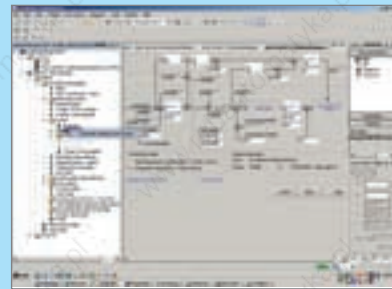

Parameters for all internal control functions are automatically set when IndraDyn motors are connected.

This setting is ideal for the majority of applications, requiring no further adjustment. Where requirements are more complex, the auto-tuning function is available to assist with adjusting the control settings to your machine.

Four-channel oscilloscope

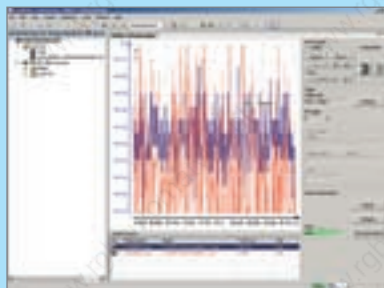

The integrated four-channel oscilloscope is available to assist with drive optimization, troubleshooting and preventive maintenance. For documentation purposes all the measurements and the related settings can be printed out or saved to a file.

CamBuilder (optional)

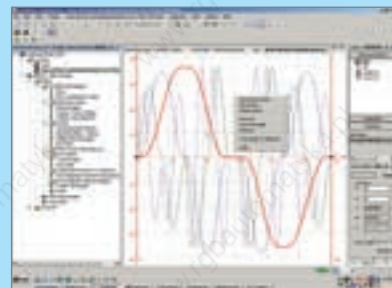

Rexroth CamBuilder is a graphics-based software tool for the convenient creation of electronic cams. With a few inputs, you can implement various applications easily and quickly. The established cams are directly transferable to Rexroth drives and controls.

Rexroth IndraSize – rapid and safe sizing

IndraSize – the user-friendly program for drive sizing – is the quickest way to finding the optimum drive for your machine. Regardless of whether you are using a conventional servo axis or direct drive, IndraSize allows you to define the ideal motor/drive combination in a few steps.

Mechanics

IndraSize is compatible with all standard drive mechanisms such as:

- Ball screw with rotating screw
- Ball screw with rotating nut
- Rack and pinion
- Belt drive
- Direct drive, linear
- Direct drive, rotary
- Roll feed
- Cross cutter

With the aid of graphics you simply simulate your machine kinematics, combining the motor and the selected mechanical parts with the various transfer units:

- Coupling
- Belt drive
- Gears

Any number of these can be combined in any order.



Motion profile

With IndraSize you can freely compile a full motion profile from individual sequences of movements. If applicable, you may use higher-order equations of motion as e. g. polynomials or sines. Alternatively, import ready-made cams generated with the CamBuilder.

Moreover, IndraSize allows you to define typical applications very simply by inputting parameters. Applications can be configured in next to no time, such as:

- Roll feeds
- Press feeders
- Flying cutoff
- Winders
- Cross cutters

Download

IndraSize can be downloaded from the Internet at www.boschrexroth.com/indrasize

Mechanical system



Ball screw with rotating screw



Ball screw with rotating nut



Belt drive



Gear rack and pinion



Direct drive, linear



Direct drive, rotary



Roller mechanics

and much more

Five steps to your drive solution

Regardless of whether you want to tackle a simple or complex drive task – whatever the case, IndraSize will lead you confidently through just five steps to success. Let the menu take you through the individual program steps from selecting the mechanical system and associated motion profile right through to the point where you are presented with the optimum motor/drive combination together with a table or curve showing its performance data.

1. Step:
Select mechanical system and motion profile



4. Step:
Select the drive from the filtered list generated



2. Step:
Input mechanical and link element data



5. Step:
Specify the presentation of results



3. Step:
Define the motion cycle



Rexroth IndraDyn – motors and gearboxes



Rexroth

A powerful family

- | Extensive range including robust housed and frameless (kit) motors
- | Coverage of entire power range
- | High-precision encoder systems
- | Highly-dynamic synchronous linear motors
- | Special hazardous duty designs conforming to ATEX or UL/CSA

Your benefits

IndraDyn S

Synchronous MSK servo motors for all requirements up to 448 Nm
Synchronous MKE servo motors with explosion-proof enclosure for potentially explosive atmospheres up to 190 Nm

IndraDyn A

Air-cooled asynchronous MAD servo motors with power ratings up to 100 kW
Liquid-cooled asynchronous MAF servo motors with power ratings up to 120 kW

IndraDyn L

Synchronous linear motors for feeding forces of up to 21,500 N

IndraDyn T

Synchronous torque motors with torque ratings up to 13,800 Nm and speeds of up to 4,000 rpm

IndraDyn H

High-speed frameless (kit) motors for speeds of up to 30,000 rpm and maximum torques of up to 4,500 Nm

1MB

Asynchronous frameless (kit) motors for speeds of up to 20,000 rpm and rated torques of up to 875 Nm

Servo gearbox

GTE servo planetary gears for standard applications
GTM servo planetary gears for high-performance applications

Standard and geared motors

Wide range of motors made by well-known manufacturers for combining with IndraDrive



IndraDyn S – MSK servo motors to meet all requirements

The particularly outstanding features of the MSK range of motors are its wide power spectrum and narrow size increments. The high torque density of these synchronous servo motors allows a particularly compact design with maximum torques of up to 448 Nm.

Depending on the level of precision required, we can supply the motors with encoder systems for standard or high-precision requirements. Both encoder versions are available in a single-turn and multi-turn configuration.

A number of further options, such as the shaft keyway, holding brake, reduced runout and the high protection category IP65 mean that they can be used in virtually any application.





Compact and powerful

- ▮ Maximum torques up to 448 Nm
- ▮ Maximum speeds up to 9,000 rpm
- ▮ Encoder systems for a wide and diverse range of applications
- ▮ High protection category IP65
- ▮ Choice of cooling systems

Your benefits

The simple step-by-step guide to ordering your MSK servo motor:

Option
MSK060C-0600-NN-S1-UG0-NNNN

Motor

- Size (e. g. "060")
- Overall length (e. g. "C")
- Winding (e. g. "0600")

Cooling system

NN = Natural convection

Surface cooling or (FN)
 Option of liquid cooling for certain sizes

Encoder

- S1** = Single-turn encoder (Hiperface) 128 increments
- M1** = Multi-turn encoder (Hiperface) 128 increments with 4096 revolutions absolute
- S2** = Single-turn encoder (EnDat) 2048 increments
- M2** = Multi-turn encoder (EnDat) 2048 increments with 4096 revolutions absolute

Shaft

- G** = Plain shaft with shaft sealing ring
- P** = Keyway conforming to DIN 6885-1 and shaft sealing ring

Other versions

- N** = Standard
 - S¹⁾** = Hazardous duty version conforming to Equipment Group II, Category 3, G and D
- ¹⁾ hazardous duty design available for certain sizes

Shaft runout

- N** = Standard, in conjunction with S1 or M1 encoder only
- R** = Reduced, linear movement conforming to DIN 42955, in conjunction with S2 or M2 encoder only

Holding brake

- 0** = without holding brake
- 1** = with electr. released holding brake

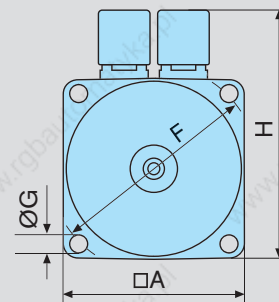
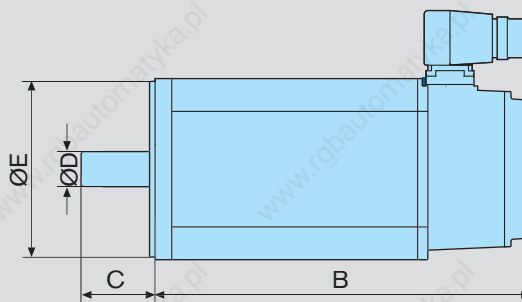
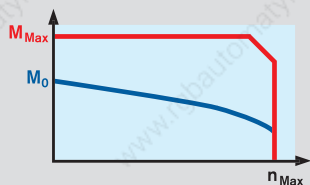

IndraDyn S – technical data

Motor		Maximum speed ¹⁾	Cont. torque at standstill	Maximum torque	Cont. current at standstill	Maximum current	Moment of inertia	Dimensions							Mass ²⁾	
		n _{Max} [rpm]	M ₀ [Nm]	M _{Max} [Nm]	I ₀ [A]	I _{Max} [A]	J _R [kgm ²]	A [mm]	B [mm]	C [mm]	Ø D [mm]	Ø E [mm]	Ø F [mm]	Ø G [mm]	H [mm]	m [kg]
MSK030	B-0900	9,000	0.4	1.8	1.5	6.8	0.000013	54	152.5	20	9	40	63	4.5	98.5	1.3/1.6
	C-0900	9,000	0.8	4.0	1.5	6.8	0.000030		188							1.9/2.1
MSK040	B-0450	6,500	1.7	5.1	1.5	6.0	0.000100	82	155.5	30	14	50	95	6.6	124.5	2.8/3.1
	B-0600	7,500			2.0	8.0										
	C-0450	6,500	2.7	8.1	2.4	9.6	0.000140		185.5							3.6/3.9
	C-0600	7,500			3.1	12.4										
MSK050	B-0300	4,300	3.0	9.0	1.8	7.2	0.000280	98	173	40	19	95	115	9	134.5	4.0/4.9
	B-0450	4,500			3.1	12.4										
	B-0600	6,000			3.7	14.8										
	C-0300	4,700	5.0	15.0	3.1	12.4	0.000330		203							5.4/6.3
	C-0450	6,000			4.7	18.8										
	C-0600	6,000			6.2	24.8										
MSK060	B-0300	4,800	5.0	15.0	3.0	12.0	0.000480	116	181	50	24	95	130	9	156	5.7/6.4
	B-0600	6,000			6.1	24.4										
	C-0300	4,900	8.0	24.0	4.8	19.2	0.000800		226							8.4/9.2
	C-0600	6,000			9.5	38.0										
MSK061	C-0200	3,000	8.0	32.0	3.1	14.0	0.000752	116	264	40	19	95	130	9	156	8.3/8.8
	C-0300	4,200			4.3	19.4										
	C-0600	6,000			7.7	34.7										
MSK070	C-0150	2,500	13.0	33.0	4.1	16.4	0.002910	140	238	58	32	130	165	11	202	11.7/13.2
	C-0300	5,500			8.2	32.8										
	C-0450	6,000			12.3	36.9										
	D-0150	2,700	17.5	52.5	6.2	24.8	0.003750		268							14.0/15.6
	D-0300	4,900			11.0	33.0										
	D-0450	6,000	23.0	60.0	16.6	49.8	0.004580		298							16.2/17.8
	E-0150	2,200			6.4	25.6										
	E-0300	5,300			15.4	46.3										
E-0450	6,000	19.3			57.9											
MSK071	C-0200	3,500	12.0	44.0	5.2	23.4	0.001730	140	272	58	32	130	165	11	202	13.9/15.8
	C-0300	5,000			7.3	32.9										
	C-0450	5,800			8.9	40.1										
	D-0200	3,200	17.5	66.0	7.3	32.8	0.002550		312							18.0/19.6
	D-0300	3,800			9.1	40.5										
	D-0450	6,000			15.4	69.3										
	E-0200	3,400	23.0	84.0	10.1	45.5	0.002900		352							23.5/25.1
	E-0300	4,200			12.5	56.3										
	E-0450	6,000			20.0	90.1										

Motor	Maximum speed ¹⁾	Cont. torque at standstill	Maximum torque	Cont. current at standstill	Maximum current	Moment of inertia	Dimensions								Mass ²⁾							
	n_{Max} [rpm]	M_0 [Nm]	M_{Max} [Nm]	I_0 [A]	I_{Max} [A]	J_R [kgm ²]	A [mm]	B [mm]	C [mm]	$\varnothing D$ [mm]	$\varnothing E$ [mm]	$\varnothing F$ [mm]	$\varnothing G$ [mm]	H [mm]	m [kg]							
MSK075	C-0200	4,000	12.0	44.0	5.9	26.4	0.003520	140	307	58	32	130	165	11	202	14.8/16.4						
	C-0300	4,500			8.2	36.9																
	C-0450	6,000			12.3	55.4																
	D-0200	4,000	17.0	66.0	8.1	36.6	0.004900		347							58	32	130	165	11	202	19.0/20.1
	D-0300	4,500			11.4	51.3																
	D-0450	6,000			16.1	72.5																
	E-0200	3,850	21.0	88.0	10.2	45.9	0.006130		387							58	32	130	165	11	202	22.5/23.6
	E-0300	5,200			14.2	63.9																
E-0450	6,000	18.4			82.7																	
MSK076	C-0300	4,700	12.0	43.5	7.2	32.4	0.004300	140	292.5	50	24	110	165	11	180	13.8/14.9						
	C-0450	5,000			12.2	54.9																
MSK100	A-0200	4,000	15.0	54.0	9.3	41.7	0.011000	192	302	60	32	130	215	11	211.5	23.0/24.1						
	A-0300	4,000			10.3	46.5																
	A-0450	4,500			12.1	54.4																
	B-0200	4,100	28.0	102.0	14.7	66.2	0.019200		368							60	32	130	215	11	211.5	34.0/36.0
	B-0300	4,750			17.4	78.3																
	B-0400	4,500			23.7	106.7																
	B-0450	4,500	38.0	148.0	28.5	110.7	0.027300		434							60	32	130	215	11	211.5	45.1/50.0
	C-0200	3,500			17.7	79.7																
	C-0300	4,500			21.6	97.2																
	C-0450	4,000	48.0	187.0	35.4	159.3	0.035000		502							60	32	130	215	11	211.5	56.0/59.5
D-0200	2,100	13.0			58.5																	
D-0300	3,000	20.7			93.2																	
MSK101	C-0200	4,000	32.0	110.0	15.3	69.3	0.006500	192	350	80	38	180	215	14	258	28.3/32.1						
	C-0300	4,500			18.7	84.2																
	C-0450	6,000			25.9	116.5																
	D-0200	3,400	50.0	160.0	22.2	99.9	0.009320		410							80	38	180	215	14	258	40.0/43.8
	D-0300	4,600			30.6	137.7																
	D-0450	6,000			41.7	187.7																
	E-0200	3,500	70.0	231.0	32.1	144.5	0.013800		501							80	38	180	215	14	258	53.5/57.3
	E-0300	4,600			41.6	187.4																
E-0450	6,000	58.3			262.4																	
MSK131	B-0200	3,400	85.0	220.0	36.7	165.0	0.023200	303	470	110	48	250	300	18	337	84.0/89.4						
	D-0200	3,000			62.5	281.4																

All the specifications relate to the basic version of the motor with encoder S1 and without holding brake

¹⁾ at 750 V DC bus voltage

²⁾ values without/with standard holding brake

IndraDyn S – MKE servo motors for potentially explosive areas

The MKE range of motors are specifically designed for use in production plants susceptible to explosive mixtures of air and flammable gases, vapors, mist or dust:

- Chemical industry
- Mining
- Printing shops
- Woodworking
- Paint shops
- Mills
- Food processing industry
- Refineries
- Tank farms
and much more

Within the broad range of torques up to a maximum of 190 Nm, there is a choice of various sizes of motor with flameproof enclosures. Needless to say, all are ATEX certified and/or UL/CSA compliant.

These motors can also be supplied with a range of options – holding brake, keyway and single- or multi-turn encoder systems.



The simple step-by-step guide to ordering your MKE servo motor:

Option
MKE037B-144-AGO-BENN

Motor

- Size (e. g. "037")
- Overall length (e. g. "B")
- Winding (e. g. "144")

Encoder

- A** = Single-turn encoder (Hiperface) 128 increments
- B¹⁾** = Single-turn encoder (EnDat) 2048 increments
- C** = Multi-turn encoder (Hiperface) 128 increments with 4096 revolutions absolute
- D¹⁾** = Multi-turn encoder (EnDat) 2048 increments with 4096 revolutions absolute

¹⁾ not applicable to MKE037 and MKE047

Shaft

- G** = Plain shaft with shaft sealing ring
- P** = Keyway conforming to DIN 6885-1 and shaft sealing ring

Cable entry

- 4** = Diameter 13 – 16 mm
- 6** = Diameter 17 – 19.5 mm
- N** = Conforming to American Standard (UL)

Housing design

- E²⁾** = Conforming to European standard (ATEX)
 - U** = Conforming to American standard (UL)
- ²⁾ version E only available with power connection option B

Power connection

- A** = on the A-Side
- B** = on the B-Side
- L** = Left
- R** = Right

Holding brake

- 0** = without holding brake
- 1** = with electr. released holding brake



Ultra-safe

- ! Maximum torques up to 190 Nm
- ! Maximum speeds up to 9,000 rpm
- ! Range of encoder systems
- ! Explosion-proof enclosure
- ! Compliance with ATEX and UL/CSA

Your benefits

Motor	Maximum speed	Cont. torque at standstill	Maximum torque	Cont. current at standstill	Maximum current	Moment of inertia	Dimensions								Mass ¹⁾	
							n_{Max} [rpm]	M_0 [Nm]	M_{Max} [Nm]	I_0 [A]	I_{Max} [kgm ²]	J_R [A]	A [mm]	B [mm]		C [mm]
MKE037	B-144	9,000	0.9	4.0	4.7	21.2	0.000030	60	283	20	9	40	70	4.5	123	2.5/2.8
MKE047	B-144	6,000	2.7	11.3	7.1	32.0	0.000170	88	287	30	14	50	100	6.6	146	5.5/5.8
MKE098	B-047	3,200	12.0	43.5	13.9	62.6	0.004300	144	383	50	24	110	165	11	202	18.0/19.1
	B-058	4,000		43.5	17.5	79.0										
	B-024	2,000	28.0	102.0	21.7	97.7	0.019400	194	492	60	32	130	215	14	-	44.0/45.1
	B-058	4,000			40.1	180.5										
MKE118	D-012	1,000	48.0	187.0	17.5	78.8	0.036200	194	664	60	32	130	215	14	-	65.0/69.1
	D-027	2,000			31.3	140.9										
	D-035	3,000			42.2	190.0										

¹⁾ values without/with standard holding brake

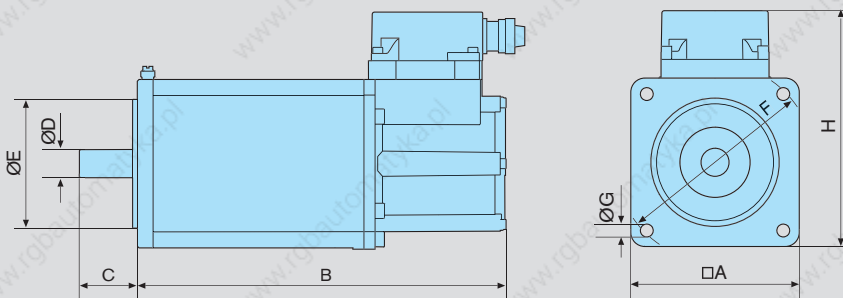
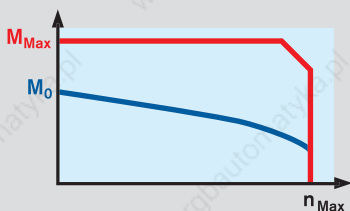

Internationally recognized certification

MKE motors have been certified by the German metrology institute providing scientific and technical services, the PTB Braunschweig, in accordance with Directive 94/9/EC – ATEX95 (PTB 03 ATEX 1108 X Ex II 2 G/D EEx d IIB T4 IP6X T 135 °C).

The certificates are recognized by all member states of the European Union as well as non-European members of the CENELEC.

MKE motors based on the American standard (UL/CSA) conforming to Class I, Groups C and D as per UL508C, UL674 and UL1446, have been certified directly by Underwriters Laboratories Inc. (UL) in the USA.



MKE as per ATEX – terminal box with EExd cable connectors



MKE as per UL/CSA – terminal box with lines for conduit installation

IndraDyn A – MAD asynchronous servo motors for high performance

With their phenomenal power density, the MAD range of motors is predestined for servo and main spindle applications, such as in machine tools, printing presses or metal forming technology.

High-resolution single-turn or multi-turn encoder systems and outstanding true running quality guarantee highest

handling precision. In addition to the optional keyway and holding brake, these motors can also be supplied with a special bearing assembly for high-speed applications or for applications with increased radial load.

The motor protection category IP65 even includes the fan motor, making it suitable for harsh industrial use.

The easy-maintenance design of the motor means that it is even possible to exchange the fan while the motor is running – particularly advantageous in the printing industry.





Robust and easy-maintenance

- ▮ Rated outputs of up to 100 kW
- ▮ Maximum speeds up to 11,000 rpm
- ▮ Encoder systems for a wide and diverse range of applications
- ▮ High protection category IP65, including fan motor
- ▮ Easy-maintenance motor design

Your benefits

The simple step-by-step guide to ordering your MAD asynchronous servo motor:

Option
MAD100C-0100-SA-S2-AH0-05-N1

Motor

- Size (e. g. "100")
- Overall length (e. g. "C")
- Winding (e. g. "0100")

Cooling system

- SA** = Axial-flow fan
- SL** = Fan cowl

Encoder

- S2** = Single-turn encoder (EnDat) 2048 increments
- M2** = Multi-turn encoder (EnDat) 2048 increments with 4096 revolutions absolute
- S6¹⁾** = Single-turn encoder (EnDat) 2048 increments for potentially explosive atmospheres
- M6¹⁾** = Multi-turn encoder (EnDat) 2048 increments and 4096 revolutions, for potentially explosive atmospheres
- C0** = Incremental encoder 2048 increments

¹⁾ equipment group II 2G, type of protection EEx p d IIB T3 only in combination with cooling option SL

Line terminal

- A** = Plug for A side
- B** = Plug for B side
- L** = Plug left
- R** = Plug right
- F** = Terminal box for A side
- K** = Terminal box for B side
- T** = Terminal box left
- S** = Terminal box right

Shaft

- G** = Plain shaft with sealing ring
- H** = Plain shaft without sealing ring
- P** = with keyway and sealing ring
- Q** = with keyway but without sealing ring

Vibration severity grade

- 1** = A
- 3** = B

Bearing assembly

- N** = Standard
 - H²⁾** = High speed
 - V²⁾** = Heavy duty
- ²⁾ only for certain sizes

Construction

- 05** = Flange-mounted
- 35** = Flange-mounted or foot-mounted

Holding brake

- 0** = without holding brake
 - 1** = with electr. released holding brake
 - 3³⁾** = with electr. released holding brake, heavy duty
 - 5** = with electr. clamped holding brake
- ³⁾ only for certain sizes

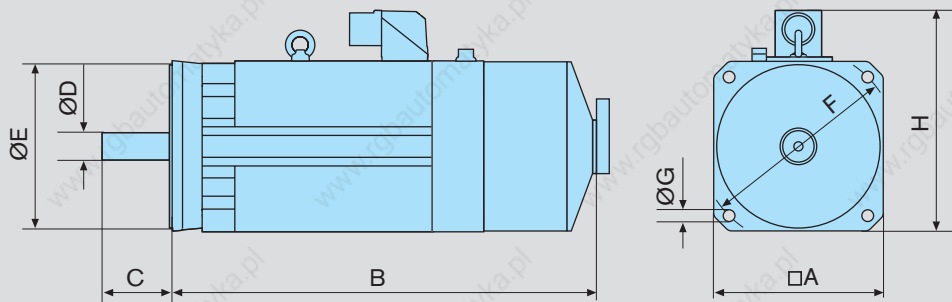
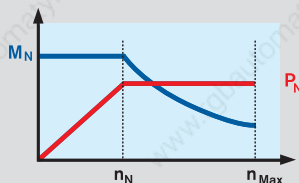

IndraDyn A – technical data

Motor	Rated speed	Maximum speed	Rated torque	Maximum torque	Rated power	Rated current	Moment of inertia	Dimensions							Mass ²⁾		
	n _N [rpm]	n _{Max} [rpm]	M _N [Nm]	M _{Max} [Nm]	P _N [kW]	I _N [A]	J _R [kgm ²]	A [mm]	B [mm]	C [mm]	Ø D [mm]	Ø E [mm]	Ø F [mm]	Ø G [mm]	H ¹⁾ [mm]	m [kg]	
MAD100	B-0050	500	3,000	34	75.1	1.8	5.3	0.0190	192	462	60	32	130	215	14	277 (264)	43
	B-0100	1,000	6,000	31	74.7	3.2	8.9										
	B-0150	1,500	9,000	30	68.0	4.7	12.9										
	B-0200	2,000	11,000	28	66.2	5.9	14.6										
	B-0250	2,500	11,000	25	61.5	6.5	16.2										
	C-0050	500	3,000	51	112.3	2.7	8.2	0.0284	192	537	60	32	130	215	14	277 (264)	59
	C-0100	1,000	6,000	50	118.8	5.2	13.2										
	C-0150	1,500	9,000	48	110.4	7.5	19.7										
	C-0200	2,000	11,000	45	105.5	9.4	25.7										
	C-0250	2,500	11,000	40	91.0	10.5	27.8										
	D-0050	500	3,000	70	153.6	3.7	10.1	0.0392	192	537	60	32	130	215	14	277 (264)	72
	D-0100	1,000	6,000	64	146.5	6.7	19.3										
D-0150	1,500	9,000	59	140.8	9.3	25.6											
D-0200	2,000	11,000	54	129.8	11.3	27.2											
D-0250	2,500	11,000	50	118.7	13.1	32.4											
MAD130	B-0050	500	3,000	95	208.8	5.0	12.8	0.0840	260	570	110	42	250	300	18	345 (340)	100
	B-0100	1,000	6,000	100	230.0	10.5	26.9										
	B-0150	1,500	9,000	85	200.0	13.4	34.9										
	B-0200	2,000	10,000	80	187.2	16.8	43.0										
	B-0250	2,500	10,000	75	176.5	19.6	47.2										
	C-0050	500	3,000	140	307.9	7.3	19.7	0.1080	260	640	110	42	250	300	18	345 (340)	122
	C-0100	1,000	6,000	125	305.0	13.1	36.2										
	C-0150	1,500	9,000	117	275.2	18.4	48.9										
	C-0200	2,000	10,000	110	252.9	23.0	57.0										
	C-0250	2,500	10,000	100	250.0	26.2	62.0										
	D-0050	500	3,000	180	395.6	9.4	24.2	0.1640	260	640	110	42	250	300	18	345 (340)	165
	D-0100	1,000	6,000	170	417.8	17.8	43.7										
D-0150	1,500	9,000	155	374.6	24.3	61.5											
D-0200	2,000	10,000	150	340.7	31.4	71.3											
D-0250	2,500	10,000	120	310.0	31.4	72.0											

Motor	Rated speed	Maximum speed	Rated torque	Maximum torque	Rated power	Rated current	Moment of inertia	Dimensions								Mass ²⁾						
	n _N [rpm]	n _{Max} [rpm]	M _N [Nm]	M _{Max} [Nm]	P _N [kW]	I _N [A]	J _R [kgm ²]	A [mm]	B [mm]	C [mm]	Ø D [mm]	Ø E [mm]	Ø F [mm]	Ø G [mm]	H ¹⁾ [mm]	m [kg]						
MAD160	B-0050	500	3,000	220	483.9	11.5	0.2500	316	748	110	55	300	350	18	422 (395)	201						
	B-0100	1,000	6,000	200	460.9	20.9											43.5					
	B-0150	1,500	6,000	190	440.1	29.9											61.6					
	B-0200	2,000	6,000	160	375.3	33.5											75.8					
	C-0050	500	3,000	240	528.2	12.6	27.6		0.3110						838	140	60	300	350	18	469	238
	C-0100	1,000	6,000	225	530.0	23.6	52.9															
	C-0150	1,500	6,000	215	496.0	33.8	75.3															
C-0200	2,000	6,000	210	494.2	44.0	93.9	0.4580	320	1,089	140	60	300	350	18	469						334	
C-0050	500	3,000	325	715.5	17.0	38.2																
C-0100	1,000	6,000	300	620.0	31.4	69.0																
C-0150	1,500	6,000	270	681.0	42.4	88.6																
C-0200	2,000	6,000	250	594.4	52.4	104.6		0.5940							1,089	75	350	400	583	610		
D-0050	500	3,000	390	857.8	20.4	39.7																
D-0100	1,000	6,000	370	901.5	38.7	82.4																
D-0150	1,500	6,000	340	794.0	53.4	107.4	1.6500	434	1,240	75	350	400	583	610								
D-0200	2,000	6,000	300	768.2	62.8	117.4																
C-0050	500	3,000	660	1,450.0	34.6	72.0																
MAD225	C-0100	1,000	3,750	640	1,450.0	67.0	121.0	434	1,240	75	350	400	583	610								
	C-0150	1,500	3,750	593	1,450.0	93.1	174.0															

All the specifications given relate to the basic version of the motor without a holding brake. The maximum speed depends on the bearing version.

¹⁾ motor height H for version with terminal box, the values in parentheses apply for power connection with plug ²⁾ values without holding brake with fan

IndraDyn A – MAF asynchronous servo motors with liquid cooling

The liquid-cooled motors in the MAF series are particularly suitable for applications demanding maximum torques in minimum amounts of space. At the same time the unique cooling

system design ensures the thermal isolation of motor and machine and therefore maximum handling precision. The quick couplings with integrated leak-proofing simplify your maintenance work.

Options such as holding brakes, different encoder systems, vibration severity grades and shaft specifications allow you to tailor the MAF motors optimally to your specific application.





Compact and powerful

- ▮ Rated outputs of up to 120 kW
- ▮ Maximum speeds up to 11,000 rpm
- ▮ Encoder systems for a wide and diverse range of applications
- ▮ High protection category IP65
- ▮ Liquid cooling with quick coupling

Your benefits

The simple step-by-step guide to ordering your MAF asynchronous servo motor:

Option
MAF100C-0100-FQ-S2-AH0-05-N1

Motor

- Size (e. g. "100")
- Overall length (e. g. "C")
- Winding (e. g. "0100")

Cooling system connection

- FQ** = Connection thread
- FR** = Quick coupling (comprised in the delivery)

Encoder

- S2** = Single-turn encoder (EnDat) 2048 increments
- M2** = Multi-turn encoder (EnDat) 2048 increments with 4096 revolutions absolute
- S6**¹⁾ = Single-turn encoder (EnDat) 2048 increments for potentially explosive atmospheres
- M6**¹⁾ = Multi-turn encoder (EnDat) 2048 increments and 4096 revolutions, for potentially explosive atmospheres
- C0** = Incremental encoder 2048 increments

¹⁾ equipment group II 2G, type of protection EEx p d IIB T3 only in combination with cooling option SL

Vibration severity grade

- 1** = A
- 3** = B

Bearing assembly

- N** = Standard
 - H**²⁾ = High speed
 - V**²⁾ = Heavy duty
- ²⁾ only for certain sizes

Construction

- 05** = Flange-mounted
- 35** = Flange-mounted or foot-mounted

Line terminal

- A** = Plug for A side
- B** = Plug for B side
- L** = Plug left
- R** = Plug right
- F** = Terminal box for A side
- K** = Terminal box for B side
- T** = Terminal box left
- S** = Terminal box right

Shaft

- G** = Plain shaft with sealing ring
- H** = Plain shaft without sealing ring
- P** = with keyway and sealing ring
- Q** = with keyway but without sealing ring

Holding brake

- 0** = without holding brake
 - 1** = with electr. released holding brake
 - 3**³⁾ = with electr. released holding brake, heavy duty
 - 5** = with electr. clamped holding brake
- ³⁾ only for certain sizes

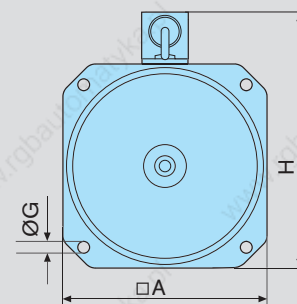
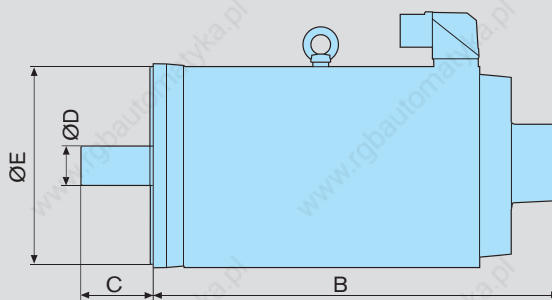
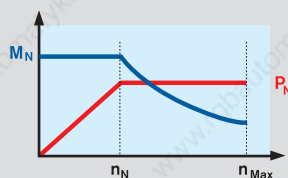

IndraDyn A – technical data

Motor	Rated speed	Maximum speed	Rated torque	Maximum torque	Rated power	Rated current	Moment of inertia	Dimensions							Mass ³⁾	
	n_N [rpm]	n_{Max} [rpm]	M_N [Nm]	M_{Max} [Nm]	P_N [kW]	I_N [A]	J_R [kgm ²]	A [mm]	B [mm]	C [mm]	Ø D [mm]	Ø E [mm]	Ø F [mm]	Ø G [mm]	H ¹⁾ [mm]	m [kg]
MAF100	B-0050	500	3,000	50	109.7	2.6	8.5	192	382	60	38	130	215	14	277 (264)	38
	B-0100	1,000	6,000	46	110.0	4.8	15.2									
	B-0150	1,500	9,000	42	101.4	6.6	18.1									
	B-0200	2,000	11,000	38	92.4	8.0	23.9									
	B-0250	2,500	11,000	33	83.6	8.6	26.0									
	C-0050	500	3,000	70	153.7	3.9	12.1									
	C-0100	1,000	6,000	68	154.0	7.5	19.0	0.0284	457	60	38	130	215	14	277 (264)	52
	C-0150	1,500	9,000	66	149.5	10.4	27.9									
	C-0200	2,000	11,000	64	145.2	13.4	36.7									
	C-0250	2,500	11,000	62	138.1	16.2	40.2									
	D-0050	500	3,000	88	193.3	4.6	14.5									
	D-0100	1,000	6,000	84	190.0	8.8	27.1									
D-0150	1,500	9,000	79	185.3	12.4	32.7	0.0320	532	60	38	130	215	14	277 (264)	64	
D-0200	2,000	11,000	80	182.3	16.8	43.1										
D-0250	2,500	11,000	75	177.5	19.6	45.8										
B-0050	500	3,000	116	254.7	6.1	14.7										
B-0100	1,000	6,000	112	254.7	11.7	28.4	0.0790	260	110	42	250	300	18	345 (340)	81	
B-0150	1,500	9,000	115	264.0	18.1	43.7										
B-0200	2,000	10,000	100	220.0	20.9	52.7										
B-0250	2,500	10,000	90	210.0	23.6	55.5										
C-0050	500	3,000	155	340.0	8.1	21.0										
C-0100	1,000	6,000	150	330.0	15.7	38.0										
C-0150	1,500	9,000	145	329.8	22.8	53.2	0.1010	478	110	42	250	300	18	345 (340)	106	
C-0200	2,000	10,000	135	314.7	28.3	69.8										
C-0250	2,500	10,000	125	298.4	32.7	75.5										
D-0050	500	3,000	230	506.3	12.0	32.3	0.1510	608	110	42	250	300	18	345 (340)	147	
D-0100	1,000	6,000	220	500.0	23.0	50.7										
D-0150	1,500	9,000	200	484.4	31.4	72.6										
D-0200	2,000	10,000	200	461.4	41.9	93.9										
D-0250	2,500	10,000	190	432.1	49.7	113.0										

Motor	Rated speed	Maximum speed	Rated torque	Maximum torque	Rated power	Rated current	Moment of inertia	Dimensions								Mass ³⁾	
	n _N [rpm]	n _{Max} [rpm]	M _N [Nm]	M _{Max} [Nm]	P _N [kW]	I _N [A]	J _R [kgm ²]	A [mm]	B [mm]	C [mm]	Ø D [mm]	Ø E [mm]	Ø F [mm]	Ø G [mm]	H ¹⁾ [mm]	m [kg]	
MAF160	B-0050	500	3,000	270	594.5	14.1	34.3	0.2300	316	618	110	60	300	350	18	422 (395)	197
	B-0100	1,000	6,000	260	592.7	27.2	73.7										
	B-0150	1,500	6,000	250	570.8	39.3	89.5										
	B-0200	2,000	6,000	240	550.1	50.3	108.5										
	C-0050	500	3,000	340	747.8	17.8	47.4	0.2600	708							227	
	C-0100	1,000	6,000	325	746.4	34.0	91.2										
	C-0150	1,500	6,000	300	681.4	47.1	109.5										
	C-0200	2,000	6,000	285	677.4	59.7	136.0										
MAF180	C-0050	500	3,000	435	986.2	22.8	50.0	0.4900	320 ²⁾	792		60	300	350		469	322
	C-0100	1,000	6,000	400	957.0	41.9	93.9										
	C-0150	1,500	6,000	365	858.1	57.3	128.8										
	C-0200	2,000	6,000	318	739.2	66.6	154.0										
	D-0050	500	3,000	500	1,100.2	26.2	60.4	0.6100	902	140				18		382	
	D-0100	1,000	6,000	460	1,094.5	48.2	94.8										
	D-0150	1,500	6,000	435	1,013.0	68.3	146.1										
	D-0200	2,000	6,000	400	1,008.0	83.8	168.5										
MAF225	C-0050	500	3,000	860	1,750.0	45.0	98.0	1.6500	434 ²⁾	932		75	350	400		583	587
	C-0100	1,000	3,750	820	1,750.0	85.9	170.0										
	C-0150	1,500	3,750	764	1,750.0	120.0	215.0										

All the specifications given relate to the basic version of the motor without a holding brake. The maximum speed depends on the bearing version.

¹⁾ motor height H for version with terminal box, the values in parentheses apply for power connection with plug ²⁾ housing size > flange size A ³⁾ values without holding brake

IndraDyn L – linear motors for maximum dynamics

Compact construction, high dynamics and maximum forces of up to 21,500 N – these are the challenges to which our IndraDyn L synchronous linear motors are admirably equipped to meet. Given their exceptionally low force ripple, these motors are particularly suitable for applications with maximum demands in terms of acceleration and accuracy.

There is a choice of sizes geared to typical requirements supplied in standard encapsulation or thermal encapsulation for maximum temperature stability.

The combination of several linear motors – whether in series or parallel – gives rise to completely new machine concepts with greatly enhanced machining force.



The simple step-by-step guide to ordering your IndraDyn L synchronous linear motor:

Primary part

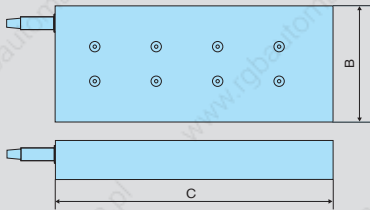

MLP140C-0170-FS-N0CN-NNNN

Option

Enclosure

- S** = Standard encapsulation
- T** = Thermal encapsulation

Motor (primary part)

- Size (e. g. "140")
- Overall length (e. g. "C")
- Winding (e. g. "0170")

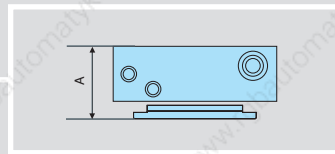

Secondary part

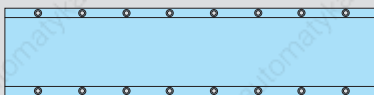

MLS140S-3A-0150-NNNN

Option

Segment length

- 0150** = 150 mm
- 0450** = 450 mm
- 0600** = 600 mm

Motor (Secondary part)

- Size (e. g. "140")

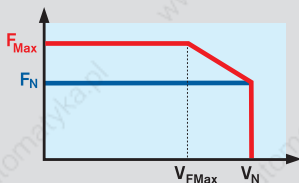



High dynamics and precision

- ! Maximum force of up to 21,500 N
- ! Maximum velocity up to 600 m/min
- ! Compact design
- ! Low force ripple
- ! Heat dissipation minimized by thermal encapsulation

Your benefits

Motor	Continuous nominal force	Maximum force	Nominal velocity	Maximum velocity with F _{Max}	Cont. nominal current	Maximum current	Standard encapsulation				Thermal encapsulation													
							Total installation height	Primary part width	Primary part length	Primary part mass	Total installation height	Primary part width	Primary part length	Primary part mass										
							A [mm]	B [mm]	C [mm]	m _P [kg]	A [mm]	B [mm]	C [mm]	m _P [kg]										
	F _N [N]	F _{Max} [N]	V _N [m/min]	V _{F Max} [m/min]	I ₀ [A]	I _{Max} [A]																		
MLP040	A-0300	250	800	500	300	4.2	61.4	100	210	4.7	73.9	108	235	6.1										
	B-0150			300	150	4.2									20									
	B-0250	370	1,150	400	250	5.3			27	285			6.1	310	8.1									
	B-0300			500	300	6.0			35															
MLP070	A-0150	550	2,000	200	150	5.5		61.4	130	285		8.4	73.9	138	310	10.9								
	A-0220			360	220	6.3											42							
	A-0300			450	300	10.5											55							
	B-0100			200	100	5.5											28							
	B-0120	820	2,600	220	120	5.8				42		360		10.4	510	14.5	138	385	13.4					
	B-0150			260	150	6.2				48														
	B-0250			400	250	10.0				55														
	B-0300			450	300	12.0				70														
	C-0120	1,200	3,800	180	120	8.9	55			510	14.5	535		18.4	138	535	18.4							
	C-0150			250	150	11.7	70																	
	C-0240			350	240	13.0	90																	
	C-0300			450	300	19.0	110																	
MLP100	A-0090	1,180	3,750	150	90	6.6	61.4	160	360	13.5	73.9	168	385	17.0										
	A-0120			190	120	8.0									44									
	A-0150			220	150	10.0									55									
	A-0190			290	190	12.0									70									
	B-0120	1,785	5,600	190	120	12.0			70	510			18.7	660	24	168	535	23.3						
	B-0250			350	250	22.0			130															
	C-0090			170	90	13.0			90															
	C-0120			190	120	15.0			85															
C-0190	2,310	7,150	290	190	23.0	140	660	24	685	29.7	168	685	29.7											
A-0120			1,680	5,200	190	120								12.0	70		360	17	385	21.2				
B-0090			2,415	7,650	160	90								15.0	85						510	24.5	535	30.1
B-0120					190	120								18.0	105									
C-0050	3,150	10,000			110	50	13.0	70	660	32		685	38.9											
C-0120					190	120	21.0	125																
C-0170			250	170	29.0	140																		
C-0350			400	350	53.0	260																		
MLP140	A-0090	2,415	7,450	170	90	13.0	61.4	200	360	23	73.9	268	385	28.3										
	A-0120			190	120	16.0									88									
	B-0040	3,465	10,900	100	40	13.0			70	510			33	660	42	268	535	40.0						
	B-0120			190	120	22.0			130															
	C-0090			170	90	23.3			120															
	C-0120			190	120	30.0			175															
	C-0170	4,460	14,250	220	170	46.0			210	810			51	835	61.3		268	685	50.7					
	D-0060			140	60	28.0			140															
	D-0100			180	100	46.0			210															
	D-0120			190	120	53.0			225															
MLP200	A-0090	2,415	7,450	170	90	13.0	61.4	200	360	23	73.9	268	385	28.3										
	A-0120			190	120	16.0									88									
	B-0040	3,465	10,900	100	40	13.0			70	510			33	660	42	268		535	40.0					
	B-0120			190	120	22.0			130															
	C-0090			170	90	23.3			120															
	C-0120			190	120	30.0			175															
	C-0170	4,460	14,250	220	170	46.0			210	810			51	835	61.3		268	685	50.7					
D-0060	140			60	28.0	140																		
D-0100	180			100	46.0	210																		
D-0120	190	120	53.0	225																				
MLP300	A-0090	3,350	11,000	160	90	19.0	110	-	-	-	-	77.9	368	385	40.8									
	A-0120			190	120	23.0	138																	
	B-0070	5,150	16,300	140	70	28.0	140							-	-	-		-	77.9	368	535	58.3		
	B-0120			190	120	35.0	205																	
	C-0060			110	60	29.0	140																	
	C-0090	6,720	21,500	150	90	37.0	212							-	-	-	-	77.9		368	685	74.9		
	C-0120			180	120	52.3	222																	

All the specifications given are based on operation with liquid cooling and 540 V DC bus voltage.

IndraDyn T – frameless (kit) torque motors

The IndraDyn T torque motors are liquid-cooled kit motors which have been optimized for high torques of up to 13,800 Nm. They consist of a stator with three-phase winding and a rotor with permanent magnets.

Typical areas of application for these motors mainly include direct drives in rotary tables or swivel axes in machining centers. However, they also offer innovative new approaches to solutions in mechanical engineering applications using robots, plastics processing machines, woodworking machines, lathes and special purpose machines.

We can supply the motors with an optional preassembled assembly aid for quick and easy installation.



The simple step-by-step guide to ordering your IndraDyn T torque motor:

Stator

MST^{Option}**530B-0070-FT-N0****CN**-NNNN

Motor (Stator)

- Size (e. g. "530")
- Overall length (e. g. "B")
- Winding (e. g. "0070")

Electrical connection

- CN** = Axial on side with larger Ø
- SN** = Axial on side with smaller Ø
- RN** = Radial on side with larger Ø

Rotor

MRT^{Option}**530B-3A-0410**-NNNN

Motor (Rotor)

- Size (e. g. "530")
- Overall length (e. g. "B")

Internal diameter of rotor

The rotors can be supplied with different internal diameters.



Powerful and direct

- ▮ Maximum torques of up to 13,800 Nm
- ▮ Full torque even at standstill
- ▮ Extremely high overload capacity
- ▮ Liquid cooling with thermal encapsulation
- ▮ Easy to assemble

Your benefits

Motor		Rated torque	Maximum torque	Speed at M_{Max}	Rated speed	Rated current	Maximum current	Rotor ¹⁾ Moment of inertia	Dimensions			Mass ²⁾
		M_N [Nm]	M_{Max} [Nm]	n_{Mmax} [rpm]	n_N [rpm]	I_N [A]	I_{Max} [A]	J_R [kgm ²]	ØA [mm]	B [mm]	ØC [mm]	m [kg]
MST130	A-0200	9	15	900	2,000	7.5	16	0.0008	150	63	60	2.4/0.65
	C-0050	25	40	225	500	7.5	12	0.0018		103		5.1/1.5
	E-0020	42	65	90	200	7.5	12	0.0029		143		7.7/2.2
MST160	A-0050	35	90	180	500	6.5	20	0.0059	180	95	80	5.6/2.4
	C-0050	70	180	180	500	13.0	40	0.0108		145		9.6/4.3
	E-0050	105	270	180	500	19.5	60	0.0158		195		13.9/6.2
MST210	A-0027	50	100	100	270	7.0	25	0.0120	230	75	120	7.2/3.0
	C-0027	120	250	100	270	13.0	50	0.0230		120		11.5/4.8
	C-0050			200	500	25.0	100					
	D-0070	150	300	270	700	32.0	120	0.0270		150		13.8/5.8
E-0027	240	500	100	270	24.0	90	0.0420	195	18.8/7.8			
MST290	B-0018	220	460	70	180	14.8	60	0.0800	310	105	200	13.5/6.2
	D-0002	350	700	10	25	6.3	25	0.1100		135		20.0/9.0
	D-0004			17	45	10.4	30					
	D-0018			70	180	26.0	100					
	E-0004	575	1,150	16	40	12.5	50	0.1700		195		25.1/11.6
	E-0018			70	180	35.0	125					
MST360	B-0018	375	900	70	180	20.0	70	0.1900	385	120	260	23.0/9.8
	D-0012	525	1,150	45	120	16.5	60	0.2700		150		28.8/13.5
	D-0018			70	180	28.0	100					
	E-0018	875	1,900	70	180	42.0	141	0.4400		210		40.3/20.9
MST450	B-0012	540	1,200	45	120	22.0	70	0.4500	480	120	350	31.0/13.0
	D-0006	810	1,800	25	60	18.8	50	0.6400		150		38.7/17.9
	D-0012			45	120	33.0	100					
	E-0006	1,400	3,250	25	60	32.0	88	1.0100		210		54.2/27.7
	E-0012			45	120	46.0	125					
MST530	B-0010	800	1,800	45	100	28.6	71	0.9200	565	120	410	36.0/22.0
	C-0010	1,200	2,700	40	100	31.2	88	1.2500		150		45.0/27.5
	E-0010	2,100	4,700	40	100	64.0	212	1.9200		210		63.0/38.5
	G-0007	4,200	9,200	28	70	96.0	305	3.8400		370		144.0/77.0
	L-0006	6,300	13,800	25	60	120.0	380	5.7600		520		205.0/115.0

All the specifications given are based on operation with liquid cooling and 540 V DC bus voltage ¹⁾ depends on rotor version ²⁾ stator/rotor

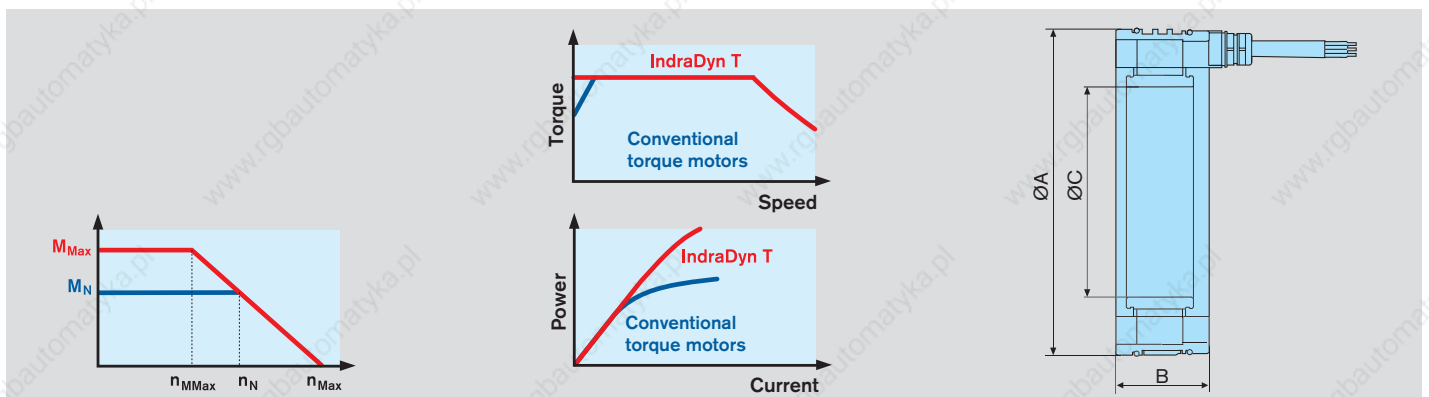

IndraDyn H – high-speed frameless (kit) motors

The liquid-cooled high-speed IndraDyn H kit motors achieve maximum torques of up to 4,500 Nm with speeds of up to 30,000 rpm.

With their broad constant output power range, short ramp-up time and low rotor temperature they are predestined for motor spindles and other similar areas of application.

The new onboard cooling system simplifies their integration in the machine and increases their cooling efficiency.

For extra easy assembly and disassembly we can supply the rotor on request with a step interference fit and the corresponding hydraulic connections.

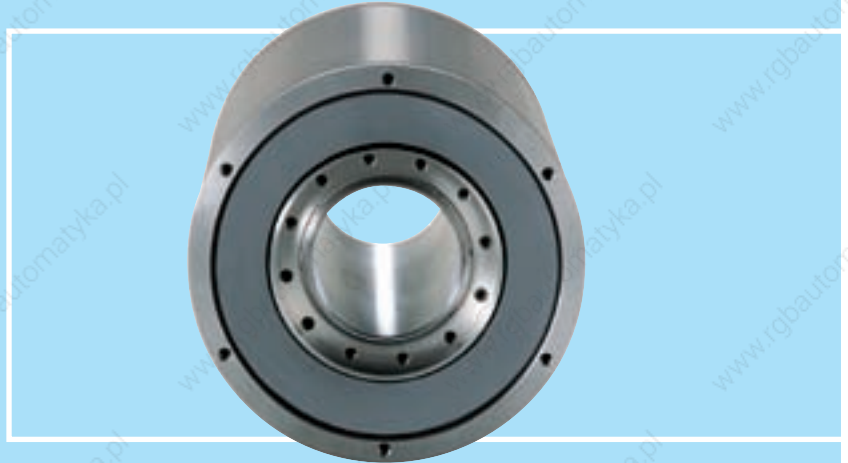

The simple step-by-step guide to ordering your high-speed IndraDyn H motor:

Stator

MSS^{Option}**182A-0100-FA-N0CN-NNNN**

Motor (Stator)

- Size (e. g. "182")
- Overall length (e. g. "A")
- Winding (e. g. "0100")

Rotor

MRS^{Option}**182A-1N-0075-NNNN**

Internal diameter of rotor

Corresponding internal diameters are available for every rotor size. For further details see configuration handbook.

Motor (Rotor)

- Size (e. g. "182")
- Overall length (e. g. "A")

Rotor version

- 1N** = Smooth bore
- 2N** = Step interference fit with hydraulic connection



High dynamics and precision

- Maximum torques up to 4,500 Nm
- Maximum speeds up to 30,000 rpm
- Wide constant output power range
- Integrated cooling system
- Straightforward integration in the machine

Your benefits

Motor		Rated speed	Maximum speed	Rated torque	Maximum torque	Rated power	Rated current	Maximum current	Rotor ¹⁾	Dimensions			Mass ²⁾	
		n_N [rpm]	n_{Max} [rpm]	M_N [Nm]	M_{Max} [Nm]	P_N [kW]	I_N [A]	I_{Max} [A]	Moment of inertia J_R [kgm ²]	$\varnothing A$ [mm]	B [mm]	$\varnothing C$ ¹⁾ [mm]	m [kg]	
MSS102	B-0800	8,000	30,000	10.5	30.0	8.8	18.0	40.0	0.0030	120	156	46	7.7/2.1	
	D-0800	8,000	30,000	20.0	45.0	16.8	24.0	69.0	0.0040		206		10.1/3.1	
	F-0300	3,000	18,000	32.0	75.0	10.1	15.3	35.0	0.0060	180	306	68	14.9/5.1	
F-0800	8,000	30,000	26.0	68.0	21.8	43.0	100.0							
F-0700	7,000	28,000	27.5	67.0	20.2	45.0	100.0	0.0110			181		16.7/4.6	
MSS142	D-0700	7,000	28,000	40.5	90.0	29.7	65.0	140.0	0.0140	160	231	58	21.2/6.5	
	F-0700	7,000	28,000	65.0	150.0	47.6	68.0	180.0	0.0170		281		25.7/8.3	
	B-0400	4,000	20,000	50.0	115.0	20.9	42.0	110.0	0.0140		206		22.0/6.9	
MSS162	D-0400	4,000	20,000	70.0	160.0	29.3	64.0	170.0	0.0180	180	256	68	28.1/8.8	
	F-0310	3,100	15,500	90.0	200.0	29.2	64.0	170.0	0.0220		306		34.1/10.6	
	J-0200	2,000	10,000	120.0	275.0	25.1	64.0	170.0	0.0280		381		46.1/13.4	
MSS182	A-0100	1,000	6,000	12.0	30.0	1.3	3.7	11.0	0.0089	200	82	85	6.9/2.7	
	A-0250	2,500	12,000	12.0	30.0	3.1	5.0	15.0						
	B-0280	2,800	12,000	100.0	230.0	29.3	64.0	170.0	0.0310		232		32.1/9.6	
	D-0260	2,600	12,000	140.0	320.0	38.1	71.0	200.0	0.0390		282		38.9/11.8	
MSS202	F-0200	2,000	12,000	200.0	450.0	41.9	71.0	200.0	0.0530	220	382	96	52.6/21.3	
	A-0200	2,000	11,000	105.0	270.0	22.0	45.0	130.0	0.0500		215		33.0/12.8	
	B-0150	1,500	8,200	140.0	390.0	22.0	52.0	141.0	0.0640		265		40.7/16.2	
	B-0210	2,100	11,500	140.0	390.0	30.8	68.0	180.0					315	48.3/19.6
MSS242	D-0120	1,200	6,600	245.0	650.0	30.8	68.0	180.0	0.1040	270	415	110	63.7/26.9	
	B-0100	1,000	6,000	250.0	575.0	26.2	68.0	180.0	0.1190		275		66.7/22.5	
	D-0070	700	4,200	375.0	860.0	27.5	49.5	180.0	0.1670		375		92.3/31.7	
MSS272	F-0060	600	3,600	425.0	970.0	26.7	68.0	180.0	0.1930	300	425	135	105.1/36.5	
	B-0065	650	3,000	400.0	900.0	27.2	71.0	200.0	0.2680		330		90.4/35.5	
	B-0080	800	3,200	400.0	900.0	33.5	82.0	250.0					405	112.3/44.5
	D-0050	500	2,200	525.0	1,200.0	27.5	71.0	200.0	0.3350		480		134.2/53.5	
MSS312	F-0040	400	1,800	650.0	1,500.0	27.2	71.0	200.0	0.4030	340	480	170	154.1/67.4	
	B-0035	350	1,500	650.0	1,550.0	23.8	62.5	170.0	0.6170		380		128.7/55.0	
	D-0028	280	1,200	820.0	1,950.0	24.0	59.5	160.0	0.7510		455		154.1/67.4	
	D-0060	600	2,400	820.0	1,950.0	51.5	93.2	250.0					455	154.1/67.4
	F-0028	280	1,200	975.0	2,275.0	28.6	62.0	180.0	0.8850		530		179.5/79.5	
MSS382	H-0025	250	1,100	1,125.0	2,750.0	29.5	62.0	180.0	1.0640	405	630	240	215.0/95.6	
	H-0085	850	3,400	1,100.0	2,750.0	97.9	197.0	570.0						
	B-0025	250	1,000	1,375.0	2,875.0	36.0	85.0	250.0	1.5250		430		178.5/77.6	
	D-0020	200	800	1,775.0	3,700.0	37.2	101.0	250.0	1.9110		530		220.1/97.2	
MSS482	F-0018	180	720	2,170.0	4,500.0	40.9	83.6	250.0	2.2960	510	630	345	262.0/120.0	
	A-0200	2,000	5,000	120.0	275.0	25.1	40.0	140.0	0.6040		115		14.8/16.4	

All the specifications given are based on operation with liquid cooling and 540 V DC bus voltage. The indicated maximum speed is reached at a DC bus voltage of 750 V.

¹⁾ depends on rotor version ²⁾ stator/rotor with largest available internal diameter of rotor

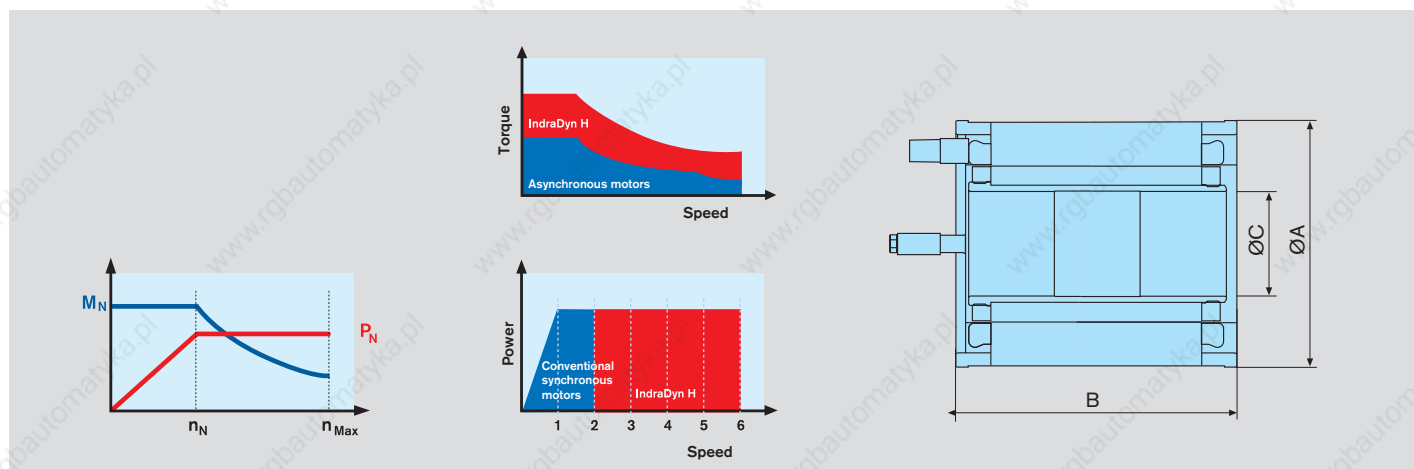

1MB – asynchronous frameless (kit) motors for compact drive solutions

The 1MB frameless (kit) motors are maintenance-free asynchronous motors with high power density. For different performance requirements and installation situations, our product range offers 9 motor sizes with different overall lengths and diameters.

Typical areas of application of these motors are the main spindles of modern CNC machines and machining centers. These frameless (kit) motors excel by their superb running smoothness and perfect servo quality for C-axis machining, thread cutting and spindle positioning.



The simple step-by-step guide to ordering your asynchronous frameless (kit) motor 1MB:

Stator

Motor (stator)

- Overall size (e. g. "310")
- Overall length (e. g. "B")
- Winding (e. g. "6B")

Option
1MS**310B-6B-A2/S010**

Special version

S010 = with several integrated temperature sensors (NTC thermistor, PTC thermistor, temperature switch)

Electrical connection

- 1** = Lines at the stator side brought out with larger outside diameter
- 2** = Lines at the stator side brought out with smaller outside diameter

Rotor

Motor (rotor)

- Overall size (e. g. "310")
- Overall length (e. g. "B")

Option
1MR**310B-A094**

Internal diameter of rotor

For each rotor size, corresponding internal diameters are available. For details, refer to the configuration handbook.

Rotor version

e. g. step interference with hydraulic connection



Robust and reliable

- ▮ Rated torques up to 875 Nm
- ▮ Maximum speeds up to 20,000 rpm
- ▮ Large spindle cutoff
- ▮ Excellent running smoothness
- ▮ Easy integration into the machine

Your benefits

Motor		Rated speed	Maximum speed	Rated torque	Rated performance	Rated current	Moment of inertia	Dimensions			Mass ²⁾
		n _N [rpm]	n _{Max} [rpm]	M _N [Nm]	P _N [kW]	I _N [A]	J _R [kgm ²]	Ø A [mm]	B [mm]	Ø C ¹⁾ [mm]	m [kg]
1MS140	B-4A	7,500	20,000	7	5.5	18.0	0.0044	160	150	45	5.3/3.3
	B-4B	5,000	20,000	7	3.7	25.0	0.0061				8.2/4.5
	D-4B	4,000	16,000	14	6.0	43.0	0.0082				11.8/6.1
	F-4A	3,000	15,000	24	7.5	43.0	0.0103				15.5/7.3
	H-4B	3,000	15,000	34	10.5	58.0	0.0084				6.8/5.3
1MS160	B-4A	3,000	12,000	16	5.0	36.0	0.0121	180	255	60	11.1/7.3
	D-4A	3,000	12,000	32	10.0	48.0	0.0149				14.4/9.4
	D-4B	2,000	8,000	32	6.7	23.8	0.0161				15.8/10.2
	E-4B	1,000	4,000	33	3.5	19.0	0.0201				21.0/9.8
	F-4A	3,000	12,000	48	15.0	74.0	0.0267				28.1/12.7
	F-4B	3,000	12,000	48	15.0	45.0	0.0267				28.1/12.7
	F-4D	2,500	10,000	48	12.5	23.2	0.0267				28.1/12.7
	H-4A	3,000	12,000	64	20.0	58.0	0.0267				28.1/12.7
	N-4A	3,000	12,000	89	28.0	75.0	0.0267				28.1/12.7
	N-4B	2,000	8,000	89	18.6	60.0	0.0267				28.1/12.7
	N-4C	1,500	6,000	89	14.0	26.0	0.0267				28.1/12.7
1MS200	C-4A	1,500	6,000	57	9.0	50.0	0.0410	220	295	66	21.0/15.0
	D-4B	1,500	6,000	85	13.5	48.0	0.0370				29.0/19.0
	D-4C	5,000	20,000	59	31.0	75.0	0.0370				29.0/19.0
	D-4D	2,500	10,000	85	22.0	59.0	0.0370				29.0/19.0
	D-4E	1,500	6,000	85	13.5	84.0	0.0370				29.0/19.0
	D-4F	6,000	18,000	49	31.0	82.0	0.0590				34.0/22.0
	E-4B	1,800	7,200	85	16.0	41.4	0.0590				34.0/22.0
	E-4C	3,900	15,600	74	30.2	65.0	0.0690				41.0/26.0
	H-4B	1,500	6,000	124	19.5	68.0	0.0690				41.0/26.0
	H-4D	1,500	6,000	124	19.5	52.6	0.0690				41.0/26.0
1MS240	B-4A	1,000	4,000	62	6.5	46.0	0.0780	270	360	72	29.0/19.0
	F-4A	1,000	4,000	123	13.0	74.0	0.1200				48.0/29.0
	H-4B	1,000	4,000	169	18.0	56.0	0.1530				62.0/37.0
1MS241	D-6A	1,000	4,000	112	12.0	62.0	0.1350	270	410	111	38.0/24.0
	D-6C	1,000	4,000	112	12.0	27.0	0.2270				63.0/39.0
	H-6C	1,800	7,200	202	32.0	75.5	0.2270				63.0/39.0
	H-6D	850	3,400	202	18.0	66.4	0.2270				63.0/39.0
	H-6G	800	3,200	202	16.9	39.7	0.2270				63.0/39.0
1MS242	N-4B	1,700	6,800	185	33.0	98.0	0.1350	270	440	71	81.0/37.0
1MS270	C-4B	1,500	6,000	190	30.0	96.0	0.2580	300	400	120	82.0/52.0
1MS310	B-6B	1,000	4,000	260	27.0	75.0	0.4770	340	450	125	84.0/65.0
	B-6D	700	2,800	260	19.0	81.0	0.4920				108.0/80.0
	B-6E	440	1,760	260	12.0	58.0	0.7230				133.0/97.0
	D-6B	800	3,200	340	28.5	81.0	0.7230				133.0/97.0
	F-6A	400	1,600	480	20.0	61.0	1.3900				162.0/106.0
	F-6B	900	3,600	480	35.0	111.0	1.3900				162.0/106.0
1MS375	B-6B	600	2,400	636	40.0	120.0	1.7300	405	620	170	205.0/132.0
	D-6B	600	2,400	875	55.0	150.0	1.7300				205.0/132.0
	D-6D	300	1,200	875	27.5	94.0	1.7300				205.0/132.0

All the specifications given are based on operation with liquid cooling and 540 V DC bus voltage.

¹⁾ available diameters depend on rotor version ²⁾ stator/rotor

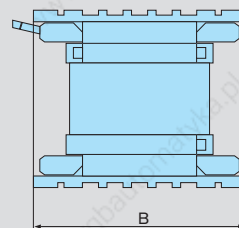
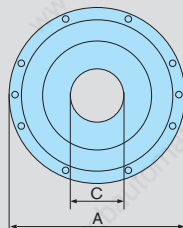
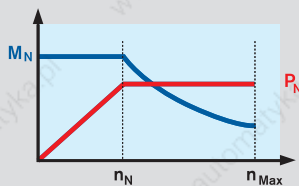

GTE – planetary gearboxes for standard applications

Together with our dynamic MSK motors, the compact GTE range of planetary gearboxes guarantees high torques in all standard applications.

Typical areas of application include simple handling and automation systems with rack-and-pinion drives or synchronous belt drives.

Virtually all performance requirements can be met in these applications thanks to the subtle staggering of sizes and the high power density of the GTE gearboxes.

The single-stage or two-stage gearboxes can be supplied with a plain shaft or keyway.



The simple step-by-step guide to ordering your GTE planetary gearboxes:

Option
GTE060-NN1-004A-NN03

Gearbox

- Size (e. g. "040")

Gear stages

- 1 = Single-stage
- 2 = Two-stage

Output shaft and backlash

- A = with keyway
- B = Plain shaft

Motor/gearbox combination

	Motor	GTE060	GTE080	GTE120	GTE160
MSK	030	NN02	NN02	–	–
	040	–	NN03	NN03	–
	050	–	–	NN20	NN20
	060	–	–	NN21 ¹⁾	NN21
	061	–	–	NN05 ¹⁾	NN05
	070	–	–	–	NN16
	071	–	–	–	NN16
	075	–	–	–	NN16
	076	–	–	–	NN06
	100	–	–	–	NN09 ¹⁾

¹⁾ combination only possible with single-stage gearboxes

Economical and compact

- ! Ideal for standard applications
- ! Low backlash
- ! Open choice of mounting positions
- ! Silent operation
- ! Lifetime lubrication

Your benefits

Gearbox	Transmission ratio		Nominal input speed	Maximum input speed	Maximum output speed	Nominal input torque	Nominal output torque	Maximum input torque	Maximum output torque	Backlash	Torsional stiffness	Efficiency	Moment of inertia	Mass
	i	n_{IN} N [rpm]	n_{IN} Max [rpm]	n_{OUT} Max [rpm]	M_{IN} N [Nm]	M_{OUT} N [Nm]	M_{IN} Max [Nm]	M_{OUT} Max [Nm]	- [arcmin]	D [Nm/arcmin]	η [%]	J [kgcm ²]	m [kg]	
GTE060	single-stage	3	4,000	13,000	4,333	4.0	12	4.0	12	< 20	1.5	96	0.135	0.9
		4	4,000	13,000	3,250	4.0	16	4.0	16					
		5	4,000	13,000	2,600	3.2	16	3.2	16					
		8	4,000	13,000	1,625	1.9	15	1.9	15					
	two-stage	12	4,000	13,000	1,083	3.7	44	3.7	44	< 25	1.5	94	0.127	1.1
		20	4,000	13,000	650	2.2	44	2.2	44					
GTE080	single-stage	3	4,000	7,000	2,333	13.3	40	13.3	40	< 12	4.5	96	0.770	2.1
		4	4,000	7,000	1,750	12.5	50	12.5	50					
		5	4,000	7,000	1,400	10.0	50	10.0	50					
		8	4,000	7,000	875	6.3	50	6.3	50					
	two-stage	12	4,000	7,000	583	10.0	120	10.0	120	< 17	5.2	94	0.720	2.6
		20	4,000	7,000	350	6.0	120	6.0	120					
GTE120	single-stage	3	3,500	6,500	2,167	26.7	80	26.7	80	< 8	11	96	2.630	6
		4	3,500	6,500	1,625	25.0	100	25.0	100					
		5	3,500	6,500	1,300	22.0	110	22.0	110					
		8	3,500	6,500	813	15.0	120	15.0	120					
	two-stage	12	3,500	6,500	542	21.7	260	21.7	260	< 12	11	94	2.560	8
		20	3,500	6,500	325	13.0	260	13.0	260					
GTE160	single-stage	3	3,000	6,500	2,167	133.3	400	133.3	400	< 6	32.5	96	12.140	18
		4	3,000	6,500	1,625	112.5	450	112.5	450					
		5	3,000	6,500	1,300	90.0	450	90.0	450					
		8	3,000	6,500	813	56.3	450	56.3	450					
	two-stage	12	3,000	6,500	542	66.7	800	66.7	800	< 10	35	94	12.370	22
		20	3,000	6,500	325	40.0	800	40.0	800					
		40	3,000	6,500	163	17.5	700	17.5	700				5.280	

GTM – planetary gearboxes for maximum performance

Characterized by a particularly high power density and low backlash, the high-precision GTM range of planetary gearboxes has been designed for mounting directly on servo motors.

Their high degree of efficiency makes these gearboxes suitable for the S1 continuous operation and therefore ideal for use in printing presses, for example.

Combined with the dynamic IndraDyn motors they achieve the highest speeds, acceleration and optimum positioning accuracy.

The single-stage or two-stage gearboxes can be supplied with a plain shaft or keyway and also with reduced backlash on request.

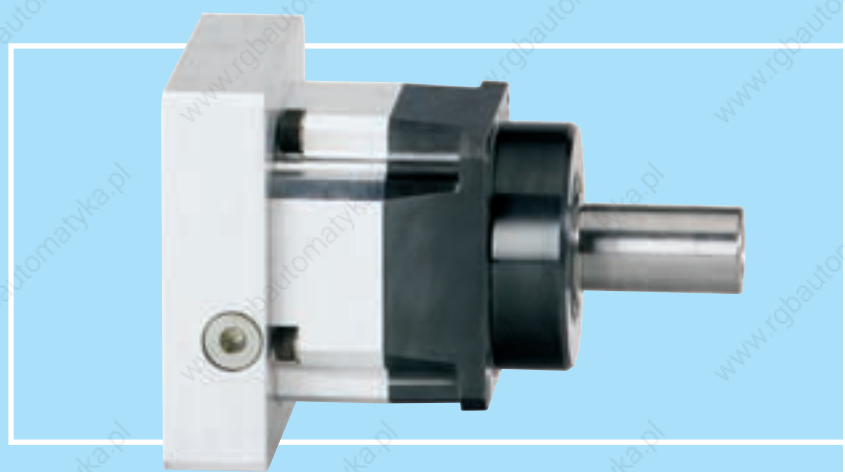

The simple step-by-step guide to ordering your GTM planetary gearbox:

GTM075-NN1-004A-NN03

Gears

- Size (e. g. "075")

Gear range

- 1** = Single-stage
- 2** = Two-stage

Output shaft and backlash

- A** = with keyway
- B** = Plain shaft
- C** = with keyway and reduced backlash
- D** = Plain shaft, reduced backlash

Option

Motor/gearbox combination

	Motor	GTM060	GTM075	GTM100	GTM140	GTM180	GTM240
MSK	030	NN02	-	-	-	-	-
	040	NN03	NN03	-	-	-	-
	050	-	NN20	NN20	NN20	-	-
	060	-	NN21	NN21	NN21	-	-
	061	-	NN05	NN05	NN05	-	-
	070	-	-	NN16	NN16	NN16	-
	071	-	-	NN16	NN61	NN16	-
	075	-	-	NN16	NN61	NN16	-
	076	-	-	NN06	NN06	-	-
	100	-	-	-	NN09	NN09	-
101	-	-	-	NN19	NN19	-	
131	-	-	-	-	NN15 ¹⁾	NN15 ¹⁾	
MKE	037	NN13	-	-	-	-	-
	047	NN14	NN14	-	-	-	-
	098	-	-	NN06	NN06	-	-
MAD	118	-	-	-	NN09	NN09	-
	100	-	-	-	NN09	NN09	-
	130	-	-	-	-	NN11 ¹⁾	NN11 ¹⁾
MAF	160	-	-	-	-	-	NN12 ¹⁾
	100	-	-	-	-	NN08	-
	130	-	-	-	-	NN11 ¹⁾	NN11 ¹⁾

¹⁾ combination only possible with single-stage gearboxes



High-precision and flexibility

- ! High-precision gearing for highest positioning accuracy
- ! Minimum power dissipation in continuous operation
- ! Optimized gear tooth forming for silent operation
- ! Environment-resistant, hermetically sealed housing
- ! High acceleration torque is achievable through a compact and rigid construction

Your benefits

Gearbox	Transmission ratio		Nominal input speed	Maximum input speed	Maximum output speed	Nominal input torque	Nominal output torque	Maximum input torque	Maximum output torque	Backlash standard / reduced	Torsional stiffness	Efficiency	Moment of inertia	Mass
		i	$n_{IN\ N}$ [rpm]	$n_{IN\ Max}$ [rpm]	$n_{OUT\ Max}$ [rpm]	$M_{IN\ N}$ [Nm]	$M_{OUT\ N}$ [Nm]	$M_{IN\ Max}$ [Nm]	$M_{OUT\ Max}$ [Nm]	- [arcmin]	D [Nm/arcmin]	η [%]	J [kgcm ²]	[kg]
GTM060	single-stage	4	3,000	5,000	1,250	6.25	25	12.5	50	$\leq 6/\leq 3$	3.5	≥ 97	0.160	1.6
		5	4,000	6,300	1,260	5.00	25	10.0	50					
		7	5,000	8,000	1,143	3.60	25	7.1	50					
		10	6,000	10,000	1,000	2.00	20	4.0	40					
	two-stage	20	4,000	6,300	315	1.25	25	2.5	50	$\leq 8/\leq 6$	≥ 94	0.120	2.2	
		50	6,000	10,000	200	0.50	25	1.0	50					
GTM075	single-stage	4	3,000	5,000	1,250	21.30	85	42.5	170	$\leq 6/\leq 3$	8.2	≥ 97	0.550	2.9
		5	4,000	6,300	1,260	20.00	100	40.0	200					
		7	5,000	8,000	1,143	12.10	85	24.3	170					
		10	6,000	10,000	1,000	6.00	60	11.0	110					
	two-stage	20	4,000	6,300	315	4.25	85	8.5	170	$\leq 8/\leq 6$	≥ 94	0.470	3.8	
		50	6,000	10,000	200	2.00	100	4.0	200					
GTM100	single-stage	3	2,300	4,000	1,333	40.00	120	73.3	220	$\leq 4/\leq 2$	24	≥ 97	2.800	5.7
		4	2,500	4,000	1,000	42.50	170	85.0	340					
		5	3,000	5,000	1,000	40.00	200	80.0	400					
		7	4,000	6,300	900	24.30	170	48.6	340					
		10	5,000	8,000	800	12.00	120	22.0	220					
	two-stage	20	3,000	5,000	250	8.50	170	17.0	340	$\leq 6/\leq 4$	≥ 94	1.560	7.5	
50	5,000	8,000	160	4.00	200	8.0	400							
GTM140	single-stage	3	1,800	3,200	1,067	93.30	280	186.7	560	$\leq 4/\leq 2$	48	≥ 97	8.200	11.5
		4	2,000	3,200	800	105.00	420	210.0	840					
		5	2,500	4,000	800	100.00	500	200.0	1,000					
		7	3,000	5,000	714	60.00	420	120.0	840					
		10	4,000	6,300	630	28.00	280	56.0	560					
	two-stage	20	2,500	4,000	200	21.00	420	42.0	840	$\leq 6/\leq 4$	≥ 94	5.290	15	
50	4,000	6,300	126	10.00	500	20.0	1,000							
GTM180	single-stage	3	1,300	2,500	833	240.00	720	480.0	1,440	$\leq 4/\leq 2$	148	≥ 97	36.000	27
		4	1,500	2,500	625	255.00	1,020	510.0	2,040					
		5	2,000	3,200	640	240.00	1,200	480.0	2,400					
		7	2,500	4,000	571	145.70	1,020	291.4	2,040					
		10	3,000	5,000	500	72.00	720	144.0	1,440					
	two-stage	20	2,000	3,200	160	51.00	1,020	102.0	2,040	$\leq 6/\leq 4$	≥ 94	6.950	35	
50	3,000	5,000	100	24.00	1,200	48.0	2,400							
GTM240	single-stage	3	800	2,000	667	600.00	1,800	1,000.0	3,000	$\leq 4/\leq 2$	340	≥ 97	128.000	62
		4	1,000	2,000	500	625.00	2,500	1,250.0	5,000					
		5	1,200	2,500	500	600.00	3,000	1,200.0	6,000					
		7	1,500	3,000	429	357.10	2,500	714.3	5,000					
		10	2,000	3,500	350	180.00	1,800	300.0	3,000					

Standard and geared motors – for simple applications

For use with frequency converters we recommend combining IndraDrive with geared motors or three-phase asynchronous motors made by NORD Drive Systems or VEM Motors.

Upon request we can supply all-in-one solutions, comprising of control units and motors also sourced directly from Rexroth.

Our range of geared motors covers various types of gears of different performance categories:

- Spur gear motors with rated outputs of up to 160 kW and torques of up to 26,000 Nm

- Offset geared motors with rated outputs of up to 200 kW and torques of up to 200,000 Nm
- Bevel gear motors with rated outputs of up to 160 kW and torques of up to 32,000 Nm
- Worm gear motors with rated outputs of up to 15 kW and torques of up to 3,000 Nm

Our range of three-phase asynchronous motors includes:

- Standard motors with rated outputs of up to 500 kW
- Energy-saving motors with rated outputs of up to 335 kW

These motors are particularly suitable for operation with frequency converters and boast the following features:

- Motor design conforming to DIN EN 60034 (IEC 72)
- Mounting dimensions and output correlation compliant with DIN 42673, 42677
- Robust, low-vibration version in gray cast iron
- Protection category IP 55, higher protection category up to IP 65 optional
- Insulation class F with thermal reserve, insulation class H optional
- Further options include brakes, encoder, position of terminal box, etc.

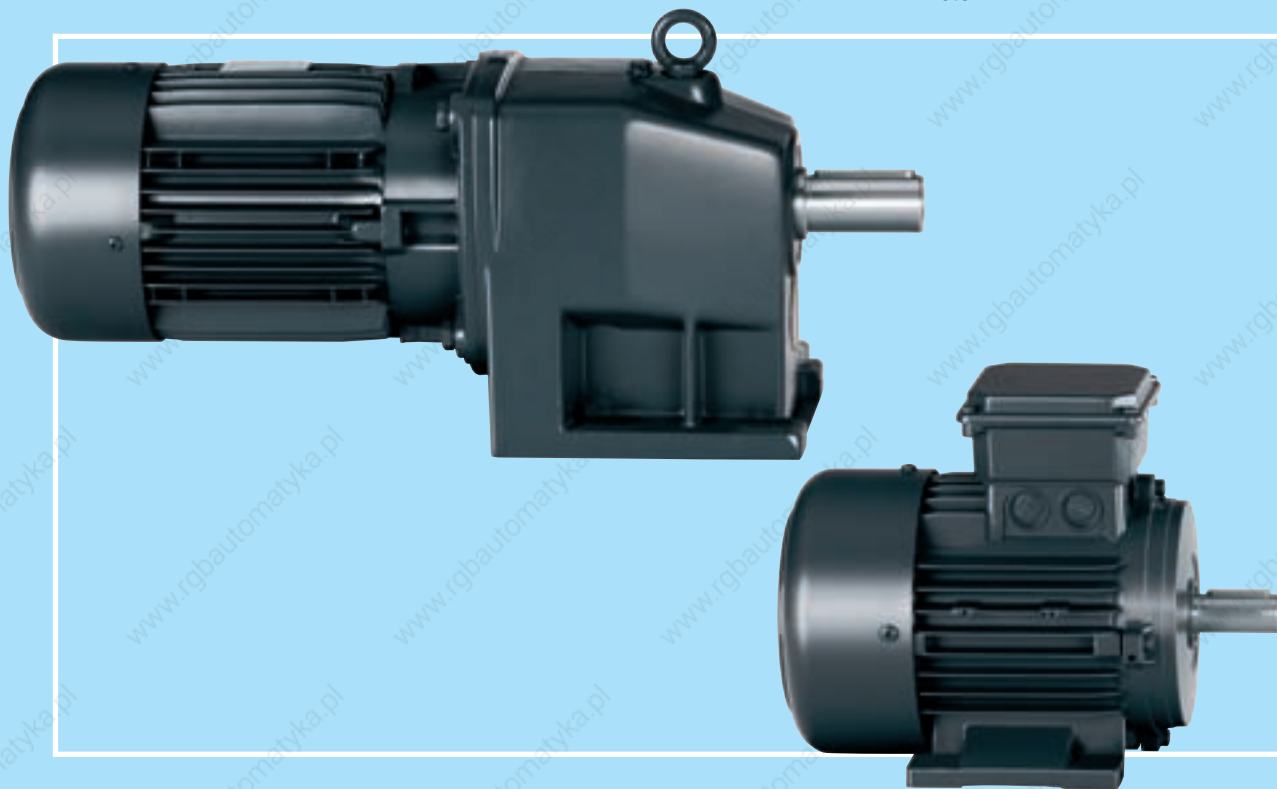

Cross reference for IEC standard motors

Mechanical motor output P _{Nom}	I _{Nom}	cos φ	η	Continuous operation I _{Nom} (> 10 min)	Overload operation 1.1 x I _{Nom} (1 min) I _{Nom} (9 min)	Overload operation 1.5 x I _{Nom} (1 min) I _{Nom} (4 min)	Overload operation 2 x I _{Nom} (2 s) I _{Nom} (18 s)
1.1 kW	2.6 A	0.79	76.6 %	HCS02.1E-W0012 HMS01.1N-W0020 HMD01.1N-W0012	HCS02.1E-W0012 HMS01.1N-W0020 HMD01.1N-W0012	HCS02.1E-W0012 HMS01.1N-W0020 HMD01.1N-W0012	HCS02.1E-W0012 HMS01.1N-W0020 HMD01.1N-W0012
1.5 kW	3.4 A	0.81	78.8 %	HCS02.1E-W0012 HMS01.1N-W0020 HMD01.1N-W0012	HCS02.1E-W0012 HMS01.1N-W0020 HMD01.1N-W0012	HCS02.1E-W0028 HMS01.1N-W0020 HMD01.1N-W0012	HCS02.1E-W0028 HMS01.1N-W0020 HMD01.1N-W0012
2.2 kW	5.2 A	0.76	81.0 %	HCS02.1E-W0028 HMS01.1N-W0020 HMD01.1N-W0012	HCS02.1E-W0028 HMS01.1N-W0020 HMD01.1N-W0012	HCS02.1E-W0028 HMS01.1N-W0020 HMD01.1N-W0012	HCS02.1E-W0028 HMS01.1N-W0020 HMD01.1N-W0012
3.0 kW	6.7 A	0.79	82.0 %	HCS02.1E-W0028 HMS01.1N-W0020 HMD01.1N-W0012	HCS02.1E-W0028 HMS01.1N-W0020 HMD01.1N-W0020	HCS02.1E-W0028 HMS01.1N-W0020 HMD01.1N-W0020	HCS02.1E-W0028 HMS01.1N-W0020 HMD01.1N-W0020
4.0 kW	8.8 A	0.78	84.2 %	HCS02.1E-W0028 HMS01.1N-W0020 HMD01.1N-W0020	HCS02.1E-W0028 HMS01.1N-W0020 HMD01.1N-W0020	HCS02.1E-W0028 HMS01.1N-W0036 HMD01.1N-W0036	HCS02.1E-W0054 ¹⁾ HMS01.1N-W0036 HMD01.1N-W0036
5.5 kW	11.8 A	0.77	85.7 %	HCS02.1E-W0054 ¹⁾ HMS01.1N-W0020 HMD01.1N-W0036	HCS02.1E-W0054 ¹⁾ HMS01.1N-W0036 HMD01.1N-W0036	HCS02.1E-W0054 ¹⁾ HMS01.1N-W0036 HMD01.1N-W0036	HCS02.1E-W0054 ¹⁾ HMS01.1N-W0036 HMD01.1N-W0036
7.5 kW	15.0 A	0.84	87.0 %	HCS02.1E-W0054 ¹⁾ HMS01.1N-W0036 HMD01.1N-W0036	HCS02.1E-W0054 ¹⁾ HMS01.1N-W0036 HMD01.1N-W0036	HCS02.1E-W0070 ¹⁾ HMS01.1N-W0036 HMD01.1N-W0036	HCS02.1E-W0070 ¹⁾ HMS01.1N-W0036 HMD01.1N-W0036
11.0 kW	21.0 A	0.85	88.4 %	HCS02.1E-W0070 ¹⁾ HMS01.1N-W0036	HCS02.1E-W0070 ¹⁾ HMS01.1N-W0054	HCS02.1E-W0070 ¹⁾ HMS01.1N-W0054	HCS03.1E-W0070 ¹⁾ HMS01.1N-W0054
15.0 kW	28.0 A	0.86	89.4 %	HCS03.1E-W0070 ¹⁾ HMS01.1N-W0054	HCS03.1E-W0070 ¹⁾ HMS01.1N-W0054	HCS03.1E-W0070 ¹⁾ HMS01.1N-W0070	HCS03.1E-W0070 ¹⁾ HMS01.1N-W0070
18.5 kW	34.5 A	0.86	90.0 %	HCS03.1E-W0070 ¹⁾ HMS01.1N-W0054	HCS03.1E-W0070 ¹⁾ HMS01.1N-W0070	HCS03.1E-W0100 ¹⁾ HMS01.1N-W0110	HCS03.1E-W0100 ¹⁾ HMS01.1N-W0110
22.0 kW	42.0 A	0.84	90.5 %	HCS03.1E-W0070 ¹⁾ HMS01.1N-W0070	HCS03.1E-W0100 ¹⁾ HMS01.1N-W0110	HCS03.1E-W0100 ¹⁾ HMS01.1N-W0110	HCS03.1E-W0100 ¹⁾ HMS01.1N-W0110
30.0 kW	55.5 A	0.85	91.5 %	HCS03.1E-W0100 ¹⁾ HMS01.1N-W0110	HCS03.1E-W0100 ¹⁾ HMS01.1N-W0110	HCS03.1E-W0150 ¹⁾ HMS01.1N-W0150	HCS03.1E-W0150 ¹⁾ HMS01.1N-W0150
37.0 kW	67.0 A	0.86	92.5 %	HCS03.1E-W0100 ¹⁾ HMS01.1N-W0110	HCS03.1E-W0150 ¹⁾ HMS01.1N-W0150	HCS03.1E-W0150 ¹⁾ HMS01.1N-W0150	HCS03.1E-W0150 ¹⁾ HMS01.1N-W0150
45.0 kW	81.0 A	0.86	93.0 %	HCS03.1E-W0150 ¹⁾ HMS01.1N-W0150	HCS03.1E-W0150 ¹⁾ HMS01.1N-W0150	HCS03.1E-W0210 ¹⁾ HMS01.1N-W0210	HCS03.1E-W0210 ¹⁾ HMS01.1N-W0210
55.0 kW	98.5 A	0.86	93.5 %	HCS03.1E-W0210 ¹⁾ HMS01.1N-W0150	HCS03.1E-W0210 ¹⁾ HMS01.1N-W0210	HCS03.1E-W0210 ¹⁾ HMS01.1N-W0210	HCS03.1E-W0210 ¹⁾ HMS01.1N-W0210
75.0 kW	134.0 A	0.86	94.1 %	HCS03.1E-W0210 ¹⁾ HMS01.1N-W0210	HCS03.1E-W0210 ¹⁾ HMS01.1N-W0210	HMS01.1N-W0350 ²⁾	HMS01.1N-W0350 ²⁾
90.0 kW	160.0 A	0.86	94.6 %	HMS01.1N-W0350 ²⁾	HMS01.1N-W0350 ²⁾	HMS01.1N-W0350 ²⁾	HMS01.1N-W0350 ²⁾
110.0 kW	194.0 A	0.86	95.1 %	HMS01.1N-W0350 ²⁾	HMS01.1N-W0350 ²⁾	-	-
132.0 kW	233.0 A	0.86	95.1 %	HMS01.1N-W0350 ²⁾	HMS01.1N-W0350 ²⁾	-	-

The examples apply to operation of 4-pole standard motors 3 AC 400 V/50 Hz at 4 kHz switching frequency and a rotary frequency > 4 Hz. An external fan may be necessary depending on your application. ¹⁾ with HNL power choke ²⁾ preliminary

Cross reference for NEMA standard motors

Mechanical motor output P_{Nom}	I_{Nom}	$\cos \varphi$	η	Continuous operation $I_{Nom} (> 10 \text{ min})$	Overload operation $1.1 \times I_{Nom} (1 \text{ min})$ $I_{Nom} (9 \text{ min})$	Overload operation $1.5 \times I_{Nom} (1 \text{ min})$ $I_{Nom} (4 \text{ min})$	Overload operation $2 \times I_{Nom} (2 \text{ s})$ $I_{Nom} (18 \text{ s})$
1.5 hp	2.3 A	0.72	82.5 %	HCS02.1E-W0012 HMS01.1N-W0020 HMD01.1N-W0012	HCS02.1E-W0012 HMS01.1N-W0020 HMD01.1N-W0012	HCS02.1E-W0012 HMS01.1N-W0020 HMD01.1N-W0012	HCS02.1E-W0012 HMS01.1N-W0020 HMD01.1N-W0012
2.0 hp	3.0 A	0.78	85.5 %	HCS02.1E-W0012 HMS01.1N-W0020 HMD01.1N-W0012	HCS02.1E-W0012 HMS01.1N-W0020 HMD01.1N-W0012	HCS02.1E-W0012 HMS01.1N-W0020 HMD01.1N-W0012	HCS02.1E-W0012 HMS01.1N-W0020 HMD01.1N-W0012
3.0 hp	4.0 A	0.80	90.2 %	HCS02.1E-W0028 HMS01.1N-W0020 HMD01.1N-W0012	HCS02.1E-W0028 HMS01.1N-W0020 HMD01.1N-W0012	HCS02.1E-W0028 HMS01.1N-W0020 HMD01.1N-W0012	HCS02.1E-W0028 HMS01.1N-W0020 HMD01.1N-W0012
5.0 hp	6.7 A	0.79	88.5 %	HCS02.1E-W0028 HMS01.1N-W0020 HMD01.1N-W0012	HCS02.1E-W0028 HMS01.1N-W0020 HMD01.1N-W0020	HCS02.1E-W0028 HMS01.1N-W0020 HMD01.1N-W0020	HCS02.1E-W0028 HMS01.1N-W0020 HMD01.1N-W0020
7.5 hp	9.7 A	0.81	88.5 %	HCS02.1E-W0054 ¹⁾ HMS01.1N-W0020 HMD01.1N-W0020	HCS02.1E-W0054 ¹⁾ HMS01.1N-W0020 HMD01.1N-W0036	HCS02.1E-W0054 ¹⁾ HMS01.1N-W0036 HMD01.1N-W0036	HCS02.1E-W0054 ¹⁾ HMS01.1N-W0036 HMD01.1N-W0036
10.0 hp	12.7 A	0.81	90.2 %	HCS02.1E-W0054 ¹⁾ HMS01.1N-W0036 HMD01.1N-W0036	HCS02.1E-W0054 ¹⁾ HMS01.1N-W0036 HMD01.1N-W0036	HCS02.1E-W0054 ¹⁾ HMS01.1N-W0036 HMD01.1N-W0036	HCS02.1E-W0054 ¹⁾ HMS01.1N-W0036 HMD01.1N-W0036
15.0 hp	18.5 A	0.84	90.2 %	HCS02.1E-W0070 ¹⁾ HMS01.1N-W0036 HMD01.1N-W0036	HCS02.1E-W0070 ¹⁾ HMS01.1N-W0036 HMD01.1N-W0036	HCS02.1E-W0070 ¹⁾ HMS01.1N-W0054 -	HCS02.1E-W0070 ¹⁾ HMS01.1N-W0054 -
20.0 hp	26.0 A	0.78	91.0 %	HCS03.1E-W0070 ¹⁾ HMS01.1N-W0054	HCS03.1E-W0070 ¹⁾ HMS01.1N-W0054	HCS03.1E-W0070 ¹⁾ HMS01.1N-W0054	HCS03.1E-W0070 ¹⁾ HMS01.1N-W0054
25.0 hp	31.5 A	0.82	91.7 %	HCS03.1E-W0070 ¹⁾ HMS01.1N-W0054	HCS03.1E-W0070 ¹⁾ HMS01.1N-W0054	HCS03.1E-W0100 ¹⁾ HMS01.1N-W0110	HCS03.1E-W0070 ¹⁾ HMS01.1N-W0110
30.0 hp	38.5 A	0.79	93.0 %	HCS03.1E-W0070 ¹⁾ HMS01.1N-W0070	HCS03.1E-W0070 ¹⁾ HMS01.1N-W0070	HCS03.1E-W0100 ¹⁾ HMS01.1N-W0110	HCS03.1E-W0100 ¹⁾ HMS01.1N-W0110
40.0 hp	50.0 A	0.82	91.7 %	HCS03.1E-W0100 ¹⁾ HMS01.1N-W0110	HCS03.1E-W0100 ¹⁾ HMS01.1N-W0110	HCS03.1E-W0100 ¹⁾ HMS01.1N-W0150	HCS03.1E-W0150 ¹⁾ HMS01.1N-W0150
50.0 hp	60.5 A	0.81	92.4 %	HCS03.1E-W0100 ¹⁾ HMS01.1N-W0110	HCS03.1E-W0100 ¹⁾ HMS01.1N-W0110	HCS03.1E-W0150 ¹⁾ HMS01.1N-W0150	HCS03.1E-W0150 ¹⁾ HMS01.1N-W0150
60.0 hp	73.5 A	0.83	91.7 %	HCS03.1E-W0150 ¹⁾ HMS01.1N-W0150	HCS03.1E-W0150 ¹⁾ HMS01.1N-W0150	HCS03.1E-W0210 ¹⁾ HMS01.1N-W0210	HCS03.1E-W0210 ¹⁾ HMS01.1N-W0210
75.0 hp	92.0 A	0.82	94.1 %	HCS03.1E-W0150 ¹⁾ HMS01.1N-W0150	HCS03.1E-W0210 ¹⁾ HMS01.1N-W0150	HCS03.1E-W0210 ¹⁾ HMS01.1N-W0210	HCS03.1E-W0210 ¹⁾ HMS01.1N-W0210
100.0 hp	115.0 A	0.87	94.5 %	HCS03.1E-W0210 ¹⁾ HMS01.1N-W0210	HCS03.1E-W0210 ¹⁾ HMS01.1N-W0210	HMS01.1N-W0350 ²⁾	HMS01.1N-W0350 ²⁾
125.0 hp	143.0 A	0.87	94.5 %	HMS01.1N-W0210	HMS01.1N-W0350 ²⁾	HMS01.1N-W0350 ²⁾	HMS01.1N-W0350 ²⁾
150.0 hp	170.0 A	0.87	95.4 %	HMS01.1N-W0350 ²⁾	HMS01.1N-W0350 ²⁾	HMS01.1N-W0350 ²⁾	HMS01.1N-W0350 ²⁾
200.0 hp	230.0 A	0.86	95.0 %	HMS01.1N-W0350 ²⁾	HMS01.1N-W0350 ²⁾	-	-

The examples apply to operation of 4-pole standard motors 3 AC 400 V/60 Hz at 4 kHz switching frequency and a rotary frequency > 4 Hz. An external fan may be necessary depending on your application. ¹⁾ with HNL power choke ²⁾ preliminary

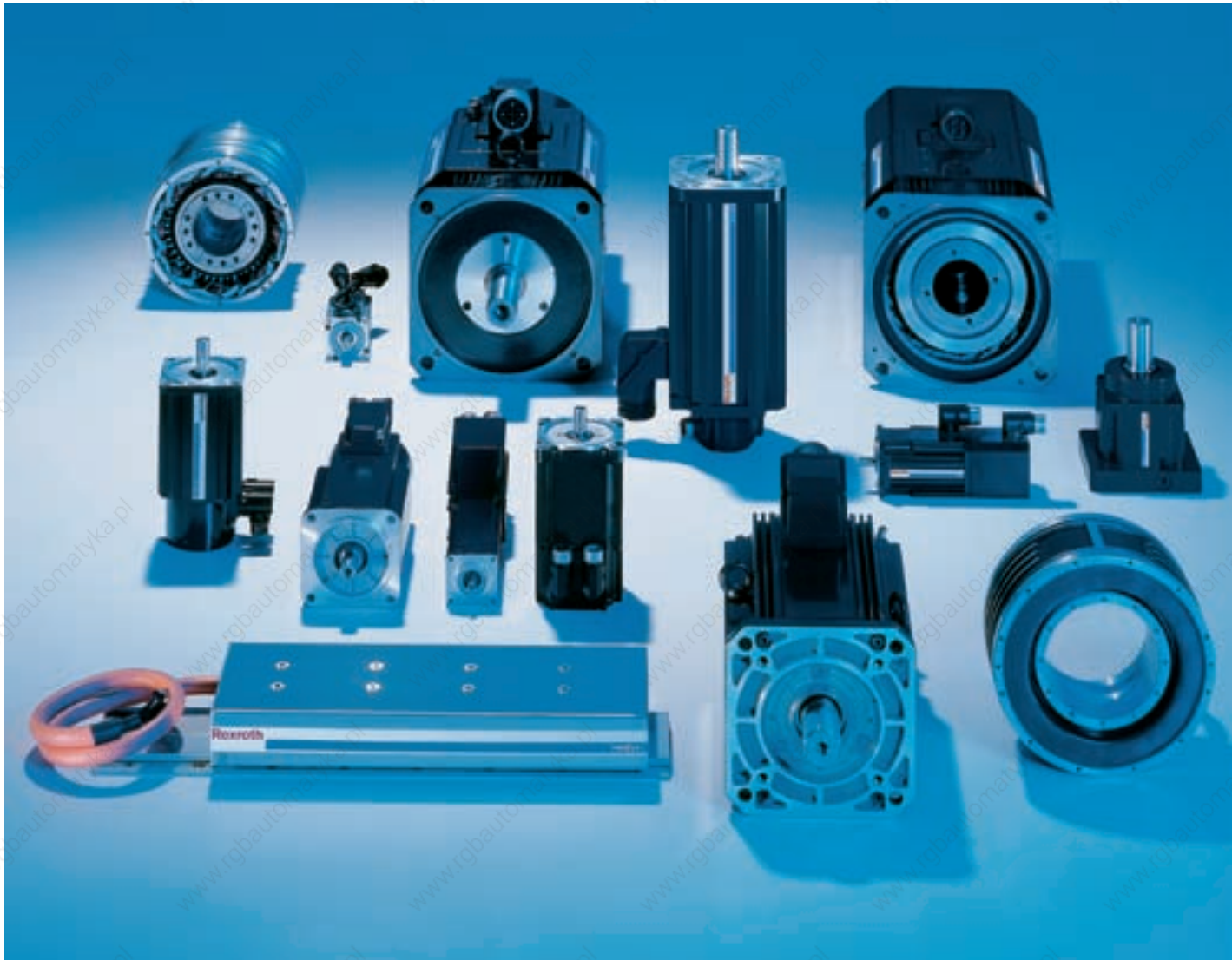

Auxiliary components





Accessories for all requirements

- ▮ Filters and chokes for EMC-proof operation
- ▮ Components designed to absorb high braking forces
- ▮ Energy storage capacitors for dynamic sequences
- ▮ Accessories for simplified assembly and installation

Your benefits

Mains filters

- EMC filters for the power supply units and converters
- for reduced circuit feedback

Mains filters with integrated mains choke

- for direct mounting on HCS03 series converters

Mains chokes

- for increased DC bus continuous output
- for reduced harmonics

Motor filters

- to protect the motor winding from extreme voltage rises
- for effective reduction of malfunctions in the motor supply line

Brake resistor

- for input power during regenerative operation
- for direct mounting on HCS02 and HCS03 series converters

Brake units

- brake resistor and braking transistor in one unit
- for increased braking power

Capacity modules

- capacitor unit for dynamic energy storage
- can be combined with power supply units or converters to save space

Blower unit

- for direct installation to supply unit HMV01.1R-W0120 and inverter HMS01.1N-W0350

Other accessories

- basic accessories for assembly and installation
- shield connection for EMC-compatible connection of the motor cable to the power unit
- control cabinet adapter for combining control units of different depths
- auxiliary capacitor
- electrical adaptors
- modular bus extension to bridge larger distances between drive groups

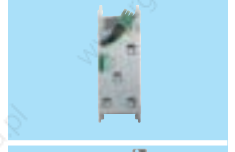

Mains filters – for HMV power supply units and HCS converters

Mains filters for HMV power supply units and HCS converters	Continuous current	Power dissipation	Width W	Height H	Depth D	Mass
	A	W	mm	mm	mm	kg
HNFO1.1A-F240-E0051-A-480-NNNN	51	< 89	100	440	262	15
HNFO1.1A-M900-E0051-A-480-NNNN	51	< 91	100	440	262	15
HNFO1.1A-F240-E0125-A-480-NNNN	125	< 127	150	440	262	18
HNFO1.1A-M900-E0125-A-480-NNNN	125	< 174	150	440	262	30
HNFO1.1A-F240-E0202-A-480-NNNN	202	< 238	150	440	262	29
HNFO1.1A-M900-E0202-A-480-NNNN	202	< 373	250	440	262	37
HNFO1.1A-A075-E0235-A-500-NNNN	235	in prep.	in prep.	in prep.	in prep.	in prep.
HNFO1.1A-A075-E0309-A-500-NNNN	309	in prep.	175	263	180	in prep.
HNFO1.1A-F240-R0026-A-480-NNNN	26	< 73	100	440	262	14
HNFO1.1A-M900-R0026-A-480-NNNN	26	< 77	150	440	262	17
HNFO1.1A-F240-R0065-A-480-NNNN	65	< 163	150	440	262	25
HNFO1.1A-M900-R0065-A-480-NNNN	65	< 157	150	440	262	26
HNFO1.1A-F240-R0094-A-480-NNNN	94	< 135	150	440	262	28
HNFO1.1A-M900-R0094-A-480-NNNN	94	< 146	150	440	262	29
HNFO1.1A-H350-R0180-A-480-NNNN	180	< 305	250	440	262	45
HNS02.1A-Q200-R0023-A-480-NNNN	23	< 75	80	352	265	15
for HCS converters	A	W	mm	mm	mm	kg
NFD03.1-480-007	7	3.9	50	160	90	0.7
NFD03.1-480-016	16	6.4	55	220	90	1
NFD03.1-480-030	30	11.9	60	270	100	1.4
NFD03.1-480-055	55	25.9	90	220	105	2
NFD03.1-480-075	75	30.4	90	240	145	3.5

All data applies to nominal rating at 3 AC 400 V mains voltage. Please see the selection tables on the end of this chapter for exact assignments to the power units.



Mains filters ensure that the EMC limit values are adhered to and suppress leakage current generated by line capacitors.

Our mains filters are optimally coordinated with the power units and are scalable in regards to current, number of drives and motor cable length.

They can be combined with our shielded motor cables for trouble-free operation conforming to EN 61800-3, Class A, Group 2, even with cable lengths of up to 75 m.

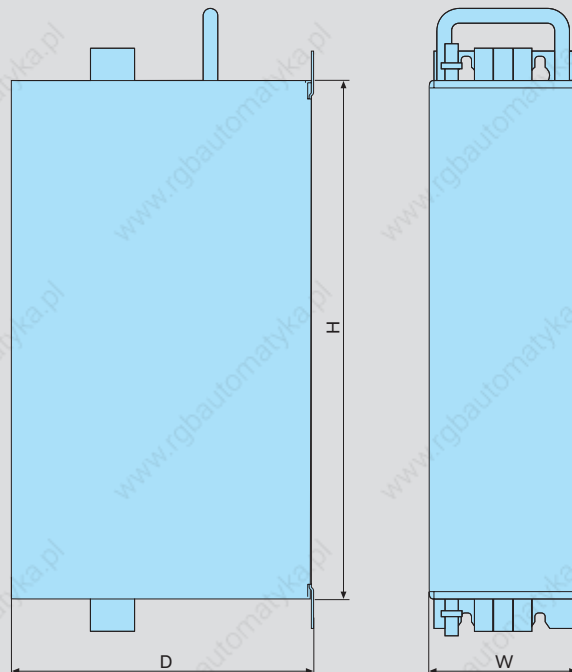

Mains filters with integrated mains choke – for HCS03 converters

Mains filters with integrated mains choke	Continuous current	Power dissipation	Nominal inductance	Capacitance	Width W	Height H	Depth D	Mass
	A	W	μH	μF	mm	mm	mm	kg
HNK01.1A-A075-E0050-A-500-NNNN	50	50	3 x 571	3 x 1.1	125	322.5	251.5	15
HNK01.1A-A075-E0080-A-500-NNNN	80	80	3 x 362	3 x 2.2	225	310	270	20
HNK01.1A-A075-E0106-A-500-NNNN	106	110	3 x 240	3 x 2.2	225	310	270	20
HNK01.1A-A075-E0146-A-500-NNNN	146	130	3 x 170	3 x 2.2	350	380	270	28

All data applies to nominal rating at 3 AC 400 V mains voltage. Please see the selection tables on the end of this chapter for exact assignments to the power units.

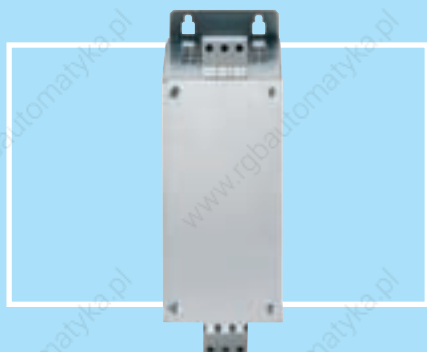

The combination of mains filter and mains choke in one unit simplifies assembly and installation. It is simply fitted underneath the converter to form one space-saving unit. It is also a particularly easy way to comply with the directives contained in EN 61800-3, Class A, Group 2.

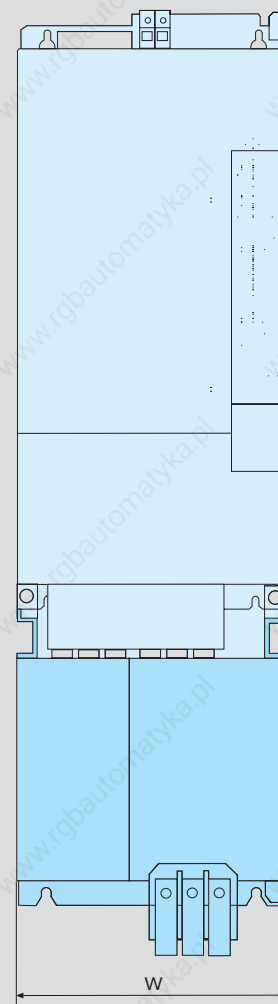
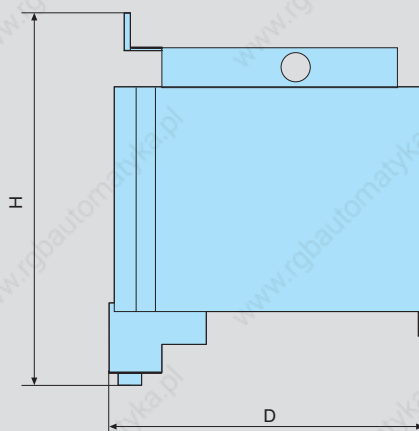

Example of assembly

Mains chokes – for HMV power supply units and HCS converters

Mains choke	Continuous current	Power dissipation	Nominal inductance	Capacitance	Width W	Height H	Depth D	Mass
	A	W	μH	μF	mm	mm	mm	kg
HNL01.1E-1000-N0012-A-500-NNNN	12	40	3 x 1,000	–	120	164	61	2.7
HNL01.1E-1000-N0020-A-500-NNNN	20	60	3 x 1,000	–	150	184	66.5	3.8
HNL01.1E-0600-N0032-A-500-NNNN	32	75	3 x 600	–	150	184	66.5	4.5
HNL01.1E-0400-N0051-A-480-NNNN	51	165	3 x 400	–	180	225	112	13.5
HNL01.1E-0200-N0125-A-480-NNNN	125	170	3 x 200	–	230	295	148	24
HNL01.1E-0100-N0202-A-480-NNNN	202	200	3 x 100	–	265	350	152	33
HNL01.1R-0980-C0026-A-480-NNNN	26	225	3 x 980	3 x 10	210	245	172	16
HNL01.1R-0590-C0065-A-480-NNNN	65	310	3 x 590	3 x 20	300	360	205	45
HNL01.1R-0540-C0094-A-480-NNNN	94	420	3 x 540	3 x 20	340	385	229	65
HNL01.1R-0300-C0180-A-480-NNNN	180	800	3 x 300	3 x 30	340	400	261	73
HNL02.1R-0980-C0023-A-480-NNNN	23	95	3 x 980	3 x 10	165	352	115	14
HNL01.1E-0571-N0050-A-500-NNNN	50	50	3 x 571	–	183	238	100	13
HNL01.1E-0362-N0080-A-500-NNNN	80	80	3 x 362	–	205	175	180	17
HNL01.1E-0240-N0106-A-500-NNNN	106	100	3 x 240	–	205	193	210	17
HNL01.1E-0170-N0146-A-500-NNNN	146	130	3 x 170	–	250	205	230	23

All data applies to nominal rating at 3 AC 400 V mains voltage. Please see the selection tables on the end of this chapter for exact assignments to the power units.

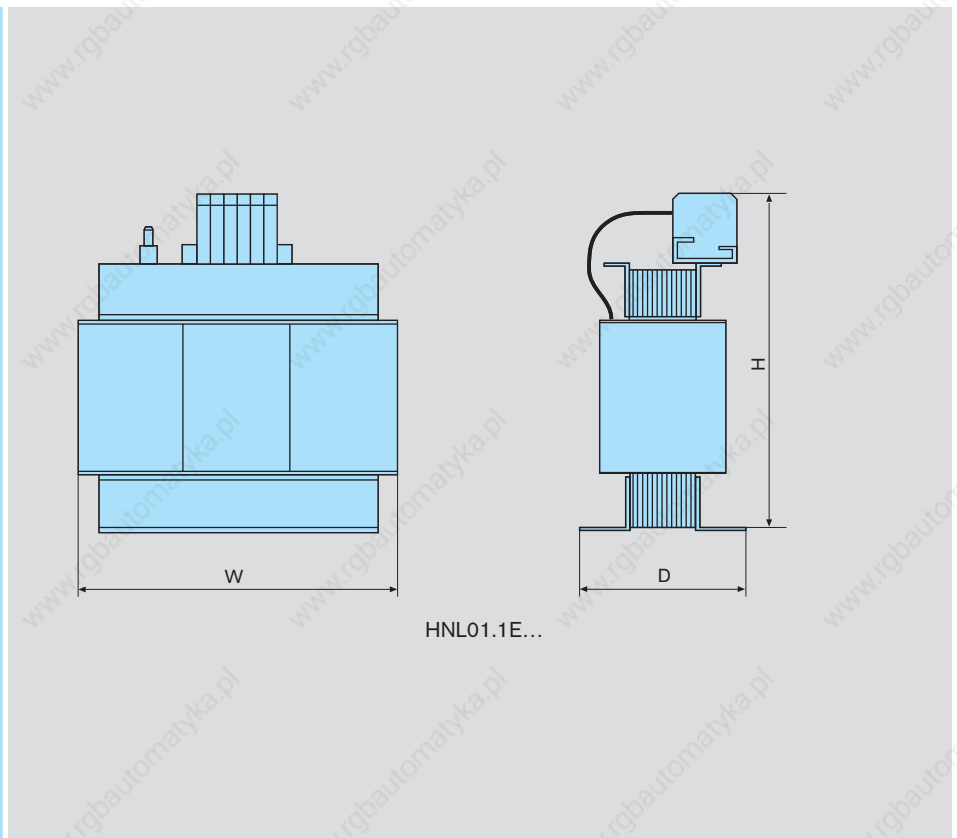

In connection with the mains chokes, converters and infeed power supply units realize higher DC bus continuous power. They reduce the harmonics in the line current while simultaneously preventing circuit feedback.

When using supply units with line regeneration, these components are always required.

This combination always complies to the permissible EMC values for industrial networks stipulated by EN 61000-2-4.

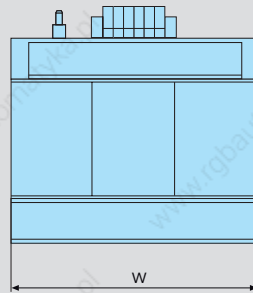

HNL01.1R...

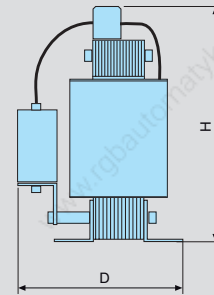

HNL02.1R...

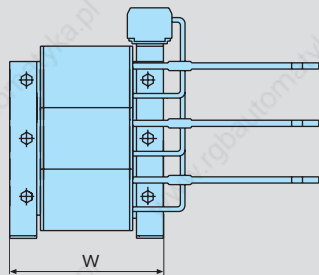
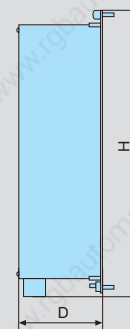

HNL01.1E-0571...

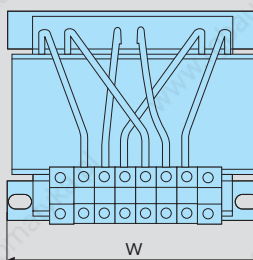
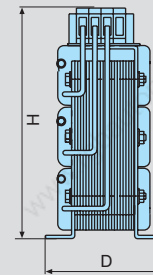

HNL01.1E-0362... to HNL01.1E-0170...

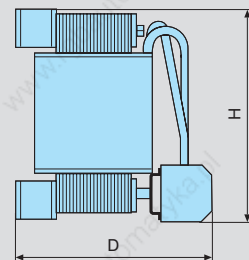

Motor filters – for HCS converters

Motor filter	Continuous current	Power dissipation	Inductance	Width W	Height H	Depth D	Mass
	A	W	μH	mm	mm	mm	kg
HMF01.1N-N0K2-M0012-A-500-NNNN	12	in prep.	3 x 900	155	162	92	5
HMF01.1N-N0K2-M0028-A-500-NNNN	28	in prep.	3 x 450	210	182	130	11
HMF01.1A-N0K2-D0045-A-500-NNNN	45	120	3 x 160	125	330	270	15
HMF01.1A-N0K2-D0073-A-500-NNNN	72	160	3 x 100	225	315	270	20
HMF01.1A-N0K2-D0095-A-500-NNNN	95	190	3 x 78	225	315	270	20
HMF01.1A-N0K2-D0145-A-500-NNNN	145	220	3 x 50	350	400	260	38

All data applies to nominal rating at 3 AC 400 V mains voltage and 4 kHz clock frequency. The maximum output frequency is 200 Hz. Please see the selection tables on the end of this chapter for exact assignments to the power units.



The combination of the steep switching curves of modern converters and long motor wires can often cause transient overvoltages on the motor terminals. This, along with the leakage current of the motor wires, can be reduced by using a motor filter on the inverter output.

This has the following advantages:

- Voltage rise limited to values below 1 kV/ μs
- Winding insulation protected by limiting the voltage peak to max. 1,000 V
- Operation of several motors connected in parallel on one frequency converter via long supply lines
- Compliance with increased EMC requirements thanks to reduced interference voltages

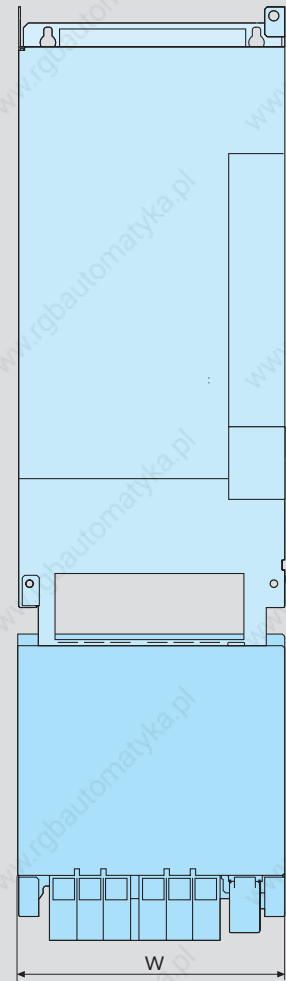
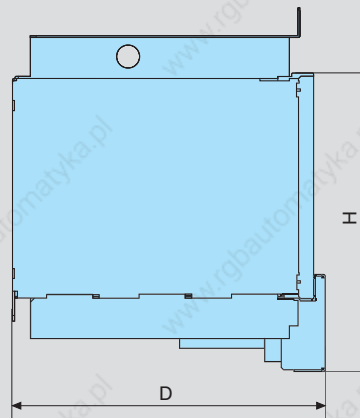

Example of assembly for HMF...D0045 to ...D0145

Brake resistors – for HCS converters

Braking resistor	Maximum energy consumption	Braking power				Resistance	Width W	Height H	Depth D	Mass
		Duration	max.	t _{on} time	t _{cycle} time					
	kWs	kW	kW	s	s	Ω	mm	mm	mm	kg
HLR01.1N-0300-N17R5-A-007-NNNN	37	0.30	37	1	120	20.5	123	300	196	3
HLR01.1N-0470-N11R7-A-007-NNNN	56	0.47	56	1	120	13.7	223	300	210	4.5
HLR01.1N-0780-N07R0-A-007-NNNN	93	0.78	93	1	120	8.2	223	300	210	5.5
HLR01.1N-1K08-N05R0-A-007-NNNN	130	1.08	130	1	120	5.8	350	300	220	8

Please see the selection tables on the end of this chapter for exact assignments to the power units.



When using the HCS03 converters in regenerative operation there is a choice of particularly compact brake resistors for various different levels of power consumption.

The brake resistor is mounted directly above the converter. This space-saving arrangement also simplifies the installation work. At the same time the converter's extracted air flow makes an effective cooling system.

The robust construction and high dielectric strength of the resistor elements enables high power and impulse loading. The resistor elements are flame-proof and are protected from harmful environmental factors by their full encapsulation.

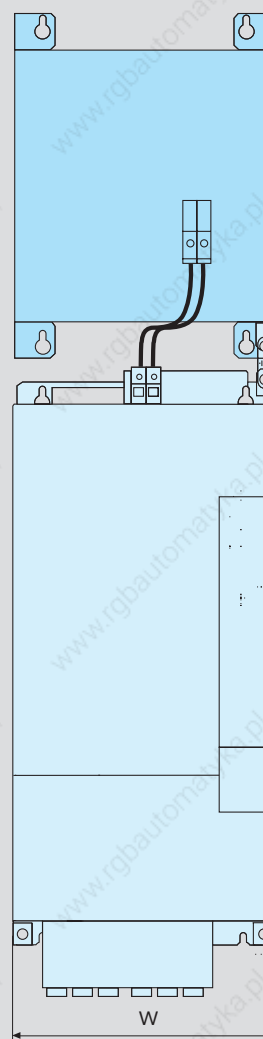
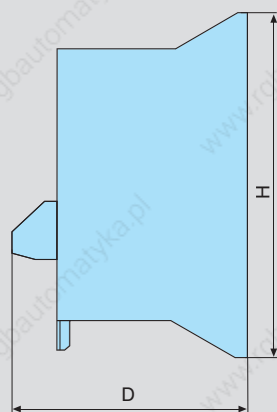

Example of assembly

Brake resistors, heavy-duty version – for HCS converters

Brake resistor	Maximum energy consumption	Brake power				Resistance	Type	Width W	Height H	Depth T	Mass
		Duration	max.	t _{on} time	t _{cycle} times						
	kWs	kW	kW	s	s	Ω	mm	mm	mm	kg	
HLR01.1N-01K8-N40R0-A-007-NNNN	72	1.8	18	4	120	40.0	–	in prep.	in prep.	in prep.	in prep.
HLR01.1N-03K8-N40R3-A-007-NNNN	300	3.8	18	16.7	120	40.3	–	in prep.	in prep.	in prep.	in prep.
HLR01.1N-02K4-N28R0-A-007-NNNN	100	2.4	26	3.9	120	28.0	–	in prep.	in prep.	in prep.	in prep.
HLR01.1N-05K5-N28R2-A-007-NNNN	420	5.5	26	16.2	120	28.2	–	in prep.	in prep.	in prep.	in prep.
HLR01.1N-01K6-N18R0-A-007-NNNN	109	1.6	34	3.3	120	20.0	A	185	586	120	5.2
HLR01.1N-03K5-N19R0-A-007-NNNN	252	3.5	31	8	120	21.3	B	300	270	490	9.5
HLR01.1N-04K5-N18R0-A-007-NNNN	432	4.5	33	13	120	20.2	B	400	270	490	13
HLR01.1N-06K5-N18R0-A-007-NNNN	686	6.5	33	21	120	20.2	B	400	270	490	13
HLR01.1N-10K0-N18R0-A-007-NNNN	1,080	10	33	32	120	20.2	B	600	270	490	22
HLR01.1N-02K0-N15R0-A-007-NNNN	137	2	40	3.4	120	16.7	A	185	686	120	6.2
HLR01.1N-05K0-N15R0-A-007-NNNN	360	5	40	9	120	16.9	B	400	270	490	13
HLR01.1N-07K0-N14R0-A-007-NNNN	672	7	43	16	120	15.7	B	600	270	490	22
HLR01.1N-09K5-N13R0-A-007-NNNN	1,003	9.5	46	22	120	14.6	B	600	270	490	22
HLR01.1N-14K5-N13R0-A-007-NNNN	1,566	14.5	46	34	120	14.6	B	800	270	490	33
HLR01.1N-04K5-N07R4-A-007-NNNN	246	4.5	81	3	120	8.3	B	300	270	490	9.5
HLR01.1N-08K5-N08R0-A-007-NNNN	612	8.5	75	8.2	120	9.0	B	600	270	490	22
HLR01.1N-11K0-N07R3-A-007-NNNN	1,056	11	82	13	120	8.2	B	600	270	490	22
HLR01.1N-15K0-N08R1-A-007-NNNN	1,584	15	74	21	120	9.1	B	800	270	490	33
HLR01.1N-24K0-N07R2-A-007-NNNN	2,592	24	83	31	120	8.1	C	795	710	490	80
HLR01.1N-06K5-N06R1-A-007-NNNN	356	6.5	98	3.6	120	6.9	B	400	270	490	13
HLR01.1N-12K5-N05R5-A-007-NNNN	900	12.5	109	8.3	120	6.2	B	800	270	490	33
HLR01.1N-17K0-N05R1-A-007-NNNN	1,632	17	117	14	120	5.7	B	1,000	270	490	43
HLR01.1N-23K0-N05R5-A-007-NNNN	2,429	23	109	22	120	6.2	C	595	710	490	56
HLR01.1N-36K0-N05R4-A-007-NNNN	3,888	36	111	35	120	6.1	C	995	710	490	93

Please see the selection tables on the end of this chapter for exact assignments to the power units.

The heavy-duty version of the brake resistor must always be used in applications where high regeneration occurs over a relatively long period of time. This is the case, for example, when lowering large loads or when braking high mass moments of inertia.

Depending on the braking power required there is a choice of compact brake resistors of different power levels and designs for each converter.

Type A

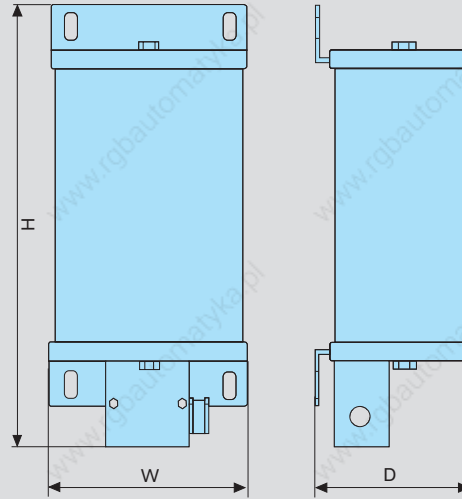

Type B

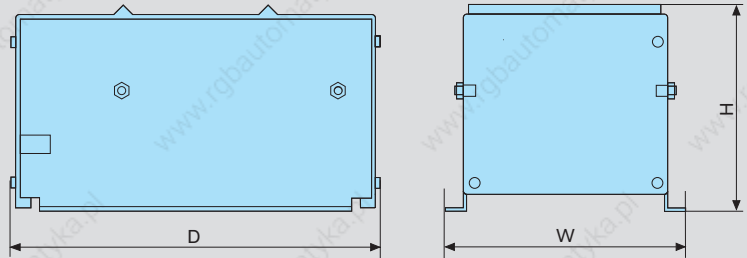

Type C

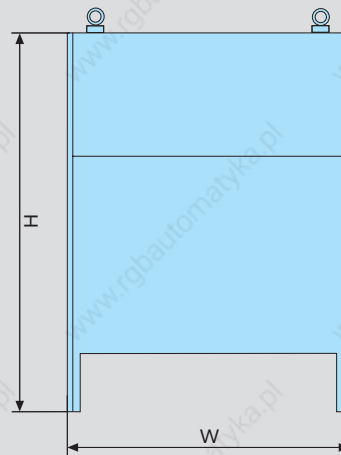

$D = 490 \text{ mm}$

Brake units – for HMV power supply units and HCS converters

Brake units	Maximum energy consumption	Brake power				Width W	Height H	Depth D	Mass
		Duration	max.	t_{on} time	t_{cycle} times				
	kWs	kW	kW	s	s	mm	mm	mm	kg
HLB01.1C-01K0-N06R0-A-007-NNNN	100	1	100	5	100	65	352	251.5	5.8
HLB01.1D-02K0-N03R4-A-007-NNNN	500	2	100	1	250	100	440	309	12.2

Please see the selection tables on the end of this chapter for exact assignments to the power units.



The connection of brake units increases the continuous and peak regenerative power.

The brake unit also makes it possible to have the DC bus short circuit function available in the drive system.

This function makes it possible to brake the synchronous motors even in the event of a power failure.

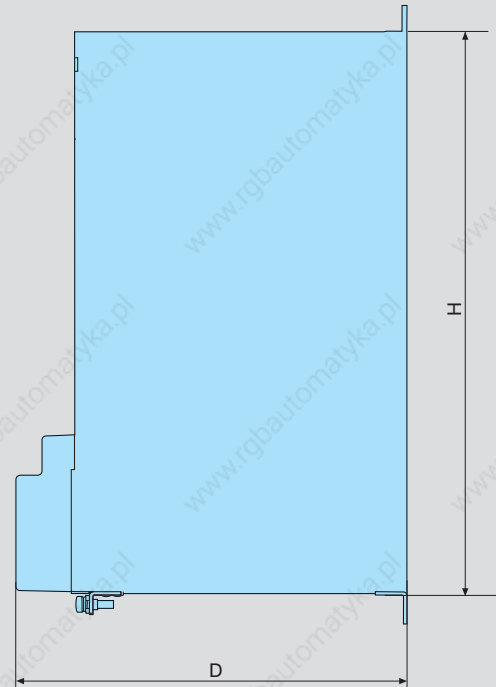
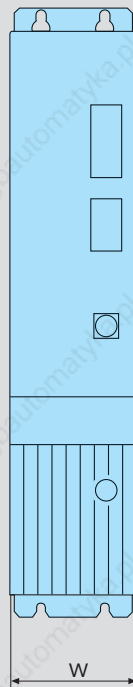

Capacity modules – for H MV power supply units and HCS converters

Capacity modules	Capacitance	Width W	Height H	Depth D	Mass
	mF	mm	mm	mm	kg
HLC01.1C-01M0-A-007-NNNN	1	50	352	251.5	3.2
HLC01.1C-02M4-A-007-NNNN	2.4	50	352	251.5	4.3
HLC01.1D-05M0-A-007-NNNN	5	75	440	309	8.6

Please see the selection tables on the end of this chapter for exact assignments to the power units.



Capacity modules improve the energy balance in applications where machining cycles take place in rapid succession, such as roll feeds or cross cutting lines.

Connected to the DC bus, the capacity modules act as a temporary energy storage unit and reduce the heat loss in the control cabinet by relieving the braking resistor.

In the event of a power failure the reserve energy enables a controlled retraction motion. This protects the workpiece and the tool, e.g. in gear cutting machines.

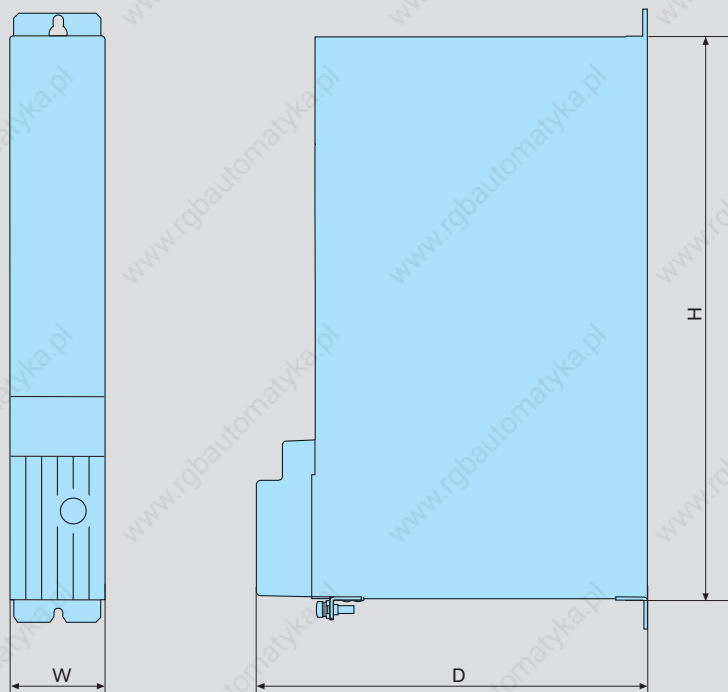

Additional fan – for HVM supply units and HMS inverters

Blower unit	Width W	Height H	Depth D	Mass
	mm	mm	mm	kg
HAB01.1-0350-1640-NN	350	308	152	7.5



The additional fan HAB01 is required for operating the supply unit HVM01.1R-W0120 and the inverter HMS01.1N-W0350. In a space-saving arrangement, it is mounted directly below the unit. The electrical connection is made by a simple plug-in connector.

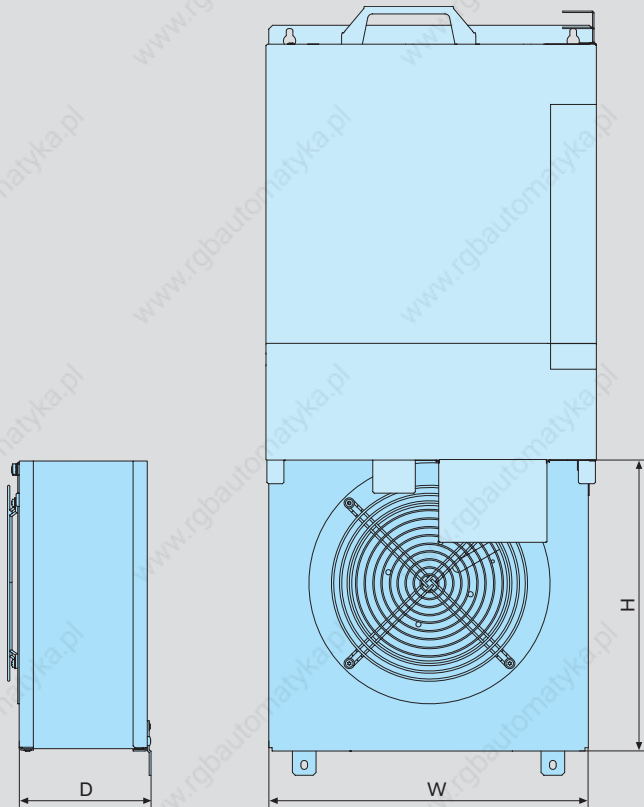

Other accessories



Basic accessories HAS01

The basic accessories contain all the mounting parts and fixing elements. Depending on the application, we supply these accessories complete with all the connecting bars for control voltage and DC bus.



Shield connection HAS02

The shield connection plate is an EMC-compatible method of connecting the motor cable to your control unit. It also serves as a cord grip.

Control cabinet adapter HAS03

The control cabinet adapters are used to combine HCS02 converters and their auxiliary components options, HLB brake unit and HLC expansion capacitor, with units from the IndraDrive M series. Spacer bolts can be used to even out the lower unit depth thus creating an even frontage with a uniform installation height.

Auxiliary capacitor HAS04

Use the additional capacitor HAS04 to operate HCS02 and HCS03 inverters with an HNF mains filter even if the minimum number of attached control units is not reached.

Electrical adapters HAS05

- HAS05.1-001 Use the HAS05.1-001-NNN-NN adapter to connect a HNK mains filter or a HMF motor filter to an HCS03.1E-W0070 converter.
- HAS05.1-002 If you install both – mains filter and motor filter please use the HAS05.1-002-NNN-NN adapter.
- HAS05.1-003 You can use the HAS05.1-003 signal level converter to adjust the voltage level of the encoder emulation signals to your application. Signal levels can be adjusted between 5 and 30 volts. The signal level converter is simply connected to the D-Sub connector of the control unit.
- HAS05.1-004 You can use the HAS05.1-004 DC bus adapter to supply power to inverter units without using the standard connecting bars. Cables with a cross-section of up to 2 x 50 mm² per phase can be used.
- HAS05.1-005 The HAS05.1-005 signal level converter enables you to add RS485 connectivity to your IndraDrive. Pre-assembled cables are available to connect the level converter to the RS232 port of the control unit. The converters can either be clipped on to a DIN rail or attached directly to the mounting plate.

Module bus extension RKB0001

All the control units are fitted with a bus cable – matched to the respective unit width – to transmit the control signals.

Where there are relatively large distances between individual control units we can supply the necessary module bus extensions. These come in various lengths ranging from 0.5 m and 40 m.

Auxiliary components – cross reference

Components	HMV01.1E- W0030	HMV01.1E- W0075	HMV01.1E- W0120	HMV01.1R- W0018	HMV01.1R- W0045	HMV01.1R- W0065	HMV01.1R- W0120	HMV02.1R- W0015	HCS02.1E- W0012	HCS02.1E- W0028	HCS02.1E- W0064	HCS03.1E- W0070	HCS03.1E- W0070	HCS03.1E- W0100	HCS03.1E- W0150	HCS03.1E- W0210
------------	--------------------	--------------------	--------------------	--------------------	--------------------	--------------------	--------------------	--------------------	--------------------	--------------------	--------------------	--------------------	--------------------	--------------------	--------------------	--------------------

Mains filter HNF

HNF01.1A-F240-E0051-A-480-NNNN	12/280												6/240 ²⁾			
HNF01.1A-M900-E0051-A-480-NNNN	21/1050								12/900 ¹⁾		12/900 ¹⁾²⁾	12/900 ²⁾	12/900 ²⁾			
HNF01.1A-F240-E0125-A-480-NNNN		12/280													6/240 ²⁾	
HNF01.1A-M900-E0125-A-480-NNNN		21/1050													12/900 ²⁾	
HNF01.1A-F240-E0202-A-480-NNNN			12/280													6/240 ²⁾
HNF01.1A-M900-E0202-A-480-NNNN			21/1050													12/900 ²⁾
HNF01.1A-A075-E0235-A-500-NNNN																
HNF01.1A-A075-E0309-A-500-NNNN																
HNF01.1A-F240-R0026-A-480-NNNN				12/280						6/240 ¹⁾		6/240 ²⁾	6/240 ²⁾			
HNF01.1A-M900-R0026-A-480-NNNN				21/1050						12/900 ¹⁾		12/900 ²⁾	12/900 ²⁾			
HNF01.1A-F240-R0065-A-480-NNNN					12/280											
HNF01.1A-M900-R0065-A-480-NNNN					21/1050											
HNF01.1A-F240-R0094-A-480-NNNN						12/280									6/240 ²⁾	
HNF01.1A-M900-R0094-A-480-NNNN						21/1050									12/900 ²⁾	
HNF01.1A-H350-R0180-A-480-NNNN							8/350									

Mains filter HNS

HNS02.1A-Q200-R0023-A-480-NNNN								12/200 ¹⁾								
--------------------------------	--	--	--	--	--	--	--	----------------------	--	--	--	--	--	--	--	--

Mains filter NFD03

NFD03.1-480-007									6/120 ¹⁾							
NFD03.1-480-016									6/120 ¹⁾							
NFD03.1-480-030									6/120 ¹⁾		6/120 ²⁾	6/120 ²⁾				
NFD03.1-480-055									6/120 ¹⁾		6/120 ²⁾	6/120 ²⁾				
NFD03.1-480-075									6/120 ¹⁾		6/120 ²⁾	6/120 ²⁾				

Notes: 12/280 = mains filter for up to 12 drives and a maximum motor cable length of 280 m. These values must be reviewed for each application. Additional components may be necessary.

Regardless of the number of axes, the effective total mains current must not exceed the maximum current rating of the mains filter.

The maximum length might be different in case of open-loop mode or when using unshielded cables.

¹⁾recommended values for group supply without DC bus connection, the maximum cable length for single drives is 75 m.

²⁾recommended values for central supply: one inverter supplies power to other inverters, the maximum cable length for single drives is 75 m.

Mains filter with integrated HNK mains choke

HNK01.1A-A075-E0050-A-500-NNNN													1/75			
HNK01.1A-A075-E0080-A-500-NNNN														1/75		
HNK01.1A-A075-E0106-A-500-NNNN															1/75	
HNK01.1A-A075-E0146-A-500-NNNN																1/75

Notes: 1/75 = mains filter for one drive, maximum motor cable length 75 m. These values must be reviewed for each application. Additional components may be necessary.

The effective mains current must not exceed the maximum current rating of the mains filter.

The maximum length might be different in case of open-loop mode or when using unshielded cables.

Components	HMV01.1E- W0030	HMV01.1E- W0075	HMV01.1E- W0120	HMV01.1R- W0018	HMV01.1R- W0045	HMV01.1R- W0065	HMV01.1R- W0120	HMV02.1R- W0015	HCS02.1E- W0012	HCS02.1E- W0028	HCS02.1E- W0054	HCS03.1E- W0070	HCS03.1E- W0100	HCS03.1E- W0150	HCS03.1E- W0210
------------	--------------------	--------------------	--------------------	--------------------	--------------------	--------------------	--------------------	--------------------	--------------------	--------------------	--------------------	--------------------	--------------------	--------------------	--------------------

Mains choke HNL															
HNL01.1E-0400-N0051-A-480-NNNN	•														
HNL01.1E-0200-N0125-A-480-NNNN		•													
HNL01.1E-0100-N0202-A-480-NNNN			•												
HNL01.1R-0980-C0026-A-480-NNNN				•											
HNL01.1R-0590-C0065-A-480-NNNN					•										
HNL01.1R-0540-C0094-A-480-NNNN						•									
HNL01.1R-0300-C0180-A-480-NNNN							•								
HNL01.1E-1000-N0012-A-500-NNNN									•	•					
HNL01.1E-1000-N0020-A-500-NNNN											•				
HNL01.1E-0600-N0032-A-500-NNNN												•			
HNL01.1E-0571-N0050-A-500-NNNN													•		
HNL01.1E-0362-N0080-A-500-NNNN														•	
HNL01.1E-0240-N0106-A-500-NNNN															•
HNL01.1E-0170-N0146-A-500-NNNN															•
HNL02.1R-0980-C0023-A-480-NNNN								•							

The effective total mains current of your application must not exceed the maximum rated current of the mains choke.

Motor filter HMF															
HMF01.1N-NOK2-M0012-A-500-NNNN									•	•					
HMF01.1N-NOK2-M0028-A-500-NNNN											•	•			
HMF01.1A-NOK2-D0045-A-500-NNNN												•			
HMF01.1A-NOK2-D0073-A-500-NNNN													•		
HMF01.1A-NOK2-D0095-A-500-NNNN														•	
HMF01.1A-NOK2-D0145-A-500-NNNN															•

Auxiliary components – cross reference

Components	HCS02.1E-W0054	HCS02.1E-W0070	HCS03.1E-W0070	HCS03.1E-W0100	HCS03.1E-W0150	HCS03.1E-W0210
Brake resistor HLR						
HLR01.1N-01K8-N40R0-A-007-NNNN	○					
HLR01.1N-03K8-N40R3-A-007-NNNN	○					
HLR01.1N-02K4-N28R0-A-007-NNNN		○				
HLR01.1N-05K4-N28R2-A-007-NNNN		○				
HLR01.1N-0300-N17R5-A-007-NNNN			●			
HLR01.1N-01K6-N18R0-A-007-NNNN			○			
HLR01.1N-03K5-N19R0-A-007-NNNN			○			
HLR01.1N-04K5-N18R0-A-007-NNNN			○			
HLR01.1N-06K5-N18R0-A-007-NNNN			○			
HLR01.1N-10K0-N18R0-A-007-NNNN			○			
HLR01.1N-0470-N11R7-A-007-NNNN				●		
HLR01.1N-02K0-N15R0-A-007-NNNN				○		
HLR01.1N-05K0-N15R0-A-007-NNNN				○		
HLR01.1N-07K0-N14R0-A-007-NNNN				○		
HLR01.1N-09K5-N13R0-A-007-NNNN				○		
HLR01.1N-14K5-N13R0-A-007-NNNN				○		
HLR01.1N-0780-N07R0-A-007-NNNN					●	
HLR01.1N-04K5-N07R4-A-007-NNNN					○	
HLR01.1N-08K5-N08R0-A-007-NNNN					○	
HLR01.1N-11K0-N07R3-A-007-NNNN					○	
HLR01.1N-15K0-N08R1-A-007-NNNN					○	
HLR01.1N-24K0-N07R2-A-007-NNNN					○	
HLR01.1N-1K08-N05R0-A-007-NNNN						●
HLR01.1N-06K5-N06R1-A-007-NNNN						○
HLR01.1N-12K5-N05R5-A-007-NNNN						○
HLR01.1N-17K0-N05R1-A-007-NNNN						○
HLR01.1N-23K0-N05R5-A-007-NNNN						○
HLR01.1N-36K0-N05R4-A-007-NNNN						○

● Standard version ○ Heavy-duty version

Components	HMV01.1E-W0030	HMV01.1E-W0075	HMV01.1E-W0120	HMV01.1R-W0018	HMV01.1R-W0045	HMV01.1R-W0065	HMV01.1R-W0120	HMV02.1R-W0015	HMS01.1N-W0020	HMS01.1N-W0036	HMS01.1N-W0054	HMS01.1N-W0070	HMS01.1N-W0110	HMS01.1N-W0150	HMS01.1N-W0210	HMS01.1N-W0350	HMS02.1N-W0028	HMS02.1N-W0054	HMD01.1N-W0012	HMD01.1N-W0020	HMD01.1N-W0036	HCS02.1E-W0012	HCS02.1E-W0028	HCS02.1E-W0054	HCS02.1E-W0070	HCS03.1E-W0070	HCS03.1E-W0100	HCS03.1E-W0150	HCS03.1E-W0210
------------	----------------	----------------	----------------	----------------	----------------	----------------	----------------	----------------	----------------	----------------	----------------	----------------	----------------	----------------	----------------	----------------	----------------	----------------	----------------	----------------	----------------	----------------	----------------	----------------	----------------	----------------	----------------	----------------	----------------

Brake unit HLB																														
HLB01.1C-01K0-N06R0-A-007-NNNN	○	○	○	○	○	○	○	●																●	●	●	○	○	○	○
HLB01.1D-02K0-N06R0-A-007-NNNN	●	●	●	●	●	●	●																○	○	○	○	●	●	●	●

○ With control cabinet adapter HAS03 to even out the different unit depths

Capacity module HLC																													
HLC01.1C-01M0-A-007-NNNN	○	○	○	○	○	○	○	●																					○
HLC01.1C-02M4-A-007-NNNN	○	○	○	○	○	○	○	●																					○
HLC01.1D-05M0-A-007-NNNN	●	●	●	●	●	●	●																○	○	○				●

○ With control cabinet adapter HAS03 to even out the different unit depths

Basic accessories HAS01																														
HAS01.1-050-072-MN																														
HAS01.1-065-072-CN																														
HAS01.1-065-NNN-CN																														
HAS01.1-075-072-MN																														
HAS01.1-100-072-MN																														
HAS01.1-105-072-CN																														
HAS01.1-105-NNN-CN																														
HAS01.1-125-072-CN																														
HAS01.1-125-072-MN																														
HAS01.1-125-NNN-CN																														
HAS01.1-150-072-MN	●																													
HAS01.1-150-NNN-MN	●																													
HAS01.1-150-NNN-M2																														
HAS01.1-175-072-MN																														
HAS01.1-175-NNN-MN																														
HAS01.1-200-072-MN																														
HAS01.1-225-072-CN																														
HAS01.1-225-NNN-CN																														
HAS01.1-250-072-MN																														
HAS01.1-250-NNN-MN																														
HAS01.1-350-072-MN																														
HAS01.1-350-NNN-CN																														
HAS01.1-350-NNN-MN																														

Auxiliary components – cross reference

Components	HMS01.1N-W0020	HMS01.1N-W0036	HMS01.1N-W0054	HMS01.1N-W0070	HMS01.1N-W0110	HMS01.1N-W0150	HMS01.1N-W0210	HMS01.1N-W0350	HMS02.1N-W0028	HMS02.1N-W0054	HMD01.1N-W0012	HMD01.1N-W0020	HMD01.1N-W0036	HCS02.1E-W0012	HCS02.1E-W0028	HCS02.1E-W0054	HCS02.1E-W0070	HCS03.1E-W0070	HCS03.1E-W0100	HCS03.1E-W0150	HCS03.1E-W0210	HNK01.1A-...-E0050	HNK01.1A-...-E0080	HNK01.1A-...-E0106	HNK01.1A-...-E0146	KCU01.2N
------------	----------------	----------------	----------------	----------------	----------------	----------------	----------------	----------------	----------------	----------------	----------------	----------------	----------------	----------------	----------------	----------------	----------------	----------------	----------------	----------------	----------------	--------------------	--------------------	--------------------	--------------------	----------

Shield connection HAS02																											
HAS02.1-001-NNN-NN	•	•	•	•																							
HAS02.1-002-NNN-NN									•	•	•	•	•	•	•	•											
HAS02.1-003-NNN-NN					•	•	•																				
HAS02.1-004-NNN-NN																	•										
HAS02.1-005-NNN-NN																		•	•								
HAS02.1-006-NNN-NN																					•						
HAS02.1-007-NNN-NN																						•	•				
HAS02.1-008-NNN-NN																					•						
HAS02.1-009-NNN-NN																										•	
HAS02.1-010-NNN-NN									•																		
HAS02.1-011-NNN-NN								•																			
HAS02.1-014-NNN-NN																											•
HAS02.1-015-NNN-NN																											•

Components	HCS02.1E-W0012	HCS02.1E-W0028	HCS02.1E-W0054	HCS02.1E-W0070	HLB01.1C	HLC01.1C
------------	----------------	----------------	----------------	----------------	----------	----------

Control cabinet adapter HAS03						
HAS03.1-002-NNN-NN	•	•			•	•
HAS03.1-004-NNN-NN			•	•		

Components	HCS02.1E-W0012	HCS02.1E-W0028	HCS02.1E-W0054	HCS02.1E-W0070	HCS03.1E-W0070	HCS03.1E-W0100	HCS03.1E-W0150	HCS03.1E-W0210
------------	----------------	----------------	----------------	----------------	----------------	----------------	----------------	----------------

Auxiliary capacitor HAS04								
HAS04.1-001-NNN-NN		•	•	•				
HAS04.1-002-NNN-NN					•	•	•	•

Only required in combination with mains filter HNF or if power is supplied to other HMS01 inverters.

Components	HMV01.1E-W0030	HMV01.1E-W0075	HMV01.1E-W0120	HMV01.1R-W0018	HMV01.1R-W0045	HMV01.1R-W0065	HMV01.1R-W0120	HMV02.1R-W0015	HMS01.1N-W0020	HMS01.1N-W0036	HMS01.1N-W0054	HMS01.1N-W0070	HMS01.1N-W0110	HMS01.1N-W0150	HMS01.1N-W0210	HMS01.1N-W0350	HMS02.1N-W0028	HMS02.1N-W0054	HMD01.1N-W0012	HMD01.1N-W0020	HMD01.1N-W0036
------------	----------------	----------------	----------------	----------------	----------------	----------------	----------------	----------------	----------------	----------------	----------------	----------------	----------------	----------------	----------------	----------------	----------------	----------------	----------------	----------------	----------------

Adapter HAS05 – DC bus connection																					
HAS05.1-004-NNL-NN	•	•	•	•	•	•	•	•	•	•	•	•	•	•	•	•	•	•	•	•	•
HAS05.1-004-NNR-NN	•	•	•	•	•	•	•	•	•	•	•	•	•	•	•	•	•	•	•	•	•

Components	BASIC OPEN LOOP CSB01.1N-FC	BASIC ANALOG CSB01.1N-AN	BASIC PROFIBUS CSB01.1N-PB	BASIC SERCOS CSB01.1N-SE	BASIC UNIVERSAL Single-axis CSB01.1C	BASIC UNIVERSAL Dual-axis CDB01.1C	ADVANCED CSH01.1C
------------	-----------------------------------	--------------------------------	----------------------------------	--------------------------------	---	---	----------------------

Adapter HAS05 – signal level converter							
HAS05.1-003-NNN-NN		•			• ¹⁾	• ¹⁾	• ¹⁾

¹⁾ for control units with MEM encoder emulation only

Adapter HAS05 – RS232/485 converter							
HAS05.1-005-NNN-NN	•	•	•	•	•	•	•

Adapter HAS05 – from the D-Sub 9-pole connector (X41) to the terminal							
HAS05.1-007-NNN-NN		• ¹⁾	• ¹⁾	• ¹⁾	• ¹⁾	• ¹⁾	• ¹⁾

¹⁾ for control units with Safety Technology option (L1, S1)

Components	HCS03.1E-W0070 with HMF motor filter	HCS03.1E-W0070 with HNK mains filter	HCS03.1E-W0070 with HMF motor filter and HNK mains filter
------------	---	---	--

Adapter HAS05 – connection accessories			
HAS05.1-001-NNN-NN	•	•	•
HAS05.1-002-NNN-NN			•

Auxiliary components – connection cables

Motor	Power unit	Power cable	Encoder cable
MSK030B-0900 MSK030C-0900 MSK040B-0450, -0600 MSK040C-0450, -0600 MSK050B-0300, -0450, -0600 MSK050C-0300, -0450, -0600 MSK060B-0300, -0600 MSK060C-0300, -0600 MSK061C-0200, -0300, -0600 MSK076C-0300, -0450	HMD01.1N-W0012 HMx01.1N-W0020 HMx01.1N-W0036 HCS02.1E-W0012 HCS02.1E-W0028	RKL4302	
MSK070C-0150, -0300, -0450 MSK070D-0150 MSK070E-0150 MSK071C-0200, -0300, -0450 MSK071D-0200, -0300, -0450 MSK071E-0200, -0300 MSK075C-0200, -0300, -0450 MSK075D-0200, -0300 MSK075E-0200, -0300	HMD01.1N-W0012 HMx01.1N-W0020 HMx01.1N-W0036 HCS02.1E-W0012 HCS02.1E-W0028	RKL4306	
	HMS01.1N-W0054 HMS01.1N-W0070 HCS02.1E-W0054 HCS02.1E-W0070 HCS03.1E-W0070	RKL4307	
	HMx01.1N-W0020 HMx01.1N-W0036 HCS02.1E-W0012 HCS02.1E-W0028	RKL4308	
MSK070D-0300, -0450 MSK070E-0300 MSK071E-0450 MSK075D-0450 MSK075E-0450	HMS01.1N-W0054 HMS01.1N-W0070 HCS02.1E-W0054 HCS02.1E-W0070 HCS03.1E-W0070	RKL4309	RKG4200
	HMS01.1N-W0110 HMS01.1N-W0150 HMS01.1N-W0210 HCS03.1E-W0100 HCS03.1E-W0150	RKL4310	
MSK070E-0450	HMS01.1N-W0054 HMS01.1N-W0070 HCS02.1E-W0054 HCS02.1E-W0070 HCS03.1E-W0070	RKL4314	
	HMS01.1N-W0110 HMS01.1N-W0150 HMS01.1N-W0210 HCS03.1E-W0100 HCS03.1E-W0150	RKL4315	
MSK100A-0200, -0300, -0400 MSK100B-0200 MSK100D-0200 MSK101C-0200	HMx01.1N-W0020 HMx01.1N-W0036 HCS02.1E-W0012 HCS02.1E-W0028	RKL4325	
	HMS01.1N-W0054 HMS01.1N-W0070 HCS02.1E-W0054 HCS02.1E-W0070 HCS03.1E-W0070	RKL4320	

Motor	Power unit	Power cable	Encoder cable
MSK100B-0300 MSK100C-0200, -0300 MSK100D-0300	HMx01.1N-W0020 HMx01.1N-W0036 HCS02.1E-W0012 HCS02.1E-W0028	RKL4326	RKG4200
	HMS01.1N-W0054 HMS01.1N-W0070 HCS02.1E-W0054 HCS02.1E-W0070 HCS03.1E-W0070	RKL4321	
	HMS01.1N-W0110 HMS01.1N-W0150 HMS01.1N-W0210 HCS03.1E-W0100 HCS03.1E-W0150	RKL4343	
MSK100B-0400 MSK100B-0450 MSK101C-0300, -0450	HMx01.1N-W0020 HMx01.1N-W0036 HCS02.1E-W0012 HCS02.1E-W0028	RKL4327	
	HMS01.1N-W0054 HMS01.1N-W0070 HCS02.1E-W0054 HCS02.1E-W0070 HCS03.1E-W0070	RKL4322	
	HMS01.1N-W0054 HMS01.1N-W0070 HCS02.1E-W0054 HCS02.1E-W0070 HCS03.1E-W0070	RKL4323	
MSK100C-0450 MSK101D-0200, -0300 MSK101E-0200 MSK131B-0200 MSK131D-0100	HMS01.1N-W0110 HMS01.1N-W0150 HMS01.1N-W0210 HCS03.1E-W0100 HCS03.1E-W0150	RKL4328	
	HMS01.1N-W0054 HMS01.1N-W0070 HCS02.1E-W0054 HCS02.1E-W0070 HCS03.1E-W0070	RKL4324	
	HMS01.1N-W0110 HMS01.1N-W0150 HMS01.1N-W0210 HCS03.1E-W0100 HCS03.1E-W0150	RKL4329	
MSK101D-0450 MSK101E-0300	HMS01.1N-W0054 HMS01.1N-W0070 HCS02.1E-W0054 HCS02.1E-W0070 HCS03.1E-W0070	RKL4344	
	HMS01.1N-W0110 HMS01.1N-W0150 HMS01.1N-W0210 HCS03.1E-W0100 HCS03.1E-W0150	RKL4330	
	HCS03.1E-W0210	RKL4333	
MSK131D-0200	HCS03.1E-W0210	RKL4349	

These tables are an extract from our extensive range of cables. Cables for other motors can be found in our documentation entitled "Connection cables – selection data". All specifications given relate to motors with natural convection.

Glossary

ADVANCED

Control units for maximum performance and dynamics with many configuration options

BASIC

Control units for standard applications

Basic accessories

All the mounting parts and hardware, and the connecting bars for the control voltage and DC bus

Brake chopper Brake transistor

Transistor which switches a brake resistor on and off

Brake resistor

For input power in regenerative operation (converted into heat)

Brake unit

All-in-one unit comprising brake resistor and braking transistor (brake chopper) used to increase the braking power

Braking power

Power which is recovered in regenerative operation of the motors

Capacity module

Optional auxiliary component used to increase the storable DC bus energy

CLOSED LOOP

Closed control loop (automatically regulated operation) in which the device being regulated is monitored using a measuring system and made available to the drive

Control cabinet adapter

Spacer bolts used to even out different unit depths

Control unit

The part of the drive unit comprising all the control functions and interfaces for installation in the power unit

Converter

Takes the mains voltage with its fixed amplitude and frequency and generates a three-phase alternating current with variable amplitude and frequency

DC bus voltage

DC voltage generated from the AC network and used to supply the power units; also serves as buffer storage for energy

Derating

Lowering of the specified data in the event of a change in operating conditions

EMC

Electromagnetic compatibility

Encoder cable

Cable used to connect the motor encoder to the encoder interface of the control unit

Firmware

Device-specific software for the drive functions

Functions library

Collection of function blocks conforming to IEC or PLCopen

IndraDrive

Converter or inverter, consisting of a power unit and a control unit, used to control servo or standard motors

IndraDrive C

Compact drive series, converter

IndraDrive M

Modular drive series, inverter and power supply units

IndraDrive Mi

Motor-integrated drive series – Inverter, control unit and synchronous servo motor in one unit

IndraDyn A

Air-cooled or liquid-cooled asynchronous servo motors

IndraDyn H

High-speed frameless (kit) motors

IndraDyn L

Synchronous linear motors

IndraDyn S

Synchronous servo motors, also for potentially explosive areas

IndraDyn T

Synchronous frameless (kit) torque motors

IndraMotion MLD

Integrated automation solution comprising drive functions, motion control and processing logic

IndraSize

Software tool used for sizing and selecting drives based on the machine data

IndraWorks

Engineering software toolkit for project planning, parameterization, start-up, diagnostics, etc.

Inverter

Takes the DC bus voltage and generates a three-phase alternating current with variable amplitude and frequency

M Mains choke	Used to increase the continuous DC bus output and to suppress harmonics
Mains filter	EMC filters for power supply units and converters used to reduce circuit feedback
Module bus	Bus connection between power units for exchanging internal control signals
Module bus extension	Optional bus connection used to bridge larger than average distances between individual drive control units
Motion Logic	Integrated automation solution comprising drive functions, motion control and processing logic
Motor filter	Used to protect the motor winding from extreme voltage rises
OPEN LOOP	Open control loop (controlled operation) in which the device being controlled is not monitored using measuring techniques
P Power cable	Cable for connecting the motor to the power unit
Power supply unit	Takes the mains voltage with fixed amplitude and frequency and generates a DC bus voltage
Power unit	The part of the drive control unit containing the power electronics to control the motors, used to hold the control unit
R Regeneration	Recirculation of the energy into the supply network during regenerative operation of the drive
S Safety on Board	Safety technology integrated in the drive, certified as complying with EN 954-1, Category 3
Shield connection	Connection plate for EMC-compatible connection of the motor cable to the control unit
Software module	MultiMedia Card for simple transmission of axis-oriented drive parameters without the use of a PC

T Switching frequency	Clock frequency of the pulse width modulation (PWM)
Technology package	Process-oriented function blocks, e.g. tension control
U User library	Collection of function blocks developed by the user
User program	Application-specific combination of different function blocks / technology packages

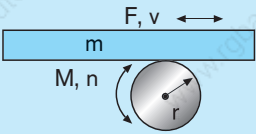
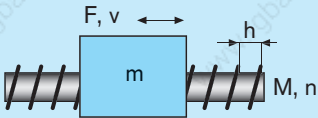
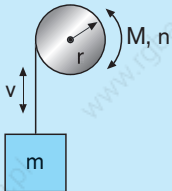
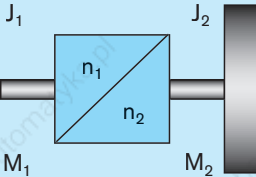

Formulas

	Speed	Torque	Output	Mass moment of inertia
Roller, wheel and pinion drive 	$n = \frac{v}{2 \cdot r \cdot \pi}$	$M = F \cdot r$	$P = \frac{F \cdot v}{60}$	$J = m \cdot r^2$
Ball screw drive 	$n = \frac{v \cdot 1000}{h}$	$M = \frac{F \cdot h}{2 \cdot \pi \cdot 1000}$	$P = \frac{F \cdot v}{60}$	$J = m \cdot \left(\frac{h}{2 \cdot \pi \cdot 1000} \right)^2$
Pulley drive 	$n = \frac{v}{2 \cdot \pi \cdot r}$	$M = m \cdot g \cdot r$	$P = \frac{m \cdot g \cdot v}{60}$	$J = m \cdot r^2$
	Speed	Torque	Transmission ratio	Mass moment of inertia
Gear conversion 	$n_1 = n_2 \cdot i$	$M_1 = \frac{M_2}{i}$	$i = \frac{n_1}{n_2}$	$J_1 = \frac{J_2}{i^2}$

Miscellaneous			
Rotational frequency	$\omega = \frac{2 \cdot \pi \cdot n}{60}$	Effective electrical power	$P = U \cdot I \cdot \cos\varphi \cdot \sqrt{3}$
Rotational kinetic energy	$W = \frac{J}{2} \cdot \omega^2$	Apparent electrical power	$S = U \cdot I \cdot \sqrt{3}$
Translational kinetic energy	$W = \frac{m}{2} \cdot \left(\frac{v}{60}\right)^2$	Reactive electrical power	$Q = U \cdot I \cdot \sin\varphi \cdot \sqrt{3}$
Synchronous rpm	$n = \frac{f \cdot 60}{p}$	DC bus voltage	$U = U_{\text{net}} \cdot \sqrt{2}$
Synchronous speed	$v = 2 \cdot f \cdot \tau_p$	Force	$F = m \cdot a$

Unit conversion			
Physical value	Name of unit	Conversion	Name of unit
force	pound-force	1 lbf = 4.4482 N	Newton
power	horsepower	1 hp = 745.7 W	watt
length	inch	1 in = 25.4 mm	millimeter
length	foot	1 ft = 0.3048 m	meter
mass	pound	1 lb = 0.4536 kg	kilogram

Legend		
a – Acceleration [ms ⁻²]	J – Mass moment of inertia [kgm ²]	r – Radius [m]
F – Force [N]	M – Torque [Nm]	S – Apparent power [VA]
f – Frequency [s ⁻¹]	m – Mass [kg]	U – Voltage [V]
g – Gravitational acceleration [9.81 ms ⁻²]	n – Rotational speed [rpm]	v – Speed [m/min]
h – Spindle pitch [mm]	P – Power [W]	W – Energy [Ws]
I – Current [A]	p – Pole pair number	τ_p – Pole pitch
i – Transmission ratio	Q – Reactive power [var]	ω – Rotational frequency [s ⁻¹]

Documentation and further information

We can supply further information about IndraDrive and IndraDyn as a hard copy, on CD-ROM, DVD or on the Internet.

Alternatively you can contact your local Rexroth distribution agency directly. The relevant address can be found on the back cover of this document.



IndraDrive Mi
Configuration
R911320925/DE
R911320924/EN



IndraMotion MLD
Application
instructions
R911306071/DE
R911306084/EN



IndraDrive
Control units
Project Planning
Manual
R911295011/DE
R911295012/EN



IndraMotion MLD
The first steps
Brief description
R911319304/DE
R911319306/EN

Documentation – hard copy



Drive system
IndraDrive Project
Planning Manual
R911309635/DE
R911309636/EN



Firmware
Theory of operation
R911315484/DE
R911315485/EN



IndraMotion MLD
Libraries
Library description
R911318317/DE
R911319224/EN



IndraDrive
Supply Units and
Power Sections
R911318789/DE
R911318790/EN



Firmware
Parameter
description
R911297316/DE
R911297317/EN



IndraLogic
Programming
instructions
R911305035/DE
R911305036/EN



IndraDrive
Additional
Components
R911306139/DE
R911306140/EN



Safety technology
Application
instructions
R911297837/DE
R911297838/EN



Troubleshooting
information
R911297318/DE
R911297319/EN



IndraDyn S
Project Planning
Manual
R911296288/DE
R911296289/EN



IndraDyn S
for hazardous areas
Project Planning
Manual
R911312708/DE
R911312709/EN



IndraDyn A
Project Planning
Manual
R911295054/DE
R911295781/EN



1MB frameless (kit)
spindle motors
Project Planning
Manual
R911263704/DE
R911264277/EN



IndraDyn L
Project Planning
Manual
R911293634/DE
R911293635/EN



GTE gearboxes
Project Planning
Manual
R911308841/DE
R911308842/EN



IndraDyn H
Project Planning
Manual
R911297894/DE
R911297895/EN



GTM gearboxes
Project Planning
Manual
R911297320/DE
R911297321/EN



IndraDyn T
Project Planning
Manual
R911291224/DE
R911298798/EN



Connection cables
Selection data
R911280894/DE
R911280897/EN

Documentation on CD/DVD

The complete documentation for
IndraDrive and IndraDyn on
CD-ROM or DVD.



R911306531/DE
and EN

Documentation online

All current documentation can also
be downloaded at
www.boschrexroth.com/mediadirectory

Download IndraSize

IndraSize – the drive sizing program can
be downloaded at
www.boschrexroth.com/indrasize

Rexroth online

Information about Bosch Rexroth AG and
our products and system solutions can be
found by visiting
www.boschrexroth.com

Bosch Rexroth AG
Electric Drives and Controls
P.O. Box 13 57
97803 Lohr, Germany
Bgm.-Dr.-Nebel-Str. 2
97816 Lohr, Germany
Phone +49 9352-40-0
Fax +49 9352-40-4885
www.boschrexroth.com

Presented by: _____



The data specified above only serve to describe the product. As our products are constantly being further developed, no statements concerning a certain condition or suitability for a certain application can be derived from our information. The information given does not release the user from the obligation of own judgment and verification. It must be remembered that our products are subject to a natural process of wear and aging.

71 511 AE/07-08 – A3 – SM
R911313044
© Bosch Rexroth AG 2007
Subject to revisions!
Printed in Germany