B&R ControlSystems Overview Catalog 12/99

B&R SYSTEM 2000 Control Generation

B&R SYSTEM 2003

B&R SYSTEM 2005

B&R SYSTEM 2010

B&R SYSTEM 2000 Logic Scanner

Table of Contents

B&R SYSTEM 2000 Control Generation	9
Limits used for B&R Industrial Products	9
Limits	9
International Standards	10
Modular Structure	11
B&R SYSTEM 2003	11
B&R SYSTEM 2005	11
B&R SYSTEM 2010	11
System and I/O Bus	11
B&R SYSTEM 2003	11
B&R SYSTEM 2005	12
B&R SYSTEM 2010	12
Power Supply	12
B&R SYSTEM 2003 and B&R SYSTEM 2005	12
B&R SYSTEM 2010	12
Terminal Blocks	12
B&R SYSTEM 2003	12
B&R SYSTEM 2005	13
B&R SYSTEM 2010	13
Application Memory Modules	13
B&R SYSTEM 2003	13
B&R SYSTEM 2005	13
B&R SYSTEM 2010	14
Local Expansion (Expansion I/O)	14
General Information	14
B&R SYSTEM 2003	14
B&R SYSTEM 2005	14
B&R SYSTEM 2010	15
Remote Expansion (Remote I/O)	16
B&R SYSTEM 2003	16
B&R SYSTEM 2005	18
B&R SYSTEM 2010	19
Combinations Possible using Local Expansions	20
B&R SYSTEM 2005 an 2010	20
B&R SYSTEM 2010 an 2005	20
Combinations Possible using Remote Expansions	20
B&R 2003, B&R 2005 und B&R 2010	20

B&R SYSTEM 2003 21

Module Overview	21
Sorted Alphabetically According to Module ID	21
Sorted According to Group	23
General Information	26
Measurements	26
Mounting Rail	26
Module Rack	26
Modules	27
Installation Dimensions	29
Installation	30
System Requirements	32
Environmental Temperature during Operation and Relative Humidity	33
Module Rack	34
BP70x	34
Bus Controller Modules	36
EX477 / EX777	36
EX270	38
EX470 / EX770	39
CPUs	41
CP430 / CP47x / CP77x	41
Application Memory Module	43
ME770	43
Analog Interface (AF) Modules	44
AF101	44
Digital Input Modules	46
General Information	46
Input Filter	46
Overview Screw-in Modules	46
Overview I/O Modules	46
DI135	47
DI435	49
DI439.7	50
DI439.72	51
DI645	52
Digital Output Modules	53
General Information	53
Protective Circuit	53
Overview Screw-in Modules	53
Overview I/O Modules	53
DO135	54
DO164	56
DO435	58
DO720	60
DO721	61
DO722	62
Digital Mixed Modules	63
General Information	63
Overview	63
DM435	64
DM438	66
DM465	68
Analog Input Modules	70
General Information	70
Overview	70
AI261	71
AI294	72

AI351	73
AI354	74
AI774	75
Analog Output Modules	76
General Information	76
Overview	76
AO352	77
Temperature Modules	78
General Information	78
Overview	78
AT324	79
AT352	81
AT664	82
Other Modules	83
General Information	83
Overview	83
CM211	84
CM411	87
Communication Modules	89
General Information	89
IF311	90
IF321	91
IF361	92
IF371	93
Counter and Positioning Modules	94
General Information	94
NC161	95
Accessories	97
General Information	97
AC010	98
AC011	98
TB710	99
TB712	100
TB718	101
TB722	102
TB733	103
TB736	104
TB772	105
Manuals	106
Overview	106

B&R SYSTEM 2005 107

Module Overview	107
Sorted Alphabetically according to Module ID:	107
Sorted According to Group	110
General Information	113
Dimensions	113
Basic Module Construction	113
Base Plate	113
Mounting Rail	113
Installation	114
Terminal Block TB170	115
Environmental Temperature during Operation and Relative Humidity	116
Module Rack	117
General Information	117
BP150 / BP151 / BP152 / BP155	118

Power Supply Modules	119
General Information	119
Special Functions	119
Safety Features	119
Expansion Slave (Local Expansion)	119
Remote Slave (Remote Expansion)	119
Expansion Slot	119
Overview	120
PS465 / PS476 / PS477	121
PS691 / PS692 / PS694	123
PS791 / PS792 / PS794	125
Bus Controller Modules	127
EX150	127
EX250	128
EX350	130
CPUs	131
CP152 / CP153	131
CP260	133
IF152	135
IF260	137
IP161	139
XP152	142
Programmable Module	144
DM455	144
Application Memory Modules	146
General Information	146
Buffering the RAM	146
ME960 / ME963 / ME965	147
Digital Input Modules	148
General Information	148
Input Filter	148
Sink/Source Wiring	148
Overview	148
DI450	149
DI475 / DI476	151
DI477	152
DI695	153
Digital Output Modules	154
General Information	154
Protective Circuit	154
Overview	154
DO479 / DO480	155
D0650 / DO750	156
DO690	157
DO760	158
Digital Mixed Modules	159
General Information	159
Overview	159
DM476	160
Analog Input Modules	162
General Information	162
Overview	162
AI350 / AI375 / AI775	163
Analog Output Modules	164
General Information	164
Overview	164
AO350 / AO775	165

Analog Mixed Modules	166
General Information	166
Overview	166
AM050	167
AM051	168
AM055	169
AM374	170
Temperature Modules	172
General Information	172
Overview	172
AT350 / AT450	173
AT660	174
Communication Modules	176
General Information	176
IF050	177
IF060	179
IF613	180
IF621	181
IF622	182
IF661	183
IF671	184
IF672	186
IF681.95	187
IF681.96	188
NW150	189
Counter and Positioning Modules	190
General Information	190
NC150	191
NC154	193
Accessories	196
General Information	196
NiCd Battery	197
AC240	198
Cable NC154 - PC	199
BM150	199
TB162	200
TB170	201
Manuals	202
Overview	202

B&R SYSTEM 2010 203

Module Overview	203
Sorted Alphabetically according to Module ID	203
Sorted according to Group	205
General Information	207
Dimensions	207
Principle Module Structure	207
Differences between System and I/O Modules	207
Base Plate Modules	208
Mounting Rail	208
Installation	209
Installing PCC Modules	210
Terminal Blocks TB120 / TB140	211
Cable Routing and Connection to the Terminal Block	211
Coding the Terminal Block	211
Environmental Temperature during Operation and Relative Humidity	211

Module Rack	212
General Information	212
Configuration of the Various Base Plates	212
BP101 / BP110 / BP200 / BP201 / BP202 / BP210 / BP300	214
Power Supply Modules	215
General Information	215
Safety Features	215
Overview	215
Power Supply Module Location	215
PS425	217
PS740	218
Bus Controller Modules	220
EX100 / EX200	220
EX301 / EX302	221
CPUs	222
General Information	222
Status Area	222
Connection Area	222
Safety Features	222
CP100 / CP104 / CP200 / CP210	223
Programmable Modules	225
General Information	225
DS100	226
DS101	228
MP100	230
Application Memory Modules	232
General Information	232
Buffering RAM	232
ME910 / ME913 / ME915	233
Digital Input Modules	234
General Information	234
Input Filter	234
Overview	234
Sink/Source Wiring	234
DI400	236
DI425 / DI426	238
DI725	239
DI825	240
Digital Output Modules	242
General Information	242
Protective Circuit	242
Overview	242
DO428 / DO430	243
DO600 / DO700	244
DO710	245
Analog Input Modules	246
General Information	246
Overview	246
AI300 / AI700	247
AI730	248
Analog Output Modules	249
General Information	249
Overview	249
AO300 / AO725 / AO900	250
Temperature Modules	251
General Information	251
Overview	251
AT300	252
AT610	253

Other Modules	255
General Information	255
UM900	256
Communication Modules	258
General Information	258
IF100 / IF101	259
NW100	261
Counter and Positioning Modules	262
General Information	262
NC303	263
Accessories	266
General Information	266
BM100	267
TB120 / TB140	268
Manuals	268
Overview	268

B&R SYSTEM 2000 Logic Scanner 269

Module Overview	269
General Information	270
B&R PCC Operating System	270
Compatibility	270
High Performance	270
Visualization	270
Additional Interfaces	270
External Power Supply of the Logic Scanner CPU	270
CPU	271
LS251	271
Communication Modules	274
General Information	274
LS071	275
LS079	277
Manuals	279
Overview	279

General Accessories 281

General Information	281
General Accessories	282
AC401	282
AC410	282
AC912	283
AC913	283
AC916	284
RS485 Bus Connector	284
AC911	285
INT1	286

Index 287

Model Number Index 295

Relevant Conversions 299

B&R SYSTEM 2000 Control Generation

Limits used for B&R Industrial Products

In general, the B&R 2000 control generation is designed to conform to product standard IEC61131-2. The following standards provide detailed definitions required for proper operation in a typical environment containing electromagnetic charges.

Standard	Description
IEC 50081-2 IEC 61000-6-4	Electromagnetic compatibility (EMC) Part 2, Generic standards – Section 4: Emission standard for industrial environments. (IEC 50081-2 is replaced by IEC 61000-6-4)
IEC 50082-2 IEC 61000-6-2	Electromagnetic compatibility (EMC) - Part 2, Generic standards - Immunity for industrial environments- (IEC 50082-2 is replaced by IEC 61000-6-2)
IEC 55022	Information technology equipment. Radio disturbance characteristics. Limits and methods of measurement
IEC 55024	Information technology equipment. Immunity characteristics. Limits and methods of measurement
IEC 60204-1	Safety of machinery - Electrical equipment of machines - Part 1 : General requirements
IEC 60950	Safety of information technology equipment
IEC 61000-3-2	Electromagnetic compatibility (EMC) - Part 3: Limits - Section 2: Limits for harmonic current emissions (equipment input current \leq 16 A per phase)
IEC 61000-3-3	Electromagnetic compatibility (EMC) - Part 3: Limits - Section 3: Limitation of voltage fluctuations and flicker in low-voltage supply systems for equipment with rated current \leq 16 A
IEC 61131-2	Programmable controllers - Part 2: Equipment requirements and tests
IEC 61800-3	Adjustable speed electrical power drive systems - Part 3: EMC product standard including specific test methods
UL 508	Industrial Control Equipment, (UL = Underwriters Laboratories)

Limits

IEC 61000-4-2 Electrostatic Discharge		
	IEC 61131-2	B&R Limit Value
Contact discharge to powdered and blank metal parts	4 kV	8 kV
Discharge through the air to plastic parts	8 kV	15 kV

IEC 61000-4-3 Electromagnetic Fields	
Housing, completely wired:	80 MHz - 1 GHz, 10 V/m, 80 % amplitude modulation with 1 kHz

IEC 61000-4-4 Burst (asymmetric fast transient)		
	IEC 61131-2	B&R Limit Value
Power supply	2 kV, 1 min	4 kV, 5 min
All other lines	1 kV, 1 min	2 kV, 5 min

IEC 61000-4-5 Surge		
	Limits CM, unsymmetrical	Limits DM, symmetrical
AC power supply	2 kV (12 Ω)	1 kV (2 Ω)
DC power supply	1 kV (12 Ω)	0.5 kV (2 Ω)
Digital and analog I/O, AC, unshielded AC auxiliary voltage outputs for sensors, etc.	2 kV (42 Ω)	1 kV (42 Ω)
Digital and analog I/O, DC, unshielded Data lines, unshielded DC auxiliary voltage outputs for sensors, etc.	0.5 kV (42 Ω)	0.5 kV (42 Ω)
All shielded lines	1 kV (2 Ω)	---

IEC 61000-4-6 Conducted Disturbances (radio frequency)	
Network connections Signals >10 m Functional ground	150 kHz – 80 MHz, 10 V, (in broadcast range 3 V) 80 % amplitude modulation with 1 kHz





IEC 60664-1 Pollution Degree
Pollution degree 2: non-conductive pollution

IEC 60068-2-6, Test Fc Vibration Test		
Frequency Range [Hz]	Continuous	Periodic
10 ≤ f < 57	0.0375 mm amplitude	0.075 mm amplitude
57 ≤ f ≤ 150	0.5 g constant acceleration	1 g constant acceleration
f > 150	not defined	not defined

IEC 60068-2-27, Test Ea Shock Test
Periodic peaks up to 15 g over 11 msec, half sine wave in all three perpendicular axes.

International Standards

B&R products and services meet all required standards. These are international standards from organizations such as ISO, IEC and CENELEC, as well as national standards of organizations such as UL, CSA, FCC, VDE, ÖVE, etc. We give special consideration to the reliability of our products in an industrial environment. For example, the requirements of the product standard IEC 61131-2 for electromagnetic immunity are exceeded considerably.

Certifications	
USA and Canada 	All important B&R products are tested and listed by Underwriters Laboratories and are checked quarterly by a UL inspector. This mark is valid for the USA and Canada and eases certification of your machines and systems in these areas.
Europe 	All harmonized EN standards for the valid guidelines are met.
Russian Federation 	B&R has a GOST certification for all products for export to the Russian Federation.
	The entire B&R SYSTEM 2005 is certified by Bureau Veritas. Bureau Veritas is one of the largest multinational companies for classification of ships, oil rigs etc.

Modular Structure

B&R SYSTEM 2003

Controller and I/O modules are hung on the module rack and tightly screwed to a threaded strip, which has been pushed into the aluminium section. The electrical connection between the modules is achieved by pushing the modules together (integrated plug and socket connection in the modules).

The module rack is hung on a mounting rail (according to EN 50022 - 35 x 7.5 mm). This mounting rail is conductively attached to the control cabinet back wall.

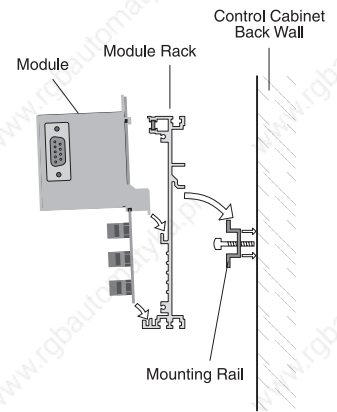

B&R SYSTEM 2005

B&R System 2005 consists of encased modules. The modules (except the power supply and the CPU) can be inserted in any order on the base plate.

The base plate is hung on a mounting rail (according to EN 50022 - 35 x 7.5 mm). This mounting rail is conductively connected to the control cabinet back wall.

Both the bus system and the supply lines are provided on the base plate modules. Base plates are available in different lengths (6, 9, 12, 15 slots).

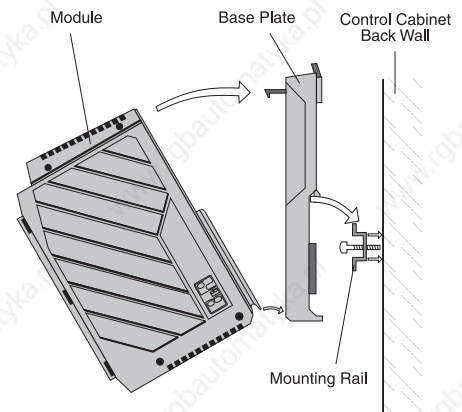

B&R SYSTEM 2010

B&R System 2010 consists of encased modules, which are attached to a base plate with a modular construction.

The base plate is hung on a mounting rail (according to EN 50022 - 35 x 7.5 mm). This mounting rail is conductively connected to the control cabinet back wall.

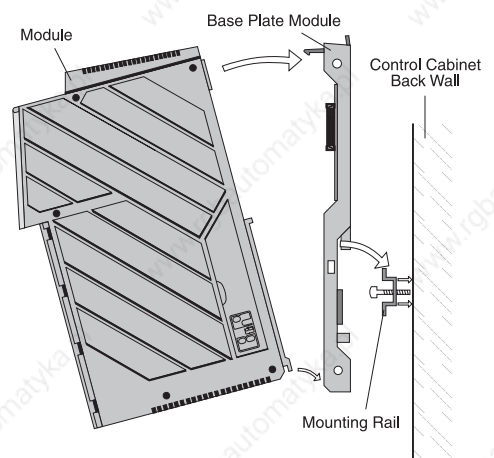

System and I/O Bus

B&R SYSTEM 2003

B&R SYSTEM 2003 has an I/O bus. The electrical connection between the modules is established by pushing the modules together (integrated plug and socket connection in the modules).

- Compact Construction
- Integrated Terminal Block Technology
- Standard Field Bus Technology
 - 2 or 3 line connection
 - No other terminal required

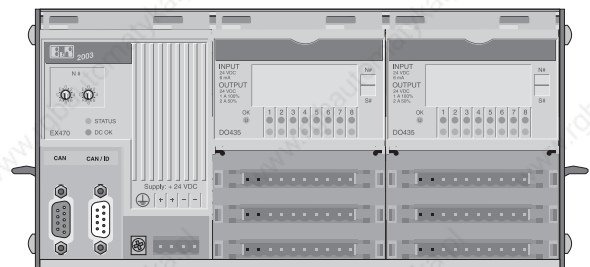

B&R SYSTEM 2005

There is a combined I/O and system bus on every B&R System 2005 base plate. Therefore system and I/O modules can be inserted on the main base plate. The base plate on which the CPU is located is known as the main base plate.

- Combined System Bus and I/O Bus
- Only one Type of Base Plate is Necessary for Main and Expansion Base Plates (easy stock management)
- Secure Protocol for I/O Data Transfer (expansion)

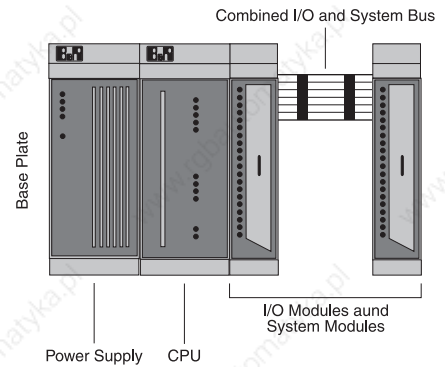

B&R SYSTEM 2010

One characteristic of B&R System 2010 is the separation of the bus system into System bus and I/O bus. I/O modules and power supply modules are located on the I/O bus, and system modules (e.g. network modules, multiprocessors) are located on the system bus.

- Separate System Bus and I/O Bus
- Different Base Plate Modules are Required for System Bus and I/O Bus
- Secure Protocol for I/O Data Transfer
- High Data Throughput Rate, as System Bus and I/O Bus do not Influence one Another:
 - The I/O bus has to handle the constant, deterministic and cyclic characteristics of a classic PLC module (e.g. digital or analog input/output modules).
 - Large amounts of data appear sporadically on the system bus. Due to the separated bus system, the stream of data does not affect the I/O bus.

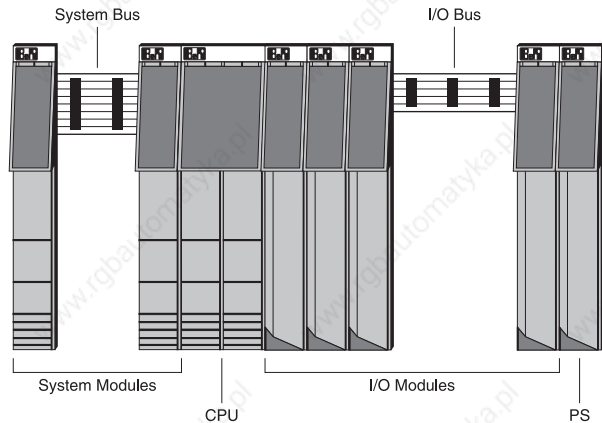

Power Supply

B&R SYSTEM 2003 and B&R SYSTEM 2005

These systems are supplied centrally. Power supplies are either 24 VDC $\pm 25\%$ or 90 to 250 VAC.

B&R SYSTEM 2010

There is a remote power supply for B&R SYSTEM 2010. Any number of power supply modules can be placed on the I/O bus to provide the power for the I/O and system modules via the bus system.

It is possible to integrate **redundant** power supply modules into the system, so that more PS modules are used, than are actually needed. This ensures that PCCs will always be supplied with power, even if one of the PS modules breaks down for any reason.

Terminal Blocks

B&R SYSTEM 2003

Modules from the B&R 2003 controller family use a variety of terminals. The structure of the terminal blocks have the following advantages for the PCC user:

- Terminal blocks can be removed easily using two ejection levers found either on the module or directly on the terminal block.
- Most terminal blocks are available with either screw clamps or cage clamps.

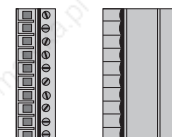

B&R SYSTEM 2005

B&R System 2005 modules are connected using the 20 pin terminal block TB170. The terminal block can easily be taken out by pressing the ejection lever (using a screwdriver).

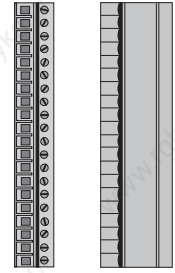

B&R SYSTEM 2010

B&R System 2010 modules are connected using the user-friendly 40 pin terminal block (TB140) or the 20 pin terminal block (TB120).

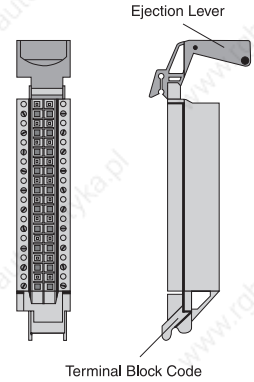

Application Memory Modules

B&R SYSTEM 2003

PCC 2003 CPU

When using a B&R CPU, application programs and the operating system are stored in the CPU.

Remote Slaves

When used as Remote I/O Slave, the application programs are stored in the Remote Master (e.g. EX150) . The operating system is programmed in the Remote I/O bus controller.

CAN Slaves

When used as CAN Bus Slave, application programs are stored in the CAN Master (e.g. XP152). The operating system is programmed in the CAN bus controller. Configuration data can be placed in configuration memory (inserted from the front). The CAN bus controller EX270 is equipped with an internal S-EEPROM. Operating parameters can be stored in this S-EEPROM.

B&R SYSTEM 2005

All the software which is necessary for PCC System B&R 2005 (operating system, application program), is stored in application memory. The application memory is located in the front of the CPU.



B&R SYSTEM 2010

All the software which is necessary for PCC System B&R 2010 (operating system, application program), is stored in application memory. The application memory is inserted into the front of a processor module.



Local Expansion (Expansion I/O)

General Information

To save space, B&R SYSTEM 2005 and B&R SYSTEM 2010 can be separated into several bus segments. With local expansion, the expansion unit is attached near the main unit (usually in the same control cabinet).

B&R SYSTEM 2003

Local I/O bus expansion is not possible with this system.

B&R SYSTEM 2005

The main rack contains the CPU. Expansion racks do not have CPUs, but they all have their own power supply module. A CPU with expansion master is required in the main rack, and a power supply module with expansion slave is required in the expansion rack. Up to four expansion slaves can be operated from one expansion master.

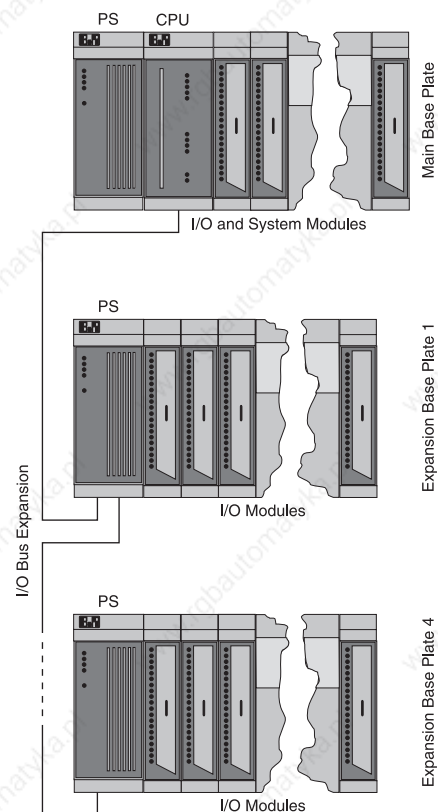

B&R SYSTEM 2010

Up to 99 modules (I/O modules, power supply modules, expansion modules) can be addressed on the I/O bus of a B&R 2010 system. This I/O bus can be split up into several bus segments using expansion modules.

Therefore, the I/O modules are not restricted by the size and shape of the control cabinet. You can always use the maximum number of slots for I/O modules without worrying about the space required (except for the slots for the expansion master, expansion slave and power supply modules).

The following should be noted when splitting up the local I/O bus into several sections:

- An expansion master can be operated in any bus segment on level 1 or 2 (see diagram) in any slot on the I/O bus.
- The expansion slave is always located in the far left slot of a bus segment.
- A separate base plate module (BP202) is required for the expansion slave.

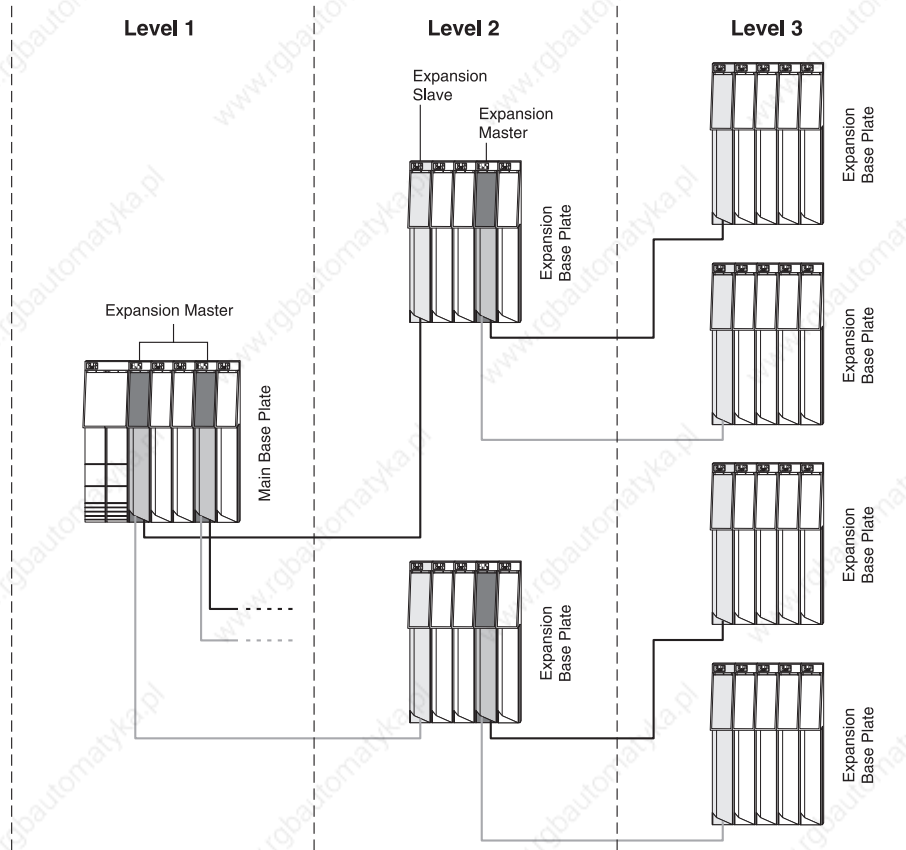

Remote Expansion (Remote I/O)

Expansion units can be up to 1200 meters from the main unit, when using remote expansion (remote I/O). With repeaters, the network can be extended even further. A remote I/O master module is required on the main rack, and a power supply module with remote

I/O slave (2005) or a remote I/O slave module (2010) is required on the expansion rack. Up to 31 remote I/O slaves can be operated with one remote I/O master without a repeater, or up to 126 remote I/O slaves with a repeater.

B&R SYSTEM 2003

Two types of expansion are possible:

- Remote I/O Bus
- CAN Field Bus

Remote I/O Bus

The Remote Master is a B&R SYSTEM 2005, B&R SYSTEM 2010 or B&R SYSTEM 2000 Logic Scanner. To be able to use a B&R SYSTEM 2003 as slave in a Remote I/O network, a Remote I/O bus controller EX477 or EX777 is required.

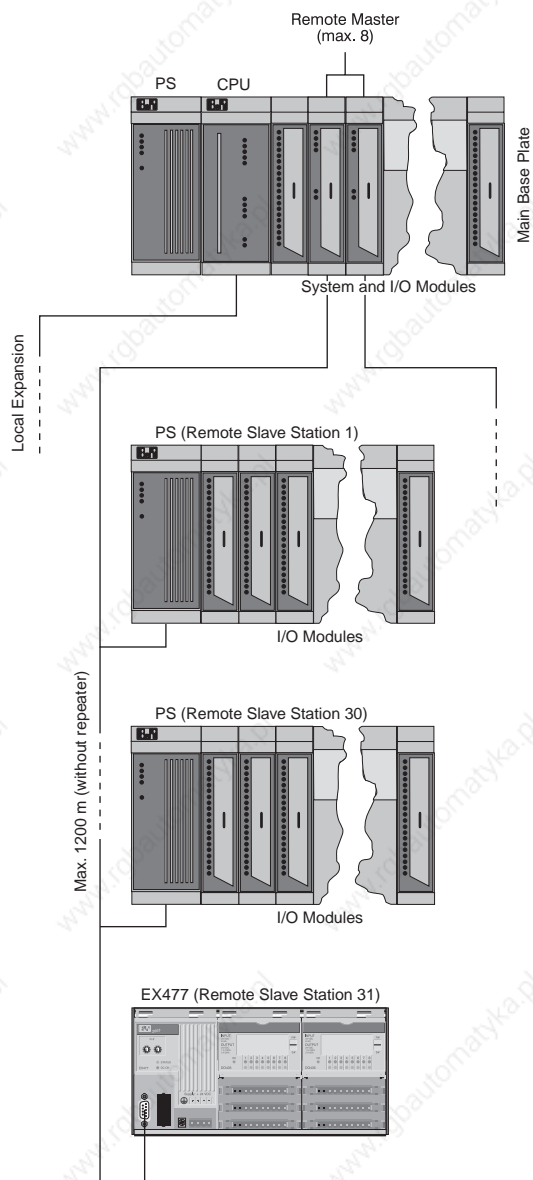

CAN Field Bus

The CAN Master is a B&R SYSTEM 2003, B&R SYSTEM 2005, B&R SYSTEM 2010 or B&R SYSTEM 2000 Logic Scanner. To be able to use a B&R SYSTEM 2003 in a CAN network, a CAN bus controller EX270, EX470 or EX770 is required.

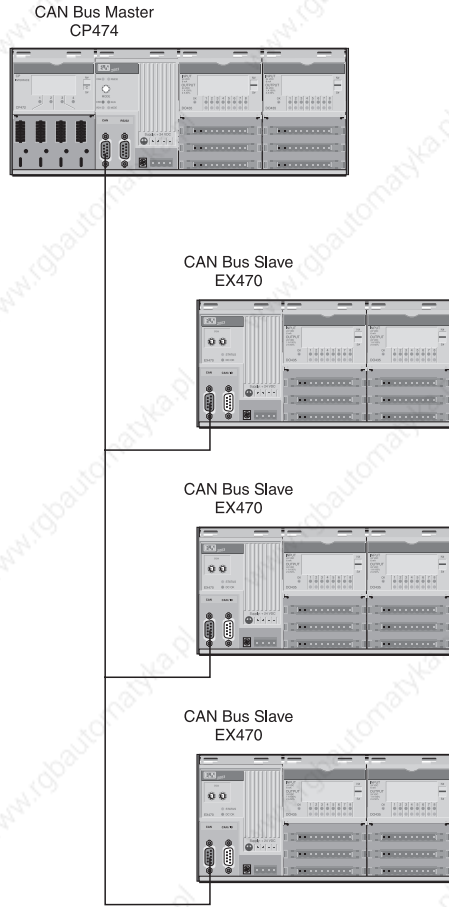

B&R SYSTEM 2005

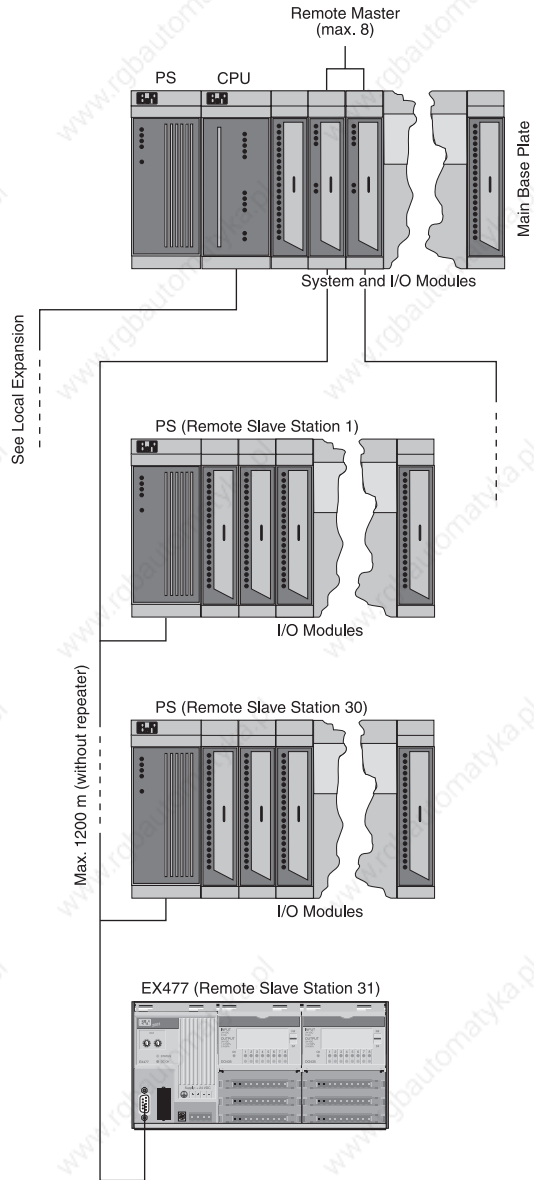

B&R SYSTEM 2010

Every remote I/O slave can address up to a maximum of 99 modules. Separation into several bus segments is also possible since each remote I/O has its own I/O bus.

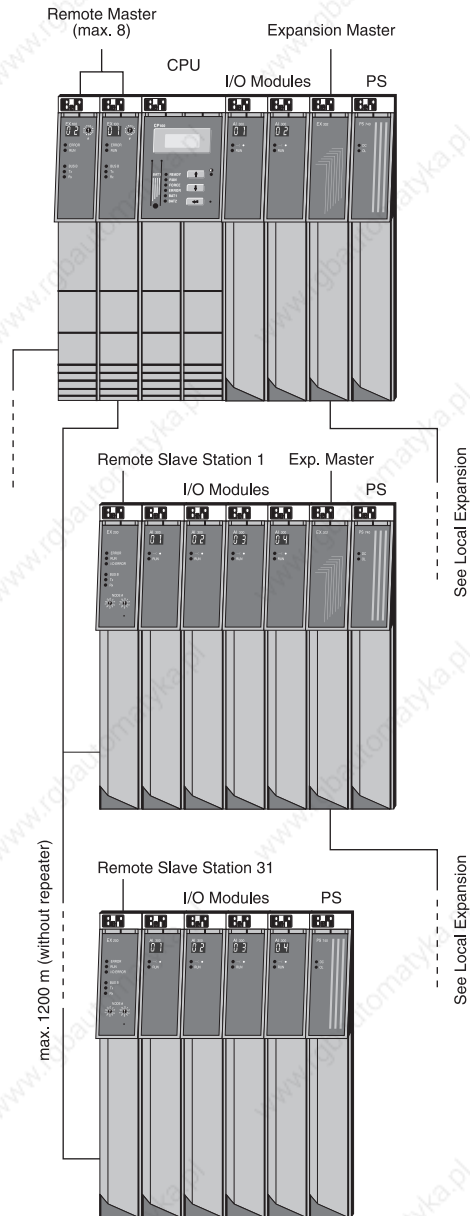

Combinations Possible using Local Expansions

B&R SYSTEM 2005 an 2010

A B&R 2005 expansion base plate is coupled to a B&R 2010 expansion master via a power supply with expansion slave. The entire configuration may consist of a maximum of four B&R 2005 expansion base plates.

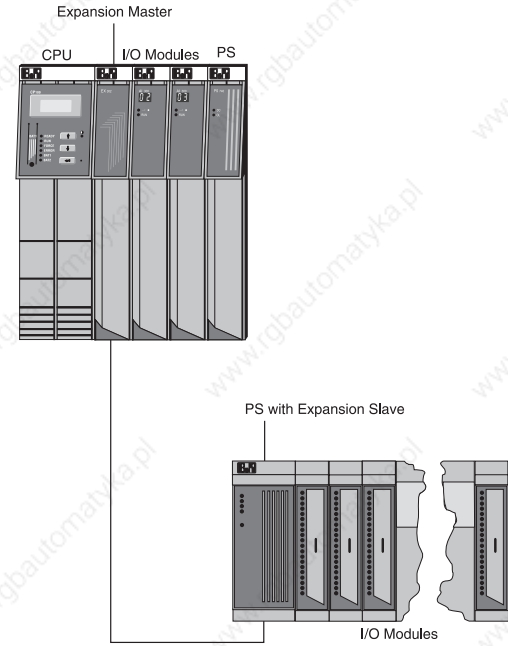

B&R SYSTEM 2010 an 2005

A B&R 2010 I/O bus is coupled to a B&R 2005 CPU (with expansion master), using an expansion slave. A maximum of twenty B&R 2010 I/O modules can be connected in this way.

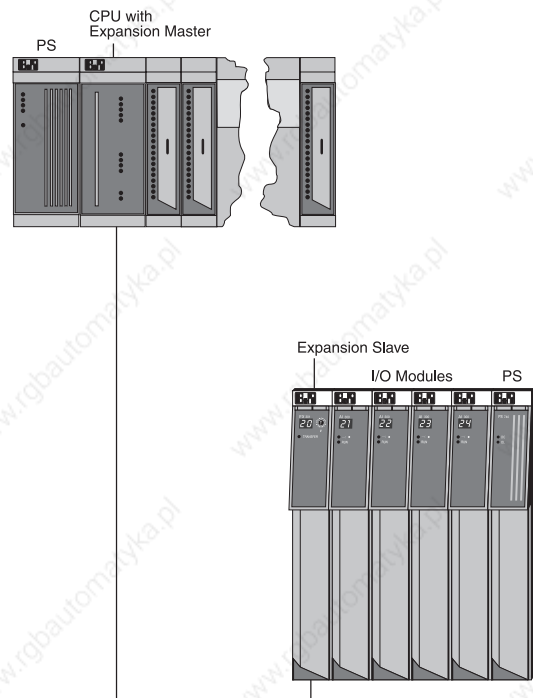

Combinations Possible using Remote Expansions

B&R 2003, B&R 2005 und B&R 2010

Up to 31 remote slaves can be connected to a remote master (B&R 2010 or B&R 2005). It is possible to mix the B&R 2003, B&R 2005 and B&R 2010 systems.

Slave Type	Number of Slots
2010	max. 99 (daisy chained)
2005	max. 13
2003	max. 8

B&R SYSTEM 2003

Module Overview

Column "Power" contains a power value provided by the module or required by the module. This can be used to quickly and easily create a power balance for a certain hardware configuration.

The power supplied by the PS modules is labeled with '+'. The power required by the other modules is labeled with '-'. In order to create a power balance, add the power values together taking the sign into consideration. The sum is not allowed to be less than zero.

Sorted Alphabetically According to Module ID

Module ID	Description	Power	Model No.	Page
AC010	5 Bus Cover		7AC010.9	98
AC011	5 Stress Relief Attachments including Installation Material		7AC011.9	98
AF101	Adapter Module AF101	-0.3 W	7AF101.7	44
AI261	1 Input for Strain Gauge Full Bridge Evaluation, 24 Bit Resolution	-0.6 W	7AI261.7	71
AI294	4 Inputs for Potentiometer Encoder, 13 Bit Resolution	-0.5 W	7AI294.7	72
AI351	1 Input ± 10 V or 0 - 20 mA, 12 Bit Resolution + Sign. Potentiometer Operation	U/I: -0.3 W Pot.: -0.7 W	7AI351.70	73
AI354	4 Inputs ± 10 V, 12 Bit Resolution + Sign	-0.5 W	7AI354.70	74
AI774	4 Inputs 0 - 20 mA, 12 Bit Resolution	-0.4 W	7AI774.70	75
AO352	2 Outputs ± 10 V / 0 - 20 mA	-1.2 W	7AO352.70	77
AT324	4 Inputs for temperature sensor (PT100 / PT100 / KTY 10-6 / KTY84 - 130)	-0.1 W	7AT324.70	79
AT352	2 Input for PT100 Sensor (3 wire)	-0.4 W	7AT352.70	81
AT664	4 Inputs for Thermoelements	-0.4 W	7AT664.70	82
BP701.1	Module Rack, Space for 1 Module, incl. right side section		7BP701.1	34
BP702	Module Rack, Space for 2 Module		7BP702.0	34
BP702.1	Module Rack, Space for 2 Module, incl. right side section		7BP702.1	34
BP703	Module Rack, Space for 3 Module		7BP703.0	34
BP704	Module Rack, Space for 4 Module		7BP704.0	34
BP705	Module Rack, Space for 5 Module		7BP705.0	34
BP706	Module Rack, Space for 6 Module		7BP706.0	34
BP707	Module Rack, Space for 7 Module		7BP707.0	34
BP708	Module Rack, Space for 8 Module		7BP708.0	34
BP709	Module Rack, Space for 9 Module		7BP709.0	34
BP710	Module Rack, Space for 10 Module		7BP710.0	34
CM211	8 Digital Inputs, 24 VDC, 20 kHz, One or Two Channel Counters, Incremental Encoder, 8 Digital Outputs, 24 VDC, 0.5 A, Comparator Function, 2 Analog Inputs ± 10 V or 0 - 20 mA, Resolution 12 Bit, 2 Analog Outputs ± 10 V, Resolution 12 Bit	-1.5 W	7CM211.7	84
CM411	3 Digital Inputs, 24 VDC, 50 kHz, One or Two Channel Counter, Incremental Encoder 2 Digital Outputs, 24 VDC, 0.5 A, Comparator Function, 3 Analog Inputs ± 10 V, 16 Bit Resolution, 3 Analog Outputs ± 10 V, 16 Bit Resolution	-2.4 W	7CM411.70-1	87

Module ID	Description	Power	Model No.	Page
CP430	CPU, 24 VDC, 100 KByte SRAM, 256 KByte FlashPROM	+9.5 W	7CP430.60-1	41
CP470	CPU, 24 VDC, 100 KByte SRAM, 256 KByte FlashPROM	+16.5 W	7CP470.60-1	41
CP474	CPU, 24 VDC, CP-Interface, 100 KByte SRAM, 512 KByte FlashPROM	+11 W ¹⁾	7CP474.60-1	41
CP770	CPU, 100 - 240 VAC, 100 KByte SRAM, 256 KByte FlashPROM	+16.5 W	7CP770.60-1	41
CP774	CPU, 100 - 240 VAC, CP-Interface, 100 KByte SRAM, 512 KByte FlashPROM	+11 W ¹⁾	7CP774.60-1	41
DI135	4 Inputs, 24 VDC, Event counter or Incremental Encoder Operation, 1 Comparator Output, 24 VDC	-0.4 W	7DI135.70	47
DI435	8 Inputs, 24 VDC, Input Delay 1 msec	-0.2 W	7DI435.7	49
DI439.7	16 inputs, 24 VDC, Input Delay 1 msec, Terminal Connection	-0.4 W	7DI439.7	50
DI439.72	16 inputs, 24 VDC, Input Delay 1 msec, D-type Connection	-0.4 W	7DI439.72	51
DI645	8 Inputs, 100-240 VAC, Input Delay 50 msec	-0.2 W	7DI645.7	52
DM435	8 Digital Inputs, 24 VDC, Input Delay 1 msec and 8 Digital Outputs, 24 VDC, 0.5 A, Terminal Connection	-0.5 W	7DM435.7	64
DM438	8 Digital Inputs, 24 VDC, Input Delay 1 msec and 8 Digital Outputs, 24 VDC, 0.5 A, D-Type Connection	-0.5 W	7DM438.72	66
DM465	16 Digital Inputs, 24 VDC, Input Delay 1 msec, 16 Digital Outputs, 24 VDC, 0.5 A	-1.1 W	7DM465.7	68
DO135	4 FET-Outputs, 12 - 24 VDC, 0.1 A, 100 kHz	-0.2 W	7DO135.70	54
DO164	4 FET outputs 12 to 125 VDC, 0.05 A, Zero cross detection	-0.6 W	7DO164.70	56
DO435	8 Channels, Each Channel can be Declared as Output or Input, max. 8 FET-Outputs, 24 VDC, 2 A, max. 8 Inputs, 24 VDC, Input Delay 1 msec	-0.5 W	7DO435.7	58
DO720	8 Relay Outputs, 240 VAC / 30 VDC, 2 A	-1.4 W	7DO720.7	60
DO721	8 Relay Outputs, 240 VAC / 24 VDC, 4 A	-1.4 W	7DO721.7	61
DO722	8 Relay Outputs, 240 VAC / 24 VDC, 2.5 A	-1.4 W	7DO722.7	62
EX270	CAN Bus Controller, 24 VDC Supply	+ 4 W	7EX270.50-1	38
EX470	CAN Bus Controller, 24 VDC Supply	+14 W	7EX470.50-1	39
EX477	Remote I/O Bus controller, 24 VDC Supply	+14 W ²⁾	7EX477.50-1	36
EX770	CAN Bus Controller, 100 - 240 VDC Supply	+14 W	7EX770.50-1	39
EX777	Remote Bus Controller, 100 - 240 Supply	+14 W ³⁾	7EX777.50-1	36
IF311	Interface Module with RS232 Interface without PW Panel with PW Panel P120 / P121	-0.5 W -1.6 W	7IF311.7	90
IF321	Interface Module with RS485/RS422 Interface	-1.4 W	7IF321.7	91
IF361	Interface Module with RS485 Interface (PROFIBUS-DP Slave)	-2.6 W	7IF361.70-1	92
IF371	Interface Module with CAN Interface	-2.5 W	7IF371.70-1	93
ME770	Configuration Memory for CAN Bus Controller	-0.1 W	7ME770.5	43
NC161	Encoder Module, Input Frequency 100 kHz, Incremental or Absolute, 32 Bit Resolution	-0.3 W -I _{Enc} * 5.4 V	7NC161.7	95
TB710	Single Row Terminal Block, 10 pin, Screw Terminals		7TB710.9	99
TB710	Single Row Terminal Block, 10 pin, Cage Clamps		7TB710.91	99
TB710	30 Single Row Terminal Block, 10 pin, Screw Terminals		7TB710:90-01	99
TB710	30 Single Row Terminal Block, 10 pin, Cage Clamps		7TB710:91-01	99
TB712	Single Row Terminal Block, 12 pin, Screw Terminals		7TB712.9	100
TB712	Single Row Terminal Block, 12 pin, Cage Clamps		7TB712.91	100
TB712	20 Single Row Terminal Block, 12 pin, Screw Terminals		7TB712:90-02	100
TB712	20 Single Row Terminal Block, 12 pin, Cage Clamps		7TB712:91-02	100
TB718	Single Row Terminal Block, 18 pin, Screw Terminals		7TB718.9	101
TB718	Single Row Terminal Block, 18 pin, Cage Clamps		7TB718.91	101
TB718	20 Single Row Terminal Block, 18 pin, Screw Terminals		7TB718:90-02	101
TB718	20 Single Row Terminal Block, 18 pin, Cage Clamps		7TB718:91-02	101

Module ID	Description	Power	Model No.	Page
TB722	Double Row Terminal Block, 22 pin, Screw Terminals		7TB722.9	102
TB722	Double Row Terminal Block, 22 pin, Cage Clamps		7TB722.91	102
TB733	Triple Row Terminal Block, 33 pin, Screw Clamp		7TB733.9	103
TB733	Triple Row Terminal Block, 33 pin, Cage Clamp		7TB733.91	103
TB736	Double Row Terminals, 36 pin, Screw Clamps		7TB736.9	104
TB736	Double Row Terminals, 36 pin, Cage Clamps		7TB736.91	104
TB772	Four Row Terminal Block, 72 pin, Cage Clamp		7TB772.91	105

¹⁾ Integrated supply for basic PANELWARE operator panels, e.g P120

²⁾ Starting with Revision 30.xx of EX470

³⁾ Starting with Revision 10.XX of EX770

Sorted According to Group

Module ID	Description	Power	Model No.	Page
	Module Rack			
BP701.1	Module Rack, Space for 1 Module, incl. right side section		7BP701.1	34
BP702	Module Rack, Space for 2 Module		7BP702.0	34
BP702.1	Module Rack, Space for 2 Module, incl. right side section		7BP702.1	34
BP703	Module Rack, Space for 3 Module		7BP703.0	34
BP704	Module Rack, Space for 4 Module		7BP704.0	34
BP705	Module Rack, Space for 5 Module		7BP705.0	34
BP706	Module Rack, Space for 6 Module		7BP706.0	34
BP707	Module Rack, Space for 7 Module		7BP707.0	34
BP708	Module Rack, Space for 8 Module		7BP708.0	34
BP709	Module Rack, Space for 9 Module		7BP709.0	34
BP710	Module Rack, Space for 10 Module		7BP710.0	34
	Bus Controller Modules			
EX270	CAN Bus Controller, 24 VDC Supply	+ 4 W	7EX270.50-1	38
EX470	CAN Bus Controller, 24 VDC Supply	+14 W	7EX470.50-1	39
EX477	Remote I/O Bus controller, 24 VDC Supply	+14 W ²⁾	7EX477.50-1	36
EX770	CAN Bus Controller, 100 - 240 VDC Supply	+14 W	7EX770.50-1	39
EX777	Remote Bus Controller, 100 - 240 Supply	+14 W ³⁾	7EX777.50-1	36
	CPUs			
CP430	CPU, 24 VDC, 100 KByte SRAM, 256 KByte FlashPROM	+9.5 W	7CP430.60-1	41
CP470	CPU, 24 VDC, 100 KByte SRAM, 256 KByte FlashPROM	+16.5 W	7CP470.60-1	41
CP474	CPU, 24 VDC, CP-Interface, 100 KByte SRAM, 512 KByte FlashPROM	+11 W ¹⁾	7CP474.60-1	41
CP770	CPU, 100 - 240 VAC, 100 KByte SRAM, 256 KByte FlashPROM	+16.5 W	7CP770.60-1	41
CP774	CPU, 100 - 240 VAC, CP-Interface, 100 KByte SRAM, 512 KByte FlashPROM	+11 W ¹⁾	7CP774.60-1	41
	Application Memory Modules			
ME770	Configuration Memory for CAN Bus Controller	-0.1 W	7ME770.5	43
	Analog Interface (AF) Modules			
AF101	Adapter Module AF101	-0.3 W	7AF101.7	44
	Digital Input Modules			
DI135	4 Inputs, 24 VDC, Event counter or Incremental Encoder Operation, 1 Comparator Output, 24 VDC	-0.4 W	7DI135.70	47
DI435	8 Inputs, 24 VDC, Input Delay 1 msec	-0.2 W	7DI435.7	49
DI439.7	16 inputs, 24 VDC, Input Delay 1 msec, Terminal Connection	-0.4 W	7DI439.7	50
DI439.72	16 inputs, 24 VDC, Input Delay 1 msec, D-type Connection	-0.4 W	7DI439.72	51
DI645	8 Inputs, 100-240 VAC, Input Delay 50 msec	-0.2 W	7DI645.7	52

Module ID	Description	Power	Model No.	Page
Digital Output Modules				
DO135	4 FET-Outputs, 12 - 24 VDC, 0.1 A, 100 kHz	-0.2 W	7DO135.70	54
DO164	4 FET outputs 12 to 125 VDC, 0.05 A, Zero cross detection, Screw-in module	-0.6 W	7DO164.70	56
DO435	8 Channels, Each Channel can be Declared as Output or Input, max. 8 FET-Outputs, 24 VDC, 2 A, max. 8 Inputs, 24 VDC, Input Delay 1 msec	-0.5 W	7DO435.7	58
DO720	8 Relay Outputs, 240 VAC / 30 VDC, 2 A	-1.4 W	7DO720.7	60
DO721	8 Relay Outputs, 240 VAC / 24 VDC, 4 A	-1.4 W	7DO721.7	61
DO722	8 Relay Outputs, 240 VAC / 24 VDC, 2.5 A	-1.4 W	7DO722.7	62
Digital Mixed Modules				
DM435	8 Digital Inputs, 24 VDC, Input Delay 1 msec and 8 Digital Outputs, 24 VDC, 0.5 A, Terminal Connection	-0.5 W	7DM435.7	64
DM438	8 Digital Inputs, 24 VDC, Input Delay 1 msec and 8 Digital Outputs, 24 VDC, 0.5 A, D-Type Connection	-0.5 W	7DM438.72	66
DM465	16 Digital Inputs, 24 VDC, Input Delay 1 msec and 16 Digital Outputs, 24 VDC, 0.5 A	-1.1 W	7DM465.7	68
Analog Input Modules				
AI261	1 Input for Strain Gauge Full Bridge Evaluation, 24 Bit Resolution	-0.6 W	7AI261.7	71
AI294	4 Inputs for Potentiometer Encoder, 13 Bit Resolution	-0.5 W	7AI294.7	72
AI351	1 Input ± 10 V or 0 - 20 mA, 12 Bit Resolution + Sign. Potentiometer Operation	U/I: -0.3 W Pot.: -0.7 W	7AI351.70	73
AI354	4 Inputs ± 10 V, 12 Bit Resolution + Sign	-0.5 W	7AI354.70	74
AI774	4 Inputs 0 - 20 mA, 12 Bit Resolution	-0.4 W	7AI774.70	75
Analog Output Modules				
AO352	2 Outputs ± 10 V / 0 - 20 mA	-1.2 W	7AO352.70	77
Temperature Modules				
AT324	4 Inputs for temperature sensor (PT100 / PT100 / KTY 10-6 / KTY84 - 130)	-0.1 W	7AT324.70	79
AT352	2 Input for PT100 Sensor (3 wire)	-0.4 W	7AT352.70	81
AT664	4 Inputs for Thermoelements	-0.4 W	7AT664.70	82
Other Modules				
CM211	8 Digital Inputs, 24 VDC, 20 kHz, One or Two Channel Counters, Incremental Encoder, 8 Digital Outputs, 24 VDC, 0.5 A, Comparator Function, 2 Analog Inputs ± 10 V or 0 - 20 mA, Resolution 12 Bit, 2 Analog Outputs ± 10 V, Resolution 12 Bit	-1.5 W	7CM211.7	84
CM411	3 Digital Inputs, 24 VDC, 50 kHz, One or Two Channel Counter, Incremental Encoder 2 Digital Outputs, 24 VDC, 0.5 A, Comparator Function, 3 Analog Inputs ± 10 V, 16 Bit Resolution, 3 Analog Outputs ± 10 V, 16 Bit Resolution	-2.4 W	7CM411.70-1	87
Communication Modules				
IF311	Interface Module with RS232 Interface without PW Panel with PW Panel P120 / P121	-0.5 W -1.6 W	7IF311.7	90
IF321	Interface Module with RS485/RS422 Interface	-1.4 W	7IF321.7	91
IF361	Interface Module with RS485 Interface (PROFIBUS-DP Slave)	-2.6 W	7IF361.70-1	92
IF371	Interface Module with CAN Interface	-2.5 W	7IF371.70-1	93
Counter and Positioning Modules				
NC161	Encoder Module, Input Frequency 100 kHz, Incremental or Absolute, 32 Bit Resolution	-0.3 W -I _{Enc} * 5.4 V	7NC161.7	95

Module ID	Description	Power	Model No.	Page
	Accessories			
AC010	5 Bus Cover		7AC010.9	98
AC011	5 Stress Relief Attachments including Installation Material		7AC011.9	98
TB710	Single Row Terminal Block, 10 pin, Screw Terminals		7TB710.9	99
TB710	Single Row Terminal Block, 10 pin, Cage Clamps		7TB710.91	99
TB710	30 Single Row Terminal Block, 10 pin, Screw Terminals		7TB710:90-01	99
TB710	30 Single Row Terminal Block, 10 pin, Cage Clamps		7TB710:91-01	99
TB712	Single Row Terminal Block, 12 pin, Screw Terminals		7TB712.9	100
TB712	Single Row Terminal Block, 12 pin, Cage Clamps		7TB712.91	100
TB712	20 Single Row Terminal Block, 12 pin, Screw Terminals		7TB712:90-02	100
TB712	20 Single Row Terminal Block, 12 pin, Cage Clamps		7TB712:91-02	100
TB718	Single Row Terminal Block, 18 pin, Screw Terminals		7TB718.9	101
TB718	Single Row Terminal Block, 18 pin, Cage Clamps		7TB718.91	101
TB718	20 Single Row Terminal Block, 18 pin, Screw Terminals		7TB718:90-02	101
TB718	20 Single Row Terminal Block, 18 pin, Cage Clamps		7TB718:91-02	101
TB722	Double Row Terminal Block, 22 pin, Screw Terminals		7TB722.9	102
TB722	Double Row Terminal Block, 22 pin, Cage Clamps		7TB722.91	102
TB733	Triple Row Terminal Block, 33 pin, Screw Clamp		7TB733.9	103
TB733	Triple Row Terminal Block, 33 pin, Cage Clamp		7TB733.91	103
TB736	Double Row Terminals, 36 pin, Screw Clamps		7TB736.9	104
TB736	Double Row Terminals, 36 pin, Cage Clamps		7TB736.91	104
TB772	Four Row Terminal Block, 72 pin, Cage Clamp		7TB772.91	105
	Manuals			
MASYS22003-0	B&R 2003 User's Manual, German		MASYS22003-0	105
MASYS22003-E	B&R 2003 User's Manual, English		MASYS22003-E	105

¹⁾ Integrated supply for basic PANELWARE operator panels, e.g P120

²⁾ Starting with Revision 30.xx of EX470

³⁾ Starting with Revision 10.XX of EX770

General Information

Measurements

All modules for the B&R 2003 system have the same measurements. The following sketch shows the measurements for the B&R SYSTEM 2003:

Measurements [mm]	
Height	115
Width 7BP7xx.0 7BP70x.1	M x 76,5 + 8,5 M x 76,5 + 4,5
Depth	70
M ... max. number of modules on a module rack (see module rack)	

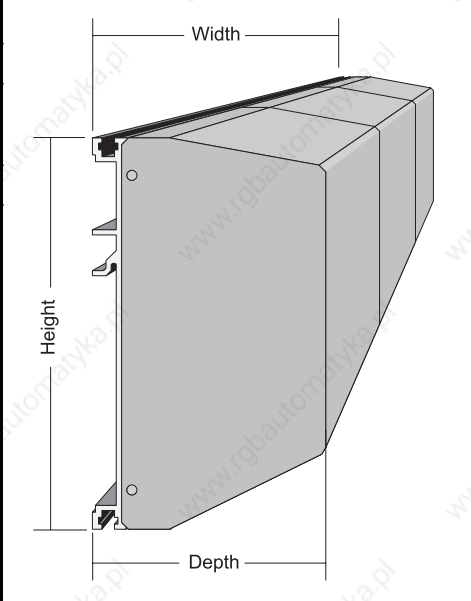

Mounting Rail

A mounting rail is required to install the PCC which must conform to the EN 50022. This mounting rail is to be attached conductively to the control panel back wall.

Follow the manufacturer's installation guidelines!

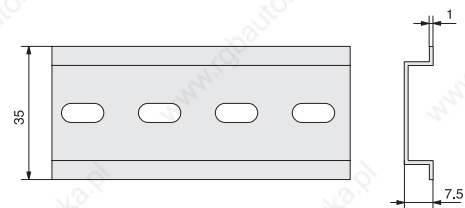

Module Rack

B&R SYSTEM 2003 module racks are aluminium profiles available in various widths. Module racks are used with either one or two side sections, depending on the controller.

Example of a Module Rack with Two Side Sections

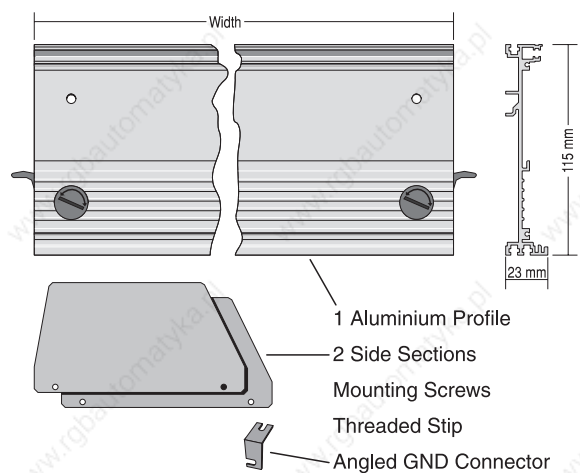

Dimensions

All module racks are 115 mm high. Side sections and mounting screws have to be taken into consideration for the width measurement.

Module racks with two side sections (7BP7xx.0): approx. 8.5 mm
 Module racks with one side section (7BP70x.1): approx. 4.5 mm

Module Rack	Modules	7BP7xx.0, Width [mm] ¹⁾	7BP70x.1, Width [mm] ²⁾
BP701	1	---	81
BP702	2	161,5	157,5
BP703	3	238	---
BP704	4	314,5	---
BP705	5	391	---
BP706	6	467,5	---
BP707	7	544	---
BP708	8	620,5	---
BP709	9	697	---
BP710	10	773,5	---

¹⁾ Including 8.5 mm for two side sections and fastening screws

²⁾ Including 4.5 mm for one side section and fastening screws

Modules

Systems B&R 2003 modules are separated into four groups:

- Controllers
- CPUs
- I/O Modules
- Screw-in Modules (ScrM)

The module group is listed in the technical data section for each module.

Controller, CPU and I/O modules are hung on the module rack and screwed into the threaded strip on the profile. The electrical connection between the modules is made using 9 pin D-type connectors (modules are simply screwed together). Risks involved with typical ribbon cable and connecting a module in the wrong slot can be ruled out.

Screw-in modules (ScrM) are installed on the adapter module or on the CP interface. Up to four screw-in modules can be installed on each adapter module or CP interface.

Controller, CPU and I/O Module Dimensions

Controller and I/O Modules are only available as single width modules. CPUs are available as single and double width modules. The CAN Bus Controller EX270 is an exception to the controllers. It is not inserted in the module rack, instead it is screwed onto the module rack instead of the left side section.

Single Width

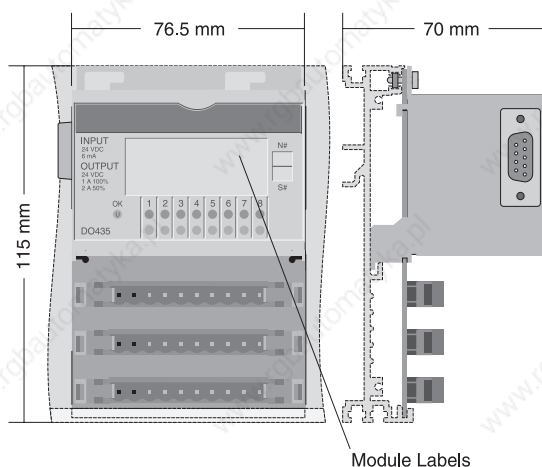

Double Width

The CPUs CP474 and CP774 are double width modules.
The depth is 70 mm (same as other modules).

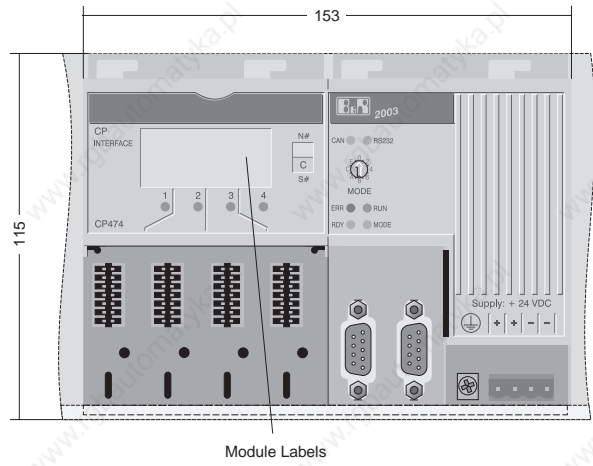

CAN Bus Controller EX270

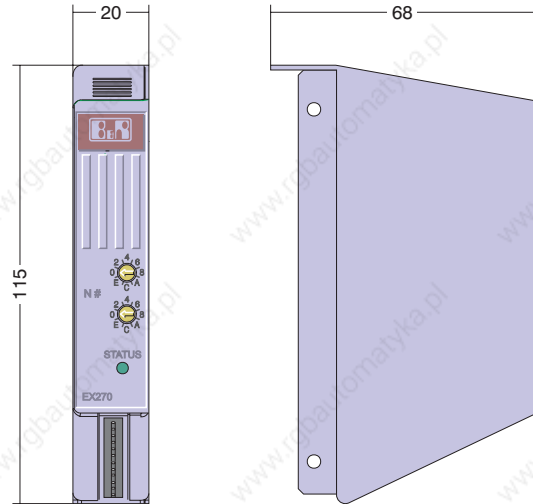

Screw-in Module Dimensions

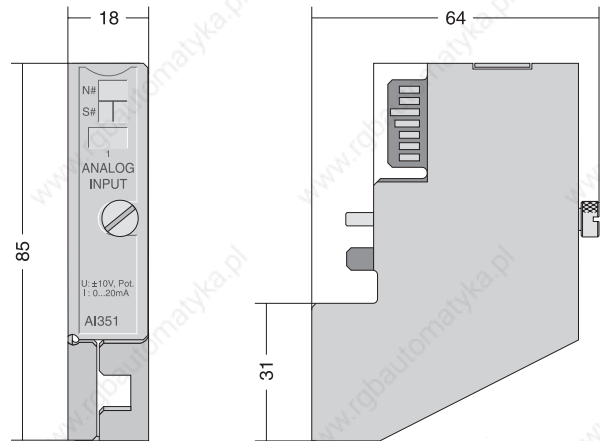

Installation Dimensions

Horizontal Installation

For installation in a switching cabinet or housing, the following dimensions must be taken into consideration:

Width	see section „Module Rack“
Height	h = 115 mm without screw-in modules h = 146 mm with screw-in modules

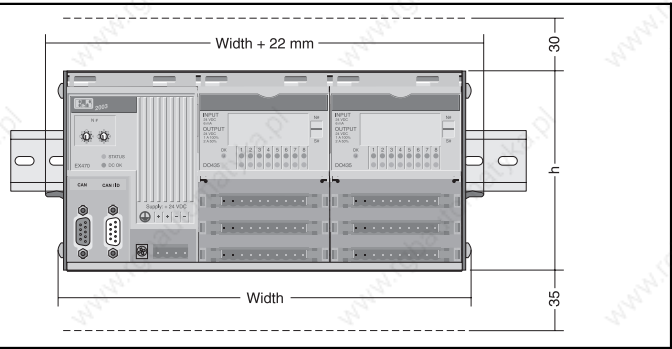

At least 30 mm must be left open above the module. The cooling slots are not allowed to be covered.

For input, output and supply cables, 35 mm is to be left open below the B&R 2003.

Standard Installation

If the controller is installed in the module rack, add 22 mm to the width listed in section "Module Rack" (column "7BP7xx.0").

Installation with CAN Bus Controller EX270

The CAN Bus Controller EX270 is used together with the module rack with model number 7BP70x.1. The EX270 is screwed onto the module rack instead of the left side section.

Add 31 mm to the width listed in section "Module Rack" (column "7BP70x.1").

Vertical Installation

When installing the system vertically in a switching cabinet or housing, take note of the following dimensions:

Height	see section "Module Rack", Column "Width"
Width	b = 115 mm without screw-in modules b = 146 mm with screw-in modules

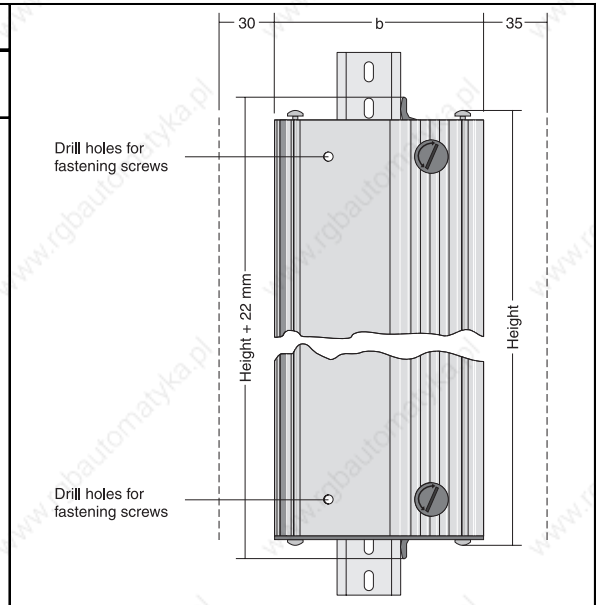

At least 30 mm free space has to be available to the left of the modules. The cooling vents are not allowed to be covered.

35 mm is to be left free to the right of the B&R 2003 for cabling of inputs and outputs and the supply cables.

Two fastening screws are to be used to prevent the controller from slipping. The threaded strips, the left side section and the screws for the right side have to be pre-installed before the module rack is screwed into place.

The modules have to be placed so that the controller is on the bottom of the module rack.

With vertical installation, the temperature range is limited to 0 - 50 °C.

Standard Installation

If the controller is installed in the module rack, add 22 mm to the width listed in section "Module Rack" (column "7BP7xx.0") when calculating the height.

Installation with CAN Bus Controller EX270

The CAN Bus Controller EX270 is used together with the module rack with model number 7BP70x.1. The EX270 is screwed onto the module rack instead of the left side section.

Add 31 mm to the width listed in section "Module Rack" (column "7BP70x.1") when calculating the height.

Installation

The installation is only to be carried out by qualified personnel!

The installation of a B&R SYSTEM 2003 must take place in a certain order:

- 1) Install the mounting rail
- 2) Place the modules on the module rack
- 3) Mount the entire unit

Modules

In order to hang and fix the modules into the module rack, you first need to push in the threaded strip to attach the left hand side section (see following diagram).

- If the threaded strip is not pre-mounted, push it into the aluminium profile:

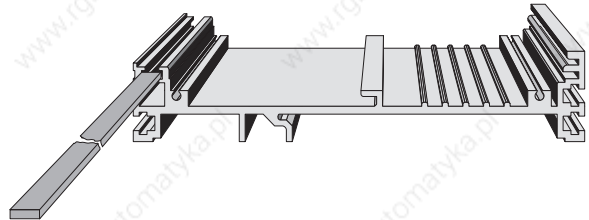

- Fasten the left side section to the aluminium profile with two screws. This side section serves as a stop when inserting the first module.

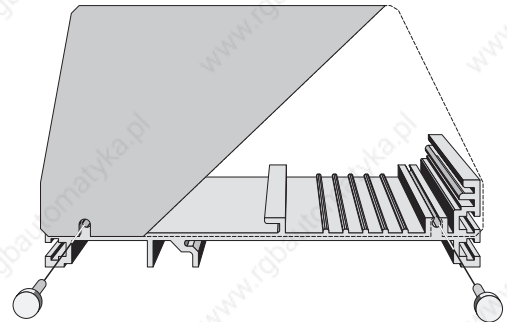

After these preparations, you can hang the modules, slide them to the left (connecting the modules to each other) and screw them in tightly.

- Hang the modules in the module rack (the side section, which has already been installed is not shown in the diagram):

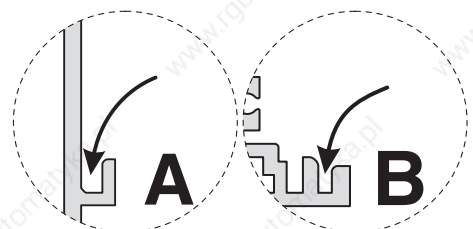
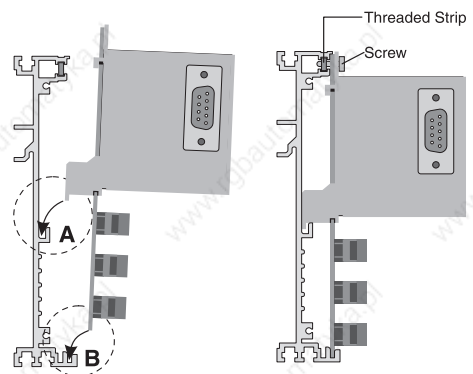

- Slide the first module to the left until it reaches the side section.

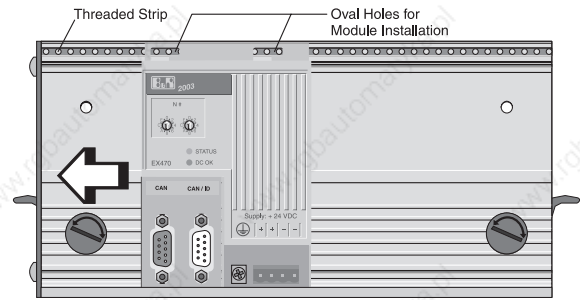

- Each module is fastened to the threaded strip on the module rack with two screws. A angled GND connector is also mounted on the power supply for the I/O controller and connected to the module rack.
- Further modules are installed as described previously, slid to the left and screwed into place:

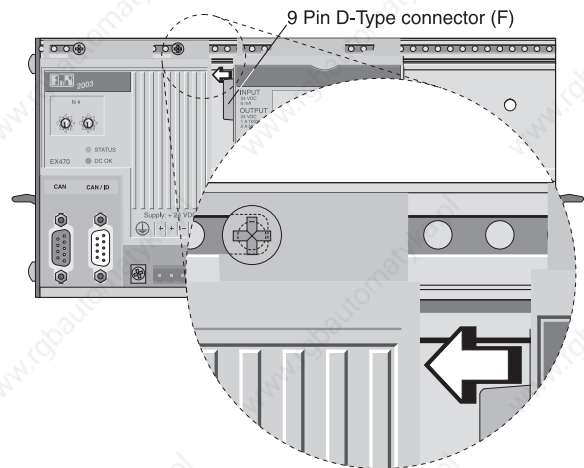

Make sure that the modules are pushed together until proper connection is made between the modules.

- After all modules are installed and fastened onto the module rack, screw on the right side section.

Module Rack

The following steps are to be taken to mount the module rack onto the mounting rail:

- Open both fastening levers (**OPEN** position)

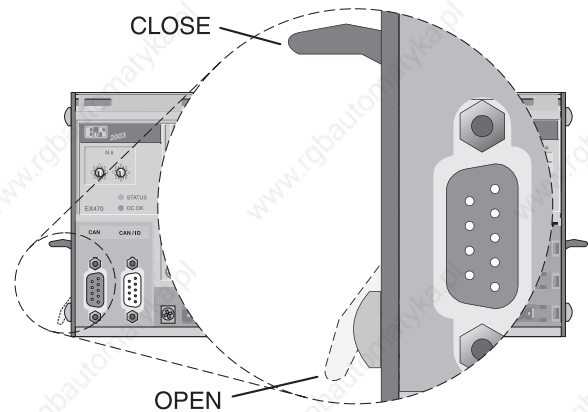

- Place the module rack in the desired position in the mounting rail
- Close both fastening levers (**CLOSE** position)

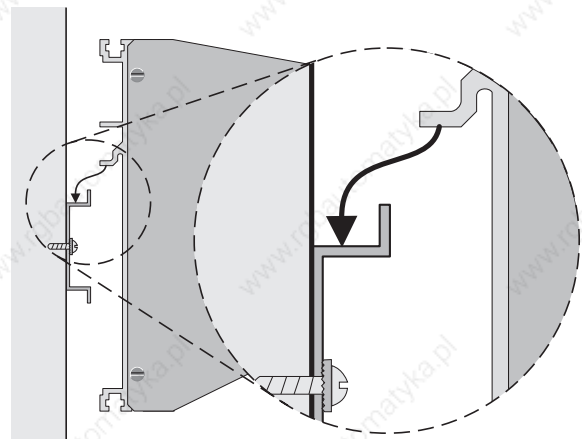

Terminal Block

Single row terminal blocks are used to cable the modules which can be removed using two levers. Pressing the ejection levers (with a screwdriver) loosens the terminal block from the pin block and allows it to be removed easily.

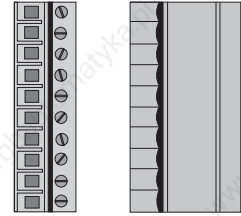

Cabling the Terminal Block

Daisy Chaining

The arrangement of the pin blocks allows the supply voltage to be daisy chained:

The picture shows an example of how supply lines can be daisy chained.

Pay attention to the required voltage and current!

Daisy chaining is only possible if all modules use the same voltage. Additionally, the maximum current load for the connector is not allowed to be exceeded.

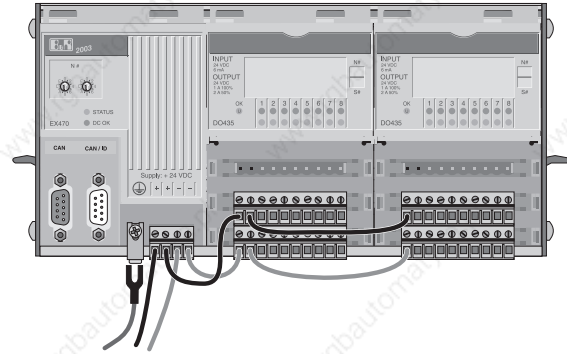

Input and Output Connections

The connections for all the input and output channels lie on top of one another. This makes things a lot clearer, and enables you to find the correct cable for the corresponding channel straight away. Exceptions to this rule are given in the module description.

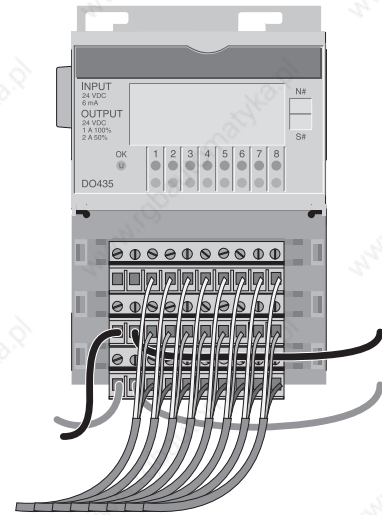

System Requirements

Physical Module Slots

Module racks with various lengths are available for the B&R SYSTEM 2003. Module racks range size from one module slot to a maximum of 10 module slots.

Logical Module Slots

The number of logical module slots depends on the controller. The number of module slots for analog modules also depends on the controller (see section "Modules that Require an Analog Module Slot").

Controller	Maximum Number of Logical Module Slots	Maximum Number of Analog Module Slots
CP430	4	2
CP470 / CP770	8	4
CP474 / CP774	12	4
EX270	4	2
EX470 / EX770	8	4
EX477 / EX777	8	4

Some modules require more than one logical module slot. That means the number of physical module slots required is different than the number of logical module slots required.

The following table contains an overview of the modules that require more than one logical module slot:

Module	Number of Logical Module Slots	Number of Analog Module Slots
DI439	2	---
DM465	2	---
CM211	2	1
CM411	2	2

Modules that Require an Analog Module Slot

Analog modules have to be installed directly next to the controller. The maximum number of analog module slots depends on the controller (see section "1.2 Logical Module Slots").

Analog Module Overview

Model Number	Description
7AF101.7	Adapter Module AF101
7CM211.7	2003 Combination module, 8 inputs, 24 VDC, 4 msec, sink, 3 one channel - or 2 two channel counters or 2 incremental encoders, 20 kHz, 8 transistor outputs, 24 VDC, 0.5 A Comparator, short circuit protection, 2 inputs, +/- 10 V / 0-20 mA, 12 Bit, 2 outputs, +/- 10 V, 12 Bit
7CM411.70-1	2003 Combination Module, 3 Inputs, 24 VDC, 50 kHz, Sink, One or two channel counter, Incremental Encoder, 2 Transistor outputs, 24 VDC, 0.5 A, Comparator, short circuit protection, 3 inputs, +/- 10 V, 16 Bit, 3 outputs, +/- 10 V, 16 Bit

Environmental Temperature during Operation and Relative Humidity

The following entries are valid for all 2003 modules as long as no other value is given in the "Technical Data" section.

Environmental Temperature during Operation	0 to 60 °C
Relative Humidity	5 to 95 %, non-condensing

Module Rack

BP70x

Order Data

Model Number	Description	Figure
Module Racks with two side sections		
7BP702.0	2003 Module rack for 2 modules	
7BP703.0	2003 Module rack for 3 modules	
7BP704.0	2003 Module rack for 4 modules	
7BP705.0	2003 Module rack for 5 modules	
7BP706.0	2003 Module rack for 6 modules	
7BP707.0	2003 Module rack for 7 modules	
7BP708.0	2003 Module rack for 8 modules	
7BP709.0	2003 Module rack for 9 modules	
7BP710.0	2003 Module rack for 10 modules	
Module Racks with one side section		
7BP701.1	2003 2003 Module rack for 1 module, incl. right side section	
7BP702.1	2003 Module rack for 2 modules, incl. right side section	
Accessories		
7AC010.9	2003 Bus cover, 5 pcs	

Technical Data

Module Rack with two side sections (7BPxx.0)

Module ID	BP702	BP703	BP704	BP705	BP706	BP707	BP708	BP709	BP710
Number of Module Slots	2	3	4	5	6	7	8	9	10
C-UL-US Listed	YES								
Material	Aluminum								
Fastening the Modules	Hang up the modules and screw in to place (threaded strip in profile)								
Fastening the Module Rack	Integrated mechanics for installation (standard mounting rail)								
Dimensions [mm]									
Height	115	115	115	115	115	115	115	115	115
Width ¹⁾	161.5	238	314.5	391	467.5	544	620.5	697	773.5
Depth	23	23	23	23	23	23	23	23	23

¹⁾ Including 8.5 mm for two side sections and fastening screws.

Module Rack with one side section (7BP0x.1)

Module ID	BP701	BP702
Number of Module Slots	1	2
C-UL-US Listed	YES	
Material	Aluminum	
Fastening the Modules	Hang up the modules and screw in to place (threaded strip in profile)	
Fastening the Module Rack	Integrated mechanics for installation (standard mounting rail)	
Dimensions [mm]		
Height	115	115
Width ¹⁾	81	157.5
Depth	23	23

¹⁾ Including 4.5 mm for one side section and fastening screws.

Module Address

The module address is determined by the controller and the module location. The CP interface is accessed with module address 0.

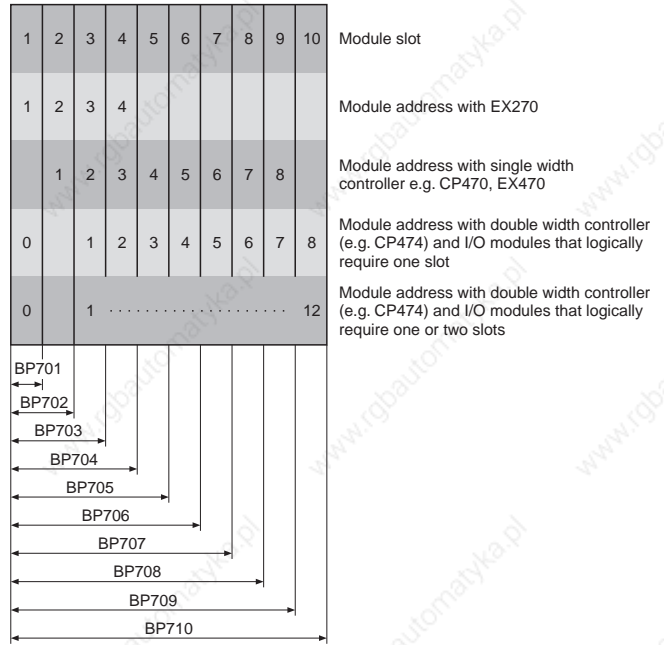

Bus Controller Modules

EX477 / EX777

Order Data

Model Number	Description	Figure
	Remote I/O Bus Controller	
7EX477.50-1	2003 Remote I/O bus controller, 24 VDC, 14 W Supply, 1 electrically isolated RS485 interface, For connecting to remote I/O bus	
7EX777.50-1	2003 Remote I/O bus controller, 100-240 VA, 14 W supply, 1 electrically isolated RS485 interface, For connecting to Remote I/O Bus	
	Accessories	
0G1000.00-090	Bus Connector, RS485, for PROFIBUS networks, remote I/O	
0AC916.9	Bus Termination, RS485, active, For PROFIBUS networks, Remote I/O, Standard mounting rail, Supply voltage: 120/230 VAC	
Additional information concerning accessories can be found in sections "Accessories" and "Manuals".		

Technical Data

Module ID	EX477	EX777
General		
C-UL-US Listed	YES	
Module Type	B&R 2003 Controller	
Module Width	B&R 2003 single width	
Module Location	1	
Peripherals		
Diagnosis LEDs	YES	
I/O Bus Connection	9 pin D-type connector (F)	
Number Switch	Set remote address	
Standard Communication Interface		
Interface	RS485	
Connection	9 pin D-type connector (F)	
Isolation	YES	
Baudrate	Depending on Distance	
100 kBit/sec	Max. 1200 m	
181 kBit/sec	Max. 1000 m	
500 kBit/sec	Max. 400 m	
1000 kBit/sec	Max. 200 m	
2000 kBit/sec	Max. 100 m	
Remote I/O Bus		
Access	Master/Slave-Principle	
Number of Slaves	Max. 31 (without repeater)	
Topology	Physical Bus	
Connection to Bus	Direct	
Transfer Medium	Shielded, twisted pair	
Termination Resistance	External	
Power Supply		
Input Voltage		
Minimum	18 VDC	85 VAC
Nominal	24 VDC	100 - 240 VAC
Maximum	30 VDC	264 VAC
Input Voltage Frequency	--	47 to 63 Hz
Power Consumption	Max. 20 W	
Output Power for I/O Modules and Screw-in Modules	14 W	

Description

A remote I/O bus controller takes over communication between a B&R remote master (B&R 2005 or B&R 2010) and the B&R 2003 I/O system. It also has the following local tasks:

- Initialization from power-on to active operation on a network
- Recording and sending input states (polled from the master)
- Receiving and switching the outputs
- Defined error behavior with network crashes and local problems

Bus Controller Modules

EX270

Order Data

Model Number	Description	Figure
	CAN Bus Controller	
7EX270.50-1	2003 CAN bus controller, 24 VDC, 4 W supply, 1 CAN interface, electrically isolated, network capable	
7TB712.9	2003 Terminal Block, 12 Pin, Screw Clamp	
7TB712.91	2003 Terminal Block, 12 Pin, Cage Clamp	
7TB712:90-02	2003 Terminal Blocks, 12 Pin, 20 pcs. Screw Clamp	
7TB712:91-02	2003 Terminal Block, 12 Pin, 20 pcs. Cage Clamp	
Additional information concerning accessories can be found in sections "Accessories" and "Manuals".		

Technical Data

Module ID	EX270
General	
C-UL-US Listed	in preparation
Module Type	B&R 2003 Controller
Module Width	20 mm
Installation	The controller is screwed onto the module rack instead of the left side section
Peripherals	
Diagnosis LEDs	YES
I/O Bus Interface	9 pin D-type socket
Number Switch	Set the node number and baudrate
Standard Communication Interface	
Application Interface	CAN Interface
Electrical Isolation	YES
Connector	12pin pin-connector
Distance	Max. 1000 m
Max. Baudrate	
Bus Length 10 - 60 m	500 kBit/sec
Bus Length 100 - 200 m	250 kBit/sec
Bus Length 800 - 1000 m	50 kBit/sec
Power Supply	
Input Voltage	
Minimum	18 VDC
Nominal	24 VDC
Maximum	30 VDC
Power Consumption	Max. 5 W
Output Power for I/O Modules and Screw-in Modules	Max. 4 W
Voltage Monitoring	The power supply is only activated above an input voltage of approx. +15 V. Therefore the Status LED DC-OK is not needed.

Description

A CAN bus controller takes over communication with a PCC, PLC, or other CAN compatible devices. Additionally, a CAN bus slave module handles the following local tasks:

- Initialization from power-on to active operation on a network
- Recording and sending input states
- Sending input states cyclically and/or when the input states change
- Receiving and switching the outputs
- Defined error behavior with network crashes and local problems
- Setting and changing the operating parameters can be done either with a special instruction which is sent from a CAN client (master) or with configurations memory.

Bus Controller Modules

EX470 / EX770

Order Data

Model Number	Description	Figure
	CAN Bus Controller	
7EX470.50-1	2003 CAN bus controller, 24 VDC, 14.5 W supply, 2 CAN interfaces, electrically isolated, network capable	
7EX770.50-1	2003 CAN bus controller, 100-240 VAC, 14.5 W supply, 2 CAN interfaces, electrically isolated, network capable	
	Accessories	
7AC911.9	Bus Connector, CAN	
0AC912.9	Bus adapter, CAN, 1 CAN interface	
0AC913.92	Bus adapter, CAN, 2 CAN interface, including 30 cm connection cable	
7ME770.5	2003 Configuration Memory for CAN Bus Controller	
Additional information concerning accessories can be found in sections "Accessories" and "Manuals".		

Technical Data

Module ID	EX470	EX770
General		
C-UL-US Listed	YES	
Module Type	B&R 2003 Controller	
Module Width	B&R 2003 single width	
Module Location	1	
Environmental Temperature during Operation	0 - 60 °C ^{1) 2)}	
Peripherals		
Diagnosis LEDs	YES	
I/O Bus Interface	9pin D-type connector (F)	
Number Switch	Set the node number and baudrate	
Standard Communication Interface		
Application Interface IF1 Isolated Connection Distance Max. Baudrate Bus Length 10 - 60 m Bus Length 100 - 200 m Bus Length 800 - 1000 m	CAN Interface (left) YES 9pin D-type connector (M) Max. 1000 m 500 kBit/sec 250 kBit/sec 50 kBit/sec	
Application Interface IF2 Isolated Connection Distance Max. Baudrate Bus Length 10 - 60 m Bus Length 100 - 200 m Bus Length 800 - 1000 m	CAN/ID Interface (right) YES 9pin D-type connector (F) Max. 1000 m 500 kBit/sec 250 kBit/sec 50 kBit/sec	
Power Supply		
Input Voltage Minimum Nominal Maximum	18 VDC 24 VDC 30 VDC	85 VAC 100 - 240 VAC 264 VAC
Input Voltage Frequency	---	47 to 63 Hz

Module ID	EX470	EX770
Power Consumption		Max. 20 W
Output Power for I/O Modules and Screw-in Modules		14.5 W ^{1) 2)}

¹⁾ Starting with revision 30.xx of EX470.

²⁾ Starting with revision 10.xx of EX770.

Description

A CAN bus controller takes over communication with a PCC, PLC, or other CAN compatible devices. Additionally, a CAN bus slave module handles the following local tasks:

- Initialization from power-on to active operation on a network
- Recording and sending input states
- Sending input states cyclically and/or when the input states change
- Receiving and switching the outputs
- Defined error behavior with network crashes and local problems
- Setting and changing the operating parameters can be done either with a special instruction which is sent from a CAN client (master) or with configurations memory.

CPUs

CP430 / CP47x / CP77x

Order Data

Model Number	Description	Figure
CPU		
7CP430.60-1	2003 CPU, 100 KB SRAM, 256 KB FlashPROM, 24 VDC, 6 W Supply, 1 RS232 Interface, 1 CAN Interface, CAN: Electrically Isolated, Network Capable	
7CP470.60-1	2003 CPU, 100 KB SRAM, 256 KB FlashPROM, 24 VDC, 16.5 W Supply, 1 RS232 Interface, 1 CAN Interface, CAN: elec.isolated, network capable	
7CP770.60-1	2003 CPU, 100 KB SRAM, 256 KB FlashPROM, 100-240 VAC, 16.5 W Supply, 1 S232 Interface, 1 CAN Interface, CAN: elec. isolated, network capable	
7CP474.60-1	2003 CPU, 100 KB SRAM, 512 KB FlashPROM, 24 VDC, 11 W Supply, 1 RS232 Interface, 1 CAN Interface (electrically isolated, network capable), 4 Slots for screw-in modules	
7CP774.60-1	2003 CPU, 100 KB SRAM, 512 KB FlashPROM, 100-240 VAC, 11 W Supply, 1 RS232 Interface, 1 CAN Interface (electrically isolated, network-capable), 4 slots for screw-in modules	
Accessories		
0G0001.00-090	Cable PC <-> PCC/PW, RS232, online cable	
0AC201.9	Lithium Batteries, 5 pcs, 3 V / 950 mAh	
7AC911.9	Bus Connector, CAN	
Buffer battery is included in delivery.		
Additional information concerning accessories can be found in sections "Accessories" and "Manuals".		

Technical Data

Module ID	CP430	CP470/CP770	CP474/CP774
General			
C-UL-US Listed	in preparation		YES
Module Type	B&R 2003 CPU		
Module Width	B&R 2003 single width		B&R 2003 double width
Module Location	1		1 + 2
Processor			
Instruction Cycle Time	Average time for 70 % bit- and 30 % analog processing 1.6 µsec		0.8 µsec
Standard Memory User-RAM System-PROM User-PROM	100 KByte SRAM 256 KByte FlashPROM 256 KByte FlashPROM		100 KByte SRAM 512 KByte FlashPROM 512 KByte FlashPROM
Data Buffering Buffer battery Buffer current	Lithium-Battery 3 V / 950 mAh		
Typical Maximum	1.6 µA 60 µA		2.2 µA 110 µA
Hardware Watchdog	YES		
Voltage Monitoring	The internal supply is monitored for over and under voltage		
Peripherals			
Real Time Clock Resolution	Nonvolatile 1 sec		
Status Display	LEDs		
I/O Bus Interface	9pin D-type connector (F)		
Slots for Screw-in Modules Suited for IF Modules	NO		4 1 - 3

Module ID	CP430	CP470/CP770	CP474/CP774
Standard Communication Interface			
Application Interface IF1 Isolated Connection Max. Distance Max. Baudrate	RS232 NO 9pin D-type connector (M) 15 m / 19200 Baud 115.2 kBaud		
Application Interface IF2 Isolated Connection Max. Distance Max. Baudrate Bus Length 10 - 60 m Bus Length 100 - 200 m Bus Length 800 - 1000 m	CAN YES 9pin D-type connector (M) 1000 m 500 kBit/sec 250 kBit/sec 50 kBit/sec		
Power Supply			
Input Voltage	CP430/CP470/CP474		CP770/CP774
Minimum	18 VDC		85 VAC
Nominal	24 VDC		100 - 240 VAC
Maximum	30 VDC		264 VAC
Input Voltage Frequency	---		47 - 63 Hz
Power Consumption	Max. 9.5 W	Max. 20 W	Max. 20 W
Output power for I/O Modules and Screw-in Modules on the Right Side of CPU	7 W ¹⁾	16.5 W ¹⁾	11 W ¹⁾

¹⁾ Integrated supply for basic PANELWARE operator panels (e.g. P120) via pin 4 of the RS232 interface

General Information

The CPU is operated on the far left hand side of the module rack. There are status LEDs and the connection sockets for an RS232 and a CAN interface on the module.

The CPUs CP474/CP774 have four slots for screw-in module. The screw-in modules are plugged into the CP interface as required, and are attached using the fastening screws.

The interface modules can be installed in slots 1, 2 and 3.

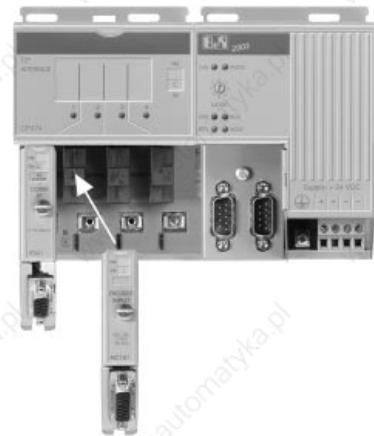

Module Overview

The following screw-in modules can be used on the CP Interface.

Module	Type	Description
7AI261.7	Analog INPUT	1 input to evaluate a full-bridge strain gauge
7AI294.7	Analog INPUT	4 inputs to evaluate a potentiometer
7AI351.70	Analog INPUT	1 x ± 10 V or 1 x 0 - 20 mA (± 20 mA also possible), potentiometer operation
7AI354.70	Analog INPUT	4 x ± 10 V
7AI774.70	Analog INPUT	4 x 0 - 20 mA (± 20 mA also possible)
7AO352.70	Analog OUTPUT	2 x ± 10 V / 0 - 20 mA
7AT324.70	Analog INPUT	4 x Temperature sensors (PT100, PT1000, KTY10 or KTY84)
7AT352.70	Analog INPUT	2 x PT100 3 wire
7AT664.70	Analog INPUT	4 x temperature sensor
7DI135.70	Digital INPUT	4 x 24 VDC, 50 kHz
7DO135.70	Digital OUTPUT	4 x 12 - 24 VDC, 0.1 A, 100 kHz
7DO164.70	Digital OUTPUT	4 x 48 - 125 VAC, 50 mA, zero cross detection
7IF311.7	Interface	1 x RS232
7IF321.7	Interface	1 x RS422/RS485
7IF361.70-1	Interface	1 x PROFIBUS DP-Slave
7IF371.70-1	Interface	1 x CAN
7NC161.7	Encoder Module	1 x 100 kHz, 5 / 24 VDC

Application Memory Module

ME770

Order Data

Model Number	Description	Figure
7ME770.5	2003 configuration memory for CAN bus controller	
Additional information concerning accessories can be found in section "Bus Controller Modules EX470/EX770".		

Technical Data

Module ID	ME770
C-UL-US Listed	YES
Memory Type	4 KBit S-EEPROM
Programming ME770 Programmed using	Must be on CAN bus slave module CAN-Library for PG2000, CAN Configurator
Interface Type	9pin D-type connector (M)
Power Consumption	0.1 W

Description

All operating parameters for a node are saved in the nonvolatile configuration memory. The node is initialized corresponding to the parameter in configuration memory after power-on.

The data is taken from configuration memory if...

- a) the node number set on the module corresponds to the one saved, or
- b) the node number 0 is set on the module.

Analog Interface (AF) Modules

AF101

Order Data

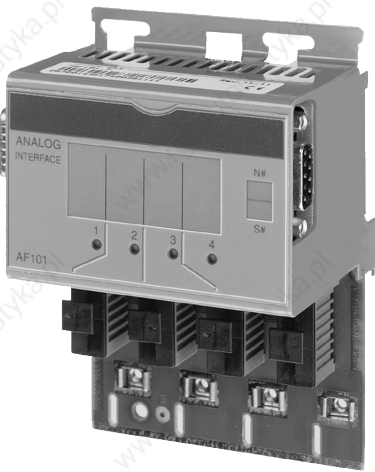
Model Number	Description	Figure
7AF101.7	2003 Analog Interface module, 4 Slots for screw-in modules	

Technical Data

Module ID	AF101
General	
C-UL-US Listed	YES
Module Slots	
CP430, EX270	2
CP470, CP770 CP474, CP774 EX470, EX770 EX477, EX777	4
Adapter Interface	4 Slots for screw-in modules
Isolation	NO
Status LEDs	For each channel
Power Consumption	Max. 0.3 W
Mechanical Characteristics	
Dimensions	B&R 2003 single width

General Information

The adapter module is equipped with four slots for screw-in modules. The screw-in modules required are plugged onto the adapter module and screwed into place.



Module Overview

The following screw-in modules can be used on the AF101 Adapter Module or the CP Interface.

Module	Type	Description
7AI261.7	Analog INPUT	1 input to evaluate a full-bridge strain gauge
7AI294.7	Analog INPUT	4 inputs to evaluate a potentiometer
7AI351.70	Analog INPUT	1 x ± 10 V or 1 x 0 - 20 mA (± 20 mA also possible), potentiometer operation
7AI354.70	Analog INPUT	4 x ± 10 V
7AI774.70	Analog INPUT	4 x 0 - 20 mA (± 20 mA also possible)
7AO352.70	Analog OUTPUT	2 x ± 10 V / 0 - 20 mA
7AT324.70	Analog INPUT	4 x Temperature sensors (PT100, PT1000, KTY10 or KTY84)
7AT352.70	Analog INPUT	2 x PT100 3 wire
7AT664.70	Analog INPUT	4 x temperature sensor
7DI135.70	Digital INPUT	4 x 24 VDC, 50 kHz
7DO135.70	Digital OUTPUT	4 x 12 - 24 VDC, 0.1 A, 100 kHz
7DO164.70	Digital OUTPUT	4 x 48 - 125 VAC, 50 mA, zero cross detection
7NC161.7	Encoder module	1 x 100 kHz, 5 / 24 VDC

Digital Input Modules

General Information

Digital Input modules convert the binary signals of a process into the internal signal necessary for the PCC. Status LEDs display the digital input states. Relevant distinguishing features for the input modules are:

- Number of inputs
- Input Voltage
- Input Delay (filter)
- Special Functions (e.g. counting input)

Input Filter

Each input is wired with a filter. The input delay is given in the technical data section. Interference pulses, which are shorter than the input delay, are suppressed by the input filter.

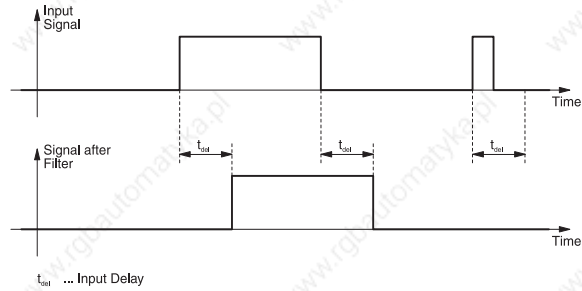

Overview Screw-in Modules

Module	DI135
Number of Inputs	4
Input Voltage Nominal	24 VDC
Input Frequency Incremental Encoder Event Counter	50 kHz 100 kHz
Number of Outputs	1
Operating Voltage Nominal	24 VDC
Continuous Current	0.5 A
Switching Frequency	Max. 20 kHz for resistive load

Overview I/O Modules

Module	DI435	DI439.7	DI439.72	DI645
Number of Inputs	8	16	8	16
Input Voltage	24 VDC	24 VDC	24 VDC	100 - 240 VAC
Input Delay	1 msec	1 msec	1 msec	50 msec
Remarks		Connection: Pin Connector	Connection: D-type connector (M)	

Digital Input Module

DI135

Order Data

Model Number	Description	Figure
7DI135.70	2003 Digital Input module, 4 Inputs 24 VDC, Sink, Incremental encoder operation: 50 kHz, Event counter operation: 100 kHz, 1 Comparator Output 24 VDC, Screw-in module, Order Terminal Block TB712 Separately!	
7TB712.9	2003 Terminal Block, 12 Pin, Screw Clamp	
7TB712.91	2003 Terminal Block, 12 Pin, Cage Clamp	
7TB712:90-02	2003 Terminal Blocks, 12 Pin, 20 pcs. Screw Clamp	
7TB712:91-02	2003 Terminal Block, 12 Pin, 20 pcs. Cage Clamp	

Technical Data

Module ID	DI135
General	
C-UL-US Listed	YES
Module Type	B&R 2003 Screw-in module
Slot	AF101 Adapter Module, CP Interface
Power Consumption	Max. 0.4 W
Inputs	
Number of Inputs	4
Wiring	Sink
Input Voltage Minimum Nominal Maximum	18 VDC 24 VDC 30 VDC
Input Frequency Incremental Encoder Event Counter	50 kHz 100 kHz
Switching Threshold LOW HIGH	<5 V >15 V
Input Delay	Max. 3 µsec (at 18 - 30 V)
Input Current at Nominal Voltage	8 mA
Isolation	Input - PCC
Incremental Encoder	
Signal Form	Square wave
Evaluation	4-fold
Input Frequency	50 kHz
Counter Frequency	200 kHz
Phase shift Between Channel A and B	90° ±25°
Counter size	32 Bit
Inputs Input 1 Input 2 Input 3 Input 4	Channel A Channel B Reference pulse R Reference enable switch ENR

Module ID	DI135
Event Counter	
Signal Form	Square Wave
Input Frequency	100 kHz
Counter size	2 x 16 Bit
Inputs Input 1 Input 2	Counter 1 Counter 2
Outputs	
Number of Outputs	1
Operating Voltage Minimum Nominal Maximum	18 VDC 24 VDC 30 VDC
Continuous Current	0.5 A
Switching Frequency	Max. 20 kHz for resistive load
Braking Voltage	45 V to 55 V
Diagnosis	Reverse polarity protection, Short-circuit protection, status monitored with software
Isolation	Output - PCC
Mechanical Characteristics	
Dimensions	B&R 2003 Screw-in module

General Information

The DI135 screw-in module can be used for the following tasks:

- Counting and measuring digital signals (internal measuring frequency 4 MHz)
- Gate time measurement
- Frequency measurement
- Event Counting
- Incremental encoder operation
- Reaction to input events in the µsec range
- Local counter monitoring with direct output control

Digital Input Module

DI435

Order Data

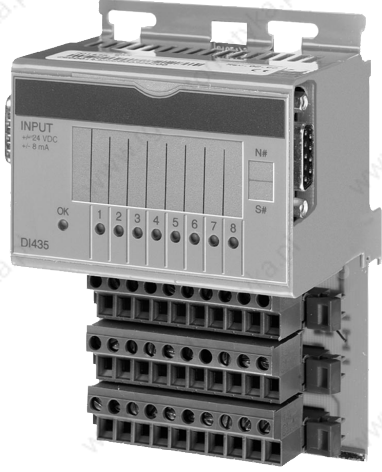
Model Number	Description	Figure
7DI435.7	2003 Digital input module, 8 Inputs 24 VDC, 1 msec, Sink/Source, Order terminal blocks separately!	
7TB710.9	2003 Terminal block 10 pin, screw clamps	
7TB710.91	2003 Terminal block 10 pin, cage clamps	
7TB710:90-01	2003 Terminal block 10 pin, 30 pieces, screw clamps	
7TB710:91-01	2003 Terminal block 10 pin, 30 pieces, cage clamps	
Terminal blocks not included in delivery.		

Chapter 2
B&R SYSTEM 2003

Technical Data

Module ID	DI435
General	
C-UL-US Listed	YES
Module Slot	
CP430, EX270	4
CP470, CP770, CP474, CP774 EX470, EX770, EX477, EX777	8
Static Characteristics	
Module Type	B&R 2003 I/O-Module
Number of Inputs	8
Wiring	Sink or Source
Input Voltage	
Minimum	18 VDC
Nominal	24 VDC
Maximum	30 VDC
Switching Threshold	
LOW	<5 V
HIGH	>15 V
Input Delay	Max. 1 msec (at 18 - 30 V)
Input Current at Nominal Voltage	Approx. 8 mA (Sink/Source)
Voltage Monitoring (LED: U-OK)	YES, Supply Voltage >18 V
Power Consumption	Max. 0.2 W
Operating Characteristics	
Isolation	Input – PCC
Mechanical Characteristics	
Dimensions	B&R 2003 single width

Digital Input Module

DI439.7

Order Data

Model Number	Description	Figure
7DI439.7	2003 Digital input module, 16 Inputs 24 VDC, 1 msec, Sink/Source, Order terminal blocks separately!	
7TB718.9	2003 Terminal block, 18 pin, screw clamp	
7TB718.91	2003 Terminal block, 18 pin, cage clamp	
7TB718:90-02	2003 Terminal block, 18 pin, 20 pieces screw clamp	
7TB718:91-02	2003 Terminal block, 18 pin, 20 pieces cage clamp	
Terminal blocks not included in delivery		

Technical Data

Module ID	DI439.7
General	
C-UL-US Listed	in preparation
Module Slot ¹⁾	
CP430, EX270	2
CP470, CP770, EX470, EX770 EX477, EX777	4
CP474, CP774	6
Static Characteristics	
Module Type	B&R 2003 I/O-Module
Number of Inputs	16
Wiring	Sink or Source
Input Voltage	
Minimum	18 VDC
Nominal	24 VDC
Maximum	30 VDC
Switching Threshold	
LOW	<5 V
HIGH	>15 V
Input Delay	Max. 1 msec (at 18 - 30 V)
Input Current at Nominal Voltage	Approx. 4 mA (Sink/Source)
Voltage Monitoring (LED: U-OK)	YES, Supply Voltage > 18 V
Power Consumption	Max. 0.4 W
Operating Characteristics	
Isolation	Input – PCC
Mechanical Characteristics	
Dimensions	B&R 2003 single width

¹⁾ Module requires 2 logical slots.

Digital Input Module

DI439.72

Order Data

Model Number	Description	Figure
7DI439.72	2003 Digital input module, 16 inputs 24 VDC, 1 msec, Sink/Source, 2 electrically isolated input groups	

Chapter 2
B&R SYSTEM 2003

Technical Data

Module ID	DI439.72
General	
C-UL-US Listed	in preparation
Module Slot ¹⁾	
CP430, EX270	2
CP470, CP770, EX470, EX770 EX477, EX777,	4
CP474, CP774	6
Static Characteristics	
Module Type	B&R 2003 I/O-Module
Number of Inputs Total in 2 groups of	16 8
Wiring	Sink or Source
Input Voltage Minimum Nominal Maximum	18 VDC 24 VDC 30 VDC
Switching Threshold LOW HIGH	<5 V >15 V
Input Delay	Max. 1 ms (at 18 - 30 V)
Input Current at Nominal Voltage	Approx. 4 mA (Sink/Source)
Voltage Monitoring (LED: U-OK)	YES, Supply Voltage > 18 V
Power Consumption	Max. 0.4 W
Operating Characteristics	
Isolation Input - PCC Group - Group	YES YES
Mechanical Characteristics	
Dimensions	B&R 2003 single width

¹⁾ Module requires two logical slots.

Digital Input Module

DI645

Order Data

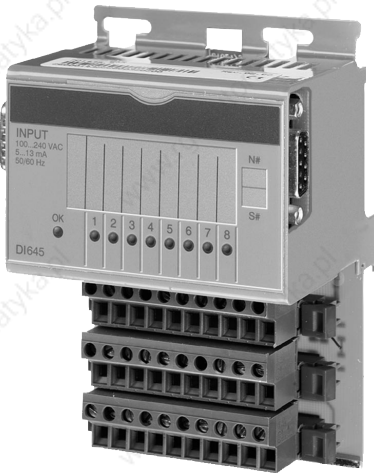
Model Number	Description	Figure
7DI645.7	2003 Digital Input Module, 8 Inputs 100-240 VAC, 50 ms, Order terminal blocks separately	
7TB710.9	2003 Terminal Block, 10 pin, screw clamp	
7TB710.91	2003 Terminal Block, 10pol, cage clamp	
7TB710:90-01	2003 Terminal Block, 10pol, 30 pieces, screw clamp	
7TB710:91-01	2003 Terminal Block, 10pol, 30 pieces, cage clamp	
Terminal block not included in delivery		

Technical Data

Module ID	DI645
General	
C-UL-US Listed	YES
Module Slots	
CP430, EX270	4
CP470, CP770, CP474, CP774 EX470, EX770, EX477, EX777	8
Static Characteristics	
Module Type	B&R 2003 I/O-Module
Number of Inputs	8
Wiring	Sink or Source
Input Voltage	
Minimum	85 VAC
Nominal	100 - 240 VAC
Maximum	264 VAC
Input Voltage Frequency	47 - 63 Hz
Switching Threshold	
LOW	Max. 40 VAC at 2 mA
HIGH	Min. 79 VAC
Input Delay	Max. 50 msec (at 85 - 264 VAC)
Input Current	
100 VAC / 60 Hz	Approx. 5 mA
240 VAC / 50 Hz	Approx. 11 mA
Voltage Monitoring (LED: U-OK)	YES, Supply Voltage >85 VAC
Power Consumption	Max. 0.2 W
Operating Characteristics	
Isolation	Input - PCC
Mechanical Characteristics	
Dimensions	B&R 2003 single width

Digital Output Modules

General Information

Digital output modules are used to control external loads (relays, motors, solenoids). The states of the digital outputs are indicated with status LEDs. The relevant differences in characteristics for the output modules are:

- Number of Outputs
- Type (relay, transistors)
- Switching Voltage
- Switching Current

Protective Circuit

The transistor output module DO435 had overload protection and an internal protection circuit for overload peaks or reverse polarity. The breakage voltage allows fast switching of inductive loads without external diodes.

The relay output module DO720 requires external overload protection (fuse).

The relay output module DO721 has a fuse for overload protection for every output.

Overview Screw-in Modules

Module	DO135	DO164
Number of Outputs	4	4
Type	FET	Triac Couplers
Switching	Push/Pull	---
Switching Voltage Minimum Nominal Maximum	11.4 VDC 11 – 24 VDC 30 VDC	48 – 125 VAC
Continuous Current Per Output Per Module	Max. 0.1 A Max. 0.4 A	Max. 0.05 A Max. 0.2 A
Ignition Pulse Current	---	Max. 0.5 A
Switching Frequency	Max. 100 kHz	96 – 126 Hz

Overview I/O Modules

Module	DO435	DO720	DO721	DO722
Number of Outputs	Max. 8	8	4	8
Type	FET	Relay	Relay	Relay
Switching		N.O	Changeover	N.O
Input Voltage Minimum Nominal Maximum	18 VDC 24 VDC 30 VDC	240 VAC / 30 VDC 264 VAC / 110 VDC	240 VAC / 24 VDC 264 VAC / 125 VDC	240 VAC / 24 VDC 264 VAC / 125 VDC
Continuous Current Per Output Per Module	Max. 2 A Max. 8 A	Max. 2 A Max. 12 A	Max. 4 A Max. 16 A	Max. 2.5 A Max. 20 A

Digital Output Module

DO135

Order Data

Model Number	Description	Figure
7DO135.70	2003 Digital output module, 4 FET-output 12 to 24 VDC, 0.1 A, Screw-in module, Order Terminal Block TB712 Separately!	
7TB712.9	2003 Terminal Block, 12 Pin, screw clamp	
7TB712.91	2003 Terminal Block, 12 Pin, cage clamp	
7TB712:90-02	2003 Terminal Blocks, 12 Pin, 20 pcs. screw clamp	
7TB712:91-02	2003 Terminal Block, 12 Pin, 20 pcs. cage clamp	

Technical Data

Module ID	DO135
General	
C-UL-US Listed	YES
Slot	AF101 Adapter Module, CP-Interface
Static Characteristics	
Module Type	B&R 2003 screw-in module
Number of Outputs	4
Type	FET
Switching	Push/Pull
Switching Voltage / Supply	
Minimum	11.4 VDC
Nominal	12 - 24 VDC
Maximum	30 VDC
Protection	Reverse Polarity Protection
Continuous Current	
Per Output	Max. 0.1 A
Per Module	Max. 0.4 A
Maximum Switching Frequency	100 kHz
Residual Voltage	Max. 0.6 V at 0.1 A
Capacitive Load	Max. 20 nF An Overcurrent warning is given for large capacitive loads during the switching process
Power Consumption	Max. 0.2 W
Protection	
Protective Circuit	
Short Circuit	YES
Overload	YES
Short Circuit Current	0.11 – 0.3 A
Diagnos status after Software Evaluation	
Overvoltage	Us >30 VDC Voltage >35 VDC at t >5 msec damages the outputs
Undervoltage	Us <10,5 VDC
Overcurrent Monitoring	Switch on duration of at least 10 µsec
Dynamic Characteristics	
Switching Delay	
Typical	<2 µsec
Maximum	2.4 µsec

Module ID	DO135
Operating Characteristics	
Isolation Output – PCC Output - Output	NO NO
Mechanical Characteristics	
Dimensions	B&R 2003 Screw-in module

General Information

The DO135 is a 4 channel output module. The type of operation can be set for each output separately. The following types of operation are possible:

- Normal operation
- Pulse width modulation (PWM)
- TPU operation

Normal Operation

The outputs are switched on / off.

Pulse Width Modulation

The outputs are switched on / off periodically. Pulse width, period and resolution can be set.

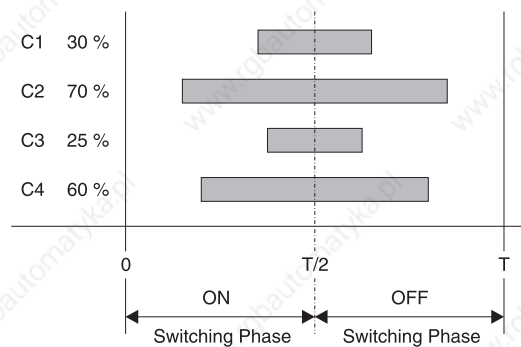

TPU Operation

In TPU operation, the outputs are controlled using TPU. If, for example, the DO135 module is installed in the first slot on the CP Interface, the first output can be controlled using the LTX function LTXdo0().

Special Functions

- The supply voltage is monitored ($10.5 \text{ VDC} < U_s < 30 \text{ VDC}$)
- The channels are equipped with current cutoff (readable).

Digital Output Module

DO164

Order Data

Model Number	Description	Figure
7DO164.70	2003 Digital Output Module, 4 FET Outputs 48 to 125 VAC, 0.05 A, Zero Cross Detection, Screw-in Module, Order Terminal Block TB712 Separately!	
7TB712.9	2003 Terminal Blocks, 12 pin, screw clamps	
7TB712.91	2003 Terminal Blocks, 12 pin, cage clamps	
7TB712:90-02	2003 Terminal Blocks, 12 pin, 20 screw clamps	
7TB712:91-02	2003 Terminal Blocks, 12 pin, 20 cage clamps	

Technical Data

Module ID	DO164
General	
C-UL-US Listed	in preparation
Slot	AF101 Adapter Module, CP-Interface
Module Type	B&R 2003 screw-in Module
Zero Voltage Input (Connection Pins 11 and 12)	
Number of Inputs	1
Rated Voltage	48 to 125 VAC
Rated Frequency	48 to 63 Hz
Input Impedance in Signal Range	1 M Ω Symmetrical, 500 k Ω to GND = Earth
Switching Threshold Low Range High Range	≤ 5 V ≥ 5 V
Switching Hysteresis	0.2 V
Tolerance of the Zero Cross Signal at 48 to 125 VAC	0 to 100 μ sec
Electrical Isolation	NO
Triac Outputs	
Number of Outputs	4
Type of Output ¹⁾	Triac Coupler, only for control of Power Triacs or non Parallel Thyristors
Rated Voltage	48 to 125 VAC
Rated Frequency	48 to 63 Hz
Output Current Continuous Current Ignition Pulse Current	Max. 50 mA Max. 0.5 A
Residual Voltage	Max. 2.5 V at 50 mA
Holding Current	Max. 3.5 mA
Leakage Current (0 Signal)	Max. 1 μ A
Critical Voltage in Switched Off Status	>500 V/ μ sec
Drive Pulse Duration (TPU Outputs)	>250 μ sec
Power Consumption	Max. 0.6 W

Module ID	DO164
Protection Characteristics	
Protection	No Short Circuit Protection
Type of external protection RC Combination Gate Resistance	Reducing dV/dt Increasing the Resistance to Disturbance
Dynamic Characteristics	
Delay Time 0 to 1	Max. 200 µsec
Delay Time 1 to 0	Max. 200 µsec
Operating Characteristics	
Isolation Input – Output Output – Output	YES YES
Recommended Cable Type	Twisted pair to the Terminals
Cable Length Power Triac	Max. 10 m
Mechanical Characteristics	
Dimensions	B&R 2003 screw-in Module

1) Due to the very low value (dV/dt)_c of the Triac coupler („Critical Rate of Rise of Commutating Voltage“), the Triac output is not suitable as a SSR relay for direct switching of loads.

General Information

The screw-in module DO164 is equipped with four output channels. It is used to output ignition pulses for phase angle control on power triacs.

The module is either attached to the adapter module AF101 or to the CP interface.

Digital Output Module

DO435

Order Data

Model Number	Description	Figure
7DO435.7	2003 Digital output module, 8 FET output 24 VDC, 2 A, Outputs can be optionally used as inputs, Order terminal blocks separately!	
7TB710.9	2003 Terminal Block, 10 pin, screw clamp	
7TB710.91	2003 Terminal Block, 10pol, cage clamp	
7TB710:90-01	2003 Terminal Block, 10pol, 30 pieces, screw clamp	
7TB710:91-01	2003 Terminal Block, 10pol, 30 pieces, cage clamp	
Terminal block not included in delivery		

Technical Data

Module ID	DO435
General	
C-UL-US Listed	YES
Module Type	B&R 2003 I/O Module, single width
Module Slots	
CP430, EX270	4
CP470, CP770, CP474, CP774 EX470, EX770, EX477, EX777	8
Voltage Monitoring (LED: U-OK)	YES
Supply Voltage	>18 V
Power Consumption	Max. 0.5 W
Outputs	
Number of Outputs	Max. 8
Type	FET
Switching Voltage / Supply	
Minimum	18 VDC
Nominal	24 VDC
Maximum	30 VDC
Continuous Current	
Per Output	Max. 2 A
Per Module	Max. 8 A
Simultaneousness	
at 1 A	100%
at 2 A	50% (note derating curve)
Residual Voltage	Max. 1 V at 2 A
Protection	
Short Circuit	YES
Overload	YES
Short Circuit Current at 24 V	Approx. 20 A until switched off
Breaking Voltage when Switching Inductive Loads	Approx. 46 V

Module ID	DO435
Switching Delay log. 0 - log. 1 log. 1 - log. 0	Aprox. 200 μ sec Typ. 50 μ sec / Max. 250 μ sec Typ. 170 μ sec / Max. 250 μ sec
Max. Switching Frequency Resistive Load Inductive Load	100 Hz see Diagram "switching Inductive Loads"
Isolation	Outout – PCC

All Channels can either be used as inputs or outputs on this module. All outputs must be defined as such. After each power-on, all channels are configured as inputs (by default).

Technical Data for the inputs

Module ID	DO435
Number of Inputs	Max. 8
Wiring	Sink
Input Voltage Minimum Nominal Maximum	18 VDC 24 VDC 30 VDC
Switching Threshold LOW HIGH	<5 V >15 V
Input Delay	Max. 1 msec (at 18 - 30 V)
Input Current at Nominal Delay	Approx. 6 mA
Isolation	Input – PCC

Digital Output Module

DO720

Order Data

Model Number	Description	Figure
7DO720.7	2003 Digital output modules, 8 Relay output 240 VAC / 30 VDC, 2 A, Order terminal blocks separately!	
7TB710.9	2003 Terminal Block, 10 pin, screw clamp	
7TB710.91	2003 Terminal Block, 10pol, cage clamp	
7TB710:90-01	2003 Terminal Block, 10pol, 30 pieces, screw clamp	
7TB710:91-01	2003 Terminal Block, 10pol, 30 pieces, cage clamp	
Terminal block not included in delivery		

Technical Data

Module ID	DO720
General	
C-UL-US Listed	YES
Module Slots	
EX270	2
CP430	4
CP470, CP770, CP474, CP774 EX470, EX770, EX477, EX777	8
Static Characteristics	
Module Type	B&R 2003 I/O Module
Number of Outputs	8
Type	Relay / N.O
Switching Voltage Nominal Maximum	240 VAC / 30 VDC 264 VAC / 110 VDC
Continuous Current Per Output Per Module	2 A 12 A
Contact Resistance	30 mΩ at 6 VDC, 1 A
Max. Switching Capacity (AC)	480 VA
Max. Switching Capacity (DC)	60 W
Power Consumption	Max. 1.4 W
Protection	
Short Circuit	Fuse 16 AT (slow-blow)
Dynamic Characteristics	
Switching Delay log 0 - log 1 log 1 - log 0	Max. 10 msec Max. 10 msec
Operating Characteristics	
Isolation	Output - PCC
Isolation Voltage Capacity Contact - Contact Contact - Coil	750 VAC / 1 min 2000 VAC / 1 min
Mechanical Characteristics	
Dimensions	B&R 2003 single width

Digital Output Module

DO721

Order Data

Model Number	Description	Figure
7DO721.7	2003 Digital output module, 4 Relay outputs 240 VAC / 24 VDC, 4A	
7AC011.9	2003 Stress relief attachment, 5 pcs, Incl. mounting material	
Terminal block are included in delivery		

Technical Data

Module ID	DO721
General	
C-UL-US Listed	YES
Module Slots	
EX270	2
CP430	4
CP470, CP770, CP474, CP774	8
EX470, EX770, EX477, EX777	
Static Characteristics	
Module Type	B&R 2003 I/O Module
Number of Outputs	4 isolated channels
Type	Relay / Change-over
Switching Voltage	
Nominal at 4 A	240 VAC / 24 VDC
Maximum	264 VAC / 125 VDC
Maximum Voltage Relay – Relay	460 VAC
Continuous Current	
Per Output	4 A
Per Module	16 A
Switch on Current	15 A / 200 msec
Contact Resistance	100 mΩ at 6 VDC, 100 mA
Max. Switching Capacity (AC)	1000 VA
Max. Switching Capacity (DC)	120 W at 30 VDC
Power Consumption	Max. 1.4 W
Protection	
Short Circuit	Fuse T 5A H / 250 V per output
Dynamic Characteristics	
Switching Delay	
log 0 - log 1	Max. 10 msec
log 1 - log 0	Max. 10 msec
Operating Characteristics	
Isolation	Output – PCC, Output - Output
Isolation Voltage Capacity	
Contact - Contact	1.4 kV at 1.2 x 50 μsec pulse
Contact – PCC, Relay - Relay	4 kV at 1.2 x 50 μsec pulse
Mechanical Characteristics	
Dimensions	B&R 2003 single width

Digital Output Module

DO722

Order Data

Model Number	Description	Figure
7DO722.7	2003 Digital output module, 8 Relay outputs 240 VAC / 24 VDC, 2.5 A	
7AC011.9	2003 stress relief attachments, 5 pcs, incl. mounting material	
0AC171.9	Glass fuses 5 x 20 mm, 20 pieces, 3.15 A T / 250 V	
Terminal blocks are contained in delivery.		

Technical Data

Module ID	DO722
General	
C-UL-US Listed	YES
Module Slots	
EX270	2
CP430	4
CP470, CP770, CP474, CP774 EX470, EX770, EX477, EX777	8
Static Characteristics	
Module Type	B&R 2003 I/O Module
Number of Outputs	8 isolated Channels
Type	Relay / N.O
Switching Voltage Nominal at 4 A Maximum Maximum Voltage Relay - Relay	240 VAC / 24 VDC 264 VAC / 125 VDC 460 VAC
Continuous Current Per Output Per Module	2.5 A 20 A
Max. Switching Capacity (AC)	625 VA
Max. Switching Capacity (DC)	75 W at 30 VDC
Power Consumption	Max. 1.4 W
Protection	
Short Circuit	Fuse T 3.15 A H / 250 V per output
Dynamic Characteristics	
Output Delay for Signal Changes from log 0 - log 1 log 1 - log 0	Max. 10 msec Max. 10 msec
Operating Characteristics	
Isolation Output - PCC Output - Output	YES YES
Mechanical Characteristics	
Dimensions	B&R 2003 single width

Digital Mixed Modules

General Information

Digital mixed modules are a combination of digital input and output modules. The states of the digital inputs/outputs are indicated using Status LEDs.

Overview

Module	DM435	DM438	DM465
Number of Inputs	8	8	16
Nom. Input Voltage	24 VDC	24 VDC	24 VDC
Number of Outputs	8	8	16
Nom. Switching Voltage	24 VDC	24 VDC	24 VDC
Continuous Current	0.5 A	0.5 A	0.5 A
Connection	Terminal	D-Type	Terminal

Digital Mixed Module

DM435

Order Data

Model Number	Description	Figure
7DM435.7	2003 digital mixed module 8 Inputs 24 VDC, 1 msec, Sink/Source 8 Transistor outputs, 24 VDC, 0,5 A Order terminal blocks separately!	
7TB710.9	2003 Terminal Block, 10 pin, screw clamp	
7TB710.91	2003 Terminal Block, 10 pin, cage clamp	
7TB710:90-01	2003 Terminal Block, 10 pin, 30 pieces, screw clamp	
7TB710:91-01	2003 Terminal Block, 10 pin, 30 pieces, cage clamp	
7TB722.9	2003 Terminal Block, 22 pin, screw clamps	
7TB722.91	2003 Terminal Block, 22 pin, cage clamps	
7TB733.9	2003 Terminal Block, 33 pin, screw clamps	
7TB733.91	2003 Terminal Block, 33 pin, cage clamps	
Terminal blocks not included in delivery.		

Technical Data

Module ID	DM435
General	
C-UL-US Listed	YES
Voltage and Output Monitoring (LED: OK)	YES, Supply Voltage > 18 V, Output OK
Power Consumption	Max. 0.5 W
Module Slots	
CP430, EX270	4
CP470, CP770, CP474, CP774 EX470, EX770, EX477, EX777	8
Inputs	
Number of Inputs	8
Wiring	Sink or Source
Input Voltage	
Minimum	18 VDC
Nominal	24 VDC
Maximum	30 VDC
Switching Threshold	
LOW	<5 V
HIGH	>15 V
Input Delay	Max. 1 msec
Input Current at Nominal Voltage	Approx. 8 mA
Isolation	Input - PCC
Outputs	
Number of Outputs	8
Type	Highside Driver IC (Transistor)
Switching Voltage	
Minimum	18 VDC
Nominal	24 VDC
Maximum	30 VDC
Continuous Current	
Per Output	Max. 0.5 A
Per Module	Max. 4 A
Leakage Current when switched off	12 µA

Module ID	DM435
Overload Protection	YES
Continuous Short Circuit Current	Typ. 4 A
Internal Protection Circuit	YES
Breaking Voltage with Internal Load Switched Off	47 V
Switching Delay log. 0 - log. 1 log. 1 - log. 0	Max. 450 µsec Max. 450 µsec
Isolation	Output - PCC
Mechanical Characteristics	
Dimensions	B&R 2003 single width

Digital Mixed Module

DM438

Order Data

Model Number	Description	Figure
7DM438.72	2003 Digital mixed module, 8 Inputs 24 VDC, 1 ms, Sink/Source 8 Transistor outputs 24 VDC, 0,5 A	

Technical Data

Module ID	DM438
General	
C-UL-US Listed	in preparation
Module Type	B&R 2003 I/O Module
Module Slots	
CP430, EX270	4
CP470, CP770, CP474, CP774 EX470, EX770, EX477, EX777	8
Voltage and Output Monitoring (LED: OK)	YES, Supply Voltage >18 V, Output OK
Power Consumption	Max. 0.5 W
Inputs	
Number of Inputs	8
Wiring	Sink or Source
Input Voltage	
Minimum	18 VDC
Nominal	24 VDC
Maximum	30 VDC
Switching Threshold	
LOW	<5 V
HIGH	>15 V
Input Delay	Max. 1 msec
Input Current at Nominal Voltage	Approx. 8 mA
Isolation	Input - PCC
Outputs	
Number of Outputs	8
Type	Highside Driver IC (Transistor)
Switching Voltage	
Minimum	18 VDC
Nominal	24 VDC
Maximum	30 VDC
Continuous Current	
Per Output	Max. 0.5 A
Per Module	Max. 4 A
Leakage Current when Switched Off	12 μ A

Module ID	DM438
Overload Protection	YES
Continuous Short Circuit Current	Typ. 4 A
Internal Protection Circuit	YES
Braking Voltage with Inductive Load Switch Off	47 V
Switching Delay log. 0 - log. 1 log. 1 - log. 0	Max. 450 µsec Max. 450 µsec
Isolation	Output - PCC
Mechanical Characteristics	
Dimensions	B&R 2003 single width

Digital Mixed Module

DM465

Order Data

Model Number	Description	Figure
7DM465.7	2003 Digital mixed module, 16 Inputs 24 VDC, 1 msec, Sink, 16 Transistor outputs 24 VDC, 0,5 A, Order terminal blocks separately!	
7TB718.9	2003 Terminal block, 18 pin, screw clamps	
7TB718.91	2003 Terminal block, 18 pin, cage clamps	
7TB718:90-02	2003 Terminal block, 18 pin, 20 pieces, screw clamps	
7TB718:91-02	2003 Terminal block, 18 pin, 20 pieces, cage clamps	
7TB736.9	2003 Terminal block, 36 pin, screw clamps	
7TB736.91	2003 Terminal block, 36 pin, cage clamps	
7TB772.91	2003 Terminal block, 72 pin, cage clamps	
Terminal blocks not included in delivery.		

Technical Data

Module ID	DM465
General	
C-UL-US Listed	in preparation
Module Type	B&R 2003 I/O Module
Module Slots ¹⁾	
CP430, EX270	2
CP470, CP770 EX470, EX770, EX477, EX777	4
CP474, CP774	6
Voltage and Output Monitoring	YES (LED: OK), Supply Voltage >18 V, Outputs OK
Power Consumption	Max. 1.1 W
Inputs	
Number of Inputs	16
Wiring	Sink
Input Voltage	
Minimum	18 VDC
Nominal	24 VDC
Maximum	30 VDC
Switching Threshold	
LOW	<5 V
HIGH	>15 V
Input Delay	Max. 1 msec
Input Current at Nominal Voltage	Approx. 4 mA
Isolation	
Input – PCC	YES
Input – Output	NO
Outputs	
Number of Outputs	16
Type	Highside Driver IC (Transistor)
Switching Voltage	
Minimum	18 VDC
Nominal	24 VDC
Maximum	30 VDC

Module ID	DM465
Continuous Current Per Output Per Module	Max. 0.5 A Max. 8 A
Leakage Current when Switched off	12 µA
Overload Protection	YES
Switch after Overload Protection	Automatic within seconds (depending on module temperature)
Continuous Short Circuit Protection	Typ. 4 A
Internal Protection Circuit	YES
Braking Voltage when Switching Off Inductive Loads	47 V
Switching Delay log. 0 - log. 1 log. 1 - log. 0	Max. 450 µsec Max. 450 µsec
Isolation Output – PCC Output – Input	YES NO
Mechanical Characteristics	
Dimensions	B&R 2003 single width

Analog Input Modules

General Information

With analog input modules, measured values (voltages, current) are converted into numerical values which can be processed in the PCC.

Analog data is always in the 16 bit two's complement in the PCC, regardless of the resolution. For this reason, the resolution of the input module does not have to be taken into consideration when the application program is made.

A status LED is assigned to every adapter module on the analog interface module. This indicates that the input module is working.

Overview

Module	AI261	AI294
Number of Inputs	1	4
Input Signal	± 1 to ± 16 mV/V	0 to 4,5 V
Digital Converter Resolution	24 Bit	13 Bit
Remarks	1 Input for Full Bridge Strain Gauge Measurement	4 Inputs for Potential Evaluation (e.g. Transducer)

Module	AI351	AI354	AI774
Number of Inputs	1	4	4
Input Signal	± 10 V or 0 – 20 mA	± 10 V	0 – 20 mA
Digital Converter Resolution	12 Bit + sign	12 Bit + sign	12 Bit

Analog Input Modules

AI261

Order Data

Model Number	Description	Figure
7AI261.7	2003 Analog input module, 1 input for evaluation of full bridge, strain gauge data, 24 Bit Screw-in module	

Technical Data

Module ID	AI261
General	
C-UL-US Listed	YES
Slot	AF101 Adapter Module, CP-Interface
Static Characteristics	
Module Type	B&R 2003 screw-in module
Number of Inputs	1
Digital Converter Resolution	24 Bit
Measured Value Resolution Calibration Linearization Conversion	Using software, also during operation $y = k * x + d$ In physical units (32 Bit-Representation)
Measurement Range	± 1 to ± 16 mV/V, set by Software
Input Current	<140 nA
Operating Range / Measuring Gauge	75 to 5000 Ω
Bridge Operating Voltage Short Circuit and Overload Protection Connection	4.5 VDC ± 3 % / Max. 60 mA YES 4 Wire connection
Sensor Type	Isolated
Internal Power Consumption	Max. 0.6 W
Operating Characteristics	
Isolation Voltage under Normal Operating Conditions and between Channel and Bus	No Electronic Isolation
Mechanical Characteristics	
Dimensions	B&R 2003 screw-in module

General Information

A strain gauge bridge can be used for the following tasks:

- Force Gauge
- Bending Elasticity Gauge
- Weight Measurement Cell
- Pressure Gauge
- Strain Gauge
- Torsion Meter

Analog Input Module

AI294

Order Data

Model Number	Description	Figure
7AI294.7	2003 Analog input module, 4 inputs, potentiometer-evaluation, 13 Bit, screw-in module	

Technical Data

Module ID	AI294
General	
C-UL-US Listed	YES
Slot	AF101 Adapter Module, CP-Interface
Static Characteristics	
Module Type	B&R 2003 screw-in module
Number of Inputs	4
Digital Converter Resolution	13 Bit
Potentiometer Supply U_{pot}	+4.5 V \pm 3 % at 40 mA
Short Circuit and Overload Protection	YES
Input Current	<0,2 μ A
Transducer	0.5 to 10 k Ω , Potentiometer
Measurement Range	0 V to U_{pot}
Sensor Type	Isolated
Internal Power Consumption	Max. 0.5 W
Operating Characteristics	
Isolation Voltage under Normal Operating Conditions between Channel and Bus	No electrical isolation
Mechanical Characteristics	
Dimensions	B&R 2003 screw-in module

Analog Input Module

AI351

Order Data

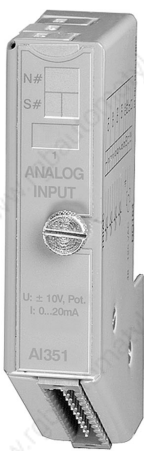
Model Number	Description	Figure
7AI351.70	2003 Analog Input Module, 1 Input, +/- 10 V or 0 to 20 mA, 12 bit + sign. screw-in module, order terminal block TB712 separately!	
7TB712.9	2003 Terminal Block, 12 pin, screw clamp	
7TB712.91	2003 Terminal Block, 12 pin, cage clamp	
7TB712:90-02	2003 Terminal Block, 12 pin, 20 pieces, screw clamp	
7TB712:91-02	2003 Terminal Block, 12 pin, 20 pieces, cage clamp	

Technical Data

Module ID	AI351
General	
C-UL-US Listed	YES
Slot	AF101 Adapter Module, CP-Interface
Static Characteristics	
Module Type	B&R 2003 screw-in module
Number of Inputs	1 Differential input
Input Signal Current Voltage	Set with switch 0 - 20 mA (also ±20 mA) ±10 V
Potentiometer Voltage	±9.94 V at max. 10 mA
Digital Converter Resolution	12 Bit + sign
Differential Input Resistance Voltage Current (Load)	20 MΩ 130 - 200 Ω
Power Consumption Current / Voltage Measurement Potentiometer Operation	Max. 0.3 W Max. 0.7 W
Operating Characteristics	
Isolation Input – PCC	NO
Mechanical Characteristics	
Dimensions	B&R 2003 screw-in module

Analog Input Module

AI354

Order Data

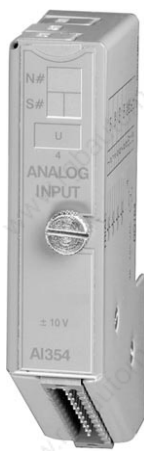
Model Number	Description	Figure
7AI354.70	2003 Analog Input Module, 4 Inputs, +/- 10 V, 12 Bit + sign, Screw-in Module, Order Terminal Block TB712 Separately!	
7TB712.9	2003 Terminal Block, 12 pin, screw clamp	
7TB712.91	2003 Terminal Block, 12 pin, cage clamp	
7TB712:90-02	2003 Terminal Block, 12 pin, 20 pieces, screw clamp	
7TB712:91-02	2003 Terminal Block, 12 pin, 20 pieces, cage clamp	

Technical Data

Module ID	AI354
General	
C-UL-US Listed	YES
Slot	AF101 Adapter Module, CP-Interface
Static Characteristics	
Module Type	B&R 2003 screw-in module
Number of Inputs	4 Differential inputs
Input Signal	±10 V
Digital Converter Resolution	12 Bit + sign
Differential Input Resistance	20 MΩ
Power Consumption	Max. 0.5 W
Operating Characteristics	
Isolation Input – PCC Input - Input	 NO NO
Mechanical Characteristics	
Dimensions	B&R 2003 screw-in module

Analog Input Module

AI774

Order Data

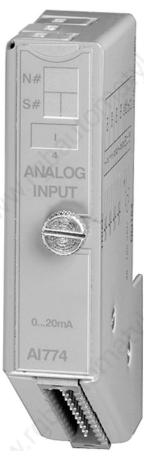
Model Number	Description	Figure
7AI774.70	2003 Analog Input module, 4 Inputs, 0 to 20 mA, 12 Bit, Screw-in module, Order Terminal Block TB712 Separately!	
7TB712.9	2003 Terminal Block, 12 pin, screw clamp	
7TB712.91	2003 Terminal Block, 12 pin, cage clamp	
7TB712:90-02	2003 Terminal Block, 12 pin, 20 pieces, screw clamp	
7TB712:91-02	2003 Terminal Block, 12 pin, 20 pieces, cage clamp	

Chapter 2
B&R SYSTEM 2003

Technical Data

Module ID	AI774
General	
C-UL-US Listed	YES
Slot	AF101 Adapter Module, CP-Interface
Static Characteristics	
Module Type	B&R 2003 screw-in module
Number of Inputs	4 Differential inputs
Input Signal	0 - 20 mA (also ± 20 mA)
Digital Converter Resolution	12 Bit
Differential Input Resistance (Load)	130 – 200 Ω
Power Consumption	Max. 0.4 W
Operation Characteristics	
Isolation	
Input – PCC	NO
Input – Input	NO
Mechanical Characteristics	
Dimensions	B&R 2003 screw-in module

Analog Output Modules

General Information

Analog Output Modules convert internal PCC numerical values into voltages or currents. The numerical values to be converted must be in 16 bit two's complement. Conversion occurs regardless of the resolution of the output module used.

A status LED is assigned to every analog output module on the analog interface module. This indicates that the output module is working.

Overview

Module	AO352
Number of Outputs	2
Output Signal	± 10 V or 0 – 20 mA
Digital Converter Resolution	12 Bit

Analog Output Module

AO352

Order Data

Model Number	Description	Figure
7AO352.70	2003 Analog Output module, 2 Outputs., +/- 10 V or 0-20 mA, 12 Bit, Screw-in module, Order Terminal Block TB712 Separately!	
7TB712.9	2003 Terminal Block, 12 pin, screw clamp	
7TB712.91	2003 Terminal Block, 12 pin, cage clamp	
7TB712:90-02	2003 Terminal Block, 12 pin, 20 pieces, screw clamp	
7TB712:91-02	2003 Terminal Block, 12 pin, 20 pieces, cage clamp	

Technical Data

Module ID	AO352
General	
C-UL-US Listed	YES
Slot	AF101 Adapter Module, CP-Interface
Static Characteristics	
Module Type	B&R 2003 screw-in module
Number of Outputs	2
Output Signal Current Voltage	Can be set with switch for each channel 0 - 20 mA ±10 V
Digital Converter Resolution	12 Bit
Short Circuit Protection	YES
Power Consumption	Max. 1.2 W
Current Output	
Load	Max. 400 Ω
LSB Value (12 Bit)	5.16 μA ±2.4 % / LSB
Voltage Output	
Load	Max. 10 mA
LSB Value (12 Bit)	5.15 mV ±0.8 % / LSB
Operating Characteristics	
Isolation Output – PCC Output – Output	NO NO
Mechanical Characteristics	
Dimensions	B&R 2003 screw-in module

Temperature Modules

General Information

With temperature modules, temperatures measured values are converted into numerical values which can be processed in the PCC.

Numerical values are always in the 16 bit two's complement in the PCC, regardless of the resolution. For this reason, the resolution of the temperature module does not have to be taken into consideration when the application program is made.

When temperatures are being measured, the temperature module delivers the measurement values units of in 0.1°. This means that a result of 750 corresponds to 75.0°C. By default, the data format 0.1°C is supported by all temperature modules. With some temperature modules, a higher resolution can be used.

A status LED is assigned to every temperature module on the adapter module. This indicates that the temperature module is working.

Overview

Module	AT324	AT352	AT664
Number of Channels	4	2	4
Measurement Range	-200 to +850 °C	-200 to +850 °C	-270 to +1372 °C
Sensor	KTY10-6 KTY84-130 PT100 PT1000	PT100	FeCuNi Type J NiCrNi Type K PtRhPt Type S
Raw Value Processing	YES	NO	YES
Digital Converter Resolution	16 Bit	16 Bit	16 Bit

Temperature Module

AT324

Order Data

Model Number	Description	Figure
7AT324.70	2003 Analog Input Module, 4 Temperature Inputs (2-Wire Connection), KTY10 -50 to +150 °C, KTY84 -40 to +300 °C, PT100 -200 to +850 °C, PT1000 -200 to +850 °C, Screw-in module. Order Terminal Block TB712 Separately!	
7TB712.9	2003 Terminal Block, 12 pin, screw clamp	
7TB712.91	2003 Terminal Block, 12 pin, cage clamp	
7TB712:90-02	2003 Terminal Block, 12 pin, 20 pieces, screw clamp	
7TB712:91-02	2003 Terminal Block, 12 pin, 20 pieces, cage clamp	

Technical Data

Module ID	AT324
General	
C-UL-US Listed	in Preparation
Slot	AF101 Adapter Module, CP-Interface
Static Characteristics	
Module Type	B&R 2003 screw-in module
Type of Inputs	Resistance measurement in 2 wire operation with constant current supply
Number of Inputs	4
Sensor	
KTY10-6	-50 °C to +150 °C
KTY84-130	-40 °C to +300 °C
PT100	-200 °C to +850 °C
PT1000	-200 °C to +850 °C
Type of Wiring	2 Wire
Converter Method	Sigma Delta
Digital Converter Resolution	16 Bit
Input Amplification	Can be set for all Channels by Software
G = 1	KTY10-6, KTY84-130, PT1000
G = 2	PT100
Reference	5 kΩ ±0.1 %
Measurement Current	200 μA ±5.22 %
Resistance Measurement Range	
at G = 1	1 to 4995 Ω
at G = 2	1 to 2497,5 Ω
Converter Time per Channel	
Input Amplification	
Standardized	60 msec
Varying	190 msec
Resolution in °C	
KTY10-6	1 LSB = 0.01 °C
KTY84-130	1 LSB = 0.03 °C
PT100	1 LSB = 0.15 °C
PT1000	1 LSB = 0.03 °C
Resolution in ?	
at G = 1	1 LSB = 76.29395 mΩ ±0.1 %
at G = 2	1 LSB = 38.14697 mΩ ±0.1 %
Data Format	INT16

Module ID	AT324
Resolution KTY10-6 KTY84-130 PT100 PT1000	Set according to Channel -50.00 °C to +150.00 °C -40.00 °C to +300.00 °C -200.0 °C to +850.0 °C -200.0 °C to +850.0 °C
Value Range in Resistance Measurement at G = 1 at G = 2	Set according to Channel 0.1 Ω to 5000.0 Ω 0.05 Ω to 5000.0 Ω
Measurement Range Monitoring Open Inputs Broken Wire Below Range ¹⁾ Over Range General Errors	\$7FFF \$7FFF \$8001 \$7FFF \$8000
Common Mode Rejection DC 50 Hz	>90 dB >150 dB
Cross Talk between the Channels	Typ. 100 dB
Dynamic Characteristics	
Input Filter Type Square Frequency	Low Pass, First Order 150 Hz
Operating Characteristics	
Isolation Input – PCC Input – Input	NO NO
Mechanical Characteristics	
Dimensions	B&R 2003 screw-in module

¹⁾ Only on Measurements with Temperature Sensor

General Information

The AT324 screw-in module is equipped with four input channels. It is used to handle measurements for PT100, PT1000, KTY10-6 and KTY84-130 temperature sensors.

The module can be installed on either the AF101 adapter module or on the CP Interface.

Temperature Module

AT352

Order Data

Model Number	Description	Figure
7AT352.70	2003 Analog Input Module, 2 Inputs, PT100 (3 Line connection), -200 to +850°C Screw-in Module, Order Terminal Block TB712 Separately!	
7TB712.9	2003 Terminal Block, 12 pin, screw clamp	
7TB712.91	2003 Terminal Block, 12 pin, cage clamp	
7TB712:90-02	2003 Terminal Block, 12 pin, 20 pieces, screw clamp	
7TB712:91-02	2003 Terminal Block, 12 pin, 20 pieces, cage clamp	

Chapter 2
B&R SYSTEM 2003

Technical Data

Module ID	AT352
General	
C-UL-US Listed	in Preparation
Slot	AF101 Adapter Module, CP-Interface
Static Characteristics	
Module Type	B&R 2003 screw-in module
Number of Inputs	2
Sensor Type Connection Standard	PT100 3-Line connection IEC/EN 60751
Digital Converter Resolution	16 Bit
Measurement Range	2 Ranges can be set
Small Range Resolution	-200.00 to +327.67 °C 0.01 °C
Large Range Resolution	-200.0 to +850.0 °C 0.1 °C
Measurement Update	20 or 16.67 msec
Conversion of Measured Value of Temperature Value	Automatic in module
Measurement Current	2 mA
Power Consumption	Max. 0.4 W
Operating Characteristics	
Isolation Input – PCC Input – Input	NO NO
Mechanical Characteristics	
Dimensions	B&R 2003 screw-in module

Temperature Module

AT664

Order Data

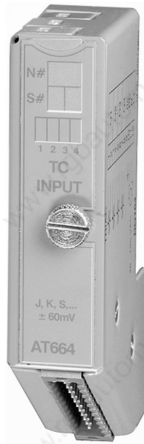
Model Number	Description	Figure
7AT664.70	2003 Analog Input Module, 4 Inputs, thermocouple, -270 to +1372 °C, Screw in module, Order Terminal Block TB712 Separately!	
7TB712.9	2003 Terminal Block, 12 pin, screw clamp	
7TB712.91	2003 Terminal Block, 12 pin, cage clamp	
7TB712:90-02	2003 Terminal Block, 12 pin, 20 pieces, screw clamp	
7TB712:91-02	2003 Terminal Block, 12 pin, 20 pieces, cage clamp	

Technical Data

Module ID	AT664
General	
C-UL-US Listed	YES
Slot	AF101 Adapter Module, CP-Interface
Static Characteristics	
Module Type	B&R 2003 screw-in module
Number of Inputs	4
Sensors	Thermocouple
Digital Converter Resolution	16 Bit
Measurement Range	According to sensor type ¹⁾
Sensor Temperature	
FeCuNi: Type J	-210 to +1200 °C
NiCrNi: Type K	-270 to +1372 °C
PtRhPt: Type S	-50 to +1768 °C
Terminal Temperature	-55 to +125 °C
Raw Value	±65534 µV
Resolution	
Sensor Temperature Output	0.1 °C / LSB
Terminal Temperature Output	0.1 °C / LSB
Raw Value Output	2 µV / LSB
Conversion of Measured Value to Temp. Value	Automatic in module
Terminal Temp Compensation	YES
Power Consumption	Max. 0.4 W
Operating Characteristics	
Isolation	
Input – PCC	NO
Input – Input	NO
Mechanical Characteristics	
Dimensions	B&R 2003 screw-in module

¹⁾ Configured using software.

Scan Order

The analog input module AT664 scans the inputs with a consistent cycle time.

Sensor Type Selection

Each input can be set individually to the desired sensor type. Raw value measurement and automatic thermocouple calculations can be combined without restriction.

Other Modules

General Information

The combination module is a combination of digital and analog I/O modules. The status of the digital I/O is indicated using Status LEDs.

Overview

Module	CM211	CM411
Digital Inputs		
Number of Inputs	8	3
Input Voltage Nominal	24 VDC	24 VDC
Digital Outputs		
Number of Outputs	8	2
Rated Voltage	24 VDC	24 VDC
Continuous Current	0.5 A	0.5 A
Analog Inputs		
Number of Inputs	2	3
Input Signal	± 10 V or 0 - 20 mA	± 10 V
Resolution	12 Bit	16 Bit
Analog Outputs		
Number of Outputs	2	3
Output Signal	± 10 V	± 10 V
Resolution	12 Bit	16 Bit

Other Module

CM211

Order Data

Model Number	Description	Figure
7CM211.7	2003 Combination module, 8 inputs, 24 VDC, 4 msec, sink, 3 one channel - or 2 two channel counters or 2 incremental encoders, 20 kHz, 8 transistor outputs, 24 VDC, 0.5 A Comparator, short circuit protection, 2 inputs, +/- 10 V / 0-20 mA, 12 Bit, 2 outputs, +/- 10 V, 12 Bit, Order terminal blocks separately!	
7TB718.9	2003 Terminal block, 18 pin, screw clamps	
7TB718.91	2003 Terminal block, 18 pin, cage clamps	
7TB718:90-02	2003 Terminal block, 18 pin, 20 pieces, screw clamp, variant 90-02	
7TB718:91-02	2003 Terminal block, 18 pin, 20 pieces, cage clamp, variant 91-02	
7TB736.9	2003 Terminal Block, 36 pin, screw clamps	
7TB736.91	2003 Terminal Block, 36 pin, cage clamps	
Terminal blocks not included in delivery.		

Technical Data

Module ID	CM211
General	
C-UL-US Listed	in preparation
Module Type	B&R 2003 I/O Module
Slot	
CP430, EX270, EX470, EX770	2
CP470, CP770, CP474, CP774 EX477, EX777	4
External Voltage Monitoring	YES (LED: OK), Supply Voltage > 18 V
Isolation	
Analog – PCC	NO
Digital – PCC	NO
Digital – Analog	NO
Power Consumption	Max. 1.5 W
Analog Inputs	
Type of Inputs	Asymmetric
Number of Inputs	2
Input Signal Nominal	± 10 V / 0 - 20 mA, per channel, set with switch
Maximum Permitted Continuous Load (without damage)	± 15 V / ± 50 mA
Digital Converter Resolution	12 Bit
Data Format sent to Application Program	INT16
Value Range	
Voltage	
+10 V	\$7FFF
0 V	\$0000
-10 V	\$8001
Current	
20 mA	\$7FFF
0 mA	\$0000
Measurement Range Monitoring	
Open Inputs	\$7FFF
Range Exceeded (below)	
Voltage	\$8001
Current	\$0000
Range Exceeded (above)	\$7FFF
General Error	\$8000

Module ID	CM211
Converter Method	Successive approximation
Converter Time	<4 msec for both channels. The channels are cyclically converted
Input Impedance in Signal Range on Voltage Input	≥1 MΩ
Input Impedance in Signal Range on Current Input (Load)	95 - 200 Ω
Input Filter	Cut off frequency 500 Hz
Analog Outputs	
Number of Outputs	2
Output Signal	±10 V
Load	Max. ±10 mA
Digital Converter Resolution	12 Bit
Data Format in Application	INT16
Value Range	
+10 V	\$7FFF
0 V	\$0000
-10 V	\$8001
Converter Time	<4 msec for both channels
Load Impedance	≥1 kΩ
Short Circuit Protection	YES
Digital Inputs	
Number of Inputs	8
Type of Inputs	3 x Event Counter, 3 x Period duration measurement, 3 x Gate time measurement, 2 x Incremental encoder ABR (+24 V), 1 x Comparator
Input Voltage	
Minimum	18 VDC
Nominal	24 VDC
Maximum	30 VDC
Input Current at Nominal Voltage	Approx. 4 mA
Wiring	Sink
Switching Threshold	
LOW	<5 V
HIGH	>15 V
Delay Time 0 to 1 with SW Filter without SW Filter	<4 msec (default) <0.01 ms
Delay Time 1 to 0 with SW Filter without SW Filter	<4 msec (default) <0.01 ms
Status Display	8 green LEDs
Incremental Encoder Operation	
Signal Form	Square Wave
Evaluation	4 fold, Counter repeats
Input Frequency	20 kHz
Counter Frequency	80 kHz
Counter Size	32 Bit
Input 1	Reference encoder switch 1
Input 2	Channel A1
Input 3	Channel B1
Input 4	Channel R1
Input 5	Channel A2
Input 6	Channel B2
Input 7	Channel R2
Input 8	Reference encoder switch 2
Event Counter Operation	
Signal Form	Square Wave
Evaluation	Each edge, counter repeats
Input Frequency	20 kHz
Counter Frequency	40 kHz
Counter Size	16 Bit
Input 2	Counter 1
Input 3	Counter 2
Input 5	Counter 3

Module ID	CM211
Period Duration Measurement Signal Form Evaluation Input Frequency Counter Frequency Internal Counter Frequency External Counter Size Input 3 Input 4 Input 7 Input 2 Input 5	Square Wave Positive edge - negative edge 20 kHz 16 MHz, 4 MHz, 1 MHz, 250 kHz Max. 20 kHz 16 Bit Period channel 1 Period channel 2 Period channel 3 External counter frequency for the channels 1 and 2 External counter frequency for channel 3
Gate Time Measurement Signal Form Evaluation Input Frequency Counter Frequency Internal Counter Frequency External Counter Size Gate Pause Input 3 Input 4 Input 7 Input 2 Input 5	Square Wave Positive edge - negative edge 10 kHz 16 MHz, 4 MHz, 1 MHz, 250 kHz Max. 20 kHz 16 Bit 50 µsec Gate channel 1 Gate channel 2 Gate channel 3 External counter frequency for the channels 1 and 2 External counter frequency for channel 3
Comparator Comparator Output Reaction Time Evaluation Incremental Encoder Operation Event Counter Operation	Output 1 <500 µsec Actual value of the counter stand of incremental encoder 1 Comparison of the counter stand of counter 2 (Window comparator)
Isolation Input – Input	NO
Digital Outputs	
Number and Type of Outputs	8 Transistor Outputs
Measurement Current	Max. 0.5 A
Total Output Current	Max. 4 A
Rated Voltage	24 VDC
Switching Voltage Range	18 - 30 VDC
Leakage Current (0 Signal)	12 µA
Wiring	Source
Short Circuit Protection	YES
Overload Protection	YES
Braking Voltage when Switching Off Inductive Loads	47 V
Delay Time 0 to 1	<1.5 msec
Delay Time 1 to 0	<1.5 msec
Status Display	8 orange LEDs
Isolation Output – Output	NO
Mechanical Characteristics	
Dimensions	B&R 2003 single width

¹⁾ Module requires two logical slots.

²⁾ Refers to the measurement range.

Other Module

CM411

Order Data

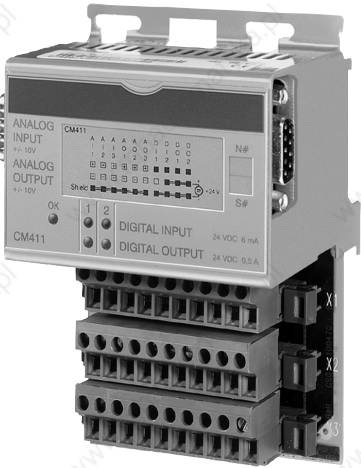
Model Number	Description	Figure
7CM411.70-1	2003 Combination Module, 3 Inputs, 24 VDC, 50 kHz, Sink, One or two channel counter, Incremental Encoder, 2 Transistor outputs, 24 VDC, 0,5 A, Comparator, short circuit protection, 3 inputs, +/- 10 V, 16 Bit, 3 outputs, +/- 10 V, 16 Bit, Order terminal blocks separately!	
7TB710.9	2003 Terminal Block, 10 pin, screw clamp	
7TB710.91	2003 Terminal Block, 10 pin, cage clamp	
7TB710:90-01	2003 Terminal Block, 10 pin, 30 pieces, screw clamp	
7TB710:91-01	2003 Terminal Block, 10 pin, 30 pieces, cage clamp	
Terminal blocks not included in delivery.		

Technical Data

Module ID	CM411
General	
C-UL-US Listed	in preparation
Module Type	B&R 2003 I/O Module
Voltage and Output Monitoring	YES (LED: OK), Supply Voltage > 18 V, Outputs OK
Isolation	
Analog – PCC	NO
Digital – PCC	YES
Digital – Analog	YES
Power Consumption	Max. 2.4 W
Slots ¹⁾	
CP430, EX270	1
CP470, CP770, CP474, CP774 EX470, EX770, EX477, EX777	2
Analog Inputs	
Number of Inputs	3
Input Signal Nominal	±10 V
Digital Converter Resolution	16 Bit
Data Format sent to Application Program	INT16
Value Range	
+10 V	\$7FFF
-10 V	\$8001
Measurement Range Monitoring	
Open Inputs	\$7FFF
Range Exceeded (Below)	\$8001
Range Exceeded (Above)	\$7FFF
General Error	\$8000
Input Impedance in Signal Range	≥1 MΩ
Analog Outputs	
Number of Outputs	3
Output Signal	±10 V
Load	Max. ±10 mA
Digital Converter Resolution	16 Bit

Module ID	CM411
Load Impedance	≥1 kΩ
Short Circuit Current	±15 mA (Continuous short circuit protection)
Digital Inputs	
Number of Inputs	3 Counter Inputs
Wiring	Sink
Input Voltage Minimum Nominal Maximum	18 VDC 24 VDC 30 VDC
Switching Threshold LOW HIGH	<5 V >15 V
Input Delay	Max. 3 µsec
Input Current at Nominal Voltage	Approx. 6 mA
Incremental Encoder Operation Signal Form Evaluation Input Frequency Counter Frequency Counter Size Input 1 Input 2 Input 3	Square Wave 4 fold, Counter repeated 50 kHz 200 kHz 32 Bit Channel A Channel B Ref
Event Counter Operation Signal Form Evaluation Input Frequency Counter Frequency Counter Size Input 1 Input 2	Square Wave Each edge, counter repeated 100 kHz 200 kHz 2 x 16 Bit Counter 1 Counter 2
Comparator Evaluation Comparator Output Reaction Time	Actual value compared to counter value in incremental operation or from counter 2 in event counter operation (Window comparator) Outputs 1 <100 µsec
Isolation Input - Input	NO
Digital Outputs	
Number and Type of Outputs	2 Transistor Outputs
Measurement Currents	Max. 0.5 A
Total Output Current	Max. 1 A
Rated Voltage	24 VDC
Switching Voltage Range	18 - 30 VDC
Wiring	Source
Short Circuit Protection	YES
Overload Protection	YES
Braking Voltage when Switching off Inductive Loads	59 V
Switching Delay log. 0 - log. 1 log. 1 - log. 0	Max. 100 µsec Max. 100 µsec
Isolation Output - Output	NO
Mechanical Characteristics	
Dimensione	B&R 2003 single width

¹⁾ Module requires two logical slots.

²⁾ Refers to the measurement range.

Communication Modules

General Information

Module	Description
IF311	2003 Interface module, 1 RS232 Interface, Screw-in module
IF321	2003 Interface module, 1 RS485/RS422 Interface, Electronically isolated, network capable, Screw-in module
IF361	2003 Interface module, 1 RS485 interface, Electrically isolated, network capable, Transfer protocol: PROFIBUS DP, Screw-in module
IF371	2003 Interface module, 1 CAN interface, Electrically isolated, network capable, Screw-in module

Communication Module

IF311

Order Data

Model Number	Description	Figure
	Interface Module	
71F311.7	2003 Interface module, 1 RS232 Interface, Screw-in module	
	Accessories	
0G0001.00-090	Cable PC <-> PCC/PW, RS232, online cable	

Technical Data

Module ID	IF311
General	
C-UL-US Listed	YES
Module Type	2003 screw-in module
Slot	CP-Interface, slot 1, 2 and 3
Power Consumption	Max. 0.5 W Max. 1.6 W with P120 / P121 ¹⁾
Standard Communication Interface	
Interface Type	RS232
Isolation Interface – PCC	No
Connection	9 pin D-type connector (M)
Handshake Lines	RTS, CTS
Baudrate	Max. 115.2 kBaud
Distance	15 m at 19200 Baud
Network Capable	NO
Data Format	
Data Bits	5 to 8
Parity	Yes / No / Even / Odd
Stop Bits	1 / 2
Mechanical Characteristics	
Dimensions	B&R 2003 screw-in module

¹⁾ Integrated current supply over pin 4 on the RS232 interface for basic PANELWARE operator panels, e.g. P120.

Communication Module

IF321

Order Data

Model Number	Description	Figure
	Interface Module	
7IF321.7	2003 Interface module, 1 RS485/RS422 Interface, Electronically isolated, network capable, Screw-in module	
	Accessories	
0G1000.00-090	Bus Connector, RS485, for PROFIBUS networks, remote I/O	
0AC916.9	Bus Termination, RS485, active, for PROFIBUS networks, Remote I/O, Standard mounting rail, Supply voltage: 120 / 230 VAC	
Additional information concerning accessories can be found in sections "Accessories" and "Manuals".		

Technical Data

Module ID	IF321
General	
C-UL-US Listed	YES
Module Type	2003 screw-in module
Slot	CP-Interface, Slots 1, 2 and 3
Power Consumption	Max. 1.4 W
Standard Communication Interface	
Interface Type	RS485/RS422 ¹⁾
Isolation Interface – PCC	YES
Connection	9 pin D-type connector (F)
Handshake Lines	---
Baudrate	Max. 115.2 kBaud ¹⁾
Distance	1200 m (without Repeater)
Network Capable	YES
Data Format	
Data Bits	7 / 8
Parity	Yes / No / Even / Odd
Stop Bits	1 / 2
Mechanical Characteristics	
Dimensions	B&R 2003 screw-in modules

¹⁾ Configured using software.

Communication Module

IF361

Order Data

Model Number	Description	Figure
	Interface Module	
7IF361.70-1	2003 Interface module, 1 RS485 interface, Electrically isolated, network capable, Transfer protocol: PROFIBUS DP, Screw-in module	
	Accessories	
0G1000.00-090	Bus Connector, RS485, for PROFIBUS networks, remote I/O	
0AC916.9	Bus Termination, RS485, active, for PROFIBUS networks, Remote I/O, Standard mounting rail, Supply voltage: 120 / 230 VAC	
Additional information concerning accessories can be found in sections "Accessories" and "Manuals".		

Technical Data

Module ID	IF361
General	
C-UL-US Listed	in preparation
Module Type	2003 screw-in module
Slot	CP-Interface, Slots 1, 2 and 3
Power Consumption	Max. 2.6 W
Standard Communication Interface	
Interface Type	RS485
Controller	ASIC SPC3
RAM	1.5 KByte
Transfer Protocol	PROFIBUS-DP
Connection	9 pin D-type connector (F)
Isolation	YES
Maximum Difference	1000 m
Protective Circuit	YES
Maximum Baudrate	
Bus Length <100 m	12 MBit/sec
Bus Length <200 m	1.5 MBit/sec
Bus Length <400 m	500 kBit/sec
Bus Length <1000 m	187.5 kBit/sec
Network Capable	YES
Bus Termination Resistance	External using T-connector
Mechanical Characteristics	
Dimensions	B&R 2003 screw-in module

Communication Module

IF371

Order Data

Model Number	Description	Figure
	Interface Module	
7IF371.70-1	2003 Interface module, 1 CAN interface, Electrically isolated, network capable, Screw-in module	
	Accessories	
7AC911.9	Bus Connector, CAN	
Additional information concerning accessories can be found in sections "Accessories" and "Manuals".		

Technical Data

Module ID	IF371
General	
C-UL-US Listed	YES
Module Type	2003 screw-in module
Slot	CP-Interface, Slots 1, 2 and 3
Power Consumption	Max. 2.5 W
Standard Communication Interface	
Interface Type	CAN
Isolation	Interface - PCC
Connection	9 pin D-type connector (M)
Interface LEDs	RXD and TXD
Maximum Distance	1000 m
Maximum Baudrate	
Bus Length 10 - 60 m	Max. 500 kBit/sec
Bus Length 100 - 200 m	Max. 250 kBit/sec
Bus Length 800 - 1000 m	Max. 50 kBit/sec
Network Capable	YES
Mechanical Characteristics	
Dimensions	B&R 2003 screw-in module

Counter and Positioning Modules

General Information

Module	Description
NC161	2003 Encoder module, Input frequency 100 kHz, Incremental or absolute, 32 Bit, Encoder supply 5 VDC or 24 VDC, Screw-in module

Counter and Positioning Module

NC161

Order Data

Model Number	Description	Figure
7NC161.7	2003 Encoder module, Input frequency 100 kHz, Incremental or absolute, 32 Bit, Encoder supply 5 VDC or 24 VDC, Screw-in module	
Additional information concerning accessories can be found in sections "Accessories" and "Manuals".		

Technical Data

Module ID	NC161
General	
C-UL-US Listed	YES
Module Type	2003 screw-in module
Slot	AF101 Adapter Module, CP-Interface
Power Consumption	0.3 W + I _{Enc} * 5.4 V
Encoder Input	
General	15 pin D-type connector (F) Incremental of SSI absolute encoder (both electrically isolated)
Incremental Encoder Signal Form Evaluation Input Counter Frequency Phase Shift between Channel A and B Counter Size Inputs Input Level	Square Wave 4 fold Max. 100 kHz Max. 400 kHz 90° ±15° 32 Bit A, A', B, B', R, R' 5 V (Differential Input)
SSI-Absolute Encoder Coding Word Size Baudrate Data Input Level Clock Output Level Maximum Signal Delay Clock - Data	Gray, Binary Max. 31 Bit 100 kBaud 5 V (Differential signal) 5 V (Differential signal) ≤2,5 µsec
Additional Inputs +24 VDC Reference Enable Switch Isolation Reference Pulse Isolation	Terminal Connection YES 15 pin D-type connector (Pin 10 and 11) YES
Encoder Supply	
Output Voltage Protection	+5 VDC / Max. 500 mA without external supply Short Circuit and Overload
External Supply Voltage Protection	+24 VDC / Max. 300 mA Short Circuit
Mechanical Characteristics	
Dimensions	B&R 2003 screw-in module

General Information

The NC161 is an encoder module with symmetrical incremental encoder or absolute encoder evaluation.

The 5 V encoder supply is provided directly from the module. The 24 V encoder supply voltage has to be connected externally.

Types of Operation

The NC161 is used in together an AO352 analog output module for single axis positioning with ramps.

Special Functions

- Latching the counter status with reference enable switch
- Comparator output can be used for incremental encoder operation

Accessories

General Information

Model Number	Description
7AC010.9	2003 Bus cover, 5 pcs
7AC011.9	2003 Stress relief, 5 pcs, incl. mounting material
7TB710.9	2003 Terminal Block, 10 pin, screw clamp
7TB710.91	2003 Terminal Block, 10 pin, cage clamp
7TB710:90-01	2003 Terminal Block, 10 pin, 30 pieces, screw clamp
7TB710:91-01	2003 Terminal Block, 10 pin, 30 pieces, cage clamp
7TB712.9	2003 Terminal Block, 12 pin, screw clamp
7TB712.91	2003 Terminal Block, 12 pin, cage clamp
7TB712:90-02	2003 Terminal Block, 12 pin, 20 pieces, screw clamp
7TB712:91-02	2003 Terminal Block, 12 pin, 20 pieces, cage clamp
7TB718.9	2003 Terminal block, 18 pin, screw clamps
7TB718.91	2003 Terminal block, 18 pin, cage clamps
7TB718:90-02	2003 Terminal block, 18 pin, 20 pieces, screw clamps
7TB718:91-02	2003 Terminal block, 18 pin, 20 pieces, cage clamps
7TB722.9	2003 Terminal Block, 22 pin, screw clamps
7TB722.91	2003 Terminal Block, 22 pin, cage clamps
7TB733.9	2003 Terminal Block, 33 pin, screw clamps
7TB733.91	2003 Terminal Block, 33 pin, cage clamps
7TB736.9	2003 Terminal block, 36 pin, screw clamps
7TB736.91	2003 Terminal block, 36 pin, cage clamps
7TB772.91	2003 Terminal block, 72 pin, cage clamps

Accessories

AC010

Order Data

Model Number	Description	Figure
7AC010.9	2003 Bus Cover, 5 pcs.	

General Information

If there are free slots, we recommend that you attach a bus cover at the first free slot. Therefore, the last module is protected from damage.

Accessories

AC011

Order Data

Model Number	Description	Figure
7AC011.9	2003 stress relief attachment, 5 pcs, incl. mounting material	

General Information

To avoid stress on connectors when cabling modules, this attachment for stress-relief is used.

The stress-relief attachment is installed under the module. For this purpose, a threaded strip is pushed into the module rack, and the stress-relief attachment is screwed into place with two screws. The installation material is delivered with the stress-relief attachment.

The wires to the module are fixed to the attachment with cable ties. In this way, the connectors are free from stress, and safe electrical wiring is guaranteed.

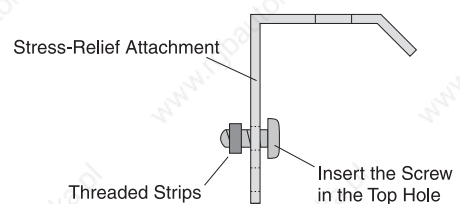

Accessories

TB710

Order Data

Model Number	Description	Figure
7TB710.9	2003 Terminal Block, 10 pin, screw clamp	
7TB710.91	2003 Terminal Block, 10 pin, cage clamp	
7TB710:90-01	2003 Terminal Block, 10 pin, 30 pieces, screw clamp	
7TB710:91-01	2003 Terminal Block, 10 pin, 30 pieces, cage clamp	
<p>Most modules are terminated using this single row 10 pin terminal block. It has a compact structure and is easy to remove (using two ejection levers on the module)</p>		

Technical Data

Module ID	TB710
Number of Pins	10
Type of Terminal Block	Screw or cage clamps
Distance between Contacts	5.08 mm
Contact Resistance	6 mΩ
Nominal Voltage	250 V
Current Load ¹⁾	Max. 12 A / Contact
Connection Cross Section	0.14 mm ² (AWG26) – 2.5 mm ² (AWG12)
Type of Cable	Only copper wire (No Aluminum wire!)
Removal	Mechanical

¹⁾ Take the respective limits for I/O modules into consideration!

Accessories

TB712

Order Data

Model Number	Description	Figure
7TB712.9	2003 Terminal Block, 12 pin, screw clamp	
7TB712.91	2003 Terminal Block, 12 pin, cage clamp	
7TB712:90-02	2003 Terminal Block, 12 pin, 20 pieces, screw clamp	
7TB712:91-02	2003 Terminal Block, 12 pin, 20 pieces, cage clamp	
<p>This single row 12 pin terminal block is used to terminate screw-in modules. It can be removed using two ejection levers on the terminal block.</p>		

Technical Data

Module ID	TB712
Number of Pins	12
Type of Terminal Block	Screw or cage clamps
Distance between Contacts	3.5 mm
Nominal Voltage	125 V
Current Load ¹⁾	Max. 12 A / Contact
Connection Cross Section	0.08 mm ² (AWG28) – 1.5 mm ² (AWG16)
Type of Cable	Only copper wire (No Aluminum wire!)
Removal	Mechanical

¹⁾ Take the respective limits for I/O modules into consideration!

Accessories

TB718

Order Data

Model Number	Description	Figure
7TB718.9	2003 Terminal block, 18 pin, screw clamps	
7TB718.91	2003 Terminal block, 18 pin, cage clamps	
7TB718:90-02	2003 Terminal block, 18 pin, 20 pieces, screw clamps	
7TB718:91-02	2003 Terminal block, 18 pin, 20 pieces, cage clamps	
<p>This single row 18 pin terminal block is used to terminate B&R 20003 I/O modules. It can be removed using two ejection levers on the terminal block.</p>		

Technical Data

Module ID	TB718
Number of Pins	18
Type of Terminal Block	Screw or cage clamps
Distance between Contacts	3.5 mm
Nominal Voltage	125 V
Current Load ¹⁾	Max. 12 A / Contact
Connection Cross Section	0.08 mm ² (AWG28) – 1.5 mm ² (AWG16)
Type of Cable	Only copper wire (No Aluminum wire!)
Removal	Mechanical

¹⁾ Take the respective limits for I/O modules into consideration!

Accessories

TB722

Order Data

Model Number	Description	Figure
7TB722.9	2003 Terminal Block, 22 pin, screw clamps	
7TB722.91	2003 Terminal Block, 22 pin, cage clamps	
<p>The TB722 terminal block is used to supply the digital inputs on the DM435 module. It is a 22 pin double row terminal block with offset terminal strips. The contacts on the front row are connected together and the ones on the back row are also connected together. This creates a positive and GND strip.</p>		

Technical Data

Module ID	TB722	
Number of Pins	22	
Type of Terminal Block	Screw od cage clamps	
Distance between Contacts	5.08 mm	
Nominal Voltage	250 V	
Current Load ¹⁾	Max. 12 A / Contact	
Connection Cross Section	0.14 mm ² (AWG26) – 2.5 mm ² (AWG12)	
Type of Cable	Only copper wire (No Aluminum wire!)	
Measurements	TB722.9	TB722.91
Height	33	33
Width	76	76
Depth	52	33

¹⁾ Take the respective limits for I/O modules into consideration!

Accessories

TB733

Order Data

Model Number	Description	Figure
7TB733.9	2003 Terminal Block, 33 pin, screw clamps	
7TB733.91	2003 Terminal Block, 33 pin, cage clamps	
<p>The terminal block TB733 is used as an additional jumper terminal, if the digital mixed module DM435 is operated with a three wire connection. The TB733 consists of one 33 pin pin block, which is a screw clamp or a cage clamps. All connections in a pin row are connected together.</p>		

Technical Data

Module ID	TB733	
Number of Pins	33 All 11 Connections of a Pin Row are Short Circuited	
Type of Terminal Block	Screw or cage clamps	
Distance between Contacts	5.08 mm	
Nominal Voltage	250 V	
Current Load ¹⁾	Max. 10 A / Contact	
Fuse	According External Fuse	
Connection Cross Section	0.14 mm ² (AWG26) – 2.5 mm ² (AWG12)	
Type of Cable	Only copper wire (No Aluminum wire!)	
Measurements	TB733.9	TB733.91
Height	48	48
Width	76	76
Depth	52	44

¹⁾ Take the respective limits for I/O modules into consideration!

Accessories

TB736

Order Data

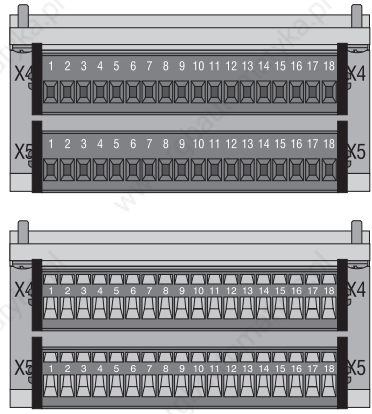
Model Number	Description	Figure
7TB736.9	2003 Terminal block, 36 pin, screw clamps	
7TB736.91	2003 Terminal block, 36 pin, cage clamps	
<p>The terminal block TB736 is used for the digital input supply on the DM465 module. It consists of two 18 pin blocks. The terminal blocks have to be ordered separately. All contacts on a pin connector are connected together and create a positive and GND strip.</p>		

Technical Data

Module ID	TB736	
Number of Pins	36 All 18 Connections of a Pin Row are Short Circuited	
Connection	Two 18 pin, pin blocks	
Type of Terminal Block	Screw or cage clamps	
Distance between Contacts	3.5 mm	
Nominal Voltage	125 V	
Current Load ¹⁾	Max. 12 A / Contact	
Connection Cross Section	0.08 mm ² (AWG28) – 1.5 mm ² (AWG16)	
Type of Cable	Only copper wire (No Aluminum wire!)	
Measurements	TB736.9	TB736.91
Height	33	33
Width	76	76
Depth	32	32

¹⁾ Take the respective limits for I/O modules into consideration!

Accessories

TB772

Order Data

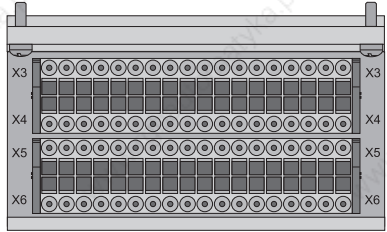
Model Number	Description	Figure
7TB772.91	2003 Terminal block, 72 pin, cage clamps	
<p>The terminal block TB722 is used as an additional jumper connector, if the digital mixed module DM435 is operated with a three wire connection.</p> <p>The TB722 consists of two 36 pin, pin blocks and contact strips with cage clamps and an ejection lever. All contacts of a pin row are connected together.</p>		

Technical Data

Module ID	TB772
Number of Pins	72 All 36 Connections of a Pin Row are Short Circuited
Connection	Two 36 Pin, Pin Blocks with Contact Strips with Cage Technology and an Ejection Lever
Distance between Contacts	3.5 mm
Nominal Voltage	50 V
Current Load ¹⁾	Max. 5 A / Contact
Fuse	According External Fuse
Connection Cross Section	0.5 mm ² - 1 mm ²
Type of Cable	Only copper wire (No Aluminum wire!)
Measurements	
Height	48
Width	76
Depth	34

¹⁾ Take the respective limits for I/O modules into consideration!

Manuals

Overview

Model Number	Description
MASYS22003-0	B&R 2003 User's Manual, German
MASYS22003-E	B&R 2003 User's Manual, English

B&R SYSTEM 2005

Module Overview

Column "Power" contains a power value provided by the module or required by the module. This can be used to quickly and easily create a power balance for a certain hardware configuration.

The power supplied by the PS modules is labeled with '+'. The power required by the other modules is labeled with '-'.

In order to create a power balance, add the power values together taking the sign into consideration. The sum is not allowed to be less than zero.

Sorted Alphabetically according to Module ID:

Module ID	Description	Base Plate	Power	Model No.	Page
0G2001.00-090	Cable PC <-> NC154, RS232, NC154 Operating System Download			0G2001.00-090	199
AC100	NiCd Batteries, 5 pieces, 3.6 V / 40 mAh			0AC100.9	197
AC240	Battery module for two 9 V block cells, separate slot			3AC240.9	198
AI350	8 voltage inputs ± 10 V, resolution 12 Bit	Main and Expansion	-5 W	3AI350.6	163
AI375	8 voltage inputs 0 - 10 V, resolution 12 Bit	Main and Expansion	-5 W	3AI375.6	163
AI775	8 current inputs 0 - 20 mA, resolution 12 Bit	Main and Expansion	-5 W	3AI775.6	163
AM050	4 voltage inputs 0 - 10 V, 4 voltage outputs ± 10 V, resolution 12 Bit	Main and Expansion	-6.5 W	3AM050.6	167
AM051	4 current inputs 0 - 20 mA, 4 current outputs 0 - 20 mA, resolution 12 Bit	Main and Expansion	-6.5 W	3AM051.6	168
AM055	5 voltage inputs 0 - 10 V, 3 voltage outputs ± 10 V, resolution 12 Bit	Main and Expansion	-7 W	3AM055.6	169
AM374	4 inputs 0 - 10 V / 0 - 20 mA, 4 outputs ± 10 V / 0 - 20 mA, signal switched in groups of 2	Main and Expansion	-6.5 W	3AM374.6	170
AO350	8 voltage outputs ± 10 V, resolution 12 Bit	Main and Expansion	-5 W	3AO350.6	165
AO775	8 current outputs 0 - 20 mA, resolution 11 Bit	Main and Expansion	-5.5 W	3AO775.6	165
AT350	4 inputs for PT100 sensor (3 wire)	Main and Expansion	-4 W	3AT350.6	173
AT450	4 inputs for PT100 sensor (4 wire)	Main and Expansion	-4 W	3AT450.6	173
AT660	8 inputs for FeCuNi sensor Type L + J, NiCrNi sensor Type K, raw value measurement	Main and Expansion	-6 W	3AT660.6	174
BM150	Dummy module	Main and Expansion		3BM150.9	199
BP150	Base plate module with 15 slots			3BP150.4	118
BP150	Base plate module with 15 slots, buffer battery			3BP150.41	118
BP151	Base plate module with 12 slots			3BP151.4	118
BP151	Base plate module with 12 slots, buffer battery			3BP151.41	118
BP152	Base plate module with 9 slots			3BP152.4	118
BP152	Base plate module with 9 slots, buffer battery			3BP152.41	118
BP155	Base plate module with 6 slots			3BP155.4	118
BP155	Base plate module with 6 slots, buffer battery			3BP155.41	118

Module ID	Description	Base Plate	Power	Model Nr.	Page
CP152	CPU with Expansion Master	Main		3CP152.9	131
CP152	CPU with Expansion Master, NC Synchronisation	Main		3CP152.90-2	131
CP153	CPU without Expansion Master	Main		3CP153.9	131
CP260	CPU with 2 insert slots, PCMCIA memory card	Main		3CP260.60-1	133
DI450	16 digital inputs, 24 VDC, 4 counter inputs, gate time / period measurement	Main and Expansion	-2 W	3DI450.60-9	149
DI475	16 digital inputs, 24 VDC, 10 msec switching delay	Main and Expansion	-1.5 W	3DI475.6	151
DI476	16 digital inputs, 24 VDC, 1 msec switching delay	Main and Expansion	-1.5 W	3DI476.6	151
DI477	32 digital inputs, 24 VDC, 1 msec switching delay	Main and Expansion	-1.5 W	3DI477.6	152
DI695	16 digital inputs, 120 / 230 VAC, 50 msec switching delay	Main and Expansion	-1.5 W	3DI695.6	153
DM455	8 digital inputs, 24 VDC, 2.5 µsec, 8 transistor outputs, 0 - 50 VDC, 1 A	Main and Expansion	-3.5 W	3DM455.60-2	144
DM476	16 dig. inputs, 24 VDC / 24 VAC, 1 msec, 16 transistor outputs, 24 VDC, 0.4 A	Main and Expansion	-2.5 W	3DM476.6	160
DO479	16 transistor outputs, 24 VDC, 0.5 A	Main and Expansion	-1 W	3DO479.6	155
DO480	16 transistor outputs, 24 VDC, 2 A	Main and Expansion	-2.5 W	3DO480.6	155
DO650	16 relay outputs, 120 VAC / 24 VDC, 2 A	Main and Expansion	-4 W	3DO650.6	156
DO690	8 triac outputs, 120 VAC, 1 A	Main and Expansion	-1.5 W	3DO690.6	157
DO750	8 relay outputs, 230 VAC / 24 VDC, 3 A	Main and Expansion	-3 W	3DO750.6	156
DO760	8 relay outputs, 240 VAC / 30 VDC, 4 A	Main and Expansion	-4 W	3DO760.6	158
EX150	Remote I/O Master	Main	-5.5 W	3EX150.60-1	127
EX250	Remote I/O Slave, power supply insert		-1.6 W	3EX250.60-1	128
EX350	I/O Master Controller, power supply insert		-1.5 W	3EX350.6	130
IF050	Interface module, 1 x RS232, 1 x RS485/RS422, 1 x RS232/TTY	Main	-7 W	3IF050.6	177
IF060	Interface module with slot for interface module insert	Main	-1 W	3IF060.6	179
IF152	Programmable interface module processor, 118 KByte SRAM, 512 KByte FlashPROM, 1 x RS232, 1 x CAN	Main	-4 W	3IF152.60-2	135
IF260	CPU or programmable interface processor, 850 KByte SRAM, 1.5 MByte FlashPROM, 1 insert slot	Main		3IF260.60-1	137
IF613	Interface module for insert slot, 3 x RS232		-0.9 W	3IF613.9	180
IF621	Interface module for insert slot, 1 x RS485/RS422, 1 x CAN		-1.5 W	3IF621.9	181
IF622	Interface module for insert slot, 1 x RS232, 2 x RS485/RS422		TBD	3IF622.9	182
IF661	Interface module for insert slot, 1 x RS485 (PROFIBUS-DP Slave)		-2 W	3IF661.9	183
IF671	Interface module for insert slot, 1 x RS232, 1 x RS485/RS422, 1 x CAN		-2 W	3IF671.9	184
IF672	Interface module for insert slot, 1 x RS232, 2 x CAN		-1.8 W	3IF672.9	186
IF681.95	Interface module for insert slot, 1 x RS232, 1 x ETHERNET (10BASE2: CHEAPERNET BNC-socket)		-2.4 W	3IF681.95	187
IF681.96	Interface module for insert slot, 1 x RS232, 1 x ETHERNET (10BASE-T: Twisted Pair RJ45 socket)		-1.65 W	3IF681.96	188
IP161	Programmable I/O processor, 850 KByte SRAM, 1.5 MByte FlashPROM, 1 x RS232, 1 x CAN, max. 12 digital inputs, 24 VDC, 2.5 µsec switching delay, max. 12 digital outputs, 24 VDC, 0.1 A, 6 analog inputs, ±10 V, 14 Bit, 6 analog outputs, ±10 V, 12 Bit, 2 outputs with +10 V and -10 V per terminal block	Main	-14.5 W ¹⁾ -3.5 f. pot.	3IP161.60-1	139

Module ID	Description	Base Plate	Power	Model No..	Page
ME960	Application memory, 64 KByte SRAM, 256 KByte FlashPROM			3ME960.90-1	147
ME963	Application memory, 512 KByte SRAM, 1 MByte FlashPROM			3ME963.90-1	147
ME965	Application memory, 512 KByte SRAM, 1 MByte FlashPROM			3ME965.90-1	147
NC150	Counter module, 2 32 bit counters, 100 kHz, 2 voltage outputs ± 10 V, resolution 12 Bit	Main and Expansion	-5 W	3NC150.6	191
NC154	Positioning module, three axes	Main	-6 W	3NC154.60-2	193
NW150	PROFIBUS network module	Main	-7 W	3NW150.60-1	189
PS465	Power supply 24 VDC, 50 W, with expansion slot	Main and Expansion	+50 W	3PS465.9	121
PS476	Power supply 24 VDC, 50 W, with Remote I/O Slave	Main and Expansion	+50 W	3PS476.90-1	121
PS477	Power supply 24 VDC, 50 W, with Expansion Slave	Main and Expansion	+50 W	3PS477.9	121
PS691	Power supply 120 VAC, 45 W, with Remote I/O Slave	Main and Expansion	+45 W	3PS691.90-1	123
PS692	Power supply 120 VAC, 45 W, with Expansion Slave	Main and Expansion	+45 W	3PS692.9	123
PS694	Power supply 120 VAC, 45 W, with expansion slot	Main and Expansion	+45 W	3PS694.9	123
PS791	Power supply 230 VAC, 45 W, with Remote I/O Slave	Main and Expansion	+45 W	3PS791.90-1	125
PS792	Power supply 230 VAC, 45 W, with Expansion Slave	Main and Expansion	+45 W	3PS792.9	125
PS794	Power supply 230 VAC, 45 W, with expansion slot	Main and Expansion	+45 W	3PS794.9	125
TB162	Single row terminal block, 12 pin, screw clamp			3TB162.9	200
TB170	Single row terminal block, 20 pin, screw clamp			3TB170.9	201
TB170	Single row terminal block, 20 pin, cage clamp			3TB170.91	201
TB170	20 single row terminal blocks TB170, screw clamp			3TB170:90-01	201
TB170	20 single row terminal blocks, 20 pin, cage clamp			3TB170:91-01	201
XP152-1	CPU, power supply insert, CAN interface, 256 KByte FlashPROM			3XP152.60-1	142
XP152-2	CPU, power supply insert, CAN interface, 512 KByte FlashPROM			3XP152.60-2	142

¹⁾ 3.5 W required for potentiometer (if used externally).

Sorted According to Group

Module ID	Description	Base Plate	Power	Model No.	Page
Module Rack					
BP150	Base plate module with 15 slots			3BP150.4	118
BP150	Base plate module with 15 slots, buffer battery			3BP150.41	118
BP151	Base plate module with 12 slots			3BP151.4	118
BP151	Base plate module with 12 slots, buffer battery			3BP151.41	118
BP152	Base plate module with 9 slots			3BP152.4	118
BP152	Base plate module with 9 slots, buffer battery			3BP152.41	118
BP155	Base plate module with 6 slots			3BP155.4	118
BP155	Base plate module with 6 slots, buffer battery			3BP155.41	118
Power Supply Modules					
PS465	Power supply 24 VDC, 50 W, with expansion slot	Main and Expansion	+50 W	3PS465.9	121
PS476	Power supply 24 VDC, 50 W, with Remote I/O Slave	Main and Expansion	+50 W	3PS476.90-1	121
PS477	Power supply 24 VDC, 50 W, with Expansion Slave	Main and Expansion	+50 W	3PS477.9	121
PS691	Power supply 120 VAC, 45 W, with Remote I/O Slave	Main and Expansion	+45 W	3PS691.90-1	123
PS692	Power supply 120 VAC, 45 W, with Expansion Slave	Main and Expansion	+45 W	3PS692.9	123
PS694	Power supply 120 VAC, 45 W, with expansion slot	Main and Expansion	+45 W	3PS694.9	123
PS791	Power supply 230 VAC, 45 W, with Remote I/O Slave	Main and Expansion	+45 W	3PS791.90-1	125
PS792	Power supply 230 VAC, 45 W, with Expansion Slave	Main and Expansion	+45 W	3PS792.9	125
PS794	Power supply 230 VAC, 45 W, with expansion slot	Main and Expansion	+45 W	3PS794.9	125
Bus Controller Modules					
EX150	Remote I/O Master	Main	-5.5 W	3EX150.60-1	127
EX250	Remote I/O Slave, power supply insert		-1.6 W	3EX250.60-1	128
EX350	I/O Master Controller, power supply insert		-1.5 W	3EX350.6	130
CPUs					
CP152	CPU with Expansion Master	Main		3CP152.9	131
CP152	CPU with Expansion Master, NC Synchronisation	Main		3CP152.90-2	131
CP153	CPU without Expansion Master	Main		3CP153.9	131
CP260	CPU with 2 insert slots, PCMCIA memory card	Main		3CP260.60-1	133
IF152	Programmable interface module processor, 118 KByte SRAM, 512 KByte FlashPROM, 1 x RS232, 1 x CAN	Main	-4 W	3IF152.60-2	135
IF260	CPU or programmable interface processor, 850 KByte SRAM, 1.5 MByte FlashPROM, 1 insert slot	Main		3IF260.60-1	137
IP161	Programmable I/O processor, 850 KByte SRAM, 1.5 MByte FlashPROM, 1 x RS232, 1 x CAN, max. 12 digital inputs, 24 VDC, 2.5 µsec switching delay, max. 12 digital outputs, 24 VDC, 0.1 A, 6 analog inputs, ±10 V, 14 Bit, 6 analog outputs, ±10 V, 12 Bit, 2 outputs with +10 V and -10 V per terminal block	Main	-14.5 W ¹⁾ -3.5 f. pot.	3IP161.60-1	139
XP152-1	CPU, power supply insert, CAN interface, 256 KByte FlashPROM			3XP152.60-1	142
XP152-2	CPU, power supply insert, CAN interface, 512 KByte FlashPROM			3XP152.60-2	142
Programmable Modules					
DM455	8 digitale Eingänge, 24 VDC, 2,5 µs, 8 Transistor-Ausgänge, 0 - 50 VDC, 1 A	Main and Expansion	-3.5 W	3DM455.60-2	144

Module ID	Description	Base Plate	Power	Model No.	Page
Application Memory Modules					
ME960	Application memory, 64 KByte SRAM, 256 KByte FlashPROM			3ME960.90-1	147
ME963	Application memory, 512 KByte SRAM, 1 MByte FlashPROM			3ME963.90-1	147
ME965	Application memory, 512 KByte SRAM, 1 MByte FlashPROM			3ME965.90-1	147
Digital Input Modules					
DI450	16 digital inputs, 24 VDC, 4 counter inputs, gate time / period measurement	Main and Expansion	-2 W	3DI450.60-9	149
DI475	16 digital inputs, 24 VDC, 10 msec switching delay	Main and Expansion	-1.5 W	3DI475.6	151
DI476	16 digital inputs, 24 VDC, 1 msec switching delay	Main and Expansion	-1.5 W	3DI476.6	151
DI477	32 digital inputs, 24 VDC, 1 msec switching delay	Main and Expansion	-1.5 W	3DI477.6	152
DI695	16 digital inputs, 120 / 230 VAC, 50 msec switching delay	Main and Expansion	-1.5 W	3DI695.6	153
Digital Output Modules					
DO479	16 transistor outputs, 24 VDC, 0.5 A	Main and Expansion	-1 W	3DO479.6	155
DO480	16 transistor outputs, 24 VDC, 2 A	Main and Expansion	-2.5 W	3DO480.6	155
DO650	16 relay outputs, 120 VAC / 24 VDC, 2 A	Main and Expansion	-4 W	3DO650.6	156
DO690	8 triac outputs, 120 VAC, 1 A	Main and Expansion	-1.5 W	3DO690.6	157
DO750	8 relay outputs, 230 VAC / 24 VDC, 3 A	Main and Expansion	-3 W	3DO750.6	156
DO760	8 relay outputs, 240 VAC / 30 VDC, 4 A	Main and Expansion	-4 W	3DO760.6	158
Digital Mixed Modules					
DM476	16 dig. inputs, 24 VDC / 24 VAC, 1 msec, 16 transistor outputs, 24 VDC, 0.4 A	Main and Expansion	-2.5 W	3DM476.6	160
Analog Input Modules					
AI350	8 voltage inputs ± 10 V, resolution 12 Bit	Main and Expansion	-5 W	3AI350.6	163
AI375	8 voltage inputs 0 - 10 V, resolution 12 Bit	Main and Expansion	-5 W	3AI375.6	163
AI775	8 current inputs 0 - 20 mA, resolution 12 Bit	Main and Expansion	-5 W	3AI775.6	163
Analog Output Modules					
AO350	8 voltage outputs ± 10 V, resolution 12 Bit	Main and Expansion	-5 W	3AO350.6	165
AO775	8 current outputs 0 - 20 mA, resolution 11 Bit	Main and Expansion	-5.5 W	3AO775.6	165
Analog Mixed Modules					
AM050	4 voltage inputs 0 - 10 V, 4 voltage outputs ± 10 V, resolution 12 Bit	Main and Expansion	-6.5 W	3AM050.6	167
AM051	4 current inputs 0 - 20 mA, 4 current outputs 0 - 20 mA, resolution 12 Bit	Main and Expansion	-6.5 W	3AM051.6	168
AM055	5 voltage inputs 0 - 10 V, 3 voltage outputs ± 10 V, resolution 12 Bit	Main and Expansion	-7 W	3AM055.6	169
AM374	4 inputs 0 - 10 V / 0 - 20 mA, 4 outputs ± 10 V / 0 - 20 mA, signal switched in groups of 2	Main and Expansion	-6.5 W	3AM374.6	170

Module ID	Description	Base Plate	Power	Model No.	Page
Temperature Modules					
AT350	4 inputs for PT100 sensor (3 wire)	Main and Expansion	-4 W	3AT350.6	173
AT450	4 inputs for PT100 sensor (4 wire)	Main and Expansion	-4 W	3AT450.6	173
AT660	8 inputs for FeCuNi sensor Type L + J, NiCrNi sensor Type K, raw value measurement	Main and Expansion	-6 W	3AT660.6	174
Communication Modules					
IF050	Interface module, 1 x RS232, 1 x RS485/RS422, 1 x RS232/TTY	Main	-7 W	3IF050.6	177
IF060	Interface module with slot for interface module insert	Main	-1 W	3IF060.6	179
IF613	Interface module for insert slot, 3 x RS232		-0.9 W	3IF613.9	180
IF621	Interface module for insert slot, 1 x RS485/RS422, 1 x CAN		-1.5 W	3IF621.9	181
IF622	Interface module for insert slot, 1 x RS232, 2 x RS485/RS422		TBD	3IF622.9	182
IF661	Interface module for insert slot, 1 x RS485 (PROFIBUS-DP Slave)		-2 W	3IF661.9	183
IF671	Interface module for insert slot, 1 x RS232, 1 x RS485/RS422, 1 x CAN		-2 W	3IF671.9	184
IF672	Interface module for insert slot, 1 x RS232, 2 x CAN		-1.8 W	3IF672.9	186
IF681.95	Interface module for insert slot, 1 x RS232, 1 x ETHERNET (10BASE2: CHEAPERNET BNC-socket)		-2.4 W	3IF681.95	187
IF681.96	Interface module for insert slot, 1 x RS232, 1 x ETHERNET (10BASE-T: Twisted Pair RJ45 socket)		-1.65 W	3IF681.96	188
NW150	PROFIBUS network module	Main	-7 W	3NW150.60-1	189
Counter and Positioning Modules					
NC150	Counter module, 2 32 bit counters, 100 kHz, 2 voltage outputs ± 10 V, resolution 12 Bit	Main and Expansion	-5 W	3NC150.6	191
NC154	Positioning module, three axes	Main	-6 W	3NC154.60-2	193
Accessories					
AC100	NiCd Batteries, 5 pieces, 3.6 V / 40 mAh			0AC100.9	197
AC240	Battery module for two 9 V block cells, separate slot			0AC240.9	198
0G2001.00-090	Cable PC <-> NC154, RS232, NC154 Operating System Download			0G2001.00-090	199
BM150	Dummy module	Main and Expansion		3BM150.9	199
TB162	Single row terminal block, 12 pin, screw clamp			3TB162.9	200
TB170	Single row terminal block, 20 pin, screw clamp			3TB170.9	201
TB170	Single row terminal block, 20 pin, cage clamp			3TB170.91	201
TB170	20 single row terminal blocks TB170, screw clamp			3TB170:90-02	201
TB170	20 single row terminal blocks, 20 pin, cage clamp			3TB170:91-02	201
Manuals					
MASYS22005-0	B&R 2005 User's Manual, German			MASYS22005-0	202
MASYS22005-E	B&R 2005 User's Manual, English			MASYS22005-E	202

¹⁾ 3.5 W required for potentiometer (if used externally).

General Information

Dimensions

B&R System 2005 consists of both single and double wide modules. The width corresponds to the number of slots required: The measurements given are installation measurements. The depth of the base plate must be added to the total depth of PCC.

Width	Slot
single	1
double	2

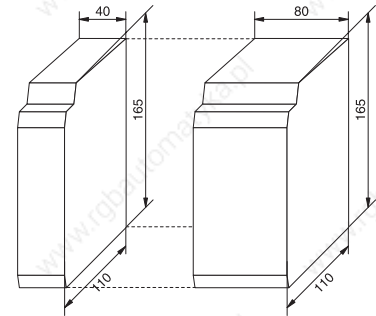

Single Width Module

Double Width Module

Basic Module Construction

The following elements can be found behind the module door:

- Status LEDs
- Node Number Switch
- Reset Button
- Connection Plug
- Slot for Application memory (only CPU)

Openings are provided in the module door so that the LEDs can be read without the door being open.

A label strip can be inserted on the inside of the module door which can be seen from the outside.

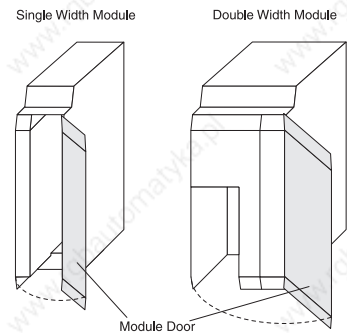

Single Width Module

Double Width Module

Module Door

Base Plate

All base plates for the System 2005 have the same construction. The number of slots are different:

Number of Slots	Base Plate	Length x
6	BP155	240 mm
9	BP152	360 mm
12	BP151	480 mm
15	BP150	600 mm

When installing base plates, make sure to leave a min. of 20 mm on the left and right for fastening levers.

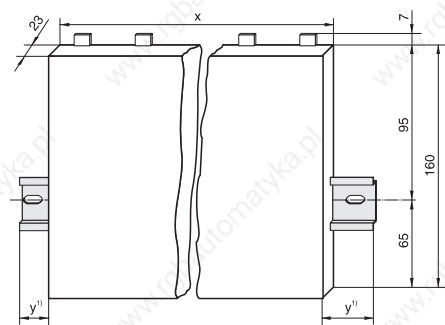

¹⁾ at least 20 mm for the fastening lever

Mounting Rail

A mounting rail which meets the EN 50022 standard is used to secure the PCC. The mounting rail is fastened to the back wall of the cabinet.

Follow the manufacturer's installation instructions!

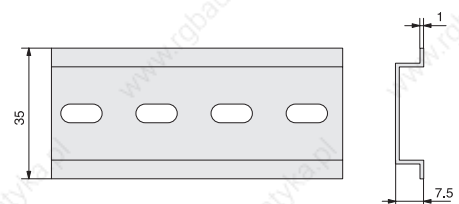

Installation

The installation is only allowed to be carried out by a qualified personnel!

The installation of the PCC is to be made in the following order:

- 1) Install the mounting rail
- 2) Mount the base plate
- 3) Mount the PCC modules

Installing the Base Plate

The following steps are to be taken in order to secure the base plate on the mounting rail:

- 1) **Set all fastening levers to the „OPEN“ position**
- 2) Hang the base plate on the desired position on the mounting rail
- 3) **Set all fastening levers to the „CLOSE“ position**

The steps are to be carried out in the reverse order to **remove** the base plate.

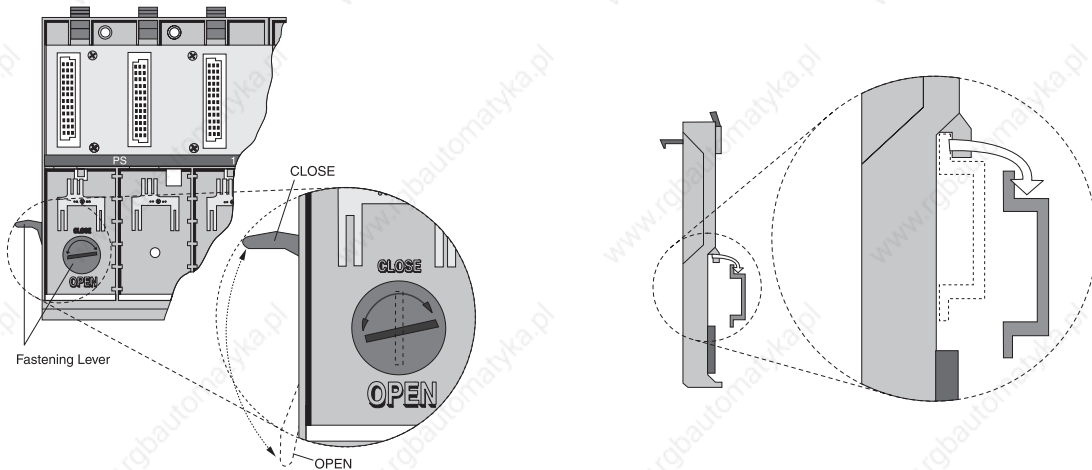

Installing the PCC Modules

After the base plate is secured to the mounting rail, the PCC modules can be inserted into the corresponding slots on the base plate. A module is to be inserted in the following manner:

- (1) Hang the module in the corresponding module slot using the module support hook.

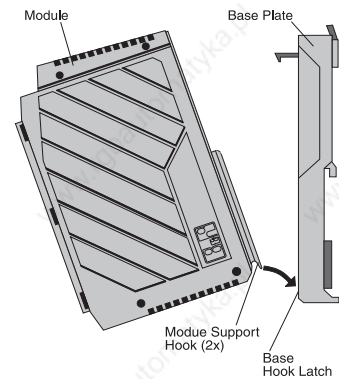

- (2) Tip the module back until the upper fastening clip clicks onto the PCC module.

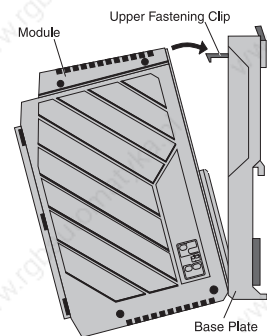

The PCC modules are **removed** in the opposite order.

Pressing the release lever (1) unclips the lock pin. The module can then be tipped forwards (2) and removed from the base plate (3).

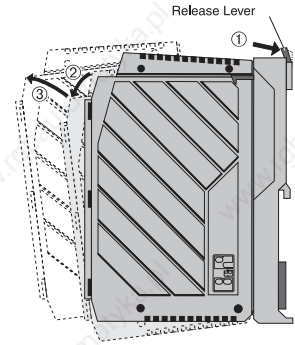

Terminal Block TB170

Single row terminal blocks, which can be removed with two ejection levers, are used to wire most modules.

Connecting Cables to the Terminal Block

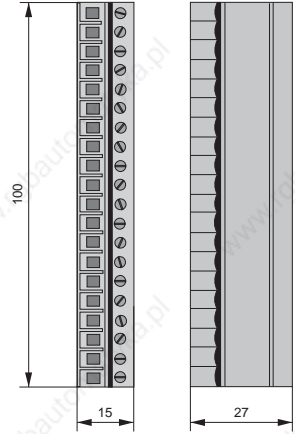

Chapter 3
B&R SYSTEM 2005

Connecting Cables to the Terminal Block

All cables (cable bunches) are to be run down from the terminal blocks.

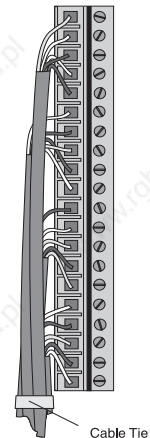

A cable tie is used to relieve strain on the terminal block and is to be attached to the slots provided on the module housing.

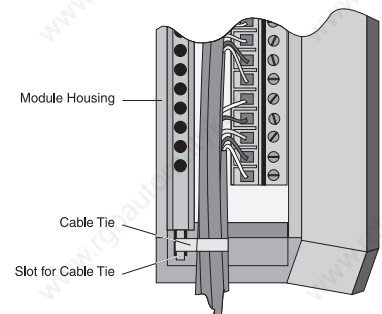

Environmental Temperature during Operation and Relative Humidity

The following values apply for all B&R 2005 modules unless a different value is given in the „Technical Data“ section.

Environmental Temperature during Operation	0 to 60 °C
Relative Humidity	5 to 95 %, non-condensing

Module Rack

General Information

Base plate modules are installed on a standard mounting rail. They are used for installing controller components (CPU, I/O modules, power supply modules, system modules etc.). The I/O bus, system bus and the supply lines are provided on the base plate modules. Base plate modules are available with 6, 9, 12 or 15 slots for the B&R 2005 system.

You are recommended to use the smallest possible base plate module, so that as few slots as possible remain free! All free slots must be fitted with dummy modules.

The base plate modules 3BP15x.41 are equipped with a **backup battery**. This lithium battery is used to buffer data centrally on the PCC 2005 (e.g. data and real time clock on the XP152).

The **module address** is determined by the slot (slot coding). Module addressing begins with slot 3, which has address 1. For PCC systems with an operating system older than version 1.10, module addressing for system modules begins with address 0 (numbers are different for system modules and I/O modules).

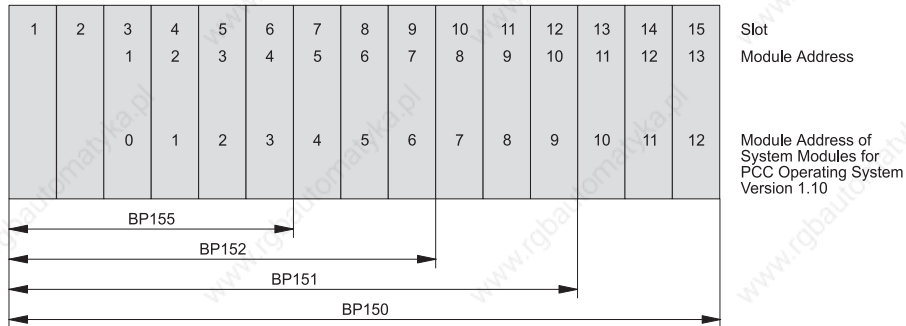

The following modules can be used depending on whether the base plate is used as a main base plate or an expansion base plate:

Slot	Main Base Plate	Expansion Base Plate
1	Power supply with expansion slot or any other power supply	Power Supply: with expansion slot, with expansion slave or with remote I/O slave
2		
3	System or I/O module	I/O module
4		I/O module
5	System or I/O module	I/O module
6	System or I/O module	I/O module
:	:	:
:	:	:
15	System or I/O module	I/O module

Module Rack

BP150 / BP151 / BP152 / BP155

Order Data

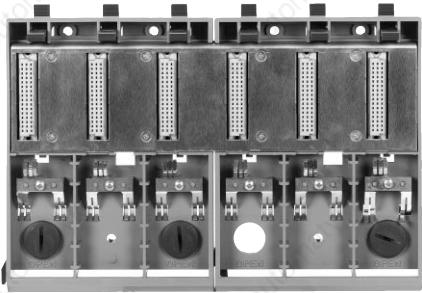
Model Number	Description	Figure
	Module Rack	
3BP150.4	2005 Base plate module, 15 slots	
3BP151.4	2005 Base plate module, 12 slots	
3BP152.4	2005 Base plate module, 9 slots	
3BP155.4	2005 Base plate module, 6 slots	
3BP150.41	2005 Base plate module, 15 slots, Backup Battery	
3BP151.41	2005 Base plate module, 12 slots, Backup Battery	
3BP152.41	2005 Base plate module, 9 slots, Backup Battery	
3BP155.41	2005 Base plate module, 6 slots, Backup Battery	
	Accessories	
0AC201.9	5 Lithium Batteries 3 V / 950 mAh	
The backup battery is included with the delivery.		

Technical Data

Module ID	BP150	BP151	BP152	BP155
C-UL-US Listed	YES			
Number of Slots	15	12	9	6
Dimension ¹⁾				
Height	165 mm	165 mm	165 mm	165 mm
Width	600 mm	480 mm	360 mm	240 mm
Depth	23 mm	23 mm	23 mm	23 mm
Number of Insert Modules				
on Main Base Plate 1 Power Supply + ...	13 System or I/O modules	10 System or I/O modules	7 System or I/O modules	4 System or I/O modules
on Expansion Base Plate 1 Power Supply + ...	13 I/O modules	10 I/O modules	7 I/O modules	4 I/O modules
Backup Battery	Only base plate modules with model number 3BP15x.41			
Type	Lithium Battery - 3 V / 950 mAh			
Storage Time (not installed)	Max. 3 years at 30 °C			
Storage Temperature				
Base Plate Module without Lithium Battery	-20 to +70 °C			
Base Plate Module with Lithium Battery	-20 to +60 °C			
Lithium Battery (not installed)	-20 to +60 °C			

¹⁾ When installing the base plate module, 20 mm must be left on both sides of the fastening lever.

Power Supply Modules

General Information

Power supply modules create the voltages required by the PCC, from the input voltage (24 VDC, 120 VAC, 230 VAC, or 230 VAC / 220 VDC). Each main and expansion unit requires its own power supply module. The power supply module must always be operated in the far left slot of the base plate module. All power supply modules require two slots.

The distinguishing feature of power supply modules is the input voltage range.

When configuring a system, make sure that the power consumption of all the inserted modules is not greater than the output power of the power supply module.

Special Functions

Some power supply modules have additional special functions, e.g. remote I/O slave, expansion slave or expansion slot.

Safety Features

Power supply modules are equipped with an internal current limit (short circuit protection), and have connections for an external buffer voltage (AC240 battery module). A fuse protects the module against overloading and reverse polarity. The fuse is behind the module door.

The PCC functions can be monitored with a so-called ready-relay. This ready-relay is set in normal operation and opens if an error occurs. The ready-relay is normally connected with the E-STOP circuit.

Expansion Slave (Local Expansion)

An expansion slave, which can be used to begin another I/O bus segment, is built into power supply modules PS477, PS692 and PS792.

For local expansion, the expansion unit (expansion slave) is placed as near to the main unit (expansion master) as possible; normally in the same cabinet.

Up to four expansion slaves can be operated by an expansion master.

Remote Slave (Remote Expansion)

Power supply modules PS476, PS691 and PS791 have a built-in remote slave, which can be connected to the bus cable of a system 2005 or 2010 remote master.

With remote expansion (remote I/O), the expansion unit (remote slave) can be up to 1200 m from the main unit (remote master). With a repeater, the network can be extended even further.

Without a repeater, a maximum of 31 remote slaves can be connected to a remote master.

Expansion Slot

Power supply modules PS465, PS694, PS754 and PS794 have an expansion slot. The XP152 CPU insert can be placed in this slot, for example.

Overview

The characteristics relevant for power supply modules are input voltage, output power and slots for expansion modules.

Power Supply Module	PS465	PS476	PS477
Input Voltage	24 VDC	24 VDC	24 VDC
Output Power	50 W	50 W	50 W
Special Functions			
Expansion Slave	NO	NO	YES
Remote I/O Slave	NO	YES	NO
Expansion Slot	YES	NO	NO
Fuse, Slow-Blow	5 A / 250 V	5 A / 250 V	5 A / 250 V

Power Supply Module	PS691	PS692	PS694
Input Voltage	120 VAC	120 VAC	120 VAC
Output Power	45 W	45 W	45 W
Special Functions			
Expansion Slave	NO	YES	NO
Remote I/O Slave	YES	NO	NO
Expansion Slot	NO	NO	YES
Fuse, Slow-Blow	1.6 A / 250 V	1.6 A / 250 V	1.6 A / 250 V

Power Supply Module	PS791	PS792	PS794
Input Voltage	230 VAC	230 VAC	230 VAC
Output Power	45 W	45 W	45 W
Special Functions			
Expansion Slave	NO	YES	NO
Remote I/O Slave	YES	NO	NO
Expansion Slot	NO	NO	YES
Fuse, Slow-Blow	1.6 A / 250 V	1.6 A / 250 V	1.6 A / 250 V

Power Supply Modules

PS465 / PS476 / PS477

Order Data

Model Number	Description	Figure
Power Supply Modules		
3PS465.9	2005 power supply modules, 24 VDC, 50 W, with expansion slot	
3PS476.90-1	2005 power supply modules, 24 VDC, 50 W, with remote I/O slave	
3PS477.9	2005 power supply modules, 24 VDC, 50 W, with expansion slave	
Accessories		
0G1000.00-090	Bus connector, RS485, PROFIBUS networks, remote I/O	
0AC916.9	Bus termination, RS485, active, For PROFIBUS networks, remote I/O, standard mounting rail, Supply voltage: 120 / 230 VAC	
0G0010.00-090	Cable I/O Bus expansion, 1 m, Bus expansion for B&R 2005 / B&R 2010	
0G0012.00-090	Cable I/O Bus expansion, 2 m, Bus expansion B&R 2005 / B&R 2010	

The following modules can be operated in an expansion slot:

Model Number	Description	See Section
3EX250.60-1	2005 Remote I/O slave controller, electrically isolated RS485 interface, for connecting to remote I/O bus, insert for power supply modules	Bus Controller Modules
3EX350.6	2005 local I/O master controller, Controls I/O modules on, up to 4 expansion racks, Insert for power supply modules	Bus Controller Modules
3XP152.60-1	2005 CPU, 118 KB SRAM, 256 KB FlashPROM, 1 RS232 interface, 1 CAN interface, CAN: electrically isolated, network-capable, Insert for power supply modules	CPUs
3XP152.60-2	2005 CPU, 118 KB SRAM, 512 KB FlashPROM, 1 RS232 interface, 1 CAN interface, CAN: electrically isolated, network-capable, Insert for power supply modules	CPUs

The EX150 module is use as Remote I/O Master:

Model Number	Description	See Section
3EX150.60-1	2005 remote I/O master, Electrically isolated RS485 interface, For connecting to remote I/O bus	Bus Controller Modules

The CP152 CPU is used as Expansion Master:

Model Number	Description	See Section
3CP152.9	2005 CPU, 64 + 256 KB SRAM, 1 RS232 interface, 1 electrically isolated RS485/RS422/TTY, RS485/RS422: network-capable, 1 expansion master interface, Order application memory separately!	CPUs
3CP152.90-2	2005 CPU, 64 + 256 KB SRAM, 1 RS232 interface, 1 electrically isolated RS485/RS422/TTY, RS485/RS422: network-capable, 1 expansion master interface, NC synchronization, Order application memory separately!	CPUs

Technical Data

Module ID	PS465	PS476	PS477
General			
C-UL-US Listed	YES		
Module Type	B&R 2005 power supply module, double width		
Insert in Main Rack Expansion Rack	1 + 2 1 + 2		
Power Supply			
Input Voltage Minimum Nominal Maximum	18 VDC 24 VDC 30 VDC		
External Protection Capacitor for Single Phase Bridge for Three Phase Bridge	10000 µF 6000 µF		
Output Power	Max. 50 W		
Current Flow	Max. 3.5 A		
Input Capacitance	500 µF		
Fuse	6.3 A slow-blow / 250 V		
Peripherals			
Remote Slave	NO	YES	NO
Expansion Slave	NO	NO	YES
Expansion Slot	YES	NO	NO
External Ram Buffering by Supplying	12 V (min. 8 V / max. 30 V)		
Status Display	LEDs		
READY Relay Type Switching Voltage Switching Current Protection	N.O. Max. 30 VDC Max. 3 A 370 V Transient voltage protection diode		

Power Supply Modules

PS691 / PS692 / PS694

Order Data

Model Number	Description	Figure
Power Supply Voltage		
3PS694.9	2005 power supply module, 120 VAC, 45 W, with remote I/O slave	
3PS691.90-1	2005 power supply module, 120 VAC, 45 W, with expansion slave	
3PS692.9	2005 power supply module, 120 VAC, 45 W, with expansion slot	
Accessories		
0G1000.00-090	Bus connector, RS485, PROFIBUS networks, remote I/O	
0AC916.9	Bus termination, RS485, active, For PROFIBUS networks, remote I/O, standard mounting rail, Supply voltage: 120 / 230 VAC	
0G0010.00-090	Cable I/O Bus expansion, 1 m, Bus expansion for B&R 2005 / B&R 2010	
0G0012.00-090	Cable I/O Bus expansion, 2 m, Bus expansion B&R 2005 / B&R 2010	

The following modules can be operated in an expansion slot:

Model Number	Description	See Section
3EX250.60-1	2005 Remote I/O slave controller, electrically isolated RS485 interface, for connecting to remote I/O bus, insert for power supply modules	Bus Controller Modules
3EX350.6	2005 local I/O master controller, Controls I/O modules on, up to 4 expansion racks, Insert for power supply modules	Bus Controller Modules
3XP152.60-1	2005 CPU, 118 KB SRAM, 256 KB FlashPROM, 1 RS232 interface, 1 CAN interface, CAN: electrically isolated, network-capable, Insert for power supply modules	CPUs
3XP152.60-2	2005 CPU, 118 KB SRAM, 512 KB FlashPROM, 1 RS232 interface, 1 CAN interface, CAN: electrically isolated, network-capable, Insert for power supply modules	CPUs

The EX150 module is use as Remote I/O Master:

Model Number	Description	See Section
3EX150.60-1	2005 remote I/O master, Electrically isolated RS485 interface, For connecting to remote I/O bus	Bus Controller Modules

The CP152 CPU is used as Expansion Master:

Model Number	Description	See Section
3CP152.9	2005 CPU, 64 + 256 KB SRAM, 1 RS232 interface, 1 electrically isolated RS485/RS422/TTY, RS485/RS422: network-capable, 1 expansion master interface, Order application memory separately!	CPUs
3CP152.90-2	2005 CPU, 64 + 256 KB SRAM, 1 RS232 interface, 1 electrically isolated RS485/RS422/TTY, RS485/RS422: network-capable, 1 expansion master interface, NC synchronization, Order application memory separately!	CPUs

Technical Data

Module ID	PS691	PS692	PS694
General			
C-UL-US Listed	YES		
Module Type	B&R 2005 power supply modules, double width		
Insert in Main Rack Expansion Rack	1 + 2 1 + 2		
Power Supply			
Input Voltage Minimum Nominal Maximum	92 VAC 120 VAC 133 VAC		
Input Voltage Frequency	47 to 63 Hz		
Overvoltage Peak Value Half-peak Duration	<500 V <10 msec (not periodic)		
Output Power	Max. 45 W		
Current Flow	Max. 0.8 A		
Fuse	1.6 A slow-blow / 250 V		
Peripherals			
Remote Slave	YES	NO	NO
Expansion Slave	NO	YES	NO
Expansion Slot	NO	NO	YES
External RAM Buffering by Supplying	12 V (min. 8 V / max. 30 V)		
Status Display	LEDs		
READY Relay Type Switching Voltage Switching Current Protection	N.O. Max. 270 VAC / 30 VDC Max. 3 A 780 V VDR internal		

Power Supply Modules

PS791 / PS792 / PS794

Order Data

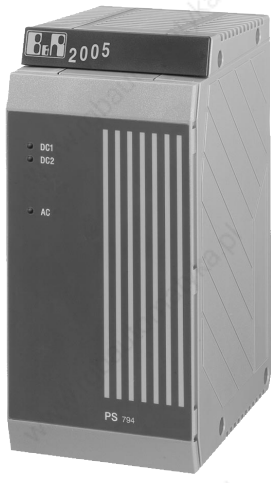
Model Number	Description	Figure
Power Supply Modules		
3PS794.9	2005 power supply module, 230 VAC, 45 W, with remote I/O slave	
3PS791.90-1	2005 power supply module, 230 VAC, 45 W, with expansion slave	
3PS792.9	2005 power supply module, 230 VAC, 45 W, with expansion slot	
Accessories		
0G1000.00-090	Bus connector, RS485, PROFIBUS networks, remote I/O	
0AC916.9	Bus termination, RS485, active, For PROFIBUS networks, remote I/O, standard mounting rail, Supply voltage: 120 / 230 VAC	
0G0010.00-090	Cable I/O Bus expansion, 1 m, Bus expansion for B&R 2005 / B&R 2010	
0G0012.00-090	Cable I/O Bus expansion, 2 m, Bus expansion B&R 2005 / B&R 2010	

The following modules can be operated in an expansion slot:

Model Number	Description	See Section
3EX250.60-1	2005 Remote I/O slave controller, electrically isolated RS485 interface, for connecting to remote I/O bus, insert for power supply modules	Bus Controller Modules
3EX350.6	2005 local I/O master controller, Controls I/O modules on, up to 4 expansion racks, Insert for power supply modules	Bus Controller Modules
3XP152.60-1	2005 CPU, 118 KB SRAM, 256 KB FlashPROM, 1 RS232 interface, 1 CAN interface, CAN: electrically isolated, network-capable, Insert for power supply modules	CPUs
3XP152.60-2	2005 CPU, 118 KB SRAM, 512 KB FlashPROM, 1 RS232 interface, 1 CAN interface, CAN: electrically isolated, network-capable, Insert for power supply modules	CPUs

The EX150 module is use as Remote I/O Master:

Model Number	Description	See Section
3EX150.60-1	2005 remote I/O master, Electrically isolated RS485 interface, For connecting to remote I/O bus	Bus Controller Modules

The CP152 CPU is used as Expansion Master:

Model Number	Description	See Section
3CP152.9	2005 CPU, 64 + 256 KB SRAM, 1 RS232 interface, 1 electrically isolated RS485/RS422/TTY, RS485/RS422: network-capable, 1 expansion master interface, Order application memory separately!	CPUs
3CP152.90-2	2005 CPU, 64 + 256 KB SRAM, 1 RS232 interface, 1 electrically isolated RS485/RS422/TTY, RS485/RS422: network-capable, 1 expansion master interface, NC synchronization, Order application memory separately!	CPUs

Technical Data

Module ID	PS791	PS792	PS794
General			
C-UL-US Listed	YES		
Module Type	B&R 2005 power supply modules, double width		
Insert in Main Rack Expansion Rack	1 + 2 1 + 2		
Power Supply			
Input Voltage Minimum Nominal Maximum	187 VAC 230 VAC 265 VAC		
Input Voltage Frequency	47 to 63 Hz		
Overvoltage Peak Value Half-peak Duration	<500 V <10 msec (not periodic)		
Output Power	Max. 45 W		
Current Flow	Max. 0.4 A		
Fuse	1.6 A slow-blow / 250 V		
Peripherals			
Remote Slave	YES	NO	NO
Expansion Slave	NO	YES	NO
Expansion Slot	NO	NO	YES
External RAM Buffering by Supplying	12 V (min. 8 V / max. 30 V)		
Status Display	LEDs		
READY Relay Type Switching Voltage Switching Current Protection	N.O. Max. 270 VAC / 30 VDC Max. 3 A 780 V VDR internal		

Bus Controller Module

EX150

Order Data

Model Number	Description	Figure
	Remote I/O Master	
3EX150.60-1	2005 Remote I/O master, Electrically isolated RS485 interface, For connecting to remote I/O bus	
	Accessories	
0G1000.00-090	Bus connector, RS485, PROFIBUS networks, remote I/O	
0AC916.9	Bus termination, RS485, active, For PROFIBUS networks, remote I/O, standard mounting rail, Supply voltage: 120 / 230 VAC	
Additional information concerning accessories can be found in sections "Accessories" and "Manuals".		

Technical Data

Module ID	EX150
General	
C-UL-US Listed	YES
Module Type	B&R 2005 system module, single width
Insert in Main Rack Expansion Rack	YES NO
Power Consumption	Max. 5.5 W
Peripherals	
Diagnosis LEDs	YES
Number Switch	Ste the slave address
Standard Communication Interface	
Interface Type Connection Isolation Baudrates 100 kBit/sec 181 kBit/sec 500 kBit/sec 1000 kBit/sec 2000 kBit/sec	RS485 9 pin D-type connector (F) YES Depends on the distance Max. 1200 m Max. 1000 m Max. 400 m Max. 200 m Max. 100 m
Remote I/O Bus Access Procedure Number of Remote I/O Master Number of Slaves Topology Connection to Bus Termination Resistance	Master/Slave principle Max. 8 Max. 31 (without repeater) Physical bus Direct Shielded, twisted pair cable External

General Information

Remote Master:

The remote master is a system module that can be used to connect I/O modules to the CPU over greater distances. The remote master and up to 31 remote slaves are connected with a bus cable.

Remote Slave:

The remote slave is available in two models:

- Power supply insert (EX250)
- Integrated in a power supply module (see section "Power Supply Modules").

Bus Controller Module

EX250

Order Data

Model Number	Description	Figure
	Remote I/O Slave	
3EX250.60-1	2005 Remote I/O slave controller, electrically isolated RS485 interface, for connecting to remote I/O bus, insert for power supply modules	
	Accessories	
0G1000.00-090	Bus connector, RS485, PROFIBUS networks, remote I/O	
0AC916.9	Bus termination, RS485, active, For PROFIBUS networks, remote I/O, standard mounting rail, Supply voltage: 120 / 230 VAC	
Additional information concerning accessories can be found in sections "Accessories" and "Manuals".		

The EX150 module is use as Remote I/O Master:

Model Number	Description	See Section
3EX150.60-1	2005 remote I/O master, Electrically isolated RS485 interface, For connecting to remote I/O bus	Bus Controller Modules

Technical Data

Module ID	EX250
General	
C-UL-US Listed	in preparation
Slot	Insert for power supplies PS465, PS694 or PS794
Power Consumption	Max. 1.6 W
Diagnosis LEDs	YES
Nummber Switch	Set slave address
Interface Type	RS485
Connector	9 pin D-type socket
Potentialtrennung	YES
Baudrates 100 kBit/sec 181 kBit/sec 500 kBit/sec 1000 kBit/sec 2000 kBit/sec	Depemds on the distance Max. 1200 m Max. 1000 m Max. 400 m Max. 200 m Max. 100 m
Access	Master/Slave principle
Topology	Physical bus
Bus Coupling	Direct
Transfer Medium	Shielded, twisted pair cable
Termination Resistor	External
Baudrate	Automatic baudrate recognition

General Information

A B&R SYSTEM 2005 is integrated into a remote I/O bus as slave station with the EX250 bus controller. A bus cable is used to connect the remote master station and up to 31 remote slave stations. Each B&R SYSTEM 2005 slave begins a new I/O bus which can be used to address a maximum of 13 modules.

The EX250 bus controller is operated in an expansion slot on power supply modules PS465, PS694 or PS794.

The module is equipped with status LEDs, two number switches for slave address settings and a connector for an RS485 interface.

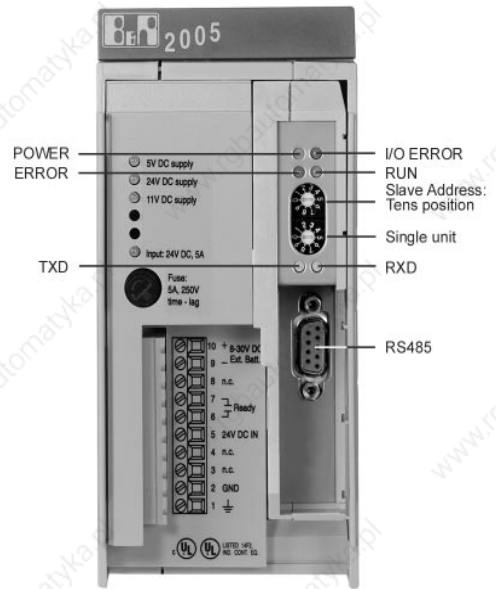

Bus Controller Module

EX350

Order Data

Model Number	Description	Figure
	Local I/O Master Controller	
3EX350.6	2005 Local I/O master controller, Controls I/O modules on, up to 4 expansion racks, Insert for power supply modules	
	Accessories	
0G0010.00-090	Cable I/O Bus expansion, 1 m, Bus expansion for B&R 2005 / B&R 2010	
0G0012.00-090	Cable I/O Bus expansion, 2 m, Bus expansion B&R 2005 / B&R 2010	

Technical Data

Module ID	EX350
General	
C-UL-US Listed	YES
Slot	Power supply insert PS465, PS694 or PS794
Power Consumption	Max. 1.5 W
Processor	
Data Buffering	Buffering via B&R 2005 base plate module
Number of Expansion Racks	Max. 4
Number of I/O Data Points digital analog	Refers to the main system and B&R 2005 expansion systems 1024 inputs / 1024 outputs 512 inputs / 512 outputs
Communication Interface	
Interface Isolation Access	Expansion Master NO B&R local I/O bus expansion (secure)

General Information

Unlike CP152, the processor modules CP260, IF152, IF260, IP152, IP161 and IP350 do not have an expansion master. If the I/O master controller EX350 is used, you can also have up to four expansion base plates for the above modules, onto which all I/O modules can be inserted.

The I/O master controller is operated in the expansion slot of a power supply module PS465, PS694, PS754 or PS794. The I/O modules on the main base plate are handled by the CPU. The EX350 module supports the CPU during data processing of the I/O modules on the expansion base plates.

CPUs

CP152 / CP153

Order Data

Model Number	Description	Figure	
CPUs			
3CP152.9	2005 CPU, 64 + 256 KB SRAM, 1 RS232 interface, 1 electrically isolated RS485/RS422/TTY, RS485/RS422: network-capable, 1 expansion master interface, Order application memory separately!		
3CP152.90-2	2005 CPU, 64 + 256 KB SRAM, 1 RS232 interface, 1 electrically isolated RS485/RS422/TTY, RS485/RS422: network-capable, 1 expansion master interface, NC synchronization, Order application memory separately!		
3CP153.9	2005 CPU, 64 + 256 KB SRAM, 1 RS232 interface, 1 electrically isolated RS485/RS422/TTY, RS485/RS422: network-capable, Order application memory separately!		
Application Memory			
3ME960.90-1	2005 Application memory, 64 KB SRAM, 256 KB FlashPROM, With PCC operating system		
3ME963.90-1	2005 Application memory, 512 KB SRAM, 1 MB FlashPROM, With PCC operating system		
3ME965.90-1	2005 Application memory, 1 MB SRAM, 2 MB FlashPROM, With PCC operating system		
Accessories			
0G0001.00-090	Cable PC <-> RPS/PW, RS232, Online cable		
0AC100.9	NiCd rechargeable, 5 pieces, 3,6 V / 40 mAh		
0G0010.00-090	Cable I/O Bus expansion, 1 m, Bus expansion for B&R 2005 / B&R 2010		
0G0012.00-090	Cable I/O Bus expansion, 2 m, Bus expansion B&R 2005 / B&R 2010		
0G1000.00-090	Bus connector, RS485, PROFIBUS networks, remote I/O		
0AC916.9	Bus termination, RS485, active, For PROFIBUS networks, remote I/O, standard mounting rail, Supply voltage: 120 / 230 VAC		
<p>The NiCd battery is included with the delivery.</p> <p>Additional information concerning accessories can be found in sections "Accessories" and "Manuals".</p>			

Technical Data

Module ID	CP152.9 CP152.90-2	CP153
General		
C-UL-US Listed	YES	
Module Type	B&R 2005 CPU, double width	
Insert in Main Rack Expansion Rack	3 + 4 ---	
Power Consumption (incl. APM)	Max. 6 W	
Processor		
Instruction Cycle Time	0.8 µsec	
Standard Memory Dual Ported RAM (DPR) System RAM	64 KByte SRAM 256 KByte SRAM	
Application Memory (not incl.)	ME960, ME963, ME965	
Data Buffering Lithium Battery in APM NiCd Battery in CPU Gold Foil Capacitor in CPU Battery Monitoringg	At least 1 year ¹⁾ At least 1 week At least 10 min. YES	
NC Synchronization	CP152.9 ... NEIN CP152.90-2 ... JA	NEIN

Module ID	CP152.9 CP152.90-2	CP153
Peripherals		
Real Time Clock Resolution	Nonvolatile 1 sec	
Expansion Master	YES	NO
Key Switch	YES	
Reset Button	YES	
Cold Start Button	YES	
Status Display	LEDs	
Standard Communication Interface		
Application Interface IF1 Isolation Connection Distance Baudrate	RS232 NO 9 pin D-type connector (M) Max. 15 m / 19200 Baud Max. 64 kBaud	
Application Interface IF2 Isolation Connection RS485/RS422 Distance Baudrate TTY Distance Baudrate	RS485 / RS422 / TTY ²⁾ YES 9 pin D-type connector (F) Max. 1200 m Max. 347 kBaud Max. 300 m Max. 9600 Baud	

¹⁾ Buffering taken over by lithium battery in APM. RAM in the APM and CPU are both buffered, therefore the buffer period is reduced to 1 year.

²⁾ Can be set with software.

General Information

The CPU is inserted in the main base plate module directly next to the power supply module. It requires two slots. Only the status LEDs can be seen with the module door closed.

Two serial interfaces, the expansion master interface (only CP152), a key switch, the NiCd battery that protects the memory when power is lost, various buttons and the slot for the application memory are found behind the module door.



CPU

CP260

Order Data

Model Number	Description	Figure
	CPUs	
3CP260.60-1	2005 CPU, 2 MB DRAM, 850 KB SRAM, 512 KB FlashPROM, 2 insert slots, 1 PCMCIA slot, 1 RS232 interface	
	Memory Card	
0MC111.9	PCMCIA memory card, 2 MB FlashPROM	
0MC211.9	PCMCIA memory card, 2 MB SRAM	
	Accessories	
0G0001.00-090	Cable PC <-> PCC/PW, RS232, Online cable	
Additional information concerning accessories can be found in sections "Accessories" and "Manuals".		

The following interface module inserts can be used with the CP260:

Model Number	Description
3IF613.9	Three RS232 interfaces
3IF621.9	One RS485/RS422 interface and one CAN interface
3IF622.9	One RS232 interface and two RS485/RS422 interfaces
3IF661.9	One RS485 interface (PROFIBUS DP Slave)
3IF671.9	One RS232 interface, one RS485/RS422 interface and one CAN interface
3IF672.9	One RS232 interface and two CAN interfaces
3IF681.95	One RS232 interface and one ETHERNET interface with 10 BASE2 connection (CHEAPERNET BNC Socket)
3IF681.96	One RS232 interface and one ETHERNET interface with 10 BASE-T connection (Twisted Pair/RJ45 Socket)

Technical Data

Module ID	CP260
General	
C-UL-US Listed	YES
Module Type	B&R 2005 CPU, double width
Insert in Main Rack Expansion Rack	3 + 4 ---
Power Consumption at 5 V at 24 V (fan)	Max. 6.1 W without memory card or interface modules Max. 2.3 W
Processor	
Instruction Cycle Time	0,2 µsec
Data and Program Code Cache	2 x 256 Byte
Standard Memory Working Memory System RAM User RAM System PROM User PROM	4 MByte DRAM 174 KByte SRAM 850 KByte SRAM 512 KByte FlashPROM 512 KByte FlashPROM
Data Buffering Buffer Batt. in 2005 Base Plate with Battery Module AC240 Buffering with NiMH Battery Battery Monitoring	At least 4 years At least 2.5 years At least 2 months YES

Module ID	CP260
Peripherals	
PCMCIA Interface Standard Card Thickness Card Type Memory Size SRAM FlashPROM	1 JEIDA V 4.0 or PCMCIA Standard Release 2.0 Max. 3 mm Memory cards Max. 16 MByte Max. 16 MByte
Real Time Clock Resolution	Nonvolatile 1 sec
Reset Button	YES
Status Display	LEDs
Insert Slots	2 (for interface module inserts)
Standard Communication Interface	
Application Interface IF1 Isolation Connection Distance Baudrate	RS232 NO 9 pin D-type connector (M) Max. 15 m / 19200 Baud Max. 64 kBaud

General Information

The CPU is operated on the main rack directly next to the power supply module. It requires two slots. When the module door is closed, only the status LEDs are visible.

Behind the module door, you will find the operational and display elements, the two insertion slots for interface modules, the PCMCIA interface and the RS232 interface.



CPU's

IF152

Order Data

Model Number	Description	Figure
	Programmable Interface Processor	
3IF152.60-2	2005 Programmable interface processor, 118 KB SRAM, 512 KB FlashPROM, 1 RS232 interface, 1 CAN interface, CAN: elec. isolated, network-capable	
	Accessories	
0G0001.00-090	Cable PC <-> PCC/PW, RS232, Online cable	
7AC911.9	Bus adapter, CAN	
0AC912.9	Bus adapter, CAN, 1 CAN interface	
0AC913.92	Bus adapter, CAN, 2 CAN interfaces, incl. 30 cm connection cable	
Additional information concerning accessories can be found in sections "Accessories" and "Manuals".		

Technical Data

Module ID	IF152
General	
C-UL-US Listed	YES
Module Type	B&R 2005 system module, single width
Slot 3 ≥ 4	Operation as CPU Operation as programmable interface processor
Power Consumption	Max. 4 W
Processor	
Instruction Cycle Time	0.6 µsec
Standard Memory System RAM User RAM System PROM User PROM	138 KByte SRAM 118 KByte SRAM 512 KByte FlashPROM 512 KByte FlashPROM
Data Buffering Buffer Battery in 2005 Rack with Battery Module AC240 Battery Monitoring	At least 4 years At least 2 years YES, when used as main CPU
Peripherals	
Real Time Clock Resolution	Nonvolatile when used as CPU (external buffering) 1 sec
Reset Button	YES
Status Display	4 Status LEDs, 4 Interface LEDs
Standard Communication Interface	
Application Interface IF1 Isolation Connection Distance Baudrate	RS232 NO 9 pin D-type connector (M) Max. 15 m / 19200 Baud Max. 115.2 kBaud
Application Interface IF2 Isolation Connection Station Number Distance Maximum Baudrate Bus Length 10 - 60 m Bus Length 100 - 200 m Bus Length 800 - 1000 m	CAN YES 9 pin D-type connector (M) Set with two node number switches Max. 1000 m 500 kBit/sec 250 kBit/sec 50 kBit/sec

General Information

The programmable interface processor IF152 has a CPU and two interfaces. One feature of the IF152 is that it can either be used as an intelligent interface processor or a CPU. The module itself recognizes the correct operating mode from the slot used.

Usually, the module is used as an interface processor, to relieve the strain on the CPU.

On the module, there is a Reset key, status LEDs, two HEX number dials for the CAN bus station number and the connector for a RS232 and a CAN interface.



CPU's

IF260

Order Data

Model Number	Description	Figure
	CPU or Programmable Interface Processor	
3IF260.60-1	2005 CPU or programmable interface processor, 850 KB SRAM, 1.5 MB FlashPROM, 1 insert slot for insertable interface modules	
	Accessories	
0G0001.00-090	Cable PC <-> PCC/PW, RS232, Online cable	
Additional information concerning accessories can be found in sections "Accessories" and "Manuals".		

The interface modules listed below can be used with the IF260 module. An interface module equipped with an RS232 interface is required for a direct online connection.

Model Number	Description
3IF613.9	Three RS232 interfaces
3IF621.9	One RS485/RS422 interface and one CAN interface
3IF622.9	One RS232 interface and two RS485/RS422 interfaces
3IF661.9	One RS485 interface (PROFIBUS DP Slave)
3IF671.9	One RS232 interface, one RS485/RS422 interface and one CAN interface
3IF672.9	One RS232 interface and two CAN interfaces
3IF681.95	One RS232 interface and one ETHERNET interface with 10 BASE2 connection (CHEAPERNET BNC Socket)
3IF681.96	One RS232 interface and one ETHERNET interface with 10 BASE-T connection (Twisted Pair/RJ45 Socket)

Technical Data

Module ID	IF260
General	
C-UL-US Listed	YES
Module Type	B&R 2005 system module, single width
Slot 3 ≥4	Operation as CPU Operation as Programmable Interface Processor
Power Consumption	Max. 3.5 W
Processor	
Instruction Cycle Time	0.4 µsec
Standard Memory System RAM User RAM System PROM User PROM	174 KByte SRAM 850 KByte SRAM 512 KByte FlashPROM 1536 KByte FlashPROM
Data Buffering Buffer Battery in 2005 Rack with Battery Module AC240 with NiMH Battery Battery Monitoring	At least 4 years At least 2,5 years At least 2 months YES, when operating as main CPU

Module ID	IF260
Peripherals	
Real Time Clock Resolution	Nonvolatile 1 sec
Insert Slots	1 (for interface module inserts)
Reset Button	YES
Status Display	5 Status LEDs

General Information

The programmable interface processor IF260 has a CPU and an insert slot. One feature of the IF260 is that it can either be used as an intelligent interface processor, or as a CPU. The module itself recognizes the correct operating mode via the slot.

Normally, the module is used as an interface processor, to relieve the strain on the CPU.

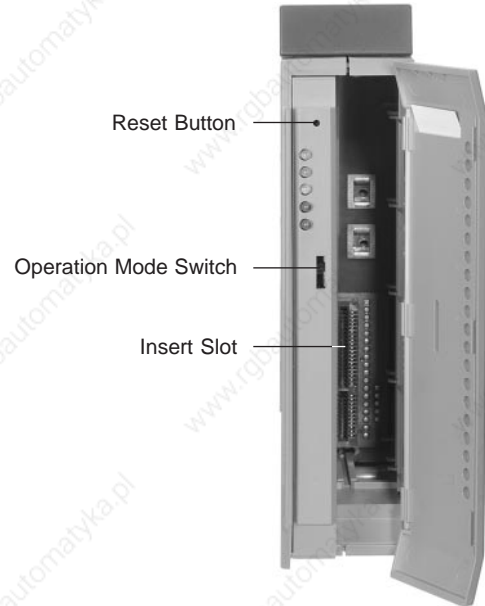

CPU

IP161

Order Data

Model Number	Description	Figure
	Programmable I/O Processor	
3IP161.60-1	2005 programmable I/O processor, 850 KB SRAM, 1.5 MB FlashPROM, 1 RS232 interface, 1 CAN interface, CAN: electrically isolated, network-capable, Max. 12 dig. inputs 24 VDC, sink, Max. 12 dig. outputs 24 VDC, 0.1 A, 6 analog inputs +/- 10 V, 14 bit, 6 analog outputs +/- 10 V, 12 bit, 2 outputs with +10 V and -10 V per block. Order terminal block separately!	
3TB170.9	2005 Terminal block, 20 pin screw clamp	
3TB170.91	2005 Terminal block, 20 pin cage clamp	
3TB170:90-02	2005 Terminal block, 20 pin, 20 pcs., screw clamp	
3TB170:91-02	2005 Terminal block, 20 pin, 20 pcs., cage clamp	
	Accessories	
0G0001.00-090	Cable PC <-> PCC/PW, RS232, Online cable	
7AC911.9	Bus adapter, CAN	
0AC912.9	Bus adapter, CAN, 1 CAN interface	
0AC913.92	Bus adapter, CAN, 2 CAN interfaces, incl. 30 cm connection cable	
0AC961.9	Bus adapter (CAN, RS232)	
Additional information concerning accessories can be found in sections "Accessories" and "Manuals".		

Technical Data

Module ID	IP161
General	
C-UL-US Listed	in preparation
Module Type	B&R 2005 system module, double width
Slot 3 ≥ 4	Operation as CPU (Slots 3+4 are used) Operation as Programmable I/O Processor
Power Consumption Digital Section Analog Section	Max. 6.5 W Max. 8 W + 3.5 W for potentiometer voltage (if used externally)
Processor	
Instruction Cycle Time	0.4 µsec
Standard Memory System RAM User RAM System PROM User PROM	174 KByte SRAM 850 KByte SRAM 512 KByte FlashPROM 1,5 MByte FlashPROM
Data Buffering Buffer Battery in 2005 Rack with Battery Module AC240 Battery Monitoring	At least 4 years At least 2 years YES, when used as main CPU
Peripherals	
Real Time Clock Resolution	Nonvolatile when used as CPU (external buffering) 1 sec
Reset Button	YES
Status Display	4 Status LEDs, 4 Interface LEDs

Module ID	IP161
Standard Communication Interface	
Application Interface IF1 Isolation Connection Distance Baudrate	RS232 NO 9 pin D-type connector (M) Max. 15 m / 19200 Baud Max. 115.2 kBaud
Application Interface IF2 Isolation Connection Station Number Distance max. Baudrate Bus Length 10 - 60 m Bus Length 100 - 200 m Bus Length 800 - 1000 m	CAN YES 9 pin D-type connector (M) Set with two node number switches Max. 1000 m 500 kBit/sec 250 kBit/sec 50 kBit/sec
Application Interface IF1 Isolation Connection Distance Baudrate	RS232 NO 9 pin D-type connector (M) Bus adapter is required for operation Max. 15 m / 19200 Baud Max. 115.2 kBaud
Potentiometer Voltage Outputs	
Number and Type of Potentiometer Voltages	2 outputs with +10 V and -10 V per terminal block
Isolation to PCC	YES
Output Current	±80 mA (simultaneous)
Maximum Output Power	1.6 W
Analog Inputs	
Number of Inputs	6
Input Signal, Nominal	±10 V
Digital Converter Resolution	14 Bit
Input Impedance in Signal Range Static Dynamic	2 MΩ 3 kΩ / 10 nF
Isolation Voltage between Input and Bus	±50 V
Analog Outputs	
Number of Outputs	6
Voltage Output	±10 V
Digital Converter Resolution	12 Bit
Load Impedance	≥1 kΩ
Output Response when Current Supply is Switched On/Off	Enable relay switches on when a defined value of 0 V Basic setting = close the output terminal using relay contact
Isolation Voltage between Output and Bus	±50 V
Repeat Precision at a Certain Temperature after Define Stabilizing Time	±2 LSB (noise at constant temperature in 24 hours)
Digital Inputs	
Number of Inputs	Up to 12 Configuration as input or output takes place in groups of two using software
Rated Voltage	+24 VDC
Rated Frequency	Max. 200 kHz (symmetrical square wave)
Wiring	Sink
Limit Values 0-Signal UL 0-Signal IL	≤5 V ≤2 mA
Delay 0 to 1	≤2.5 μsec
Delay 1 to 0	≤2.5 μsec

Module ID	IP161
Power Consumption (external) Per Group at 24 V (no load) Per Digital Input at 24 V	≤0.48 W 0.24 W
Interrupt Capable	YES Parameters can be set using LTX functions. Each digital input can trigger an IRQ. Attention: Handled using an exception task
Isolation Voltage between Input and Bus	±50 V
Digital Outputs	
Number and Type of Outputs	Up to 12 transistor outputs (Push/Pull) Configuration as input or output takes place in groups of two using software
Rated Current (1-Signal)	±100 mA
Rated Voltage	+24 VDC
Switching Voltage Range	+12 to +35 VDC
Wiring	Sink or Source
Power Consumption per Group (external)	≤20 mA + load current of the outputs
Type of External Protective Circuit	For inductive loads, terminal diodes can be connected between output and the group supply (24 VDC and GND)
Delay 0 to 1	≤2 μsec for resistive loads
Delay 1 to 0	≤2 μsec for resistive loads
Total Output Current	Max. 400 mA/group (static)
Isolation Voltage between Output and Bus	±50 V

General Information

The programmable I/O processor IP161 has a CPU, three interfaces, and digital/analog inputs/outputs. The features of the IP161 module are the interrupt-capable digital inputs and outputs as well as high speed analog inputs which can be operated in both FIFO or comparator mode. The IP161 module can either be used as an intelligent I/O processor or a CPU. The module itself recognizes the correct mode of operation from the slot used.

The module is usually used as an I/O processor, to relieve strain on the CPU.

The module has three I/O groups, a reset button, status LEDs, two HEX number dials for the CAN bus station number and the connector for two RS232 interfaces and a CAN interface.

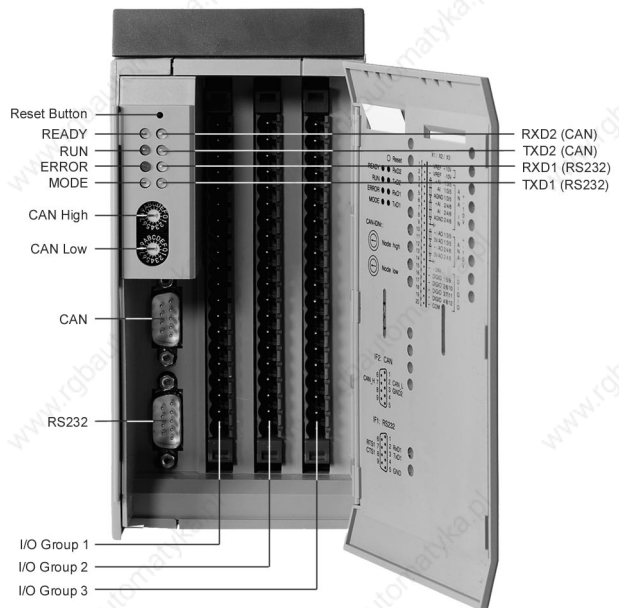

CPU

XP152

Order Data

Model Number	Description	Figure
	CPU	
3XP152.60-1	2005 CPU, 118 KB SRAM, 256 KB FlashPROM, 1 RS232 interface, 1 CAN interface, CAN: electrically isolated, network-capable, Insert for power supply modules	
3XP152.60-2	2005 CPU, 118 KB SRAM, 512 KB FlashPROM, 1 RS232 interface, 1 CAN interface, CAN: electrically isolated, network-capable, Insert for power supply modules	
	Accessories	
0G0001.00-090	Cable PC <-> PCC/PW, RS232, Online cable	
7AC911.9	Bus adapter, CAN	
0AC912.9	Bus adapter, CAN, 1 CAN interface	
0AC913.92	Bus adapter, CAN, 2 CAN interfaces, incl. 30 cm connection cable	
Additional information concerning accessories can be found in sections "Accessories" and "Manuals".		

Technical Data

Module ID	XP152	
General		
C-UL-US Listed	YES	
Module Type	B&R 2005 CPU	
Slot	Power supply insert PS465, PS694 or PS794	
Power Consumption	Max. 4 W	
Processor		
Instruction Cycle Time	0.8 µsec	
SRAM		
System RAM	138 KByte	
User RAM	118 KByte	
FlashPROM		
System PROM	256 KByte	512 KByte
User PROM	256 KByte	512 KByte
Data Buffering		
Buffer Battery in 2005 Rack with Battery Module AC240	At least 4 years	
Battery Monitoring	At least 2 years	
	YES, when used as main CPU (Rev. 12.00 and up)	
Peripherals		
Real Time Clock	Nonvolatile (external buffering)	
Resolution	1 sec	
Reset Button	YES	
Status Display	LEDs	
Standard Communication Interface		
Application Interface IF1	RS232	
Isolation	NO	
Connection	9 pin D-type connector (M)	
Distance	Max. 15 m / 19200 Baud	
Baudrate	Max. 64 kBaud	
Application Interface IF2	CAN	
Isolation	YES	
Connection	9 pin D-type connector (M)	
Distance	Max. 1000 m	
Maximum Baudrate		
Bus Length 10 - 60 m	500 kBit/sec	
Bus Length 100 - 200 m	250 kBit/sec	
Bus Length 800 - 1000 m	50 kBit/sec	

General Information

The XP152 module is a CPU insert for the power supply modules. This means that the CPU does not require its own slot. The module is equipped with a RESET button, Status LEDs, two HEX number switches for the CAN Bus station number and the connectors for an RS232 and a CAN interface.

If desired, the XP152 module can be operated as intelligent CAN Bus processor, in addition to a CPU (CP15x or CP260). With this type of operation, the XP152 cannot access local modules on the 2005 unit. It is controlled by the CPU, collects data from the CAN stations (e.g. I/O) and makes this data available to the CPU.

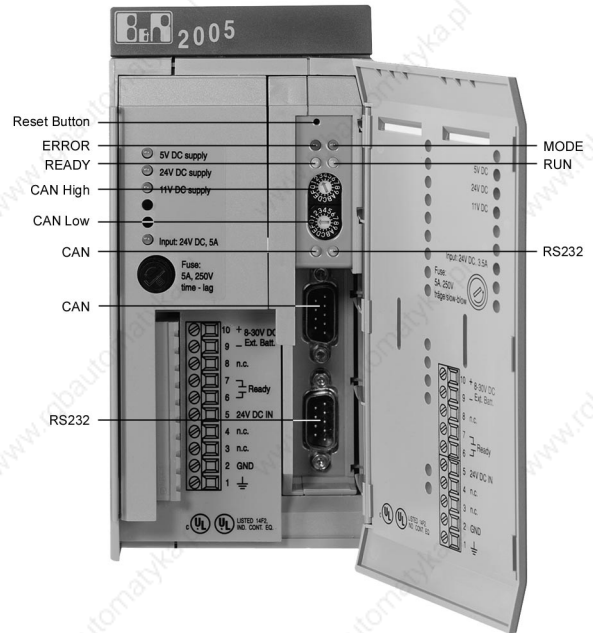

Programmable Module

DM455

Order Data

Model Number	Description	Figure
3DM455.60-2	2005 digital mixed module, 8 Inputs, 24 VDC, 2,5 µsec, sink, 8 transistor outputs, 0 to 50 VDC, 1 A, Order terminal block separately!	
3TB170.9	2005 Terminal block, 20 pin screw clamp	
3TB170.91	2005 Terminal block, 20 pin cage clamp	
3TB170:90-02	2005 Terminal block, 20 pin, 20 pcs., screw clamp	
3TB170:91-02	2005 Terminal block, 20 pin, 20 pcs., cage clamp	

Technical Data

Module ID	DM455
General	
C-UL-US Listed	YES
Module Type	B&R 2005 I/O Module
Insert in Main Rack Expansion Rack	YES YES
Power Consumption	Max. 3.5 W
Inputs	
Number of Inputs	8
Input Voltage Minimum Nominal Maximum	18 VDC 24 VDC 30 VDC
Input Current at Nominal Voltage	Approx. 5 mA
Input Frequency	Max. 100 kHz, Limited by software
Wiring	Sink
Switching Threshold LOW Range Switching Range HIGH Range	<5 V 5 bis 15 V >15 V
Areas of Use	Encoder evaluation, signal measurement, fast signal processing
Delay 0 to 1	Max. 2,5 µsec
Delay 1 to 0	Max. 2,5 µsec
Isolation Input – PCC Input – Input	YES (optocoupler) YES (optocoupler)
Outputs	
Number of Outputs	8
Type	Transistor
Supply Voltage	0 - 50 VDC
Supply Voltage Range + to Ground - to Ground	Max. +70 VDC Max. -70 VDC

Module ID	DM455
Continuous Current per Outputs Push, Pull, Push/Pull Motor Operation	Max. 1 A Max. 1 A per winding
Protective Circuit Internal External	YES Generally necessary (fuse)
Delay 0 to 1	Max. 7 µsec
Delay 1 to 0	Max. 7 µsec
Switching Frequency (resistive load)	Max. 100 kHz, Limited by software
Isolation Output – PCC Output – Input	YES (optocoupler) YES (optocoupler)
Mechanical Characteristics	
Dimensions	B&R 2005 single width

Application Memory Modules

General Information

The application memory module is inserted into the front of the CPU. Application RAM, application PROM and operating system ROM are found in the application memory module.

Buffering the RAM

The application RAM is buffered by a lithium battery. The memory contents are kept for at least 2 years without power.

The buffer time is shorter if the application memory module is located in a CPU. This is because the same battery which is used for buffering the application RAM is used for buffering CPU memory, when the CPU rechargeable battery has no buffer capacity left.

Application Memory Modules

ME960 / ME963 / ME965

Order Data

Model Number	Description	Figure
	Application Memory	
3ME960.90-1	2005 Application memory, 64 KB SRAM, 256 KB FlashPROM, With PCC operating system	
3ME963.90-1	2005 Application memory, 512 KB SRAM, 1 MB FlashPROM, With PCC operating system	
3ME965.90-1	2005 Application memory, 1 MB SRAM, 2 MB FlashPROM, With PCC operating system	
	Accessories	
0AC201.9	Lithium batteries, 5 pieces, 3 V / 950 mAh	
The backup battery is included with the delivery.		

Technical Data

Module ID	ME960	ME963	ME965
General			
C-UL-US Listed	YES		
Operating System	PCC Software		
Memory			
User SRAM	64 KByte	512 KByte	1 MByte
User FlashPROM	256 KByte	1024 KByte	2 MByte
FlashPROM Erase/Program	Programming logic in the module, LED display		
FlashPROM Write Protection	Switch on the module		
RAM Buffering ¹⁾ Lithium Battery (APM) Gold Foil Capacitor (APM)	At least 2 years At least 10 min.		
Storage			
Storage Temperature APM without Lithium Battery APM with Lithium Battery Lithium Battery (not installed)	-20 to +70 °C -20 to +60 °C -20 to +60 °C		
Storage Time Lithium Battery (not installed)	Max. 3 years at 30 °C		
Mechanical Characteristics			
Dimensions Height Width Depth	140 mm 20 mm 90 mm		

¹⁾ The buffer time given refers to application memory that is not installed in the CPU. Otherwise, the buffer time is reduced to 1 year because the RAM in the CPU is also being buffered.

General Information

Application Memory (APM) is required to save application programs. It is inserted into the slot provided on the CPU. Application memory contains Operating System ROM, User RAM and User PROM.

The operating system is stored in System Flash. The programming system can be used to download the operating system or to carry out an operating system update.

Digital Input Modules

General Information

Digital input modules convert binary process signals into the internal signals required by the PCC. The states of the digital inputs are indicated with LEDs.

Relevant input module features are:

- Number of Inputs
- Input Voltage
- Input Delay (filter)
- Special Functions (e.g. counter inputs)

Input Filter

All inputs have an input filter. The input delay is shown in the technical data sections. Disturbance pulses that are shorter than the input delay are suppressed by the input filter.

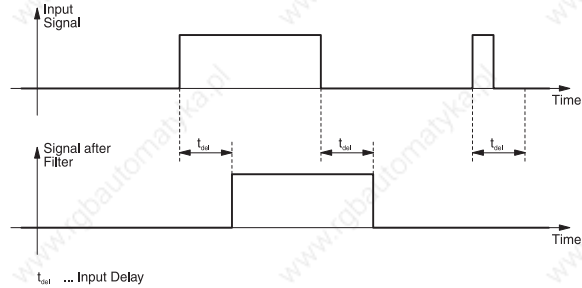

Sink/Source Wiring

Most 24 VDC B&R SYSTEM 2005 input modules can be either wired as sink or source circuits. As the inputs of most modules are generally split into isolated groups of four inputs, the individual groups can be wired differently.

For sink circuits (current consumers from sensor's point of view), the input group COM link is connected ground and the inputs are connected to 24 VDC switching sensors.

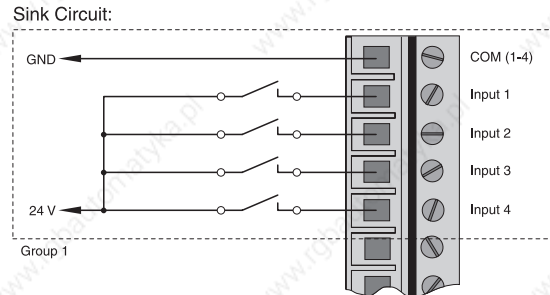

For source circuits (current source from sensor's point of view), the input group COM link is connected +24 VDC and the inputs are connected to ground switching sensors.

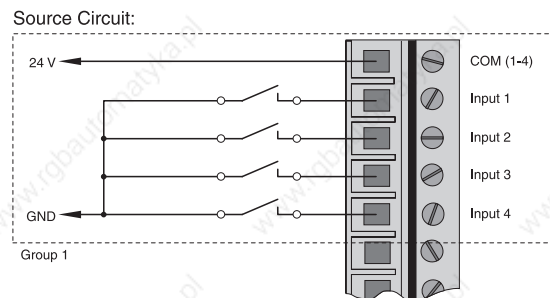

Overview

Module	DI450	DI475	DI476	DI477	DI695
Number of Inputs	16	16	16	32	16
Input Voltage	24 VDC	24 VDC	24 VDC	24 VDC	120 / 230 VAC
Input Delay	1 msec (Inputs 1-8) 10 msec (Inputs 9-16)	10 msec	1 msec	1 msec	50 msec
Remarks	Inputs 1-4: Counter Inputs Inputs 5-6: Gate Time Measurement				

Digital Input Module

DI450

Order Data

Model Number	Description	Figure
3DI450.60-9	2005 Digital input module, 16 inputs 24 VDC, 1 msec or 10 msec, Sink or sink/source, 4 electrically isolated input groups, 4 counter inputs, 100 kHz, Gating or duration measurement, Order terminal block separately!	
3TB170.9	2005 Terminal block, 20 pin screw clamp	
3TB170.91	2005 Terminal block, 20 pin cage clamp	
3TB170:90-02	2005 Terminal block, 20 pin, 20 pcs., screw clamp	
3TB170:91-02	2005 Terminal block, 20 pin, 20 pcs., cage clamp	

Technical Data

Module ID	DI450
General	
C-UL-US Listed	YES
Insert in Main Rack Expansion Rack	YES YES
Static Characteristics	
Module Type	B&R 2005 I/O Module
Number of Inputs Total in 4 groups of	16 4
Input Types Channels 1 - 4 Channels 5 - 6 Channels 7 - 16	8 bit counter Gate time, period measurement (Rev. 30.00 and up) Digital inputs
Wiring Groups 1 + 2 (Inputs 1 - 8) Groups 3 + 4 (Inputs 9 - 16)	Sink Sink or Source
Input Voltage Nominal Maximum	24 VDC 30 VDC
Input Current at 24 VDC at 30 VDC	Approx. 8 mA Approx. 10 mA
Input Resistance	2.8 kΩ
Switching Threshold LOW Range Switching Range HIGH Range	<5 V 5 to 15 V >15 V
Switching Delay Inputs 1 - 8 Typical Maximum Inputs 9 - 16 Typical Maximum	1 msec 1.2 msec 10 msec 12 msec
Counter Inputs Inputs Counter Size Counter Frequency	1 - 4 8 Bit (individual) ¹⁾ Max. 100 kHz

Module ID	DI450
Gate Time Measurement Channels Gate Frequency Gate Pause	5 and 6 Max. 10 kHz >50 µsec
Period Duration Measurement Channels Input Frequency	5 and 6 Max. 10 kHz
Power Consumption	Max. 2 W
Operating Characteristics	
Isolation Input – PCC Group – Group Input – Input (same Group)	YES (optocoupler) YES (optocoupler) NO
Mechanical Characteristics	
Dimensions	B&R 2005 single width

¹⁾ Counter Inputs 1 and 2 as well as 3 and 4 can be linked together as a 16 bit counter.

Digital Input Modules

DI475 / DI476

Order Data

Model Number	Description	Figure
3DI475.6	2005 Digital input modules, 16 inputs 24 VDC, 10 msec, sink/source, 4 electrically isolated input groups, Order terminal block separately!	
3DI476.6	2005 Digital input modules, 16 inputs 24 VDC, 1 msec, sink/source, 4 electrically isolated input groups, Order terminal block separately!	
3TB170.9	2005 Terminal block, 20 pin screw clamp	
3TB170.91	2005 Terminal block, 20 pin cage clamp	
3TB170:90-02	2005 Terminal block, 20 pin, 20 pcs., screw clamp	
3TB170:91-02	2005 Terminal block, 20 pin, 20 pcs., cage clamp	

Technical Data

Module ID	DI475	DI476
General		
C-UL-US Listed	YES	
Insert in Main Rack Expansion Rack	YES YES	
Static Characteristics		
Module Type	B&R 2005 I/O Module	
Number of Inputs Total in 4 Groups of	16 4	16 4
Wiring	Sink or Source	
Input Voltage Nominal Maximum	24 VDC 30 VDC	
Input Current at Nominal Voltage	Approx. 5 mA	
Input Resistance	4.8 kΩ	
Switching Threshold LOW Range Switching Range HIGH Range	<5 V 5 to 15 V >15 V	
Switching Delay Typical Maximum	10 msec 12 msec	1 msec 1.2 msec
Power Consumption	Max. 1.5 W	
Operating Characteristics		
Isolation Input – PCC Group – Group Input – Input (same Group)	YES (optocoupler) YES (optocoupler) NO	
Mechanical Characteristics		
Dimensions	B&R 2005 single width	

Digital Input Module

DI477

Order Data

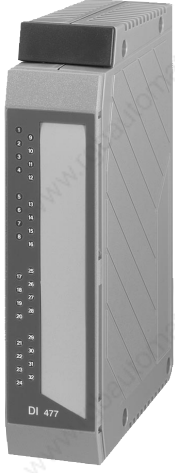
Model Number	Description	Figure
3DI477.6	2005 Digital input modules, 32 inputs 24 VDC, 1 msec, sink/source, 8 electrically isolated input groups	

Technical Data

Module ID	DI477
General	
C-UL-US Listed	YES
Insert in Main Rack Expansion Rack	YES YES
Static Characteristics	
Module Type	B&R 2005 I/O Module
Number of Inputs Total in 8 Groups of	32 4
Wiring	Sink or Source
Input Voltage Nominal Maximum	24 VDC 30 VDC
Input Current at Nominal Voltage	Approx. 5 mA
Input Resistance	4.8 k Ω
Switching Threshold LOW Range Switching Range HIGH Range	<5 V 5 to 15 V >15 V
Switching Delay Typical Maximum	1 msec 1.2 msec
Power Consumption	Max. 1.5 W
Operating Characteristics	
Isolation Input – PCC Group – Group Input – Input (same group)	YES (optocoupler) YES (optocoupler) NO
Mechanical Characteristics	
Dimensions	B&R 2005 single width

Digital Input Module

DI695

Order Data

Model Number	Description	Figure
3DI695.6	2005 Digital input module, 16 inputs 120/230 VAC, 50 msec, 2 electrically isolated input groups, Order terminal block separately!	
3TB170.9	2005 Terminal block, 20 pin screw clamp	
3TB170.91	2005 Terminal block, 20 pin cage clamp	
3TB170:90-02	2005 Terminal block, 20 pin, 20 pcs., screw clamp	
3TB170:91-02	2005 Terminal block, 20 pin, 20 pcs., cage clamp	

Technical Data

Module ID	DI695
General	
C-UL-US Listed	YES
Insert in Main Rack Expansion Rack	YES YES
Static Characteristics	
Module Type	B&R 2005 I/O Module
Number of Inputs	16
Rated Voltage	120 / 230 VAC
Rated Frequency	50 / 60 Hz
Limit Values 0-Signal UL 0-Signal IL	Max. 40 VAC Max. 15 mA
Delay 0 to 1	Max. 50 msec
Delay 1 to 0	Max. 50 msec
Power Consumption Internal External	Max. 1.5 W Max. 4 W
Operating Characteristics	
Isolation Voltage under Normal Operating Conditions between Channel and Bus	2500 VAC
Different Circuits Possible	YES, but not different phases
Mechanical Characteristics	
Dimensions	B&R 2005 single width

Digital Output Modules

General Information

Digital output modules are used for driving external loads (relays, motors, solenoid). The states of the digital outputs are indicated by status LEDs.

Relevant output module features are:

- Number of Outputs
- Type (relays, transistors, triac)
- Switching Voltage
- Continuous Current

Protective Circuit

The transistor output modules DO479 and DO480 are equipped with overload protection and an internal protection circuit against overload peaks or reversed polarity. These modules make fast switching of inductive loads with a negative voltage possible, and external inverse diodes are not needed.

Relays and triac output modules have an external overload protection (fuse).

Overview

Module	DO479	DO480	DO650	DO690	DO750	DO760
Number of Outputs	16	16	16	8	8	8
Type	Transistor	Transistor	Relay	Triac	Relay	Relay
Switching Voltage						
Minimum	19.5 VDC	0 VDC		30 VAC		
Nominal	24 VDC	24 VDC	120 VAC / 24 VDC	120 VAC	230 VAC / 24 VDC	30 VDC / 240 VAC
Maximum	30 VDC	48 VDC	144 VAC / 30 VDC	144 VAC	250 VAC / 30 VDC	125 VDC / 264 VAC
Continuous Current						
Per Output	Max. 0.5 A	Max. 2 A	Max. 2 A	Max. 1 A	Max. 3 A	Max. 4 A
Per Group	Max. 4 A	Max. 12 A	Max. 8 A	Max. 2 A	Max. 8 A	
Per Module	Max. 8 A	Max. 24 A	Max. 32 A	Max. 4 A	Max. 16 A	Max. 32 A

Digital Output Modules

DO479 / DO480

Order Data

Model Number	Description	Figure
3DO479.6	2005 Digital output module, 16 transistor outputs 24 VDC, 0.5 A, 2 electrically isolated output groups, Order terminal block separately!	
3DO480.6	2005 Digital output module, 16 transistor outputs 24 VDC, 2 A, 2 electrically isolated output groups, Order terminal block separately!	
3TB170.9	2005 Terminal block, 20 pin screw clamp	
3TB170.91	2005 Terminal block, 20 pin cage clamp	
3TB170:90-02	2005 Terminal block, 20 pin, 20 pcs., screw clamp	
3TB170:91-02	2005 Terminal block, 20 pin, 20 pcs., cage clamp	

Technical Data

Module ID	DO479	DO480
General		
C-UL-US Listed	YES	
Insert in Main Rack Expansion Rack	YES YES	
Static Characteristics		
Module Type	B&R 2005 I/O Module	
Number of Outputs Total In 2 Groups of	16 8	
Type	Transistor	
Switching Voltage Minimum Nominal Maximum	19.5 VDC 24 VDC 30 VDC	0 VDC 24 VDC 48 VDC
Continuous Current Per Output Per Group Per Module	Max. 0.5 A Max. 4 A Max. 8 A	Max. 2 A Max. 12 A ¹⁾ Max. 24 A
Leakage Current when Turned Off	0.3 mA	0.1 mA
Lamp Rating	15 W / 24 V	
Power Consumption Internal Terminal Side at 24 V	Max. 1 W Max. 2 W per Group	Max. 2.5 W
Protection		
Protective Circuit Internal External	YES Only if necessary (surge)	
Dynamic Characteristics		
Switching Delay log. 0 - log. 1 (typ./max.) log. 1 - log. 0 (typ./max.)	5 µsec / 110 µsec 60 µsec / 100 µsec	4 µsec / 120 µsec 100 µsec / 120 µsec
Switching Frequency (resistive load)	max. 500 Hz	
Operating Characteristics		
Isolation Output – PCC Group – Group Output – Output	YES YES NO	
Mechanical Characteristics		
Dimensions	B&R 2005 single width	

¹⁾ Simultaneousness factor = 75 %, maximum 12 of the 16 outputs can be fully loaded at the same time.

Digital Output Modules

DO650 / DO750

Order Data

Model Number	Description	Figure
3DO650.6	2005 Digital output module, 16 relay outputs 120 VAC / 24 VDC, 2 A, 4 electrically isolated output groups, Order terminal block separately!	
3DO750.6	2005 Digital output module, 8 relay outputs 230 VAC / 24 VDC, 3 A, 2 electrically isolated output groups, Order terminal block separately!	
3TB170.9	2005 Terminal block, 20 pin screw clamp	
3TB170.91	2005 Terminal block, 20 pin cage clamp	
3TB170:90-02	2005 Terminal block, 20 pin, 20 pcs., screw clamp	
3TB170:91-02	2005 Terminal block, 20 pin, 20 pcs., cage clamp	

Technical Data

Module ID	DO650	DO750
General		
C-UL-US Listed	YES	
Insert in Main Rack Expansion Rack	YES YES	
Static Characteristics		
Module Type	B&R 2005 I/O Module	
Number of Outputs Total In 4/2 Groups of	16 4	8 4
Type	Relay / N.O.	
Switching Voltage Nominal Maximum	120 VAC / 24 VDC 144 VAC / 30 VDC	230 VAC / 24 VDC 250 VAC / 30 VDC
Continuous Current Per Output Per Group Per Module	Max. 2 A Max. 8 A Max. 32 A	Max. 3 A Max. 8 A Max. 16 A
Switching Capacity Minimum Maximum	0.1 mA / 0.1 VDC 300 VA / 90 W	10 mA / 5 VDC 500 VA / 150 W
Switching Frequency (nominal load)	Max. 10 Hz	
Power Consumption	Max. 4 W	Max. 3 W
Protection		
Short Circuit (external)	Fuse 8 A slow-blow per group (COM connection)	
External Protective Circuit	generally required	
Dynamic Characteristics		
Switching Delay log. 0 - log. 1 (typ./max.) log. 1 - log. 0 (typ./max.)	5.6 msec / 10 msec 2.5 msec / 5 msec	4 msec / 6 msec 6 msec / 8 msec
Operating Characteristics		
Isolation Output - PCC Group - Group Output - Output	YES / max. 144 VAC YES / max. 250 VAC NO	
Mechanical Characteristics		
Dimensions	B&R 2005 single width	

Digital Output Modules

DO690

Order Data

Model Number	Description	Figure
3DO690.6	2005 Digital output module, 8 triac outputs 120 VAC, 1 A, 2 electrically isolated output groups, Order terminal block separately!	
3TB170.9	2005 Terminal block, 20 pin screw clamp	
3TB170.91	2005 Terminal block, 20 pin cage clamp	
3TB170:90-02	2005 Terminal block, 20 pin, 20 pcs., screw clamp	
3TB170:91-02	2005 Terminal block, 20 pin, 20 pcs., cage clamp	

Technical Data

Module ID	DO690	
General		
C-UL-US Listed	YES	
Insert in		
Main Rack	YES	
Expansion Rack	YES	
Static Characteristics		
Module Type	B&R 2005 I/O Module	
Number of Outputs Total	8	
In 2 Groups of	4	
Type	Triac	
Switching Voltage		
Minimum	30 VAC	
Nominal	120 VAC	
Maximum	144 VAC	
Frequency of the Switching Voltage	45 to 63 Hz	
Continuous Current		
Per Output	Max. 1 A	
Per Group	Max. 2 A (simultaneousness factor = 50%) ¹⁾	
Per Module	Max. 4 A	
Leakage Current	4 mA (resistive load)	
Power Consumption		
Internal	Max. 1.5 W	
External	Max. 6 W (simultaneousness factor = 50%) ¹⁾	
Protection		
Overload Protection		
Internal	YES	
External	By user	
Protective Circuit		
Internal	YES	
External	generally required (Fuse)	
Dynamic Characteristics		
Switching Voltage; Switching Voltage Frequency	50 Hz	60 Hz
log. 0 - log. 1	10 msec	8.5 msec
log. 1 - log. 0	10 msec	8.5 msec
Switching Frequency (resistive load)	Max. 100 Hz	
Operating Characteristics		
Isolation		
Output – PCC	YES (optotriac)	
Group – Group	YES (optotriac)	
Output – Output	NO	
Mechanical Characteristics		
Dimensions	B&R 2005 single width	

¹⁾ Simultaneousness factor = 50 %, maximum 4 of 8 outputs are allowed to be fully loaded at the same time.

Digital Output Module

DO760

Order Data

Model Number	Description	Figure
3DO760.6	2005 Digital output module, 8 relay outputs 240 VAC / 30 VDC, 4 A, Single channel isolated outputs, Order terminal block separately!	
3TB170.9	2005 Terminal block, 20 pin screw clamp	
3TB170.91	2005 Terminal block, 20 pin cage clamp	
3TB170:90-02	2005 Terminal block, 20 pin, 20 pcs., screw clamp	
3TB170:91-02	2005 Terminal block, 20 pin, 20 pcs., cage clamp	

Technical Data

Module ID	DO760
General	
C-UL-US Listed	YES
Insert in Main Rack Expansion Rack	YES YES
Static Characteristics	
Module Type	B&R 2005 I/O Module
Number and Type of Outputs	4 change-over / 4 N.O., channels are individually isolated
Rated Voltage	30 VDC / 240 VAC
Switching Voltage Range	Min. 5 VDC at 1 mA
Rated Frequency	DC or 45 - 63 Hz
Rated Current (1-Signal)	4 A (resistive load)
Switching Capacity	2000 VA; 120 W at 30 VDC (resistive load)
Wiring	4 change-over / 4 N:O:
Power Consumption Internal External	Max. 4 W Max. 4 W
Protection	
Type of Protection Short Circuit Protection AC DC Overload Protection for Contacts DC-Activation	Fuse 8 A slow-blow (external) Fuse 4 A slow-blow (external) Limited to 460 V (external) Spark protection (external)
Dynamic Characteristics	
Output Delay for Signal Transition from log 0 - log 1 log 1 - log 0	Max. 13 msec (incl. chatter time) Max. 16 msec (incl. chatter time)
Operating Characteristics	
Total Output Current Following Conditions must be Fulfilled Cable Cross Section	Max. 32 A $\Sigma I_n^2 \leq 200$ 2.5 mm ² , for currents ≥ 4 A or if a recommended value is reached
Isolation Voltage under Normal Conditions between Channel and Bus	1 minute 2800 VAC or 4 kV at 1.2 x 50 μ sec pulse
Different Phases Possible	YES, but only for 110 VAC
Mechanical Characteristics	
Dimensions	B&R 2005 single width

Digital Mixed Modules

General Information

Digital mixed modules are a combination of digital input and output modules.
The states of the digital inputs or outputs are shown by the status LEDs.

Overview

Module	DM476
Number of Inputs	16
Nominal Input Voltage	24 VDC
Number of Outputs	16
Switching Voltage	24 VDC
Continuous Current	0.4 A

Digital Mixed Modules

DM476

Order Data

Model Number	Description	Figure
3DM476.6	2005 Digital mixed module, 16 inputs, 24 VDC / 24 VAC, 1 msec, DC: sink/source, 4 electrically isolated input groups, 16 transistor outputs, 24 VDC, 0,4 A	

Technical Data

Module ID	DM476
General	
C-UL-US Listed	YES
Module Type	B&R 2005 I/O Module
Insert in Main Rack Expansion Rack	YES YES
Power Consumption intern Terminal Side at 24 V	Max. 2.5 W Max. 2 W
Inputs 25 pin D-type Female Connector (Upper)	
Number of Inputs Total in 4 groups of	16 4
Input Voltage Nominal Maximum	24 VDC / 24 VAC 30 VDC / 30 VAC
Input Voltage at Nominal Voltage	Approx. 5 mA
Wiring	Sink or Source
Switching Threshold LOW Range Switching Range HIGH Range	<5 V 5 to 15 V >15 V
Delay 0 to 1	Max. 1 msec
Delay 1 to 0	Max. 1 msec
Isolation Input – PCC Group – Group Input – Input (same group)	YES (optocoupler) YES (optocoupler) NO
Outputs 25 pin D-type Male Connector (Lower)	
Number of Outputs	16
Type	Transistor
Switching Voltage Minimum Nominal Maximum	18 VDC 24 VDC 30 VDC

Module ID	DM476
Continuous Current Per Output Per Module	Max. 0.4 A Max. 4.8 A ¹⁾
Leakage Current when Turned Off	0.3 mA
Protective Circuit Internal External	YES Only if required (surge)
Delay 0 to 1	Max. 100 µsec
Delay 1 to 0	Max. 100 µsec
Switching Frequency (resistive load)	Max. 500 Hz
Isolation Output – PCC Output – Output	YES NO
Mechanical Characteristics	
Dimensions	B&R 2005 single width

¹⁾ Simultaneousness factor = 75 %
Max. 12 of the 16 outputs are allowed to be fully loaded at one time.

Analog Input Modules

General Information

Analog input modules convert measurements (voltage, current) into number values, which can be processed by the PCC.

Analog data is always in the 16 bit 2s complement in the PCC, regardless of the resolution. Therefore, the resolution of the module used does not have to be taken into consideration when creating an application.

All analog input modules are provided with a status LED labeled „RUN“. This LED shows that the A/D conversion is taking place.

Overview

Module	AI350	AI375	AI775
Number of Inputs	8	8	8
Input Signal	±10 V	0 to 10 V	0 to 20 mA
Digital Converter Resolution	12 Bit	12 Bit	12 Bit

Analog Input Modules

AI350 / AI375 / AI775

Order Data

Model Number	Description	Figure
3AI350.6	2005 Analog input module, 8 inputs, +/- 10 V, 12 bit, Order terminal block separately!	
3AI375.6	2005 Analog input module, 8 inputs, 0 to 10 V, 12 bit, Order terminal block separately!	
3AI775.6	2005 Analog input module, 8 inputs, 0 to 20 mA, 12 bit, Order terminal block separately!	
3TB170.9	2005 Terminal block, 20 pin screw clamp	
3TB170.91	2005 Terminal block, 20 pin cage clamp	
3TB170:90-02	2005 Terminal block, 20 pin, 20 pcs., screw clamp	
3TB170:91-02	2005 Terminal block, 20 pin, 20 pcs., cage clamp	

Technical Data

Module ID	AI350	AI375	AI775
General			
C-UL-US Listed		YES	
Insert in Main Rack Expansion Rack		YES YES	
Static Characteristics			
Module Type	B&R 2005 I/O Module		
Number of Inputs	8		
Input Signal Nominal Min./Max. Allowed	-10 to +10 V -20 to +20 V	0 to +10 V -20 to +20 V	0 to 20 mA -50 to +50 mA
Digital Converter Resolution	12 Bit		
Data Format Sent to Application Program	INT16 \$8000 - \$7FF0	INT16 \$0000 - \$7FF8	INT16 \$0000 - \$7FF8
Input Impedance in Signal Range	2 M Ω	2 M Ω	50 Ω
Power Consumption	Max. 5 W		
Operating Characteristics			
Isolation Voltage under Normal Conditions between Channel and Bus	± 50 V		
Mechanical Characteristics			
Dimensions	B&R 2005 single width		

Analog Output Modules

General Information

Analog output modules convert PCC internal number values into voltage or current. The number values to be converted must be in 16 bit 2s complement. The conversion is made irrespective of the resolution of the output module used.

All analog output modules have a status LED labeled „RUN“. This LED shows that the D/A conversion is taking place.

Overview

Module	AO350	AO775
Number of Outputs	8	8
Output Signal	± 10 V	0 bis 20 mA
Digital Converter Resolution	12 Bit	11 Bit

Analog Output Modules

AO350 / AO775

Order Data

Model Number	Description	Figure
3AO350.6	2005 Analog output module, 8 outputs, +/- 10 V, 12 bit, Order terminal block separately!	
3AO775.6	2005 Analog output module, 8 Outputs, 0 to 20 mA, 11 bit, Order terminal block separately!	
3TB170.9	2005 Terminal block, 20 pin screw clamp	
3TB170.91	2005 Terminal block, 20 pin cage clamp	
3TB170:90-02	2005 Terminal block, 20 pin, 20 pcs., screw clamp	
3TB170:91-02	2005 Terminal block, 20 pin, 20 pcs., cage clamp	

Technical Data

Module ID	AO350	AO775
General		
C-UL-US Listed	YES	
Insert in Main Rack Expansion Rack	YES YES	
Static Characteristics		
Module Type	B&R 2005 I/O Module	
Number of Outputs	8	
Output Signal	-10 to +10 V	0 to 20 mA
Digital Converter Resolution	12 Bit	11 Bit
Max. Load per Output	±10 mA (load ≥1 kΩ)	
Load		Max. 600 Ω
Power Consumption	Max. 5 W	Max. 5.5 W
Operating Characteristics		
Isolation Output – PCC Output – Output	YES NO	
Mechanical Characteristics		
Dimensions	B&R 2005 single width	

Analog Mixed Modules

General Information

Analog mixed modules are a combination of analog input and output modules. All analog mixed modules are provided with status LEDs labelled „RUN“.

These LEDs show that the D/A and A/D conversion is being carried out.

Overview

Module	AM050	AM051	AM055	AM374
Number of Inputs	4	4	5	4
Input Signal	0 to 10 V	0 to 20 mA	0 to 10 V	0 - 10 V / 0 - 20 mA ¹⁾
Number of Outputs	4	4	3	4
Output Signal	±10 V	0 to 20 mA	±10 V	±10 V / 0 - 20 mA ¹⁾
Digital Converter Resolution	12 Bit	12 Bit	12 Bit	12 Bit

¹⁾ Can be switched in groups of 2.

Analog Mixed Modules

AM050

Order Data

Model Number	Description	Figure
3AM050.6	2005 Analog mixed module, 4 Inputs, 0 to 10 V, 12 bit, 4 Outputs, +/- 10 V, 12 bit, Order terminal block separately!	
3TB170.9	2005 Terminal block, 20 pin screw clamp	
3TB170.91	2005 Terminal block, 20 pin cage clamp	
3TB170:90-02	2005 Terminal block, 20 pin, 20 pcs., screw clamp	
3TB170:91-02	2005 Terminal block, 20 pin, 20 pcs., cage clamp	

Technical Data

Description refers to modules with revision number 50.00 and up.

Module ID	AM050
General	
C-UL-US Listed	YES
Insert in Main Rack Expansion Rack	YES YES
Static Characteristics	
Module Type	B&R 2005 I/O Module
Inputs Input Signal	4 0 – 10 V
Outputs Output Signal	4 ±10 V
Power Consumption	Max. 6.5 W
Operating Characteristics	
Isolation Voltage under Normal Conditions between Channel and Bus	±50 V
Analog Inputs	
Input Signal Nominal Min./Max. Allowed	0 to +10 V -20 to +20 V
Digital Converter Resolution	12 Bit
Input Impedance in Signal Range	2 MΩ
Analog Outputs	
Output Signal	±10 V
Digital Converter Resolution	12 Bit
Load Impedance	Min. 1 kΩ
Switch On/Off Behavior	Internal enable relay During boot-up or error: closed
Mechanical Characteristics	
Dimensions	B&R 2005 single width

Analog Mixed Module

AM051

Order Data

Model Number	Description	Figure
3AM051.6	2005 Analog mixed module, 4 inputs, 0 to 20 mA, 12 bit, 4 outputs, 0 to 20 mA, 12 bit, Order terminal block separately!	
3TB170.9	2005 Terminal block, 20 pin screw clamp	
3TB170.91	2005 Terminal block, 20 pin cage clamp	
3TB170:90-02	2005 Terminal block, 20 pin, 20 pcs., screw clamp	
3TB170:91-02	2005 Terminal block, 20 pin, 20 pcs., cage clamp	

Technical Data

Description refers to modules with revision number 50.00 and up.

Module ID	AM051
General	
C-UL-US Listed	YES
Insert in Main Rack Expansion Rack	YES YES
Static Characteristics	
Module Type	B&R 2005 I/O Module
Inputs Input Signal	4 0 - 20 mA
Outputs Output Signal	4 0 - 20 mA
Power Consumption	Max. 6.5 W
Operating Characteristics	
Isolation Voltage under Normal Conditions between Channel and Bus	±50 V
Analog Inputs	
Input Signal Nominal Min./Max. Allowed	0 to 20 mA -50 to +50 mA
Digital Converter Resolution	12 Bit
Input Impedance in Signal Range	50 Ω
Analog Outputs	
Output Signal	0 - 20 mA
Digital Converter Resolution	12 Bit
Load Impedance	Max. 600 Ω
Switch On/Off Behavior	Internal enable relay During boot-up or error: closed
Mechanical Characteristics	
Dimensions	B&R 2005 single width

Analog Mixed Module

AM055

Order Data

Model Number	Description	Figure
3AM055.6	2005 Analog mixed module, 5 inputs, 0 to 10 V, 12 bit, 3 outputs, +/- 10 V, 12 bit, 1 potentiometer voltage + 10 V, 2 potentiometer voltage terminals, Order terminal block separately!	
3TB170.9	2005 Terminal block, 20 pin screw clamp	
3TB170.91	2005 Terminal block, 20 pin cage clamp	
3TB170:90-02	2005 Terminal block, 20 pin, 20 pcs., screw clamp	
3TB170:91-02	2005 Terminal block, 20 pin, 20 pcs., cage clamp	

Technical Data

Module ID	AM055
General	
C-UL-US Listed	YES
Insert in Main Rack Expansion Rack	YES YES
Static Characteristics	
Module Type	B&R 2005 I/O Module
Inputs Input Signal	5 0 - 10 V
Outputs Output Signal	3 ±10 V
Potentiometer Voltage	+10 V
Power Consumption	Max. 7 W
Operating Characteristics	
Isolation Voltage under Normal Conditions between Channel and Bus	±50 V
Analog Inputs	
Inputs Signal Nominal Min./Max. Allowed	0 to +10 V -20 to +20 V
Digital Converter Resolution	12 Bit
Input Impedance in Signal Range	2 MΩ
Analog Outputs	
Output Signal	±10 V
Digital Converter Resolution	12 Bit
Load Impedance	Min. 1 kΩ
Switch On/Off Behavior	Internal enable relay During boot-up or error: closed
Potentiometer Voltage	
Output Voltage	+10 V
Load	4 x 1 kΩ parallel, max. total of 40 mA
Short Circuit Current	>100 mA
Mechanical Characteristics	
Dimensions	B&R 2005 single width

Analog Mixed Module

AM374

Order Data

Model Number	Description	Figure
3AM374.6	2005 Analog mixed module, 4 inputs, 0-10 V / 0-20 mA, 12 bit, 4 outputs, +/- 10 V / 0-20 mA, 12 bit, Signals can be set in groups of two, Order terminal block separately!	
3TB170.9	2005 Terminal block, 20 pin screw clamp	
3TB170.91	2005 Terminal block, 20 pin cage clamp	
3TB170:90-02	2005 Terminal block, 20 pin, 20 pcs., screw clamp	
3TB170:91-02	2005 Terminal block, 20 pin, 20 pcs., cage clamp	

Technical Data

Module ID	AM374
General	
C-UL-US Listed	YES
Insert in Main Rack Expansion Rack	YES YES
Static Characteristics	
Module Type	B&R 2005 I/O Module
Inputs Input Signal Group 1 Group 2	4 0 - 10 V / 0 - 20 mA (can be switched in groups of 2) Channels 1 + 2 Channels 3 + 4
Outputs Output Signal Group 1 Group 2	4 ±10 V / 0 - 20 mA (can be switched in groups of 2) Channels 1 + 2 Channels 3 + 4
Power Consumption	Max. 6.5 W
Operating Characteristics	
Isolation Voltage under Normal Conditions between Channel and Bus	±50 V
Analog Inputs – Voltage	
Input Signal Nominal Min./Max. Allowed	0 to +10 V -20 to +20 V
Digital Converter Resolution	12 Bit
Input Impedance in Signal Range	2 MΩ
Analog Inputs – Current	
Input Signal Nominal Min./Max. Allowed	0 to 20 mA -50 to +50 mA
Digital Converter Resolution	12 Bit
Input Impedance in Signal Range	50 Ω
Analog Outputs – Voltage	
Output Signal	±10 V
Digital Converter Resolution	12 Bit

Module ID	AM374
Load Impedance	Min. 1 k Ω
Switch On/Off Behavior	Internal enable relay During boot-up or error: closed
Analog Outputs – Current	
Output Signal	0 - 20 mA
Digital Converter Resolution	12 Bit
Load Impedance	Max. 600 Ω
Switch On/Off Behavior	Internal enable relay During boot-up or error: closed
Mechanical Characteristics	
Dimensions	B&R 2005 einfachbreit

Temperature Modules

General Information

Analog input modules convert temperature measurements into number values, which can be processed by the PCC.

Number values are always in the 16 bit 2s complement in the PCC, regardless of the resolution. Therefore, the resolution of the temperature module used does not have to be taken into consideration when creating an application.

With temperature measurements, the temperature module returns the measurement value in steps of 0.1 °C. That means a result of 750 corresponds to 75.0 °C. The data format 0.1 °C is supported by all temperature modules by default. Some temperature modules can also be switched to other formats.

All temperature modules are provided with a status LED labeled „RUN“. This LED shows that the A/D conversion is taking place.

Overview

Module	AT350	AT450	AT660
Number of Channels	4	4	8
Measurement Range	-50 to +450 °C	-50 to +450 °C	-200 to +950 °C -200 to +1300 °C
Sensor	PT100 / 3 wire	PT100 / 4 wire	FeCuNi / Type J + L NiCrNi / Type K
Resolution	13500 steps	13500 steps	23841 steps

Temperature Modules

AT350 / AT450

Order Data

Model Number	Description	Figure
3AT350.6	2005 Analog input module, 4 inputs, PT100 (3-line connection), -50 to +450 degrees C, Order terminal block separately!	
3AT450.6	2005 Analog input module, 4 inputs, PT100 (4-line connection), -50 to +450 degrees C, Order terminal block separately!	
3TB170.9	2005 Terminal block, 20 pin screw clamp	
3TB170.91	2005 Terminal block, 20 pin cage clamp	
3TB170:90-02	2005 Terminal block, 20 pin, 20 pcs., screw clamp	
3TB170:91-02	2005 Terminal block, 20 pin, 20 pcs., cage clamp	

Technical Data

Module ID	AT350	AT450
General		
C-UL-US Listed	YES	
Insert in Main Rack Expansion Rack	YES YES	
Static Characteristics		
Module Type	B&R 2005 I/O Module	
Number of Inputs	4 inputs for resistance measurement	
Sensor Type Connection Standard	PT100 3 wire connection B IEC/EN 60751	PT100 4 wire connection IEC/EN 60751
Measurement Range	-50 to +450 °C	
Resolution	internal 13 500 steps	
Measurement Current	2.5 mA (±0.2 %)	
Power Consumption	Max. 4 W	
Operating Characteristics		
Isolation Input – PCC Input – Input	YES NO	
Mechanical Characteristics		
Dimensions	B&R 2005 single width	

Special Functions

Scanning Sequence

Modules AT350 and AT450 offer the possibility of setting the scanning sequence. Some channels can be scanned and converted more often than others in order to keep track of procedures with faster thermal changes (e.g. heating chamber).

Data Format

In addition to the 1/10 °C data format, the formats 1/10 °F and 1/100 °C are provided. These can be selected in the application software.

Temperature Module

AT660

Order Data

Model Number	Description	Figure
3AT660.6	2005 Analog input module, 8 inputs, sensor type L/J/K, -200 to +1300 degrees C, Order terminal block separately!	
3TB170.9	2005 Terminal block, 20 pin screw clamp	
3TB170.91	2005 Terminal block, 20 pin cage clamp	
3TB170:90-02	2005 Terminal block, 20 pin, 20 pcs., screw clamp	
3TB170:91-02	2005 Terminal block, 20 pin, 20 pcs., cage clamp	

Technical Data

Module ID	AT660		
General			
C-UL-US Listed	YES		
Insert in Main Rack Expansion Rack	YES YES		
Static Characteristics			
Module Type	B&R 2005 I/O Module		
Number of Inputs	8 differential inputs for thermo couple		
Input Groups Group 1 Group 2	2 groups Channels 1 - 4 Channels 5 - 8		
Input Signal Nominal Allowed	-15 to +55 mV -20 to +20 V		
Digital Converter Resolution	Internal >14 Bit ¹⁾		
Input Impedance in Signal Range	>1 MΩ		
Power Consumption	Max. 6 W		
Sensor			
Setting	Individually for each group		
Model	FeCuNi	FeCuNi	NiCrNi
Type	L	J	K
Standard	DIN 43710	DIN IEC 584	DIN IEC 584
Signal Range ²⁾	-8.15 to 53.14 mV	-7.89 to 54.95 mV	-5.891 to 52.398 mV
Measurement Range	-200.0 to +900.0 °C	-200.0 to +950.0 °C	-200.0 to +1300.0 °C
Step Size	0.1 °C		
Linearization	YES		
Compensation Internal External	-20 to +80 °C -100 to +200 °C (can be defined)		
Raw Value Measurement			
Scaling	Standardized to 2 μV ³⁾		
Measurement Voltage Range	-15 to +55 mV		

Module ID	AT660
Measurement Range	According to sensor type
Linearization	in CPU
Compensation Internal External	Can be read ---
Operating Characteristics	
Isolation Voltage under Normal Conditions between Channel and Bus	±50 V
Mechanical Characteristics	
Dimensions	B&R 2005 single width

¹⁾ The internal resolution is different depending on the measurement time, but the converter value is always scaled to 20 msec. This prevents a value from being changed when the measurement time is changed!

²⁾ Standardized to 0 °C compensation temperature.

³⁾ Voltage standardized to 2 µV starting with rev. xx.01.

Communication Modules

General Information

Module	Description
IF050	2005 Interface module, 1 RS232 interface, 1 RS485/RS422, network-capable, 1 RS232/TTY interface, All interfaces are electrically isolated
IF060	2005 Interface module, 1 insert slot for insertable interface modules
IF613	2005 Interface module, 3 RS232 interfaces, Insert for CPU and IF modules
IF621	2005 Interface module, 1 RS485/RS422 interface, 1 CAN interface, Both are isolated and network-capable, Insert for CPU and IF modules
IF622	2005 Interface module, 1 RS232 interface, 2 isolated RS485/RS422, RS485/RS422: network capable, Insert for CPU and IF modules
IF661	2005 Interface module, 1 RS485 interface, Electrically isolated, network-capable, Transfer protocol: PROFIBUS-DP, Insert for CPU and IF modules
IF671	2005 Interface module, 1 RS232 interface, 1 RS485/RS422 interface, Electrically isolated, network-capable, 1 CAN interface, Electrically isolated, network-capable, Insert for CPU and IF modules
IF672	2005 Interface module, 1 RS232 interface, 2 CAN interfaces, CAN: electrically isolated, network-capable, Insert for CPU and IF modules
IF681.95	2005 Interface module, 1 RS232 interface, 1 ETHERNET interface, with female, 10BASE2 CHEAPERNET BNC connector, Order TCP/IP library separately!
IF681.96	2005 Interface module, 1 RS232 interface, 1 ETHERNET interface, with female, 10BASE-T Twisted Pair RJ45 connector, Order TCP/IP library separately!
NW150	2005 PROFIBUS network module, Electrically isolated RS485 interface, For connecting to PROFIBUS networks

Communication Module

IF050

Order Data

Model Number	Description	Figure
	Interface Module	
3IF050.6	2005 Interface module, 1 RS232 interface, 1 RS485/RS422, network-capable, 1 RS232/TTY interface, All interfaces are electrically isolated	
	Accessories	
0G0001.00-090	Cable PC <-> PCC/PW, RS232, Online cable	
0G1000.00-090	Bus connector, RS485, PROFIBUS networks, remote I/O	
0AC916.9	Bus termination, RS485, active, For PROFIBUS networks, remote I/O, standard mounting rail, Supply voltage: 120 / 230 VAC	
Additional information concerning accessories can be found in sections "Accessories" and "Manuals".		

Technical Data

Module ID	IF050
General	
C-UL-US Listed	YES
Module Type	B&R 2005 system module, single width
Insert in Main Rack Expansion Rack	YES NO
Power Consumption	Max. 7 W
Processor	
Processor Type	RISC
Dual Ported RAM (DPR)	576 Byte
Standard Communication Interfaces	
Isolation Interface – PCC Interface – Interface	YES YES
Data Formats ¹⁾ Databits Parity Stopbits	5 to 8 Yes / No / Even / Odd 1 / 1.5 / 2
Application Interface IF1	
Type	RS232
Connection	9 pin D-type connector (M)
Input Filter / Protective Circuit	YES
Maximum Distance	15 m / 19200 Baud
Maximum Baudrate ¹⁾	64 kBaud
Handshake Lines	DCD, DTR, DSR, RTS, CTS, RI
Network Capable	NO
Application Interface IF2	
Type	RS232/TTY ¹⁾
Connection	9 pin D-type connector (M)
Input Filter / Protective Circuit	YES

Module ID	IF050
Maximum Distance RS232 TTY	15 m / 19200 Baud 300 m
Maximum Baudrate ¹⁾ RS232 TTY	64 kBaud 2.4 kBaud
Handshake Lines RS232 TTY	RTS, CTS ---
Network Capable	NO
Application Interface IF3	
Type	RS485/RS422 ¹⁾
Connection	9 pin D-type connector (F)
Input Filter / Protective Circuit	YES
Maximum Distance	1200 m (without repeater)
Maximum Baudrate ¹⁾	347 kBaud
Network Capable	YES
Bus Termination Resistance	External using T connector

¹⁾ Can be configured using software.

Communication Module

IF060

Order Data

Model Number	Description	Figure
3IF060.6	2005 Interface module, 1 insert slot for insertable interface modules	
The following insertable interface modules can be operated with the IF060:		
Model Number	Description	
3IF613.9	Three RS232 interfaces	
3IF621.9	One RS485/RS422 interface and one CAN interface	
3IF622.9	One RS232 interface and two RS485/RS422 interfaces	
3IF661.9	One RS485 interface (PROFIBUS DP Slave)	
3IF671.9	One RS232 interface, one RS485/RS422 interface and one CAN interface	
3IF672.9	One RS232 interface and two CAN interfaces	

Technical Data

Module ID	IF060
General	
C-UL-US Listed	YES
Module Type	B&R 2005 system module, single width
Insert in Main Rack Expansion Rack	YES NO
Insert Slot	1 (for interface module inserts)
Power Consumption	Max. 1 W

General Information

The interface module IF060 has an insert slot for interface modules.

Therefore, it is possible for every B&R System 2005 CPU to integrate different bus or network systems into a B&R 2005 system via the system bus.

The interface data must be prepared in the CPU. The IF060 module provides the physical connection to the insert modules.

Multiple IF060 interface modules can be inserted on the main base plate as required. The maximum number of IF060s used depends on the type of interface modules inserted, the baudrate used and the performance of the CPU.

Communication Module

IF613

Order Data

Model Number	Description	Figure
	Interface Module	
3IF613.9	2005 Interface module, 3 RS232 interfaces, insert for CPU and IF modules	
	Accessories	
0G0001.00-090	Cable PC <-> PCC/PW, RS232, Online cable	

Technical Data

Module ID	IF613	
General		
C-UL-US Listed	YES	
Slot	Insert in CP260, IF260, IF060	
Power Consumption	Max. 0.9 W	
Application Interface IF1, IF2 and IF3		
Type	RS232	
Controller	UART Typ ST16C654	
FIFO	64 Byte in send and receive direction	
Connection	9 pin D-type connector (M)	
Isolation	NO	
Input Filter / Protective Circuit	YES	
Maximum Distance	15 m / 19200 Baud	
Maximum Baudrate	115.2 kBaud	
Handshake Lines	IF1 DTR, DSR, RTS, CTS	IF2 und IF3 RTS, CTS
Network Capable	NO	
Data Format		
Databits	5 to 8	
Parity	Yes / No / Even / Odd	
Stopbits	1 / 2	

General Information

The IF613 interface module can be used in an interface module slot on the CP260 or on the IF260 / IF060.

The module is equipped with three RS232 interfaces and is used to connect several peripheral devices which cannot be networked (modem, printer, barcode reader, terminals, etc.).

Communication Module

IF621

Order Data

Model Number	Description	Figure
	Interface Module	
3IF621.9	2005 Interface module, 1 RS485/RS422 interface, 1 CAN interface, Both are isolated and network-capable, Insert for CPU and IF modules	
	Accessories	
0G1000.00-090	Bus connector, RS485, PROFIBUS networks, remote I/O	
0AC916.9	Bus termination, RS485, active, For PROFIBUS networks, remote I/O, standard mounting rail, Supply voltage: 120 / 230 VAC	
Additional information concerning accessories can be found in sections "Accessories" and "Manuals".		

Technical Data

Module ID	IF621
General	
C-UL-US Listed	YES
Slot	Insert in CP260, IF260, IF060
Power Consumption	Max. 1.5 W
Application Interface IF1	
Type	RS485/RS422
Controller	UART Typ ST16C650
FIFO	32 Byte in send and receive direction
Connection	9 pin D-type connector (F)
Isolation IF1 – RPS	YES
Isolation IF1 - IF2	YES
Input Filter / Protective Circuit	YES
Maximum Distance	1200 m
Maximum Baudrate	115.2 kBaud
Network Capable	YES
Bus Termination Resistance	External using T connector
Application Interface IF2	
Type	CAN
Controller	Controller 82527
Connection	4 pin pin-block
Isolation IF2 – RPS	YES
Isolation IF1 - IF2	YES
Maximum Distance	1000 m
Maximum Baudrate	
Bus Length 10 - 60 m	500 kBit/sec
Bus Length 100 - 200 m	250 kBit/sec
Bus Length 800 - 1000 m	50 kBit/sec
Network Capable	YES
Bus Termination Resistance	Optional – externally wired

General Information

The IF621 interface module can be used in an interface module slot on the CP260 or on the IF260 / IF060. The module is equipped with an RS485/RS422 interface and a CAN interface. The RS485/RS422 interface is used mostly for visualization and networking based on different protocols (e.g. NET2000).

Communication Module

IF622

Order Data

Model Number	Description	Figure
	Interface Module	
3IF622.9	2005 Interface module, 1 RS232 interface, 2 isolated RS485/RS422, RS485/RS422: network capable, insert for CPU and IF modules	
	Accessories	
0G0001.00-090	Cable PC <-> PCC/PW, RS232, online cable	
0AC916.9	Bus termination, RS485, active, for PROFIBUS networks, remote I/O, standard mounting rail, supply voltage: 120 / 230 VAC	
Additional information concerning accessories can be found in sections "Accessories" and "Manuals".		

Technical Data

Module ID	IF622
General	
C-UL-US Listed	in preparation
Slot	Insert in CP260, IF260, IF060
Power Consumption	TBD
Application Interface IF1	
Type	RS232
Controller	UART Typ ST16C654
FIFO	64 Byte in send and receive direction
Connection	9 pin D-type plug
Isolation	NO
Input Filter / Protective Circuit	YES
Maximum Distance	15 m / 19200 Baud
Maximum Baudrate	115.2 kBaud
Handshake Lines	DTR, DSR, RTS, CTS
Network Capable	NO
Data Formats Databits Parity Stopbits	5 to 8 Yes / No / Even / Odd 1 / 2
Application Interface IF2 and IF3	
Type	RS485/RS422
Controller	UART Typ ST16C654
FIFO	64 Byte in send and receive direction
Connection	9 pin D-type socket
Isolation	YES
Input Filter / Protective Circuit	YES
Maximum Distance	1200 m
Maximum Baudrate	115.2 kBaud
Network Capable	YES
Connection	Via active RS485 bus termination (model number 0AC916.9)
Bus Termination Resistor	External, integrated in active RS485 bus termination

General Information

The IF622 interface module can be used in an interface module slot on the CP260 or on the IF260 / IF060. The module is equipped with an RS232 interface and two RS485/RS422 interfaces.

Communication Module

IF661

Order Data

Model Number	Description	Figure
	Interface Module	
3IF661.9	2005 Interface module, 1 RS485 interface, Electrically isolated, network-capable, Transfer protocol: PROFIBUS DP, Insert for CPU and IF modules	
	Accessories	
0G1000.00-090	Bus connector, RS485, PROFIBUS networks, remote I/O	
0AC916.9	Bus termination, RS485, active, For PROFIBUS networks, remote I/O, standard mounting rail, Supply voltage: 120 / 230 VAC	
Additional information concerning accessories can be found in sections "Accessories" and "Manuals".		

Technical Data

Module ID	IF661
General	
C-UL-US Listed	YES
Slot	Insert in CP260, IF260, IF060
Power Consumption	Max. 2 W
Application Interface IF1	
Type	RS485
Controller	ASIC SPC3
RAM	1.5 KByte
Communication Protocol	PROFIBUS-DP
Connection	9 pin D-type connector (F)
Isolation	YES
Input Filter / Preprotective Circuit	YES
Maximum Distance	1000 m
Maximum Baudrate	
Bus Length <100 m	12 MBit/sec
Bus Length <200 m	1.5 MBit/sec
Bus Length <400 m	500 kBit/sec
Bus Length <1000 m	187.5 kBit/sec
Network Capable	YES
Bus Termination Resistance	External using T connector

General Information

The IF661 interface module can be used in an interface module slot on the CP260 or on the IF260 / IF060. The module is equipped with an electrically isolated RS485 interface. The PROFIBUS-DP Format is used as transfer protocol. Therefore, a B&R 2005 PCC can be connected as a slave in a PROFIBUS-DP network.

Communication Module

IF671

Order Data

Model Number	Description	Figure
	Interface Module	
3IF671.9	2005 Interface module, 1 RS232 interface, 1 RS485/RS422 interface, electrically isolated, network capable, 1 CAN interface, electrically isolated, network capable, Insert for CPU and IF modules	
	Accessories	
0G0001.00-090	Cable PC <-> PCC/PW, RS232, online cable	
0G1000.00-090	Bus connector, RS485, PROFIBUS networks, remote I/O	
0AC916.9	Bus termination, RS485, active, For PROFIBUS networks, remote I/O, standard mounting rail, Supply voltage: 120 / 230 VAC	
Additional information concerning accessories can be found in sections "Accessories" and "Manuals".		

Technical Data

Module ID	IF671
General	
C-UL-US Listed	YES
Slot	Insert in CP260, IF260, IF060
Power Consumption	Max. 2 W
Application Interface IF1	
Type	RS232
Controller	UART Typ ST16C650
FIFO	32 Byte in send and receive direction
Connection	9 pin D-type connector (M)
Isolation	NO
Input Filter / Protective Circuit	YES
Maximum Distance	15 m / 19200 Baud
Maximum Baudrate	115.2 kBaud
Handshake Lines	DTR, DSR, RTS, CTS
Network Capable	NO
Data Format	
Databits	5 to 8
Parity	YES / No / Even / Odd
Stopbits	1 / 2
Application Interface IF2	
Type	RS485/RS422
Controller	UART Typ ST16C650
FIFO	32 Byte in send and receive direction
Connection	9 pin D-type connector (F)
Isolation	
IF1 – RPS	YES
IF1 – IF2	YES
Input Filter / Protective Circuit	YES
Maximum Distance	1200 m
Maximum Baudrate	115.2 kBaud
Network Capable	YES
Bus Termination Resistance	External using T connector

Module ID	IF671
Application Interface IF3	
Type	CAN
Controller	Controller 82527
Connection	4 pin pin-block
Isolation	YES
Maximum Distance	1000 m
Maximum Baudrate Bus Length 10 - 60 m Bus Length 100 - 200 m Bus Length 800 - 1000 m	500 kBit/sec 250 kBit/sec 50 kBit/sec
Network Capable	YES
Bus Termination Resistance	Optinal- wired externally
CAN Node Number	Set using software

General Information

The IF671 interface module can be used in an interface module slot on the CP260 or on the IF260 / IF060.

The module is equipped with an RS232 interface, an RS485/RS422 interface and a CAN interface.

Communication Module

IF672

Order Data

Model Number	Description	Figure
	Interface Module	
3IF672.9	2005 Interface module, 1 RS232 interface, 2 CAN interfaces, CAN: electrically isolated, network capable, Insert for CPU and IF modules	
	Accessories	
0G0001.00-090	Cable PC <-> PCC/PW, RS232, online cable	
Additional information concerning accessories can be found in sections "Accessories" and "Manuals".		

Technical Data

Module ID	IF672
General	
C-UL-US Listed	YES
Slot	Insert in CP260, IF260, IF060
Power Consumption	Max. 1.8 W
Application Interface IF1	
Type	RS232
Controller	UART Typ ST16C650
FIFO	32 Byte in send and receive direction
Connection	9 pin D-type connector (M)
Isolation	NO
Input Filter / Protective Circuit	YES
Maximum Distance	15 m / 19200 Baud
Maximum Baudrate	115.2 kBaud
Handshake Lines	DTR, DSR, RTS, CTS
Network Capable	NO
Data Format	
Databits	5 to 8
Parity	Yes / No / Even / Odd
Stopbits	1 / 2
Application Interface IF2 and IF3	
Type	CAN
Controller	Controller 82527
FIFO	32 Byte in Sende- und Empfangsrichtung
Connection	2 x 4 pin pin-block
Isolation to PCC	YES
Between Interfaces	YES
Input Filter / Protective Circuit	YES
Maximum Distance	1000 m
Maximum Baudrate	
Bus Length 10 - 60 m	500 kBit/sec
Bus Length 100 - 200 m	250 kBit/sec
Bus Length 800 - 1000 m	50 kBit/sec
Network Capable	YES
Bus Termination Resistance	Optional – wired externally

General Information

The IF672 interface module can be used in an interface module slot on the CP260 or on the IF260 / IF060. The module is equipped with an RS232 interface and two CAN interfaces.

Communication Module

IF681.95

Order Data

Model Number	Description	Figure
	Interface Module	
3IF681.95	2005 Interface module, 1 RS232 interface, 1 ETHERNET interface, with female, 10BASE2 CHEAPERNET BNC connector, Order TCP/IP library separately!	
	Accessories	
0G0001.00-090	Cable PC <-> PCC/PW, RS232, online cable	
	Software	
1A2205.01	B&R SYSTEM 2000 Standard Software, TCP/IP Library	

Technical Data

Module ID	IF681.95
General	
C-UL-US Listed	YES
Slot	Insert in CP260, IF260
Power Consumption	Max. 2.4 W
Application Interface IF1	
Type	RS232
Controller	UART Typ ST16C650
FIFO	32 Byte in send and receive direction
Connection	9 pin D-type connector (M)
Isolation	NO
Input Filter / Protective Circuit	YES
Maximum Distance	15 m / 19200 Baud
Maximum Baudrate	115.2 kBaud
Handshake Lines	DTR, DSR, RTS, CTS
Network Capable	NO
Data Format	
Databits	5 to 8
Parity	Yes / No / Even / Odd
Stopbits	1 / 2
Application Interface IF2	
Type	ETHERNET
Controller	Controller AM79C960
Send and Receive Buffer	128 KByte
Connection	10BASE2: CHEAPERNET BNC Socket
Isolation	YES
Maximum Baudrate	10 MBit/sec
Bus Capable	YES

General Information

The IF681.95 interface module can be used in an interface module slot on the CP260 or on the IF260. The module is equipped with an RS232 interface and an ETHERNET interface. The ETHERNET connection is made using a 10BASE2 CHEAPERNET BNC socket.

Communication Module

IF681.96

Order Data

Model Number	Description	Figure
	Interface Module	
3IF681.96	2005 Interface module, 1 RS232 interface, 1 ETHERNET interface, with female, 10BASE-T Twisted Pair RJ45 connector, Order TCP/IP library separately!	
	Accessories	
0G0001.00-090	Cable PC <-> PCC/PW, RS232, online cable	
	Software	
1A2205.01	B&R SYSTEM 2000 Standard software, TCP/IP Library	

Technical Data

Module ID	IF681.96
General	
C-UL-US Listed	YES
Slot	Insert in CP260, IF260
Power Consumption	Max. 1.65 W
Application Interface IF1	
Type	RS232
Controller	UART Typ ST16C650
FIFO	32 Byte in send and receive direction
Connection	9 pin D-type connector (M)
Isolation	NO
Input Filter / Protective Circuit	YES
Maximum Distance	15 m / 19200 Baud
Maximum Baudrate	115.2 kBaud
Handshake Lines	DTR, DSR, RTS, CTS
Network Capable	NO
Data Format Databits Parity Stopbits	5 to 8 Yes / No / Even / Odd 1 / 2
Application Interface IF2	
Type	ETHERNET
Controller	Controller AM79C960
Send and Receive Buffer	128 KByte
Connection	10BASE-T: Twisted Pair RJ45 Socket
Isolation	YES
Maximum Baudrate	10 MBit/sec
Bus Capable	YES

General Information

The IF681.96 interface module can be used in an interface module slot on the CP260 or on the IF260. The module is equipped with an RS232 interface and an ETHERNET interface. The ETHERNET connection is made with a 10BASE-T Twisted Pair RJ45 socket.

Communication Module

NW150

Order Data

Model Number	Description	Figure
	PROFIBUS Network Module	
3NW150.60-1	2005 PROFIBUS network module, Electrically isolated RS485 interface, For connecting to PROFIBUS networks	
	Accessories	
0G1000.00-090	Bus connector, RS485, PROFIBUS networks, remote I/O	
0AC916.9	Bus termination, RS485, active, For PROFIBUS networks, remote I/O, standard mounting rail, Supply voltage: 120 / 230 VAC	
Additional information concerning accessories can be found in sections "Accessories" and "Manuals".		

Technical Data

Module ID	NW150
General	
C-UL-US Listed	YES
Module Type	B&R 2005 system module, single width
Insert in Main Rack Expansion Rack	YES NO
Power Consumption	Max. 7 W
Peripherals	
Diagnosis LEDs	YES
Number Switches	Two to set the station address and one to set the baudrate
Standard Communication Interface	
Interface Type Connection Isolation Baudrates 9.6 kBit/sec 19.2 kBit/sec 93.75 kBit/sec 187.5 kBit/sec 500 kBit/sec	RS485 9 pin D-type connector (F) YES Depending on the distance Max. 1200 m Max. 1200 m Max. 1200 m Max. 1000 m Max. 400 m
PROFIBUS Data Transfer Protocol Access Number of Stations Topology Coupling to Bus Transfer Medium	PROFIBUS Standard, DIN 19245 Part 1 and 2 Token passing principle with underlying Master/Slave principle Max. 127 (with repeater) Physical Bus Direct Shielded, twisted pair

Counter and Positioning Modules

General Information

Module	Description
NC150	2005 Counter module, 2 Inputs for incremental encoder, 32 Bit, Input frequency 100 kHz, Encoder supply 5 to 30 VDC, 2 analog outputs +/- 10 V, 12 Bit, Order 8 pin terminal block separately!
NC154	2005 Positioning module, 3 axes, Each axis has the following data: Input for incremental Encoder 5 V, Input frequency 150 kHz, Input for SSI absolute encoder, Analog output +/- 10 V, 12 Bit, Encoder supply 5 VDC or 24 VDC, 4 digital inputs 24 VDC, sink, Trigger input 24 VDC, sink, 1 relay outputs 24 VAC / 24 VDC, 1 A, Order 12 pin terminal block separately!

Counter and Positioning Module

NC150

Order Data

Model Number	Description	Figure
3NC150.6	2005 Counter module, 2 Inputs for incremental encoder, 32 Bit, Input frequency 100 kHz, Encoder supply 5 to 30 VDC, 2 analog outputs +/- 10 V, 12 Bit, Order 8 pin terminal block separately!	
Additional information concerning accessories can be found in sections "Accessories" and "Manuals".		

Technical Data

Module ID	NC150
General	
C-UL-US Listed	YES
Module Type	B&R 2005 I/O module
Insert in	
Main Rack	YES
Expansion Rack	YES
Status Display	LEDs
Power Consumption	Max. 5 W
Encoder 1 and 2	
Signal Encoder Connections	Two 9 pin D-type connectors (F)
Encoder Inputs	Symmetric and asymmetric
Isolation	
Input – PCC	YES
Input – Input	NO
Encoder Supply	5 to 30 V external
Module Requirements	Typ. 40 mA at 5 V / 120 mA at 30 V
Input Filter	2 times set using software
Input Frequency	
Short Filter Time	Max. 100 kHz
Long Filter Time	Max. 20 kHz
Counter Frequency at 4-fold Evaluation	Max. 400 kHz
Phase Shift between Counter Channels A and B	90° ±45°
Counter	
Amount	2
Size	32 Bit
Types of Operation ¹⁾	Incremental (4-fold, 2- and 1-fold evaluation) Up / Down Counter
Analog Outputs	
Number of Outputs	2
Output Voltage	-10 V to +10 V
Digital Converter Resolution	12 Bit
Max. Load per Output	±10 mA (load ≥1 kΩ)
Isolation	
Output – PCC	YES
Output – Output	NO
Counter Channels – Analog Outputs	YES
Mechanical Characteristics	
Dimensions	B&R 2005 single width

¹⁾ Set using software.

General Information

The counter module NC150 is intended for externally supplied incremental encoders. The supply voltage is fed into two terminal blocks. It is then directly connected internally to the 9 pin D type connectors (F) of both encoders. The encoder is supplied via two pins on the female D type connector.

Two analog outputs (± 10 V, 12 bit resolution) are also provided for servo controllers.

Signal Encoder

The following encoders, as well as others, can be connected to the NC 150 counter module:

- 5 V - Encoder with Differential Outputs (symmetrical encoder)
- Asymmetrical Encoder with Transistor Outputs
- Symmetrical Encoder with Transistor Outputs
- Encoder with Open Collector Outputs
(When using these encoder types, the external pull up resistance must be turned on, see input circuit)

Counter and Positioning Module

NC154

Order Data

Model Number	Description	Figure
	Axis Controller	
3NC154.60-2	2005 Positioning module, 3 axes, Each axis has the following data: Input for incremental Encoder 5 V, Input frequency 150 kHz, Input for SSI absolute encoder, Analog output +/- 10 V, 12 Bit, Encoder supply 5 VDC or 24 VDC, 4 digital inputs 24 VDC, sink, Trigger input 24 VDC, sink, 1 relay outputs 24 VAC / 24 VDC, 1 A, Order 12 pin terminal block separately!	
3TB162.9	2005 Terminal block, 12 pin, screw clamp	
	Software	
1A3502.01	NC154.60-2 Operating System, Standard	
Additional information concerning accessories can be found in sections "Accessories" and "Manuals".		

Technical Data

Module ID	NC154
General	
C-UL-US Listed	YES
Module Type	B&R 2005 system module, double width
Insert in Main Rack Expansion Rack	YES NO
Working Memory	2 MByte DRAM
System PROM	2 MByte FlashPROM
NC154 Axis Coupling over Multiple Modules is Supported by	CP152.90-2, CP260, IF260
Status Display	LEDs
Number of Axis	3
Power Consumption	Max. 6 W
Umgebungstemperatur im Betrieb	0 to 55 °C
Encoder Input – Entries are Valid for Each of the three Axes	
General Information	15 pin D-type connectors (F), Incremental or SSI absolute encoder (both electrically isolated)
Incremental Encoder Signal Form Evaluation Input Frequency Counter Frequency Counter Size Inputs Input Level Time between Edges Monitoring	Square wave pulse 4-fold Max. 150 kHz Max. 600 kHz 32 Bit A, A _I , B, B _I , R, R _I 5 V (differential input) At least 0.8 µsec Open Circuit, signal disturbance
SSI Absolute Encoder Coding Word Size Baudrate Data Input Level Clock Output Level Monitoring	Gray, Binary Max. 31 Bit 230 kBaud 5 V (differential signal) 5 V (differential signal) Signal disturbance, parity, plausibility

Module ID	NC154
Encoder Supply Ext. Input Voltage Load at Output Level 5 VDC 24 VDC Protection	24 VDC Max. 400 mA per axis Max. 250 mA per axis Short circuit and overload
Servo Output – Entries are Valid for Each of the three Axes	
Output Voltage Capacity Resolution Output Filter Methodes to reduce Disturbance	±10 V, electrically isolated 5 mA 12 Bit Low pass 1 st order Disturbance compensation
Digital Inputs – Entries are Valid for Each of the three Axes	
Number of Inputs Isolation Input Voltage Input Current	5 YES (optocoupler) 24 VDC Approx. 10 mA
Digital Output – Entries are Valid for Each of the three Axes	
Type Switching Voltage Switching Current Short Circuit Protection	Relay 30 V Max. 1 A Soldered fuse 1.5 A

General Information

The axis controller NC154 is an active axis module, which includes all functions for operating three servo axes:

- Encoder Input
- Servo Output (±10 V, 12 bits)
- Closed Loop Position Controller (digital sampling controller)
- End and Reference Switch Inputs
- Input „Controller Ready“
- Output „Release Controller“

In addition, three fast trigger inputs are provided to latch the actual position for measuring purposes.

Positioning Software

The software for axis control is found in the axis controller FlashPROM. Software can be uploaded and downloaded. Therefore, an update of the positioning software can be made, if required.

Closed Loop Controller

The NC154 positioning module contains a lag free predicable **PI Closed Loop Controller**. This algorithm guarantees excellent path precision and stability.

Positioning Types

The user has a choice between several types of positioning:

- **Online Positioning**
Changing the state of a movement (position, speed and acceleration) is possible at any sampling instant.
- **Electronic Gears**
One or more gear axes have a certain relationship to a reference axis. The gear ratio and the angles of the gear axes to each other can be changed during a movement. The gear relationship or the coupling of the axes to each other (turning gear axes on and off) is possible in the stopped state.
- **Electronic Cam Profile**
The realization of a non-linear connection between two drives (coupling functions) can be carried out simply. Several cam profiles can exist at the same time and be switched when needed with the NC154. Also turning on and off synchronization to a reference axis that is not in the stopped state is possible. All limiting values are to be taken into consideration (speed, acceleration).

Additional applications:

- **Flying Saw**
 - Time-optimized movement
 - Immediate return after cut has finished
- **Cross Cutter**
 - Optimized movement
 - Print mark control
- **Interpolation**
 - Extensive NC interpreter
 - Linear, circular and helix interpolation with tangential axis
 - Dynamic „Look Ahead“
 - Gantry Axes
 - Real time action using virtual axes
- **Axis Synchronization**
 - Real time positioning
 - Multiple synchronization conditions
- **Virtual Axes**
 - Virtual master
 - Real time action when running (to superimpose real axes)
- **Remote Axes**
 - Distributed axis controller according to machine function
 - Connection via field bus

CNC Functions

Languages: The user is not only provided with the standard DIN 66025 syntax, but also very useful language expansions. Therefore, statements such as IF, ELSE, WHILE, SWITCH or arithmetic and trigonometric instructions (e.g. +, *, /, sin, cos, arctan) can be used. Up to 1000 R parameters are available as variables.

Interpolation: Straight, circular (helix) with tangential axes, level tool radian correction.

In order to avoid exceeding axes' limit values, a „look ahead“ function is implemented.

Object Oriented Axis Programming

Using new object oriented axis programming, tasks can be handled quickly and more than once. Thoroughly tested, high performance tools are used for this purpose.

The success of this new principle has been shown by applications in the main areas of automation technology.

NC154 Axis Coupling over Multiple Modules

When coupling axes over multiple modules (gears, cams, CNC), the set positions of the master axis are sent to the NC154 modules with the slave axes in an interrupt routine on the main CPU. The interrupt routine is not allowed to be interrupted. These requirements are fulfilled by the following CPUs:

- CP152.90-2
- CP260
- IF260 when it is used as a main CPU

Synchronization

If more than one NC154 axes controller is used in a system, the sampling instant can be synchronized by connecting the „Sync“ connections. This guarantees high precision even when coupling gears between different NC154 modules.

Accessories

General Information

Model Number	Description
0AC100.9	NiCd Batteries, 5 pieces, 3.6 V / 40 mAh
0AC240.9	2005 Battery module
0G2001.00-090	Cable PC <-> NC154, RS232, NC154 Operating System Download
3BM150.9	2005 Dummy module
3TB162.9	2005 Terminal block, 12 pin, screw clamp
3TB170.9	2005 Terminal block, 20 pin, screw clamp
3TB170.91	2005 Terminal block, 20 pin, cage clamp
3TB170:90-02	2005 Terminal block, 20 pin, 20 pcs., screw clamp
3TB170:91-02	2005 Terminal block, 20 pin, 20 pcs., cage clamp

Accessories

NiCd Battery

Order Data

Model Number	Description
0AC100.9	NiCd Batteries, 5 pieces, 3.6 V / 40 mAh

General Information

The CPUs CP152 and CP153 are equipped with a NiCd rechargeable battery. The battery is used to buffer data and the real time clock.

Accessories

AC240

Order Data

Model Number	Description	Figure
0AC240.9	2005 Battery module	

Technical Data

Module ID	AC240
General	
C-UL-US Listed	YES
Slot	On own base plate module (included in delivery)
Battery	9 V block cell
Battery Compartments	2
Connection Cable Length Connector	40 cm 5 pin terminal block, pro-wired
Buffer Duration with 2 Alkaline „Extra Longlife“ Batteries	see technical data for the processor module used
Mechanical Characteristics	
Dimensions	B&R 2005 single width

General Information

The battery module is used for central data buffering on the 2005 PCC (e.g. data and real time clock for the XP152). It is equipped with two battery compartments for 9V block cells.

Connection to the power supply module is made with a 40 cm long cable. The cable is connected to a 5 pin terminal block. Two 5 pin terminal blocks are included in delivery. The two together replace the 10 pin terminal block on the power supply.

A base plate module (single width) is delivered with the battery module. The base plate module is to be installed to the left of the main base plate. The battery module is inserted on this base plate module and is therefore installed to the left of the power supply.

If a slot is free on the main base plate next to the power supply, the AC240 module can also be inserted there.

Accessories

Cable NC154 - PC

Order Data

Model Number	Description
0G2001.00-090	Cable PC <-> NC154, RS232, NC154 Operating System Download

General Information

For NC154 modules with a rev. < 54.23, the software module BOOT has to be installed in the module before the operating system update.

This cable is used to connect a PC to the NC154 module. The software module BOOT (NC154.S1) can be downloaded using this connection.

Accessories

BM150

Order Data

Model Number	Description	Figure
3BM150.9	2005 Dummy module	

General Information

Dummy modules are used to fill slots which are not being used.

We recommend that all slots which are not being used are always filled with a dummy module.

Accessories

TB162

Order Data

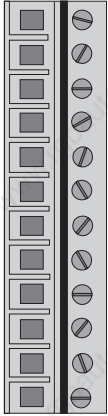
Model Number	Description	Figure
3TB162.9	2005 Terminal block, 12 pin, screw clamp	
<p>The NC154 module is equipped with three 12 pin terminal blocks. The terminal block TB162 is used for the connection. The terminal block can be removed using an ejection lever on the module.</p>		

Technical Data

Module ID	TB162
Number of Pins	12
Type of Terminals	Screw clamps
Distance between Contacts	5.08 mm
Contact Resistance	6 mΩ
Nominal Voltage	250 V
Current Load	Max. 12 A / contact
Wire Cross Section	0.14 mm ² (AWG26) – 2.5 mm ² (AWG12)
Type of Cable	Only copper wires (no aluminum wires!)
Removal	Mechanical
Stress Relief	Cable tie on the module

Accessories

TB170

Order Data

Model Number	Description	Figure
3TB170.9	2005 Terminal block, 20 pin, screw clamp	
3TB170.91	2005 Terminal block, 20 pin, cage clamp	
3TB170:90-02	2005 Terminal block, 20 pin, 20 pcs., screw clamp	
3TB170:91-02	2005 Terminal block, 20 pin, 20 pcs., cage clamp	
<p>Most modules are connected using this single row 20 pin terminal block. This terminal block is compact and easy to remove (two ejection levers on the module).</p>		

Technical Data

Module ID	TB170
Number of Pins	20
Type of Terminals	Screw or cage clamps
Distance between Contacts	5.08 mm
Contact Resistance	6 mΩ
Nominal Voltage	250 V
Current Load ¹⁾	Max. 12 A / contact
Wire Cross Section	0.14 mm ² (AWG26) – 2.5 mm ² (AWG12)
Type of Cable	Only copper wires (no aluminum wires!)
Removal	Mechanical
Stress Relief	Cable tie on the module

¹⁾ The respective limit data for I/O modules must be taken into consideration!

Manuals

Overview

Model Number	Description
MASYS22005-0	B&R 2005 User's Manual, German
MASYS22005-E	B&R 2005 User's Manual, English

B&R SYSTEM 2010

Module Overview

Column "Power" contains a power value provided by the module or required by the module. This can be used to quickly and easily create a power balance for a certain hardware configuration.

The power supplied by the PS modules is labeled with '+'. The power required by the other modules is labeled with '-'.¹⁾

In order to create a power balance, add the power values together taking the sign into consideration. The sum is not allowed to be less than zero.

Sorted Alphabetically according to Module ID

Module ID	Description	Module Type	Power	Model No.	Page
AI300	16 Voltage Inputs, ±10 V, Resolution 12 Bit	I/O	-9 W	2AI300.6	247
AI700	16 Current Inputs, ±20 mA, Resolution 12 Bit	I/O	-9 W	2AI700.6	247
AI730	8 Single Channel Isolation Current Inputs, 0 - 25 mA, Resolution 16 Bit	I/O	-6 W ¹⁾	2AI730.6	248
AO300	16 Voltage Outputs, ±10 V, Resolution 12 Bit	I/O	-10 W	2AO300.6	250
AO725	8 Current Outputs, 0 - 20 mA, Resolution 12 Bit	I/O	-10 W	2AO725.6	250
AO900	8 Voltage Outputs, ±10 V, 8 Current Outputs, 0 - 20 mA, Resolution 12 Bit	I/O	-12 W	2AO900.6	250
AT300	8 Inputs for PT100 Sensor (3 wire)	I/O	-9 W	2AT300.6	252
AT610	16 Inputs for FeCuNi Sensor (L + J), NiCrNi Sensor (K), Raw Value Measurement	I/O	-8 W	2AT610.6	253
BM100	Dummy Module	System, I/O		2BM100.9	267
BP101	2 Slots for System Bus			2BP101.3	214
BP110	4 Slots for System Bus, incl. Bus Termination			2BP110.3	214
BP200	1 Slot for I/O Bus			2BP200.4	214
BP201	4 Slots for I/O Bus			2BP201.4	214
BP202	1 Slot for Expansion or Remote Slave; I/O Bus			2BP202.4	214
BP210	1 Slot for I/O Bus, incl. Bus Termination			2BP210.4	214
BP300	2 Slots for CPU, System and I/O Bus, incl. Bus Termination			2BP300.4	214
CP100	CPU, 128 KByte DPR, 256 KByte System RAM		-10 W	2CP100.60-1	223
CP104	CPU, 128 KByte DPR, 256 KByte System RAM, CAN Bus Interface		-10 W	2CP104.60-1	223
CP200	CPU, 128 KByte DPR, 2 MByte System RAM, CAN Bus Interface		-20 W	2CP200.60-1	223
CP210	CPU, 128 KByte DPR, 6 MByte System RAM, CAN Bus Interface, MMU, FPU		-22.5 W	2CP210.60-1	223
DI400	32 Digital Inputs, 24 VDC, 10 msec Switching Delay, 8 Interrupt Capable Inputs	I/O	-6 W	2DI400.6	236
DI425	32 Digital Inputs, 24 VDC, 10 msec Switching Delay	I/O	-6 W	2DI425.6	238
DI426	32 Digital Inputs, 24 VDC, 1 msec Switching Delay	I/O	-6 W	2DI426.6	238
DI725	32 Digital Inputs, 120 / 230 VAC, 50 msec Switching Delay	I/O	-4 W	2DI725.6	239
DI825	8 Namur Inputs, Ex (I), 12 V, 12 mA, 100 µs Switching Delay	I/O	-11 W	2DI825.6	240

Module ID	Description	Module Type	Power	Model No.	Page
DO428	32 Transistor Outputs, 24 VDC, 0.5 A	I/O	-5 W	2DO428.6	243
DO430	32 Transistor Outputs, 24 VDC, 2 A	I/O	-2.9 W	2DO430.6	243
DO600	32 Relay Outputs, 120 VAC / 24 VDC, 2 A	I/O	-8 W	2DO600.6	244
DO700	16 Relay Outputs, 230 VAC / 24 VDC, 3 A	I/O	-6 W	2DO700.6	244
DO710	8 Change-over and 8 N.O. Outputs, 240 VAC / 30 VDC, 4 A	I/O	-7 W	2DO710.6	245
DS100	Intelligent I/O Processor, Drum Sequencer	I/O	-9 W ²⁾ -k x P _{Enc}	2DS100.60-1	226
DS101	Intelligent I/O Processor, Drum Sequencer with 32 Transistor Outputs	I/O	-13 W ³⁾ -k x P _{Enc}	2DS101.60-1	228
EX100	Remote I/O Master	System	-12 W	2EX100.50-1	220
EX200	Remote I/O Slave	I/O	-12 W	2EX200.50-1	220
EX301	Expansion Slave	I/O	-3 W	2EX301.5	221
EX302	Expansion Master	I/O	-3 W	2EX302.5	221
IF100	Interface Module, 1 x RS232, 1 x RS232/TTY, 1 x RS485/RS422, 1 x CAN	System	-7 W	2IF100.60-1	259
IF101	Interface Module, 1 x RS232, 1 x RS232/TTY, 1 x RS485/RS422, 1 x CAN, 1 x ETHERNET	System	-7 W	2IF101.60-1	259
ME910	Application Memory (PCC Software), 64 KByte SRAM, 256 KByte FlashPROM			2ME910.90-1	233
ME913	Application Memory (PCC Software), 512 KByte SRAM, 1 MByte FlashPROM			2ME913.90-1	233
ME915	Application Memory (PCC Software), 2 MByte SRAM, 2 MByte FlashPROM			2ME915.90-1	233
MP100	Multiprocessor, 64 KByte DPR, 256 KByte System RAM	System	-12 W	2MP100.5	230
NC303	Intelligent I/O Processor, Path Processor for Ultrasonic Transducer	I/O	-21 W -1.5 x P _{Enc}	2NC303.60-1	263
NW100	PROFIBUS Network Module	System	-15 W	2NW100.50-1	261
PS425	Power Supply, 24 VDC, 100 W	I/O	+100 W	2PS425.9	217
PS740	Power Supply, 100 - 240 VAC, 100 W	I/O	+100 W	2PS740.9	218
TB120	Terminal Block, 20 pin Screw Clamp			2TB120.9	268
TB140	Terminal Block, 40 pin Screw Clamp			2TB140.9	268
UM900	8 Digital Inputs, 24 VDC, 1 msec Switching Delay, 8 Digital Outputs, 24 VDC, 0.5 A, 4 Analog Inputs, ±10 V / 0 - 20 mA, Resolution 12 Bit, 2 Analog Outputs, ±10 V (Resolution 12 Bit), 0 - 20 mA (Resolution 11 Bit)	I/O	-8 W	2UM900.6	256

¹⁾ One watt is to be subtracted for each internally supplied encoder.

²⁾ The power consumption depends on the encoder supply used.
24 V Encoder Supply Voltage: $9\text{ W} + 1.5 \times \text{Encoder Power}$
4.6 V Encoder Supply Voltage: $9\text{ W} + 2.5 \times \text{Encoder Power}$

³⁾ The power consumption depends on the encoder supply used.
24 V Encoder Supply Voltage: $13\text{ W} + 1.5 \times \text{Encoder Power}$
4.6 V Encoder Supply Voltage: $13\text{ W} + 2.5 \times \text{Encoder Power}$

Sorted according to Group

Module ID	Description	Module Type	Power	Model No.	Page
Module Rack					
BP101	2 Slots for System Bus			2BP101.3	214
BP110	4 Slots for System Bus, incl. Bus Termination			2BP110.3	214
BP200	1 Slot for I/O Bus			2BP200.4	214
BP201	4 Slots for I/O Bus			2BP201.4	214
BP202	1 Slot for Expansion or Remote Slave; I/O Bus			2BP202.4	214
BP210	1 Slot for I/O Bus, incl. Bus Termination			2BP210.4	214
BP300	2 Slots for CPU, System and I/O Bus, incl. Bus Termination			2BP300.4	214
Power Supply Modules					
PS425	Power Supply, 24 VDC, 100 W	I/O	+100 W	2PS425.9	217
PS740	Power Supply, 100 - 240 VAC, 100 W	I/O	+100 W	2PS740.9	218
Bus Controller Modules					
EX100	Remote I/O Master	System	-12 W	2EX100.50-1	220
EX200	Remote I/O Slave	I/O	-12 W	2EX200.50-1	220
EX301	Expansion Slave	I/O	-3 W	2EX301.5	221
EX302	Expansion Master	I/O	-3 W	2EX302.5	221
CPUs					
CP100	CPU, 128 KByte DPR, 256 KByte System RAM		-10 W	2CP100.60-1	223
CP104	CPU, 128 KByte DPR, 256 KByte System RAM, CAN Bus Interface		-10 W	2CP104.60-1	223
CP200	CPU, 128 KByte DPR, 2 MByte System RAM, CAN Bus Interface		-20 W	2CP200.60-1	223
CP210	CPU, 128 KByte DPR, 6 MByte System RAM, CAN Bus Interface, MMU, FPU		-22.5 W	2CP210.60-1	223
Programmable Modules					
DS100	Intelligent I/O Processor, Drum Sequencer	I/O	-9 W ²⁾ -k x P _{Enc}	2DS100.60-1	226
DS101	Intelligent I/O Processor, Drum Sequencer with 32 Transistor Outputs	I/O	-13 W ³⁾ -k x P _{Enc}	2DS101.60-1	228
MP100	Multiprocessor, 64 KByte DPR, 256 KByte System RAM	System	-12 W	2MP100.5	230
Application Memory Modules					
ME910	Application Memory (PCC Software), 64 KByte SRAM, 256 KByte FlashPROM			2ME910.90-1	233
ME913	Application Memory (PCC Software), 512 KByte SRAM, 1 MByte FlashPROM			2ME913.90-1	233
ME915	Application Memory (PCC Software), 2 MByte SRAM, 2 MByte FlashPROM			2ME915.90-1	233
Digital Input Modules					
DI400	32 Digital Inputs, 24 VDC, 10 msec Switching Delay, 8 Interrupt Capable Inputs	I/O	-6 W	2DI400.6	236
DI425	32 Digital Inputs, 24 VDC, 10 msec Switching Delay	I/O	-6 W	2DI425.6	238
DI426	32 Digital Inputs, 24 VDC, 1 msec Switching Delay	I/O	-6 W	2DI426.6	238
DI725	32 Digital Inputs, 120 / 230 VAC, 50 msec Switching Delay	I/O	-4 W	2DI725.6	239
DI825	8 Namur Inputs, Ex (i), 12 V, 12 mA, 100 µsec Switching Delay	I/O	-11 W	2DI825.6	240
Digital Output Modules					
DO428	32 Transistor Outputs, 24 VDC, 0.5 A	I/O	-5 W	2DO428.6	243
DO430	32 Transistor Outputs, 24 VDC, 2 A	I/O	-2.9 W	2DO430.6	243
DO600	32 Relay Outputs, 120 VAC / 24 VDC, 2 A	I/O	-8 W	2DO600.6	244
DO700	16 Relay Outputs, 230 VAC / 24 VDC, 3 A	I/O	-6 W	2DO700.6	244
DO710	8 Change-over and 8 N.O. Outputs, 240 VAC / 30 VDC, 4 A	I/O	-7 W	2DO710.6	245

Module ID	Description	Module Type	Power	Model No.	Page
Analog Input Modules					
AI300	16 Voltage Inputs, ± 10 V, Resolution 12 Bit	I/O	-9 W	2AI300.6	247
AI700	16 Current Inputs, ± 20 mA, Resolution 12 Bit	I/O	-9 W	2AI700.6	247
AI730	8 Single Channel Isolation Current Inputs, 0 - 25 mA, Resolution 16 Bit	I/O	-6 W ¹⁾	2AI730.6	248
Analog Output Modules					
AO300	16 Voltage Outputs, ± 10 V, Resolution 12 Bit	I/O	-10 W	2AO300.6	250
AO725	8 Current Outputs, 0 - 20 mA, Resolution 12 Bit	I/O	-10 W	2AO725.6	250
AO900	8 Voltage Outputs, ± 10 V, 8 Current Outputs, 0 - 20 mA, Resolution 12 Bit	I/O	-12 W	2AO900.6	250
Temperature Modules					
AT300	8 Inputs for PT100 Sensor (3 wire)	I/O	-9 W	2AT300.6	252
AT610	16 Inputs for FeCuNi Sensor (L + J), NiCrNi Sensor (K), Raw Value Measurement	I/O	-8 W	2AT610.6	253
Other Modules					
UM900	8 Digital Inputs, 24 VDC, 1 msec Switching Delay, 8 Digital Outputs, 24 VDC, 0.5 A, 4 Analog Inputs, ± 10 V / 0 - 20 mA, Resolution 12 Bit, 2 Analog Outputs, ± 10 V (Resolution 12 Bit), 0 - 20 mA (Resolution 11 Bit)	I/O	-8 W	2UM900.6	256
Communication Modules					
IF100	Interface Module, 1 x RS232, 1 x RS232/TTY, 1 x RS485/RS422, 1 x CAN	System	-7 W	2IF100.60-1	259
IF101	Interface Module, 1 x RS232, 1 x RS232/TTY, 1 x RS485/RS422, 1 x CAN, 1 x ETHERNET	System	-7 W	2IF101.60-1	259
NW100	PROFIBUS Network Module	System	-15 W	2NW100.50-1	261
Counter and Positioning Modules					
NC303	Intelligent I/O Processor, Path Processor for Ultrasonic Transducer	I/O	-21 W -1.5 x P _{Enc}	2NC303.60-1	263
Accessories					
BM100	Dummy Module	I/O		2BM100.9	267
TB120	Terminal Block, 20 pin Screw Clamp			2TB120.9	268
TB140	Terminal Block, 40 pin Screw Clamp			2TB140.9	268
Manuals					
MASYS22010-0	B&R 2010 User's Manual, German			MASYS22010-0	268
MASYS22010-E	B&R 2010 User's Manual, English			MASYS22010-E	268

¹⁾ One watt is to be subtracted for each internally supplied encoder.

²⁾ The power consumption depends on the encoder supply used.
24 V Encoder Supply Voltage: $9\text{ W} + 1.5 \times \text{Encoder Power}$
4.6 V Encoder Supply Voltage: $9\text{ W} + 2.5 \times \text{Encoder Power}$

³⁾ The power consumption depends on the encoder supply used.
24 V Encoder Supply Voltage: $13\text{ W} + 1.5 \times \text{Encoder Power}$
4.6 V Encoder Supply Voltage: $13\text{ W} + 2.5 \times \text{Encoder Power}$

General Information

Dimensions

The B&R 2010 system has both single and double width modules, depending on to the slots needed:

Width	Slots
Single	1
Double	2

The given measurements are installation measurements. The depth of the base plate must be taken into consideration to find the total depth of the PCC.

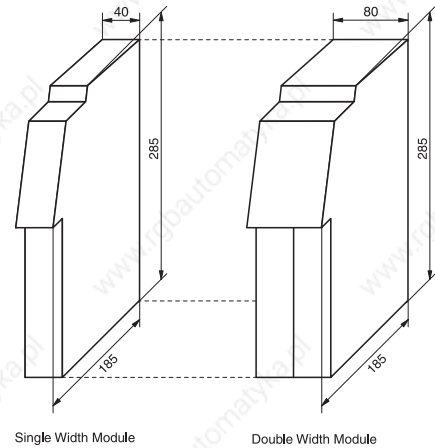

Principle Module Structure

Each module front is divided into two areas:

- Status display
- Connection area

The **Status Display** is found behind a transparent plastic door, which is opened when it is swung upwards. Depending on the module, display and/or operational elements such as seven segment display, status LEDs, number switch, reset key, etc. are found here. The plastic door is to be closed during operation.

The **Connection Area** is situated behind the module door. D-type connectors and terminal block plugs can be found here. The slot for the application memory module is found behind the same door on processor modules (double width).

A labeling strip can be inserted on the inner side of the module doors of I/O modules and the CPU module. This labeling strip can be used for describing the connection terminations and the interface assignments etc.

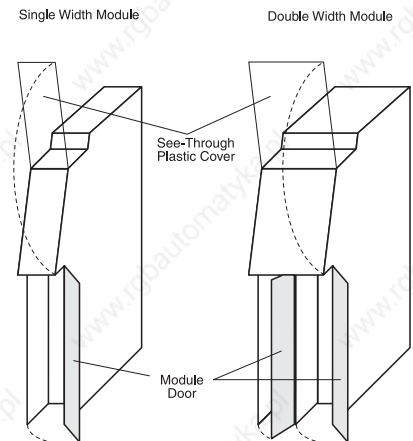

Differences between System and I/O Modules



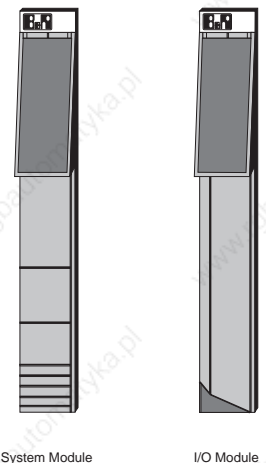

System modules and I/O modules of the 2010 system can be optically differentiated. The bottom edge of the module door is angled on I/O modules. On system modules this edge is straight.



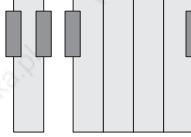
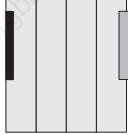

You can be absolutely sure of your system's integrity just by looking at it. To the immediate right of the CPU, only I/O modules (slanted door) are allowed and the system modules (straight door) can only be located to the left of the CPU.



Base Plate Modules

The base plate where the system or I/O bus is located is modular. Base plate modules are available in different widths and are split into three different groups:

Base Plate Modules for System Bus	Base Plate Modules for CPUs	Base Plate Modules for I/O Bus	
 BP101		 BP200 BP201	Base Plate Modules without Bus Termination
 BP110	 BP300	 BP210	Base Plate Modules with Bus Termination
		 BP202	Base plate Modules for Bus Expansion (Expansion Slave) or Remote I/O (Remote Slave)

 System Bus
  Termination for System Bus
  I/O Bus
  Termination for I/O Bus

Base Plate Module Dimensions:

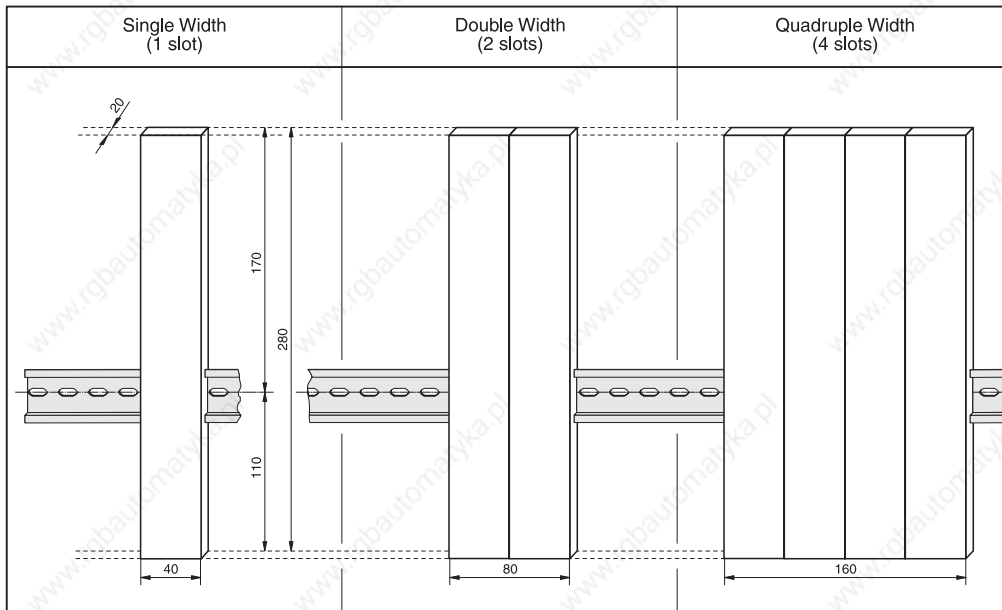

Mounting Rail

A mounting rail which conforms to standard EN 50022 is required for a proper installation. The mounting rail must be grounded and must make electrical contact with the cabinet's back wall or mounting panel.

Please take note of the manufacturers instructions!

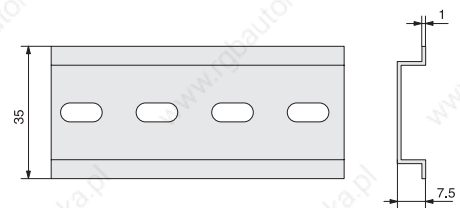

Installation

Installation is only allowed to be carried out by qualified personnel!

Installing the PCC must be done in a certain sequence:

- 1) Install mounting rail
- 2) Install base plate modules
- 3) Install PCC modules

Installing the Base Plate Modules

To put the individual base plate modules together, follow these steps:

- a) Move all fastening levers to the „OPEN“ position
- b) Hang the left-most base plate module in the desired position on the mounting rail
- c) Hang all following base plate modules, one at a time, pushing each tightly to the left up against its neighbouring module until the connecting clip locks into place. The guide pegs must align with the respective holes in the module to its immediate left.
- d) After all base plate modules have been hung and connected together, all fastening levers should be moved to the „CLOSE“ position.

**Both system and I/O buses must be terminated with a base plate module with a bus terminator
(Exception: System bus with 2 slots).**

The base plate modules should be arranged so that the single width modules are situated at the end of the bus and the quadruple-width modules should be connected to the main base plate module. This makes it easier to integrate future base plate expansions.

Removing base plate modules is done in the reverse order.

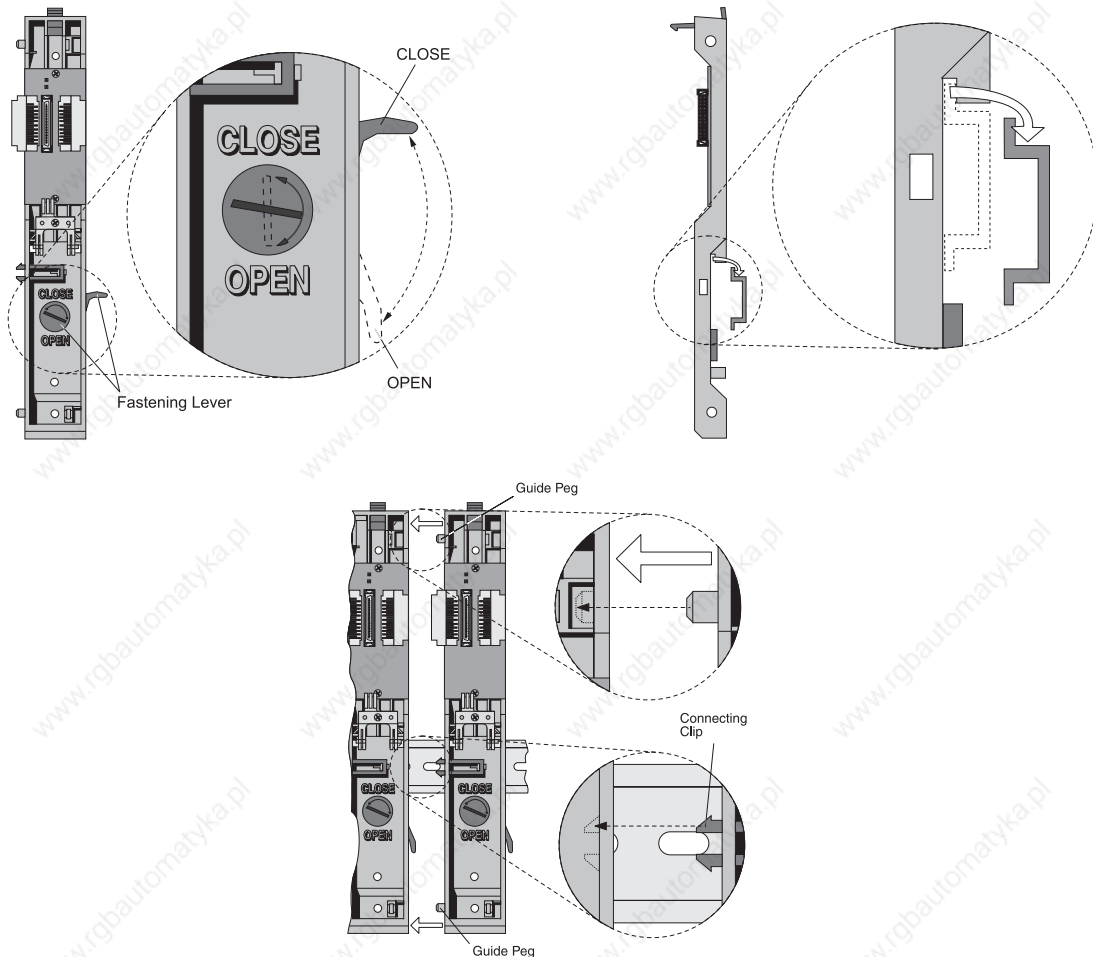

Installing PCC Modules

After all of the base plate modules are fastened securely to the mounting rail in their proper positions, the PCC modules can be installed in their respective slots on the base plates. A module is inserted into its slot as explained below:

- (1) Hang the module with the module support hook on the respective base hook latch of the base plate.

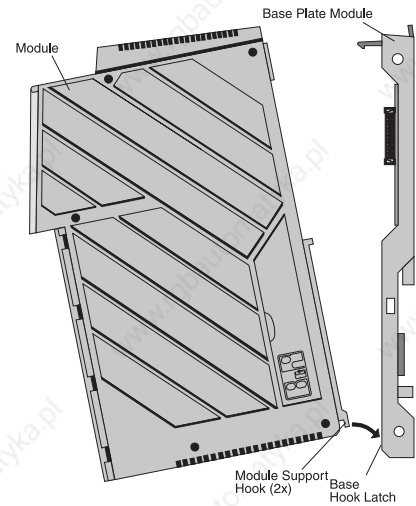

- (2) Tilt the module back until the upper fastening clip of the base plate clicks into place.

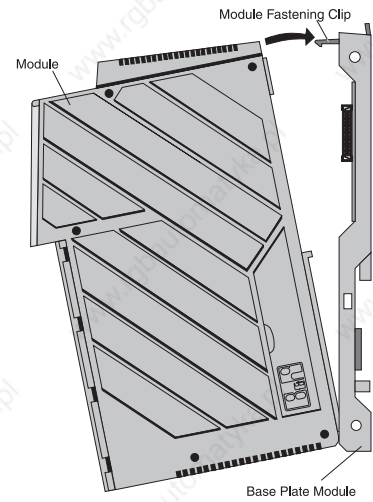

Removing PCC modules is done in the reverse order.

Pressing the module fastening lever (1) forward will unclip the attachment. The module can then be tilted forward (2) and then removed from the base plate (3).

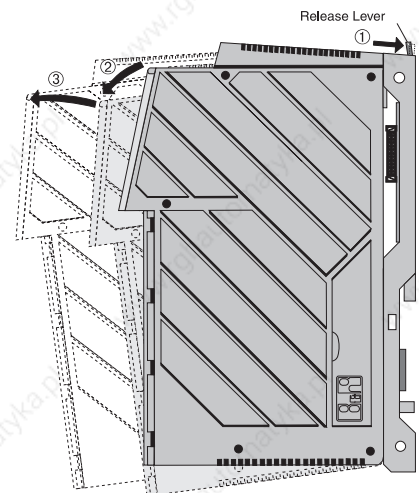

Terminal Blocks TB120 / TB140

Connection to the module is done with a double row terminal block that can easily be plugged in or unplugged. By using the special coding bars on the terminal block and on the module casing, a clear relationship between the terminal block - module or slot is established. A proper connection of the terminal block is monitored and indicated by a status LED.

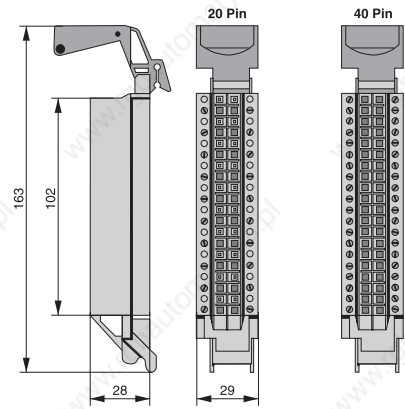

A locking/ejection lever is provided on the terminal block for easy and sure connection or removal. Pressing the terminal block into place or removing it by hand is made effortless which is a great improvement over the standard connector, especially with the 40 pin terminal block.

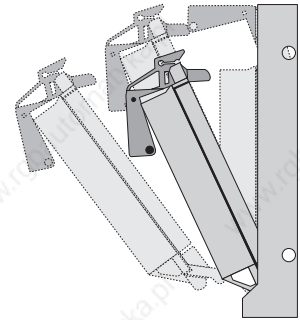

Cable Routing and Connection to the Terminal Block

All cables (cable bundles) are to be run down from the terminal blocks and attached to the slot provided with a cable tie.

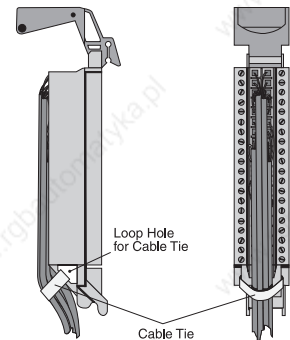

Coding the Terminal Block

Coding makes it possible to ensure that a termination to the wrong module cannot occur. For example, by coding the terminal block and the module, you can avoid connecting a terminal block which is meant for a digital output module to an input module. The coding is done with 6 coding bars on the terminal block and on the pin block of the module.

This makes it almost impossible to accidentally switch neighbouring terminal blocks.

Environmental Temperature during Operation and Relative Humidity

The following applies to all 2010 modules, if no different values exist in the „Technical Data“ section.

Environmental Temperature during Operation	0 to 60 °C
Relative Humidity	5 to 95 %, non-condensing

Module Rack

General Information

The B&R 2010 system base plate (sometimes called a back plane) has a modular construction. Individual base plate modules are installed on the mounting rail. These base plate modules hold the respective bus system (either I/O bus or system bus) and the power supply lines. The modular construction allows you to create a base plate to suit the job and the environment.

We recommend that you construct your base plate with as few empty slots as possible. All empty slots are to be filled with dummy modules.

The system bus and the I/O bus must both be terminated with a base plate module which has a bus termination (Exception: System bus with 2 slots).

The module addresses of I/O modules are determined by the slots that they are in (slot coding). Address numbering starts at slot 1 of the I/O bus with address 1. Modules addresses can be read directly from a two digit seven segment status display which is located on the front of the I/O modules. The module addresses of system modules do not depend on the slot. System module addresses are set by means of a number switch on the module.

Base Plate with CPU

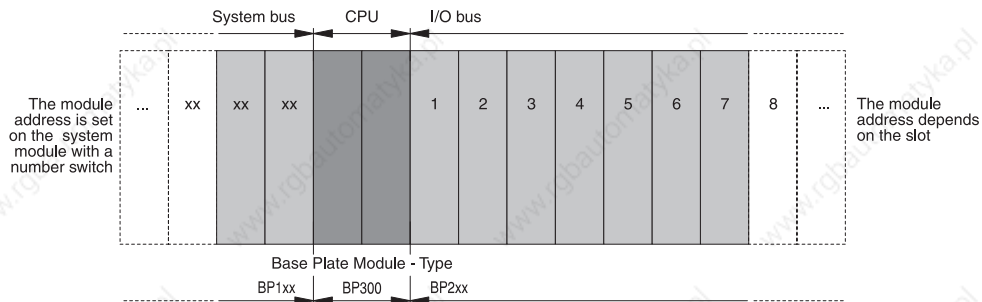

Expansion Base Plate with Expansion Slave

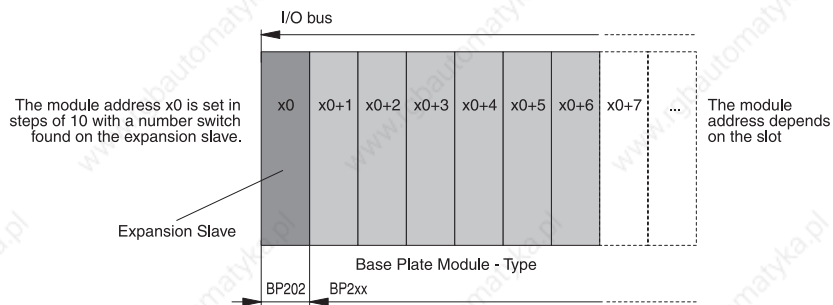

Expansion Base Plate with Remote Slave

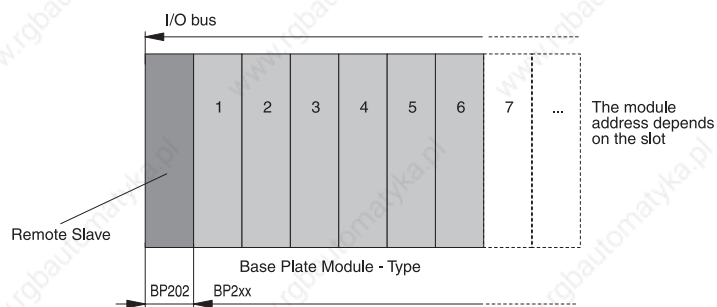

Configuration of the Various Base Plates

The following base plate configurations exist:

- Base plate with system bus: BP110, BP300, BP210
- Base plate without system bus: BP101, BP200, BP201
- Expansion base plate (remote I/O or I/O bus expansion): BP202

Different base plate modules can be used, depending on the base plate configuration. The following base plate modules are available (see diagram):

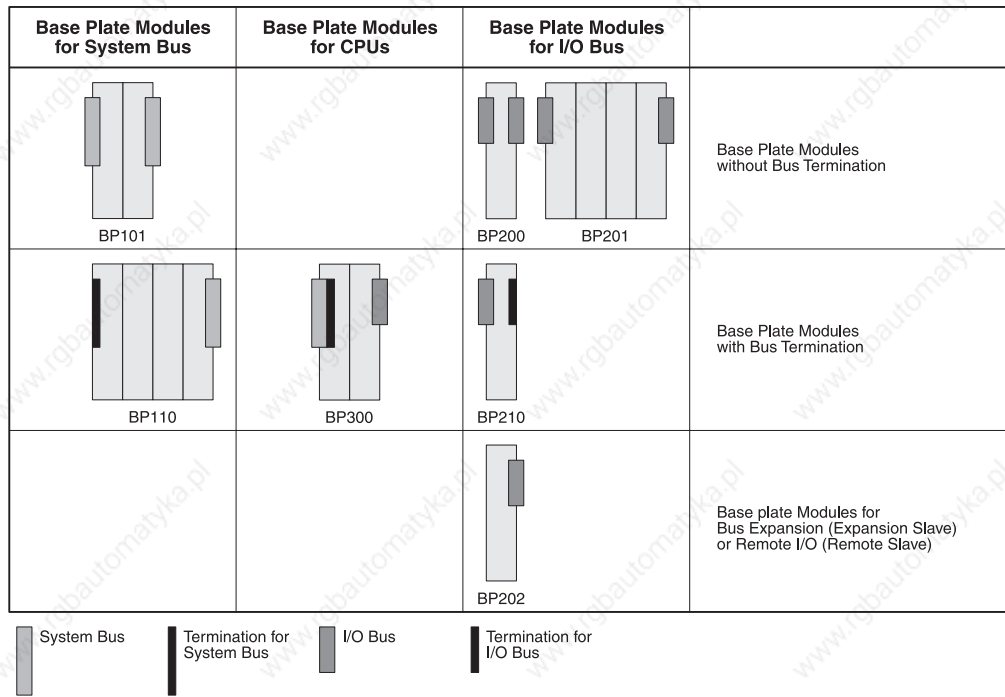

The following modules are to be used for the different base plate configurations:

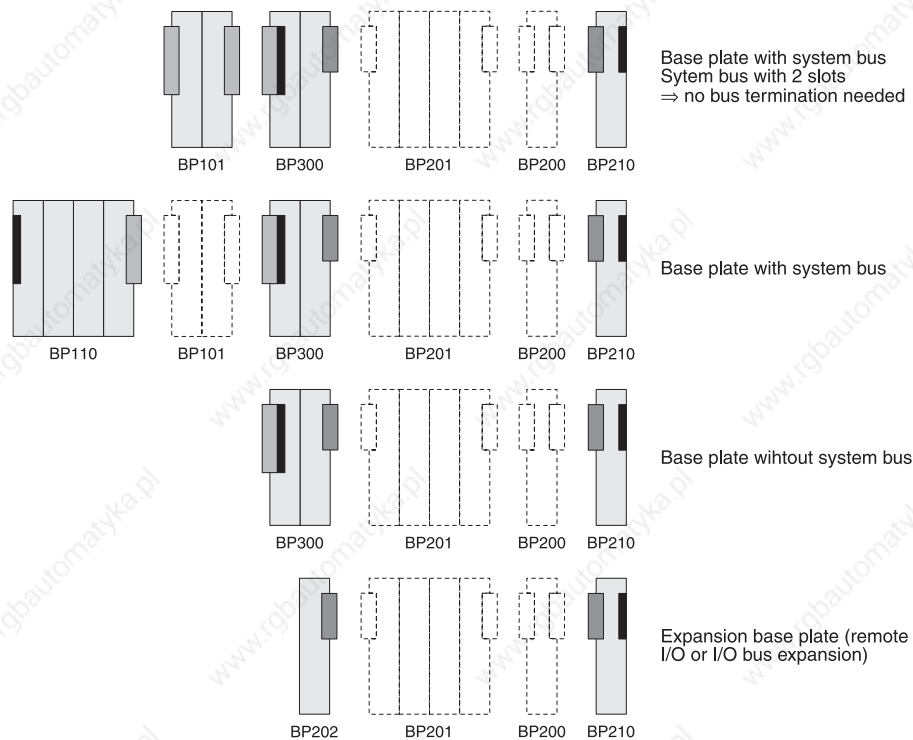

All modules in the diagram which are shown with a grey background must be used with the respective configuration. Those shown as dotted lines can be used alone or with others to expand the base plate.

The base plate modules for the I/O bus should be organized so that the single width modules are located at the end of the bus and the quadruple width modules are situated immediately next to the one with the CPU on it. This makes later expansion easier.

When configuring the base plate, remember that the number of slots is limited and that the amounts may not be exceeded:

System Bus	8 Slots
I/O Bus	20 Slots

Module Rack

BP101 / BP110 / BP200 / BP201 / BP202 / BP210 / BP300

Order Data

Model Number	Description	Figure
2BP101.3	2010 Base plate module, 2 slots for system modules	
2BP110.3	2010 Base plate module, 4 slots for system modules with bus termination for system bus	
2BP200.4	2010 Base plate module, 1 slot for I/O module	
2BP201.4	2010 Base plate module, 4 slots for I/O modules	
2BP202.4	2010 Base plate module, 1 slot for expansion or remote slave	
2BP210.4	2010 Base plate module, 1 slot for I/O module with bus termination for I/O bus	
2BP300.4	2010 Base plate module, 2 slots for CPU with bus termination for system bus	

Technical Data

Module Rack for System Bus				
Module ID	BP101		BP110	
C-UL-US Listed	YES			
Number of Slots for System Modules	2		4	
Bus Termination	NO		YES (system bus)	
Dimensions				
Height	285		285	
Width	80		160	
Depth	20		20	
Module Rack for I/O Bus				
Module ID	BP200	BP201	BP202	BP210
C-UL-US Listed	YES			
Number of Slots for I/O Module Expansion or Remote Slave	1 ---	4 ---	--- 1	1 ---
Bus Termination	NO	NO	NO	YES (I/O bus)
Dimensions				
Height	285	285	285	285
Width	40	160	40	40
Depth	20	20	20	20
Module Rack for CPU				
Model ID	BP300			
C-UL-US Listed	YES			
Number of Slots	2 (for 1 CPU)			
Bus Termination	YES (system bus)			
Dimensions				
Height	285			
Width	80			
Depth	20			

Power Supply Modules

General Information

Power supply modules convert the input voltage (24 VDC, 120 VAC or 230 VAC) to the voltage required internally by the PCC. Every main and expansion unit requires at least one power supply module. Power supply modules are only allowed to be on the I/O bus (never on the system bus).

Always make sure that you select the power supply module corresponding to the input voltage rating. When configuring a system, make sure that the power consumption of all modules to be used is not greater than the output power of the power supply modules.

Any number of power supplies (including possible redundant modules) of B&R SYSTEM 2010 can be placed in almost any slot position on the I/O bus. These modules can be inserted or removed while under power.

Safety Features

Power supply modules have an internal current limitation (short circuit protection) and overload protection. A fuse protects the module against overload and reverse polarity. The fuse is behind the module door. The functions of the power supply module can be monitored with a Ready Relay. This relay is set if the power supply module is functioning properly. If an error occurs (e.g.: overload), the relay opens breaking contact. The ready relay can be used to externally monitor the current supply.

Overview

Module	PS425	PS740
Input Voltage	24 VDC	90 ... 270 VAC
Output Power	100 W	100 W
Fuse, Slow-Blow	10 A / 250 V	1.6 A / 250 V

Power Supply Module Location

- (1) B&R recommends placing the first power supply module in the outer most right slot of the I/O bus.
- (2) The slots that other power supply modules should be situated in can be determined with a simple formula:
The power consumption of the modules is added from the right-hand side to the left. The sum is not allowed to be less than zero, or another power supply module must be installed in that position (see the following example). The first slot is an exception because no power supply can be inserted on the system bus.
In the module overview at the beginning of this section, the power provided or consumed by the various modules is listed. This allows a power balance to be quickly and easily calculated for a particular hardware configuration.
- (3) Due to the power dissipation of the power supply, which in turn causes heat, a power supply should not be situated directly next to a module with high consumption.

Example to clarify any problems concerning the location of your power supply modules on the system:

- The following modules are required in the example system:

Amount	Module	Description	Bus	Power Consumption	
				Per Module	Σ
1	NW100	Network module	System bus	15	15
1	CP100	CPU	System or I/O bus	10	10
1	AI300	Analog input module	I/O bus	9	9
4	AT610	Thermocouple module	I/O bus	8	32
3	AO300	Analog output module	I/O bus	10	30
2	DI426	Digital input module	I/O bus	6	12
2	DO700	Digital output module	I/O bus	6	12
				$\Sigma =$	120

- The sum from above has determined that we need at least two power supply modules
- We have to remember that the output power of the power supply module depends on the environmental temperature and the input voltage as well (see Technical Data).
- The following table shows the slots in which the power supply modules should be situated:

Module	Power [W] ¹⁾	Σ [W]	Remarks
NT	+100	+100	Recomendation from B&R: Power supply on the far right slot on the I/O bus
DO700	-6	+94	
DO700	-6	+88	
DI426	-6	+82	
DI426	-6	+76	
AO300	-10	+66	
AO300	-10	+56	
AO300	-10	+46	
AT610	-8	+38	
AT610	-8	+30	
AT610	-8	+22	
AT610	-8	+14	
AI300	-9	+5	
PS	+100	+105	A second power supply has to be installed here because there is not enough power left over for another module (5 W).
CP100	-10	+95	
NW100	-15	+80	There are now 80 more Watts than are needed by the modules used (reserve).

¹⁾ The power consumption of a module is indicated with a "-" and the power supplied by the power supply module is shown with "+".

After the calculation has been made, the system is organized as follows (see illustration below).

If the modules are set up differently, the calculation must be made again.

After the number of power supply modules required for the system has been determined, the required base plate modules (see „Base Plate Modules“) can be selected.

All empty slots must be filled with dummy modules.

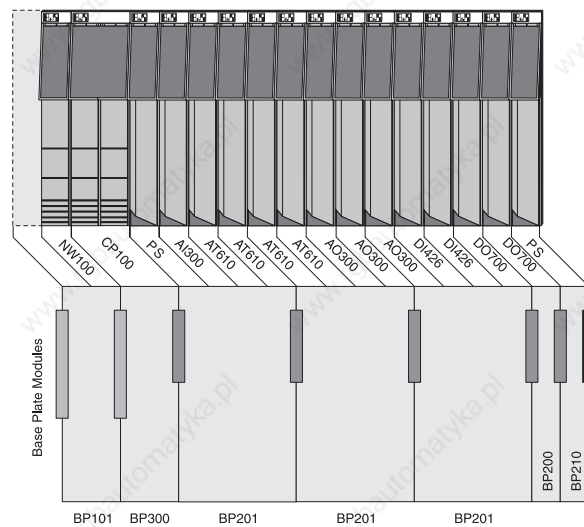

Power Supply Module

PS425

Order Data

Model Number	Description	Figure
2PS425.9	2010 Power supply module, 24 VDC, 100 W	

Technical Data

Module ID	PS425
General	
C-UL-US Listed	YES
Module Type	B&R 2010 power supply module, single width
Module Rack	BP200, BP201, BP210
Power Supply	
Input Voltage	
Minimum	18 VDC
Nominal	24 VDC
Maximum	30 VDC
External Back-up Capacitor for Single Phase Bridge for Three Phase Bridge	20000 µF 12000 µF
Output Power	100 W
Current Requirements	Max. 6.5 A
Protective Measures	
Fuse	10 A slow-blow / 250 V
Thermal Overload Protection	Monitoring the temperature within housing
Current Limitation	Monitoring output power
Peripherals	
Status Display	LEDs
READY Relay	
Wiring	N.O.
Nominal Switching Voltage	24 VDC / 230 VAC
Max. Load on Contacts	2 A
Transient Voltage	2.5 kV
Protection	External

Power Supply Module

PS740

Order Data

Model Number	Description	Figure
2PS740.9	2010 Power supply module, 100-240 VAC, 100 W	

Technical Data

Module ID	PS740
General	
C-UL-US Listed	YES
Module Type	B&R 2010 power supply module, single width
Module Rack	BP200, BP201, BP210
Power Supply	
Input Voltage Minimum Nominal Maximum	90 VAC 100 to 240 VAC 270 VAC
Input Voltage Frequency	47 to 63 Hz
Oversvoltage Peak Value Half-peak Duration	750 V 1.3 msec nonperiodic
Output Power	see diagram "Output Power"
Current Requirements	Max. 1.1 A
Protective Measures Fuse Thermal Overload Current Limitation	1,6 A slow-blow / 250 V Monitoring temperature within housing Monitoring the output power
Peripherals	
Status Display	LEDs
READY Relay Wiring Nominal Switching Voltage Max. Load on Contacts Transient Voltage Protection	N.O. 24 VDC / 230 VAC 2 A 2.5 kV External

Output Power

The output power of the PS740 power supply module sinks with falling input voltage or increasing operating temperature (because of internal temperature monitoring). This must be taken into account when planning your power requirements.

External Component Supply

The secondary voltage (28 V) produced can be switched as required to the I/O bus (PCC system) or to a terminal block on a module. This makes it possible to use this power supply for providing the power to external I/O components.

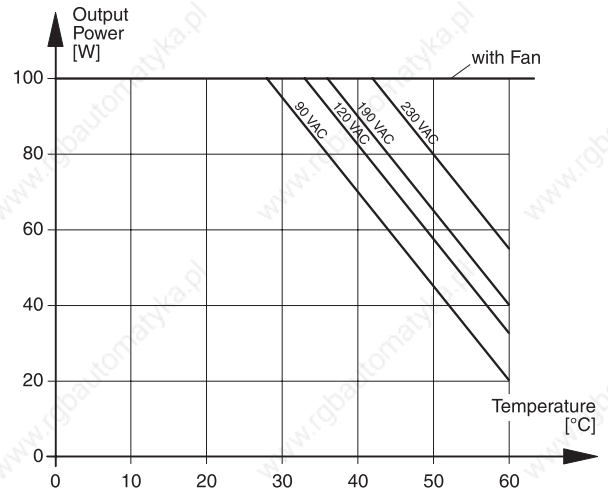

Bus Controller Modules

EX100 / EX200

Order Data

Model Number	Description	Figure
	Remote I/O Bus Controller	
2EX100.50-1	2010 Remote I/O master, 2 electrically isolated RS485 interface. For connection to remote I/O bus	
2EX200.50-1	2010 Remote I/O slave, 2 electrically isolated RS485 interface. For connection to remote I/O bus	
	Accessories	
0G1000.00-090	Bus connector, RS485, for PROFIBUS networks, remote I/O	
0AC916.9	Bus connector, RS485, active. For PROFIBUS networks, remote I/O, Standard mounting rail, Supply voltage: 120 / 230 VAC	
Additional information concerning accessories can be found in sections "Accessories" and "Manuals".		

Technical Data

Module ID	EX100 Remote Master	EX200 Remote Slave
General		
C-UL-US Listed	YES	
Module Type	B&R 2010 system module	B&R 2010 I/O module
Module Rack	BP101, BP110	BP202
Power Consumption	Max. 12 W	
Peripherals		
Diagnosis LEDs	YES	
Number Switch	Setting for the module address	----
NODE#	Setting for the slave address	
Standard Communication Interface		
Interface Type	2 x RS485	
Connection	2 x 9 pin D-type connector (F)	
Isolation	YES	
Baudrates 100 kBit/sec 181 kBit/sec 500 kBit/sec 1000 kBit/sec 2000 kBit/sec	Depends on distance Max. 1200 m Max. 1000 m Max. 400 m Max. 200 m Max. 100 m	
Remote I/O Bus		
Access	Master/Slave principle	
Number of Remote I/O Masters on System Bus	Max. 8	---
Number of Slaves	Mx. 31 (without repeater)	---
Topology	Physical bus	
Bus Coupling	Direct	
Transfer Medium	Shielded, twisted pair	
Termination Resistance	External	
Mechanical Characteristics		
Dimensions	B&R 2010 single width	

Bus Controller Modules

EX301 / EX302

Order Data

Model Number	Description	Figure
2EX301.5	2010 Expansion slave, I/O bus divided into bus segments. Order expansion cable separately!	
2EX302.5	2010 Expansion master, I/O bus divided into bus segments. Order expansion cable separately!	
0G0010.00-090	Cable I/O bus expansion, 1 m, Bus expansion for B&R 2005 / B&R 2010	
0G0012.00-090	Cable I/O bus expansion, 2 m, Bus expansion for B&R 2005 / B&R 2010	

Technical Data

Module ID	EX301	EX302
General		
C-UL-US Listed	YES	
Module Type	B&R 2010 I/O module	
Module Rack	BP202 BP200, BP201, BP210	
Power Consumption	Max. 3 W	
Peripherals		
Interfaces	1 Expansion Master connection	2 Expansion Slaves connections
Transfer Media Length	Expansion cable 1 m or 2 m	
Mechanical Characteristics		
Dimensions	B&R 2010 single width	

CPUs

General Information

The CPU module is operated on the BP300 base plate module. It requires two slots. A CPU module cannot be operated in an expansion unit.

Status Area

The status area contains Status LEDs, a two digit status display, various keys and the lithium battery compartment.

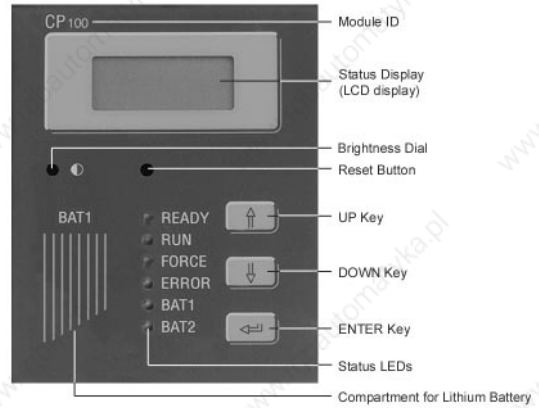

Connection Area

The serial interfaces (Online interface), a connector for FORCE and READY contacts, a key switch and the slot for the application memory are all found behind the module doors.

Behind the Left Module Door

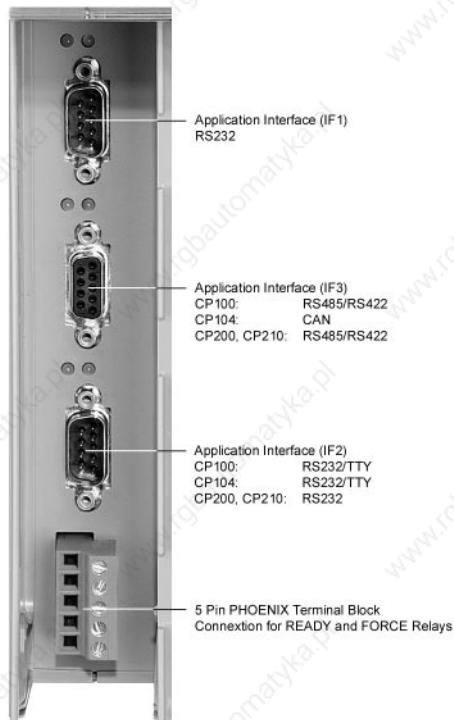

Behind the Right Module Door

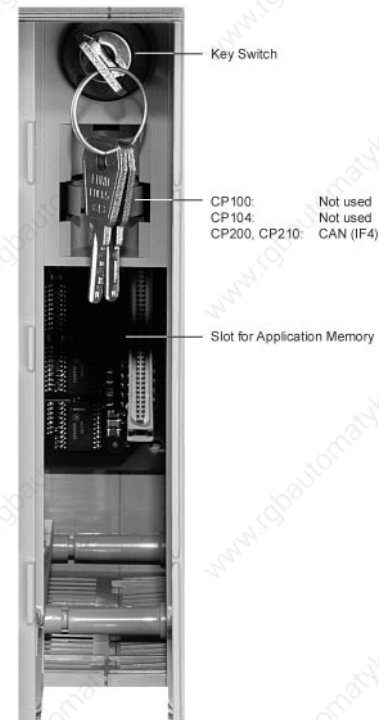

Safety Features

A **Ready Relay** can be used to monitor the functionality of the PCC. The Ready Relay is set in normal operation and falls out if an error occurs. The ready relay is normally tied into the E-STOP circuit.

The **FORCE Contact** is closed, if the „FORCE“ function is activated from the PG2000 Programming system. A memory location (I/O point) in the CPU is set to a certain value with this function.

CPUs

CP100 / CP104 / CP200 / CP210

Order Data

Model Number	Description	Figure
	CPU	
2CP100.60-1	2010 CPU, 128 + 256 KB SRAM, 1 RS232 interface, 1 electrically isolated RS232/TTY, 1 electrically isolated RS485/RS422, RS485/RS422: network-capable. Order application memory separately!	
2CP104.60-1	2010 CPU, 128 + 256 KB SRAM, 1 RS232 interface, 1 electrically isolated RS232/TTY, 1 electrically isolated CAN interface, CAN: network-capable. Order application memory separately!	
2CP200.60-1	2010 CPU, 128 KB + 2 MB SRAM, 2 x 4 KB Cache, 1 RS232 interface, 1 electrically isolated RS232, 1 electrically isolated RS485/RS422, 1 electrically isolated CAN interface, RS485/RS422 + CAN: network-capable. Order application memory separately!	
2CP210.60-1	2010 CPU, 128 KB+6 MB SRAM, 2x4 KB Cache, MMU+FPU, 1 RS232 interface, 1 electrically isolated RS232, 1 electrically isolated RS485/RS422, 1 electrically isolated CAN interface, RS485/RS422 + CAN: network-capable. Order application memory separately!	
The backup battery is included with the delivery.		

Model Number	Description
	Application Memory
2ME910.90-1	2010 Application memory, 64 KB SRAM, 256 KB FlashPROM, With PCC operating system
2ME913.90-1	2010 Application memory, 512 KB SRAM, 1 MB FlashPROM, With PCC operating system
2ME915.90-1	2010 Application memory, 2 MB SRAM, 2 MB FlashPROM, With PCC operating system
	Accessories
0G0001.00-090	Cable PC <-> PCC/PW, RS232, Online cable
0AC201.9	Cable PC <-> PCC/PW, RS232, Online cable
7AC911.9	Bus connector, CAN
0AC912.9	Bus adapter, CAN, 1 CAN interface
0AC913.92	Bus adapter, CAN, 2 CAN interfaces, incl. 30 cm connection cable
0G1000.00-090	Bus connector, RS485, for PROFIBUS networks, remote I/O
0AC916.9	Bus connector, RS485, active. For PROFIBUS networks, remote I/O, Standard mounting rail, Supply voltage: 120 / 230 VAC
Additional information concerning accessories can be found in sections "Accessories" and "Manuals".	

Technical Data

Module ID	CP100	CP104	CP200	CP210
General				
C-UL-US Listed	YES			
Module Type	B&R 2010 CPU, double width			
Module Rack	BP300			
Power Consumption (incl. APM)	Max. 10 W		Max. 20 W	Max. 22.5 W
Processor				
Communication	RISC			
MMU and FPU	NO		NO	YES
Instruction Cycle Time	0.8 µsec		0.125 µsec	
Cache	NO		2 * 4 KByte	

Module ID	CP100	CP104	CP200	CP210
Dual Ported RAM (DPR)	128 KByte SRAM			
System RAM	256 KByte SRAM		2 MB SRAM	6 MB SRAM
Application Memory (not incl.)	ME910, ME913, ME915			
Data Buffering Lithium Battery in CPU Gold Foil Capacitor in CPU Battery Monitoring	At least 2 years ¹⁾ At least 10 min YES			
Peripherals				
System Bus	YES			
Real Time Clock Resolution	Nonvolatile, battery buffered 10 msec			
Key Switch	YES			
Reset Button	YES			
Three User Keys	UP, DOWN, ENTER. Can be programmed by user			
Status Display	Alphanumeric LC display (2 lines 8 characters each), 6 Status LEDs			
READY Relay Wiring Switching Voltage Nominal Maximum Max Load on Contact Transient Voltage Protection	N.O. 24 VDC / 230 VAC 30 VDC / 270 VAC 3 A 2 kV Required externally			
FORCE Relay Wiring Switching Voltage Nominal Maximum Max. Load on Contacts Transient Voltage Protection	N.O. 24 VDC / 230 VAC 30 VDC / 270 VAC 3 A 2 kV Required externally			
Standard Communication Interface				
Application Interface IF1 Isolation Connection Distance Baudrate	RS232 NO 9 pin D-type connector (M) Max. 15 m / 19200 Baud Max. 64 kBaud			
Application Interface IF2 Isolation Connection Distance Baudrate	RS232 / TTY ²⁾ YES 9 pin D-type connector (M) RS232: max. 15 m / 19200 Baud, TTY: max. 300 m Max. 64 kBaud		RS232 YES 9 pin D-type connector (M) Max. 15 m / 19200 Baud Max. 64 kBaud	
Application Interface IF3 Isolation Connection Distance Baudrate Bus Length 10 - 60 m Bus Length 100 - 200 m Bus Length 800 - 1000 m	RS485 / RS422 ²⁾ YES 9 pin D-type connector (F) Max. 1200 m Max. 347 kBaud	CAN YES 9 pin D-type connector (M) Max. 1000 m 500 kBits/sec 250 kBits/sec 50 kBits/sec	RS485 / RS422 ²⁾ YES 9 pin D-type connector (F) Max. 1200 m Max. 347 kBaud	
Application Interface IF4 Isolation Connection Distance Baudrate Bus Length 10 - 60 m Bus Length 100 - 200 m Bus Length 800 - 1000 m			CAN YES 9 pin D-type connector (M) Max. 1000 m 500 kBits/sec 250 kBits/sec 50 kBits/sec	

¹⁾ A full battery must be present in the APM, otherwise the buffer time is reduced to 1 year because RAM in the APM is also being buffered!

²⁾ Interface can be set up using software.

Programmable Modules

General Information

Module	Description
DS100	2010 Electronic drum sequencer, Absolute encoder, SSI/parallel, 16 Bit, 3 diff. inputs, RS422 level, 100 kHz, 3 diff. outputs, RS422 level, 100 kHz, 16 digital inputs 24 VDC, 5 µsec, sink. Order terminal block separately!
DS101	2010 Electronic drum sequencer, Absolute encoder, SSI/parallel, 16 Bit, 3 diff. inputs, RS422 level, 100 kHz, 3 diff. outputs, RS422 level, 100 kHz, 16 digital inputs 24 VDC, 5 µsec, sink, 32 digital outputs 24 VDC, 0.5 A. Order terminal blocks separately!
MP100	2010 Multiprocessor, 64 + 256 KB SRAM, 1 RS232 Interface, 1 electrically isolated RS485/RS422, RS485/RS422: network-capable. Order application memory separately!

Programmable Module

DS100

Order Data

Model Number	Description	Figure
2DS100.60-1	2010 Electronic drum sequencer, Absolute encoder, SSI/parallel, 16 Bit, 3 diff. inputs, RS422 level, 100 kHz, 3 diff. outputs, RS422 level, 100 kHz, 16 digital inputs 24 VDC, 5 µsec, sink. Order terminal block separately!	
2TB140.9	2010 Terminal block, 40 pin, screw clamps	

Technical Data

Module ID	DS100
General	
C-UL-US Listed	YES
Module Type	B&R 2010 I/O module
Module Rack	BP200, BP201, BP210
Power Consumption 24 V Encoder Supply 4.6 V Encoder Supply	9 W + 1.5 x encoder power 9 W + 2.5 x encoder power
Processor	
Communication	RISC
Instruction Cycle Time	0.8 µsec
Dual Ported RAM (DPR)	384 Byte SRAM (unbuffered)
System RAM	256 KByte SRAM (unbuffered)
Encoder Supply (internal)	
Absolute Encoder SSI Voltage Current Capacity	24 V ±10% Max. 120 mA
Absolute Encoder with Parallel IF Voltage Current Capacity	4.6 V ±10% Max. 120 mA
Protection	Short circuit protection and current limitation
Isolation	YES
Encoder to be Used	
Type	Absolute encoder (single turn)
Synchronous Serial Interface Coding Resolution Working Range	Gray or dual Max. 16 Bit 4096 steps
Parallel Interface Coding Resolution	Gray or dual Max. 12 Bit
Differential Outputs	
Number of Differential Outputs	3
Output Level	RS422 standard

Module ID	DS100
Output Frequency	Max. 100 kHz
Isolation Output – PCC Output – Output	YES (optocoupler) NO
Differential Inputs	
Number of Differential Inputs	3
Input Level	RS422 standard
Input Frequency	Max. 100 kHz
Isolation Input – PCC Input – Input	YES (optocoupler) NO
Digital Inputs	
Number of Inputs Total in 4 Groups of	16 4
Wiring	Sink
Input Voltage Nominal Maximum	24 VDC 30 VDC
Input Resistance	4.4 kΩ
Switching Threshold LOW Range Switching Range HIGH Range	<5 V 5 to 15 V >15 V
Switching Delay log. 0 - log. 1 log. 1 - log. 0	(max. and typ.) 5 μsec (pulse width ≥20 μsec) 5 μsec (pulse width ≥20 μsec)
Counter Frequency	Max. 25 kHz (at ratio 1:1)
Isolation Input – PCC Group – Group Input – Input (same Group)	YES (optocoupler) YES (optocoupler) NO
Mechanical Characteristics	
Dimensions	B&R 2010 single width

General Information

The DS100 module is a programmable I/O module with 3 differential outputs, 3 differential inputs and 16 digital inputs. The main application area for this module is in **electronic drum sequencers**.

The drum sequencer has its name from its mechanical predecessor, which was a series of cam disks situated on a rotating drum, which triggered switches in sequence. Every cam disk corresponds to a certain output, which is activated in a certain position during the drum's rotation.

An electronic version of the drum sequencer has the following advantages over the mechanical type:

- Better switching precision over the entire speed range (machine acceleration and deceleration, production speed changes)
- No mechanical deterioration causing play in the works
- Easier disc adjustment (production modifications)
- Pre-stop Times (dead time compensation)

By using the DS100 I/O processor as a drum sequencer, the output states of up to 128 outputs can be calculated according to the actual position. In addition, a pre-stop time can be calculated at the same time, to compensate switching times. The output states are stored in the DPR (Dual Port RAM) and can be read cyclically by the PCC CPU and re-copied to any digital output modules.

To read the actual angular position, the following encoders can be connected to the various inputs or outputs of the DS100 module:

- Incremental Encoder
- Absolute Encoder with synchronous serial interface (SSI)
- Absolute Encoder with parallel interface

The method of coding (grey or dual) as well as the encoder resolution can be defined by the user with the software (Function Blocks).

The encoder supply comes from the module as well. It is electrically isolated from the PCC, short circuit protected and current limited and is fed through the terminal block.

The electronic drum sequencer can be configured by the user, via function blocks. The respective software can be obtained from B&R (including documentation).

Programmable Module

DS101

Order Data

Model Number	Description	Figure
2DS101.60-1	2010 Electronic drum sequencer, Absolute encoder, SSI/parallel, 16 Bit, 3 diff. inputs, RS422 level, 100 kHz, 3 diff. outputs, RS422 level, 100 kHz, 16 digital inputs 24 VDC, 5 µsec, sink, 32 digital outputs 24 VDC, 0.5 A. Order terminal blocks separately!	
2TB140.9	2010 Terminal block, 40 pin, screw clamps	

Technical Data

Module ID	DS101
General	
C-UL-US Listed	in preparation
Module Type	B&R 2010 I/O module
Module Rack	BP200, BP201, BP210
Power Consumption 24 V Encoder Supply 4.6 V Encoder Supply	13 W + 1.5 x encoder power 13 W + 2.5 x encoder power
Processor	
Communication	RISC
Instruction Cycle Time	0.8 µsec
Dual Ported RAM (DPR)	384 Byte SRAM (unbuffered)
System RAM	256 KByte SRAM (unbuffered)
Encoder Supply (Internal)	
Absolute Encoder SSI Voltage Current Capacity	24 V ±10% Max. 120 mA
Absolute Encoder Parallel IF Voltage Current Capacity	4.6 V ±10% Max. 120 mA
Protection	Short circuit protection and current limitation
Isolation	YES
Encoder to be Used	
Type	Absolute encoder (single turn)
Synchronous Serial Interface Coding Resolution Working Range	Gray or dual Max. 16 Bit 4096 steps
Parallel Interface Coding Resolution	Gray or dual Max. 12 Bit
Differential Outputs	
Number of Differential Outputs	3
Output Level	RS422 standard
Output Frequency	Max. 100 kHz

Module ID	DS101
Isolation Output – PCC Output – Output	YES (optocoupler) NO
Differential Inputs	
Number of Differential Inputs	3
Input Level	RS422 standard
Input Frequency	Max. 100 kHz
Isolation Input – PCC Input – Input	YES (optocoupler) NO
Digital Inputs	
Number of Inputs Total in 4 Groups of	16 4
Wiring	Sink
Input Voltage Nominal Maximum	24 VDC 30 VDC
Input Resistance	4.4 k Ω
Switching Threshold LOW Range Switching Range HIGH Range	<5 V 5 to 15 V >15 V
Switching Delay log. 0 - log. 1 log. 1 - log. 0	(max. and typ.) 5 μ sec (pulse width \geq 20 μ sec) 5 μ sec (pulse width \geq 20 μ sec)
Counter Frequency	Max. 25 kHz (at ratio 1:1)
Isolation Input – PCC Group – Group Input – Input (same group)	YES (optocoupler) YES (optocoupler) NO
Digital Outputs	
Number of Outputs Total in 4 Groups of	32 8
Type	Transistor
Wiring	Source
Switching Voltage Minimum Nominal Maximum	18 VDC 24 VDC 30 VDC
Continuous Current Per Output Per Group Per Module	Max. 0.5 A Max. 4 A Max. 16 A
Protective Circuit Internal External	YES Only if required (surge)
Switching Delay log. 0 - log. 1 log. 1 - log. 0	typ. 5 μ sec / max. 110 μ sec typ. 60 μ sec / max. 100 μ sec
Switching Frequency (resistive load)	Max. 500 Hz
Isolation Output – PCC Group – Group Output – Output	YES YES NO
Mechanical Characteristics	
Dimensions	B&R 2010 double width

General Information

The DS101 module is a programmable I/O module with 3 differential outputs, 3 differential inputs, 16 digital inputs and 32 digital outputs. The main area of application for this module is in the field of **Electronic Drum Sequencers**. The DS101 is basically the same as the DS100, but has 32 transistor outputs which the intelligent I/O processor handles without the support of the PCC CPU.

Programmable Module

MP100

Order Data

Model Number	Description	Figure
	Multiprocessor	
2MP100.5	2010 Multiprocessor, 64 + 256 KB SRAM, 1 RS232 Interface, 1 electrically isolated RS485/RS422, RS485/RS422: network-capable. Order application memory separately!	
	Application Memory	
2ME910.90-1	2010 Application memory, 64 KB SRAM, 256 KB FlashPROM, With PCC operating system	
2ME913.90-1	2010 Application memory, 512 KB SRAM, 1 MB FlashPROM, With PCC operating system	
2ME915.90-1	2010 Application memory, 2 MB SRAM, 2 MB FlashPROM, With PCC operating system	
	Accessories	
0G0001.00-090	Cable PC <-> PCC/PW, RS232, Online cable	
0G1000.00-090	Bus connector, RS485, for PROFIBUS networks, remote I/O	
0AC916.9	Bus connector, RS485, active. For PROFIBUS networks, remote I/O, Standard mounting rail, Supply voltage: 120 / 230 VAC	
Additional information concerning accessories can be found in sections "Accessories" and "Manuals".		

Technical Data

Module ID	MP100
General	
C-UL-US Listed	YES
Module Type	B&R 2010 system module, single width
Module Rack	BP101, BP110
Power Consumption (incl. APM)	Max. 12 W
Processor	
Communication	RISC
Instruction Cycle Time	0.8 µsec
Dual Ported RAM (DPR)	64 KByte
System RAM	256 KByte SRAM
Application Memory (not incl.)	ME910, ME913, ME915
Data Buffering Lithium Battery (APM) Gold Foil Capacitor (APM) Battery Monitoring	At least 1 year ¹⁾ At least 5 min YES
Peripherals	
System Bus	YES
Reset Button	YES
Status Display	8 Status LEDs
Standard Communication Interface	
Application Interface IF1 Isolation Connection Maximum Distance Maximum Baudrate	RS232 NO 9 pin D-type connector (M) 15 m / 19200 Baud 64 kBaud

Module ID	MP100
Application Interface IF3	RS485 / RS422 ²⁾
Isolation	YES
Connection	9 pin D-type connector (F)
Maximum Distance	1200 m
Maximum Baudrate	347 kBaud

¹⁾ Buffering is handled by the lithium battery in the APM. RAM is buffered in the APM and MP100, therefore the buffer duration is reduced to 1 year.

²⁾ Interface settings can be made using software.

General Information

Multiprocessors are used to take the load off the CPU, and to increase the power of the PCC system. Among others, the following tasks can be carried out by multiprocessors:

- Data processing
- Data preparation
- Monitoring functions for start-up and service
- Communication via serial interfaces

The multiprocessor communicates with the CPU via a common memory area (Dual Ported RAM). The multiprocessor also has a system bus interface, through which it actively accesses the system bus. This makes it possible to exchange data with other system modules and with the CPU.

The CPU and the multiprocessor are software compatible. This means that all programs in the CPU (e.g. application tasks) can also run on the multiprocessor. The multiprocessor can be used with the programming device via the RS232 interface.

Application Memory Modules

General Information

The application memory module is inserted into the slot in the front of the CPU module. The application RAM, the application PROM and the operating system ROM are situated in the application memory module.

Buffering RAM

The application RAM is buffered with a lithium battery. The memory contents is kept for at least 2 years.

If the CPU's lithium battery is dead, then the same battery that is used for buffering the application RAM is used for buffering CPU memory. Therefore the buffer time is shorter if the application memory module is in a CPU.

Application Memory Modules

ME910 / ME913 / ME915

Order Data

Model Number	Description	Figure
	Application Memory	
2ME910.90-1	2010 Application memory, 64 KB SRAM, 256 KB FlashPROM, With PCC operating system	
2ME913.90-1	2010 Application memory, 512 KB SRAM, 1 MB FlashPROM, With PCC operating system	
2ME915.90-1	2010 Application memory, 2 MB SRAM, 2 MB FlashPROM, With PCC operating system	
	Accessories	
0AC200.9	Lithium batteries, 5 pcs., 3 V / 950 mAh	
The backup battery is included with the delivery.		

Technical Data

Module ID	ME910	ME913	ME915
General			
C-UL-US Listed	YES		
Operating System	PCC Software		
Memory			
User SRAM	64 KByte	512 KByte	2 MByte
User FlashPROM	256 KByte	1024 KByte	2 MByte
FlashPROM Erase / Program.	Programming logic in module, LED display		
FlashPROM Write Protect	Switch on module		
Buffering RAM ¹⁾ Lithium Battery (APM) Gold Foil Capacitor (APM)	At least 2 years At least 10 min.		
Storage			
Storage Temperature APM without Lithium Battery APM with Lithium Battery Lithium Battery (not installed)	-20 to +70 °C -20 to +60 °C -20 to +60 °C		
Storage Time Lithium Battery (not installed)	Max. 3 years at 30 °C		
Mechanical Characteristics			
Dimensions Height Width Depth	103 mm 32 mm 122 mm		

¹⁾ The buffer times refer to application memory modules which are not installed in a processor module. Otherwise, the times are reduced to 1 year because the processor RAM is also buffered.

Digital Input Modules

General Information

Digital input modules are used for converting binary signals of a process into the internal signal levels required for the PCC. The status of all digital inputs is indicated with status LEDs.

The differences to watch out for between the various input modules are:

- Number of Inputs
- Input Voltage
- Input Delay (filter)
- Special Functions (e. g. Counter Inputs)

Input Filter

There is an input filter for every input. The input delay is indicated in the technical data. Any disturbances shorter than the input delay are suppressed by the input filter.

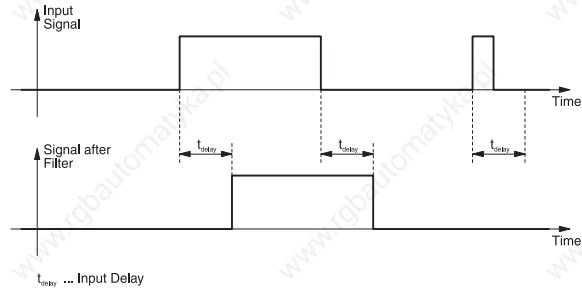

Overview

Module	DI400	DI425	DI426	DI725	DI825
Number of Inputs	32	32	32	32	8
Input Voltage	24 VDC	24 VDC	24 VDC	120 / 230 VAC	
Input Current Circuit Switching Range Hysteresis					1.2 to 2.1 mA typ. 0.5 mA
Input Delay	10 msec	10 msec	1 msec	50 msec	100 µsec
Remarks	8 CSI Inputs 4 Counter Inputs				Ignition protection type [EEEx ia] IIC

Sink/Source Wiring

All B&R SYSTEM 2010 24 VDC input modules (except DI825) can either be wired as sink or source circuits. As the inputs of a module are normally combined into isolated groups of four inputs, each group can be wired differently.

For a sink circuit, the COM termination is connected to signal ground of the same group, and the inputs of the group are connected to 24 V switching sensors.

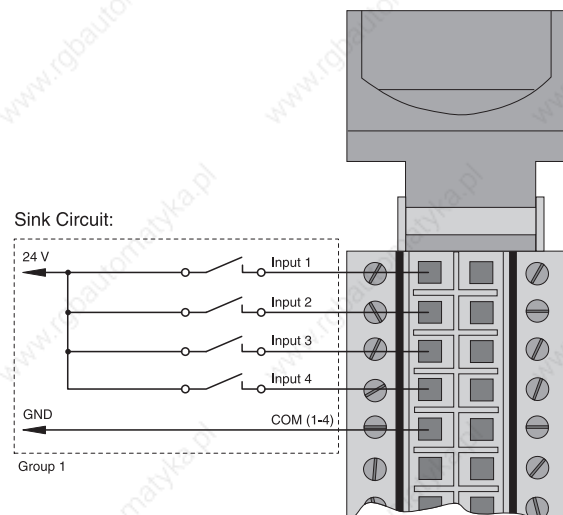

For a source circuit, the COM termination is connected to the +24 VDC of the same group and the inputs of the group are connected to ground switching sensors.

Source Circuit:

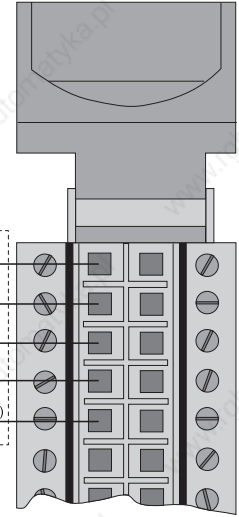
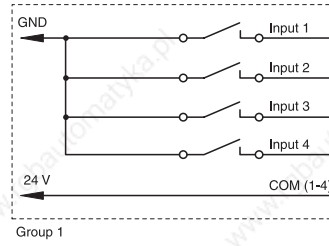

Digital Input Module

DI400

Order Data

Model Number	Description	Figure
2DI400.6	2010 Digital input module, 32 inputs 24 VDC, 10 msec, sink/source, 8 electrically isolated input group, 8 change-of-state inputs, 4 counter inputs, 100 kHz, Gating or duration measurement. Order terminal block separately!	
2TB140.9	2010 Terminal block, 40 pin, screw clamps	

Technical Data

Module ID	DI400
General	
C-UL-US Listed	YES
Module Rack	BP200, BP201, BP210
Static Characteristics	
Module Type	B&R 2010 I/O module
Number of Modules per System	1
Number of Inputs Total In 8 Groups of	32 4
Wiring	Sink or source
Input Voltage Nominal Maximum	24 VDC 30 VDC
Input Current at Nominal Voltage	Approx. 6 mA
Input Resistance	Approx. 4 kΩ
Switching Threshold LOW Range Switching Range HIGH Range	<5 V 5 to 15 V >15 V
Switching Delay Typ. Max.	10 msec 12 msec
CSI Inputs Amount Delay Interrupt Triggered	8 5 msec When state changes
Counter Inputs Amount Input Frequency Resolution Used for	4 Max. 100 kHz 16 Bit Event counting, gating / duration measurement
Power Consumption	Max. 6 W
Operating Characteristics	
Isolation Input – PCC Group – Group Input – Input (same Group)	YES (optocoupler) YES (optocoupler) NO
Mechanical Characteristics	
Dimensions	B&R 2010 single width

Special Functions

Inputs 1 to 16 have special functions:

Inputs	Special Functions
Input 1 - 8	8 Change-of-State Inputs (CSI 1 ... CSI 8)
Input 9 / 10	Counter 1 / Gate 1
Input 11 / 12	Counter 2 / Gate 2
Input 13 / 14	Counter 3 / Gate 3
Input 15 / 16	Counter 4 / Gate 4

Change-of-State Inputs

Inputs 1 to 8 can be selectively enabled for interrupt generation. If the state of an enabled input changes, an interrupt (IRQ) is created in the CPU and the appropriate IRQ task is started.

The normal input function is not influenced for active CSI inputs. Each input can be read normally, if it is enabled as a CSI input or not.

Counter (16 Bit)

Four independent 16 bit counters are available to the user via the input pairs 9/10, 11/12, 13/14 and 15/16. The counters can be reset by software in the application program at any time, in order to have a defined starting point (reference value). An overflow is not registered.

Each counter can be configured individually for:

- Event Counting
- Gating Measurement
- Duration Measurement

For gating and duration measurement, an input signal (gate input) is measured either with an external or an internal frequency. The external frequency is connected to the counter input (max. 100 kHz). When using an internal frequency, either 1 MHz or 4 MHz can be selected.

Each input can still continue to be read as a normal digital input (10 msec input delay), regardless if it is used as counter input or a gate input.

Digital Input Modules

DI425 / DI426

Order Data

Model Number	Description	Figure
2DI425.6	2010 Digital input module, 32 inputs 24 VDC, 10 msec, sink/source, 8 electrically isolated input groups. Order terminal block separately!	
2DI426.6	2010 Digital input module, 32 inputs 24 VDC, 1 msec, sink/source, 8 electrically isolated input groups. Order terminal block separately!	
2TB140.9	2010 Terminal block, 40 pin, screw clamps	

Technical Data

Module ID	DI425	DI426
General		
C-UL-US Listed	YES	
Module Rack	BP200, BP201, BP210	
Static Characteristics		
Module Type	B&R 2010 I/O module	
Number of Inputs Total In 8 Groups of	32 4	
Wiring	Sink or source	
Input Voltage Nominal Maximum	24 VDC 30 VDC	
Input Current at Nominal Voltage	Approx. 6 mA	
Input Resistance	4 kΩ	
Switching Threshold LOW Range Switching Range HIGH Range	<5 V 5 to 15 V >15 V	
Switching Delay Typical Maximum	10 msec 12 msec	1 msec 1.2 msec
Power Consumption	Max. 6 W	
Operating Characteristics		
Isolation Input – PCC Group – Group Input – Input (same Group)	YES (optocoupler) YES (optocoupler) NO	
Mechanical Characteristics		
Dimensions	B&R 2010 single width	

Digital Input Module

DI725

Order Data

Model Number	Description	Figure
2DI725.6	2010 Digital input module, 32 inputs 120/230 VAC, 50 msec, 8 electrically isolated input groups. Order terminal block separately!	
2TB140.9	2010 Terminal block, 40 pin, screw clamps	

Technical Data

Module ID	DI725
General	
C-UL-US Listed	YES
Module Rack	BP200, BP201, BP210
Static Characteristics	
Module Type	B&R 2010 I/O module
Number of Inputs	32
Rated Voltage	120 / 230 VAC
Rated Frequency	50 / 60 Hz
Limit Values 0-Signal UL 0-Signal IL	40 VAC Max. 15 mA
Delay 0 to 1	Max. 50 msec
Delay 1 to 0	Max. 50 msec
Power Consumption Internal External	Max. 4 W Max. 7 W
Operating Characteristics	
Isolation Voltage under Normal Operating Conditions between Channel and Bus	2500 VAC
Different Circuits Possible	YES (but not different phases)
Mechanical Characteristics	
Dimensions	B&R 2010 single width

Digital Input Module

DI825

Order Data

Model Number	Description	Figure
2DI825.6	2010 Digital Input Module, 8 Namur Inputs, Ex(i), 12 V, 12 mA, Electrically Isolated, Order Terminal Blocks Separately!	
2TB120.9	2010 Terminal block, 20 pin, screw clamps	

Technical Data

Module ID	DI825
General	
C-UL-US Listed	in preparation
Module Rack	BP200, BP201, BP210
Static Characteristics	
Module Type	B&R 2010 I/O module
Number of Inputs	8
No Load Voltage	8.05 V \pm 5%
Maximum Values Per Input Circuit ¹⁾	
Maximum Voltage	12 V
Maximum Current	12 mA
Maximum Power	36 mW
Maximum Values for Ignition Protection [Ex ia] IIC	
Max. External Capacitance	0.5 μ F
Max. External Inductance	2 mH
Internal Resistance	Approx. 1 k Ω
Open Line Recognition	
Switching Range	50 μ A to 350 μ A
Hysteresis	Typ. 0.15 mA
Short Circuit Recognition	
Switching Range	100 Ω to 360 Ω
Hysteresis	Typ. 100 Ω
Switching Threshold	
Switching Range	1.2 mA to 2.1 mA
Hysteresis	Typ. 0.5 mA
Delay 0 to 1	Max. 100 μ sec
Delay 1 to 0	Max. 100 μ sec
Power Consumption	Max. 11 W
Operating Characteristics	
Isolation	
Input – PCC	YES / Max. Peak Value of Nominal Voltage: 375 V
Input – Input	YES / Max. Peak Value of Nominal Voltage: 375 V
Inherent Safety	YES
Mechanical Characteristics	
Dimensions	B&R 2010 single width

¹⁾ Maximum values per Input Circuit according to European Standard EN 50020.

General Information

The DI825 module is used for getting signals from areas of hazardous explosives to other areas which are not hazardous. The area of application requires that the input current of the module is controlled according to ignition protection standard **[EEx ia] IIC**.

Standards

The DI825 module conforms to all of the standards that the other B&R 2000 generation modules conform to as well as the European standard for „Electronic Equipment for Hazardous Locations“:

EN 50014: 1977 + A1 ... A5 (VDE 0170/0171 Part 1 Withdrawn)

Electronic Equipment for Hazardous Locations, General Requirements

EN 50020: 1977 + A1 ... A2 (VDE 0170/0171 Part 1 Withdrawn)

Electronic Equipment for Hazardous Locations, Intrinsic Safety "I"

Digital Output Modules

General Information

Digital output modules are used for controlling external loads (relays, motors, solenoid valves). The output states are displayed by status LEDs.

The main differences to watch for between the various output modules are:

- Number of Outputs
- Type (relay, transistors, triac)
- Switching Voltage
- Continuous Current

Protective Circuit

The transistor output modules DO428 and DO430 have overload protection circuits and internal wiring protecting against spikes or reversed polling. Inductive loads can be quickly switched using a braking voltage without external inverse diodes.

Overview

Module	DO428	DO430	DO600	DO700	DO710
Number of Outputs	32	32	32	16	16
Type	Transistor	Transistor	Relay	Relay	Relay
Switching Voltage	24 VDC	24 VDC	24 VDC / 100 VAC	24 VDC / 230 VAC	30 VDC / 240 VAC
Continuous Current	Max. 0.5 A	Max. 2 A	Max. 2 A	Max. 2 A	Max. 4 A

Digital Output Modules

DO428 / DO430

Order Data

Model Number	Description	Figure
2DO428.6	2010 Digital output module, 32 transistor outputs 24 VDC, 0.5 A, 4 electrically isolated output groups. Order terminal block separately!	
2DO430.6	2010 Digital output module, 32 transistor outputs 24 VDC, 2 A, 4 electrically isolated output groups. Order terminal block separately!	
2TB140.9	2010 Terminal block, 40 pin, screw clamps	

Technical Data

Module ID	DO428	DO430
General		
C-UL-US Listed	YES	
Module Rack	BP200, BP201, BP210	
Static Characteristics		
Module Type	B&R 2010 I/O module	
Number of Outputs Total In 4 Groups of	32 8	
Type	Transistor	
Switching Voltage Minimum Nominal Maximum	18 VDC 24 VDC 30 VDC	
Continuous Current Per Output Per Group Per Module	Max. 0.5 A Max. 4 A Max. 16 A	Max. 2 A Max. 12 A ¹⁾ Max. 48 A
Leakage Current when Switched Off	0.3 mA	Max. 1.5 mA
Power Consumption Internal Terminal Side at 24 V	Max. 5 W Max. 2 W per group	Max. 2.9 W
Protection Characteristics		
Protective Circuit Internal External	YES Only if necessary (surge)	
Dynamic Characteristics		
Switching Delay log. 0 - log. 1 log. 1 - log. 0	Typ. 5 µsec / max. 110 µsec Typ. 60 µsec / max. 100 µsec	Max. 100 µsec Max. 100 µsec
Switching Frequency (resistive load)	Max. 500 Hz	
Operating Characteristics		
Isolation Output - PCC Group - Group Output - Output	YES YES NO	
Mechanical Characteristics		
Dimensions	B&R 2010 single width	

¹⁾ Simultaneusness factor = 75 %:
Maximum 24 of the 32 outputs can be fully loaded at the same time.

Digital Output Modules

DO600 / DO700

Order Data

Model Number	Description	Figure
DO600		
2DO600.6	2010 Digital output module, 32 relay outputs 120 VAC / 24 VDC, 2 A, 8 electrically isolated output groups. Order terminal block separately!	
2TB140.9	2010 Terminal block, 40 pin, screw clamps	
DO700		
2DO700.6	2010 Digital output module, 16 relay outputs 230 VAC / 24 VDC, 3 A, 4 electrically isolated output groups. Order terminal block separately!	
2TB120.9	2010 Terminal block, 20 pin, screw clamps	

Technical Data

Module ID	DO600	DO700
General		
C-UL-US Listed	YES	
Module Rack	BP200, BP201, BP210	
Static Characteristics		
Module Type	B&R 2010 I/O module	
Number of Outputs Total In 8 / 4 Groups of	32 4	16 4
Type	Relay / N.O.	
Switching Voltage Nominal Maximum	120 VAC / 24 VDC 144 VAC / 30 VDC	230 VAC / 24 VDC 250 VAC / 30 VDC
Continuous Current Per Output Per Group Per Module	Max. 2 A Max. 8 A Max. 32 A	Max. 3 A Max. 8 A Max. 16 A
Switching Power Minimum Maximum	1 mA / 5 VDC 750 VA / 90 W	1 mA / 5 VDC 750 VA / 90 W
Switching Frequency (nominal load)	Max. 10 Hz	
Power Consumption	Max. 8 W	Max. 6 W
Protective Characteristics		
Short Circuit Protection	Fuse 10 A (at least 8 A) slow-blow per group	
External Protective Circuit	Generally required	
Dynamic Characteristics		
Switching Delay	Approx. 10 msec	
Operating Characteristics		
Isolation Output – PCC Group – Group Output – Output	YES YES NO	
Mechanical Characteristics		
Dimensions	B&R 2010 single width	

Digital Output Module

DO710

Order Data

Model Number	Description	Figure
2DO710.6	2010 Digital output module, 16 relay outputs 240 VAC / 30 VDC, 4 A, Single channel isolated outputs. Order terminal block separately!	
2TB140.9	2010 Terminal block, 40 pin, screw clamps	

Technical Data

Module ID	DO710
General	
C-UL-US Listed	YES
Module Rack	BP200, BP201, BP210
Static Characteristics	
Module Type	B&R 2010 I/O module
Number and Type of Outputs	8 change-over / 8 N.O., Single channel isolated outputs
Rated Voltage	30 VDC / 240 VAC
Switching Voltage Range	Min. 5 VDC at 1 mA
Rated Frequency	DC or 45 - 63 Hz
Rated Current (1-Signal)	4 A (resistive load)
Switching Power	2000 VA; 120 W at 30 VDC (resistive load)
Wiring	8 change-over / 8 N.O.
Power Consumption Internal External	Max. 7 W Max. 8 W
Protective Characteristics	
Type of Protection	
Short Circuit Protection AC DC	Fuse 8 A slow-blow (required externally) Fuse 4 A slow-blow (required externally)
Overvoltage Protection for the Contacts	Limited to 460 V (required externally)
DC Connection	Spark suppression if necessary (wired externally)
Dynamic Characteristics	
Output Delay for Signal Transition from log 0 - log 1 log 1 - log 0	Max. 13 msec (incl. chatter time) Max. 13 msec (incl. chatter time)
Operating Characteristics	
Total Output Current	Max. 64 A
Following Conditions must be Fulfilled	$\Sigma I_n^2 \leq 400$
Wire Cross Section	2.5 mm ² , for currents ≥ 4 A or if one of the values listed is reached
Isolation Voltage under Normal Operating Conditions between Channel and Bus	1 minute 2800 VAC or 4 kV at 1.2 x 50 μ sec pulse
Different Phases Possible	YES, but only for 110 VAC
Mechanical Characteristics	
Dimensions	B&R 2010 single width

Analog Input Modules

General Information

Analog input modules are used to convert measurement values (voltage, current) into numerical values which can be processed in the PCC.

Analog data is stored in the PCC in 16 bit 2's complement, irrespective of the resolution. This means that while creating the application program, no reference needs to be made to the resolution of the module (step count).

All analog input modules have a „RUN“ status LED. This indicates that the A/D converter is running.

Overview

Module	AI300	AI700	AI730
Number of Inputs	16	16	8
Input Signal	±10 V	±20 mA	0 to 25 mA
Digital Converter Resolution	12 Bit	12 Bit	16 Bit

Analog Input Modules

AI300 / AI700

Order Data

Model Number	Description	Figure
2AI300.6	2010 Analog input module, 16 inputs, +/- 10 V, 12 Bit. Order terminal block separately!	
2AI700.6	2010 Analog input module, 16 inputs, +/- 20 mA, 12 Bit. Order terminal block separately!	
2TB140.9	2010 Terminal block, 40 pin, screw clamps	

Technical Data

Module ID	AI300	AI700
General		
C-UL-US Listed	YES	
Module Rack	BP200, BP201, BP210	
Static Characteristics		
Module Type	B&R 2010 I/O module	
Number of Inputs	16	
Input Signal Nominal Min./Max. Allowed	-10 to +10 V -20 to +20 V	-20 to +20 mA -30 to +30 mA
Digital Converter Resolution	12 Bit	
Differential Input Resistance	1 M Ω	
Load		50 Ω
Voltage Drop at 20 mA		1 V
Power Consumption	Max. 9 W	
Operating Characteristics		
Isolation Input – PCC Input – Input	YES NO	
Mechanical Characteristics		
Dimensions	B&R 2010 single width	

Analog Input Module

AI730

Order Data

Model Number	Description	Figure
2AI730.6	2010 Analog input module, 8 inputs, 0 - 25 mA, 16 bit, Isolation between individual channels. Order terminal block separately!	
2TB140.9	2010 Terminal block, 40 pin, screw clamps	

Technical Data

Module ID	AI730
General	
C-UL-US Listed	YES
Module Rack	BP200, BP201, BP210
Static Characteristics	
Module Type	B&R 2010 I/O module
Input Type	Current signal 0 - 25 mA
Number of Inputs	8
Encoder Supply Voltage Current	18 - 30 VDC Max. 30 mA
Shared Potential between Channels	none (single channel isolation)
Protects all Channels against Incoming Voltage and Reverse Polarity	Up to 42 VDC
Digital Convert Resolution	16 Bit
Input Impedance in Signal Range	Max. 130 Ω
Power Consumption	Max. 6 W + 1 W for each internally supplied encoder
Operating Characteristics	
Working Voltage Channel to Ground Channel to Channel Channel to Shield	Max. 300 V _{eff} Max. 600 V _{eff} Max. 300 V _{eff}
Pulse Dielectric Strength at 2000 m above Sea Level Channel to Ground Channel to Channel Channel to Shield	4000 V 4000 V 2500 V
Mechanical Characteristics	
Dimensions	B&R 2010 single width

Analog Output Modules

General Information

Analog output modules convert PCC internal numerical values into voltage or current. The numerical values which are to be converted must be in 16 bit 2's Complement. The conversion is made without having to reference the resolution of the output module used.

All analog output modules have a status LED labeled „RUN“. This indicates that the D/A conversion is running.

Overview

Module	AO300	AO725	AO900
Number of Outputs	16	8	16
Output Signal	± 10 V	0 to 20 mA	± 10 V / 0 to 20 mA
Digital Converter Resolution	12 Bit	12 Bit	12 Bit

Analog Output Modules

AO300 / AO725 / AO900

Order Data

Model Number	Description	Figure
2AO300.6	2010 Analog output module, 16 outputs, +/- 10 V, 12 Bit. Order terminal block separately!	
2AO725.6	2010 Analog output module, 8 outputs, 0 to 20 mA, 12 Bit. Order terminal block separately!	
2AO900.6	2010 Analog output module, 8 outputs, +/- 10 V, 12 Bit, 8 outputs, 0 to 20 mA, 12 Bit. Order terminal block separately!	
2TB140.9	2010 Terminal block, 40 pin, screw clamps	

Technical Data

Module ID	AO300	AO725	AO900
General			
C-UL-US Listed	YES		
Module Type	B&R 2010 I/O module		
Module Rack	BP200, BP201, BP210		
Number of Outputs	16	---	8
Voltage Outputs	---	---	8
Current Outputs	---	8	---
Output Signal	-10 to +10 V	---	-10 to +10 V
Voltage	---	---	0 to 20 mA
Current	---	0 to 20 mA	0 to 20 mA
Digital Converter Resolution	12 Bit		
Power Consumption	Max. 10 W		Max. 12 W
Operating Characteristics			
Isolation	YES		
Output – PCC	NO		
Output – Output	NO		
Voltage Outputs			
Max. Load per Output	±10 mA (load ≥1 kΩ)	---	±10 mA (load ≥1 kΩ)
Current Output			
Load	---	Max. 600 Ω	Max. 600 Ω
Mechanical Characteristics			
Dimensions	B&R 2010 single width		

Temperature Modules

General Information

Temperature modules are used to convert temperature measurement values into numerical values which can be processed in the PCC.

Numerical values are stored in the PCC in 16 bit 2's complement, irrespective of the resolution. This means that while creating the application program, no reference needs to be made to the resolution of the temperature module (step count).

The temperature module sends measurement values in 0.1 °C steps for temperature measurements. This means that a result of 750 corresponds to 75.0 °C. Data format 0.1 °C is supported by all temperature modules. Some temperature modules also support other formats.

All temperature modules have a „RUN“ status LED. This indicates that the A/D converter is running.

Overview

Module	AT300	AT610
Number of Channels	8	16
Measurement Range	-50 to +450 °C	-200 to +950 °C / -200 to +1300 °C
Sensor	PT100 / 3 wire	FeCuNi Sensor (Type J + L) NiCrNi Sensor (Type K)
Resolution	20000 steps	Internal > 14 Bit

Temperature Module

AT300

Order Data

Model Number	Description	Figure
2AT300.6	2010 Analog input module, 8 inputs, PT100 (3 line connection), -50 to +450 °C. Order terminal block separately!	
2TB140.9	2010 Terminal block, 40 pin, screw clamps	

Technical Data

Module ID	AT300
General	
C-UL-US Listed	YES
Module Rack	BP200, BP201, BP210
Static Characteristics	
Module Type	B&R 2010 I/O module
Number of Inputs Total in 2 Groups of	8 inputs to measure resistance 4
Sensor Type Connection Standard	PT100 3 line connection IEC/EN 60751
Measurement Range	-50 to +450 °C
Resolution	internally 20000 steps
Measurement Current	2 mA (±0.2 %)
Power Consumption	Max. 9 W
Operating Characteristics	
Isolation Input – PCC Group – Group Input – Input	YES YES NO
Mechanical Characteristics	
Dimensions	B&R 2010 single width

Temperature Module

AT610

Order Data

Model Number	Description	Figure
2AT610.6	2010 Analog input module, 16 inputs, temperature sensors, Type L/J/K, -200 to +1300 °C. Order terminal block separately!	
2TB140.9	2010 Terminal block, 40 pin, screw clamps	

Technical Data

Module ID	AT610		
General			
C-UL-US Listed	YES		
Module Rack	BP200, BP201, BP210		
Static Characteristics			
Module Type	B&R 2010 I/O module		
Number of Inputs	16 differential inputs for thermocouples		
Input Groups Group 1 Group 2 Group 3 Group 4	4 groups Channels 1 - 4 Channels 5 - 8 Channels 9 - 12 Channels 13 - 16		
Input Signal Nominal Allowed	-15 to +55 mV -20 to +20 V		
Input Impedance in Signal Range	>1 MΩ		
Digital Converter Resolution	Internal >14 Bit (23841 internal ADC values in 20 msec) ¹⁾		
Temperature Determination of the Internal Compensation	Temperature profile measurement on module with 4 temperature sensors Compensation temperature determined separately for each channel		
Power Consumption	Max. 8 W		
Operating Characteristics			
Isolation Input – PCC Group 1 – Group 3 Group 2 – Group 4 Groups 1 + 3 – Groups 2 + 4 Input – Input (same Group)	YES NO NO YES NO		
Max. Modulation Compared to Ground Between 2 Electrically Isolated Groups	±50 V ±50 V		
Sensor			
Sensor Selection	Set individually for each group		
Model	FeCuNi	FeCuNi	NiCrNi
Type	L	J	K
Standard	DIN 43710	DIN IEC 584	DIN IEC 584
Measurement Voltage Range ²⁾	-8.15 to 53.14 mV	-7.89 to 54.95 mV	-5.891 to 52.398 mV
Measurement Range	-200.0 to +900.0 °C	-200.0 to +950.0 °C	-200.0 to +1300.0 °C

Module ID	AT610
Step Size	0.1 °C
Linearization	YES
Compensation Measurement Internal External (can be set)	-20 to +90 °C -100 to +200 °C
Raw Value Measurement	
Selection	Set individually for each group
Scaling	Standardized to 2 µV
Measurement Voltage Range	-15 to +55 mV
Measurement Range	According to sensor type
Linearization	in CPU
Compensation Measurement Internal External	Can be read ---
AT600 Operation	
Sensor Model Type Standard Meas. Range (0.1 °C steps) Linearization Terminal Temperature Compensation	FeCuNi L DIN 43710 -50.0 to +750.0 °C YES -20 to +90 °C from internal compensation measurement
Mechanical Characteristics	
Dimensions	B&R 2010 single width

¹⁾ The internal resolution varies according to the measurement time. However, the conversion value is always scaled to 20 msec, so a change in value can be avoided during measurement!

²⁾ Standardized to 0 °C compensation temperature.

Other Modules

General Information

The universal mixed module is a combination of digital input/output modules and analog input/output modules.

The state of the digital inputs or outputs is shown on Status LEDs. A „RUN“ status LED shows that D/A and A/D conversion is taking place.

Module	UM900	
Digital Inputs		
Number of Inputs	8	
Nominal Input Voltage	24 VDC	
Switching Delay	1 msec	
Digital Outputs		
Number of Outputs	8	
Switching Voltage	24 VDC	
Continuous Current	0.5 A	
Analog Inputs		
Number of Inputs	4	
Input Signal ¹⁾	±10 V	0 to 20 mA
Digital Converter Resolution	12 Bit	12 Bit
Analog Outputs		
Number of Outputs	2	
Output Signal ²⁾	±10 V	0 to 20 mA
Digital Converter Resolution	12 Bit	11 Bit

¹⁾ Measurement range can be set with software.

²⁾ Voltage/current according to the connection.

Other Module

UM900

Order Data

Model Number	Description	Figure
2UM900.6	2010 Universal mixed module, 8 inputs, 24 VDC, 1 msec, 8 transistor outputs, 24 VDC, 0.5 A, 4 inputs, 12 Bit, +/- 10 V or 0 to 20 mA, 2 outputs, 12 or 11 Bit, +/- 10 V or 0 to 20 mA. Order terminal block separately!	
2TB140.9	2010 Terminal block, 40 pin, screw clamps bklomme	

Technical Data

Module ID	UM900
General	
C-UL-US Listed	YES
Module Type	B&R 2010 I/O module
Module Rack	BP200, BP201, BP210
Inputs / Outputs	8 digital inputs, 8 digital outputs 4 analog inputs, 2 analog outputs
Power Consumption	Max. 8 W
Operating Characteristics	
Isolation	
Input – PCC	YES
Output - PCC	YES
Group 1 – Group 2	YES
Analog - Digital	YES
Digital Inputs	
Number of Inputs	8
Total	8
in 2 Groups of	4
Rated Voltage	24 VDC
Wiring	Sink
Delay 0 to 1	Typ. 1 msec / max. 1.2 msec
Delay 1 to 0	Typ. 1 msec / max. 1.2 msec
Input Current at Nominal Voltage	5 mA
Digital Outputs	
Number of Outputs	8
Total	8
in 2 Groups of	4
Type	Transistor
Rated Current	0.5 A
Rated Voltage	24 VDC
Switching Voltage Range	18 – 30 VDC
Leakage Current (0-Signal)	0.3 mA
Wiring	Source

Module ID	UM900	
External Protective Circuit	Only if required (surge)	
Short Circuit and Overload Protection	YES	
Delay 0 to 1	Typ. 5 µsec / max. 110 µsec	
Delay 1 to 0	Typ. 60 µsec / max. 100 µsec	
Total Output Current	4 A	
Analog Inputs		
Number of Inputs	4	
Measurement Range ¹⁾	±10 V	0 to 20 mA
Digital Converter Resolution	12 Bit	
Input Impedance in Signal Range	Approx. 1 MΩ	50 Ω
Analog Outputs		
Number of Outputs	2	
Output Signal ²⁾	±10 V	0 to 20 mA
Digital Converter Resolution	12 Bit	11 Bit
Load Impedance	Min. 1 kΩ	Max. 600 Ω
Mechanical Characteristics		
Dimensions	B&R 2010 single width	

¹⁾ Measurement range can be set using software.

²⁾ Signal corresponds to connection.

Communication Modules

General Information

Module	Description
IF100	2010 Interface module, 64 + 404 KB SRAM, 256 KB FlashPROM, 1 RS232 interface, 1 electrically isolated RS232/TTY, 1 RS485/RS422 interface, electrically isolated, network-capable, 1 CAN interface, electrically isolated, network-capable
IF101	2010 Interface module, 64 + 404 KB SRAM, 256 KB FlashPROM, 1 RS232 interface, 1 electrically isolated RS232/TTY, 1 RS485/RS422 interface, electrically isolated, network-capable, 1 CAN interface, electrically isolated, network-capable, 1 ETHERNET interface, BNC connector, electrically isolated, network-capable
NW100	2010 PROFIBUS network module, 2 electrically isolated RS485 interfaces. For connection to PROFIBUS networks

Communication Modules

IF100 / IF101

Order Data

Model Number	Description	Figure
Interface Modules		
2IF100.60-1	2010 Interface module, 64 + 404 KB SRAM, 256 KB FlashPROM, 1 RS232 interface, 1 electrically isolated RS232/TTY, 1 RS485/RS422 interface, electrically isolated, network-capable, 1 CAN interface, electrically isolated, network-capable	
2IF101.60-1	2010 Interface module, 64 + 404 KB SRAM, 256 KB FlashPROM, 1 RS232 interface, 1 electrically isolated RS232/TTY, 1 RS485/RS422 interface, electrically isolated, network-capable, 1 CAN interface, electrically isolated, network-capable, 1 ETHERNET interface, BNC connector, electrically isolated, network-capable	
Accessories		
0G0001.00-090	Cable PC <-> PCC/PW, RS232, online cable	
7AC911.9	Bus connector, CAN	
0AC912.9	Bus adapter, CAN, 1 CAN interface	
0AC913.92	Bus adapter, CAN, 2 CAN interfaces, incl. 30 cm connection cable	
0G1000.00-090	Bus connector, RS485, for PROFIBUS networks, remote I/O	
0AC916.9	Bus connector, RS485, active. For PROFIBUS networks, remote I/O, Standard mounting rail, Supply voltage: 120 / 230 VAC	
Software (for IF101, ETHERNET)		
1A2205.01	B&R SYSTEM 2000 Standard Software, TCP/IP Library	
Additional information concerning accessories can be found in sections "Accessories" and "Manuals".		

Technical Data

Module ID	IF100	IF101
General		
C-UL-US Listed	YES	
Module Type	B&R 2010 system module, single width	
Module Rack	BP101, BP110	
Power Consumption	Max. 7 W	
Processor		
Dual Ported RAM (DPR)	64 KByte SRAM (unbuffered)	
User RAM	404 KByte SRAM (unbuffered)	
System RAM	108 KByte SRAM (unbuffered)	
PROM User PROM System PROM	256 KByte FlashPROM 256 KByte FlashPROM	
Application Interface IF1		
Type	RS232	
Connection	9 pin D-type connector (M)	
Isolation	NO	
Controller	RISC (68302)	
Maximum Distance	15 m / 19200 Baud	
Maximum Baudrate	64 kBaud	
Bus Capable	NO	

Module ID	IF100	IF101
Application Interface IF2		
Type	RS232/TTY	
Interface Selection	Using software	
Connection	9 pin D-type connector (M)	
Isolation	YES	
Controller	RISC (68302)	
Maximum Distance RS232 TTY	15 m / 19200 Baud 300 m	
Maximum Baudrate RS232 TTY	64 kBaud 64 kBaud	
Bus Capable	NO	
Application Interface IF3		
Type	RS485/RS422	
Interface Selection	Using Software	
Connection	9 pin D-type connector (F)	
Isolation	YES	
Controller	RISC (68302)	
Maximum Distance	1200 m	
Maximum Baudrate	347 kBaud	
Bus Capable	YES	
Busankopplung	T-connector (model number 0G1000.00-090)	
Application Interface IF4		
Type	CAN	
Connection	9 pin D-type connector (M)	
Isolation	YES	
Controller	Intel Controller 82527	
Maximum Distance	1000 m	
Maximum Baudrate Bus Length 10 - 60 m Bus Length 100 - 200 m Bus Length 800 - 1000 m	500 kBit/sec 250 kBit/sec 50 kBit/sec	
Busfähig	YES	
Busankopplung	T-connector (model number 7AC911.9)	
Application Interface IF5 (only IF101)		
Type	ETHERNET	
Connection	10BASE2 CHEAPERNET BNC socket	
Isolation	YES	
Controller	AM79C960	
Maximum Baudrate	10 MBit/sec	
Bus Capable	YES	
Bus Coupling	Coax-T	

Communication Module

NW100

Order Data

Model Number	Description	Figure
	PROFIBUS Network Module	
2NW100.50-1	2010 PROFIBUS Network Module, 2 electrically isolated RS485 interfaces. For connecting to PROFIBUS networks	
	Accessories	
0G1000.00-090	Bus connector, RS485, for PROFIBUS networks, remote I/O	
0AC916.9	Bus connector, RS485, active. For PROFIBUS networks, remote I/O, Standard mounting rail, Supply voltage: 120 / 230 VAC	
Additional information concerning accessories can be found in sections "Accessories" and "Manuals".		

Technical Data

Module ID	NW100
General	
C-UL-US Listed	YES
Module Type	B&R 2010 system module, single width
Module Rack	BP101, BP110
Power Consumption	Max. 15 W
Peripherals	
Diagnosis LEDs	YES
Number Switch	Four – to set module address, station address and baudrate
Standard Communication Interface	
Interface Type Connection Isolation Baudrates 9.6 kBit/sec 19.2 kBit/sec 93.75 kBit/sec 187.5 kBit/sec 500 kBit/sec	2 x RS485 2 x 9 pin D-type connector (F) YES Depends on the distance max. 1200 m max. 1200 m max. 1200 m max. 1000 m max. 400 m
PROFIBUS Data Transfer Protocol Access Number of Stations Topology Bus Coupling Transfer Media	PROFIBUS standard, DIN 19245 part 1 and 2 Token passing principle with underlying master/slave principle Max. 127 (with repeater) Physical bus Direct Shielded, twisted pair

Counter and Positioning Modules

General Information

Module	Description
NC303	2010 Ultrasonic transducer module, 1 pulse encoder input, 700 Hz, 24 VDC, 4 ultrasonic transducer inputs, 56 MHz, 4 digital inputs 24 VDC, 10 msec, sink, 4 transistor outputs 24 VDC, 1 A, 4 analog inputs 0 to 10 V, 12 bit, 5 analog outputs +/- 10 V, 12 bit. Order terminal block separately!

Counter and Positioning Module

NC303

Order Data

Model Number	Description	Figure
2NC303.60-1	2010 Ultrasonic transducer module, 1 pulse encoder input, 700 Hz, 24 VDC, 4 ultrasonic transducer inputs, 56 MHz, 4 digital inputs 24 VDC, 10 msec, sink, 4 transistor outputs 24 VDC, 1 A, 4 analog inputs 0 to 10 V, 12 bit, 5 analog outputs +/- 10 V, 12 bit. Order terminal block separately!	
2TB140.9	2010 Terminal block, 40 pin, screw clamps	

Technical Data

Module ID	NC303
General	
C-UL-US Listed	YES
Module Type	B&R 2010 I/O module
Module Rack	BP200, BP201, BP210
Power Consumption	21 W + 1.5 x encoder power
Processor	
Communication	RISC
Instruction Cycle Time	0.8 µsec
Dual Ported RAM (DPR)	384 Byte SRAM (unbuffered)
System RAM	256 KByte SRAM (unbuffered)
Encoder Supply	
Ultrasonic Transducer with Differential Signals Supply Encoder Supply Voltage Current Capacity	Internal 24 V ±10 % Max. 160 mA
Pulse Encoder Supply	External
Pulse Encoder Input	
Use	For RPM measurement (pulse counting, gate time measurement)
Input Voltage Nominal Maximum	24 VDC 30 VDC
Input Resistance	4.5 kΩ
Switching Threshold LOW Range Switching Range HIGH Range	<5 V 5 to 15 V >15 V
Pulse Frequency	Max. 700 Hz
Gate Measurement Resolution	7.69 µsec
Isolation	YES (optocoupler)
Channels for Path Measurement	
Encoder Type	Ultrasonic transducer with Start/Stop interface (differential signal)

Module ID	NC303
Number of Channels	4
Input Resistance	500 Ω
Two Magnet Measurement	Only possible for channel 1
Input and Output Signals	Differential level
Internal Counter Frequency	56 MHz (positive edge)
Counter Size	21 Bit
Start Pulse Duration	Approx. 1 μsec
Pulse Ignored after Start Pulse	Approx. 18 μsec
Path Measurement Resolution	0.05 mm (ultrasonic transducer speed = 2800 m/sec)
Isolation Channel – PCC Channel – Channel	YES (optocoupler) NO
Analog Inputs	
Number of Inputs	4 voltage inputs
Input Signal Nominal Min./Max. Allowed	0 to +10 V -20 V to +20 V
Digital Converter Resolution	12 Bit
Differential Input Resistance	>900 kΩ
Isolation Input – PCC Input – Input	YES (optocoupler) NO
Analog Outputs	
Number of Outputs	5 voltage outputs
Output Signal	-10 V to +10 V
Digital Converter Resolution	12 Bit
Max. Load per Output	10 mA (≥1 kΩ)
Isolation Output – PCC Output – Output	YES (optocoupler) NO
Digital Inputs	
Number of Inputs	4
Wiring	Sink
Input Voltage Nominal Maximum	24 VDC 30 VDC
Input Current at Nominal Voltage	Approx. 5.7 mA
Input Resistance	1.5 kΩ
Switching Threshold LOW Range Switching Range HIGH Range	<5 V 5 to 11 V >11 V
Switching Delay log. 0 - log. 1 log. 1 - log. 0	10 msec 10 msec
Isolation Input – PCC Input – Input	YES (optocoupler) NO

Module ID	NC303
Digital Outputs	
Number of Outputs	4
Type	Transistor
Wiring	Sink
Supply Voltage (external) Nominal Maximum	24 VDC 30 VDC
Continuous Current per Output	Max. 1 A
Residual Voltage of Transistors	Max. 0.5 V (at 1 A)
Overload and Short Circuit Protection ¹⁾	Polymer-PTC protective element (Polyswitch™) ²⁾
Switching Delay log. 0 - log. 1 log. 1 - log. 0	Entry for resistive load ≤100 µsec ≤100 µsec
Switching Frequency (resistive load)	Max. 500 Hz
Isolation Output – PCC Output – Output	YES (optocoupler) NO
Mechanical Characteristics	
Dimensions	B&R 2010 double width

¹⁾ Every digital output uses a Polymer PTC protection device for overload and short circuit protection. If an overload or a short circuit occurs, the PTC is set to high resistance and breaks the current loop. To reactivate the output, the external supply must be switched off and the error (overload or short circuit) must be corrected. After a reset time of > 10 seconds, the protection device is set back to normal.

²⁾ Polyswitch™ is a registered trademark of RAYCHEM.

General Information

The intelligent I/O processor module NC303 is a programmable I/O module with four channels for distance measurement, and one channel for RPM measurement (rotation and speed are measured with pulse counting and gate time measurement). When software is installed, the module's distance processor carries out the distance measurement on its own, and at the same time does a plausibility check and measures the rotation measurements. The data from the distance and rotation calculations is stored in DPR (Dual Port RAM) and can be read cyclically by the PCC CPU.

Parameters for distance and rotation measurement can be defined by the user with function blocks, which are easy to use. The respective software (including all documentation) can be obtained from B&R.

Accessories

General Information

Model Number	Description
2BM100.9	2010 Dummy module
2TB120.9	2010 Terminal block, 20 pin, screw clamps
2TB140.9	2010 Terminal block, 40 pin, screw clamps

Accessories

BM100

Order Data

Model Number	Description	Figure
2BM100.9	2010 Dummy module	

General Information

Dummy modules are used for filling slots in which no functional modules are required. We recommend that you fill all unused slots with dummy modules, to further protect your system.

Accessories

TB120 / TB140

Order Data

Model Number	Description	Figure
2TB120.9	2010 Terminal block, 20 pin, screw clamps	
2TB140.9	2010 Terminal block, 40 pin, screw clamps	
<p>These double row terminal blocks are used for connecting most modules in the B&R 2010 control family.</p> <p>A six position coding mechanism prevents terminal blocks from accidentally being connected to the wrong module, e.g. during service checks or module replacements. A patented ejection lever mechanism makes terminal block insertion and removal quick and easy. Minimum effort is required for removal, even with the 40 pin terminal blocks.</p> <p>Each terminal block has an I/O cable stress relief.</p>		

Technical Data

Module ID	TB120	TB140
Number of Pins	20	40
Clamp Type	Screw clamp	
Distance between Contact Terminal / Terminal Left / Right Row	10.16 mm 6.38 mm	5.08 mm 6.38 mm
Creeping Distance Terminal / Terminal Left / Right Row	8.28 mm 4.5 mm	3.2 mm 4.5 mm
Nominal Voltage	250 VAC	
Current Load ¹⁾	Max. 12 A / contact	
Dielectric Strength Terminal / Terminal Left / Right Row	>5 kV 5 kV	3.5 kV 5 kV
Wire Cross Section	0.20 mm ² (AWG24) – 2.5 mm ² (AWG12)	
Cable Type	Only copper cable (no aluminum wires!)	
Removal	Mechanical	
Stress Relief	Cable ties	

¹⁾ The respective limit data for the I/O modules have to be taken into consideration!

Manuals

Overview

Model Number	Description
MASYS22010-0	B&R 2010 User's Manual, German
MASYS22010-E	B&R 2010 User's Manual, English

B&R SYSTEM 2000 Logic Scanner

Module Overview

Module ID	Description	Model No.	Page
	CPU		
LS251	Logic Scanner CPU LS251, 32 Bit Half Size PCI card, 2 MB DRAM, 1 MB SRAM, 512 KB FlashPROM, 1 Remote I/O Master (RS485), 1 CAN interface, both are isolated and network-capable	5LS251.60-1	271
	Communication Modules		
LS071	Logic Scanner Expansion Card LS071, 1 RS232 interface, 1 CAN interface, CAN: electrically isolated, network-capable	5LS071.9	275
LS079	Logic Scanner Expansion Card LS079, 1 RS232 Interface, 1 CAN Interface, CAN: Electrically Isolated, Network Capable, Supply through External 24 VDC Power Supply	5LS079.9	277
	Manuals		
MASYS2LS-0	Logic Scanner LS251 User's Manual, German	MASYS2LS-0	279
MASYS2LS-E	Logic Scanner LS251 User's Manual, English	MASYS2LS-E	279

General Information

More and more open and closed loop processes use hardware neutral standard PCs for visualization. Process data is collected in a central controller and uses either a point to point or network connection to transfer data. When using the Logic Scanner CPU LS251, the controller no longer has to handle data collection. The CPU comes in the form of a PCI bus card that can be used in every PC equipped with a PCI bus slot.

The CPU LS251 is equipped with an integrated, high performance PCC CPU. This CPU processes the complete controller program. A remote CPU is therefore not required on the PCC rack. Connections to the field inputs and outputs can be made using a CAN field bus or a remote I/O bus. The master function is taken over by the LS251.

B&R PCC Operating System

The control program can be processed completely independent of the performance demands for visualization using the high performance processor on the CPU LS251. The B&R PCC operating system guarantees stable, real time and deterministic multitasking, that is not influenced by the operating status of the visualization software or the PC operating system.

If a software reset is triggered with [Ctrl] + [Alt] + [Del], or the PC system comes to a stand still, this does not effect the logic scanner CPU LS251.

Compatibility

Programming is completely compatible with the B&R 2003, B&R 2005 and B&R 2010 systems. Existing programs can be used directly.

High Performance

Integrating the CPU and the CAN and remote I/O field bus connections on a slot card achieves the highest performance when accessing the inputs and outputs. Short cycle times up to 1 msec are possible.

Visualization

Visualization via the PC bus provides fast access to the process data. There is no pause during screen regeneration.

Additional Interfaces

The LS071 or LS079 expansion cards increase the interface possibilities by providing an extra RS232 and a CAN interface. The modules are connected to the CPU with flat ribbon cable.

External Power Supply of the Logic Scanner CPU

The LS079 enables the LS251 to have an external 24 VDC power supply. The power supply is then fully independent of the currently used PC.

CPU

LS251

Order Data

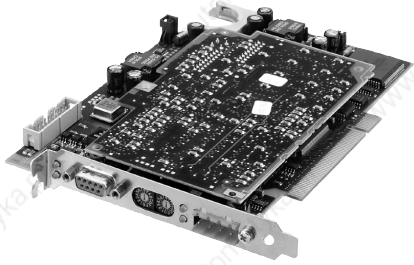
Model Number	Description	Figure
	CPU	
5LS251.60-1	Logic Scanner CPU LS251, 32 Bit Half Size PCI card, 2 MB DRAM, 1 MB SRAM, 512 KB FlashPROM, 1 Remote I/O Master (RS485), 1 CAN interface, both are isolated and network-capable	
	Accessories	
0G0001.00-090	Cable PC <-> PCC/PW, RS232, online cable	
0AC201.9	Lithium batteries, 5 pcs., 3 V / 950 mAh	
0G1000.00-090	Bus connector , RS485, for PROFIBUS networks, Remote I/O	
0AC916.9	Bus termination, RS485, active, For PROFIBUS networks, Remote I/O, Standard mounting rail installation, Supply Voltage: 120 / 230 VAC	
A lithium battery is included with the delivery of the LS251 CPU.		

The following expansion boards are available for the LS251 Logic Scanner CPU:

Model Number	Description
5LS071.9	Logic Scanner Expansion Card LS071, 1 RS232 interface, 1 CAN interface, CAN: electrically isolated, network-capable
5LS079.9	Logic Scanner Expansion Card LS079, 1 RS232 Interface, 1 CAN Interface, CAN: Electrically Isolated, Network Capable, Supply through External 24 VDC Power Supply

Additional information concerning manuals can be found in section "Manuals".

Technical Data

Module ID	LS251
General	
C-UL-US Listed	YES
Type	PCI Half Size Card Plug & Play
Power Consumption	
Without Expansion Card	Max. 7.75 W
With LS071	Max. 8.5 W
With LS079	Max. 13 W
Operating Temperature	0 - 55 °C
Processor	
Processor Architecture	32 Bit
Typical Instruction Cycle Time	0.2 µsec
Data and Program Code Cache	2 x 256 Byte
Standard Memory	
Working Memory	2 MByte DRAM
System RAM	174 KByte SRAM
User RAM	850 KByte SRAM
System PROM	512 KByte FlashPROM
User PROM	512 KByte FlashPROM
Data Buffering	
Buffer Battery	Lithium battery 3 V / 950 mAh
Battery Monitoring	YES
Duffer Duration	At least 4 years
Peripherals	
Real Time Clock	Nonvolatile
Resolution	1 sec
Status Display	LEDs
Interface Expansion	With LS071 expansion board or LS079 in neighboring slot, 1 x CAN, 1 x RS232

Module ID	LS251
Application Interface IF1	
Type	Remote I/O-Master (RS485)
Connection	9 pin D-type connector (F)
Isolation	YES
Baudrates 100 kBit/sec 181 kBit/sec 500 kBit/sec 1000 kBit/sec 2000 kBit/sec	Depends on the distance Max. 1200 m Max. 1000 m Max. 400 m Max. 200 m Max. 100 m
Access	Master/Slave principle
Number of Slaves	Max. 31 (without repeater)
Intelligent Slaves Possible with CPU	YES
Protocol Handling	Separate processor
Transfer Time	897 µsec for 64 digital I/O and 16 analog I/O
Topology	Physical bus
Bus Coupling	Direct
Transfer Media	Shielded, twisted pair
Network Capable	YES
Termination Resistance	External
Application Interface IF2	
Type	CAN
Isolation	YES
Connection	4 pin pin-block
Maximum Distance	1000 m
Maximum Baudrate Bus Length 10 - 60 m Bus Length 100 - 200 m Bus Length 800 - 1000 m	500 kBit/sec 250 kBit/sec 50 kBit/sec
Multimaster Capable	YES
Number of Stations	Max. 64 (without repeater)
Controller	Controller 82527
Priority	Via object identifier
Protocol	According to CiA/CAL
Transfer Media	4 conductor shielded cable, twisted pairs
Network Capable	YES
Termination Resistance	Optionally wired externally

RAM Buffering

RAM buffering (program and data memory) and nonvolatile operation of the real time clock is guaranteed using the lithium battery included in the delivery of the Logic Scanner.

PC Resources

PCI Bus

The LS251 Logic Scanner is a PCI bus insert card. The following points are decisive for the PCI bus:

- High speed data transfer
- 33 MHz transfer frequency
- 32 Bit data bus size
- Plug & Play

Plug & Play

Plug & Play technology simplifies start-up of the insert card. The BIOS recognizes PCI modules during the boot procedure and assigns their physical addresses. If a module is added or removed, the user does not have to change any settings.

Interrupt

The LS251 Logic Scanner uses an interrupt. It is automatically assigned by the Plug & Play technology during the boot procedure.

Memory

Memory is assigned automatically during the boot procedure. The following memory areas are used by the LS251 Logic Scanner:

Memory Size	Memory Area
1 x 1 MByte	Extended Memory (>1 MByte)
1 x 2 MByte	Extended Memory (>1 MByte)

Communication Modules

General Information

Model Number	Description
5LS071.9	Logic Scanner Expansion Card LS071, 1 RS232 interface, 1 CAN interface, CAN: electrically isolated, network-capable
5LS079.9	Logic Scanner Expansion Card LS079, 1 RS232 Interface, 1 CAN Interface, CAN: Electrically Isolated, Network Capable, Supply through External 24 VDC Power Supply

Communication Module

LS071

Order Data

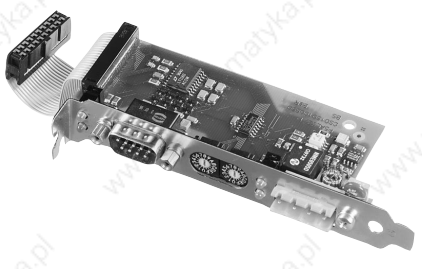
Model Number	Description	Figure
	Expansion Card	
5LS071.9	Logic Scanner Expansion Card LS071, 1 RS232 interface, 1 CAN interface, CAN: electrically isolated, network-capable	
	Accessories	
0G0001.00-090	Cable PC <-> PCC/PW, RS232, online cable	
Additional information concerning manuals can be found in section "Manuals".		

Technical Data

Module ID	LS071
General	
C-UL-US Listed	YES
Type	Mechanically inserted into slot neighboring the Logic Scanner LS251, however does not make contact with the PCI or ISA slot
Supply	LS071 is supplied by the LS251 over a flat ribbon cable
Power Consumption	Including LS251 max. 8.5 W
Operating Temperature	0 - 55 °C
Application Interface IF3	
Type	RS232
Controller	UART Typ ST16C650
FIFO	32 Byte in send and receive direction
Connection	9 pin D-type connector (M)
Isolation	NO
Input Filter / Protective Circuit	YES
Maximum Distance	15 m / 19200 Baud
Maximum Baudrate	115.2 kBaud
Handshake Lines	RTS, CTS
Network Capable	NO
Data Format	
Databits	5 to 8
Parity	Yes / No / Even / Odd
Stopbits	1 / 2
Application Interface IF4	
Type	CAN
Isolation	
IF4 – LS071	YES
IF3 – IF4	YES
Connection	4 pin pin-block
Maximum Distance	1000 m
Maximum Baudrate	
Bus Length 10 - 60 m	500 kBit/sec
Bus Length 100 - 200 m	250 kBit/sec
Bus Length 800 - 1000 m	50 kBit/sec
Multimaster Capable	YES
Number of Stations	Max. 64
Controller	Controller 82527

Module ID	LS071
Priority	Via object identifier
Protocol	According to CiA/CAL
Transfer Medium	4 conductor shielded cable, twisted pairs
Network Capable	YES
Termination Resistance	Optionally wired externally

General Information

The CPU LS251 is equipped with CAN and Remote I/O field bus connections. The LS071 Expansion Card increases the number of interfaces by an RS232 and a CAN interface. The module is connected to the LS251 using a flat ribbon cable.

Communication Module

LS079

Order Data

Model Number	Description	Figure
	Expansion Card	
5LS079.9	Logic Scanner Expansion Card LS079, 1 RS232 Interface, 1 CAN Interface, CAN: Electrically Isolated, Network Capable, Supply through External 24 VDC Power Supply	
	Accessories	
0G0001.00-090	Cable PC <-> PCC/PW, RS232, online cable	
Additional information concerning manuals can be found in section "Manuals".		

Technical Data

Module ID	LS079
General	
C-UL-US Listed	in preparation
Installation	Mechanically inserted in to the neighboring slot of the Logic Scanner, but has no contact with PCI or ISA slots
Supply External Internal	Via a 24 VDC Power Supply From LS251 through a Flat Ribbon Cable
External Power Supply, Voltage Range	18 - 30 VDC
Measurement Voltage	24 VDC
Fuse	Internal: 1.5 A Picofuse
Power Consumption of LS079 and LS251 External Supply Supply via PC	Max. 13 W Max. 13 W
Operating Temperature	0 - 55 °C
Application Interface IF3	
Type	RS232
Controller	UART Typ ST16C650
FIFO	32 Byte in send and receive direction
Connection	9 pin D-type connector (M)
Isolation	NO
Input Filter / Protection Switch	YES
Maximum Distance	15 m / 19200 Baud
Maximum Baudrate	115.2 kBaud
Handshake Lines	RTS, CTS
Network Capable	NO
Data Format Databits Parity Stopbits	5 to 8 Yes / No / Even / Odd 1 / 2
Application Interface IF4	
Type	CAN
Isolation IF4 – LS079 IF3 – IF4	YES YES
Connection	4 pin Connector
Maximum Distance	1000 m

Module ID	LS079
Maximum Baudrate Bus Length 10 - 60 m Bus Length 100 - 200 m Bus Length 800 - 1000 m	500 kBit/sec 250 kBit/sec 50 kBit/sec
Multimaster Capable	YES
Number of Stations	Max. 64
Controller	Controller 82527
Priority	Via object identifier
Protocol	According to CIA/CAL
Transfer Media	4 wire twisted pair cable
Network Capable	YES
Termination Resistance	Optional External Cable

General Information

The logic scanner LS251 is equipped with the field bus connections CAN and Remote I/O. The interface offer with the expansion card LS079 is extended to a RS232 and a CAN interface. The module is connected to the LS251 via a flat ribbon cable.

External Power Supply of the LS251

The expansion card LS079 enables the LS251 to be supplied via an external 24 VDC power supply. The power supply is connected to the LS079. The LS251 has its own power supply cable. This ensures that the power supply is fully independent of the used PC power supply.

In the case of external power supply failure, the logic scanner and expansion card are supplied by internal PC power supplies.

Manuals

Overview

Model Number	Description
MASYS2LS-0	Logic Scanner LS251 User's Manual, German
MASYS2LS-E	Logic Scanner LS251 User's Manual, English

General Accessories

General Information

Model Number	Description	Page
0AC001.9	Retaining clips, 500 pieces	---
0AC171.9	Glass fuses 5 x 20 mm, 20 pieces, 3.15 A T / 250 V	---
0AC200.9	Lithium Batteries, 5 pieces, 3 V / 950 mAh	---
0AC201.9	Lithium Batteries, 5 pieces, 3 V / 950 mAh	---
0AC401.9	Encoder 5 V - 24 V, converter for 5 V encoder (abs. or incr.)	282
0AC410.9	Interface converter TTY - RS232	282
0AC912.9	Bus adapter, CAN, 1 CAN interface	283
0AC913.92	Bus adapter, CAN, 2 CAN interfaces, incl. 30 cm connection cable	283
0AC916.9	Bus termination, RS485, active, For PROFIBUS networks, remote I/O, standard mounting rail, Supply voltage: 120 / 230 VAC	284
0G0001.00-090	Cable PC <-> PCC/PW, RS232, Online cable	284
0G0010.00-090	Cable I/O Bus expansion, 1 m, Bus expansion for B&R 2005 / B&R 2010	---
0G0012.00-090	Cable I/O Bus expansion, 2 m, Bus expansion B&R 2005 / B&R 2010	---
0G1000.00-090	Bus connector, RS485, PROFIBUS networks, remote I/O	---
0MC111.9	PCMCIA memory card, 2 MB FlashPROM	---
0MC211.9	PCMCIA memory card, 2 MB SRAM	---
7AC911.9	Bus adapter, CAN	285
ECINT1-1	RS232/RS485 interface converter, Electrically isolated, for coupling RS232 interface modules to an RS485 twisted pair network, Without lightning protection	286
ECINT1-11	RS232/RS485 interface converter, Electrically isolated, for coupling RS232 interface modules to an RS485 twisted pair network, With lightning protection	286

General Accessories

AC401

Order Data

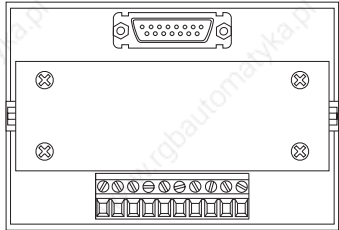
Model Number	Description	Figure
0AC401.9	Encoder 5 V - 24 V, converter for 5 V encoder (abs. or incr.)	

General Information

The adapter is used as a converter for the 5 V encoder. The 5 V differential signals delivered by the encoder are converted to 24 V signals. Absolute and incremental encoders can be used.

General Accessories

AC410

Order Data

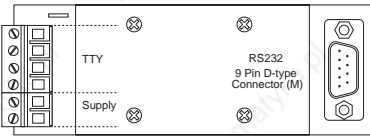
Model Number	Description	Figure
0AC410.9	Interface converter TTY - RS232	

General Information

The AC410 interface converter converts a TTY signal into an RS232 signal or an RS232 signal into a TTY-signal. In order to incorporate a PANELWARE operator panel (e.g. P120 or P121), a 5V output voltage is formed from the 24 V voltage supply. This voltage is resistant up to 0.5A

The maximum baudrate amounts to 19200 Baud.

General Accessories

AC912

Order Data

Model Number	Description	Figure
0AC912.9	Bus adapter, CAN, 1 CAN interface	

General Information

A CAN adapter is used to connect the controller to a CAN network. Networking is achieved using a 6 pin terminal strip. Connection to the controller is carried out with a 9 pin D-type connector (F). A terminal resistor is integrated into the bus adapter. The terminal resistor can be switched on or off. The controller bus adapter cable is not available from B&R and should be procured independently.

General Accessories

AC913

Order Data

Model Number	Description	Figure
0AC913.92	Bus adapter, CAN, 2 CAN interfaces, incl. 30 cm connection cable	

General Information

The CAN bus adapter can be used to connect a controller in a CAN network. The network connection is made via a 9 pin D-type plug (C1) and a 9 pin D-type socket (C2). A 30 cm cable with a D-type housing is connected to the 6 pin terminal. This cable is used for the connection to the controller. A termination resistance is built into the bus adapter. The termination resistance can be turned on or off.

General Accessories

AC916

Order Data

Model Number	Description	Figure
0AC916.9	Bus termination, RS485, active. For PROFIBUS networks, remote I/O, standard mounting rail, Supply voltage: 120 / 230 VAC	

General Information

An active bus termination is available for PROFIBUS networks and remote I/O. The active bus termination allows the network to be terminated independent of the communication module supply.

The supply voltage for the active bus termination is 120 / 230 VAC.

General Accessories

RS485 Bus Connector

Order Data

Model Number	Description	Figure
0G1000.00-090	Bus connector, RS485, PROFIBUS networks, remote I/O	

General Information

The RS485 bus connector is used to connect a controller to remote I/O, a PROFIBUS network or a RS485 network. The bus connector has an integrated termination resistance. The termination resistance can be turned on or off.

General Accessories

AC911

Order Data

Model Number	Description	Figure
7AC911.9	Bus adapter, CAN	

Technical Data

Module ID	AC911
Lines	Connections for two bus lines
Termination Resistance	120 Ω - can be switched on
Stress Relief	Integrated

General Information

The bus connector allows,

- a CAN node to be exchanged without interrupting the network because the connection is not broken,
- fast and simple adjustment of the termination resistance (e.g. if the last node in a network is to be removed).

General Accessories

INT1

Order Data

Model Number	Description	Figure
ECINT1-1	RS232/RS485 interface converter, Electrically isolated, for coupling RS232 interface modules to an RS485 twisted pair network, Without lightning protection	
ECINT1-11	RS232/RS485 interface converter, Electrically isolated, for coupling RS232 interface modules to an RS485 twisted pair network, With lightning protection	

General Information

The interface converter INT1 is used to convert RS232 interface signals to the RS485 signal level. It is used if:

- Data transfer over a long distance is required which cannot be bridged by an RS232 interface.
The distance between two stations can be a max. of 5000 m when using shielded RS485 cables.
- Electrical isolation is required for the interface.
- A PCC is to be connected to a network using an RS232 interface.

The interface converter INT1 has lightning protection.

Supply

The interface converter INT1 requires an external 24 VDC supply voltage. The current requirements can be max. 400 mA.

Index

A

Absolute Encoder Operation, NC161	96
AC010	98
AC011	98
AC240	198
AC401	282
AC410	282
AC911	285
AC912	283
AC913	283
AC916	284
Accessories	
B&R SYSTEM 2003	97
AC010	98
AC011	98
TB710	99
TB712	100
TB718	101
TB722	102
TB733	103
TB736	104
TB772	105
B&R SYSTEM 2005	196
AC240	198
BM150	199
Cable NC154 - PC	199
NiCd Rechargeable Battery	197
TB162	200
TB170	201
B&R SYSTEM 2010	266
BM100	267
TB120	268
TB140	268
Adapter Module	
B&R SYSTEM 2003	
AF101	44
Additional Interfaces	
Logic Scanner	270
AF101	44
AI261	71
AI294	72
AI300	247
AI350	163
AI351	73
AI354	74
AI375	163
AI700	247
AI730	248

AI775	163
AM050	167
AM051	168
AM055	169
AM374	170
Analog Input Modules	
B&R SYSTEM 2003	70
AI261	71
AI294	72
AI351	73
AI354	74
AI774	75
B&R SYSTEM 2005	162
AI350	163
AI375	163
AI775	163
B&R SYSTEM 2010	246
AI300	247
AI700	247
AI730	248
Analog Interface (AF) Module	
B&R SYSTEM 2003	
AF101	44
Analog Mixed Modules	
B&R SYSTEM 2005	166
AM050	167
AM051	168
AM055	169
AM374	170
Analog Output Modules	
B&R SYSTEM 2003	76
AO352	77
B&R SYSTEM 2005	164
AO350	165
AO775	165
B&R SYSTEM 2010	249
AO300	250
AO725	250
AO900	250
AO300	250
AO350	165
AO352	77
AO725	250
AO775	165
AO900	250
Application Memory	
B&R SYSTEM 2005	
ME960	147
ME963	147
ME965	147
B&R SYSTEM 2010	232
ME910	233
ME913	233
ME915	233

AT300	252
AT324	79
AT350	173
AT352	81
AT450	173
AT610	253
AT660	174
AT664	82
Axis Controller	
B&R SYSTEM 2005	
NC154	193

B

B&R Industrial Products

Limit Values	9
--------------------	---

B&R PCC Operating System

Logic Scanner	270
---------------------	-----

B&R SYSTEM 2000

Combination Possibilities	20
Expansion I/O	14
Local Expansion (Expansion I/O)	14
Modular Structure	9
Program Memory Modules	13
Remote Expansion (Remote-I/O)	16
Remote I/O	16
Supply Voltage	12
System and I/O Bus	11
Terminal Blocks	12

B&R SYSTEM 2003

Communication Modules	89
Counter Modules	94
Dimensions	26
Environmental Temperature during Operation	33
Installation Dimensions	29
Installation	30
Module Overview	21
Module Rack	26
Modules	27
Mounting Rail	26
Positioning Modules	94
Relative Humidity	33
Temperature Modules	78

B&R SYSTEM 2005

Dimensions	113
Environmental Temperature during Operation	116
Module Overview	107
Module Rack	113
Module Structure	113
Montage	114
Mounting Rail	113
Relative Humidity	116
Terminal Block TB170	115

B&R SYSTEM 2010

Cable Routing	211
Differences between System and I/O Modules	207
Dimensions	207
Environmental Temperature during Operation	211
Module Overview	203
Module Rack	208
Module Structure	207
Montage	209
Mounting Rail	208
PCC Module Installation	210
Relative Humidity	211
Terminal Block Coding	211
Terminal Blocks TB120 / TB140	211

Basic Module Structure

B&R SYSTEM 2005	113
B&R SYSTEM 2010	207

Battery Module

B&R SYSTEM 2005	
AC240	198
BM100	267
BM150	199
BP101	214
BP110	214
BP150	118
BP151	118
BP152	118
BP155	118
BP200	214
BP201	214
BP202	214
BP210	214
BP300	214
BP702	34
BP703	34
BP704	34
BP705	34
BP706	34
BP707	34
BP708	34
BP709	34
BP710	34

Bus Controller Module

B&R SYSTEM 2005	
EX150	127
EX250	128
EX350	130

Bus Controller Module

B&R SYSTEM 2003	
EX270	38
EX470	39
EX477	36
EX770	39
EX777	36
B&R SYSTEM 2010	
EX100	220
EX200	220
EX301	221
EX302	221

Bus Cover

B&R SYSTEM 2003	
AC010	98

C

Cable NC154 - PC	199
------------------------	-----

Cable Routing

B&R SYSTEM 2010	211
-----------------------	-----

CAN Bus Controller

B&R SYSTEM 2003	
EX270	38
EX470	39
EX770	39
CM211	84

CM411	87
Combination Modules	
B&R SYSTEM 2003	
CM211	84
CM411	87
Combination Possibilities	
Remote Expansion	20
Local Expansion	20
Communication Modules	
B&R SYSTEM 2003	
IF311	90
IF321	91
IF361	92
IF371	93
B&R SYSTEM 2005	
IF050	177
IF060	179
IF613	180
IF621	181
IF622	182
IF661	183
IF671	184
IF672	186
IF681.95	187
IF681.96	188
NW150	189
B&R SYSTEM 2010	
IF100	259
IF101	259
NW100	261
Logic Scanner	274
LS071	274, 275
LS079	274, 277
Comparator	
NC161	96
Compatibility	
Logic Scanner	270
Configuration Memory	
B&R SYSTEM 2003	
ME770	43
Controller	
Dimensions	27
Counter and Positioning Modules	
B&R SYSTEM 2003	
NC161	95
B&R SYSTEM 2010	
NC303	263
Counter Modules	
B&R SYSTEM 2003	94
B&R SYSTEM 2005	190
NC150	191
CP100	223
CP104	223
CP152	131
CP153	131
CP200	223
CP210	223
CP260	133
CP430	41
CP470	41
CP474	41
CP770	41
CP774	41

CPUs	
B&R SYSTEM 2003	
CP430	41
CP470	41
CP474	41
CP770	41
CP774	41
B&R SYSTEM 2005	
CP152	131
CP153	131
CP260	133
IF152	135
IF260	137
IP161	139
XP152	142
B&R SYSTEM 2010	
CP100	223
CP104	223
CP200	223
CP210	223
Dimensions	27
Logic Scanner	
LS251	271

D

D0650	156
D0750	156
DI135	47
DI400	236
DI425	238
DI426	238
DI435	49
DI439.7	50
DI439.72	51
DI450	149
DI475	151
DI476	151
DI477	152
DI645	52
DI695	153
DI725	239
DI825	240
Differences between System and I/O Module	
B&R SYSTEM 2010	207
Digital Input Modules	
Dimensions	27
B&R SYSTEM 2003	
DI135	47
DI435	49
DI439.7	50
DI439.72	51
DI645	52
B&R SYSTEM 2005	
DI450	149
DI475	151
DI476	151
DI477	152
DI695	153
B&R SYSTEM 2010	
DI400	236
DI425	238
DI426	238
DI725	239
DI825	240

Digital Mixed Modules

B&R SYSTEM 2003	63
DM435	64
DM438	66
DM465	68
B&R SYSTEM 2005	159
DM476	160

Digital Output Modules

Dimensions	27
B&R SYSTEM 2003	53
DO135	54
DO164	56
DO435	58
DO720	60
DO721	61
DO722	62
B&R SYSTEM 2005	154
DO479	155
DO480	155
DO650	156
DO690	157
DO750	156
DO760	158
B&R SYSTEM 2010	242
DO428	243
DO430	243
DO600	244
DO700	244
DO710	245

Dimensions

B&R SYSTEM 2003	26
B&R SYSTEM 2005	113
B&R SYSTEM 2010	207

DM435	64
DM438	66
DM455	144
DM465	68
DM476	160
DO135	54
DO164	56
DO428	243
DO430	243
DO435	58
DO479	155
DO480	155
DO600	244
DO690	157
DO700	244
DO710	245
DO720	60
DO721	61
DO722	62
DO760	158
DS100	226
DS101	228

Dummy Module

B&R SYSTEM 2005	
BM150	199
B&R SYSTEM 2010	267
BM100	267

E

Electromagnetic Fields	9
Electrostatic Discharge	9
Encoder Module	
B&R SYSTEM 2003	
NC161	95
Environmental Temperature during Operation	
B&R SYSTEM 2003	33
B&R SYSTEM 2005	116
B&R SYSTEM 2010	211
EX100	220
EX150	127
EX200	220
EX250	128
EX270	38
EX301	221
EX302	221
EX350	130
EX470	39
EX477	36
EX770	39
EX777	36
Expansion I/O	
B&R SYSTEM 2003	14
B&R SYSTEM 2005	14
B&R SYSTEM 2010	15
Expansion Master/Slave	
B&R SYSTEM 2010	221
EX301	221
EX302	221
External Supply for LS251	
Logic Scanner	270

G

General Accessories

AC401	282
AC410	282
AC911	285
AC912	283
AC913	283
AC916	284
General Information	281
INT1	286
RS485 Bus Connector	284

General Information

General Accessories	281
Logic Scanner	270

H

High Performance

Logic Scanner	270
---------------------	-----

High Performance Visualization

Logic Scanner	270
---------------------	-----

I	
IF050	177
IF060	179
IF100	259
IF101	259
IF152	135
IF260	137
IF311	90
IF321	91
IF361	92
IF371	93
IF613	180
IF621	181
IF622	182
IF661	183
IF671	184
IF672	186
IF681.95	187
IF681.96	188
Incremental Encoder Operation	
NC161	95
Installation	
B&R SYSTEM 2003	30
B&R SYSTEM 2005	114
B&R SYSTEM 2010	209
Installation Dimensions	
B&R SYSTEM 2003	29
INT1	286
Intelligent I/O Processors	
B&R SYSTEM 2010	226
DS100	226
DS101	228
NC303	263
Interface Adapter Module	
B&R SYSTEM 2005	
IF060	179
Interface Modules	
B&R SYSTEM 2003	
IF311	90
IF321	91
IF361	92
IF371	93
B&R SYSTEM 2005	
IF050	177
IF060	179
IF613	180
IF621	181
IF622	182
IF661	183
IF671	184
IF672	186
IF681.95	187
IF681.96	188
B&R SYSTEM 2010	259
IF100	259
IF101	259
Logic Scanner	275, 277
LS071	275
LS079	277
IP161	139

L	
Limit Values	9
Limit Values	9
Local Expansion	
B&R SYSTEM 2003	14
B&R SYSTEM 2005	14
B&R SYSTEM 2010	15
Local I/O Master Controller	
B&R SYSTEM 2005	
EX350	130
Logic Scanner	269
Additional Interfaces	270
B&R PCC Operating System	270
Compatibility	270
External Supply for the Logic Scanner CPU	270
General Information	270
High Performance Visualization	270
LS071	275
LS079	277
LS251	271
Module Overview	269
LS071	275
LS079	277
LS251	271

M

Manuals	
B&R SYSTEM 2003	106
B&R SYSTEM 2005	202
B&R SYSTEM 2010	268
Logic Scanner	279
ME770	43
ME910	233
ME913	233
ME915	233
ME960	147
ME963	147
ME965	147
Modular Structure	
B&R SYSTEM 2003	9
B&R SYSTEM 2005	11
B&R SYSTEM 2010	11
Module	
B&R SYSTEM 2003	27
Module Overview	
B&R SYSTEM 2003	21
B&R SYSTEM 2005	107
B&R SYSTEM 2010	203
Logic Scanner	269
Module Rack	
B&R SYSTEM 2003	26, 34
BP702	34
BP703	34
BP704	34
BP705	34
BP706	34
BP707	34
BP708	34
BP709	34
BP710	34

B&R SYSTEM 2005	
BP150	118
BP151	118
BP152	118
BP155	118
B&R SYSTEM 2010	208, 212
Module Structure	
B&R SYSTEM 2005	113
B&R SYSTEM 2010	207
Mounting Rail	
B&R SYSTEM 2003	26
B&R SYSTEM 2005	113
B&R SYSTEM 2010	208
MP100	230
Multiprocessors	
B&R SYSTEM 2010	230
MP100	230

N

NC150	191
NC154	193
NC161	95
NC303	263
NiCd Rechargeable Battery	197
NW100	261
NW150	189
Other Modules	
B&R SYSTEM 2003	
CM211	84
CM411	87
B&R SYSTEM 2010	255
UM900	256

P

PCC Module Installation	
B&R SYSTEM 2010	210
Positioning Modules	
B&R SYSTEM 2003	94
B&R SYSTEM 2005	190
NC154	193
Power Supply	
B&R SYSTEM 2003	12
B&R SYSTEM 2005	12
B&R SYSTEM 2010	12
Power Supply Modules	
B&R SYSTEM 2005	119
PS465	121
PS476	121
PS477	121
PS691	123
PS692	123
PS694	123
PS791	125
PS792	125
PS794	125
B&R SYSTEM 2010	215
PS425	217
PS740	218
Processor Modules	
Logic Scanner	271
LS251	271

PROFIBUS Network Modules

B&R SYSTEM 2005	
NW150	189
B&R SYSTEM 2010	261
NW100	261

Program Memory Modules

B&R SYSTEM 2003	13
ME770	43
B&R SYSTEM 2005	13, 146
ME960	147
ME963	147
ME965	147
B&R SYSTEM 2010	14, 232
ME910	233
ME913	233
ME915	233

Programmable I/O Processors

B&R SYSTEM 2005	
IP161	139
B&R SYSTEM 2010	263

Programmable Interface Processors

B&R SYSTEM 2005	
IF152	135
IF260	137

Programmable Modules

B&R SYSTEM 2005	
DM455	144
B&R SYSTEM 2010	225
DS100	226
DS101	228
MP100	230
PS425	217
PS465	121
PS476	121
PS477	121
PS691	123
PS692	123
PS694	123
PS740	218
PS791	125
PS792	125
PS794	125
Pulse Width Modulation, DO135	55

R

Relative Humidity

B&R SYSTEM 2003	33
B&R SYSTEM 2005	116
B&R SYSTEM 2010	211

Remote Expansion

B&R SYSTEM 2003	16
B&R SYSTEM 2005	18
B&R SYSTEM 2010	19

Remote I/O

B&R SYSTEM 2003	16
B&R SYSTEM 2005	18
B&R SYSTEM 2010	19

Remote I/O Bus Controller

B&R SYSTEM 2003	
EX477	36
EX777	36

Remote I/O Master	
B&R SYSTEM 2005	
EX150	127
EX250	128
Remote I/O Master/Slave	
B&R SYSTEM 2010	220
EX100	220
EX200	220
RS485 Bus Connector	284

S

Screw-in Modules

B&R SYSTEM 2003	
AI261	71
AI294	72
AI351	73
AI354	74
AI774	75
AO352	77
AT324	79
AT352	81
AT664	82
DI135	47
DO135	54
DO164	56
IF311	90
IF321	91
IF361	92
IF371	93
NC161	95

Standards	10
-----------------	----

Stress Relief

B&R SYSTEM 2003	
AC011	97

System and I/O Bus

B&R SYSTEM 2003	11
B&R SYSTEM 2005	12
B&R SYSTEM 2010	12

T

TB120	268
TB140	268
TB170	200, 201
TB710	99
TB712	100
TB718	101
TB722	102
TB733	103
TB736	104
TB772	105

Temperature Modules

B&R SYSTEM 2003	78
AT324	79
AT352	81
AT664	82
B&R SYSTEM 2005	172, 173, 174
AT350	173
AT450	173
AT660	174
B&R SYSTEM 2010	251
AT300	252
AT610	253

Terminal Block Coding

B&R SYSTEM 2010	211
-----------------------	-----

Terminal Block TB170

B&R SYSTEM 2005	115
-----------------------	-----

Terminal Blocks

B&R SYSTEM 2003	12
TB712	100
TB718	101
TB722	102
TB733	103
TB736	104
TB772	105
B&R SYSTEM 2005	13
TB162	200
TB170	201
B&R SYSTEM 2010	13, 268
TB120	268
TB140	268

Terminal Blocks TB120 / TB140

B&R SYSTEM 2010	211
-----------------------	-----

U

UM900	256
-------------	-----

Universal Mixed Modules

B&R SYSTEM 2010	255
UM900	256

X

XP152	142
-------------	-----

0

0AC100.9	196, 197
0AC240.9	196, 198
0AC401.9	282
0AC410.9	282
0AC912.9	283
0AC913.92	283
0AC916.9	284
0G1000.00-090	284
0G2001.00-090	196, 199
0MC111.9	196
0MC211.9	196

2

2AI300.6	247
2AI700.6	247
2AI730.6	248
2AO300.6	250
2AO725.6	250
2AO900.6	250
2AT300.6	252
2AT610.6	253
2BM100.9	266, 267
2CP100.60-1	223
2CP104.60-1	223
2CP200.60-1	223
2CP210.60-1	223
2DI400.6	236
2DI425.6	238
2DI426.6	238
2DI725.6	239
2DI825.6	240
2DO428.6	243
2DO430.6	243
2DO600.6	244
2DO700.6	244
2DO710.6	245
2DS100.60-1	226

Model Number Index

2DS101.60-1	228
2EX100.50-1	220
2EX200.50-1	220
2EX301.5	221
2EX302.5	221
2IF100.60-1	259
2IF101.60-1	259
2ME910.90-1	233
2ME913.90-1	233
2ME915.90-1	233
2MP100.5	230
2NC303.60-1	263
2NW100.50-1	261
2PS425.9	217
2PS740.9	218
2TB120.9	266, 268
2TB140.9	266, 268
2UM900.6	256

3

3AI350.6	163
3AI375.6	163
3AI775.6	163
3AM050.6	167
3AM051.6	168
3AM055.6	169
3AM374.6	170
3AO350.6	165
3AO775.6	165
3AT350.6	173
3AT450.6	173
3AT660.6	174
3BM150.9	196, 199
3BP150.4	118
3BP150.41	118
3BP151.4	118
3BP151.41	118
3BP152.4	118
3BP152.41	118

3BP155.4	118
3BP155.41	118
3CP152.9	131
3CP152.90-2	131
3CP153.9	131
3CP260.60-1	133
3DI450.60-9	149
3DI475.6	151
3DI476.6	151
3DI477.6	152
3DI695.6	153
3DM476.6	160
3DO479.6	155
3DO480.6	155
3DO650.6	156
3DO690.6	157
3DO750.6	156
3DO760.6	158
3EX150.60-1	127
3EX250.60-1	128
3EX350.6	130
3IF050.6	177
3IF060.6	179
3IF152.60-2	135
3IF260.60-1	137
3IF613.9	180
3IF621.9	181
3IF622.9	182
3IF661.9	183
3IF671.9	184
3IF672.9	186
3IF681.95	187
3IF681.96	188
3IP161.60-1	139
3ME960.90-1	147
3ME963.90-1	147
3ME965.90-1	147
3NC150.6	191
3NC154.60-2	193
3NW150.60-1	189
3PS465.9	121
3PS476.90-1	121
3PS477.9	121
3PS691.90-1	123
3PS692.9	123
3PS694.9	123
3PS791.90-1	125
3PS792.9	125
3PS794.9	125

3TB162.9	196, 200
3TB170.9	196, 201
3TB170.91	196, 201
3TB170.90-02	196, 201
3TB170.91-02	196, 201
3XP152.60-1	142
3XP152.60-2	142

5

5LS071.9	275
5LS079.9	277
5LS251.60-1	271

7

7AC010.9	98
7AC011.9	98
7AC911.9	285
7AF101.7	44
7AI261.7	71
7AI294.7	72
7AI351.70	73
7AI354.70	74
7AI774.70	75
7AO352.70	77
7AT324.70	79
7AT352.70	81
7AT664.70	82
7BP702.0	34
7BP703.0	34
7BP704.0	34
7BP705.0	34
7BP706.0	34
7BP707.0	34
7BP708.0	34
7BP709.0	34
7BP710.0	34
7CM211.7	84
7CM411.70-1	87
7CP430.60-1	41
7CP470.60-1	41
7CP474.60-1	41
7CP770.60-1	41
7CP774.60-1	41
7DI135.7	47
7DI435.7	49
7DI439.7	50
7DI439.72	51
7DI645.7	52

7DM435.7	64	7TB718.91	101
7DM438.7	66	7TB718:90-02	101
7DM465.7	68	7TB718:91-02	101
7DO135.70	54	7TB722.9	102
7DO164.70	56	7TB722.91	102
7DO435.7	58	7TB733.9	103
7DO720.7	60	7TB733.91	103
7DO721.7	61	7TB736.9	104
7DO722.7	62	7TB736.91	104
7EX477.50-1	36	7TB772.91	105
7EX777.50-1	36		
7IF311.7	90	E	
7IF321.7	91	ECINT1-1	286
7IF361.70-1	92	ECINT1-11	286
7IF371.70-1	93		
7NC161.7	95	M	
7TB710.9	99	MASYS22003-0	106
7TB710.91	99	MASYS22003-E	106
7TB710:90-01	99	MASYS22005-0	202
7TB710:91-01	99	MASYS22005-E	202
7TB712.9	100	MASYS22010-0	268
7TB712.91	100	MASYS22010-E	268
7TB712:90-02	100	MASYS2LS-0	279
7TB712:91-02	100	MASYS2LS-E	279
7TB718.9	101		

RELEVANT CONVERSIONS

METRIC AND ENGLISH EQUIVALENTS

Some of the values in this manual and in other documentation that you may have contain values which are only given in metric. Follow the formulas and charts on this page to help with any conversion problems that you may have.

TEMPERATURE

Below are two formulas to help in the conversion from Fahrenheit to Centigrade and vice versa.

LINEAR MEASURE & WEIGHTS

All B&R documentation includes the product dimensions, weights, distances for cabling and cutout sizes in metric. Use the conversions below to calculate these measurements into the equivalent English units.

Fahrenheit °F	Metric °C
-40	-40
-20	-28.89
-10	-23.33
-5	-20.56
0	-17.78
5	-15.00
10	-12.22
15	-9.44
20	-6.67
25	-3.89
30	-1.11
35	1.67
40	4.44
45	7.22
50	10.00
55	12.78
60	15.56
65	18.33
70	21.11
75	23.89
80	26.67
85	29.44
90	32.22
95	35.00
100	37.78
105	40.56
110	43.33
115	46.11
120	48.89
125	51.67
130	54.44
135	57.22
140	60.00
145	62.78
150	65.56

Metric °C	Fahrenheit °F
-40	-40.00
-35	-31.00
-30	-22.00
-25	-13.00
-20	-4.00
-15	5.00
-10	14.00
-5	23.00
0	32.00
5	41.00
10	50.00
15	59.00
20	68.00
25	77.00
30	86.00
35	95.00
40	104.00
45	113.00
50	122.00
55	131.00
60	140.00
65	149.00
70	158.00
75	167.00
80	176.00
85	185.00
90	194.00

$$5/9 \times (°F - 32) = °C$$

$$(9/5 \times °C) + 32 = °F$$

English Units	Metric Units
1 inch	25.4 millimeters 2.54 centimeters
1 foot	30.48 centimeters 3.048 decimeters 0.3048 meter
1 yard	0.9144 meter
0.03937 inch	1 millimeter
0.3937 inch	1 centimeter
3.937 inches	1 decimeter
39.37 inches 3.2808 feet 1.0936 yards	1 meter
3280.8 feet 1093.6 yards 0.62137 mile	1 kilometer

English Units	Metric Units
1 pound	0.45359 kilogram
1 ounce	28.350 grams
1 short ton	907.18 kilograms 0.90718 metric tons
1 long ton	1016.0 kilograms 1.0160 metric tons

Index

