

486747

# Lenze



**Global Drive**

*Servo motors*

*MDXK / MDFQA*

*synchronous / asynchronous*

# System overview

## Servo motors

In the Global Drive System, asynchronous and synchronous motors perfectly match the controllers. Thanks to modular design and the planned options it is possible to select a suitable drive. Further assets of Global Drive servo motors are: small size, long life and high operational safety.

Comfortable system cables with plug-in connectors enable easy connection. Modern production processes ensure a good price/performance ratio. This catalogue describes all preference types which are available within 15 working days as well as all industry types which require a delivery time of 30 working days. We would like to present further options of this modular design personally.

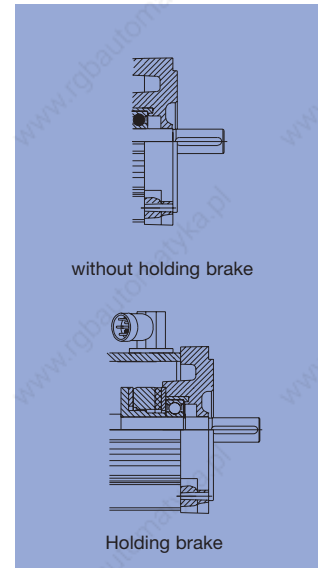
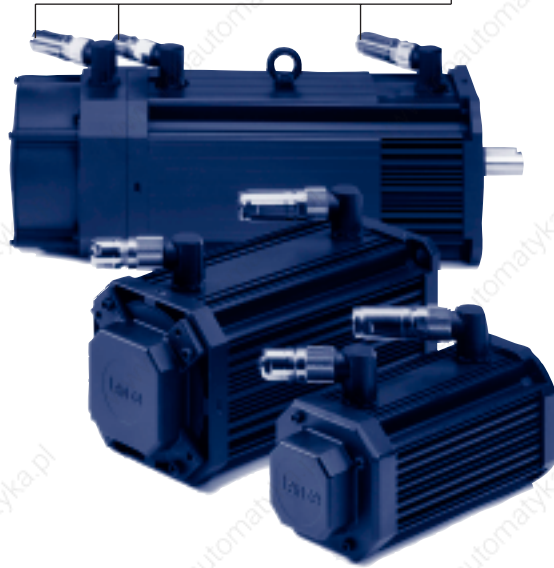
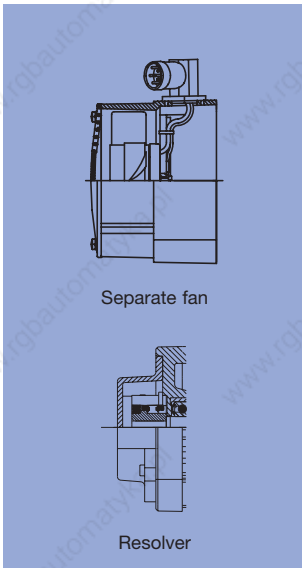

# Product code

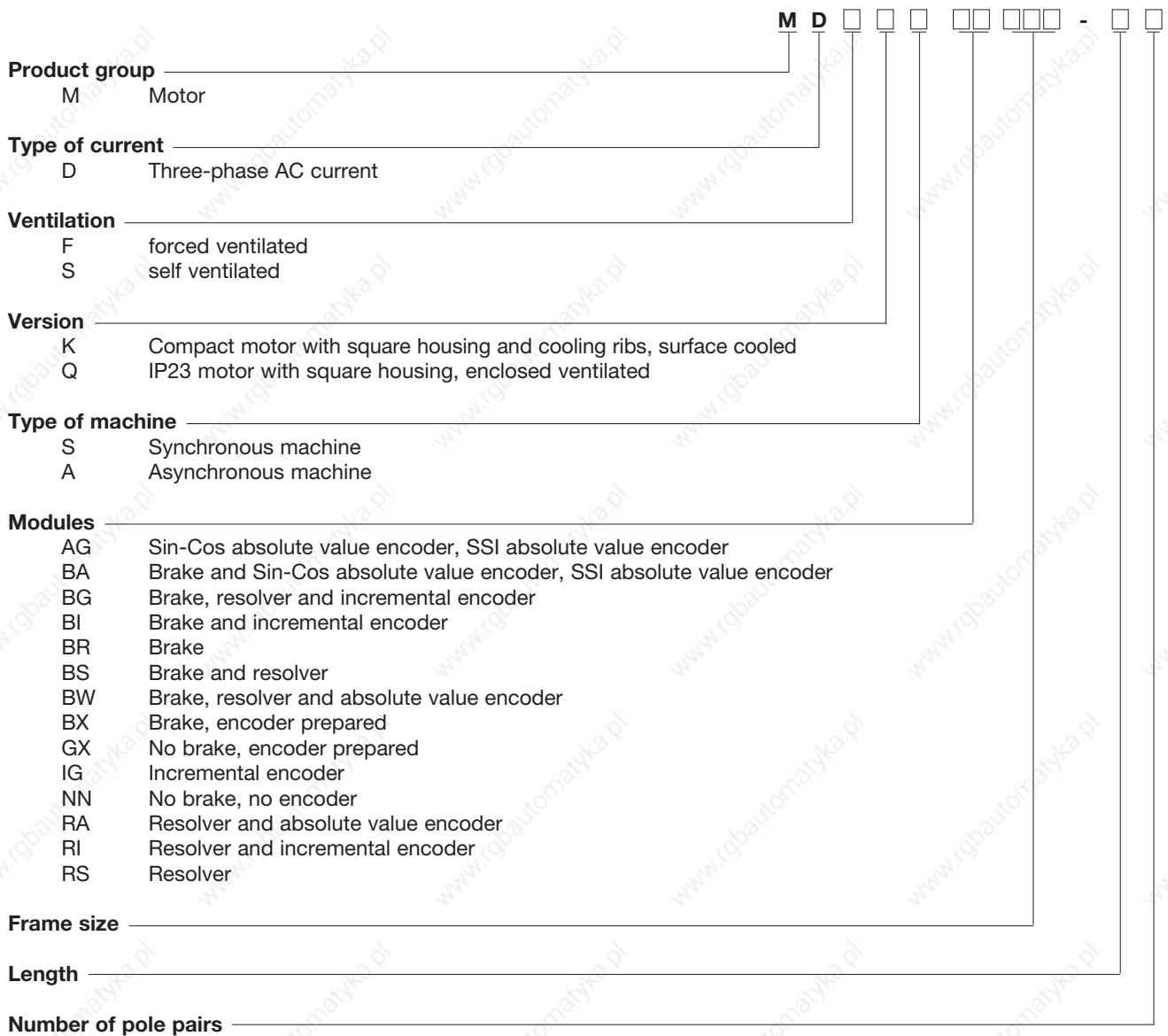

## ***Introduction of Lenze***

### **No matter which drive solution you imagine – we make your dreams come true.**

According to our maxim „one stop shopping“ we offer you a complete programme of electronic and mechanical drive systems which are distinguished by reliability and efficiency.

Our supply range includes frequency inverters, speed controllers, variable speed drives, gearboxes and motors as well as clutches and brakes.

Lenze is thus the competent partner for your application – not only as supplier for single components but also for complete drive systems including planning, execution and commissioning. Furthermore, a world-wide service and distribution network allows a qualified customer advisory

service on site and a fast and extensive after sales service. Our quality assurance system for development, production, sales and service is certified to DIN ISO 9001. Our customers set the scale for measuring the quality of our products. Our task is to meet your requirements. Customer orientation as a Lenze principle means the highest quality.

See for yourself.





## List of abbreviations

### Abbreviations used in this catalogue

<b>h</b>	[mm]	Axis height	<b>MDFQA</b>	Enclosed ventilated asynchronous servo motor, forced ventilated (MDFQA)
<b>n<sub>rated</sub></b>	[min <sup>-1</sup> ]	Rated speed	<b>MDXKX</b>	Asynchronous or synchronous servo motor, self or forced ventilated (MDSKA/MDSKS or MDFKA/MDFKS)
<b>M<sub>rated</sub></b>	[Nm]	Rated torque	<b>MDSKX</b>	Asynchronous or synchronous servo motor self ventilated (MDSKA/MDFKA)
<b>P<sub>rated</sub></b>	[kW]	Rated power	<b>MDFKX</b>	Asynchronous servo motor, self ventilated or forced ventilated (MDSKA/MDFKA)
<b>I<sub>rated</sub></b>	[A]	Rated current	<b>MDXKA</b>	Asynchronous servo motor, self ventilated or forced ventilated (MDSKA/MDFKA)
<b>I<sub>0</sub></b>	[A]	Continuous current at standstill	<b>MDXKS</b>	Synchronous servo motor, self ventilated or forced ventilated (MDXKS/MDFKS)
<b>f<sub>rated</sub></b>	[Hz]	Rated frequency	<b>AC</b>	AC voltage
<b>M<sub>max</sub></b>	[Nm]	Maximum torque	<b>DC</b>	DC voltage
<b>I<sub>max</sub></b>	[A]	Maximum current	<b>DIN</b>	Deutsches Institut für Normung
<b>n<sub>max</sub></b>	[min <sup>-1</sup> ]	Maximum speed	<b>EMC</b>	Electromagnetic compatibility
<b>J<sub>load</sub></b>	[kgcm <sup>2</sup> ]	Moment of inertia load machine	<b>EN</b>	European Standard
<b>M<sub>load</sub></b>	[Nm]	Torque load machine	<b>IEC</b>	International Electrotechnical Commission
<b>M<sub>0</sub></b>	[Nm]	Continuous torque at standstill	<b>IP</b>	International Protection Code
<b>M<sub>cont</sub></b>	[Nm]	Continuous torque	<b>NEMA</b>	National Electrical Manufacturers Association
<b>M<sub>perm</sub></b>	[Nm]	Permissible torque	<b>VDE</b>	Verband deutscher Elektrotechniker
<b>η<sub>gearbox</sub></b>		Gearbox efficiency	<b>CE</b>	Communauté Européene
<b>J<sub>mot</sub></b>	[kgcm <sup>2</sup> ]	Moment of inertia motor	<b>IM</b>	International Mounting Code
<b>m</b>	[kg]	Mass		
<b>cosφ<sub>N</sub></b>		Power factor asynchronous motor		
<b>U<sub>rated</sub></b>	[V]	Rated voltage		
<b>F<sub>a</sub></b>	[N]	Permissible axial force		
<b>F<sub>r1</sub></b>	[N]	Permissible radial force at shaft middle		
<b>F<sub>r2</sub></b>	[N]	Permissible radial force at shaft end		
<b>i</b>		Gearbox ratio		
<b>M<sub>B</sub></b>	[Nm]	Holding torque brake		
<b>J<sub>B</sub></b>	[kgcm <sup>2</sup> ]	Moment of inertia brake		

# Global Drive servo motors

## Product information

_____	8
-------	---

## Selection of servo motors

General data _____	9
Preference types _____	10
Rated data MDXKS _____	11
Rated data MDXKA _____	12
Rated data MDFQA _____	13
Torque-limit characteristics _____	14

## Technical data of servo motors

Permissible shaft load _____	38
Fan modules _____	39
Brake modules _____	40
Angle and speed controller modules _____	42
Resolver modules _____	42
SinCos absolute value encoder modules _____	43
Incremental encoder modules _____	43
KTY temperature sensor modules _____	44
Thermostat modules _____	44
Plug-in connectors _____	45
Terminal box _____	48

## Dimensions of servo motors

Synchronous servo motor MDSKS 036 _____	51
Synchronous servo motor MDSKS 056 _____	52
Synchronous servo motor MDXKS 071 _____	53
Asynchronous servo motor MDSKA 056 _____	54
Asynchronous servo motor MDXKA 071 _____	55
Asynchronous servo motor MDXKA 080 _____	56
Asynchronous servo motor MDXKA 090 _____	57
Asynchronous servo motor MDXKA 100 _____	58
Asynchronous servo motor MDXKA 112 _____	59
Asynchronous servo motor MDFQA 100...132 _____	60

## Application examples

Application of a servo controller _____	62
Possible combinations with controllers _____	64
Connection _____	68
EC Directives _____	69

## Order forms

Servo motor MDXK _____	71
Servo motor MDFQA _____	74

## Lenze worldwide

_____	76
-------	----

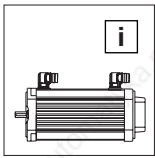

## Product information

### Servo motors MDXK and MDFQA

Today, servo drive systems must fulfil highest demands. With Global Drive, Lenze succeeded in combining different drive components to form a perfectly matching system. The programme of servo motors for the power range up to 60.1 kW is completed by brushless synchronous servo motors for the lower power range from 0.25 to 4.2 kW. Compared with standard three-phase AC motors, these servo motors provide a very low moment of inertia, low weight, high maximum speed and a wide speed-setting range.

#### High dynamic response and accuracy

Servo motors provide a low moment of inertia and a high overloadability. Optimum temperature-independent control features are achieved by continuously measuring the temperature with an integrated temperature sensor. Together with servo inverters of series 9300, the motors ensure high speed accuracy, best concentricity and high angle acceleration.

#### Long service life

The high quality standard, Lenze sets for all components, meets the requirements of modern drive technology for operational safety and service life. A reinforced isolation with thermal reserve (coated wire to thermal class H, class F temperature rise) ensures a long service life of the winding. Prestressed rolling bearings with high temperature resistant lubrication ensure a long service life.

#### Operational safety

Enclosure IP54 of MDXK motors ensures good protection against dust and water ingress. MDFQA motors up to 60.1 kW are protected by enclosure IP23.

#### CE conformity

Of course, Lenze servo motors MDXK and MDFQA comply with the EC Directives:

- CE conformity to the Low Voltage Directive
- CE conformity to the Electromagnetic Compatibility of a typical drive configuration with inverter.

The electromagnetic compatibility can be easily guaranteed by using predetermined system cables.

#### No compromises with the output speed

The wide ratio range of gearboxes combined with the small ratio step of 1.12 enables the exact selection of the output speed range required.

#### Compact

The high power density of the motors facilitates small drive units.

Especially compact drives are formed by using geared servo motors with directly connected motors.

#### Adaptability

The modular motor design and the number of planned variants facilitate the selection of the motor for your application.

Thanks to the variety of output designs of motors and geared motors, the drives fulfil many application requirements:

- Servo motors with cylindrical shaft end with or without key
- Servo motors with flanges provided with through hole bores for mounting position B5, with threaded bores for mounting position B14.
- Geared servo motors with solid shaft, hollow shaft or hollow shaft with shrink disc.
- Geared servo motors with or without flange, foot or centring
- Different integrated angle encoders ensure the accuracy required:
  - Resolver as standard solution, optimised characteristic because of internal improvement of the resolver accuracy. SinCos absolute value encoder as industry type for highest accuracy. Incremental encoder with 2048 pulses as preference type for MDFQA and as industry type for MDXK.

#### Low noise

High chopper frequency of the inverters (up to 16 kHz) result in a low noise generation.

In addition, optimised tooth geometry and internally ribbed cast iron housings of Lenze Gearboxes reduce the noise generated.

#### Reduced backlash

The application of backlash-free permanent magnet holding brakes enables a defined holding of a position even when no voltage is applied.

Compared with other gearboxes, backlash-free connection elements of Lenze Gearboxes and the high splining quality achieved by precise production ensure a low backlash at the output of geared servo motors.

#### Special types

Special applications require special motor designs.

Possible options are e.g.:

- incremental encoder as feedback with 4096 pulses
- second feedback.

We are prepared to give more detailed information.



# Selection

## General data

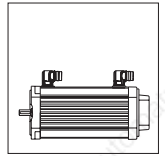

	Synchronous servo motors Series MDSKS, MDFKS	Asynchronous servo motors Series MDSKA, MDFKA	Asynchronous servo motors MDFQA
<b>Enclosure</b>	IP54 / IP65		IP23
<b>Thermal class (VDE 0530)</b>	Thermal class F use, Insulation (coated wire) as thermal class H		
<b>UL-conformity</b>	UL listed material for coated wire, brush leads, insulation material		
<b>Dielectric strength</b>	Max. voltage amplitude $\hat{V} = 1.5 \text{ kV}$ Max. rate of voltage rise $du/dt = 5 \text{ kV}/\mu\text{s}$		
<b>Vibrational severity</b>	N	N frame sizes 056 and 071, R as of frame size 80	N
<b>Concentricity, eccentricity, coaxiality (DIN 42955)</b>	N	N frame sizes 056 and 071, R as of frame size 80	N
<b>Mechanical tolerance</b>	Diameter shaft end $d \text{ } \varnothing 11$ to $\varnothing 38$ : k6, $d \text{ } \varnothing 55$ : m6 Diameter centring flange $b1$ : J6		
<b>Temperature monitoring (no complete protection)</b>	Continuous temperature sensor (KTY 83-110)		
<b>Connection</b>	1 plug for each: Motor and brake Resolver and temperature sensor, separate fan (as of frame size 071) or terminal box		Motor connection as terminal box, encoder connection with plug
<b>Temperature range</b>	-20 to + 40 °C without power derating (without brake, non-ventilated) -10 to + 40 °C without power derating (with brake) -15 to +40 °C without power derating (separately ventilated)		
<b>Surface temperature</b>	Self ventilated motors (MDSK) up to 140 °C Forced ventilated motors (MDFK) up to 110 °C		to 110 °C
<b>Installation height</b>	up to 1000 m a. m. s. l. without power derating		
<b>Demagnetising limit</b>	$> 4 \cdot I_{\text{rated}}$ with self ventilation $> 2,9 \cdot I_{\text{rated}}$ with forced ventilation	Demagnetisation not possible	
<b>Maximum torque</b>	$> 4 \cdot M_{\text{rated}}$ with self ventilation $> 2,9 \cdot M_{\text{rated}}$ with forced ventilation	$> 5 \cdot M_{\text{rated}}$	
<b>Rated speed</b>	3000 $\text{min}^{-1}$	1635-4160 $\text{min}^{-1}$	550-2935 $\text{min}^{-1}$
<b>Angle encoder</b>	Resolver / Sin-Cos encoder	Resolver / incremental encoder / Sin-Cos absolute value encoder	
<b>Mounting position</b>	B5 / B14		B5 / B35
<b>Bearing</b>	Deep groove ball bearing with high-temperature resistant grease, 2 seals		
	Locating bearing at A-side		at B-side
<b>Shaft end</b>	with / without key		
<b>Brake</b>	with or without permanent magnet holding brake at A-side		with and without spring- operated brake
<b>Fan</b>	Axial fan as of frame size 071 possible		Radial fan
<b>Colour</b>	Black, RAL 9005		

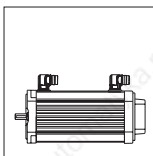

# Selection

## Technical data

### Preference and industry type of servo motors

Motor type		Motor series MDXKX											MDFQA					
		Synchronous motors						Asynchronous motors					Asynchr.-IP23					
		MDSKXX 036-13	MDSKXX 036-23	MDSKXX 056-23	MDSKXX 056-33	MDXKXX 071-03	MDXKXX 071-13	MDXKXX 071-33	MDXKAXX 056-22	MDXKAXX 071-22	MDXKAXX 080-22	MDXKAXX 090-22	MDXKAXX 100-22	MDXKAXX 112-22	MDFQAXX 100-22	MDFQAXX 112-22	MDFQAXX 132-32	
Version																		
Ventilation	Self ventilation	●	●	●	●	●	●	●	●	●	○	○	○	●	●	●		
	Forced ventilated					●	●	●	●	●	●	●	●	●	●	●	●	
Enclosure	IP54	●	●	●	●	●	●	●	●	●	●	●	●					
	IP65 (only with self ventilation)			○	○	○	○	○	○	○	○	○	○					
	IP23s													●	●	●		
Frequency / speed	>100 Hz, >2800 min <sup>-1</sup>	●	●	●	●	●	●	●	●	○	○	○	○	●	●	●		
	<100 Hz, <2500 min <sup>-1</sup>													●	●	●	●	
Mounting position	B14C105			●	●			●										
	B14C160					●	●	●										
	B5 FF75	●	●															
	B5A120 FF100			●	●			●										
	B5A160 FF130					●	●	●		●								
	B5A200 FF165									●	●							
	B5A250 FF215											●	●					
	B5A300 FF265												●	●				
	B5A400 FF350																●	
	B35A250 FF215													●				
	B35A300 FF265														●	●	●	
directly connected gearbox B9				○	○	○	○	○	○	○	○	○	○					
Shaft end	11 x 23 MP with key	●	●															
	14 x 30 MP with key			●	●			●										
	19 x 40 MP with key					●	●	●		●								
	24 x 50 MP with key									●	●							
	28 x 60 MP with key											●						
	38 x 80 MP with key												●	●	●	●		
	55 x 110 MP with key																●	
	11 x 23 OP without key	●	●															
	14 x 30 OP without key			●	●			●										
	19 x 40 OP without key					●	●	●		●								
	24 x 50 OP without key									●	●							
	28 x 60 OP without key											●						
	38 x 80 OP without key												●	●	●	●		
55 x 110 OP without key																	●	
conical shaft (B9)				○	○	○	○	○	○	○	○	○	○					
Brake	without brake	●	●	●	●	●	●	●	●	●	●	●	●	●	●	●	●	●
	24V	●	●	●	●	●	●	●	●	●	●	●	●	●	●	●	●	●
	205V			○	○	○	○	○	○	○	○	○	○	○	○	○	○	○
Encoder	Resolver	●	●	●	●	●	●	●	●	●	●	●	●	●	●	●	●	●
	SinCos multi turn AM512			○	○	○	○	○	○	○	○	○	○	○	○	○	○	○
	SinCos single turn AS512			○	○	○	○	○	○	○	○	○	○	○	○	○	○	○
	ITD21, 2048IMP, TTL																	
Connection	Plug-in conn. (enc. a. power)	●	●	●	●	●	●	●	●	●	●	●	●					
	2 x KK (encoder and power)			○	○	○	○	○	○	○	○	○	○					
	1 x KK1 (power)			○	○	○	○	○	○	○	○	○	○	●	●	●	●	
Temperature monitoring	Thermostat KTY	●	●	●	●	●	●	●	●	●	●	●	●	●	●	●	●	●
	Thermal encoder TKO													●	●	●	●	

● = preference type  
○ = industrial type

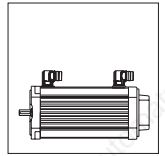

### Synchronous servo motors series MDSKS / MDFKS (surface cooled)

Motor type	Axial height h [mm]	Torque with 3000/min M <sub>rated 3000</sub> [Nm]	Speed n <sub>rated</sub> [min <sup>-1</sup> ]	Torque M <sub>rated</sub> [Nm]	Power P <sub>rated</sub> [kW]	Voltage V <sub>rat. 3~</sub> [V]	Current I <sub>rated</sub> [A]	M <sub>0</sub> [Nm]	I <sub>0</sub> [A]	Maximum torque M <sub>max</sub> [Nm]	Maximum power I <sub>max</sub> [A]	Frequency f <sub>rated</sub> [Hz]	Inertia J [kgcm <sup>2</sup> ]	Weight m <sup>1)</sup> [kg]	Gearbox connection corresp. to stand. motor d x l <sup>3)</sup>
without fan															
MDSKS 036-13, 200	35		4000	0.6	0.25	245	0.9	0.65	0.9	3.1	5.4	200	0.22	1.5	
MDSKS 036-23, 200	35		4000	1.3	0.54	345	1.1	1.5	1.25	7.2	7.5	200	0.36	2.1	
MDSKS 056-23, 190	51	2.9	3800	2.8	1.1	330	2.3	3.2	2.6	11.6	10	190	1.2	5.3	071, C105
MDSKS 056-33, 200	51	4.3	4000	4.2	1.8	325	3.6	4.7	4.0	17.2	16	200	1.8	6.3	071, C105
MDSKS 071-03, 170	65	5.9	3400	5.7	2.0	330	4.2	6.7	4.9	23.6	19	170	6.0	8.9	080, C160
MDSKS 071-13, 185	65	8.8	3700	8.3	3.2	325	7.0	10.0	8.4	35.2	32	185	8.0	10.9	080, C160
MDSKS 071-33, 180	65	12.7	3600	12.3	4.6	325	10.0	14.7	11.9	52.0	45	180	10.0	13.0	080, C160
with separate fan															
MDFKS 071-03, 165	65	7.7	3300	7.5	2.6	330	5.6	8.8	6.6	23.6	19	165	6.0	10.2	080, C160
MDFKS 071-13, 180	65	11.7	3600	11.0	4.1	325	9.2	13.3	11.1	35.2	32	180	8.0	12.2	080, C160
MDFKS 071-33, 175	65	17.0	3500	16.2	5.9	325	13.1	19.3	15.6	52.0	45	175	10.0	14.3	080, C160

1) without fan, with resolver

3) frame size and flange of a standard motor with similar flange and shaft dimensions

6) magnetic / mechanical permissible torque

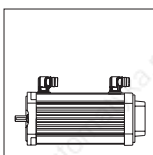

# Selection

## Rated data

### Asynchronous servo motors series MDSKA / MDFKA (surface ventilated)

Motor type	h [mm]	n <sub>rated</sub> [min <sup>-1</sup> ]	M <sub>rated</sub> [Nm]	P <sub>rated</sub> <sup>5)</sup> [kW]	V <sub>rated</sub> <sup>3)</sup> [V]	I <sub>rated</sub> [A]	M <sub>0</sub> [Nm]	I <sub>0</sub> [A]	M <sub>max</sub> <sup>6)</sup> [Nm]	n <sub>rated,max</sub> [min <sup>-1</sup> ]	f <sub>rated</sub> [Hz]	cosφ <sub>N</sub>	J <sup>1)</sup> [kgcm <sup>2</sup> ]	m <sup>1)</sup> [kg]	Gearbox connection corresponds to standard motor <sup>3)</sup>
self cooled															
MDSKA 056-22, 140	51	3950	2.0	0.8	390	2.4	2.3	2.55	10	8000	140	0.70	2.4	6.4	071, C105
MDSKA 071-22, 140	65	4050	4.0	1.7	390	4.4	4.6	4.6	32	8000	140	0.76	8.3	10.4	080, C160
MDSKA 080-22, 70	71	2000	6.7	1.4	390	3.3	8.0	3.85	60	8000	70	0.75	19.2	15.1	090, C160
MDSKA 080-22, 140		4100	5.4	2.3	390	5.8	8.0	7.7	60	8000	140	0.75			
MDSKA 090-22, 80	83	2300	10.8	2.6	390	5.5	12.8	6.0	100	8000	80	0.81	36	22.9	090, C160
MDSKA 090-22, 140		4110	9.5	4.1	350	10.2	12.8	12.0	100	8000	140	0.80			
MDSKA 100-22, 80	96	2340	16.3	4.0	390	8.2	22.5	9.85	180	8000	80	0.80	72	44.7	112, C160
MDSKA 100-22, 140		4150	12.0	5.2	330	14.0	22.5	19.7	180	8000	140	0.78			
MDSKA 112-22, 85	107	2490	24.6	6.4	390	13.5	39	15.9	300	8000	85	0.83	180	60	132, A300
MDSKA 112-22, 140		4160	17.0	7.4	320	19.8	39	31.8	300	8000	140	0.80			
with separate fan															
MDFKA 071-22, 120	65	3410	6.3	2.2	390	6.0	7.0	6.3	32	8000	120	0.75	8.3	12.0	080, C160
MDFKA 080-22, 60	71	1635	12.0	2.1	390	4.8	13.5	5.25	60	8000	60	0.81	19.2	16.9	090, C160
MDFKA 080-22, 120		3455	10.8	3.9	390	9.1	13.5	10.5	60	8000	120	0.80			
MDFKA 090-22, 60	83	1680	21.5	3.8	390	8.5	23.9	9.05	100	8000	60	0.80	36	25.5	090, C160
MDFKA 090-22, 120		3480	19.0	6.9	390	15.8	23.9	18.1	100	8000	120	0.80			
MDFKA 100-22, 60	96	1700	36.3	6.4	390	13.9	40.0	15.4	180	8000	60	0.83	72	48.2	112, C160
MDFKA 100-22, 120		3510	36.0	13.2	390	28.7	40.0	30.8	180	8000	120	0.80			
MDFKA 112-22, 60	107	1710	61.4	11.0	390	22.5	75	25.8	300	8000	60	0.85	180	63.5	132, A300
MDFKA 112-22, 120		3520	55.0	20.3	390	42.5	75	49.5	300	8000	120	0.80			

1) without brake, with resolver

3) frame size and flange of a standard motor with similar flange and shaft dimensions

5) when V<sub>rated</sub>, P = P<sub>rated</sub> up to 2.3 · n<sub>rated</sub>

6) magnetic/mechanical permissible torque

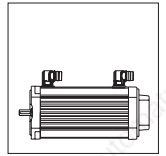

### Asynchronous servo motors series MDFQA (enclosed ventilated)

Motor type	Conne- tion	h [mm]	n <sub>rated</sub> [min <sup>-1</sup> ]	M <sub>rated</sub> [Nm]	P <sub>rated</sub> <sup>5)</sup> [kW]	V <sub>rated</sub> <sup>3)</sup> [V]	I <sub>rated</sub> [A]	M <sub>0</sub> [Nm]	I <sub>0</sub> [A]	M <sub>max</sub> <sup>6)</sup> [Nm]	f [Hz]	η	cosφ	n <sub>max</sub> [min <sup>-1</sup> ]	J <sup>1)</sup> [kgcm <sup>2</sup> ]	m <sup>1)</sup> [kg]	Gearbox connection corresponds to standard motor 3)
<b>MDFQA 100-22, 50</b>	Y	100	1420	71.3	10.6	360	26.5	76	27.0	250	50	0.76	0.84	5000	180	65	132, A300
<b>MDFQA 100-22, 100</b>	Y	100	2930	66.2	20.3	360	46.9	76	54.0	250	100	0.87	0.80				
<b>MDFQA 112-22, 50</b>	Y	112	760	145	11.5	360	27.2	156	29.5	500	28	0.78	0.87	4500	470	115	132, A300
	Δ		1425	135	20.1	360	43.7	156	51.0	500	50	0.86	0.86				
<b>MDFQA 112-22, 100</b>	Y	112	1670	130	22.7	360	49.1	156	59.0	500	58	0.87	0.85				
	Δ		2935	125	38.4	360	81.9	156	102.0	500	100	0.90	0.83				
<b>MDFQA 132-32, 36</b>	Y	132	550	296	17.0	360	45.2	325	52.6	1100	20	0.74	0.81	4500	1310	170	200, A400
	Δ		1030	288	31.1	360	77.4	325	90.2	1100	36	0.84	0.77				
<b>MDFQA 132-32, 76</b>	Y	132	1200	282	35.4	360	88.8	325	109.0	1100	42	0.82	0.78				
	Δ		2235	257	60.1	340	144.8	325	196.5	1100	76	0.88	0.80				

1) without brake, with resolver

3) frame size and flange of a standard motor with similar flange and shaft dimensions

5) when  $V_{rated}$ :  $P = P_{rated}$  up to  $2.3 \cdot n_{rated}$

6) magnetic / mechanical permissible torque



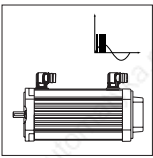

# Selection

## Torque-limit characteristics

Duty type: Continuous operation S6, 10 min load cycle with terminal box connection

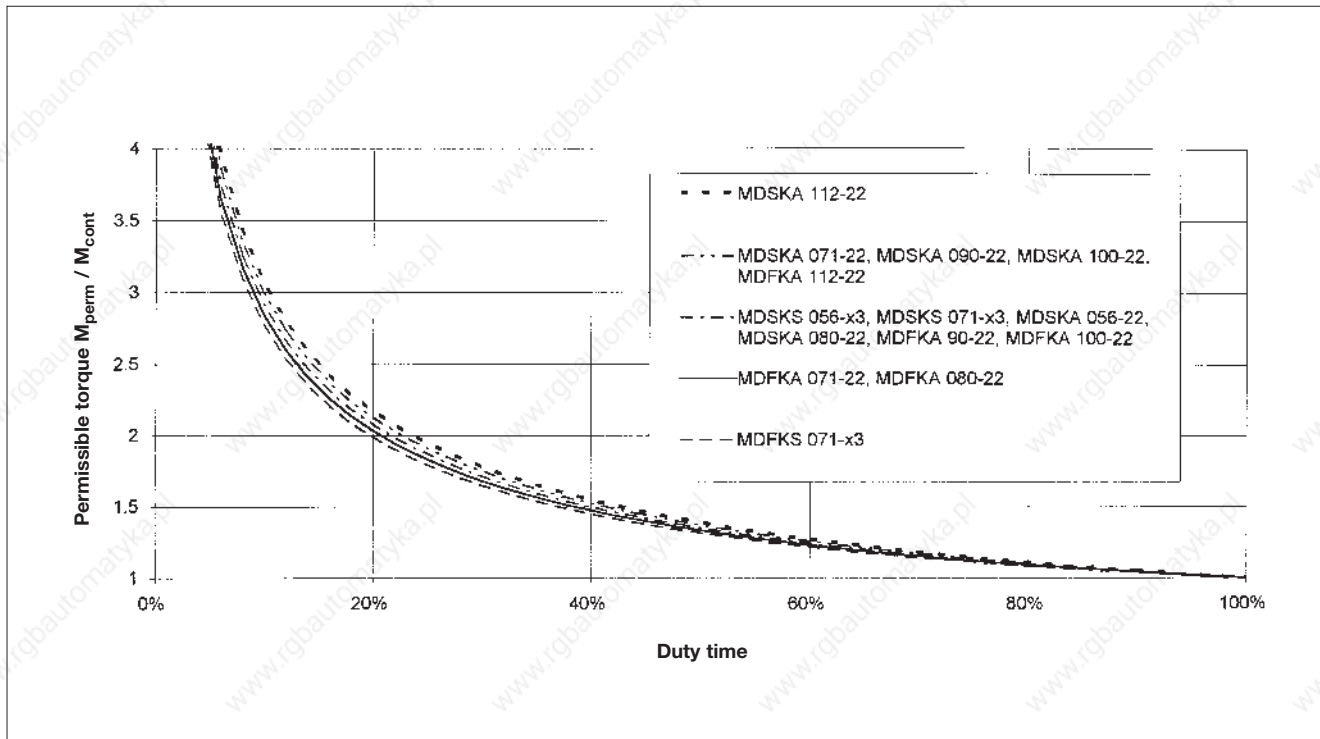

Duty type: Continuous operation S6, 1 min load cycle with terminal box connection

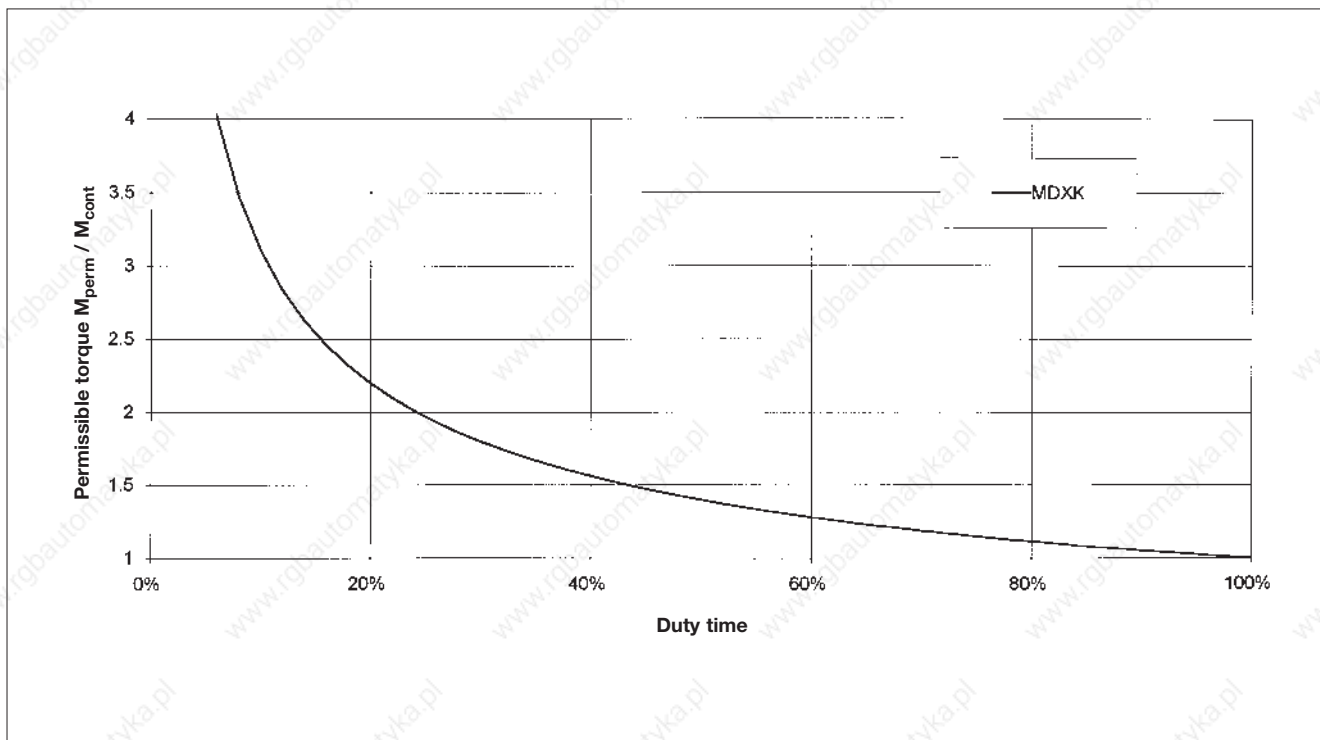

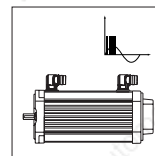

Duty type: Short time operation S2 with terminal box connection

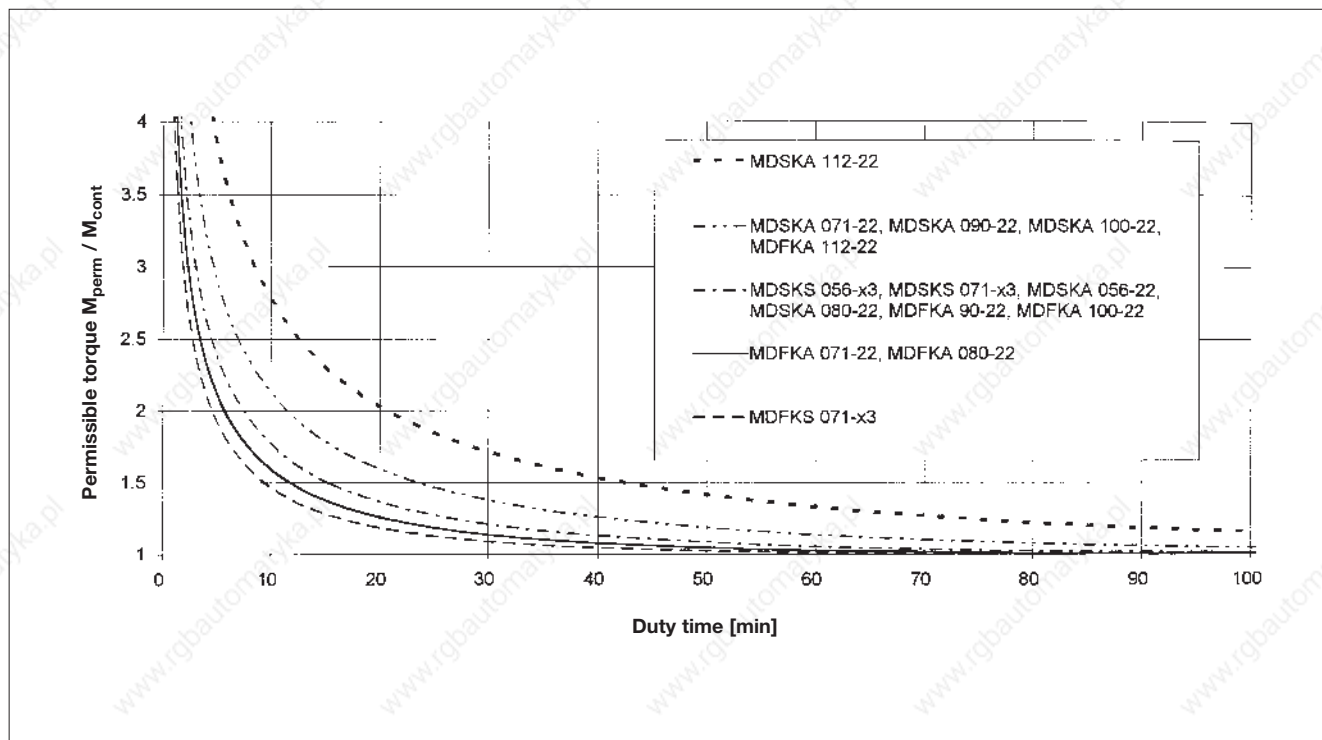

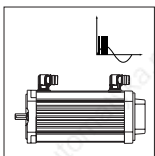

# Selection

## Torque-limit characteristics

**Motor-inverter combination:**  
**Maximum and permanent torque synchronous servo motor MDSKS 036-13, 200 Hz without fan**  
**Inverters 9321-9323**

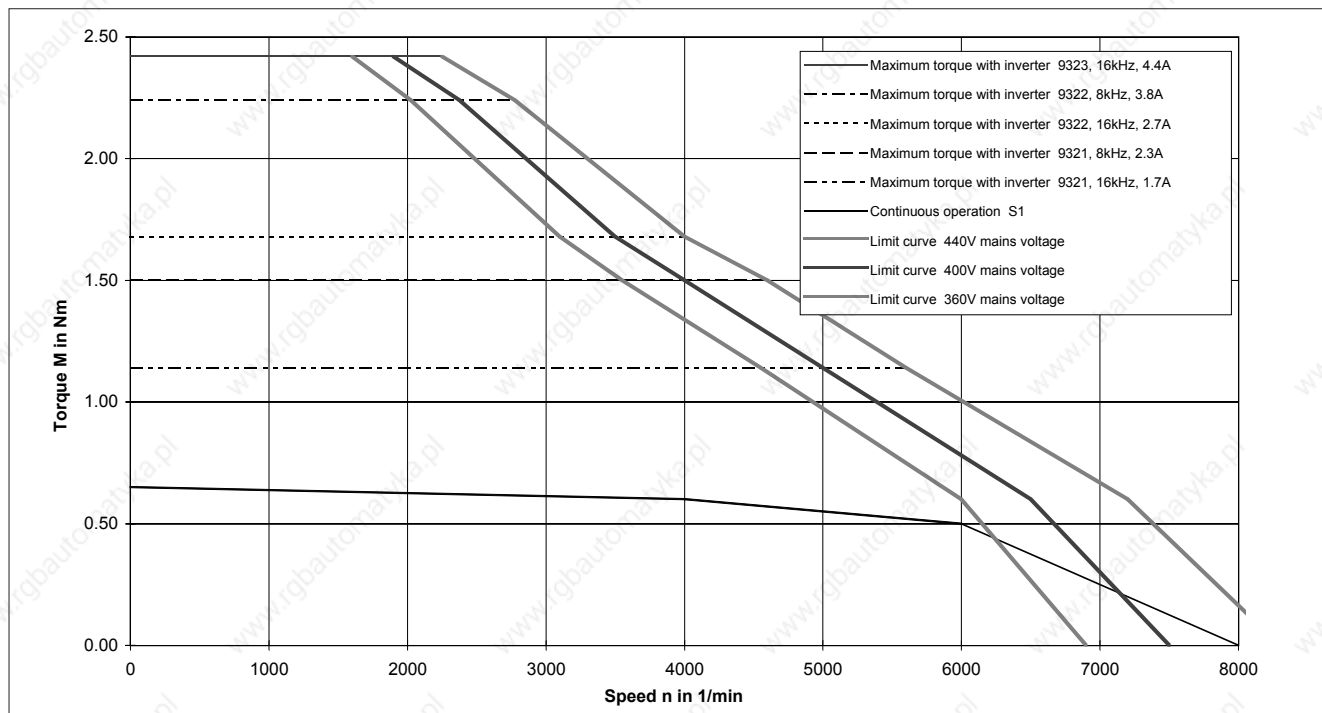

**Motor-inverter combination:**  
**Maximum and permanent torque synchronous servo motor MDSKS 036-23, 200 Hz without fan**  
**Inverters 9321-9323**

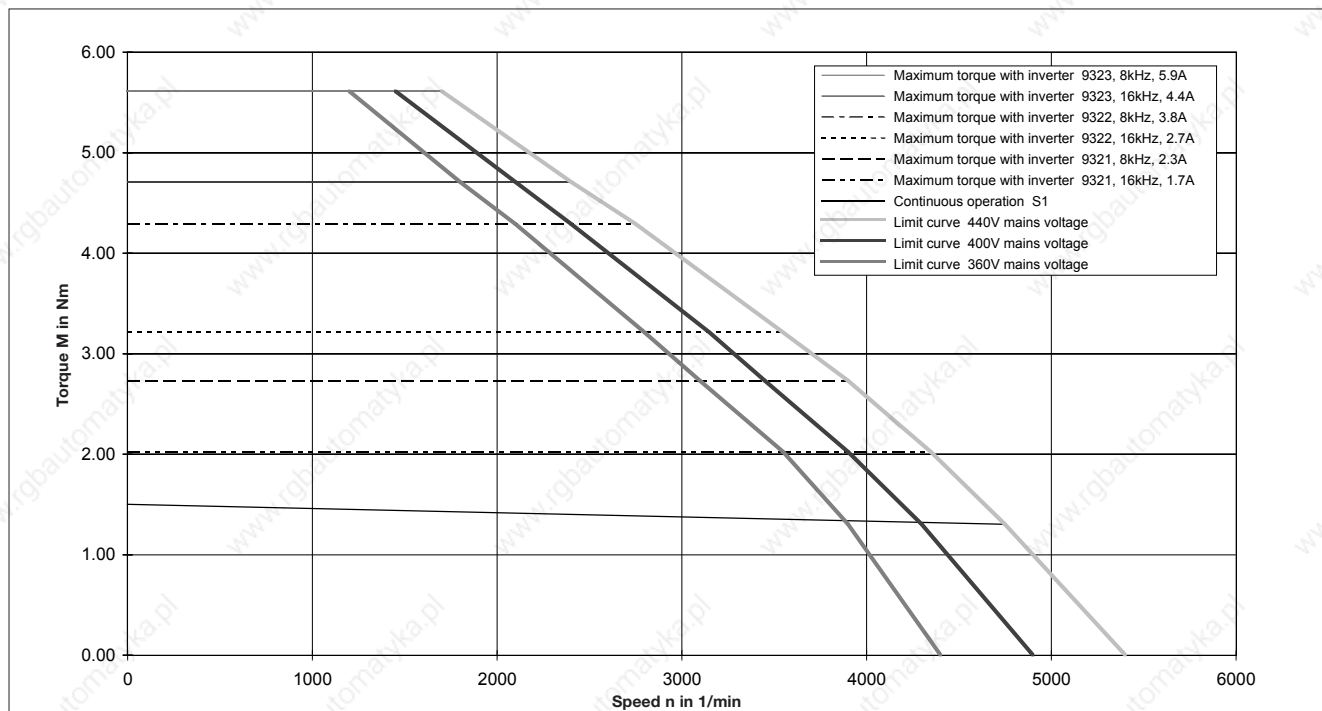



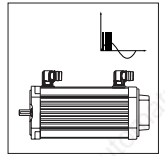

**Motor-inverter combination:  
Maximum and permanent torque synchronous servo motor MDSKS 056-23, 190 Hz without fan  
Inverters 9321-9323**

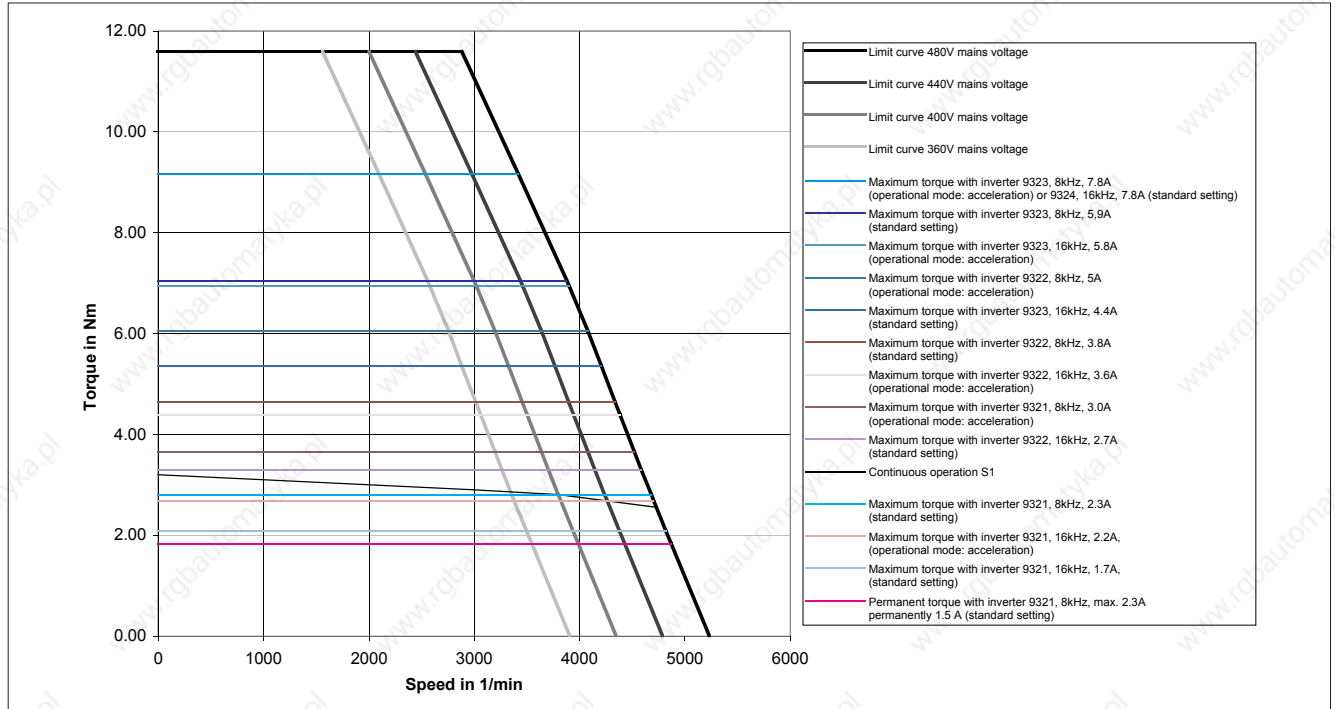

**Motor-inverter combination:  
Maximum and permanent torque synchronous servo motor MDSKS 056-33, 200 Hz without fan  
Inverters 9322-9325**

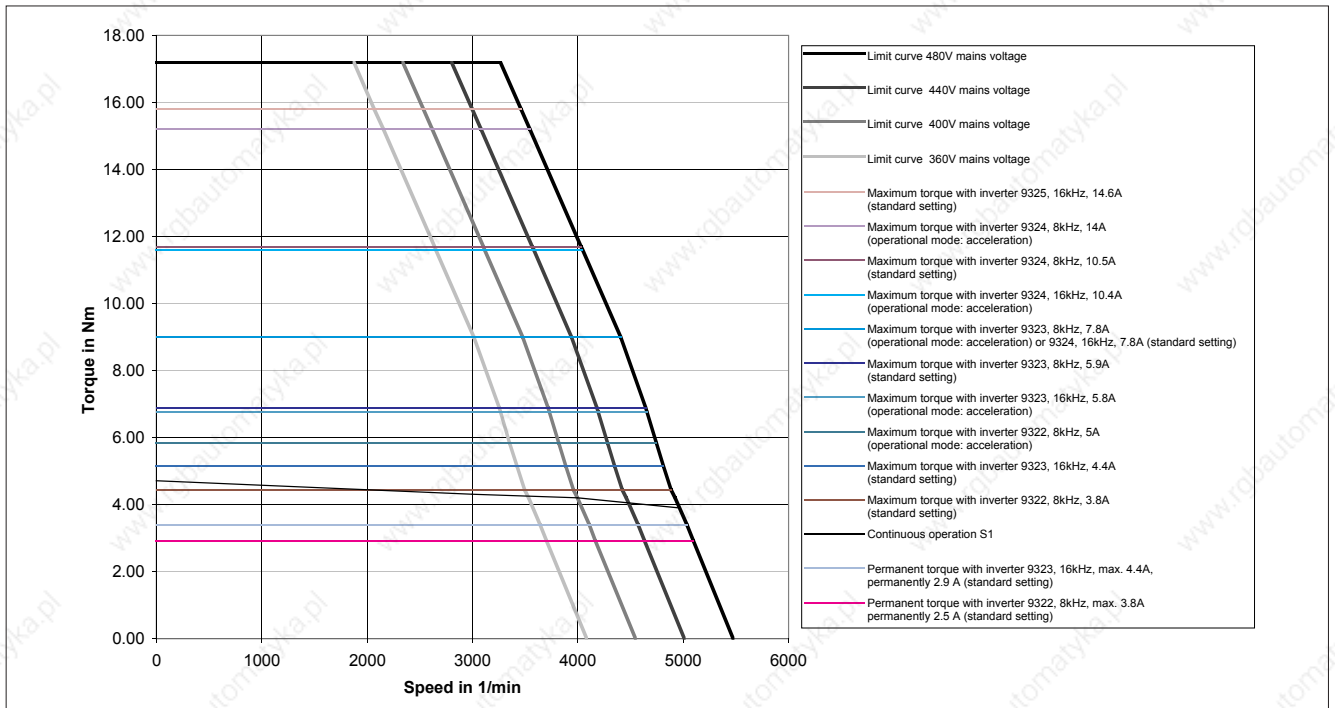

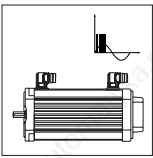

# Selection

## Torque-limit characteristics

**Motor-inverter combination:**  
**Maximum and permanent torque synchronous servo motor MDSKS 071-03, 170 Hz without fan**  
**Inverters 9323-9325**

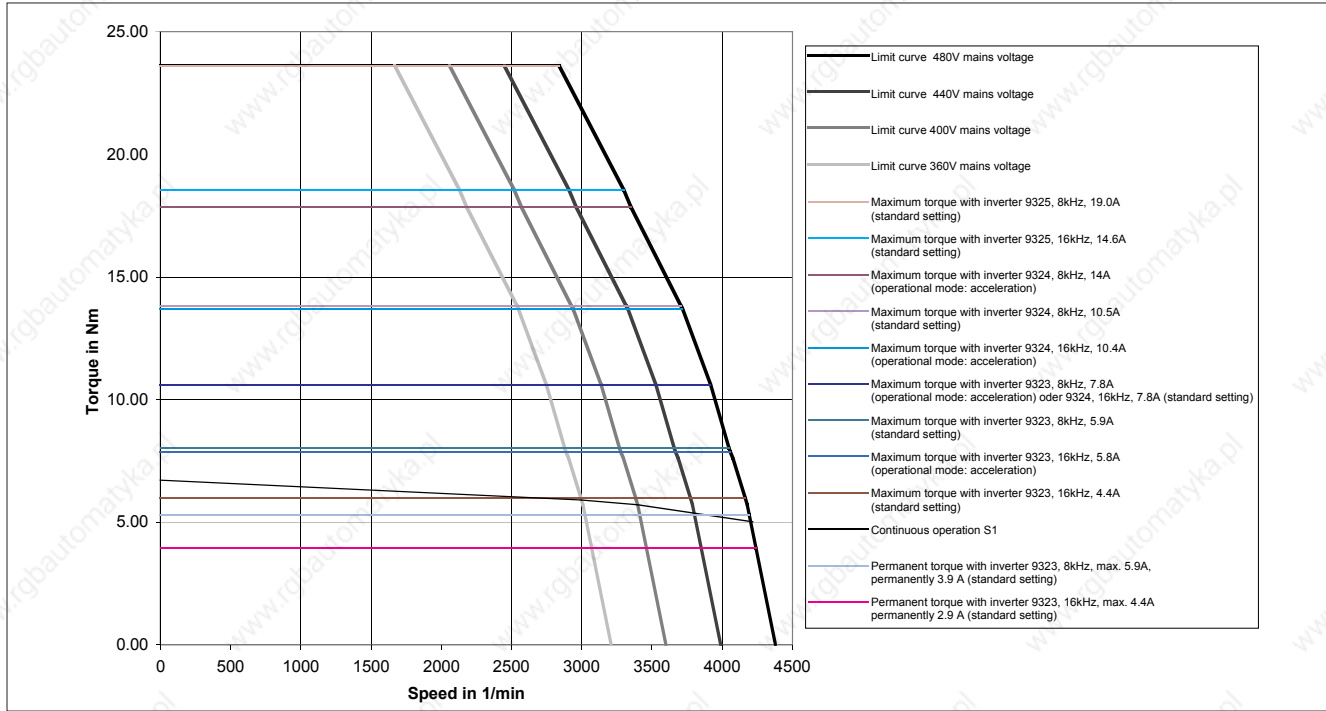

**Motor-inverter combination:**  
**Maximum and permanent torque synchronous servo motor MDFKS 071-03, 165 Hz with fan**  
**Inverters 9323-9325**

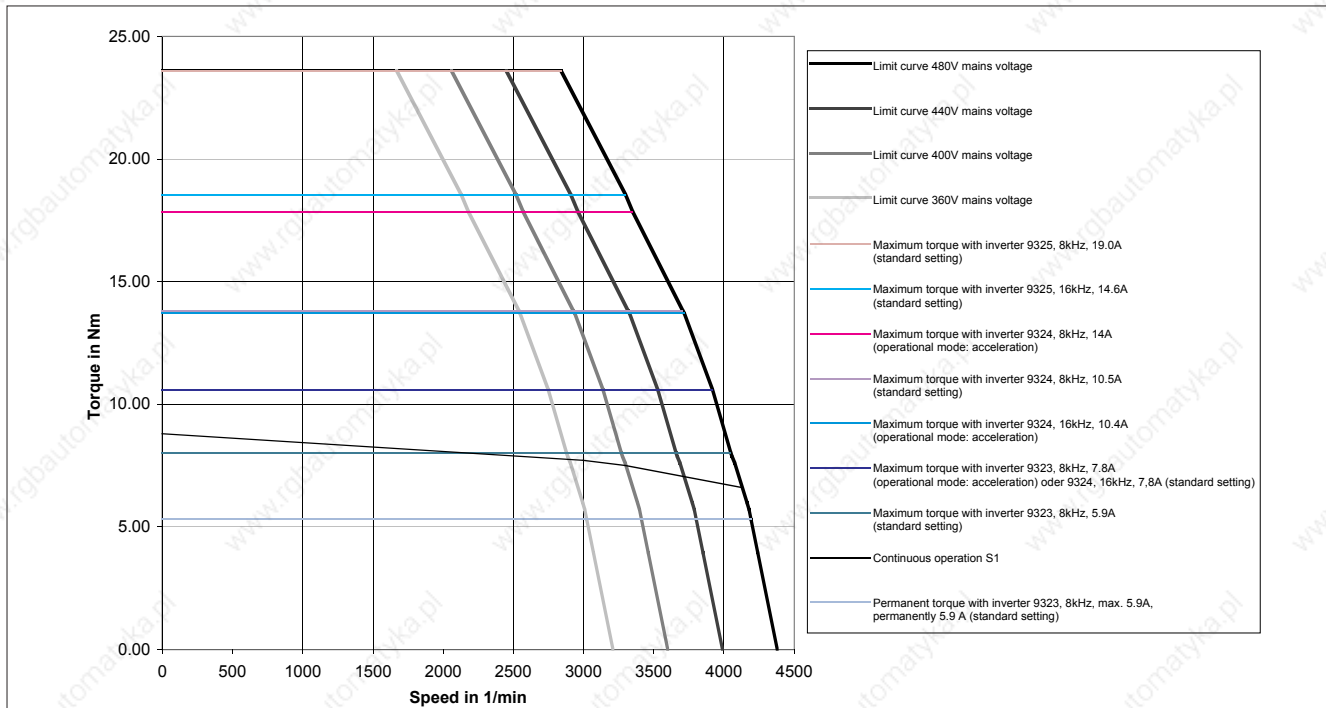

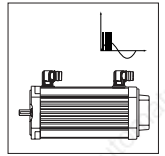

**Motor-inverter combination:  
Maximum and permanent torque synchronous servo motor MDSKS 071-13, 185 Hz without fan  
Inverters 9323-9327**

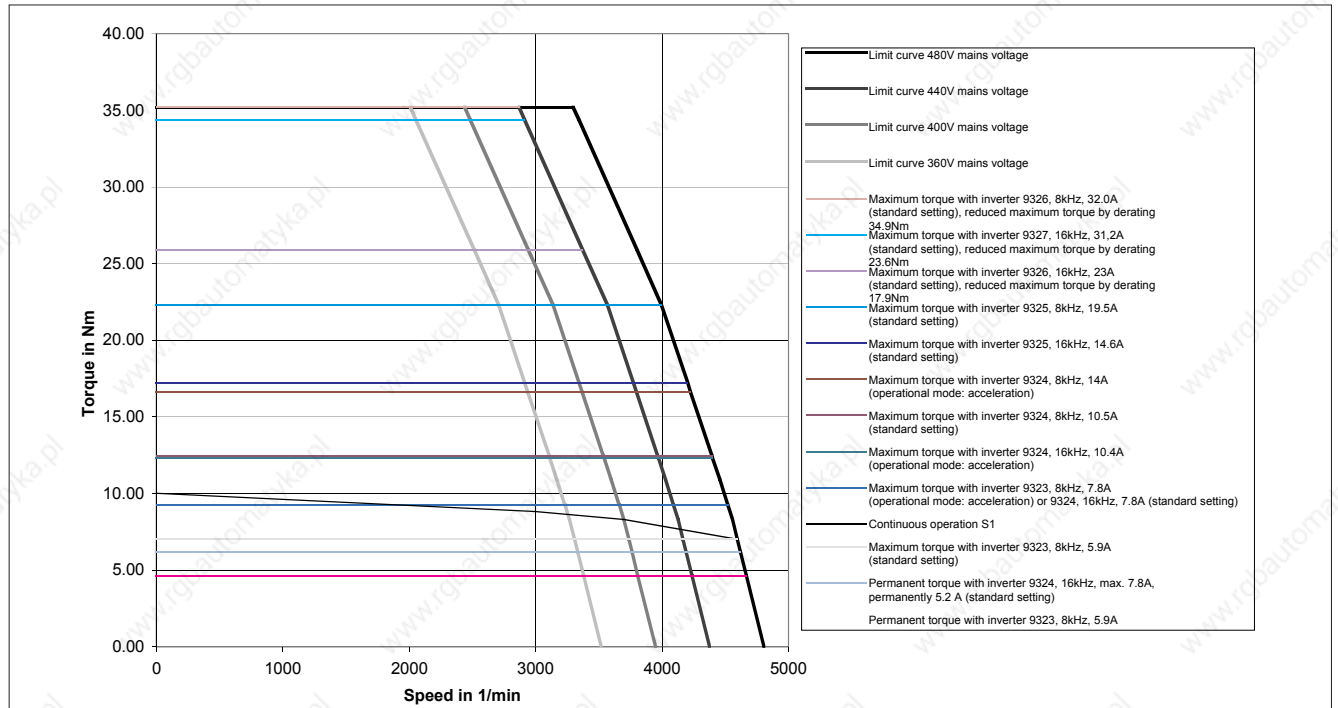

**Motor-inverter combination:  
Maximum and permanent torque synchronous servo motor MDFKS 071-13, 180 Hz with fan  
Inverters 9323-9327**

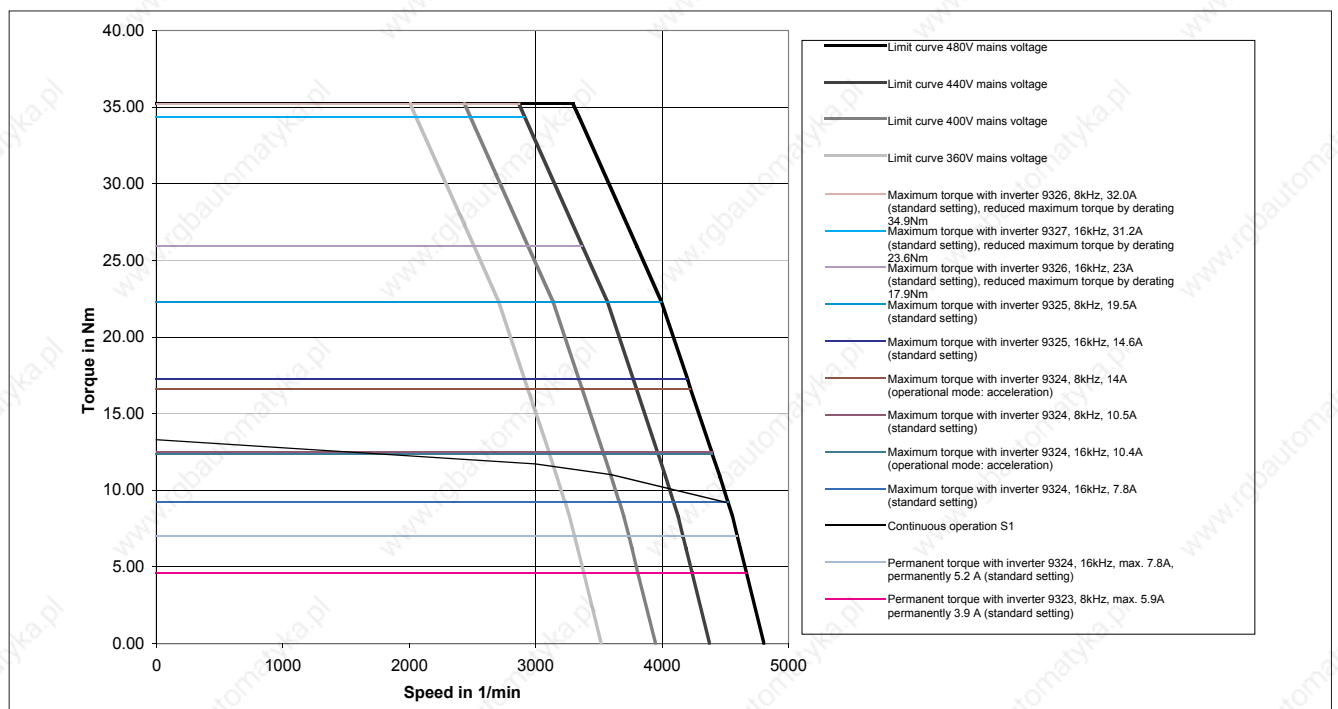

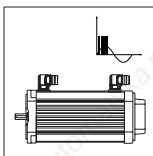

# Selection

## Torque-limit characteristics

**Motor-inverter combination:**  
**Maximum and permanent torque synchronous servo motor MDSKS 071-33, 180 Hz without fan**  
**Inverters 9324-9327**

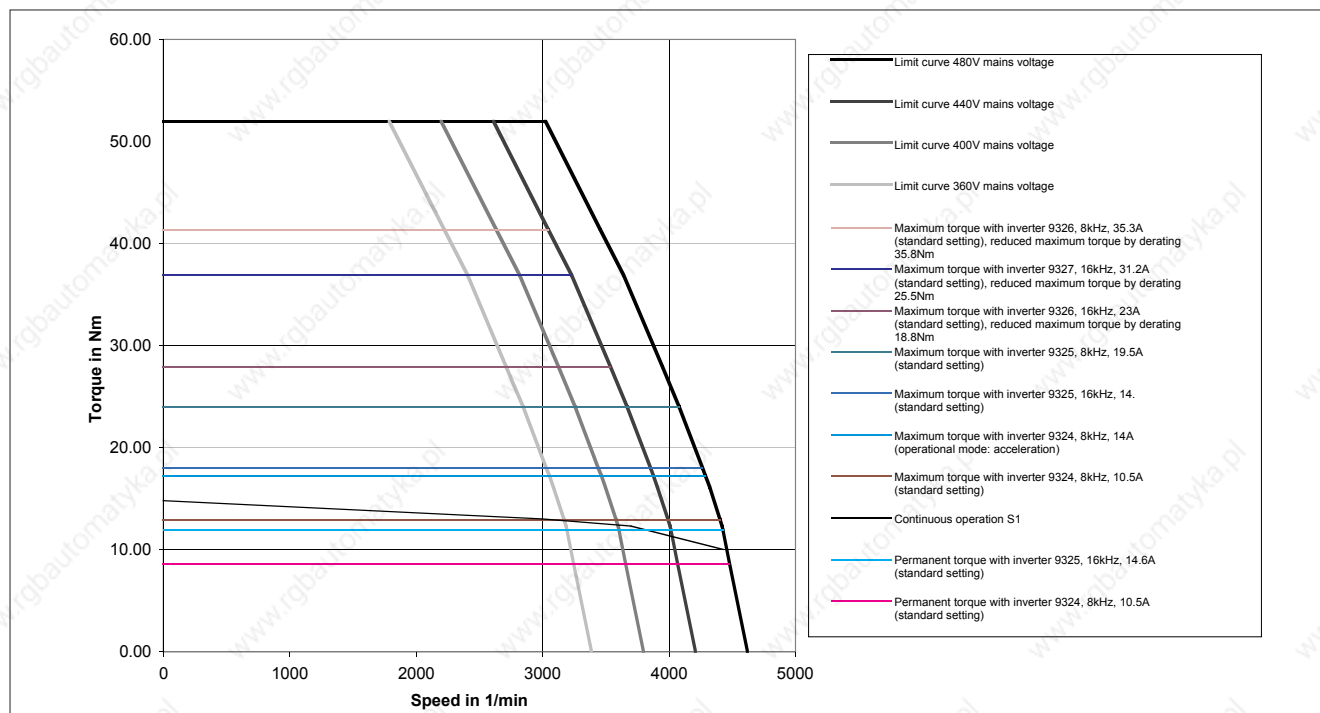

**Motor-inverter combination:**  
**Maximum and permanent torque synchronous servo motor MDFKS 071-33, 175 Hz with fan**  
**Inverters 9324-9327**

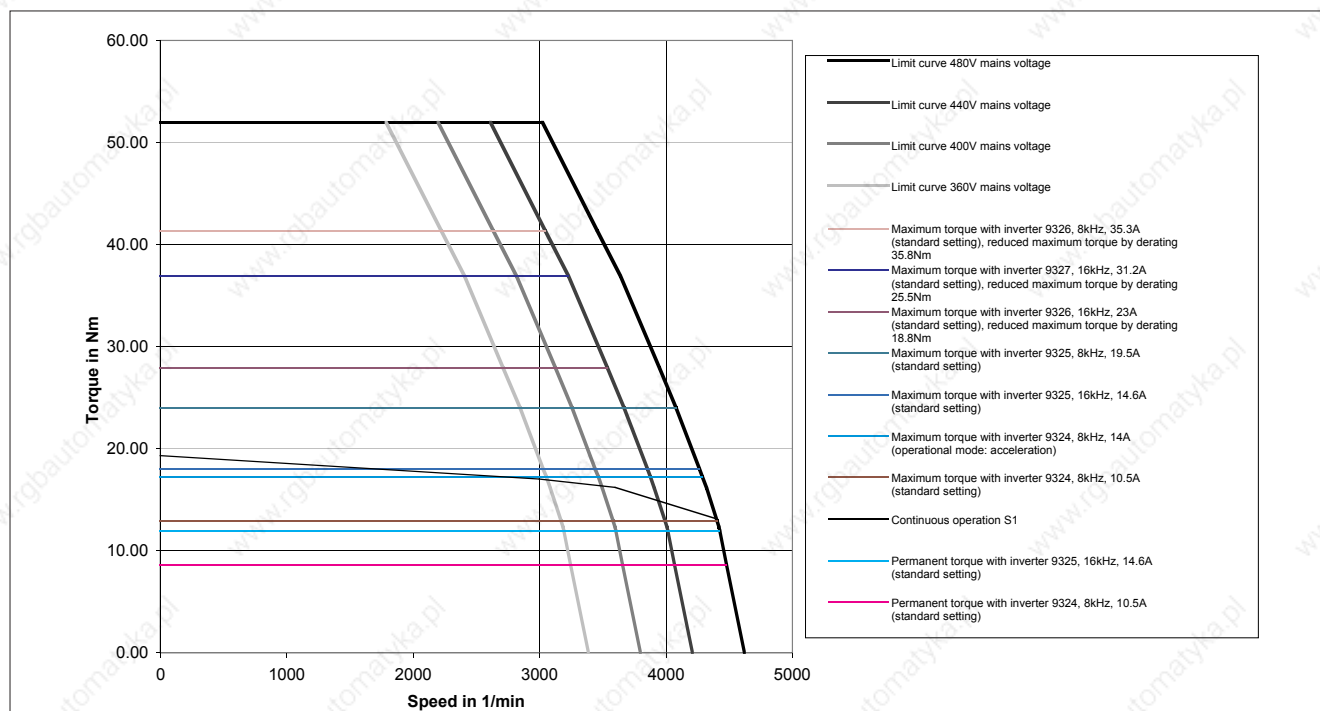

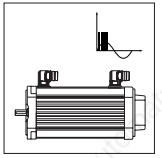

**Motor-inverter combination:  
Maximum and permanent torque asynchronous servo motor MDSKA 056, 140 Hz without fan  
Inverters 9322-9324**

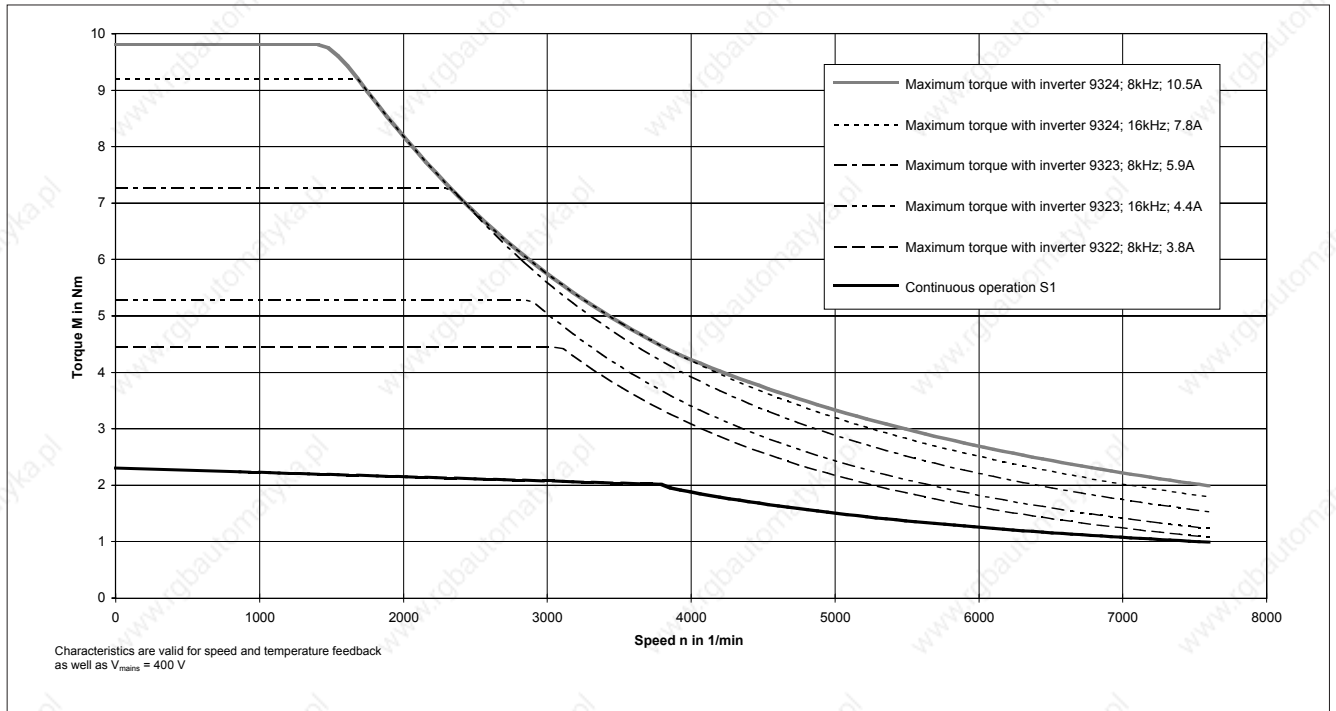

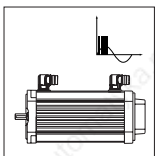

# Selection

## Torque-limit characteristics

Motor-inverter combination:

Maximum and permanent torque asynchronous servo motor MDSKA 071, 140 Hz without separate fan

Inverters 9324-9325

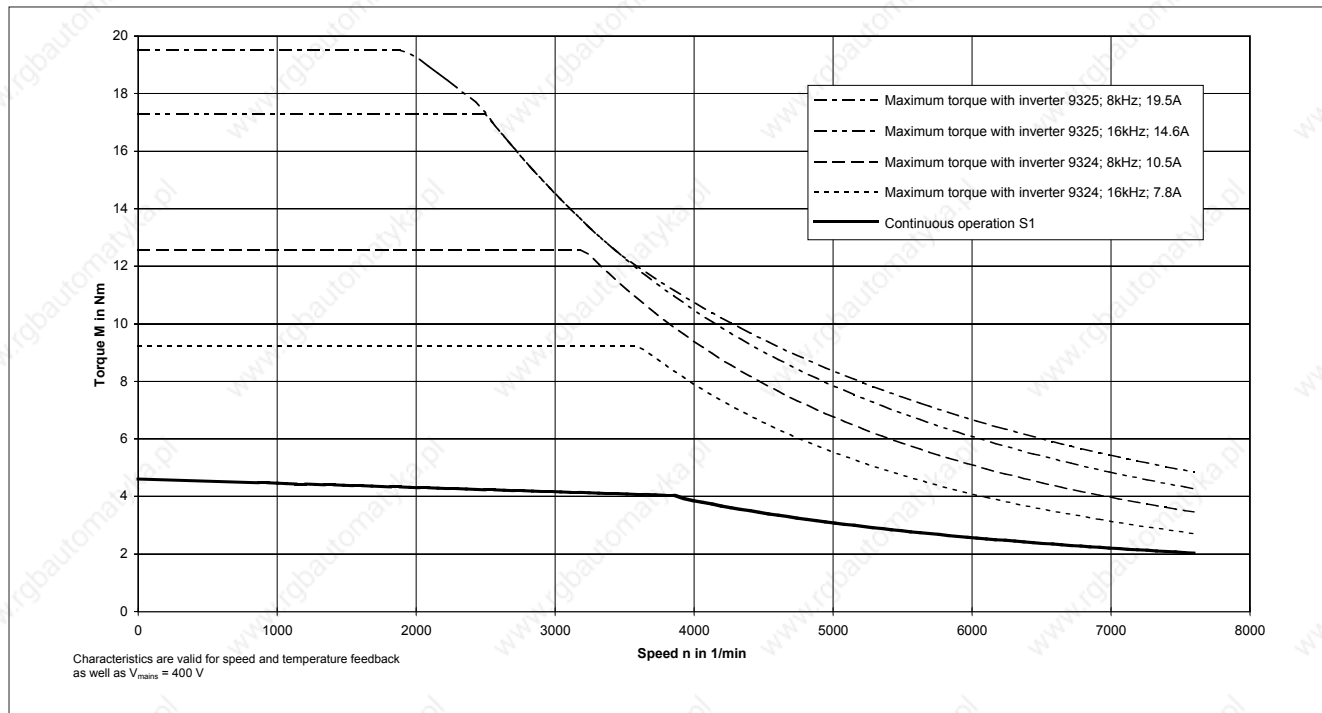

Motor-inverter combination:

Maximum and permanent torque asynchronous servo motor MDFKA 071, 120 Hz with fan

Inverters 9324-9326

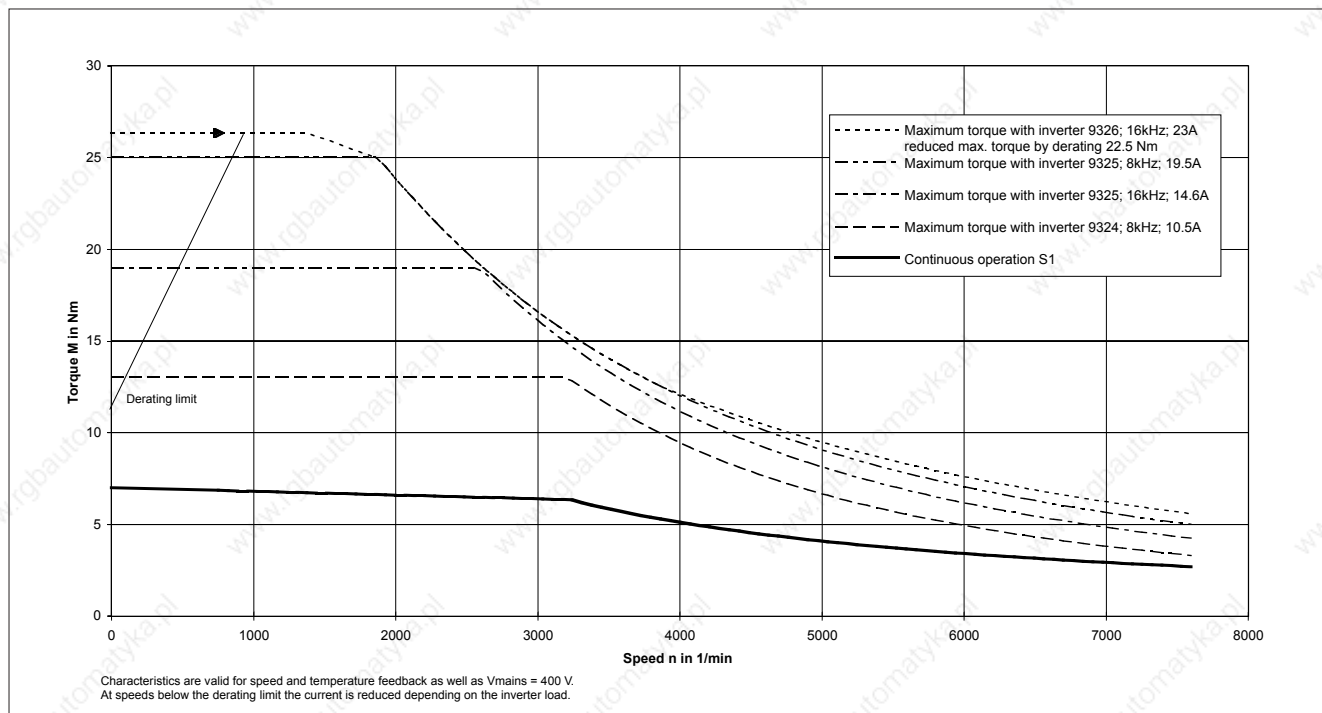

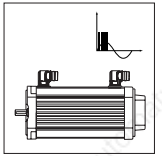

**Motor-inverter combination:  
Maximum and permanent torque asynchronous servo motor MDSKA 080, 70 Hz without fan  
Inverters 9323-9325**

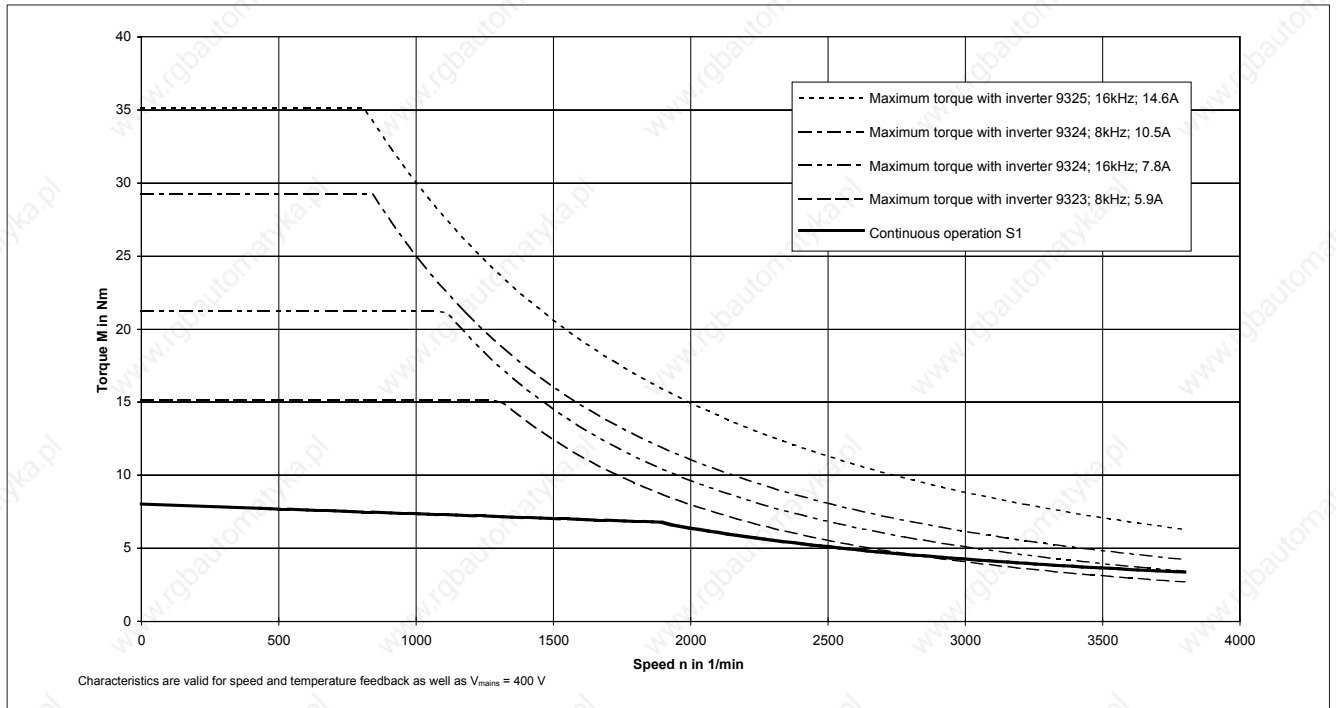

**Motor-inverter combination:  
Maximum and permanent torque asynchronous servo motor MDFKA 080, 60 Hz with separate fan  
Inverters 9324-9325**

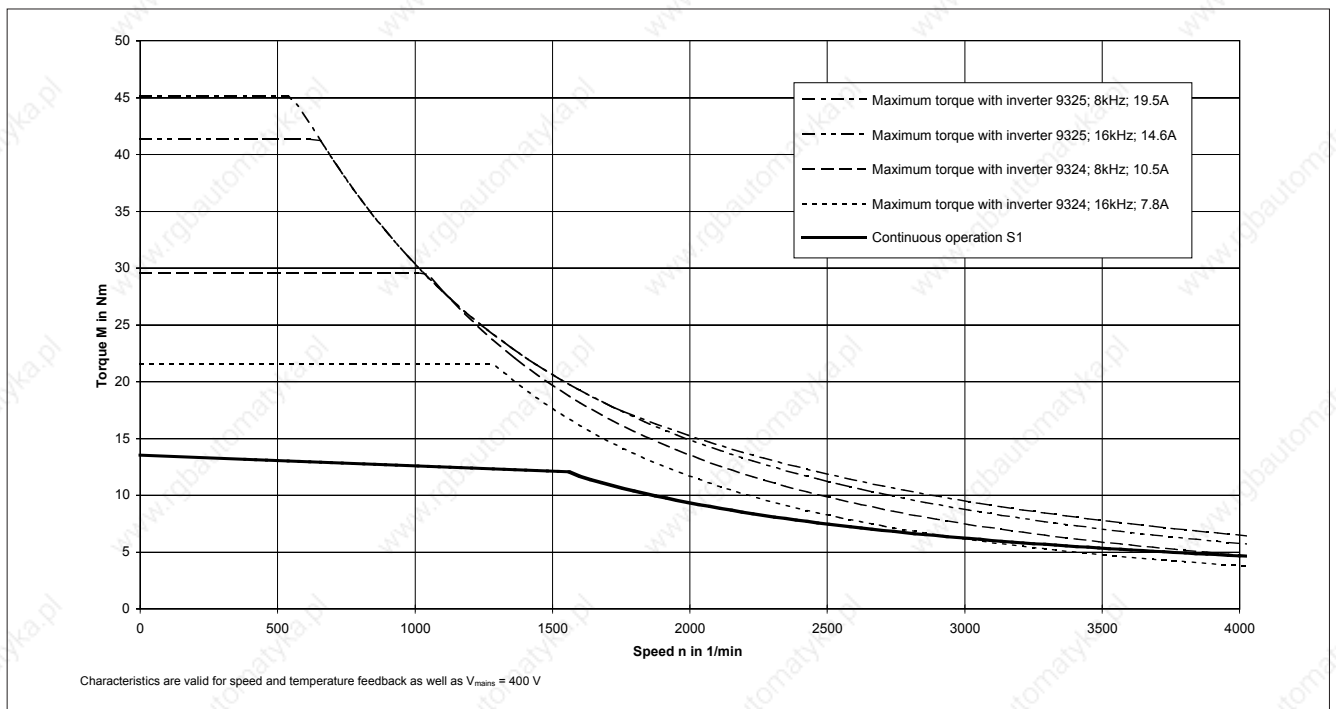

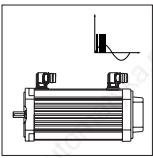

# Selection

## Torque-limit characteristics

Motor-inverter combination:

Maximum and permanent torque asynchronous servo motor MDSKA 080, 140 Hz without fan

Inverters 9324-9326

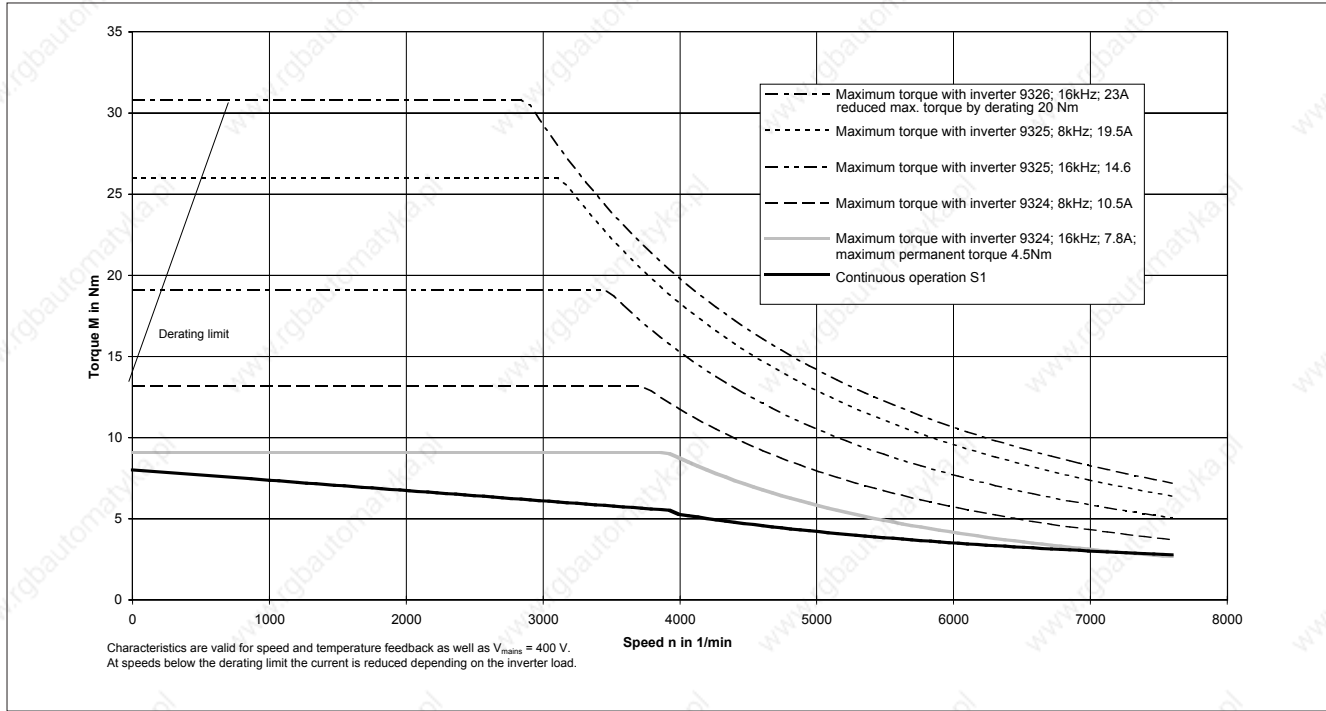

Motor-inverter combination:

Maximum and permanent torque asynchronous servo motor MDFKA 080, 120 Hz with separate fan

Inverters 9325-9327

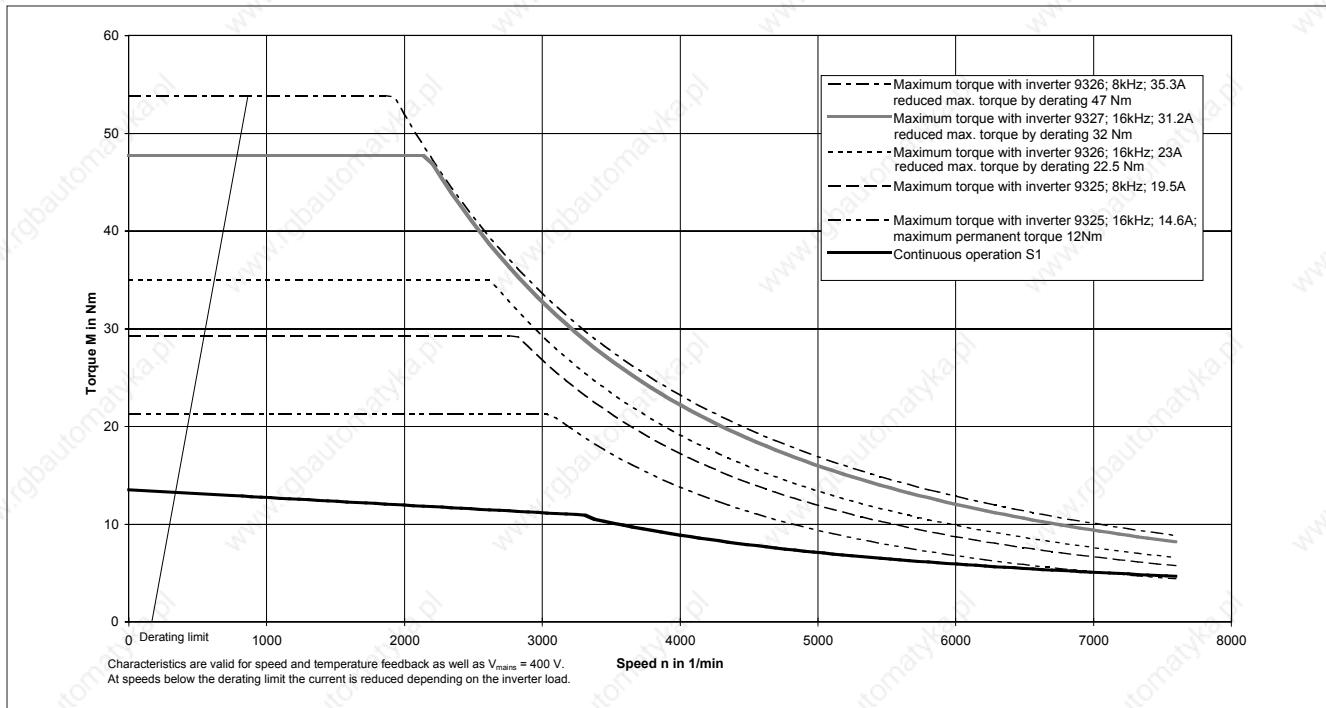



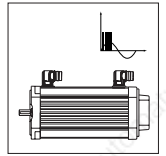

**Motor-inverter combination:  
Maximum and permanent torque asynchronous servo motor MDSKA 090, 80 Hz without fan  
Inverters 9324-9326**

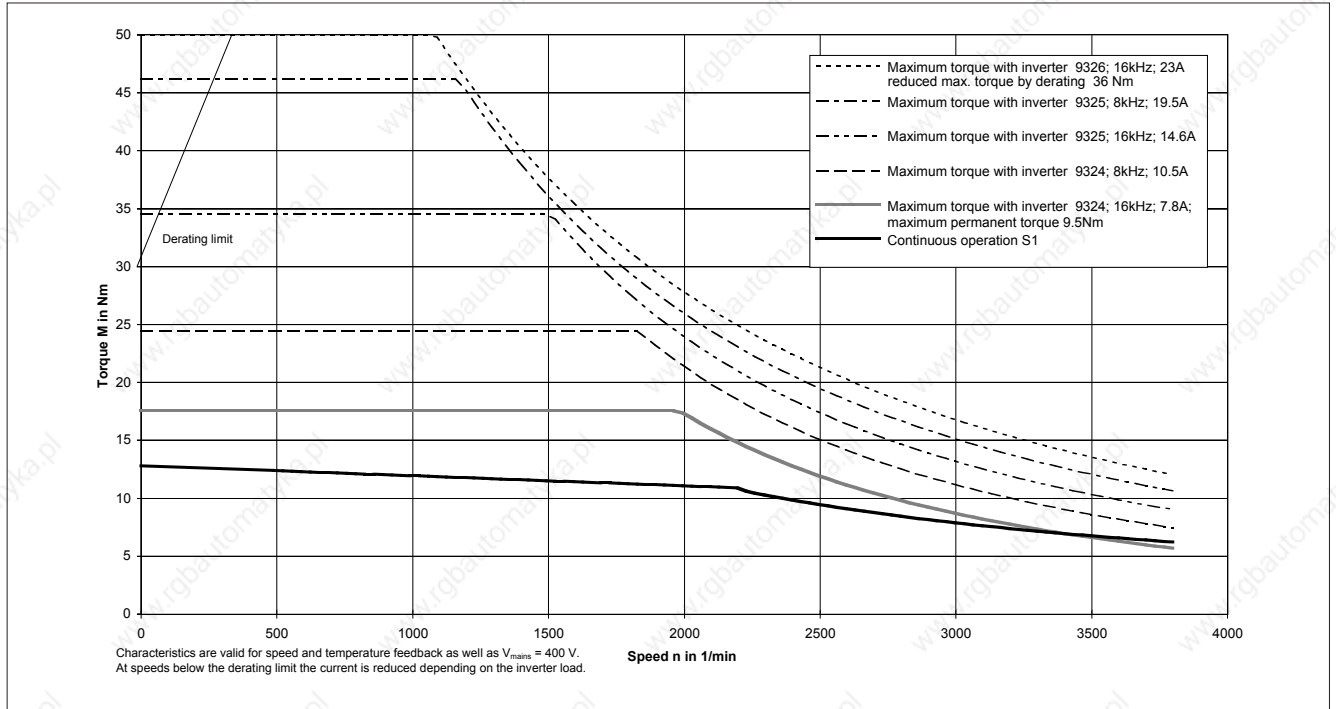

**Motor-inverter combination:  
Maximum and permanent torque asynchronous servo motor MDFKA 090, 60 Hz with separate fan  
Inverters 9325-9327**

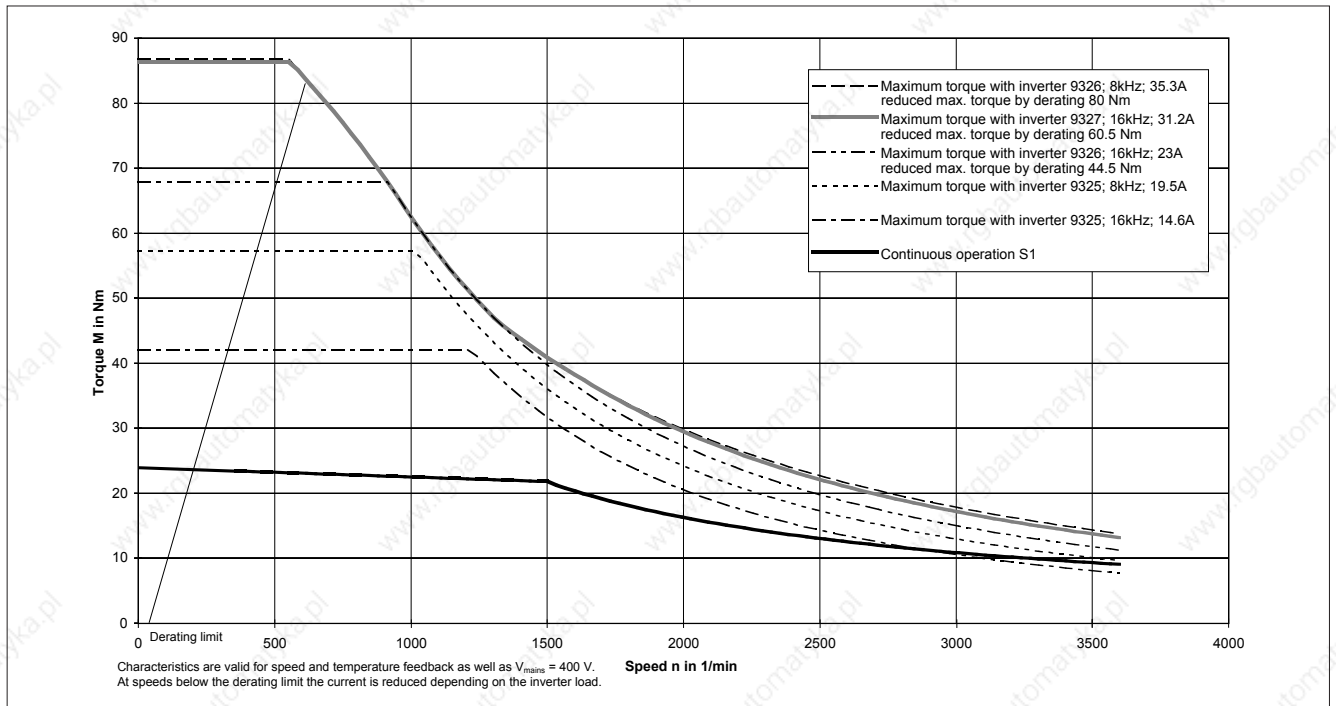

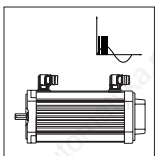

# Selection

## Torque-limit characteristics

**Motor-inverter combination:**  
**Maximum and permanent torque asynchronous servo motor MDSKA 090, 140 Hz without fan**  
**Inverters 9325-9328**

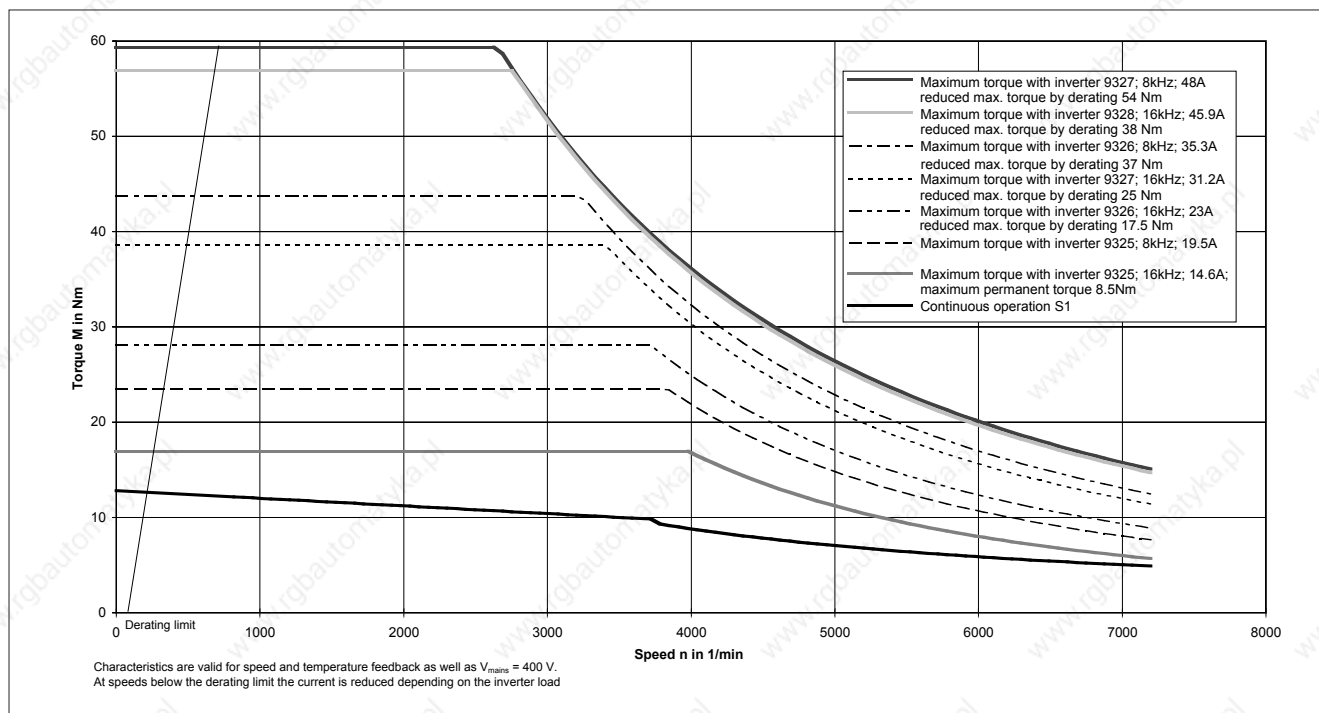

**Motor-inverter combination:**  
**Maximum and permanent torque asynchronous servo motor MDFKA 090, 120 Hz with separate fan**  
**Inverters 9326-9329**

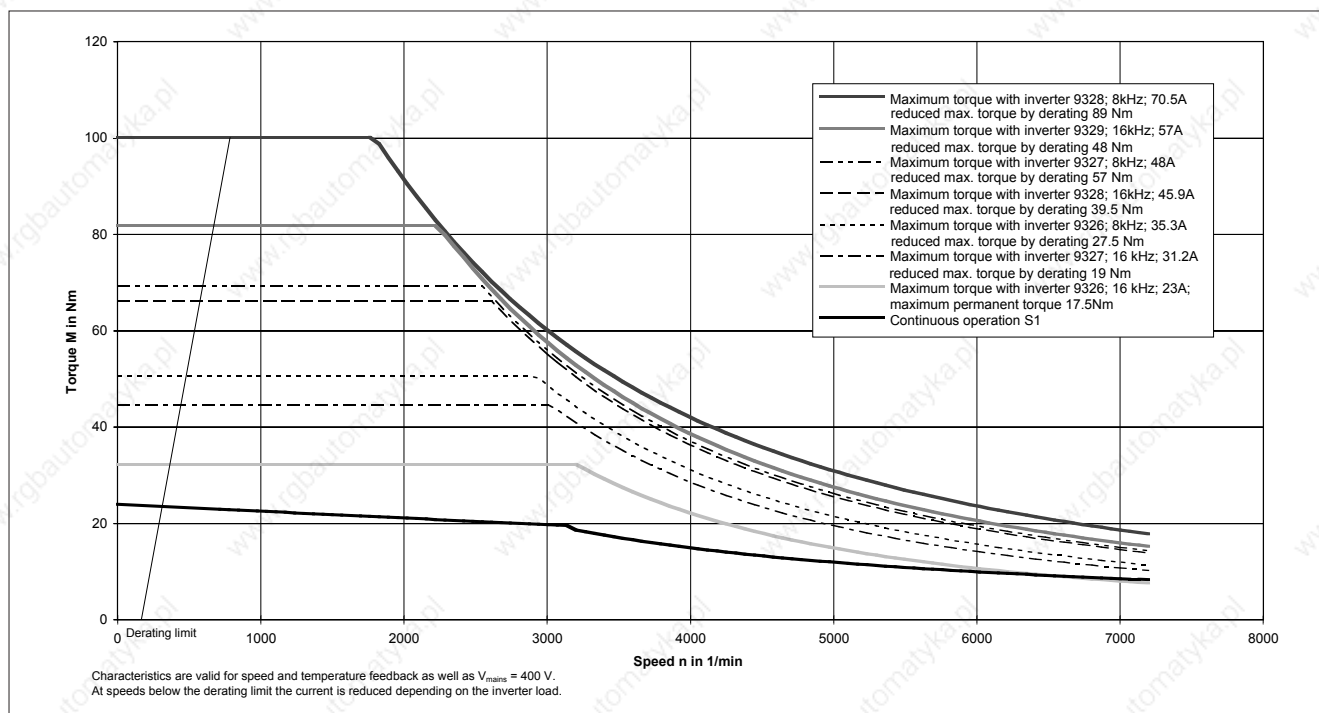

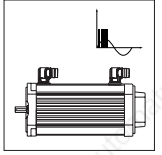

**Motor-inverter combination:  
Maximum and permanent torque asynchronous servo motor MDSKA 100, 80 Hz without fan  
Inverters 9325-9327**

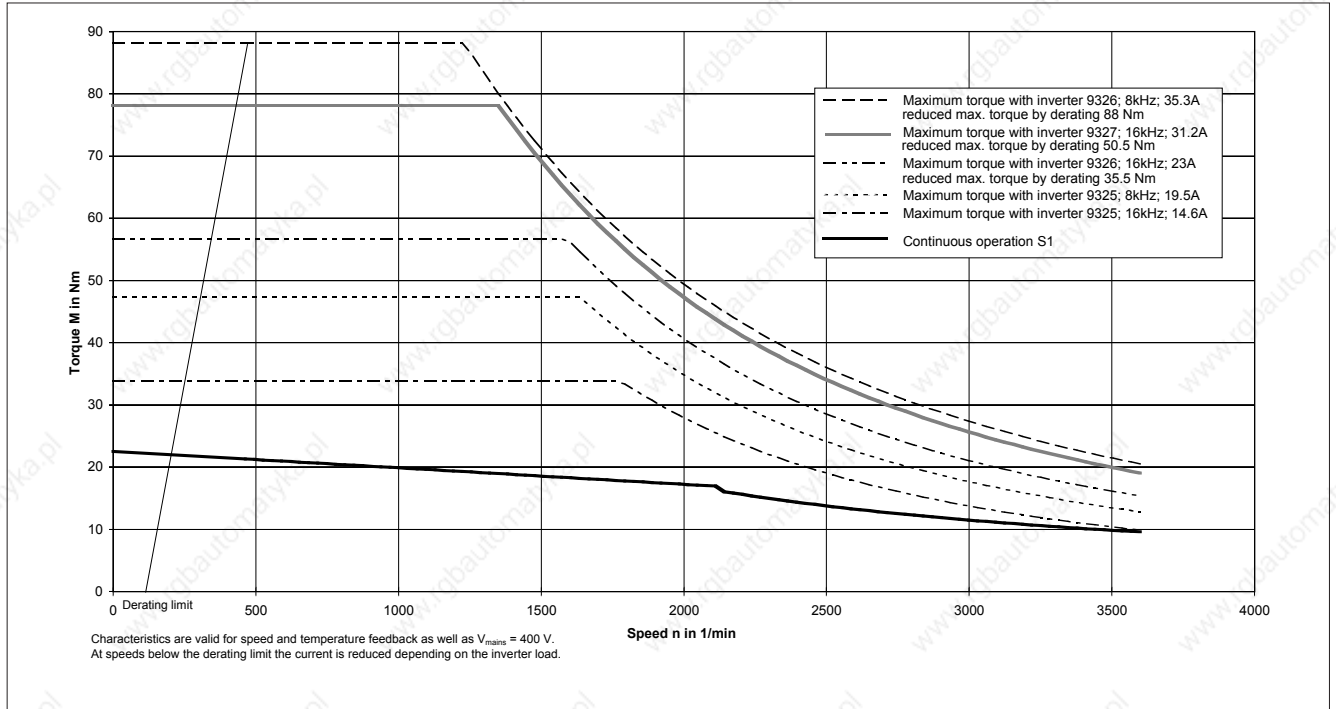

**Motor-inverter combination:  
Maximum and permanent torque asynchronous servo motor MDFKA 100, 60 Hz with separate fan  
Inverters 9325-9329**

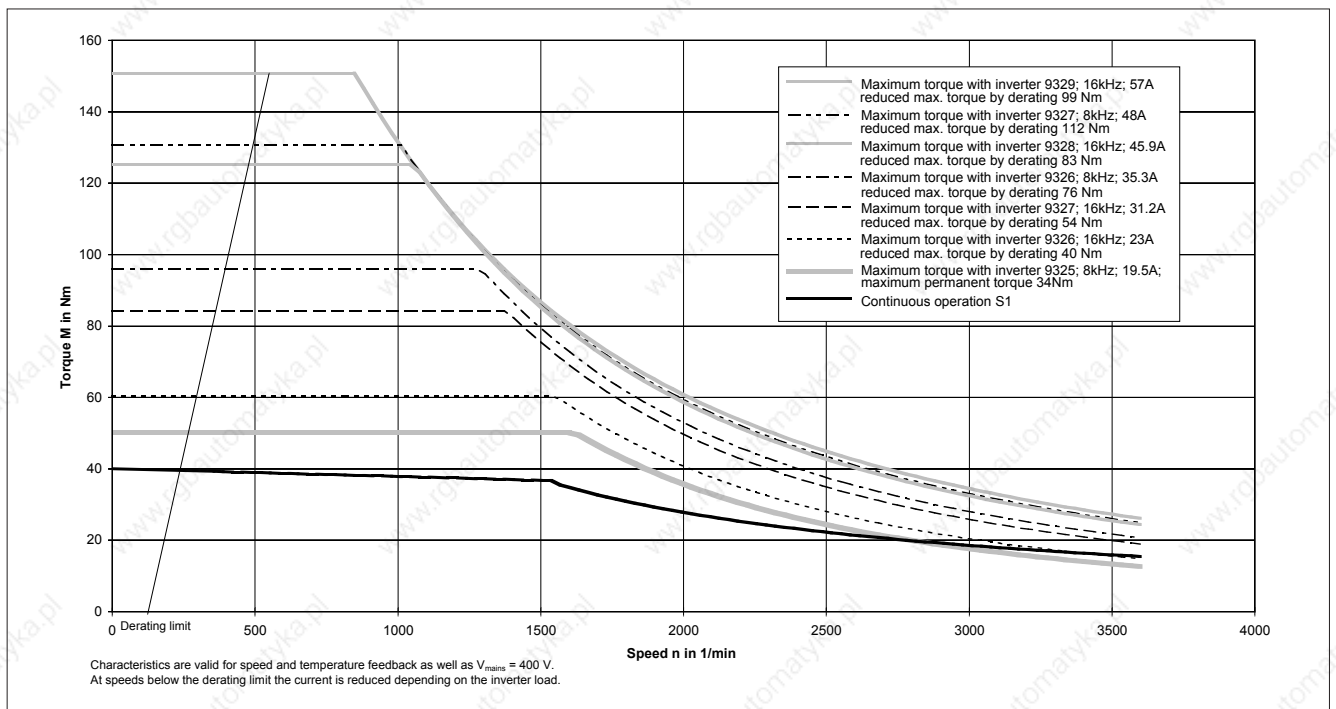

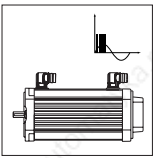

# Selection

## Torque-limit characteristics

**Motor-inverter combination:**  
**Maximum and permanent torque asynchronous servo motor MDSKA 100, 140 Hz without fan**  
**Inverters 9325-9328**

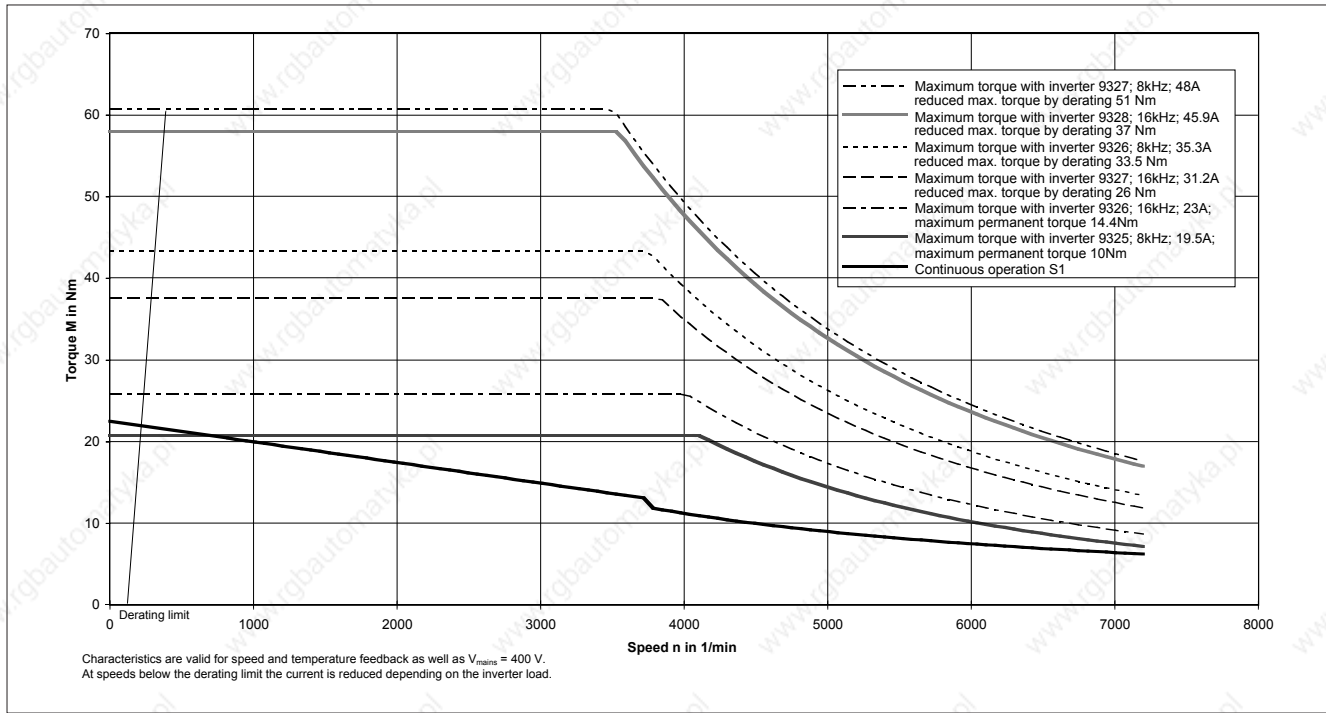

**Motor-inverter combination:**  
**Maximum and permanent torque asynchronous servo motor MDFKA 100, 120 Hz with separate fan**  
**Inverters 9326-9331**

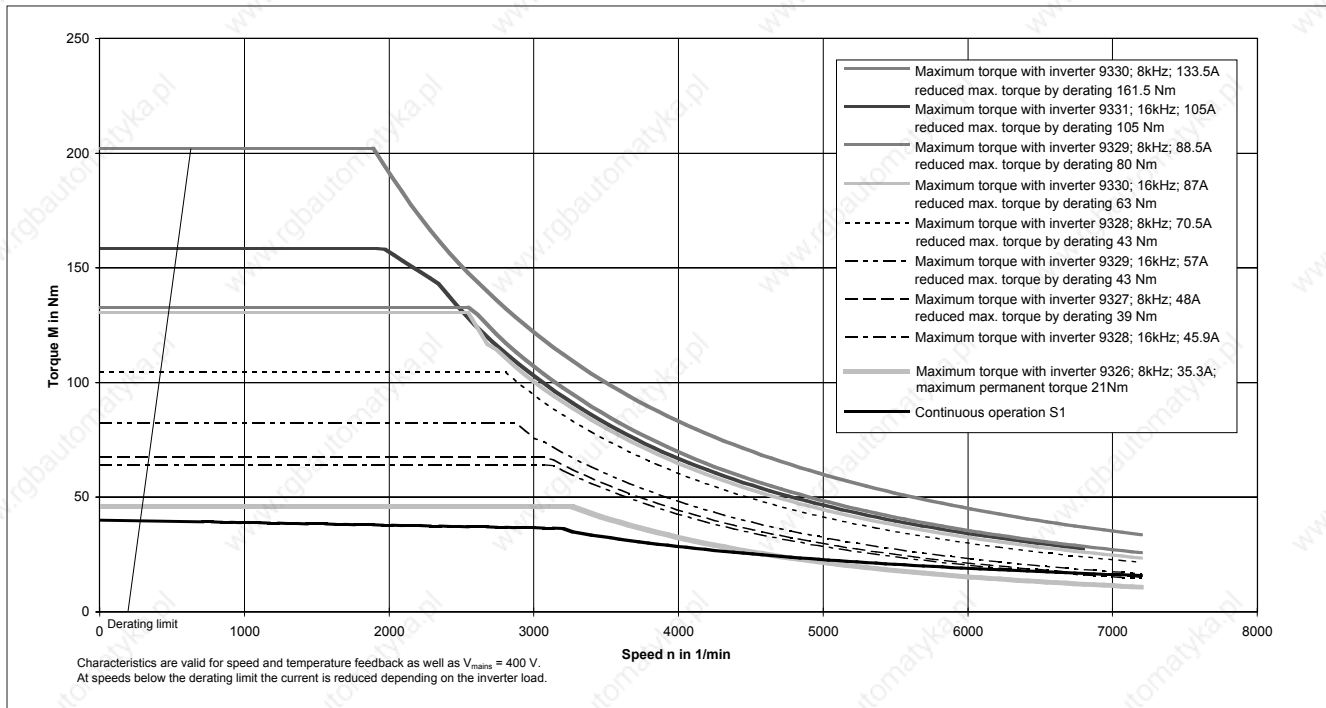

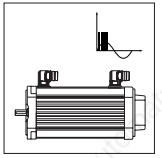

**Motor-inverter combination:  
Maximum and permanent torque asynchronous servo motor MDSKA 112, 85 Hz without fan  
Inverters 9325-9329**

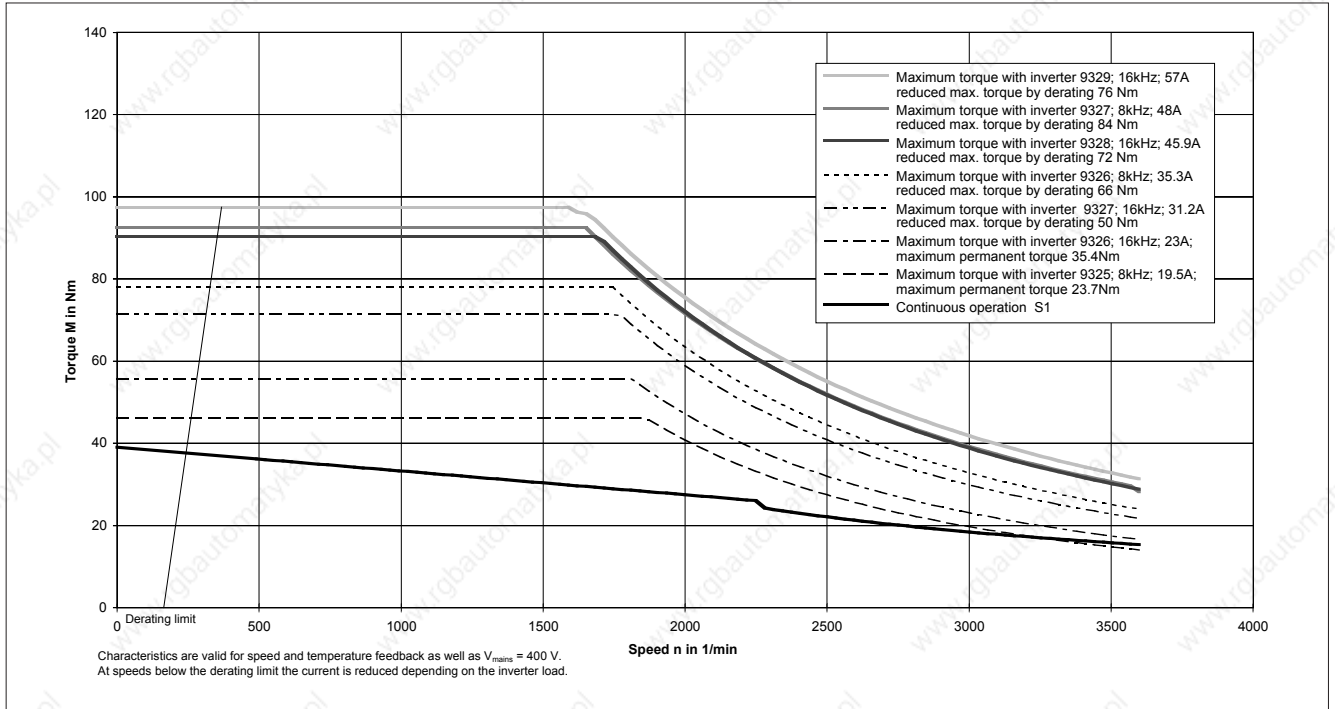

**Motor-inverter combination:  
Maximum and permanent torque asynchronous servo motor MDFKA 112, 60 Hz with separate fan  
Inverters 9326-9330**

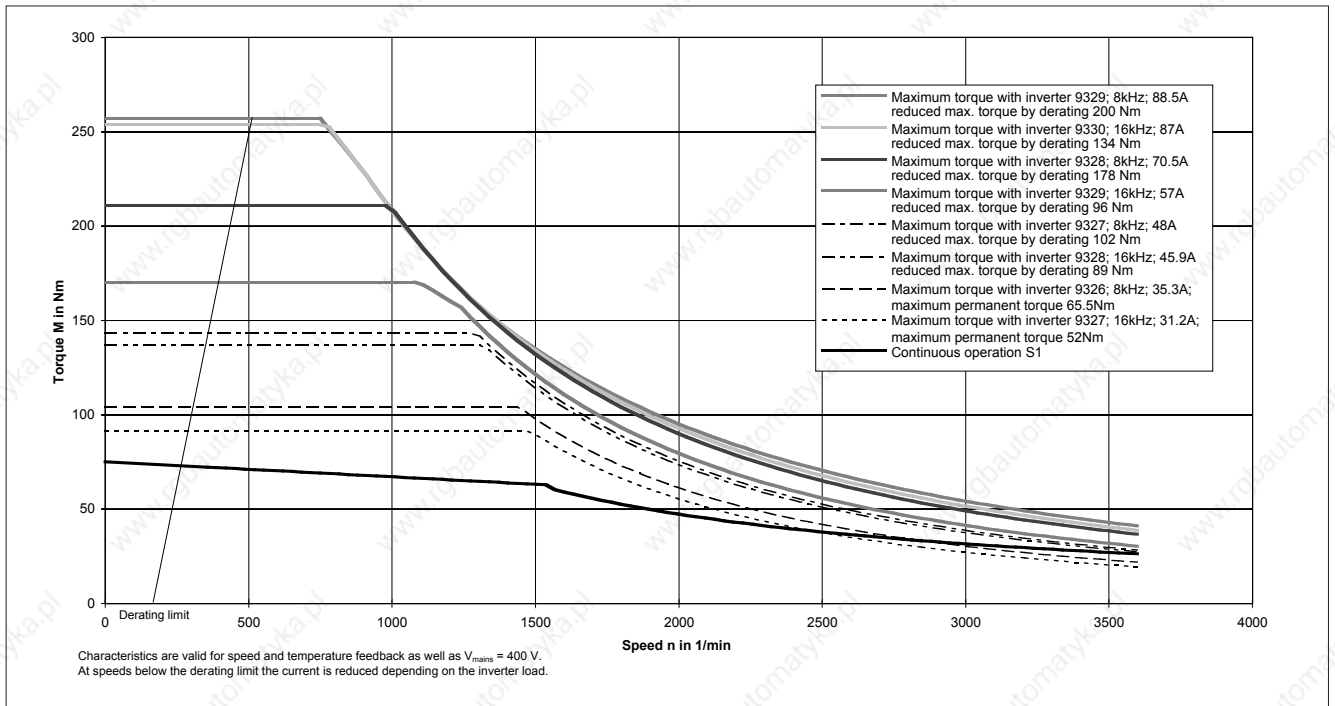

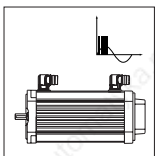

# Selection

## Torque-limit characteristics

**Motor-inverter combination:**  
**Maximum and permanent torque asynchronous servo motor MDSKA 112, 140 Hz without fan**  
**Inverters 9326-9330**

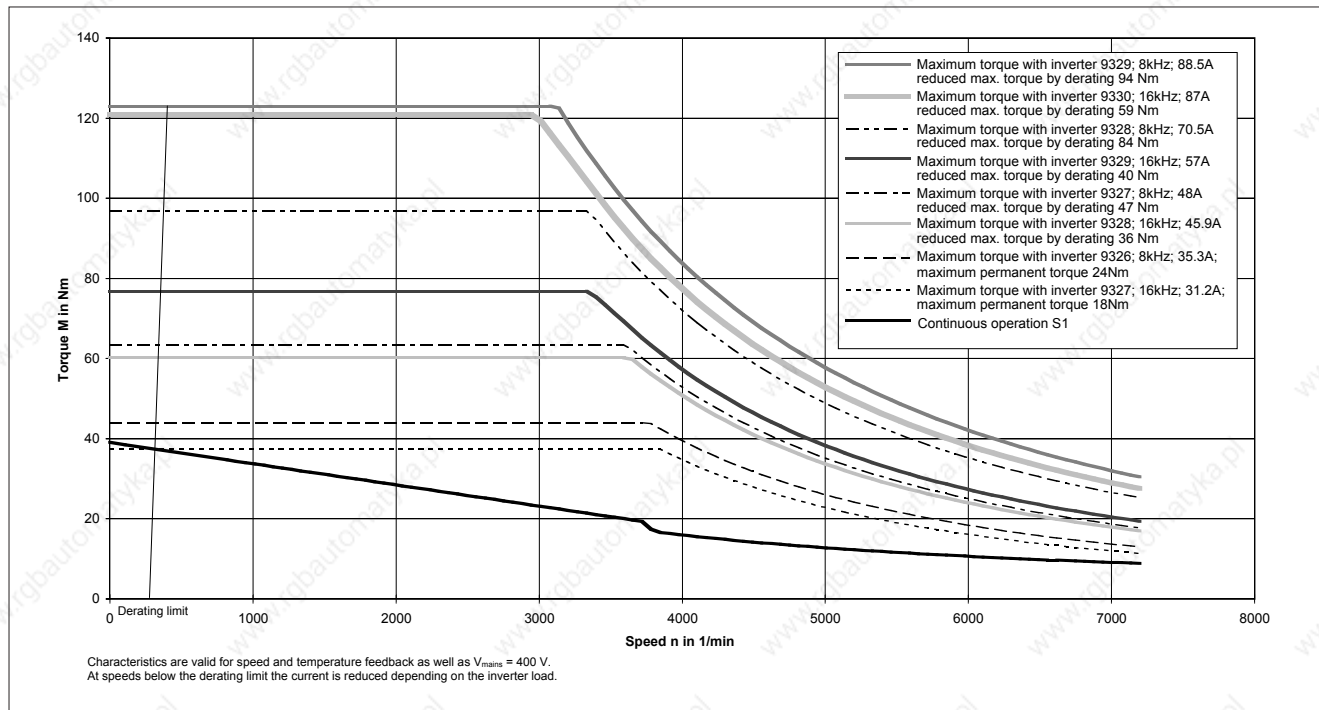

**Motor-inverter combination:**  
**Maximum and permanent torque asynchronous servo motor MDFKA 112, 120 Hz with separate fan**  
**Inverters 9328-9332**

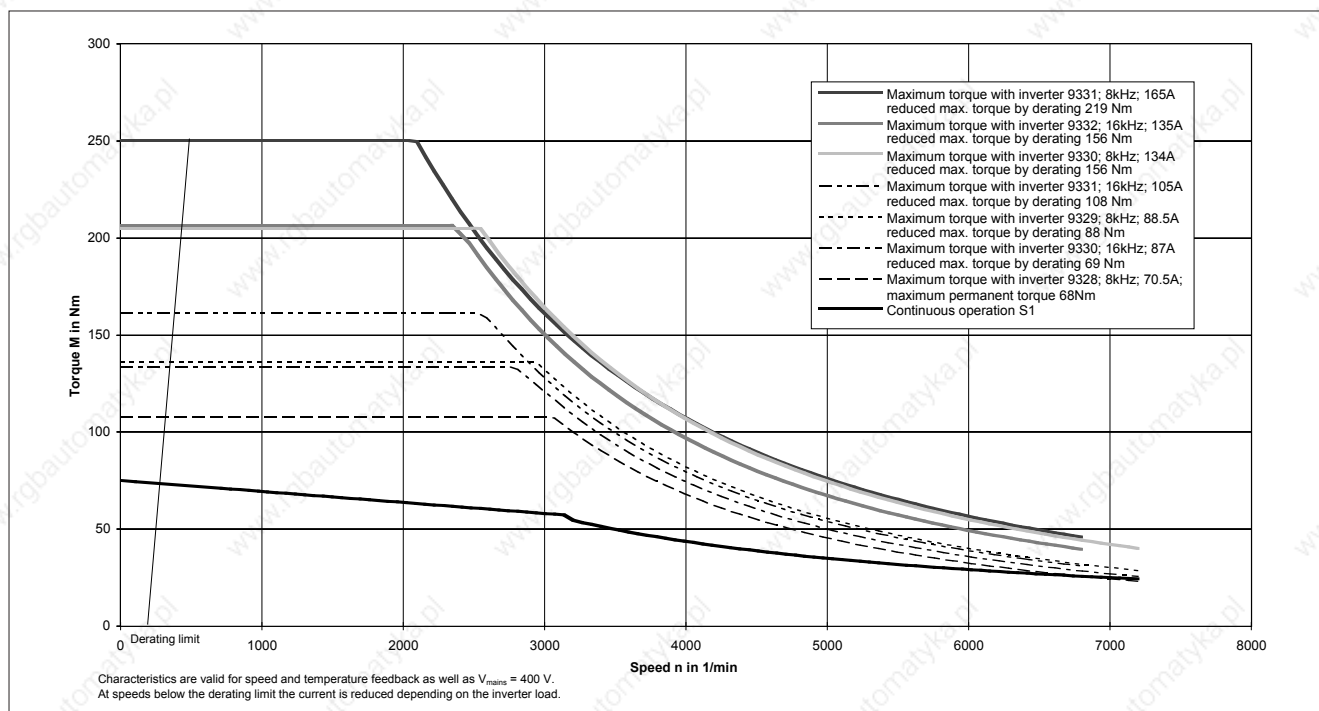

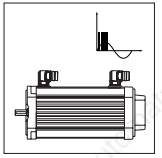

**Motor-inverter combination:**  
**Maximum and permanent torque asynchronous servo motor MDFQA 100-22, 50 Hz with separate fan in star connection**  
**Inverters 9326-9330**

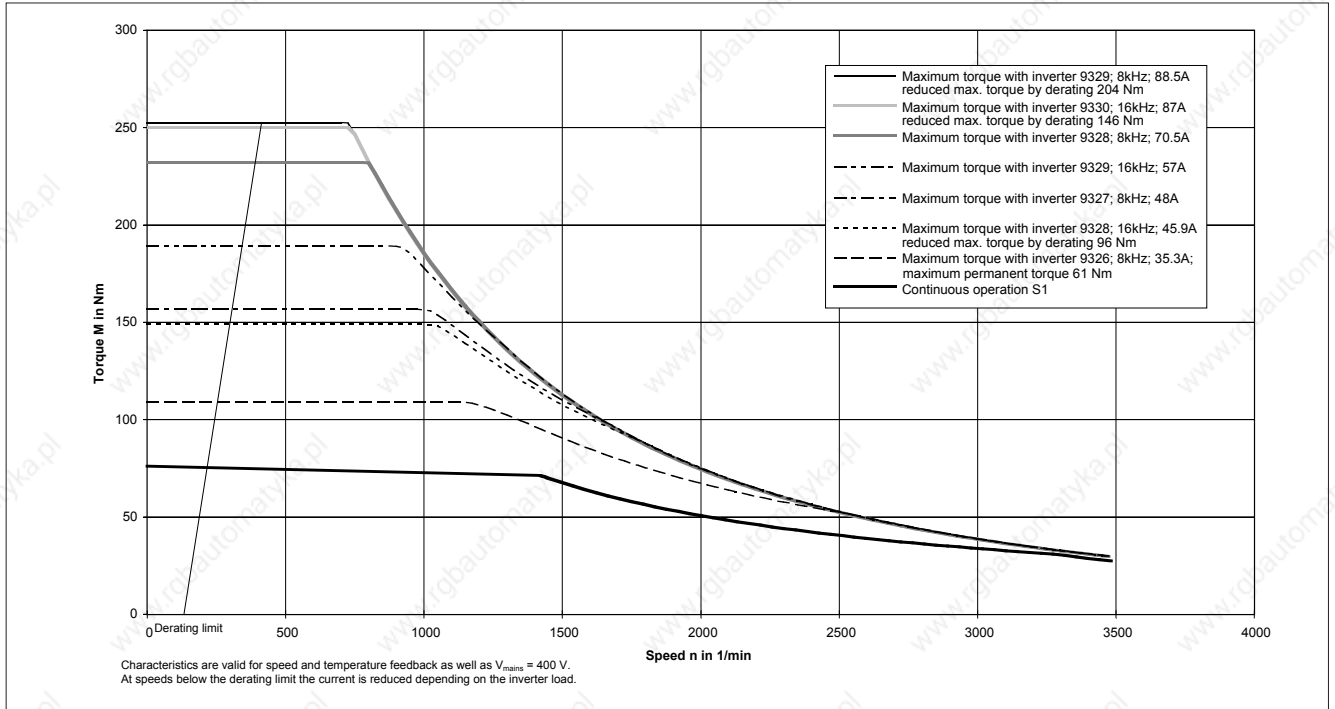

**Motor-inverter combination:**  
**Maximum and permanent torque asynchronous servo motor MDFQA 100-22, 100 Hz with separate fan in star connection**  
**Inverters 9328-9332**

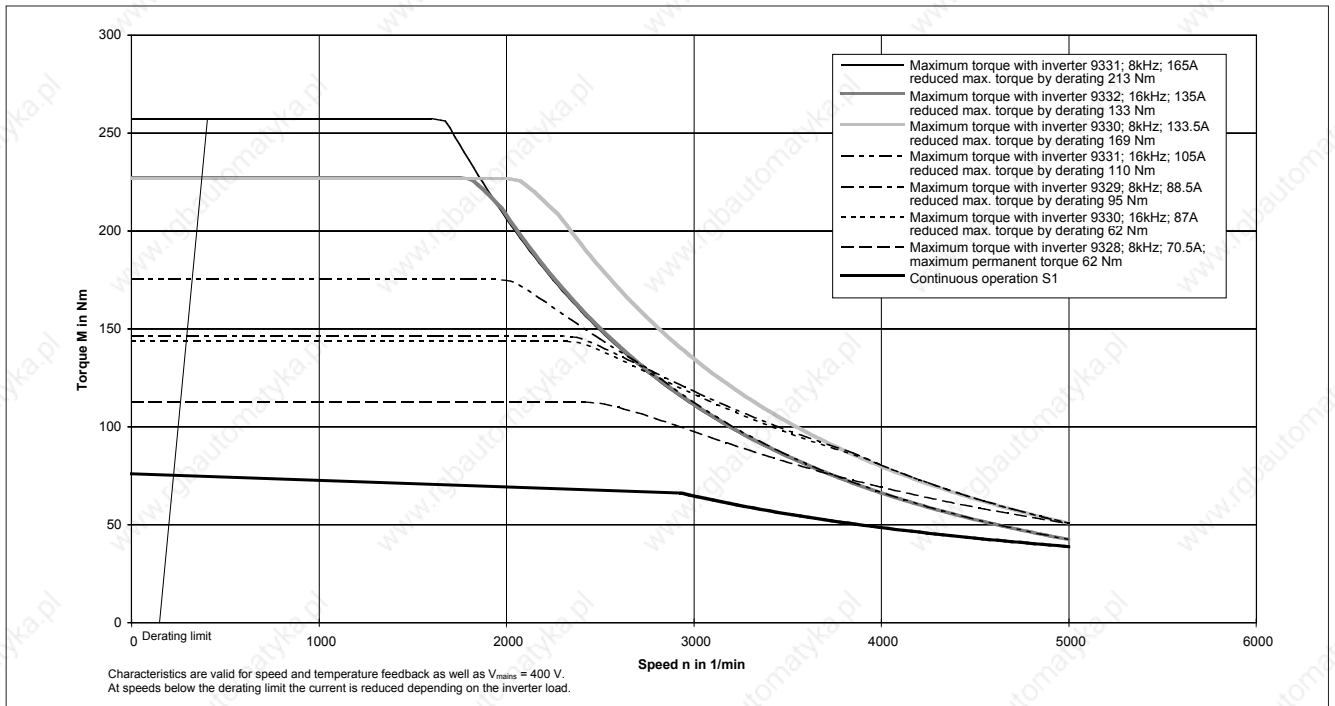

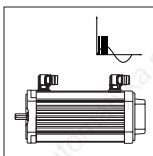

## Selection

### Torque-limit characteristics

Motor-inverter combination:

Maximum and permanent torque asynchronous servo motor MDFQA 112-22, 50 Hz with separate fan in star connection  
Inverters 9327-9330

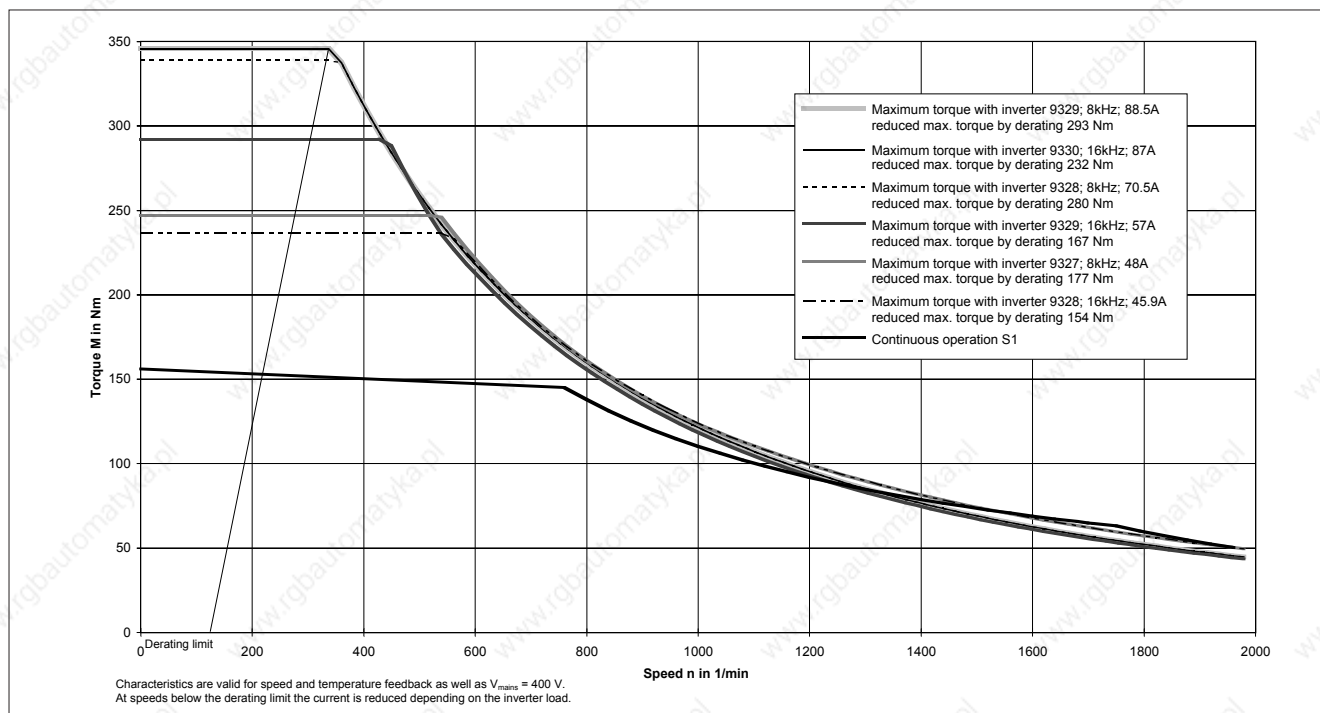

Motor-inverter combination:

Maximum and permanent torque asynchronous servo motor MDFQA 112-22, 50 Hz with separate fan in delta connection  
Inverters 9328-9331

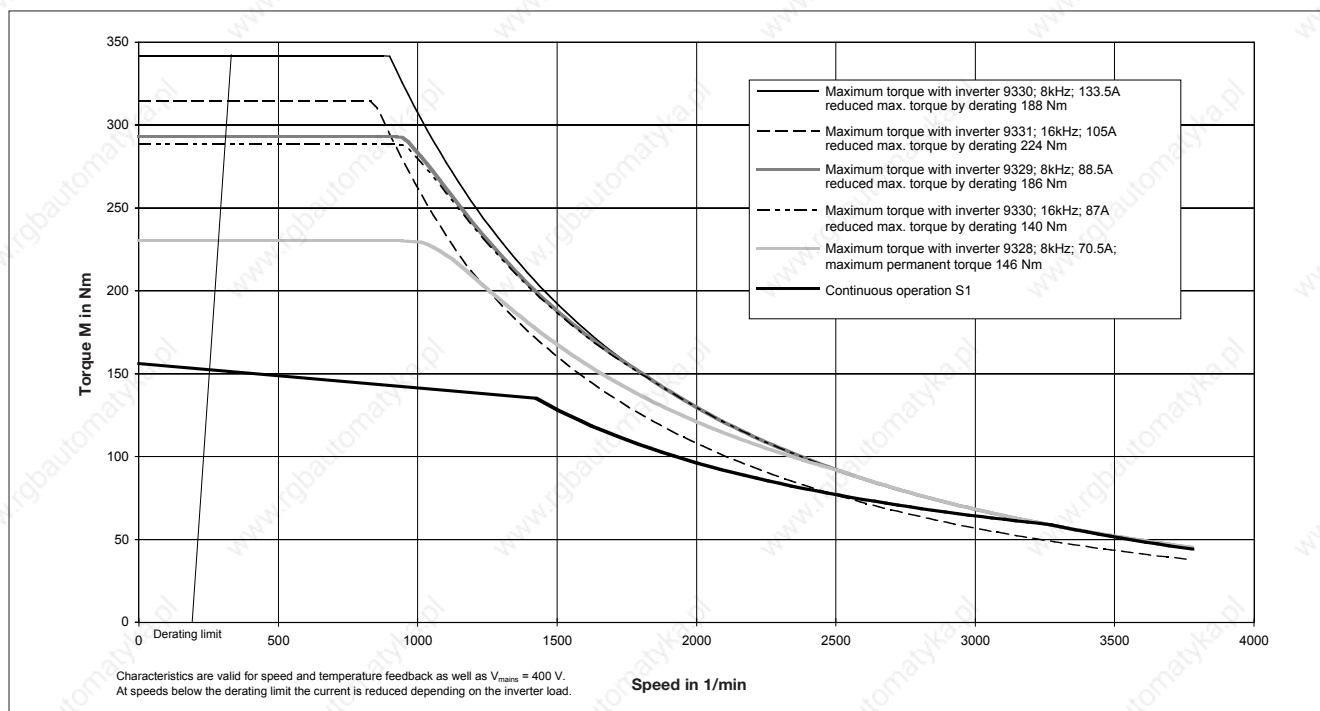



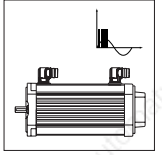

### Motor-inverter combination:

Maximum and permanent torque asynchronous servo motor MDFQA 112-22, 100 Hz with separate fan in star connection  
Inverters 9328-9332

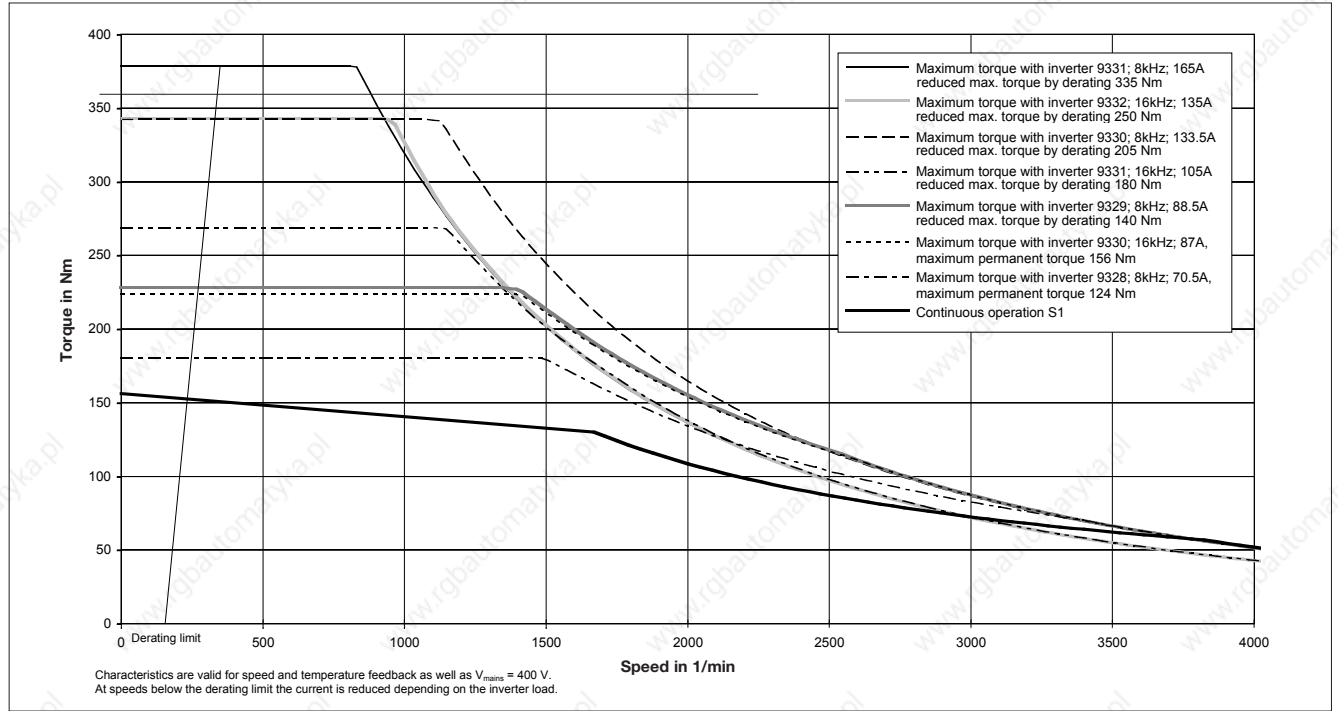

### Motor-inverter combination:

Maximum and permanent torque asynchronous servo motor MDFQA 112-22, 100 Hz with separate fan in delta connection  
Inverters 9330-9332

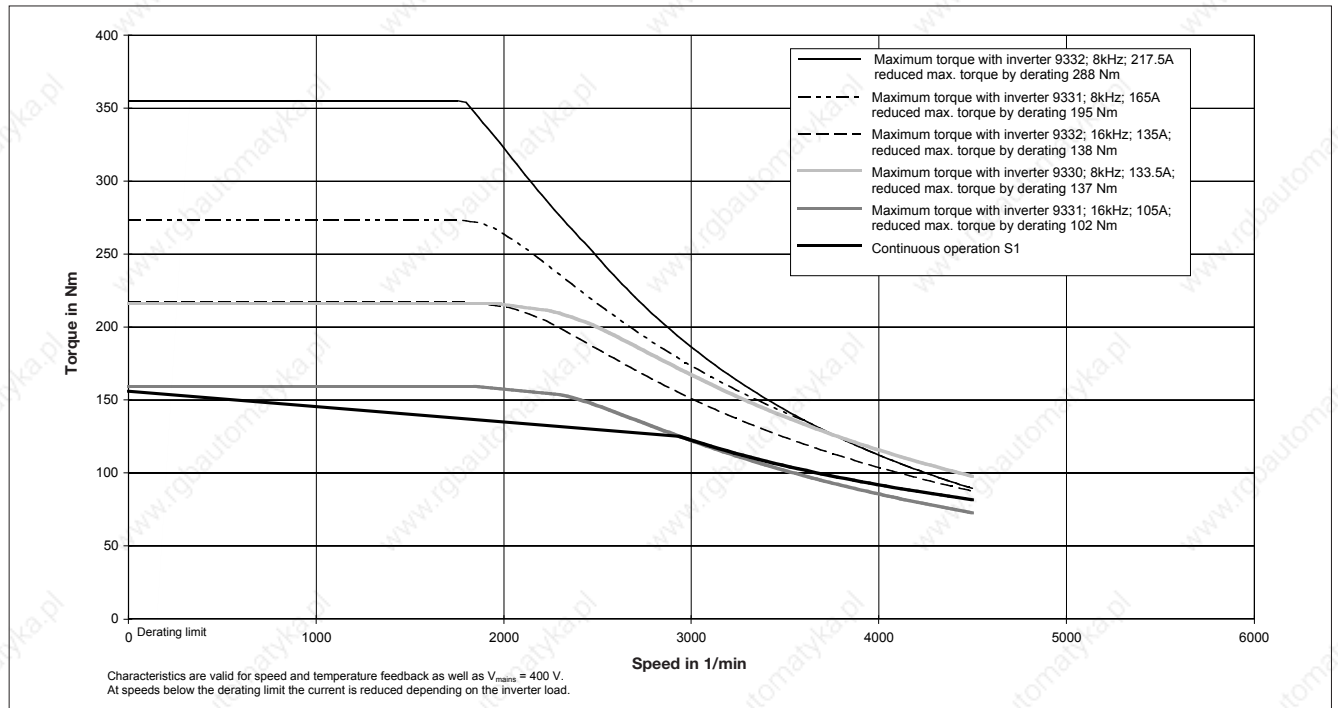

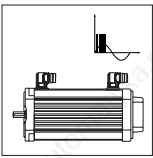

# Selection

## Torque-limit characteristics

**Motor-inverter combination:**

**Maximum and permanent torque asynchronous servo motor MDFQA 132-32, 36 Hz with separate fan in star connection**

**Inverters 9328-9332**

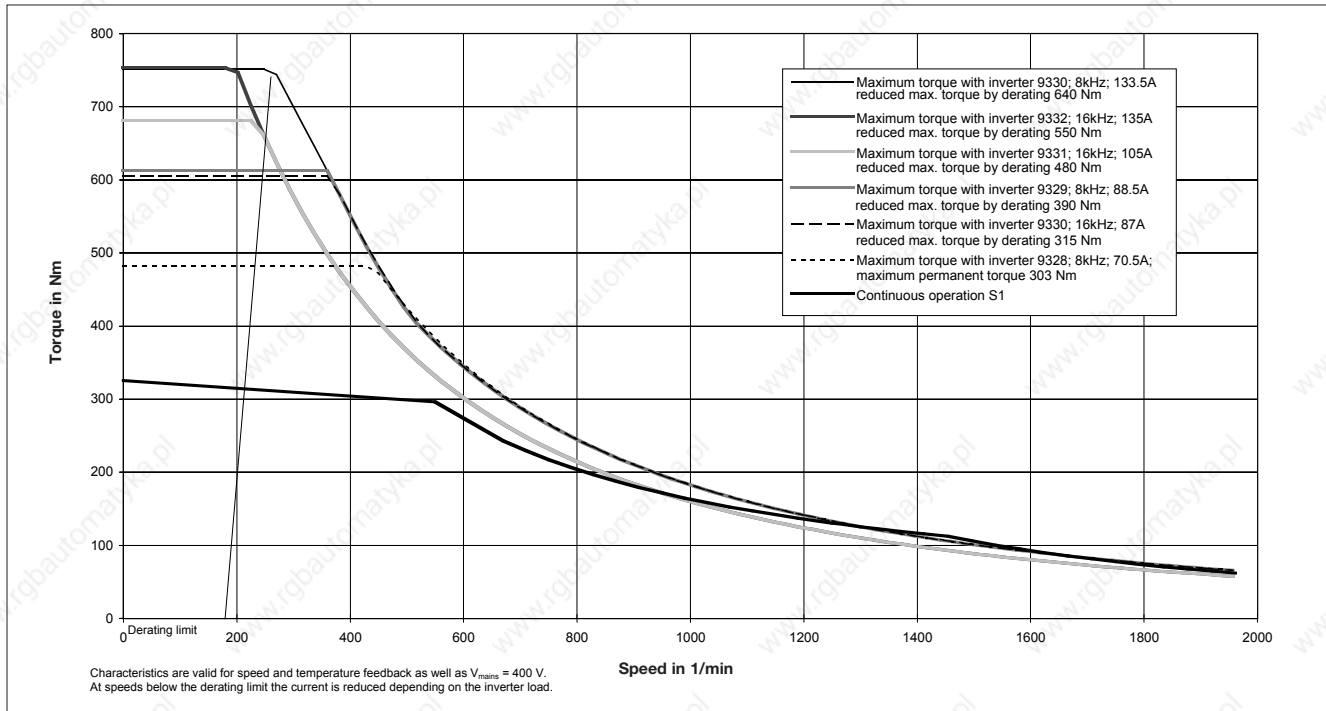

**Motor-inverter combination:**

**Maximum and permanent torque asynchronous servo motor MDFQA 132-32, 36 Hz with separate fan in delta connection**

**Inverters 9330-9332**

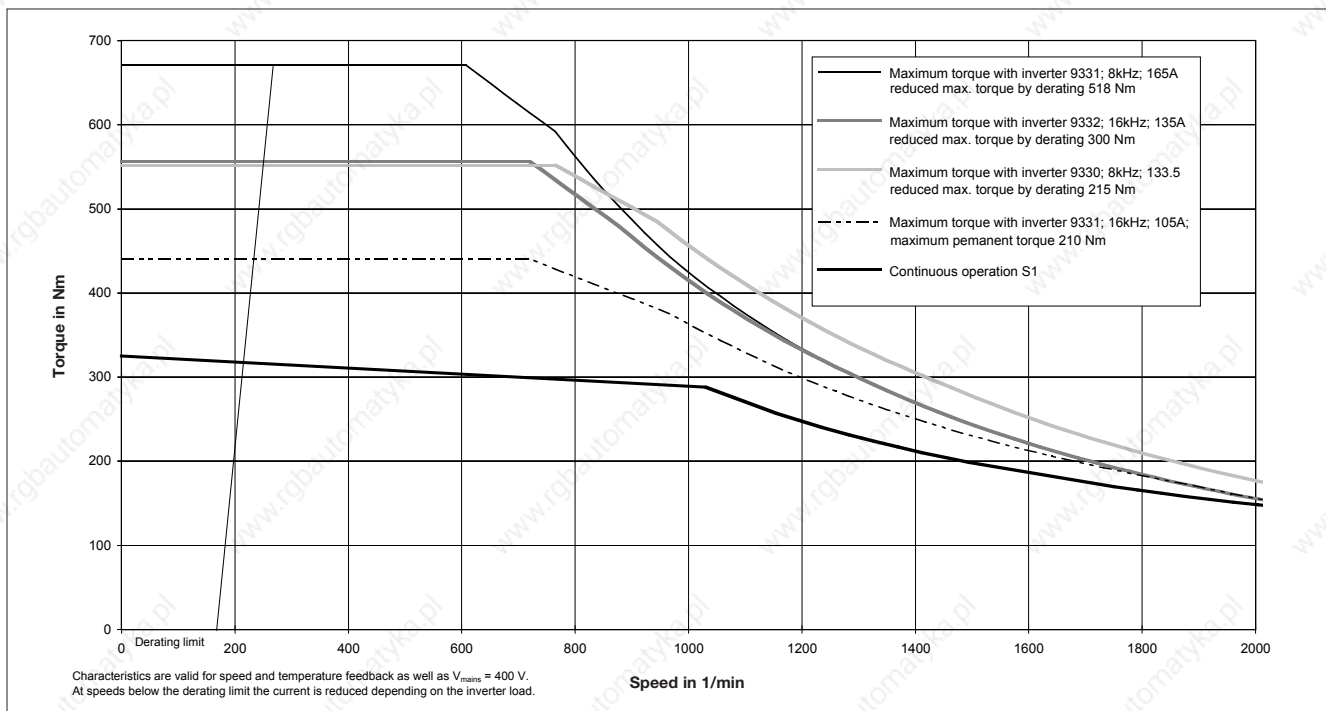

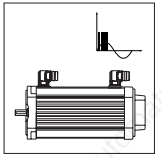

**Motor-inverter combination:**  
**Maximum and permanent torque asynchronous servo motor MDFQA 132-32, 76 Hz with separate fan in star connection**  
**Inverters 9330-9332**

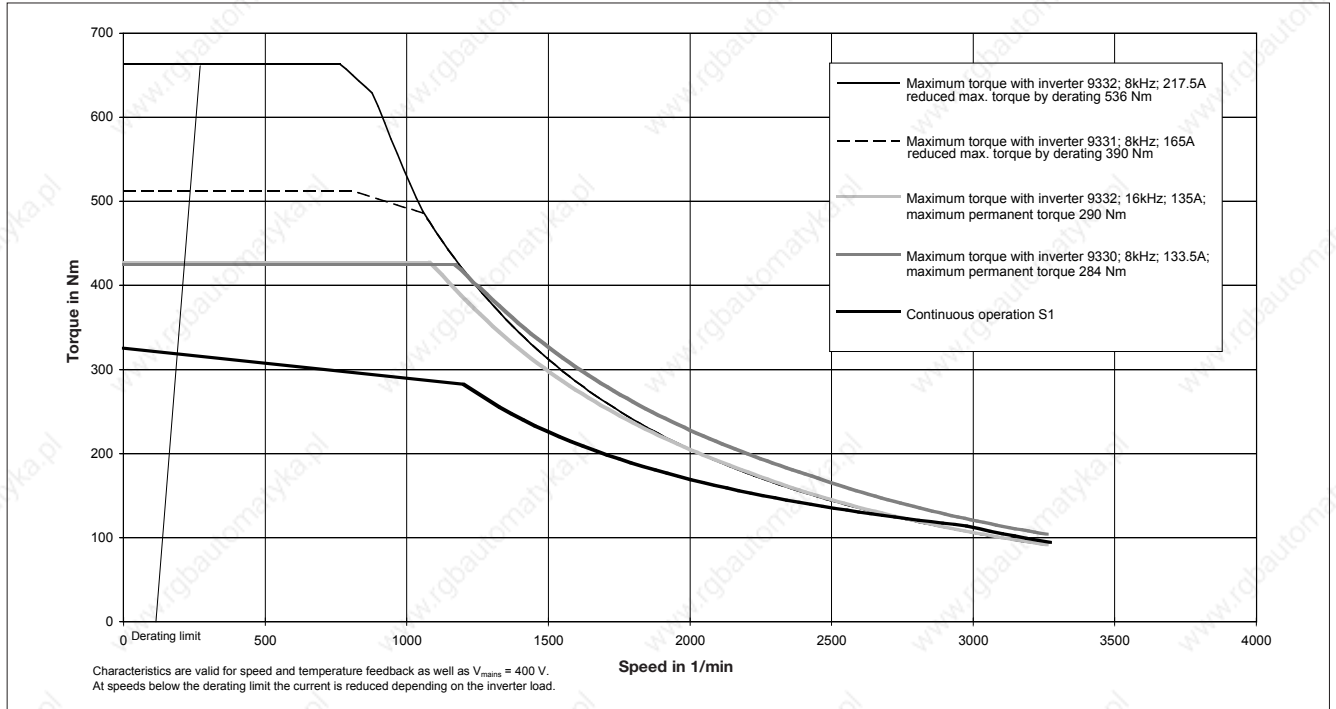

**Motor-inverter combination:**  
**Maximum and permanent torque asynchronous servo motor MDFQA 132-32, 76 Hz with separate fan in delta connection**  
**Inverters 9330-9332**

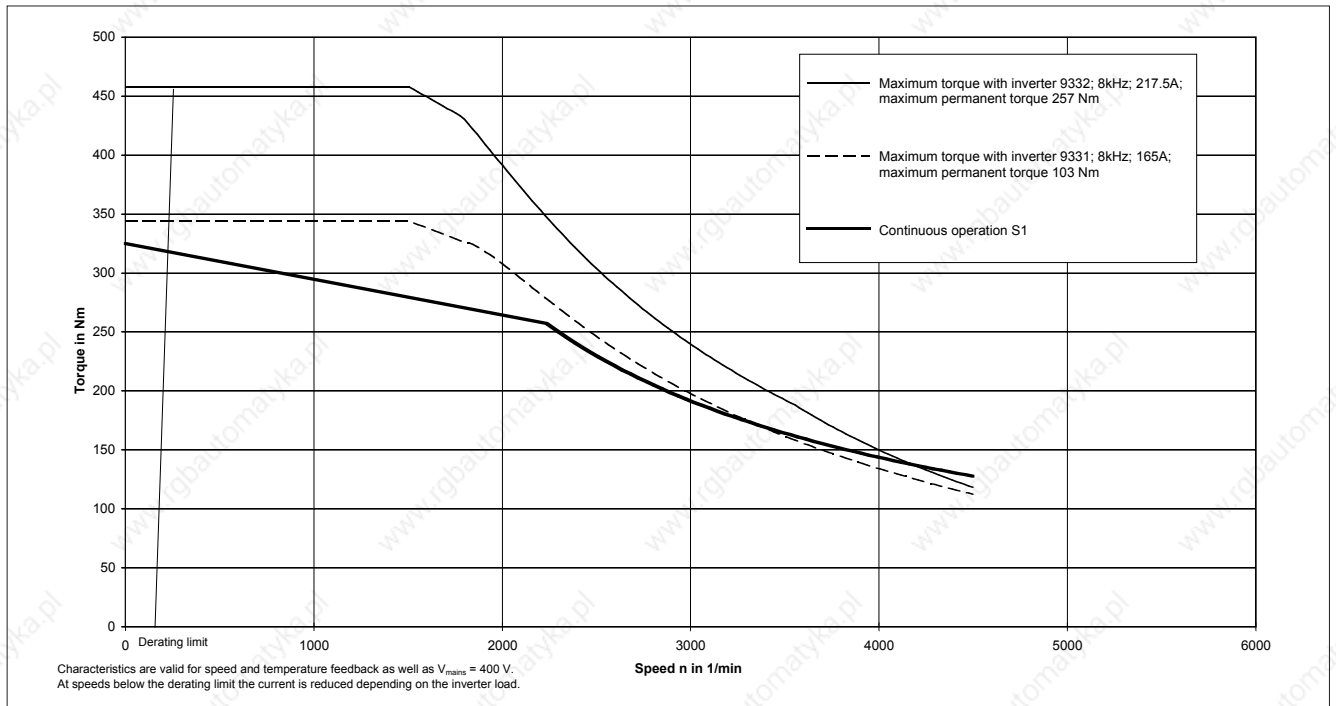

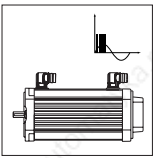

# Selection

## Torque-limit characteristics

### Influence of ambient temperature and installation height

Synchronous servo motors MDXKS, for motors with separate fan MDFKS maximum ambient temperature 40° C

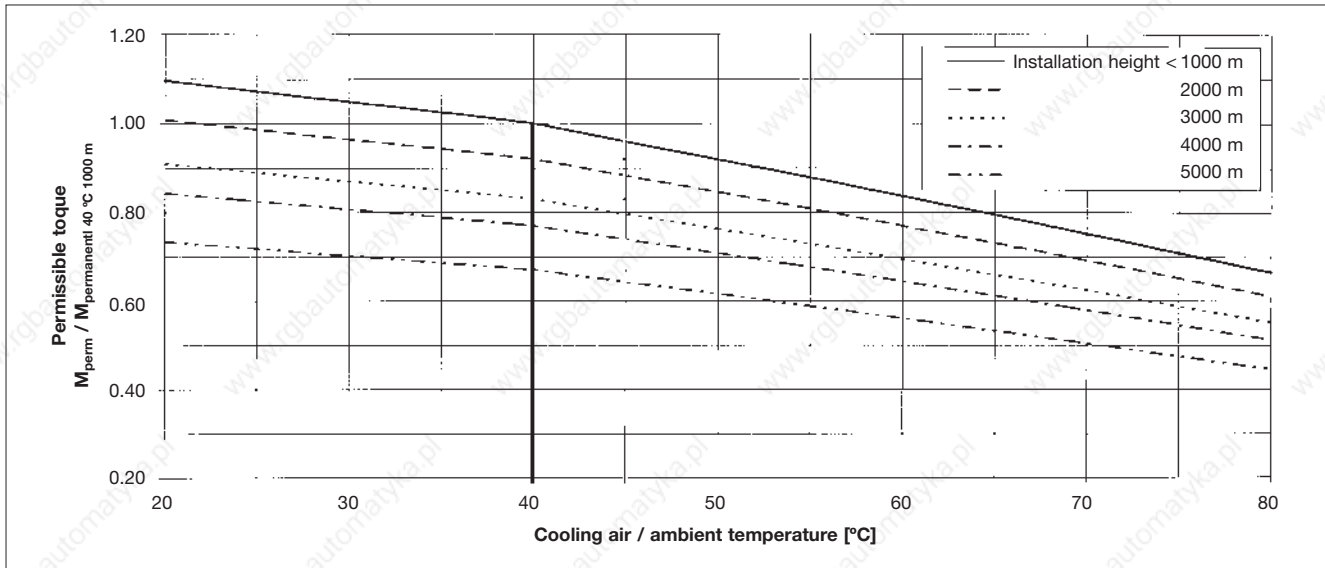

Asynchronous servo motors MDXKA and MDFQA, for motors with separate fan MDFKA and MDFQA maximum ambient temperature 40° C

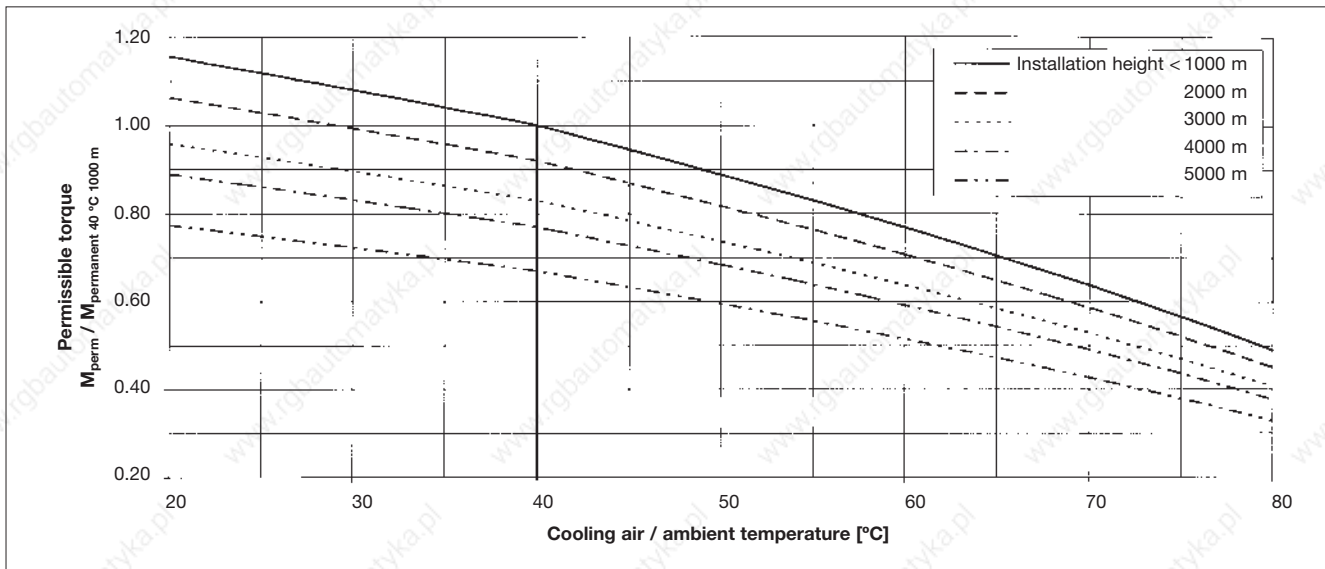



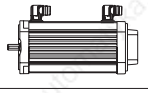

## Technical data

### Rated data

#### Permissible shaft load

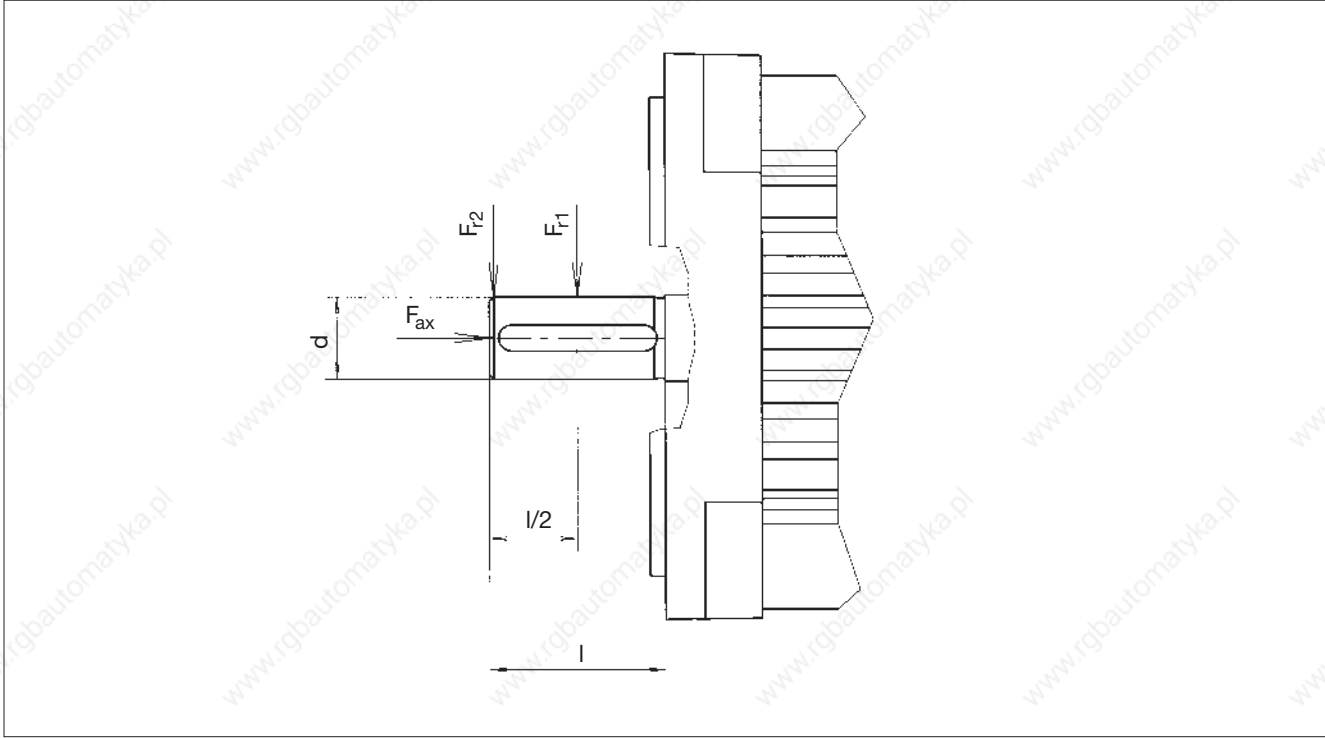

#### Series MDXKX (surface ventilated)

Motor type	d x l [mm]	$F_a$ [N]	$F_{r1}$ [N]	$F_{r2}$ [N]
MDXKS 036	11 x 23	70	250	180
MDXKX 056	14 x 30	100	330	250
MDXKX 071	19 x 40	150	600	400
MDXKX 080	24 x 50	200	700	600
MDXKX 090	24 x 50	260	1000	900
MDXKX 100	28 x 60	500	1500	1400
MDXKX 112	38 x 80	700	2000	1700

#### Series MDFQA (enclosed ventilated)

Motor type	d x l [mm]	$F_a$ [N]	$F_{r1}$ [N]	$F_{r2}$ [N]
MDFQA 100	38 x 80	900	2300	1000
MDFQA 112	38 x 80	1300	2300	1350
MDFQA 132	55 x 110	3500	4950	3580

Calculation basis:

Bearing life:  $L_{h10} = 20.000$  h, torque  $M = 2.5 M_{rated}$

Linear interpolation between  $F_{r1}$  and  $F_{r2}$  possible.

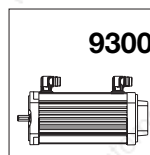

### Fans

Motor type	Fan type	$V_{rated}$ [V]	$f_{rated}$ [Hz]	$I_{rated}$ [A]	$P_{rated}$ [W]
<b>MDFK 071</b>		210...240, 1~	50/60	0.12	19
<b>MDFK 080</b>		210...240, 1~	50/60	0.12	19
<b>MDFK 090</b>		210...240, 1~	50/60	0.32	46
<b>MDFK 100</b>		210...240, 1~	50/60	0.32	46
<b>MDFK 112</b>		210...240, 1~	50/60	0.26	60
<b>MDFQA 100</b>	G2D 120	380...460, 3~	50/60	0.11	60
<b>MDFQA 100</b>	G2D 140 with filter	380...460, 3~	50/60	0.25	150
<b>MDFQA 100</b>	DNG 3-4,5 with or without filter with large voltage range	350...540, 3~	50/60	0.25	100
<b>MDFQA 112</b>	G2D 160 with filter	380...460, 3~	50/60	0.5	320
<b>MDFQA 112</b>	DNG 5-12,5 with or without filter with large voltage range	350...540, 3~	50/60	0.75	390
<b>MDFQA 132</b>	G2D 180	380...460, 3~	50/60	0.66	415
<b>MDFQA 132</b>	DNG 8-12 with or without filter with large voltage range	350...540, 3~	50/60	1.4	660

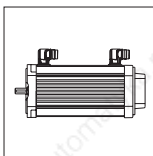

## Technical data

### Attachments

#### Brake

The servo motors MDXKX can be equipped with integrated permanent magnet holding brakes for 24 V DC (industrial type 205 V).

The enclosed ventilated asynchronous servo motors MDFQA can be equipped with a 205 V or 24 V spring operated brake.

The brakes are active after switching off the power supply (normally on principle).

When using the brakes for holding applications only, the friction linings are virtually resistant to wear. If the permissible friction work is not exceeded, at least 150 emergency stop operations are possible.

Motor type	$M_B$ [Nm]	$V_{rated\ 24}$ [V]	$I_{24}$ [A]	$V_{rated\ 205}$ [V]	$I_{205}$ [A]
<b>MDSKXBX 036</b>	2.5	24 (+5%, -10%)	0.50	–	–
<b>MDSKXBX 056</b> with direct gearbox connection	2.5 5	24 (+5%, -10%) 24 (+5%, -10%)	0.50 0.67	205 (+5%, -10%) 205 (+5%, -10%)	0.06 0.08
<b>MDXKXBX 071</b> with direct gearbox connection	10 12	24 (+5%, -10%) 24 (+5%, -10%)	0.67 0.75	205 (+5%, -10%) 205 (+5%, -10%)	0.08 0.09
<b>MDXKABX 080</b> with direct gearbox connection	12 20	24 (+5%, -10%) 24 (+5%, -10%)	0.75 1.00	205 (+5%, -10%) 205 (+5%, -10%)	0.09 0.12
<b>MDXKABX 090</b> with direct gearbox connection	20 20	24 (+5%, -10%) 24 (+5%, -10%)	0.75 1.00	205 (+5%, -10%) 205 (+5%, -10%)	0.09 0.12
<b>MDXKABX 100</b> with direct gearbox connection	40 40	24 (+5%, -10%) 24 (+5%, -10%)	1.00 1.46	205 (+5%, -10%) 205 (+5%, -10%)	0.12 0.18
<b>MDXKABX 112</b> with direct gearbox connection	80 80	24 (+5%, -10%) 24 (+5%, -10%)	1.46 1.46	205 (+5%, -10%) 205 (+5%, -10%)	0.18 0.18
<b>MDFQABX 100</b>	80 150	24 (+5%, -10%) 24 (+5%, -10%)	2.29 3.54	205 (+5%, -10%) 205 (+5%, -10%)	0.27 0.41
<b>MDFQABX 112</b>	150 240	24 (+5%, -10%) 24 (+5%, -10%)	3.54 4.17	205 (+5%, -10%) 205 (+5%, -10%)	0.41 0.49
<b>MDFQABX 132</b>	240 360	24 (+5%, -10%) 24 (+5%, -10%)	4.17 4.58	205 (+5%, -10%) 205 (+5%, -10%)	0.49 0.54

The employed brakes are no safety brakes in the real sense of the word, i.e. in case of disruption by not influencable factors, like penetration of oil or failure of the A-side shaft seal, a reduction of torque may occur.



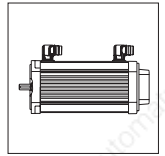

Motor type	t <sub>1</sub> , t <sub>is</sub> <sup>1)</sup> [ms]	t <sub>2</sub> , t <sub>auf</sub> [ms]	QE <sup>2)</sup> [kJ]	Shü <sup>3)</sup> [1/h]	J <sub>B</sub> [kgcm <sup>2</sup> ]	m [kg]
<b>MDSKXBX 036</b>	8	18	3.2	31	0.38	0.85
<b>MDSKXBX 056</b> with direct gearbox connection	8 13	18 22	3.2 6.5	31 23	0.38 1.06	0.85 0.75
<b>MDXKXBX 071</b> with direct gearbox connection	20 24	29 30	6.5 12.0	23 17	1.06 3.60	0.83 1.38
<b>MDXKABX 080</b> with direct gearbox connection	24 28	30 55	12.0 25.0	17 12	3.60 3.60	1.45 1.45
<b>MDXKABX 090</b> with direct gearbox connection	25 28	50 55	12.0 25.0	17 12	3.60 9.50	1.54 2.42
<b>MDXKABX 100</b> with direct gearbox connection	28 40	73 100	25.0 50.0	12 9	9.50 31.80	2.72 4.79
<b>MDXKABX 112</b> with direct gearbox connection	53 53	97 97	50.0 50.0	9 9	31.80 31.80	4.98 4.98
<b>MDFQABX 100</b>	90 110	180 300	37 60	27 20	15.00 29.00	13.5 20
<b>MDFQABX 112</b>	110 200	300 400	60 80	20 19	29.00 73.00	21.5 31
<b>MDFQABX 132</b>	200 270	400 500	80 120	19 17	73.00 200.00	32.5 46

- 1) Engagement time for DC switching, for AC switching t<sub>is</sub> prolonged by approx. factor 4
- 2) Max. friction work per switching operation with n = 1500 min<sup>-1</sup>
- 3) Transference operating frequency to VDI 2241 to detect the permissible operating frequency or friction work

With long motor cables and especially with 24V brakes, the ohmic voltage drop along the cable must be observed and compensated by a higher voltage input – otherwise, the voltage applied to the brake will not be high enough (24V or 205V).

For Lenze system cables the following applies:

$$\Delta V_B = 0.08 \cdot l_{\text{cable}} [\text{m}] \cdot I_B [\text{A}]$$

If the voltage applied to the brake is not correct (too high, too low, wrong polarity), the brake is activated immediately and can be overheated and destroyed by the still rotating motor.

Shortest switching times of the brake can be reached by DC switching of the voltage. A spark suppresser avoids voltage peaks.

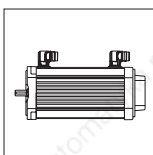

## Technical data

### Attachments

#### Angle and speed encoder for servo motors MDXK and MDXQ

Encoder	Resolver	Incremental encoder	Sin-Cosen encoder single turn	Sin-Cos encoder multi turn
Available for				
Synchronous servo motor MDXKS	●		●	●
Asynchronous servo motor MDXKA (surface cooled)	●	●	●	●
Asynchronous servo motor MDXQA (enclosed ventilated)	●	●	●	●
Designation	RS	IT2048	AS512	AM512
Type		ITD21	SCS70	SCM70
Signals		2048 bars TTL signals	512 periods, sine signals 1 V <sub>ss</sub> asynchronous half-duplex interface RS485 for transmission of the absolute position	
Resolution	0.8'	2.6'	0.4'	0.4'
Accuracy	+/- 10' bzw. +/- 4' when entering the correction code	+/- 2' depending on no. of bars	+/- 0.8'	+/- 0.8'
Absolute positioning	1 revolution	no	1 revolution	4096 rev.
Note	<b>Standard solution</b> for most applications	Incremental encoder instead of resolver	Sin-Cos encoder instead of resolver current position via interface of the 9300. Operation only possible after encoder selection at 9300 (encoder type and voltage supply), values saves, and unit switched off and on again.	

#### Resolver (built-in encoder)

Stator-fed resolver with 2 stator windings turned by 90° and a rotor winding with transformer winding.

Design	Brushless hollow shaft resolver in pancake-design	
Max. speed (permanent)	8000 min <sup>-1</sup>	
Max. speed (short time)	10000 min <sup>-1</sup>	
Input voltage	10 V amplitude	
Input frequency	4 kHz	
Ratio stator / rotor	0.3 ± 5 %	
Rotor impedance	Z <sub>ro</sub>	51Ω + j90 Ω
Stator impedance	Z <sub>s0</sub>	102 Ω + j150 Ω
Impedance	Z <sub>rs</sub>	44 Ω + j76 Ω
Insulation resistance	> 10 MΩ with 500 V DC	
No. of pole pairs	1	
Max. phase error	± 10 angular minutes	

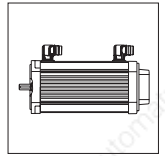

### Sin-Cos absolute value encoder (built-in encoder)

Absolute value encoder with 2 sine-wave signals displaced by 90° with 512 periods per revolution and serial interface RS 485 for the transmission of

parameters and the absolute position within one or 4096 revolutions.

Type	SCS 70
Design	Brushless hollow shaft encoder
Maximum torque	12000 min <sup>-1</sup>
No. of revolutions absolutely resolved	1 (single turn)
No. of periods	512 periods / rev.
Output signals	2 sine-wave signals displaced by 90° with 1 V <sub>SS</sub> , serial interface RS 485, asynchronous, half duplex
Limit frequency	100 kHz
Voltage supply	7 ... 12 V
Current consumption	100 ... 130 mA

Type	SCM 70
Design	Brushless hollow shaft encoder
Maximum torque	12000 min <sup>-1</sup>
No. of revolutions absolutely resolved	4096 (multi turn)
No. of periods	512 periods / rev.
Output signals	2 sine-wave signals displaced by 90° with 1 V <sub>SS</sub> , serial interface RS 485, asynchronous, half duplex
Limit frequency	100 kHz
Versorgung	7 ... 12 V
Current consumption	100 ... 130 mA

### Incremental encoder (built-in encoder)

Encoder with 2 TTL square-wave signals displaced by 90° with 2048 pulses per revolution and additional zero track.

This encoder is optionally available as preference feedback to the resolver for motor series MDFQA.

Type	ITD 21
Design	Brushless hollow shaft encoder
Maximum torque	8000 min <sup>-1</sup>
No. of pulses	2048 pulses / rev.
Output signals	2 square-wave signals displaced by 90°, zero pulse, complementary TTL signals, V <sub>low</sub> ≤ 0.5 V, V <sub>high</sub> ≥ 2.5 V
Voltage supply	5 V ± 5 %, protect against polarity reversal
Current consumption	≤ 150 mA
Limit frequency	300 kHz

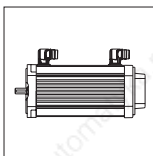

## Technical data

### Attachments

#### Temperature sensor KTY 83-110 (integrated)

The KTY temperature sensor continuously measures the motor temperature. It represents, though, no complete protection. The signals are fed back to the servo inverter

9300 via the system feedback cable. When feeding the encoder with a measuring current of 1 mA, temperature and resistance show the following characteristic:

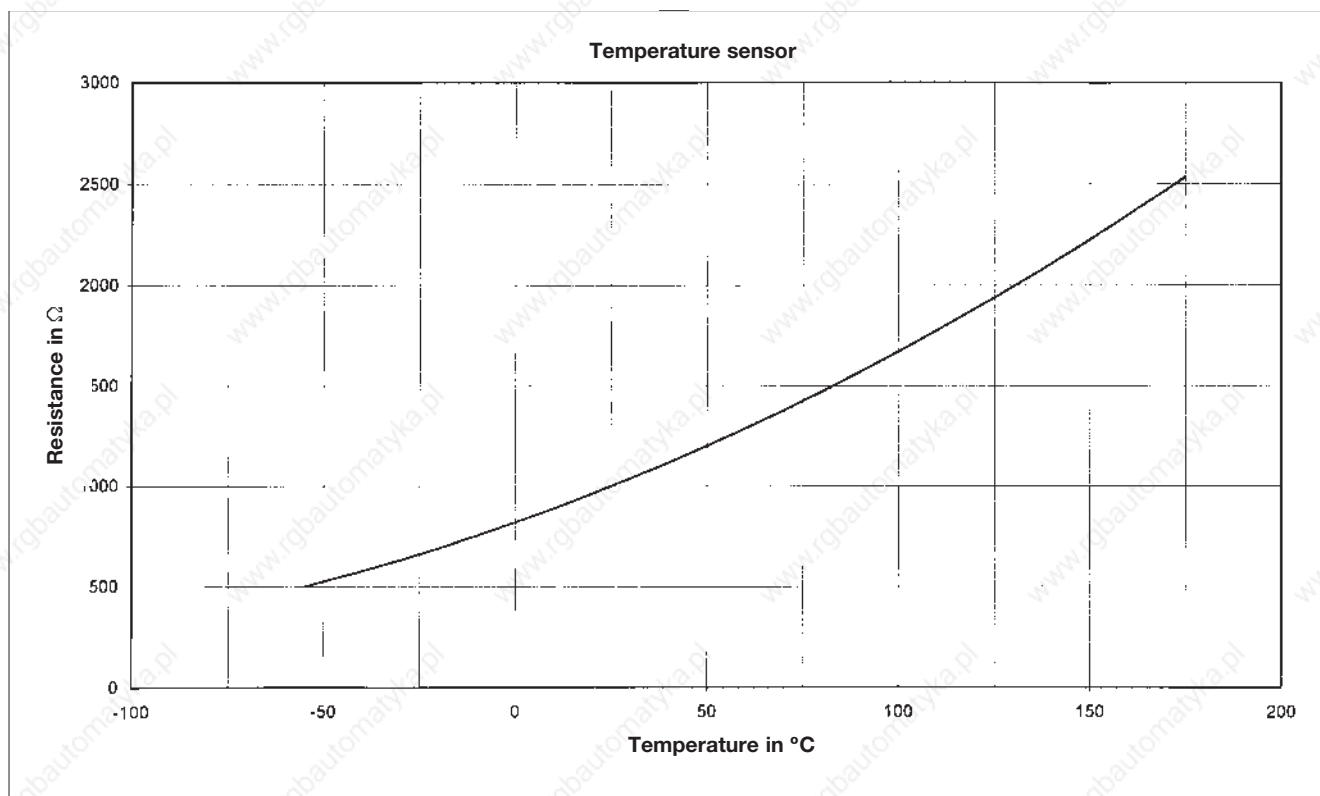

#### Temperature switch – normally closed contact

As alternative to the continuous sensor KTY, with the MDFQA it is also possible to use a temperature contact to monitor the windings.

Asynchronous motors of the series MDFQA are equipped with both temperature monitoring.

#### Technical data

	AC connection	DC connection		
Release temperature		150 °C ± 5 °C		
Reset temperature		90...135 °C		
Connection voltage	250 V ≈	60 V	48 V	24 V
Rated current [A]	2.5 A	1.0 A	1.25 A	1.6 A

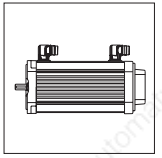

### Plug-in connectors for motor connection

#### Power connection, brake connection

	Pin no.	Terminal designation
Holding brake +UB	1	Y1
Holding brake -UB	2	Y2
Earth PE	⊕	⊕
Motor power phase U	4	1, U1
Motor power phase V	5	2, V1
Motor power phase W	6	3, W1
<b>Global Drive system cables</b>		
Standard cable	EWLMxxxGM-015C	
	MDXK036...090	
	EWLMxxxGM-025	
	MDXK036...090	
	EWLMxxxGM-040	
	MDXKA100...112	
Trailing cable	EWLMxxxGM-100	
	MDXKA100...112	
	EWLMxxxGMS025	
	MDXKA036...090	
	EWLMxxxGMS040	
Intermediate cable	MDXKA100...112	
	EWLMxxxZM-015	
	MDXKA036...090	

#### MDXK 036...090

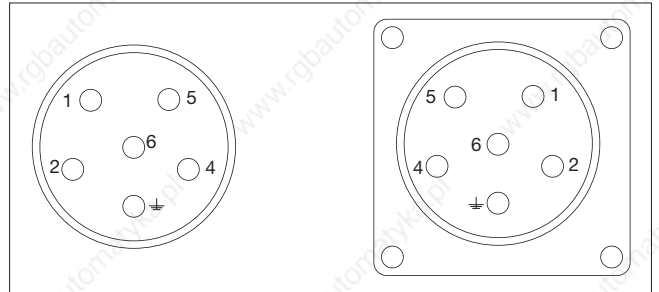

#### MDXKA 100...112

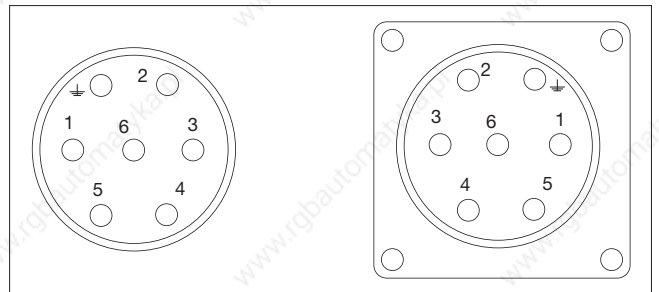

#### Fan connection

	Pin no.	Terminal designation
Earth PE	2	⊕
Fan power L1	A	U1
Fan power N	B	U2
<b>Global Drive system cables</b>		
Standard cable	EWLLxxxGM	
Trailing cable	EWLLxxxGMS	
Intermediate cable	EWLLxxxZM	

#### MDXK

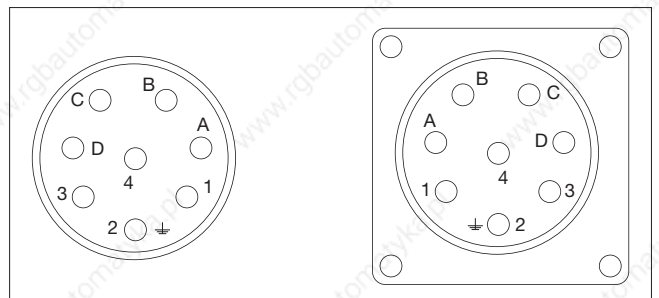

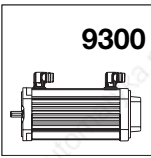

9300

# Technical data

## Motor connection

### Plug-in connectors for motor connection

#### Resolver connection

	Pin no.	Terminal designation
+Ref., transformer / reference winding	1	B1
-Ref., transformer / reference winding	2	B2
+Cos, stator winding	4	B4
-Cos, stator winding	5	B5
+Sin, stator winding	6	B6
-Sin, stator winding	7	B7
Temperature sensor +KTY	11	T1
Temperature sensor -KTY	12	T2
<b>Global Drive system cables</b>		
Standard cable	EWLRxxxGM-T	
Intermediate cable for trailing	EWLRxxxZMST	
Intermediate cable	EWLRxxxZM-T	

#### MDXK, MDFQA

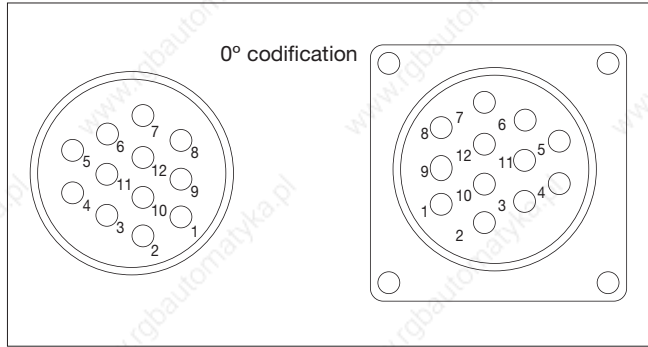

#### Connection of Sin-Cos absolute value and incremental encoder

#### MDXK, MDFQA

	Pin no.	Terminal designation
Track +B / +SIN	1	B5
Track -A / -COS	2	B4
Track +A / +COS	3	B3
Supply VCC	4	B1
Mass GND	5	B2
Track -0, -Z / -RS485	6	B8
Track +0, +Z / +RS485	7	B7
Track -B / -SIN	9	B6
Temperature sensor +KTY	11	T1
Temperature sensor -KTY	12	T2
<b>Global Drive system cables</b>		
Standard cable	EWLExxxGM-T	

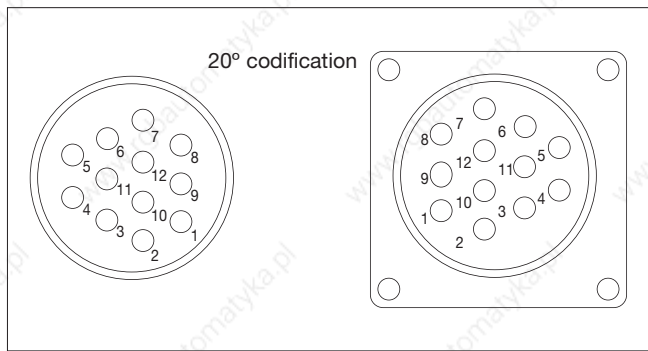

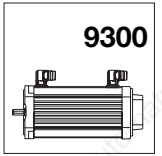

### Dimensions of plugs and sockets

Power plug size 036 ... 090

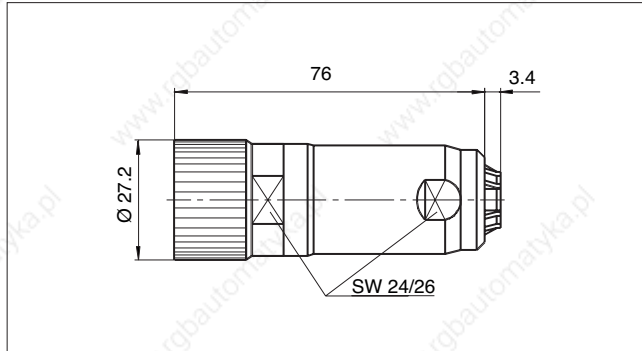

Right angle socket motor size 036 ... 090

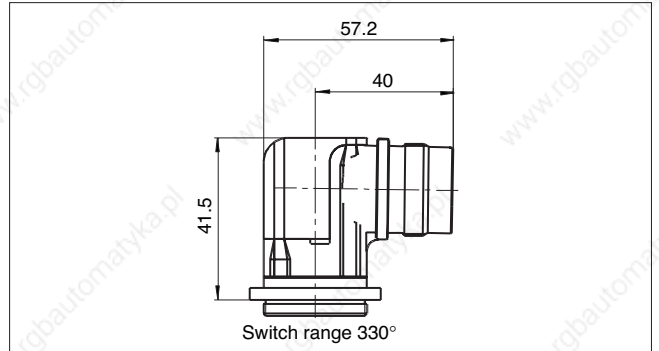

Power plug size 100 ... 112

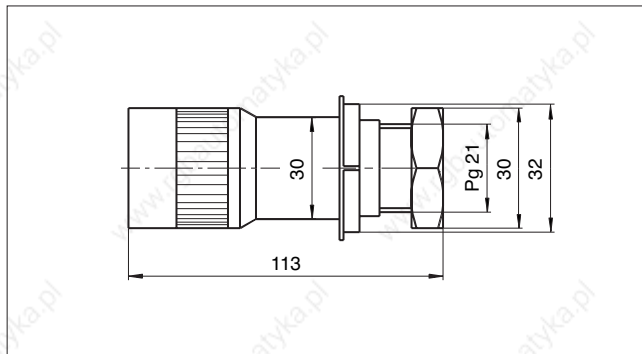

Right angle socket motor size 100 ... 112

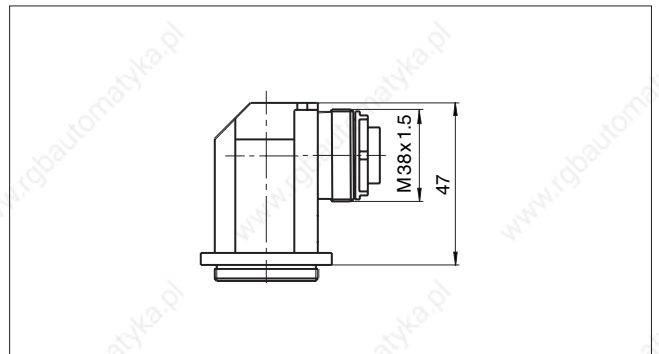

Fan plug

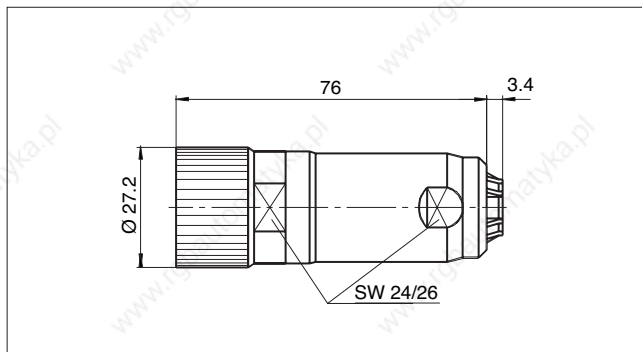

Right-angle socket fan

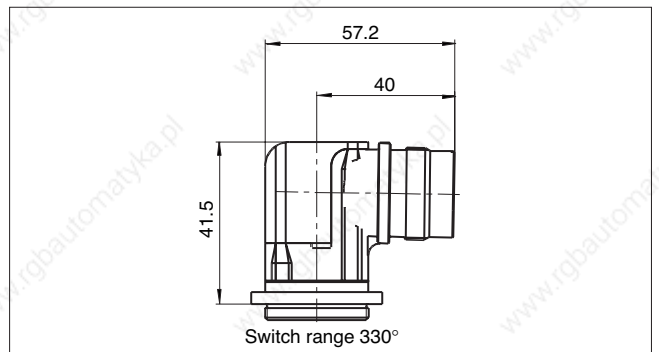

Encoder plug (resolver / Sin-Cos / incremental encoder)

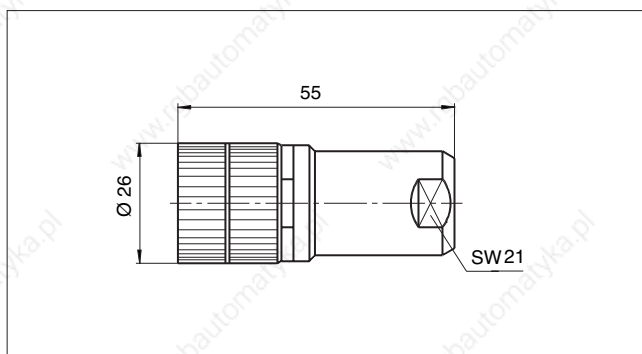

Right-angle socket encoder

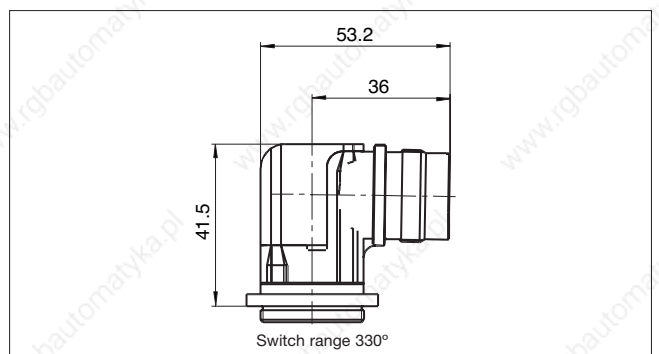

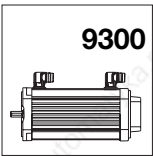

9300

# Technical data

## Motor connection

### Terminal box

As alternative to plug-in connectors, servo motors MDXK can be equipped with terminal boxes for power connection and brake.

The power connection of servo motors MDFQA (enclosed ventilated) is always equipped with a terminal box.

### a) Motor MDXK

#### Connections

	Pin no.	Terminal designation
Brake	5	Y1
Brake	6	Y2
Protective earth	PE	PE
Motor phase	1	U
Motor phase	2	V
Motor phase	3	W

#### Terminals

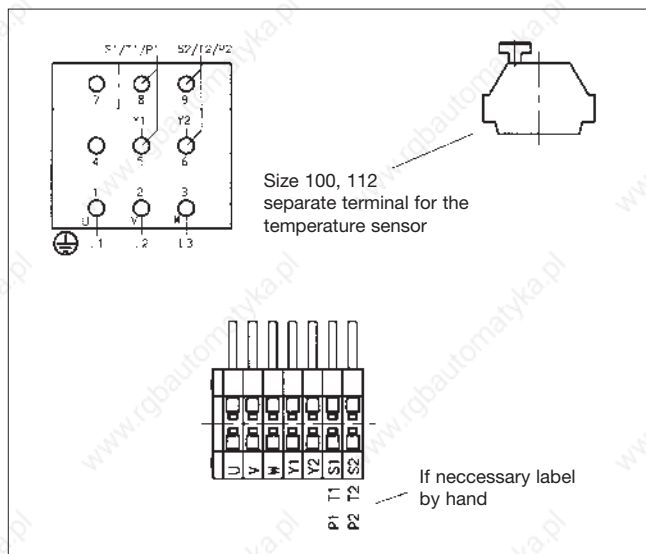

### b) Motor MDFQA

#### Connections

	Terminal designation
Protective earth	PE
Motor phase	U
Motor phase	V
Motor phase	W
Thermostat, connection T1 with 9300	S1
Thermostat, connection T2 with 9300	S2
Temperature sensor*, KTY, con. through encoder	T1
Temperature sensor*, KTY, con. through encoder	T2

#### Terminals

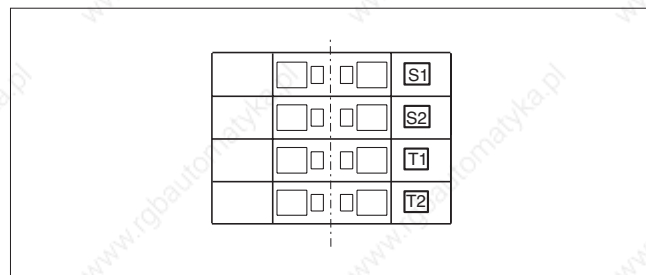

\* Motors with feedback have the temperature sensor connected to the encoder plug.

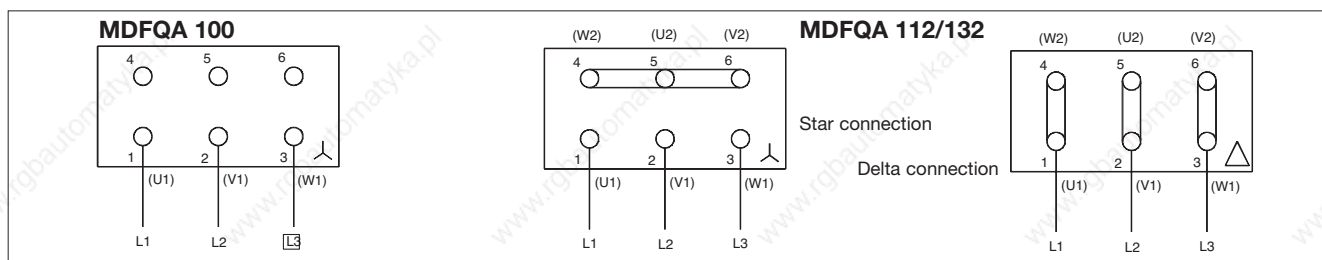



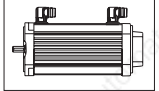

## Motor connection

Feedbacks and fans can be connected to a second terminal box.

The feedback of servo motors MDFQA (enclosed ventilated) is always equipped with plug-in connectors.

### Resolver as feedback

#### Connections

	Pin no.	Terminal designation
Temperature sensor	T1	+ KTY
Temperature sensor	T2	- KTY
Resolver	B1	+ Ref
Resolver	B2	- Ref
	B3	
Resolver	B4	+ cos
Resolver	B5	- cos
Resolver	B6	+ sin
Resolver	B7	- sin
	B8	
Separate fan	U1	L1
Separate fan	U2	N

#### Terminals

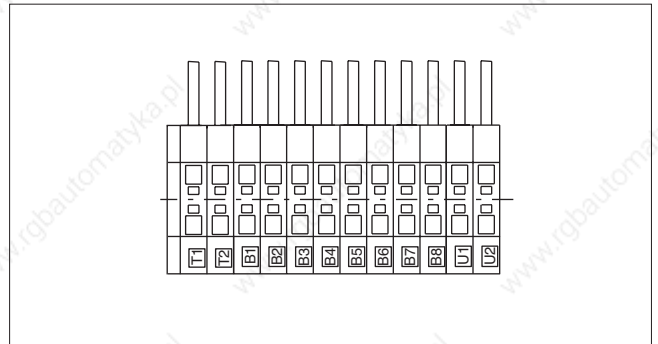

### Incremental encoder of SinCos-encoder as feedback

#### Connections

	Pin no.	Terminal designation
Temperature sensor	T1	+ KTY
Temperature sensor	T2	- KTY
Incremental encoder supply +	B1	+ UB
Incremental encoder supply -	B2	± ov
Incremental encoder track A	B3	A
Incremental encoder track A invers	B4	- A
Incremental encoder track B	B5	B
Incremental encoder track B invers	B6	- B
Inc. encoder track C (zero track)	B7	N
Inc. encoder track C (zero track invers)	B8	N
Incremental encoder mass/sensor	B9	± ov
Incremental encoder screen	B10	Screen
Incremental encoder screen +	B11	+ U sensor
Separate fan	U1	L1
Separate fan	U2	N

#### Terminals

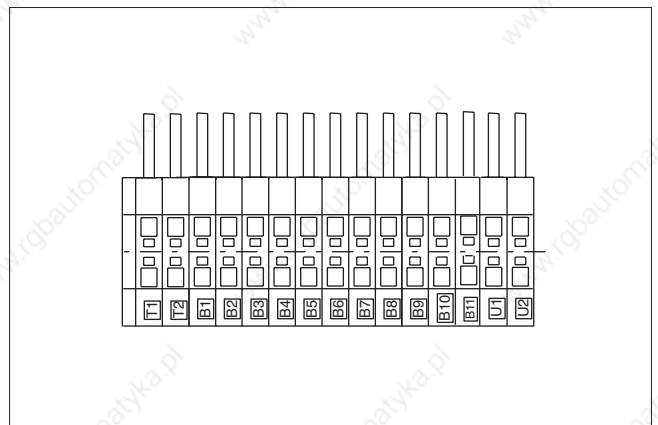

### PG glands and bolts

Motor type	Power connection		Encoder / fan connection
	PG glands	Bolts	PG glands
<b>MDSK 056</b>	1xPG13.5 + 1xPG11	M4 bzw. 0.08...2.5 mm <sup>2</sup>	1xPG13.5 + 1xPG11 + 3xPG7
<b>MDXK 071</b>	1xPG13.5 + 1xPG11	M4 bzw. 0.08...2.5 mm <sup>2</sup>	1xPG13.5 + 1xPG11 + 3xPG7
<b>MDXK 080</b>	1xPG13.5 + 1xPG11	M4 bzw. 0.08...2.5 mm <sup>2</sup>	1xPG13.5 + 1xPG11 + 3xPG7
<b>MDSK 090</b>	1xPG13.5 + 1xPG11	M4 bzw. 0.08...2.5 mm <sup>2</sup>	1xPG13.5 + 1xPG11 + 3xPG7
<b>MDXK 100</b>	2x PG16	M5	2xPG16 + 3x PG7
<b>MDXK 112</b>	1xPG21 + 1xPG16	M5	2xPG16 + 3x PG7
	Power connection		Fan connection
<b>MDFQ 100</b>	2xPG29 + 1xPG9 *	M6	1xPG9
<b>MDFQ 112</b>	2xPG36 + 2xPG9 *	M8	1xPG9
<b>MDFQ 132</b>	4xPG29 + 2xPG9 *	M12	1xPG9

\* For connection of parallel screened cables, e.g. 3 St 4 x 35 mm<sup>2</sup> or 4 St 4 x 25 mm<sup>2</sup>



# Dimensions

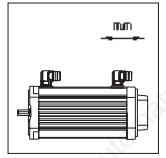

## Synchronous servo motors MDSKS 036, mounting position B5

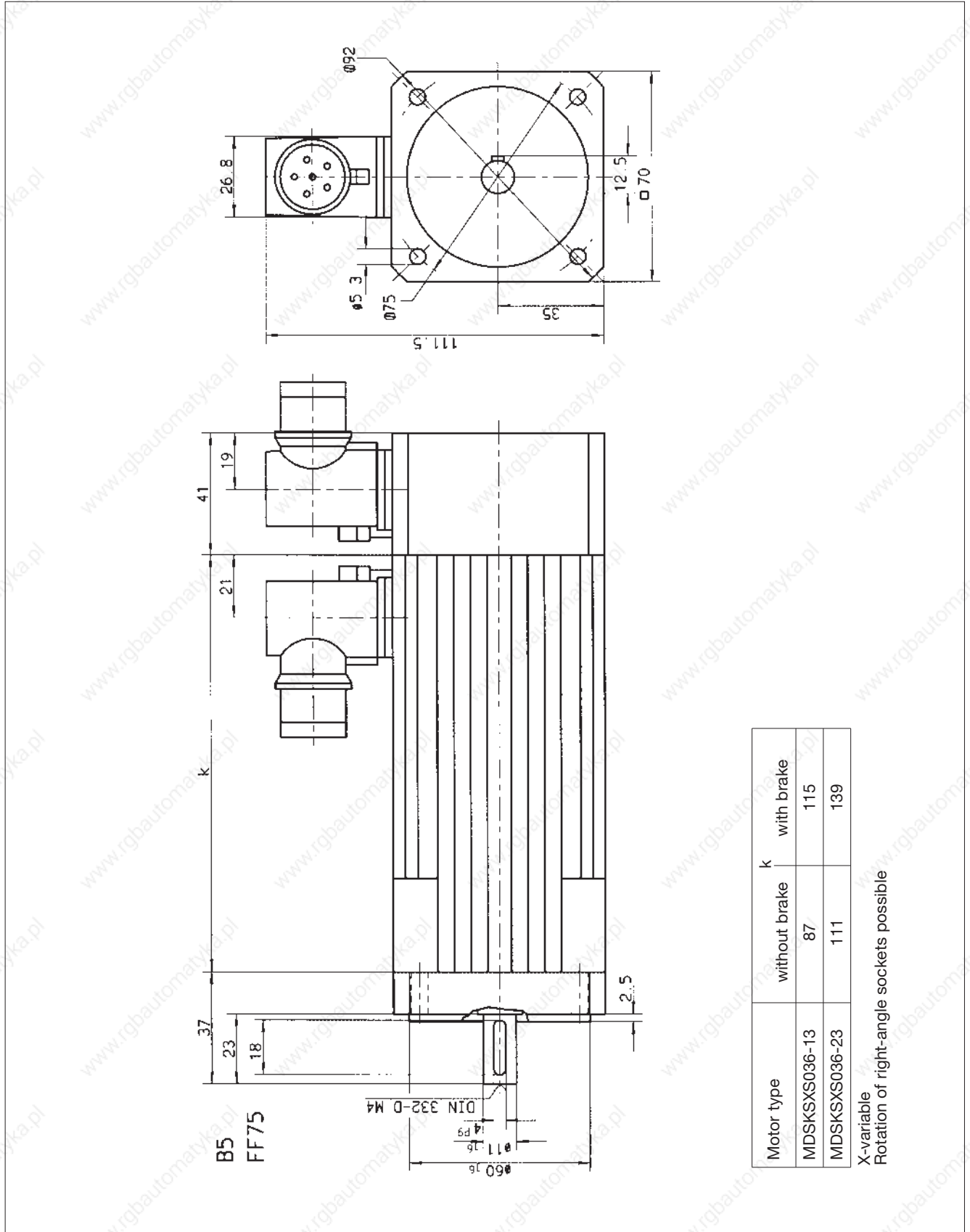

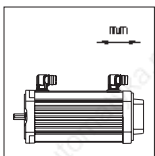

# Dimensions

## Synchronous servo motors MDSKS 056, mounting position B5/B14

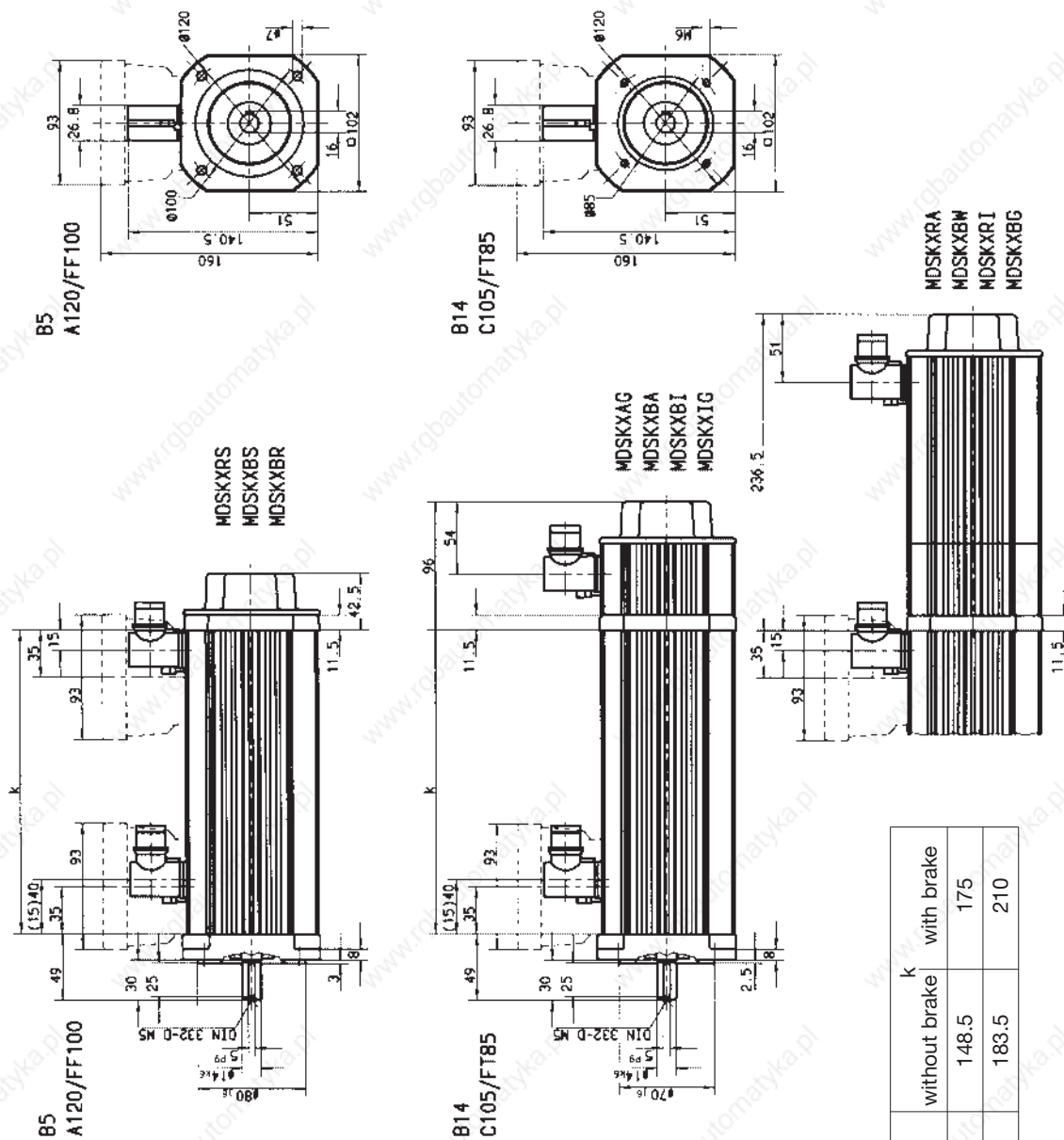

Motor type	k	
	without brake	with brake
MDSKSXS056-23, 190	148.5	175
MDSKSXS056-33, 200	183.5	210

( ) - without brake  
 X-variable  
 Rotation of right-angle sockets possible

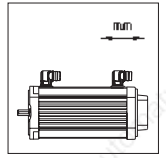

## Synchronous servo motors MDXKS 071, mounting position B5/B14

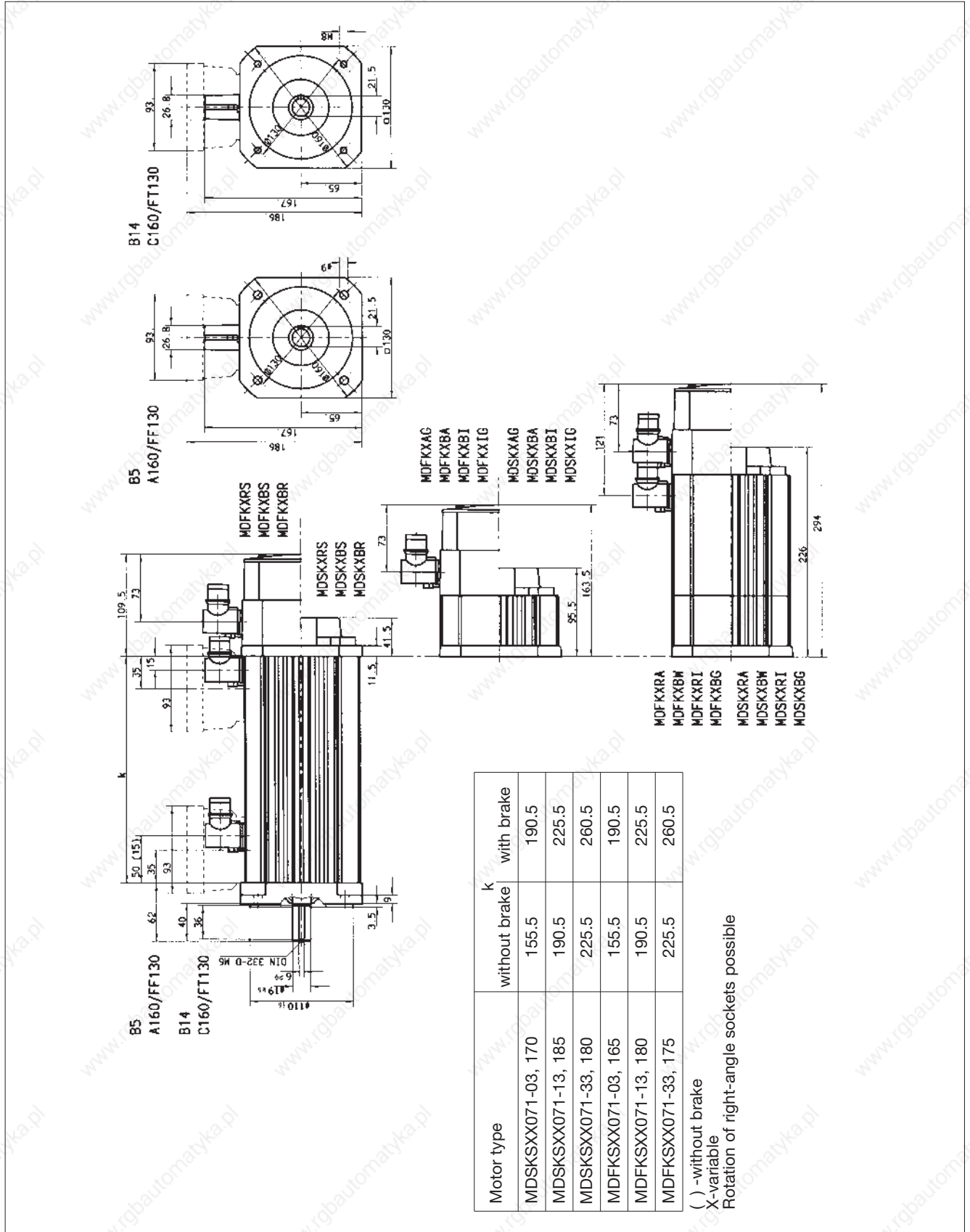

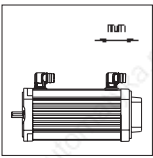

# Dimensions

## Asynchronous servo motors MDSKA 056, mounting position B5/B14

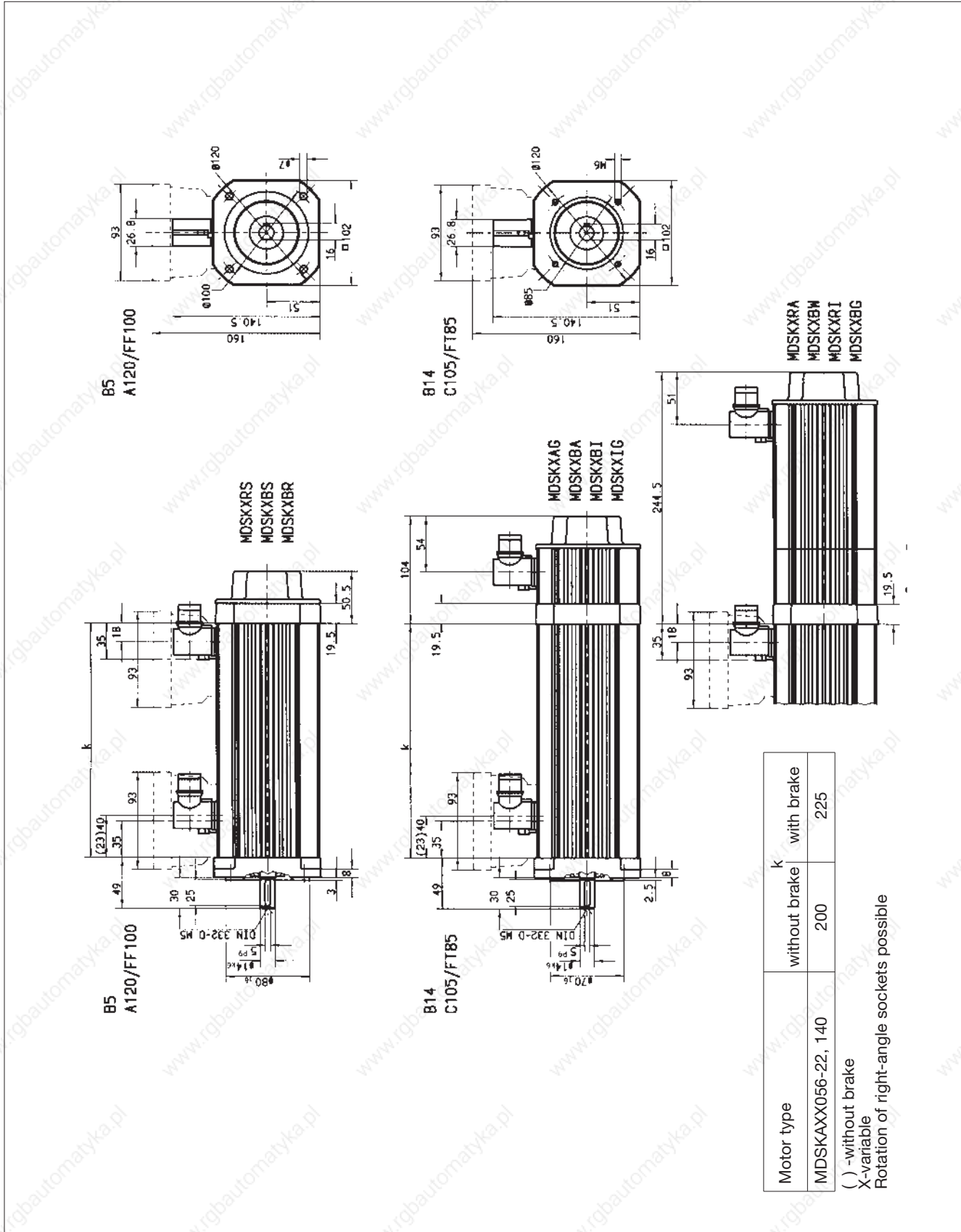

# Dimensions

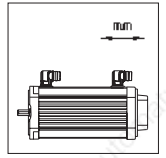

## Asynchronous servo motors MDXKS 071, mounting position B5/B14

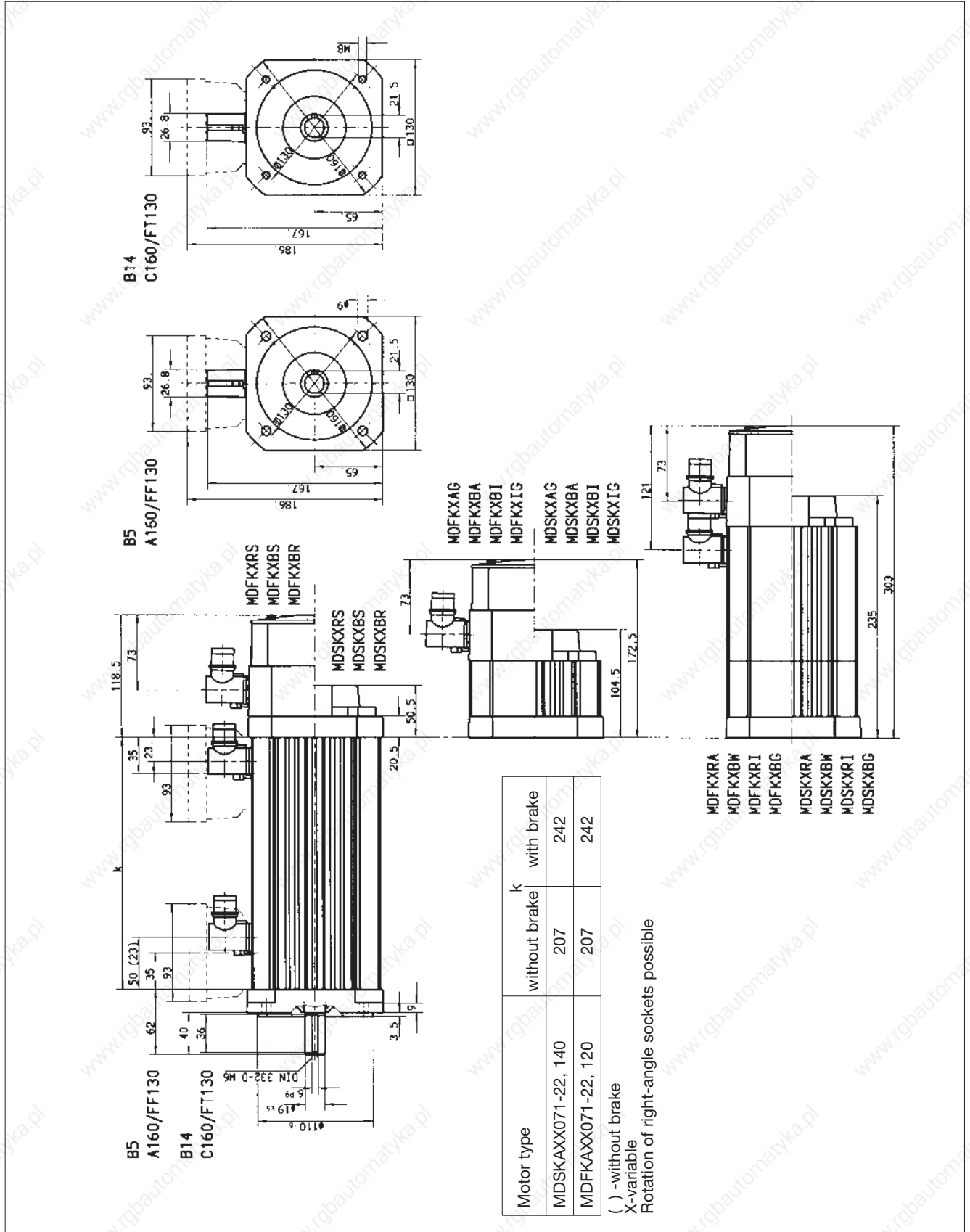

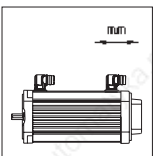

# Dimensions

## Asynchronous servo motors MDXKA 080, mounting position B5/B14

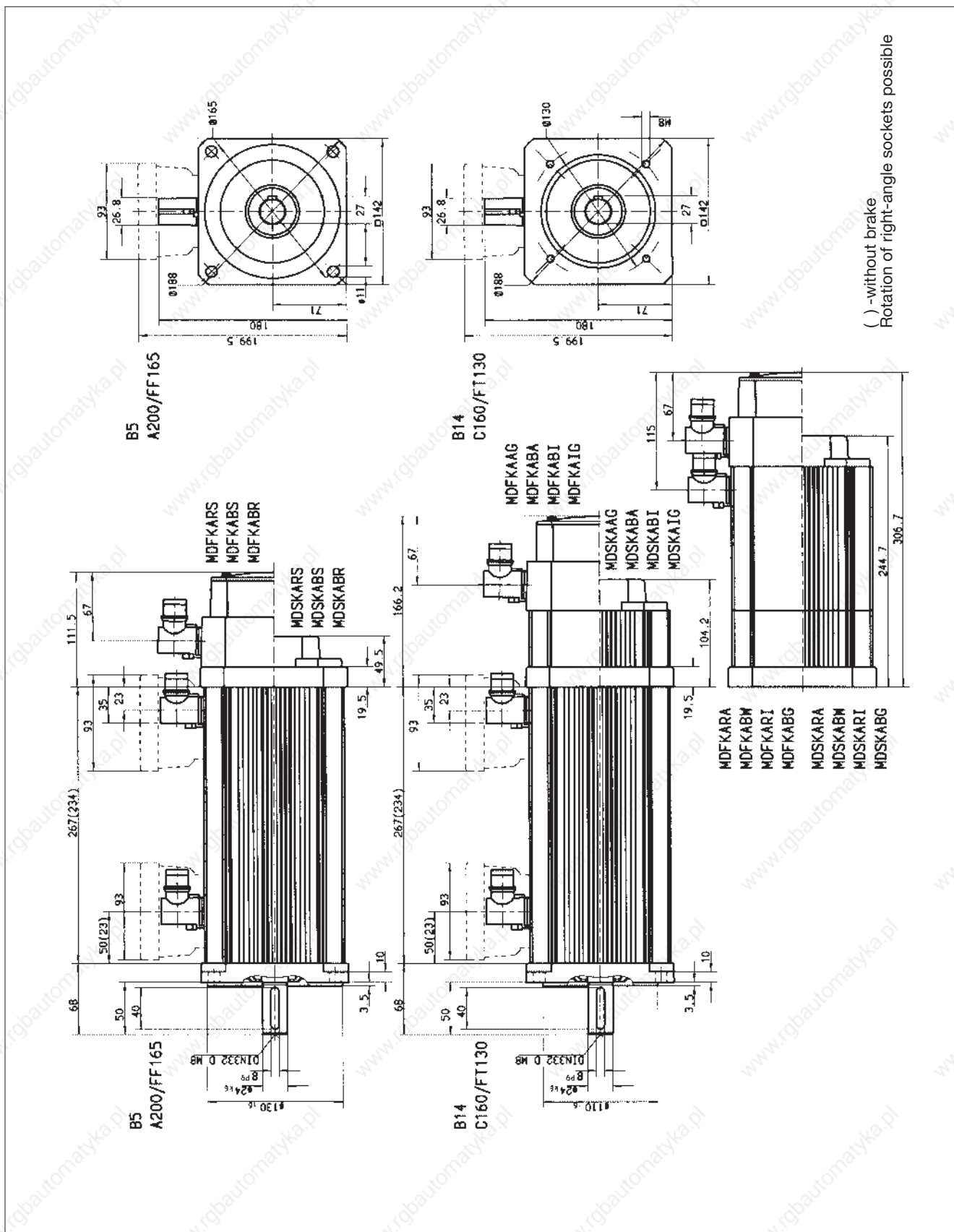



# Dimensions

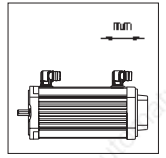

## Asynchronous servo motors MDXKA 090, mounting position B5/B14

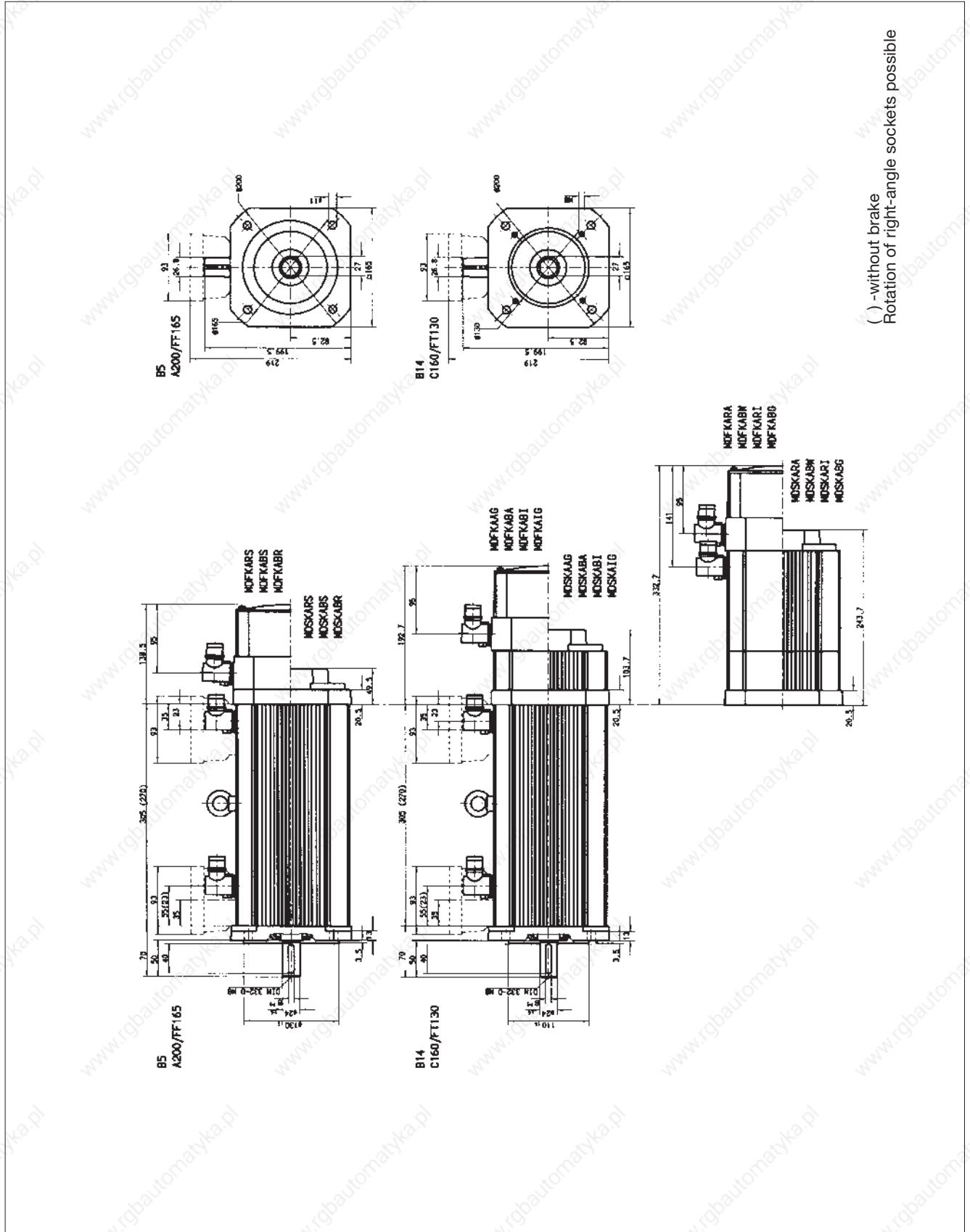

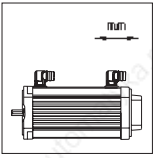

# Dimensions

## Asynchronous servo motors MDXKA 100, mounting position B5/B14

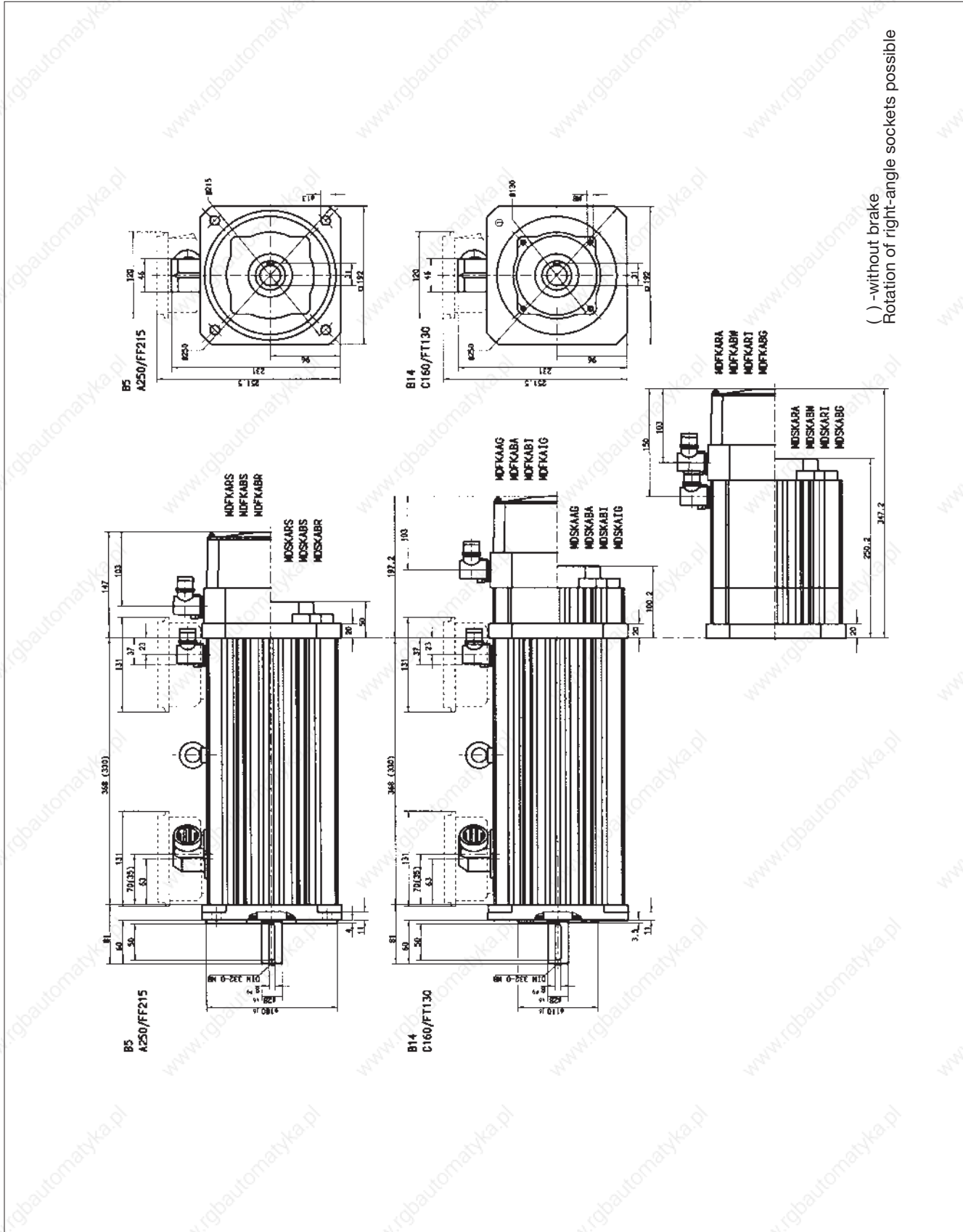

( ) - without brake  
Rotation of right-angle sockets possible

# Dimensions

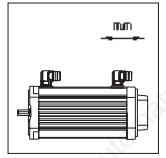

## Asynchronous servo motors MDXKA 112, mounting position B5/B14

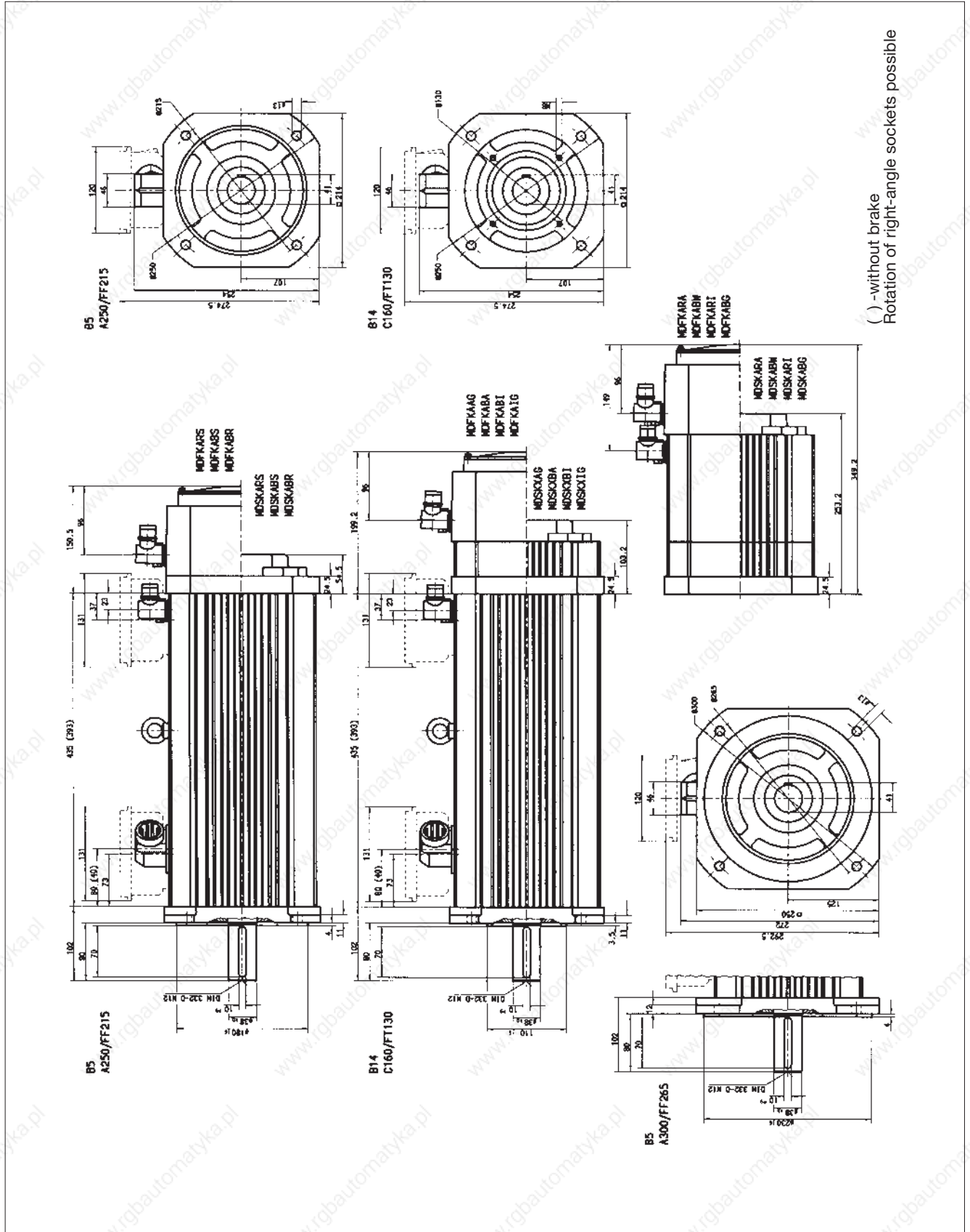

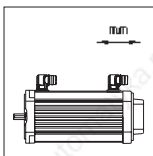

## Dimensions

### Asynchronous servo motors MDFQA 100...132, mounting position B5

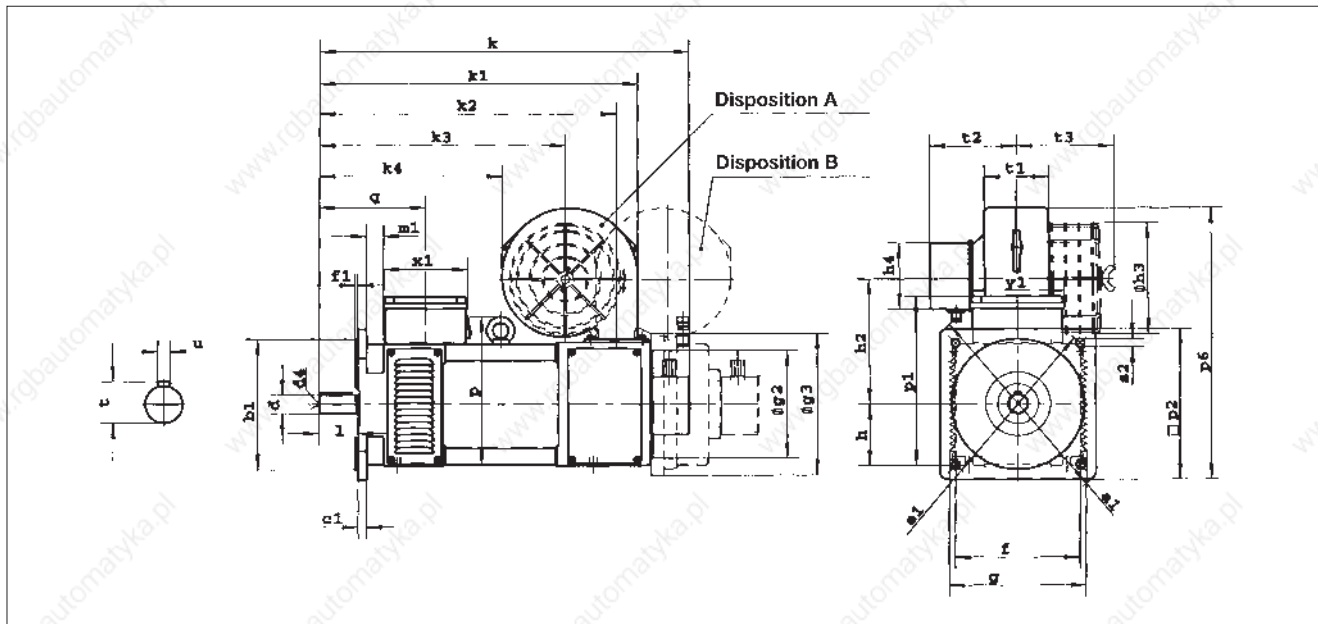

Motor type	Flange to DIN 42948	Flange to IEC 72	a1 P	b1 N	c HA	c1 LA	e1 M	f AB	f1 T	g AC	g2 -	h H	k2 -	m1 -	p -	p1 -	p2 -	q -
MDFQA 100-22	A300	FF265	300	230	14	12	265	196	4	212	163	100	452	25	243	282	220	181
MDFQA 132-32	A400	FF350	400	300	18	20	350	260	5	275	238	132	673	25	315	353	320	257

Motor type	s2 S	x1 -	y1 -	d D	l E	t GA	u F	d4 -	h2 -	h3 -	h4 -	k1 -	k3 -	k4 -	p6 -	t1 -	t2 -	t3 -	Separate fan
MDFQA 100-22	14	134	131	38	80	41	10	M12	180	-	94	480	386	304	395	82	111	124	G2D 120
	14	134	131	38	80	41	10	M12	214	185	94	489	348	240	457	100	97	142	G2D 140
	14	134	131	38	80	41	10	M12	204	187	110	487	367	275	431	52	158	64	DNG 3-4.5
MDFQA 132-32	18	261	160	55	110	59	16	M20	250	-	94	730	572	450	553	92	113	-	G2D 180
	18	261	160	55	110	59	16	M20	280	285	140	708	549	413	566	87	255	73	DNG 8-12

### Dimensions k

Motor type	Encoder		
	without	Resolver	ITD 21
MDFQA 100-22	540	572	572
MDFQA 132-32	790	822	822

### Dimensions k

Motor type	Brake 14.450					
	16	18	20	25	Resolver	ITD 21
MDFQA 100-22	666	666	-	-	696	696
MDFQA 132-32	-	-	901	901	933	933
MDFQA 100-132 *	214	243	278	330	-	-

\* = Dimension g3 (outer brake diameter)

Terminal box at top (standard)  
Shaft end fits to DIN 748T3

Key to DIN 6885, p. 1  
Designations to DIN (a, b, c...), IEC (B, A, HA...)

# Dimensions

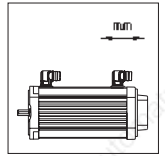

## Asynchronous servo motors MDFQA 100...132, mounting position B35

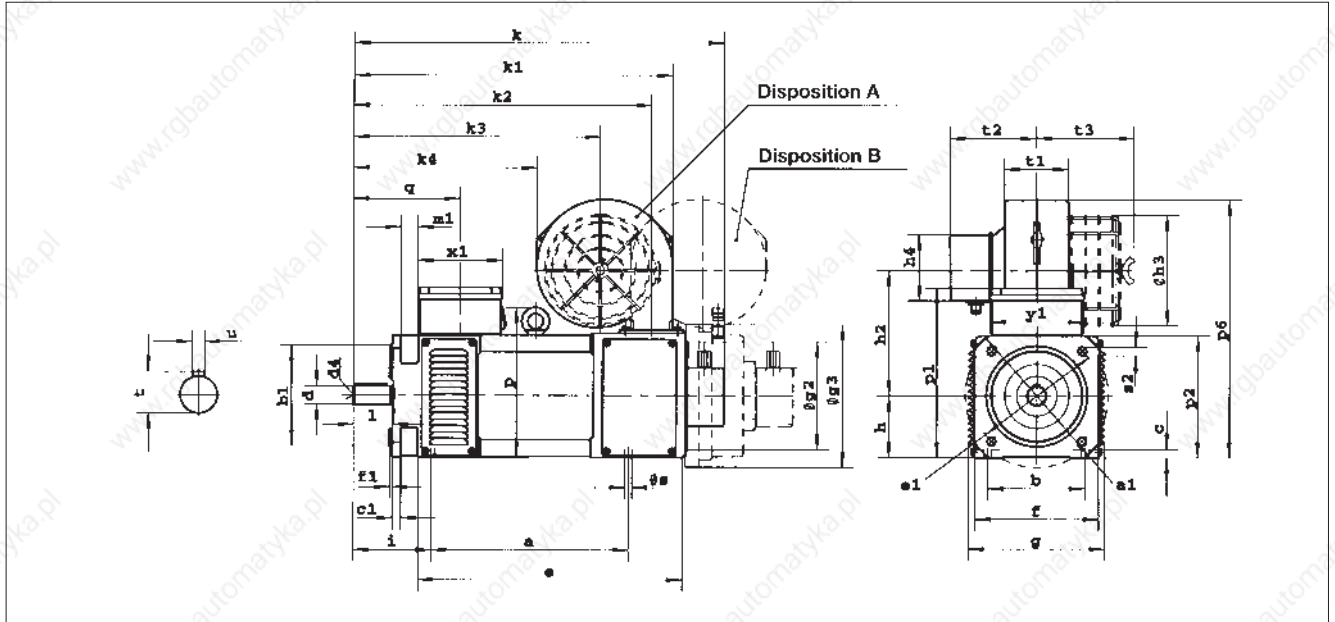

Motor type	Flange to DIN 42948	Flange to IEC 72	a B	a1 P	b A	b1 N	c HA	c1 LA	e BB	e1 M	f AB	f1 T	g AC	g2 -	h H	i -	k2 -	m1 -	p -	p1 -	p2 -
MDFQA 100-22	A250	FF215	295	250	160	180	14	12	382	215	196	4	212	163	100	143	452	25	243	270	198
MDFQA 112-22	A300	FF265	385	300	190	230	16	12	504	265	220	4	235	198	112	150	555	25	267	297	222
MDFQA 132-32	A300	FF265	460	300	215	230	18	12	604	265	260	4	275	238	132	199	673	25	315	353	262

Motor type	q -	s K	s2 S	x1 -	y1 -	d D	l E	t GA	u F	d4 -	h2 -	h3 -	h4 -	k1 -	k3 -	k4 -	p6 -	t1 -	t2 -	t3 -	Separate fan
MDFQA 100-22	181	12	14	134	131	38	80	41	10	M12	180	-	94	-	386	304	379	82	111	-	G2D 120
	181	12	14	134	131	38	80	41	10	M12	214	185	94	489	240	437	457	97	97	142	G2D 140 filter
	181	12	14	134	131	38	80	41	10	M12	204	187	110	487	367	275	408	52	158	64	DNG 3-4.5 wide range
MDFQA 112-22	168	12	14	157	155	38	80	41	10	M12	213	185	94	602	461	354	451	100	97	141	G2D 160
	168	12	14	157	155	38	80	41	10	M12	224	237	q123	590	430	322	486	87	234	96	DNG 5-12.5 Filter and wide range
MDFQA 132-32	257	15	18	261	160	55	110	59	16	M20	250	-	94	730	572	450	525	92	113	-	G2D 180
	257	15	18	261	160	55	110	59	16	M20	280	285	140	708	549	413	558	87	255	73	DNG 8-12 Filter and wide range

### Dimensions k

Motor type	Encoder		
	without	Resolver	ITD 21
MDFQA 100-22	540	572	572
MDFQA 112-22	660	692	692
MDFQA 132-32	790	822	822

Motor type	Brake 14.450					
	16	18	20	25	Resolver	ITD 21
MDFQA 100-22	666	666	-	-	698	698
MDFQA 112-22	-	786	786	-	818	818
MDFQA 132-32	-	-	931	931	963	963
MDFQA 100-132 *	214	243	278	330	-	-

\* = Dimension g3 (outer brake diameter)

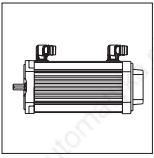

# Selection

## Selection of a servo drive

### Basic data

When installing a servo drive, normally a dynamic operation is required.

The essential data for the appropriate size of the motor are the following:

- Maximum torque  $M_{max}$ , Maximum speed  $n_{max}$ , efficient torque  $M_{eff}$  and if necessary transmission  $i$

**a) Transmission:**  
– for **perfect dynamic response**

**b) – for a good use while continuous operation**

$$i \approx \sqrt{\frac{J_{load}}{J_{motor}}}$$

$$i \approx \frac{n_{rated}}{n_{load}}$$

### Efficient torque:

$$M_{rms} = \sqrt{\frac{1}{T} \sum_i M_i^2 t_i}$$

### Maximum torque:

$$M_{max} = M_{accel} + \frac{1}{i} \frac{1}{\eta_{gearbox}} M_{load}$$

$$M_{accel} = 2 \cdot \pi \frac{\Delta n}{\Delta t} (J_{motor} + \frac{1}{i^2} J_{load})$$

### Selection of the motor

After having detected the technical data one may choose between synchronous and asynchronous motors, on the one hand and, on the other hand, between self ventilated

and forced ventilated motors. The main characteristics of the different motor types are listed below:

Select motor according to  $M_{rated} > M_{rms}$  and  $n_{max} > M_{max}$  and take into consideration:

- |  |   |   |
|--|---|---|
| – <b>no stream</b> of air allowed  | → | Motor without fan MDSK                            |
| – <b>fluffs</b> or something similar, that might block the air channels            | → | Motor without fan MDSK                            |
| – <b>high enclosure</b> required   | → | Motor without fan MDSK                            |
| – <b>high dynamic response</b> required  | → | Motor with fan MDFK,<br>Synchr. servo motor MDXKS |
| – operation with <b>constant power</b> with high speed (operation with weak field) | → | Asynchr. servo motor MDXKA                        |
| – very high <b>power density</b>   | → | Synchr. servo motor MDXKS                         |
|  | → | enclosed ventilated asynchr. motors MDFQA         |
| – <b>parallel operation</b> of servo mot. with one single inverter                 | → | Asynchr. servo motor MDXKA, MDFQA                 |

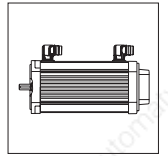

## Selection of a servo drive

### Operational mode: acceleration

Selecting the size of the drives according to the limit characteristics.

- Low noise
- Check permanent current

In the case of the continuous operation S6 and  $M_{\text{efficient}} < M_{\text{rated}}$  the current medium value  $I_{\text{medium}}$  is smaller than the permanent current of the installation.

If you select the drive according to  $n_{\text{max}}$  and  $M_{\text{max}}$ , the following has to be taken into account:

- selection of 16 kHz chopp. fre.
- especially with accelerating drive ( $I_{\text{max}} > 1.5 I_{\text{rated inverter}}$ )

$$I_{\text{perm}} > I_{\text{medium}} \equiv \frac{1}{T_i} \sum I_{\text{rated motor}} \cdot \frac{M_i \cdot t_i}{M_{\text{rated}}}$$

with synchr. motors

The mean is always below net value.

The following data are important for the operational mode acceleration drive:

$$\text{Permanent current} \approx 0.7 \cdot I_{\text{rated inverter}}$$

$$\text{Maximum current} \approx 2 \cdot I_{\text{rated inverter}}$$

9300

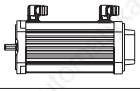

## Selection

### Possible combinations with controllers

#### Motor-controller assignment – servo motors – 9300 servo, 8 kHz chopper frequency

					Possible combinations and standard setting $I_{max} = 1.5 I_n$ , maximum torque in Nm										Possible combinations and operational mode acceleration controller Maximum torque in Nm Chopper frequency $f_{chopp} = 8 \text{ KHz}$					
					Chopper frequency $f_{chopp}$ $f_{chopp} = 8 \text{ KHz}$															
Inverter type					9321	9322	9323	9324	9325	9326	9327	9328	9329	9330	9331	9332	9321	9322	9323	9324
Continuous current [A]					1.5	2.5	3.9	7.0	13	23.5	32	47	59	89	110	145	1.05	1.7	2.6	4.7
Maximum current [A]					2.3	3.8	5.9	10.5	19.5	35.25	48	70.5	88.5	133.5	165	217.5	3	5	7.8	14
Motor type	h [mm]	$M_{rated}^{3000}$ [Nm]	$I_{rated}$ [A]	$M_{rated}$ [Nm]																
Synchr. servo motors without fan																				
MDSKS 036-13, 200	35		0.9	0.6	1.5	2.2											1.9			
MDSKS 036-23, 200	35		1.1	1.3	2.7	4.3	5.6										3.5	5.0		
MDSKS 056-23, 190	51	2.9	2.3	2.8	2.8	4.6	7.0										3.7	6.0	9.2	
MDSKS 056-33, 200	51	4.3	3.6	4.2		4.4	6.9	11.7										5.8	9.0	15.2
MDSKS 071-03, 170	65	5.9	4.2	5.7			8.0	13.8	23.6										10.6	17.8
MDSKS 071-13, 185	65	8.8	7	8.3			7.0	12.5	22.3	35.2									9.2	16.6
MDSKS 071-33, 180	65	13	10	12.3				12.9	24.0	41.4										17.2
with separate fan																				
MDFKS 071-03, 165	65	7.7	5.6	7.5			8.0	13.8	23.5										10.6	17.8
MDFKS 071-13, 180	65	11.7	9.2	11.0				12.5	21.8	35.2										16.6
MDFKS 071-33, 175	65	17	13.1	16.2				12.9	24.0	41.4										17.2



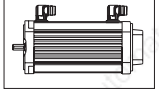

## Possible combinations with controllers

### Motor-controller assignment – servo motors – 9300 servo, 8 kHz chopper frequency

				Possible combinations and maximum torque in Nm												
				Chopper frequency $f_{chopp} = 8 \text{ KHz}$												
		Inverter type		9321	9322	9323	9324	9325	9326	9327	9328	9329	9330	9331	9332	
		Continuous current [A]		1.5	2.5	3.9	7.0	13	23.5	32	47	59	89	110	145	
		Maximum current [A]		2.3	3.8	5.9	10.5	19.5	35.3	48	70.5	88.5	133.5	165	217.5	
Motor type	h [mm]	$M_{rated}$ [Nm]	$P_{rated}$ [kW]	$I_{rated}$ [A]	$I_{max}^1$ [A]	$f_{rated}$ [Hz]										
<b>Asynchronous servo motors – surface cooled</b>																
without fan																
MDSKA 056-22, 140	51	2.0	0.8	2.4		140		4.45	7.3	9.8						
MDSKA 071-22, 140	65	4.0	1.7	4.4		140				12.6	19.5					
MDSKA 080-22, 70	71	6.7	1.4	3.3		70			15.1	29.3						
MDSKA 080-22, 140	71	5.4	2.3	5.8		140				13.2	26.0					
MDSKA 090-22, 80	83	10.8	2.6	5.5		80				24.4	46.2					
MDSKA 090-22, 140	83	9.5	4.1	10.2		140				23.4	43.7	59.4				
MDSKA 100-22, 80	96	16.3	4.0	8.2		80				47.2	88.2					
MDSKA 100-22, 140	96	12.0	5.2	14.0		140				20.7	43.3	60.7				
MDSKA 112-22, 85	107	24.6	6.4	13.5		85				46.2	78.0	92.4				
MDSKA 112-22, 140	107	17.0	7.4	19.8		140				43.9	63.3	96.8	123.0			
with separate fan																
MDFKA 071-22, 120	65	6.3	2.2	6.0		120				13.0	25.0					
MDFKA 080-22, 60	71	12.0	2.1	4.8		60				29.6	45.2					
MDFKA 080-22, 120	71	10.8	3.9	9.1		120				29.3	53.8					
MDFKA 090-22, 60	83	21.5	3.8	8.5		60				57.2	86.7					
MDFKA 090-22, 120	83	19.0	6.9	15.8		120				50.7	69.2	100.2				
MDFKA 100-22, 60	96	36.3	6.4	13.9		60				50.1	95.9	130.8				
MDFKA 100-22, 120	96	36.0	13.2	28.7		120				45.7	67.6	104.3	132.9	202.0		
MDFKA 112-22, 60	107	61.4	11.0	22.5		60				104.1	143.3	211.0	257.0			
MDFKA 112-22, 120	107	55.0	20.3	42.5		120						107.7	135.9	205.0	250.0	
<b>Asynchronous servo motors. enclosed ventilated</b>																
MDFQA 100-22, 50	100	$\lambda$	71.3	10.6	26.5		50			109.3	156.7	232.0	253.0			
MDFQA 100-22, 100	100	$\lambda$	66.2	20.3	46.9		100					112.5	146.4	227.0	257.0	
MDFQA 112-22, 50	112	$\lambda$	145	11.5	27.2		28				247.0	339.0	346.0			
MDFQA 112-22, 50	112	$\Delta$	135	20.1	43.7		50					230.1	292.9	341.8		
MDFQA 112-22, 100	112	$\lambda$	130	22.7	49.1		58					180.5	228.0	342.0	378.0	
MDFQA 112-22, 100	112	$\Delta$	125	38.4	81.9		100							216.0	273.0	355.0
MDFQA 132-32, 36	132	$\lambda$	296	17.0	45.2		20					482.0	612.0	751.0		
MDFQA 132-32, 36	132	$\Delta$	288	31.1	77.4		36							552.0	671.0	
MDFQA 132-32, 76	132	$\lambda$	282	35.4	88.8		42							424.0	512.0	663.0
MDFQA 132-32, 76	132	$\Delta$	257	60.1	144.8		76								344.0	458.0

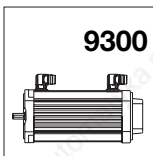

9300

# Selection

## Possible combinations with controllers

### Motor-controller assignment – servo motors – 9300 servo, 16 kHz chopper frequency (low-noise)

				Possible combinations and standard setting $I_{max} = 1.5 I_n$ Maximum torque in Nm								Possible combinations and controller for the operational mode acceleration Maximum torque in Nm			
				Chopper frequency $f_{chopp}$ $f_{chopp} = 16 \text{ KHz}$								Chopper frequency $f_{chopp}$ $f_{chopp} = 16 \text{ KHz}$			
Inverter type				9321	9322	9323	9324	9325	9326	9327	9321	9322	9323	9324	
Continuous current [A]				1.1	1.8	2.9	5.2	9.7	15.3	20.8	0.77	1.26	2.03	3.64	
Maximum current [A]				2.7	2.7	4.4	7.8	14.6	23	31.2	2.2	3.6	5.8	10.4	
Motor type	h [mm]	$I_{rated}$ [A]	$M_{rated}$ [Nm]												
<b>Synchronous servo motors without fan</b>															
MDSKS 036-13, 200	35	0.9	0.6	1.1	1.7	2.4					1.4	2.1			
MDSKS 036-23, 200	35	1.1	1.3	2.0	3.2	4.7					2.6	4.0	5.5		
MDSKS 056-23, 190	51	2.3	2.8	2.1	3.3	5.4	9.2				2.7	4.4	6.9		
MDSKS 056-33, 200	51	3.6	4.2			5.1	9.0	15.8					6.8	11.6	
MDSKS 071-03, 170	65	4.2	5.7			6.0	10.6	18.5					7.9	13.7	
MDSKS 071-13, 185	65	7	8.3				9.2	17.2	25.9	34.4				12.3	
MDSKS 071-33, 180	65	10	12.3					18.0	27.9	36.9					
<b>with separate fan</b>															
MDFKS 071-03, 165	65	5.6	7.5				10.6	18.5						13.7	
MDFKS 071-13, 180	65	9.2	11.0				9.2	17.2	25.9	34.4				12.3	
MDFKS 071-33, 175	65	13.1	16.2					18.0	27.9	36.9					

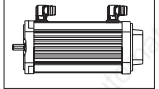

## Possible combinations with controllers

### Motor-controller assignment – servo motors – 9300 servo, 16 kHz chopper frequency (low-noise)

				Possible combinations and maximum torque in Nm												
				Chopper frequency $f_{chopp} = 16 \text{ KHz}$												
		Inverter type		9321	9322	9323	9324	9325	9326	9327	9328	9329	9330	9331	9332	
		Continuous current [A]		1.1	1.8	2.9	5.2	9.7	15.3	20.8	30.6	38	58	70	90	
		Maximum current [A]		1.7	2.7	4.4	7.8	14.6	23	31.2	45.9	57	87	105	135	
Motor type	h [mm]	$M_{rated}$ [Nm]	$P_{rated}$ [kW]	$I_{rated}$ [A]	$f_{rated}$ [Hz]											
<b>Asynchronous servo motors, surface cooled without fan</b>																
MDSKA 056-22, 140	51	2.0	0.8	2.4	140			5.3	9.2							
MDSKA 071-22, 140	65	4.0	1.7	4.4	140				9.2	17.3						
MDSKA 080-22, 70	71	6.7	1.4	3.3	70				21.2	35.1						
MDSKA 080-22, 140	71	5.4	2.3	5.8	140				9.1	19.1	30.8					
MDSKA 090-22, 80	83	10.8	2.6	5.5	80				17.5	34.5	50.0					
MDSKA 090-22, 140	83	9.5	4.1	10.2	140				16.9	28.0	38.6	56.9				
MDSKA 100-22, 80	96	16.3	4.0	8.2	80				33.8	56.7	78.1					
MDSKA 100-22, 140	96	12.0	5.2	14.0	140				25.8	37.6	57.9					
MDSKA 112-22, 85	107	24.6	6.4	13.5	85				55.8	71.4	90.3	97.5				
MDSKA 112-22, 140	107	17.0	7.4	19.8	140					37.5	60.1	76.8	120.8			
<b>with separate fan</b>																
MDFKA 071-22, 120	65	6.3	2.2	6.0	120				19.0	26.3						
MDFKA 080-22, 60	71	12.0	2.1	4.8	60				21.5	41.3						
MDFKA 080-22, 120	71	10.8	3.9	9.1	120				21.2	34.9	47.7					
MDFKA 090-22, 60	83	21.5	3.8	8.5	60				42.0	67.9	86.2					
MDFKA 090-22, 120	83	19.0	6.9	15.8	120					44.6	66.1	81.7				
MDFKA 100-22, 60	96	36.3	6.4	13.9	60				60.5	84.3	125.2	150.7				
MDFKA 100-22, 120	96	36.0	13.2	28.7	120						64.0	75.4	130.5	158.3		
MDFKA 112-22, 60	107	61.4	11.0	22.5	60					91.2	136.9	170.4	254.0			
MDFKA 112-22, 120	107	55.0	20.3	42.5	120								133.6	161.1	206.0	
<b>Asynchronous servo motors, enclosed ventilated</b>																
MDFQA 100-22, 50	100	$\lambda$	71.3	10.6	26.5	50					149.0	189.2	250.0			
MDFQA 100-22, 100	100	$\lambda$	66.2	20.3	46.9	100							143.6	175.2	227.2	
MDFQA 112-22, 50	112	$\lambda$	145	11.5	27.2	28					236.0	292.0	346.0			
MDFQA 112-22, 50	112	$\Delta$	135	20.1	43.7	50							288.5	314.3		
MDFQA 112-22, 100	112	$\lambda$	130	22.7	49.1	58							224.0	269.0	343.0	
MDFQA 112-22, 100	112	$\Delta$	125	38.4	81.9	100								159.4	217.0	
MDFQA 132-32, 36	132	$\lambda$	296	17.0	45.2	20							605.0	681.0	753.0	
MDFQA 132-32, 36	132	$\Delta$	288	31.1	77.4	36								440.0	556.0	
MDFQA 132-32, 76	132	$\lambda$	282	35.4	88.8	42									428.0	
MDFQA 132-32, 76	132	$\Delta$	257	60.1	144.8	76										

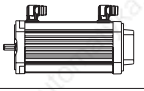

# Application examples

## Connection diagram

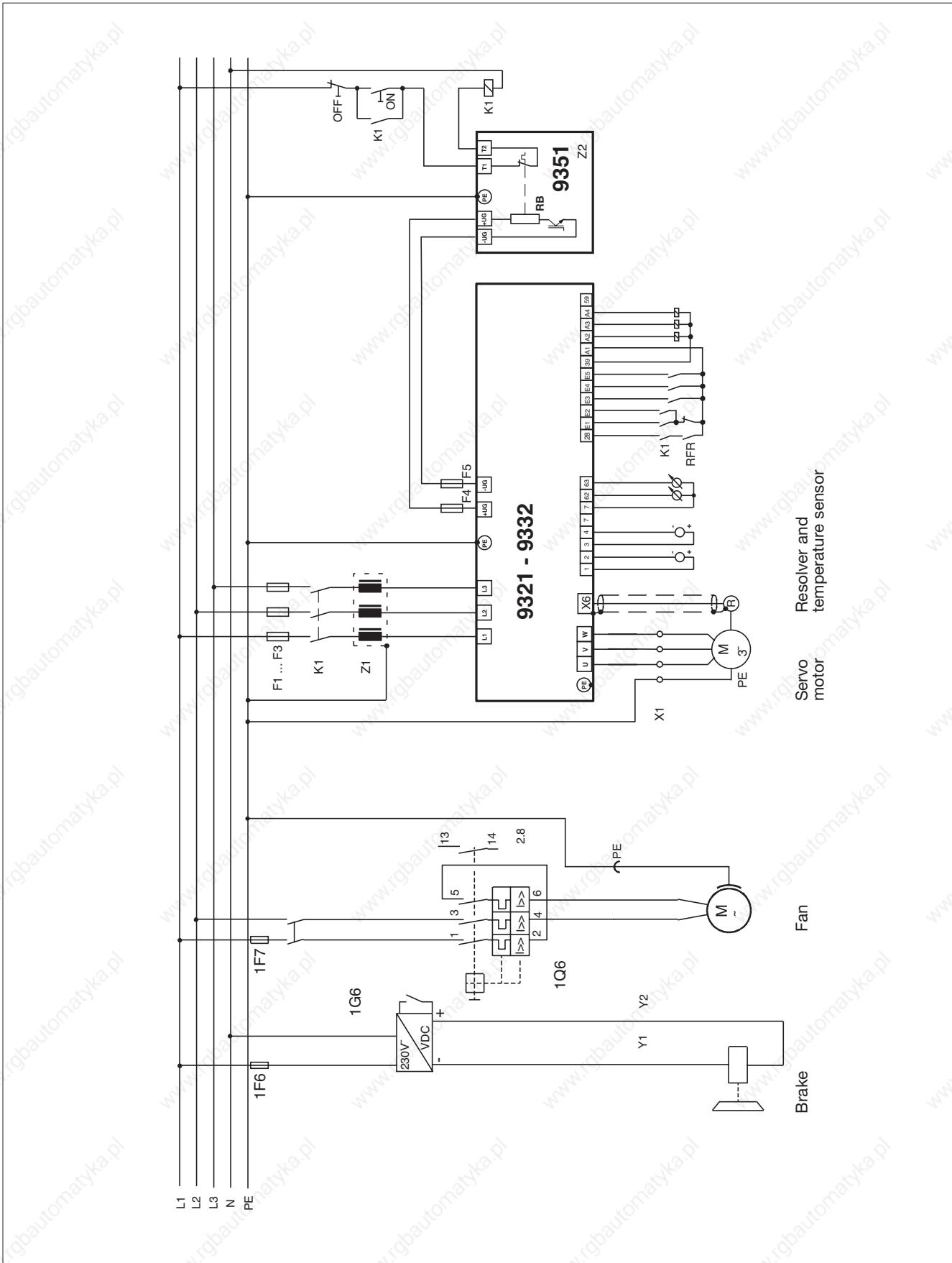

## EC-Declaration – Low-voltage Directive (73/23/EEC)

# Lenze

Lenze Drive Systems GmbH  
Postfach 10 13 52  
D-31763 Hameln

Site:  
Hans-Lenze-Straße 1  
D-31855 Aerzen  
Phone +49 (0)5154 82-0  
Telefax +49 (0)5154 82-21 11

### EC-Declaration of Conformity '96

for the purpose of the EC Low-Voltage Directive (73/ 23/ EEC)  
amended by: CE- mark directive (93/ 68/ EEC)

The following products were developed, designed, and manufactured in compliance with the above-mentioned EC directive under the sole responsibility of

**Lenze Drive Systems GmbH, Postfach 10 13 52, D-31763 Hameln**

**Product:**

DC motors

Asynchronous motors

Servo motors

Three-pase AC winder motors

**Type:**

MGFRK, MGFQU, MGFQK  
MGERK, MGEQU, MGEQK  
MGSRK, MGSQU, MGSQK

DFRA, DERA, DSRA  
MDFMA, MDEMA, MDSMA

DFVA, DSVA, MDFQA  
MDFKA, MDSKA  
MDFKS, MDSKS, MDSLK, MDLKS  
MCS, MCA

□□L12, □□F12  
□□S8, □□S6  
□□S4, □□F4  
□□MF4, □□SF4  
□□LF4

**Standards:**

EN 60204-1, IEC 204-1  
EN 60034, VDE 0530, IEC34

**Declaration about EMC directive (89/336/EEC)**

Asynchronous motors comply with the requirements of the EC directive " Electromagnetic Compatibility" 89/336/EEC under consideration of the standards EN 80081-1 and EN 50082-2 when connected to a sinusoidal AC mains voltage.

For inverter or DC-controller operation, the EMC notes of the manufacturers must be observed.

When using screened motor cables, the screening is most effective with a conductive connection with as large an area as possible between the screen and the earth potential of the motor (e.g. metal cable gland).

Hameln, March 4, 2004

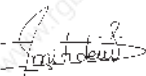

(i. A. Dr.-Ing. E. Nitidem)  
Entwicklungsleiter Elektromechanik



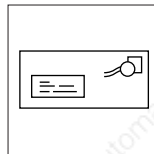

**Recipient:** **Lenze**  
**Branch office/ subsidiary**  
 Post code/ city: \_\_\_\_\_

## Servo motors series MDXKA/MDXKS – preference types

Fax: \_\_\_\_\_

### Expedient

Company: \_\_\_\_\_ Customer No. \_\_\_\_\_  
 Street / P.O. box: \_\_\_\_\_ Order No. \_\_\_\_\_  
 Postal Code / City: \_\_\_\_\_ Issuer \_\_\_\_\_  
 Delivery address\*: \_\_\_\_\_ Phone \_\_\_\_\_  
 Invoice addressee\*: \_\_\_\_\_ Fax \_\_\_\_\_  
 \* Please fill out if not expedient Date \_\_\_\_\_ Signature \_\_\_\_\_

<input type="checkbox"/> <b>MDSKAXX056-22</b> 0.8 KW 3950 RPM 390 V 140 Hz	<input type="checkbox"/> <b>MDSKAXX071-22</b> 1.7 KW 4050 RPM 390 V 140 Hz	<input type="checkbox"/> <b>MDSKAXX080-22</b> 2.3 KW 4100 RPM 390 V 140 Hz	<input type="checkbox"/> <b>MDSKAXX090-22</b> 4.1 KW 4110 RPM 350 V 140 Hz
--	--	--	--

<input type="checkbox"/> <b>MDSKAXX100-22</b> 5.2 KW 4150 RPM 330 V 140 Hz	<input type="checkbox"/> <b>MDSKAXX112-22</b> 7.4 KW 4160 RPM 320 V 140 Hz		Self-ventilated motors
--	--	--	------------------------

<input type="checkbox"/> <b>MDFKAXX071-22</b> 2.2 KW 3410 RPM 390 V 120 Hz	<input type="checkbox"/> <b>MDFKAXX080-22</b> 3.9 KW 3455 RPM 390 V 120 Hz	<input type="checkbox"/> <b>MDFKAXX090-22</b> 6.9 KW 3480 RPM 390 V 120 Hz	<input type="checkbox"/> <b>MDFKAXX100-22</b> 13.2 KW 3510 RPM 390 V 120 Hz
--	--	--	---

<input type="checkbox"/> <b>MDFKAXX112-22</b> 20.3 KW 3520 RPM 390 V 120 Hz			Forced-ventilated motors
---	--	--	--------------------------

<input type="checkbox"/> <b>MDSKSXX036-13</b> 0.25 KW 4000 RPM 245 V 200 Hz	<input type="checkbox"/> <b>MDSKSXX036-23</b> 0.54 KW 4000 RPM 345 V 200 Hz	<input type="checkbox"/> <b>MDSKSXX0056-23</b> 1.1 KW 3800 RPM 330 V 190 Hz	<input type="checkbox"/> <b>MDSKSXX056-33</b> 1.8 KW 4000 RPM 325 V 200 Hz
---	---	---	--

<input type="checkbox"/> <b>MDSKSXX071-03</b> 2.0 KW 3900 RPM 330 V 170 HZ	<input type="checkbox"/> <b>MDSKSXX071-13</b> 3.2 KW 3700 RPM 325 V 185 Hz	<input type="checkbox"/> <b>MDSKSXX071-33</b> 4.6 KW 3600 RPM 325 V 180 Hz	Self-ventilated motors
--	--	--	------------------------

<input type="checkbox"/> <b>MDFKSXX071-03</b> 2.6 KW 3300 RPM 320 V 165 HZ	<input type="checkbox"/> <b>MDFKSXX071-13</b> 4.1 KW 3600 RPM 325 V 180 Hz	<input type="checkbox"/> <b>MDFKSXX071-33</b> 5.9 KW 3500 RPM 325 V 175 Hz	Forced-ventilated motors
--	--	--	--------------------------

Motor power connection  **Plug**

Mounting  **B5 FF75** Only size 36  **B5A120** Only size 56  **B5A160** Only size 71  **B5A200** Only size 80/90  **B5A250** Only size 100/112  **B5A300** Only size 112

A-side  **without key**

Temperature monitoring  **KTY cont. temperature sensor**

Enclosure  **IP54**

Brake  **without brake**  **with brake**

Brake voltage (if selected)  **24V DC**

Encoder  **Resolver**

Gearbox mounting  **without gearbox**

Colour  **RAL 9005 black**

One cross only for each range! Price motor \_\_\_\_\_ **DM**

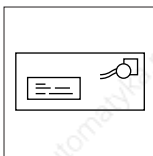

# Order form

Recipient: **Lenze**  
Branch office/  
subsidiary

Postal Code / city: \_\_\_\_\_

## Servo motors series MDFKS/MDSKS – industrial types

Fax: \_\_\_\_\_

### Expedient

Company	_____	Customer No.	_____
Street / P.O. box	_____	Order No..	_____
Postal Code / City	_____	Issuer	_____
Delivery address*	_____	Phone	_____
	_____	Fax	_____
Invoice addressee*	_____	Date of delivery	_____
	_____	Signature	_____

\* Please fill out if not expedient

Date \_\_\_\_\_

### MDSKSXX0056-23

1.1 KW  
3800 RPM  
330 V  
190 Hz

### MDSKSXX056-33

1.8 KW  
4000 RPM  
345 V  
200 Hz

### MDSKSXX071-03

2.0 KW  
3900 RPM  
330 V  
170 Hz

### MDSKSXX071-13

3.2 KW  
3700 RPM  
325 V  
185 Hz

### MDSKSXX071-33

4.6 KW  
3600 RPM  
325 V  
180 Hz

Self-ventilated motors

### MDFKSXX071-03

2.6 KW  
3300 RPM  
320 V  
165 Hz

### MDFKSXX071-13

4.1 KW  
3600 RPM  
325 V  
180 Hz

### MDFKSXX071-33

5.9 KW  
3500 RPM  
325 V  
175 Hz

Forced-ventilated motors

Motor power connection  Plug  Terminal box  
Only for size 56 and 71!

Mounting  **B5A120** Only size 56  **B5A160** Only size 71  
 B14C105 Only size 56  B14C160 Only size 71

B9 drive size  B9 - 1C Only size 56  B9 - 1D Only size 71

A-side  **without key**  with key (not for B9 – direct mounting of gearbox!)

Temperature monitoring  **KTY cont. temperature sensor**

Enclosure  **IP54**  IP65  
only for self-cooled motors, size 56 and 71

Brake  without brake  with brake

Brake voltage (if selected)  **24V DC**  205V DC  
only for size 56 / 71!

Encoder  **Resolver**  SinCos-encoder Single Turn  SinCos-encoder Multi Turn  ITD21 TTL 2048 pulses / rev.  
only for motor size 56 and 71! only for motor sizes 56 and 71!

Gearbox mounting  **without gearbox**  with "old" gearbox  KKL-1- (right)  KKL-2- (top)  KKL-3- (left)  KKL-4- (bottom)  
 with GNG gearbox  KKL-5- (left)  KKL-2- (top)  KKL-3- (left)  KKL-4- (bottom)

Colour  **RAL 9005**  
**black**

Preference drives are written in bold and are underlined One cross only for each range! Price motor + gearbox \_\_\_\_\_ DM



# Order form

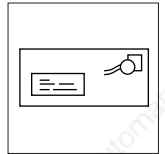

Recipient: **Lenze**  
Branch office/  
subsidiary

Postal Code / city: \_\_\_\_\_

Fax: \_\_\_\_\_

## Servo motors series MDFKA/MDSKA – industrial types

### Expedient

Company \_\_\_\_\_

Customer No. \_\_\_\_\_

Street / P.O. box \_\_\_\_\_

Order No. \_\_\_\_\_

Postal Code / City \_\_\_\_\_

Issuer \_\_\_\_\_

Delivery address\* \_\_\_\_\_

Phone \_\_\_\_\_

Invoice addressee\* \_\_\_\_\_

Date of delivery \_\_\_\_\_

\* Please fill out if not expedient

Date \_\_\_\_\_

Signature \_\_\_\_\_

<input type="checkbox"/> <b>MDSKAXX056-22</b> 0.8 KW 3950 RPM 390 V 140 Hz	<input type="checkbox"/> <b>MDSKAXX071-22</b> 1.7 KW 4050 RPM 390 V 140 Hz	<input type="checkbox"/> <b>MDSKAXX080-22</b> 1.4 KW 2000 RPM 390 V 70 Hz	<input type="checkbox"/> <b>MDSKAXX080-22</b> 2.3 KW 4100 RPM 390 V 140 Hz
<input type="checkbox"/> <b>MDSKAXX090-22</b> 2.6 KW 2300 RPM 390 V 80 Hz	<input type="checkbox"/> <b>MDSKAXX090-22</b> 4.1 KW 4110 RPM 350 V 140 Hz	<input type="checkbox"/> <b>MDSKAXX100-22</b> 4.0 KW 2340 RPM 390 V 80 Hz	<input type="checkbox"/> <b>MDSKAXX100-22</b> 5.2 KW 4150 RPM 330 V 140 Hz
<input type="checkbox"/> <b>MDSKAXX112-22</b> 6.4 KW 2490 RPM 390 V 85 Hz	<input type="checkbox"/> <b>MDSKAXX112-22</b> 7.4KW 4160 RPM 320 V 140 Hz	Self-cooled motors	

<input type="checkbox"/> <b>MDFKAXX071-22</b> 2.2 KW 3410 RPM 390 V 120 Hz	<input type="checkbox"/> <b>MDFKAXX080-22</b> 2.1 KW 1635 RPM 390 V 60 Hz	<input type="checkbox"/> <b>MDFKAXX080-22</b> 3.9 KW 3455 RPM 390 V 120 Hz	<input type="checkbox"/> <b>MDFKAXX090-22</b> 3.8 KW 1680 RPM 390 V 60 Hz
<input type="checkbox"/> <b>MDFKAXX090-22</b> 6.9 KW 3480 RPM 390 V 120 Hz	<input type="checkbox"/> <b>MDFKAXX100-22</b> 6.4 KW 1700 RPM 390 V 60 Hz	<input type="checkbox"/> <b>MDFKAXX100-22</b> 13.2 KW 3510 RPM 390 V 120 Hz	<input type="checkbox"/> <b>MDFKAXX112-22</b> 11.0 KW 1710 RPM 390 V 60 Hz
<input type="checkbox"/> <b>MDFKAXX112-22</b> 20.3 KW 3520 RPM 390 V 120 Hz	Forced-ventilated motors		

Motor power connection	<input type="checkbox"/> <b>Plug</b>	<input type="checkbox"/> Terminal box				
Mounting	<input type="checkbox"/> <b>B5A120</b> <small>Only size 36</small>	<input type="checkbox"/> <b>B5A160</b> <small>Only size 71</small>	<input type="checkbox"/> <b>B5A200</b> <small>Only size 80/90</small>	<input type="checkbox"/> <b>B5A250</b> <small>Only size 100/112</small>	<input type="checkbox"/> <b>B5A300</b> <small>Only size 112</small>	
	<input type="checkbox"/> B14C105 <small>Only size 56</small>	<input type="checkbox"/> B14C160 <small>Only size 71/80/90/100/112</small>				
B9 drive size	<input type="checkbox"/> B9 - 1C <small>Only size 56</small>	<input type="checkbox"/> B9 - 1D <small>Only size 71</small>	<input type="checkbox"/> B9 - 1E <small>Only size 80</small>	<input type="checkbox"/> B9 - 1F <small>Only size 90</small>	<input type="checkbox"/> B9 - 1G <small>Only size 100</small>	<input type="checkbox"/> B9 - 1H <small>Only size 112</small>
A-side	<input type="checkbox"/> <b>without key</b>	<input type="checkbox"/> with key	(not for B9 – direct mounting of gearbox!)			
Temperature monitoring	<input type="checkbox"/> <b>KTY cont. temperature sensor</b>					
Enclosure	<input type="checkbox"/> <b>IP54</b>	<input type="checkbox"/> IP65	<small>only for self-cooled motors!</small>			
Brake	<input type="checkbox"/> without brake <input type="checkbox"/> with brake					
Brake voltage (if selected)	<input type="checkbox"/> <b>24V DC</b> <input type="checkbox"/> 205V DC					
Encoder	<input type="checkbox"/> <b>Resolver</b>	<input type="checkbox"/> SinCos-encoder <small>Single-turn</small>	<input type="checkbox"/> SinCos-encoder <small>Multi-turn</small>	<input type="checkbox"/> ITD21 TTL <small>2048 pulses/rev.</small>		
Gearbox mounting	<input type="checkbox"/> <b>without gearbox</b>	<input type="checkbox"/> with "old" gearbox	<input type="checkbox"/> KKL-1- (right)	<input type="checkbox"/> KKL-2- (top)	<input type="checkbox"/> KKL-3- (left)	<input type="checkbox"/> KKL-4- (bottom)
		<input type="checkbox"/> with GNG gearbox	<input type="checkbox"/> KKL-5- (right)	<input type="checkbox"/> KKL-2- (top)	<input type="checkbox"/> KKL-3- (left)	<input type="checkbox"/> KKL-4- (bottom)
Colour	<input type="checkbox"/> <b>RAL 9005</b> black					

Preference drives are written in bold and are underlined  
One cross only for each range!

Price motor + gearbox \_\_\_\_\_ DM

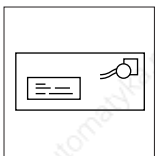

# Order form

Recipient: **Lenze**  
Branch office/  
subsidiary

Postal Code/city: \_\_\_\_\_

## Servo motor MDFQA – preference type

Fax: \_\_\_\_\_

### Expedient

Company \_\_\_\_\_

Customer No. \_\_\_\_\_

Street / P.O. box \_\_\_\_\_

Order No. \_\_\_\_\_

Postal Code / City \_\_\_\_\_

Issuer \_\_\_\_\_

Delivery address\* \_\_\_\_\_

Phone \_\_\_\_\_

Fax \_\_\_\_\_

Invoice addressee\* \_\_\_\_\_

Date of delivery \_\_\_\_\_

\* Please fill out if not expedient Date \_\_\_\_\_

Signature \_\_\_\_\_

**MDFQA xx 100-22**  
 10.6 KW  
1420 RPM  
360 V  
50 Hz

20.3 KW  
2930 RPM  
360 V  
100 Hz

**MDFQA xx 112-22**  
 20.1 / 11.5 KW  
1425 / 760 RPM  
360 V  
50 / 28 HZ

38.4 / 22.7 KW  
2935 / 1670 RPM  
360V  
100 / 58 Hz

**MDFQA xx 132-32**  
 31.1 / 17.0 KW  
1030 / 550 RPM  
360 V  
36 / 20 HZ

60.1 / 35.4 KW  
2235 / 1200 RPM  
340 / 360 V  
76 / 42 Hz

Operation mode  **S1 continuous operation**

Mounting  **B3/B5**  **B6/B5**  **B7/B5**  **B8/B5**  **V1/V5**  **V3/V6**  
Flange combination mountings: MDFQA100 = A250 MDFQA112 = A300 MDFQA132 = A300  
 **B5**  **V1**  **V3** B5 , V1 , V3 are not possible with size 112.  
Flange single mountings MDFQA100 = A300 MDFQA132 = A400

A-side  **with key**

B-side  **Motor for encoder mounting**  **Motor for brake/encoder mounting**

Temperature monitoring  **Thermal contact normally-closed + KTY contact sensor**

Enclosure  **IP23s**

Terminal box position  **-2- (on top)** referring to B3 mounting  
\* Looking on motor drive-end

Brakes  **without brake**  14.450. \_\_\_\_\_  
 24V DC  205V DC  230V AC incl rectifier

Encoder  **without encoder**  **Resolver**

only mounting device (all motors are suitable to munt A4 tachos (with hollow-shaft) as standard)

External fan for : **380 ... 460 V** without filter with filter **350 ... 540 V** with filter

size 100  G2D120  G2D140

size 112  G2D160  G2D160

size 132  G2D180  DNG 8 -12

Fan position  **-2- on top**  **-1- right side**  **-3- left side**  **-4- bottom (only for gearbox mounting)**  **without fan**

Fan housing position  **front-sided**  **back-sided**

Gearbox attachment  **without gearbox**  with "old" gearbox  KKL-1- (right)  KKL-2- (top)  KKL-3- (left)  KKL-4- (bottom)  
 with GnG gearbox  KKL-5- (right)  KKL-2- (top)  KKL-3- (left)  KKL-4- (bottom)

Colour  RAL 9005 black  RAL 6011 reseda green  RAL 2000 yellow orange  coated signal grey  RAL 9018 papyrus white

2nd nameplate  attached to terminal box

Preference types are written in bold and are underlined Price motor + gearbox \_\_\_\_\_ DM

One cross only for each range!

# Order form

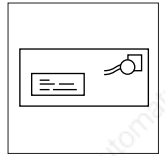

Recipient: **Lenze**  
Branch office/  
subsidiary

Postal Code/city: \_\_\_\_\_

Fax \_\_\_\_\_

## Servo motor MDFQA – industrial type

### Expedient

Company \_\_\_\_\_

Customer No. \_\_\_\_\_

Street / P.O. box \_\_\_\_\_

Order No. \_\_\_\_\_

Postal Code/City \_\_\_\_\_

Issuer \_\_\_\_\_

Delivery address\* \_\_\_\_\_

Phone \_\_\_\_\_

Invoice addressee\* \_\_\_\_\_

Date of delivery \_\_\_\_\_

\* Please fill out if not expedient

Date \_\_\_\_\_

Signature \_\_\_\_\_

- |  |   |
|--|---|
| <input type="checkbox"/> <b>MDFQA xx 100-22</b><br>10.6 KW<br>1420 RPM<br>360 V<br>50 Hz                   | <input type="checkbox"/> 20.3 KW<br>2930 RPM<br>360 V<br>100 Hz                         |
| <input type="checkbox"/> <b>MDFQA xx 112-22</b><br>20.1 / 11.5 KW<br>1425 / 760 RPM<br>360 V<br>50 / 28 HZ | <input type="checkbox"/> 38.4 / 22.7 KW<br>2935 / 1670 RPM<br>360V<br>100 / 58 Hz       |
| <input type="checkbox"/> <b>MDFQA xx 132-32</b><br>31.1 / 17.0 KW<br>1030 / 550 RPM<br>360 V<br>36 / 20 HZ | <input type="checkbox"/> 60.1 / 35.4 KW<br>2235 / 1200 RPM<br>340 / 360 V<br>76 / 42 Hz |

Operation mode  **S1 continuous operation**

Mounting  **B3/B5**  **B6/B5**  **B7/B5**  **B8/B5**  **V1/V5**  **V3/V6**  
Flange combination mountings: MDFQA100 = A250 MDFQA112 = A300 MDFQA132 = A300  
 **B5**  **V1**  **V3** B5 , V1 , V3 are not possible with size 112.  
Flange single mountings MDFQA100 = A300 MDFQA132 = A400

A-side  **with key**  **without key**

B-side  **Motor for encoder mounting**  **Motor for brake/encoder mounting**

Temperature monitoring  **Thermal contact normally-closed + KTY contact sensor**

Enclosure  **IP23s**

Terminal box position  **-2- (on top)** referring to B3 mounting  
\* Looking on motor drive-end

Brakes  **without brake**  14.450.\_\_\_\_\_  
 24V DC  205V DC  230V AC incl rectifier

Encoder  without encoder  **Resolver**  IDT21 TTL 4096 pulses  IDT21 TTL 2048 pulses  SinCos encoder Single turn  SinCos encoder Multi turn

only mounting device \_\_\_\_\_ (all motors are suitable to munt A4 tachos (with hollow-shaft) as standard)

External fan for :	380 ... 460 V		350 ... 540 V	
	without filter	with filter	without filter	with filter
size 100	<input type="checkbox"/> G2D120	<input type="checkbox"/> G2D140	<input type="checkbox"/> DNG 3 - 4.5	<input type="checkbox"/> DNG 3 - 4.5
size 112	<input type="checkbox"/> G2D160	<input type="checkbox"/> G2D160	<input type="checkbox"/> DNG 5 - 12.5	<input type="checkbox"/> DNG 5 - 12.5
size 132	<input type="checkbox"/> G2D180		<input type="checkbox"/> DNG 8 - 12	<input type="checkbox"/> DNG 8 - 12

Fan position  **-2- on top**  **-1- right side**  **-3- left side**  **-4- bottom (only for gearbox mounting)**  **without fan**

Fan housing position  **front-sided**  back-sided

Gearbox attachment  **without gearbox**  with "old" gearbox  KKL-1- (right)  KKL-2- (top)  KKL-3- (left)  KKL-4- (bottom)  
 with GnG gearbox  KKL-5- (right)  KKL-2- (top)  KKL-3- (left)  KKL-4- (bottom)

Colour  RAL 9005 black  RAL 6011 reseda green  RAL 2000 yellow orange  coated signal grey  RAL 9018 papyrus white

2nd nameplate  attached to terminal box

**Preference types are written in bold and are underlined** Price motor + gearbox \_\_\_\_\_ **DM**  
One cross only for each range!



