

Discrete I/O modules

Characteristics :
pages 42304/4 to 42304/9
References :
pages 42304/10 and 42304/11
Connections :
pages 42304/12 to 42304/15

Functions

Discrete I/O modules provide the functions of matching, galvanic isolation, filtering and protection against induced interference, overloads and overvoltages.

Characteristics specific to this range of modules are :

Module location

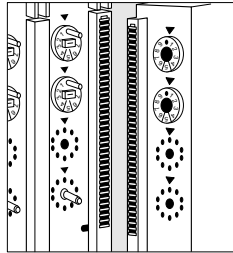

- **Hardware location device**
These devices are fitted to all the modules as well as to the backplane of the rack. By enabling the user to customize each slot of the rack to receive a particular type of module, this device eliminates all risks of errors when inserting or exchanging a module. A second location device allows the user to distinguish between modules of the same type but which may have different uses or are adjusted differently.
- **Software location device**
During the configuration procedure, the software code for each module is assigned to the specific slot it must occupy. If the actual configuration does not agree with that declared, the processor is informed.

Exchange security

The exchange of data between the PLC processor and the I/O modules is systematically checked during each PLC scan.

- **Hardware security**
The design of the I/O bus, incorporating high level technology, complete screening and withstand to short circuits, ensures a high level of security for data exchanged over the I/O bus.
- **Software security**
During each data exchange, the processor checks (parity check) the validity of data carried on the bus. In case of error, the processor does not validate the exchange and a fault is declared. This procedure avoids disrupting the control system due to incorrect exchanges.

Installation and removal of I/O under power

- **Hardware aspect**
Special measures have been incorporated to allow discrete I/O modules and their cable connectors to be connected and disconnected while energized and while the program is being scanned, without risk of damage.
- **Software security**
The processor is informed of these interventions. This information, which can be accessed by the program, allows the user to determine the action to be taken for the machine being controlled.

Module protection

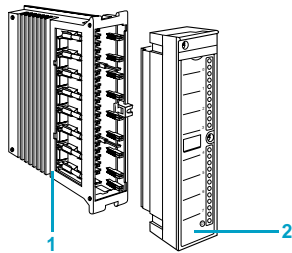

Electrical and mechanical protection : the design of the I/O modules ensures a high level of immunity to industrial interference and enables them to withstand overvoltages and polarity inversions. Most of the 4, 8, 16 or 24 channel output modules are protected by electronic overload protectors and peak limiters, or by fuses **1**.

- All faults detected by these devices are :
- displayed on the front panel of the module **2**
 - transmitted to the processor

Processing of I/O "FAULT" information

- **Hardware**
The I/O lamp on the front panel of the processor indicates an I/O fault :
 - configuration fault
 - data exchange fault
 - I/O module or cable connector disconnected
 - overload on the outputs.The fault can then be located and its cause determined by using SYSDIAG maintenance software.
- **Software**
Each I/O module has its own fault bit which can be accessed by the user. System bits specific to the I/O are also available.
Analysis and processing of all these bits by the user program eliminates any transient operation caused by the fault which may endanger the application, and can also be used to run the application in fallback mode.

Discrete I/O modules

Characteristics :
 pages 42304/4 to 42304/9
 References :
 pages 42304/10 and 42304/11
 Connections :
 pages 42304/12 to 42304/15

Functions

Special functions

TSX DET 4 66 Namur input module. This has 4 inputs specially designed for receiving signals from Namur proximity sensors. Volt-free contacts can also be connected to this module. Each input has a line monitoring device which detects line breaks and short-circuits.

TSX DST 4 17 output module. This has four $\overline{\text{---}}$ 24/48 V - 2 A outputs which are isolated and electronically protected against overloads and short-circuits. If any of these outputs goes to 1 when the external supply is absent, a fault bit is detected. One fault lamp per point indicates that a fault is present. One fault bit per point is then transmitted to the PLC processor.

TSX DET 32..., TSX DST 24 72 and TSX DST 32 92 modules

24 and 32-point discrete I/O modules can be combined to create configurations of 224 I/O in a single format rack (128 inputs in 32-point modules and 96 outputs in 24-point modules) or of 256 I/O (128 inputs in 32-point modules and 128 outputs in 32-point modules).

The terminal block fault bit (accessible by programming terminals or the application program) indicates the absence or incorrect voltage of the sensor (or preactuator) supply at the module.

I/O installation and addressing

I/O interface modules have 4, 8, 16, 24 or 32-point modularity.

The address of an input or output is defined by :

- 4, 8 and 16-point modules I/Oxy,i
 - 24 and 32-point modules I/Oxy,i (points 0 to 15)
I/O(x+1)y,i (points 16 to 24 or 32)
- I : input
 O : output
 y : slot n° in rack (0 to 7)
 x : n° of rack containing the module
 , : comma
 i : point n° (0 to F)

Note : PL7 software allows the user to enter and display the I/O either by the address as defined above, or by an associated 8-character mnemonic symbol (example : Close).

The rules for installing I/O interface modules are defined by the table below :

Type	Basic configuration		Local or remote extension	
	PLC base	Direct extension	Local/remote extension rack	Direct extension
Rack no.	0/1	2/3	x	x + 1
4/8 points	0 to 7 (1)	0 to 7 (2)	0 to 7 (1)	0 to 7 (2)
16 points	0 to 7 (1)	0 to 7 (2)	0 to 7 (1)	0 to 7 (2)
24/32 points	0 to 7 (1)	0 to 7 (2)	0 to 7 (1)	imp (3)

(1) 0 to 4 for short rack

(2) 0 to 6 for short rack

(3) If the base rack is short, it is possible to insert 24 or 32 I/O modules in slots 5, 6 and 7.

imp : installation impossible

Note : The double addressing of base racks allows 32 I/O modules to be located simultaneously in the base rack and in the direct extension racks.

Connection principles

Independent points

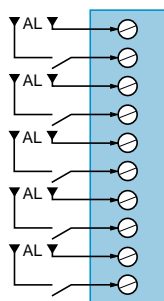

- Each point independently connected
- One power supply per point

Two wires per point

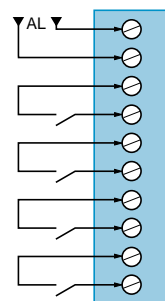

- Each point connected to the terminal block by two wires
- Power supply commons integrated in terminal block

External commons

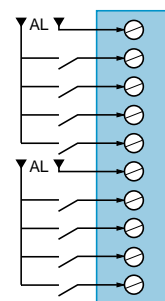

- Each point connected to the terminal block by one wire
- Power supply commons to be made externally

There are three methods of connecting 4 or 8 point I/O modules to the sensors and preactuators, depending on the type of terminal block used :

- Independent points : no connection between points.
- Two wires per point : using commons integrated in the connection block
- External commons : made using an intermediate connection block. 16, 24 and 32-point modules can only be connected in this way.

Discrete I/O modules

General :
pages 42304/2 and 42304/3
References :
pages 42304/10 and 42304/11
Connections :
pages 42304/12 to 42304/15

Characteristics of d.c. inputs

Type of module		TSX DET 32 32	TSX DET 32 42	TSX DET 32 52	
Nominal input values	Voltage	24 V	24 V	24 V	
	Current	7 mA	7 mA	7 mA	
	Sensor supply (ripple included)	19.2...30 V	19.2...30 V	19.2...30 V	
Input limit values	At state 1	Voltage	11...30 V	11...30 V	11...30 V
		Current	> 5 mA	> 5 mA	1.7...8.8 mA
	At state 0	Voltage	- 30...5 V	- 30...5 V	- 30...5 V
		Current	- 15...2.5 mA	- 15...2.5 mA	- 10.3...0.98 mA
	Continuous reverse voltage	30 V	30 V	30 V	
Max voltage for 1 min	± 48 V	± 48 V	± 48 V		
Input impedance		3.4 k	3.4 k	3.4...4.2 k	
Logic		Positive current drawn			
Response time	Change from state 0 to state 1	2...4.5 ms	6...10 ms	7...20 ms	
	Change from state 1 to state 0	2...4.5 ms	6...10 ms	6...19 ms	
Coupling capacitance at ~ 220 V		30 nF max	30 nF max	30 nF max	
Dissipated power	Per point at state 1	0.17 W	0.17 W	0.16 W	
Display lamp	State of each input	Sensor side			
Sensor common		On power supply "+"			
Compatible output modules		TSX DST 24 72/32 92			
External line	Line resistance	0...500			
	Open line leakage resistance	30 k minimum			
Isolation	Between points or groups of points	1500 V rms 50-60 Hz		Not isolated	
	Between points and internal bus	1500 V rms 50-60 Hz		Not isolated	
	Type	Opto-coupler		-	

Type of module		TSX DET 8 14	TSX DET 8 24	
Nominal input values	Voltage	130 V	110/120 V	
	Current	11.2 mA	13.6 mA	
	Sensor supply (ripple included)	100...142 V	86...132 V	
Input limit values	At state 1	Voltage	> 88 V	> 77 V
		Current	> 8 mA	> 8.5 mA
	At state 0	Voltage	< 25 V	35 V
		Current	< 2.2 mA	3.5 mA
	Continuous reverse voltage	142 V	132 V	
Max voltage for 1 min	± 156 V	± 220 V		
Input impedance		11.6...12.8 k	8...9 k	
Logic		Positive current drawn (1)		
Response time	Change from state 0 to state 1	5...8 ms	8.7...13.8 ms	
	Change from state 1 to state 0	2.5...4 ms	16.7...26.3 ms	
Coupling capacitance at ~ 220 V		30 nF max	40 nF max	
Dissipated power	Per point at state 1	1.46 W	1.5 W	
Display lamp	State of each input	Sensor side		
Sensor common		On power supply "+"		
Compatible output modules		TSX DST 16 34	TSX DST 4 17/8 17	
External line	Line resistance	< 1 k	0...500	
	Open line leakage resistance	> 60 k	30 k minimum	
Isolation	Between points or groups of points	1500 V rms 50-60 Hz		
	Between points and internal bus	1500 V rms 50-60 Hz		
	Type	Opto-coupler		

(1) Negative logic, current emitted possible for TSX DET 8 24 with independent point connections (TSX BLK 1).

Discrete I/O modules

General :
pages 42304/2 and 42304/3
References :
pages 42304/10 and 42304/11
Connections :
pages 42304/12 to 42304/15

Characteristics of d.c. inputs

Type of module			TSX DET 8 13/16 13/16 33			TSX DET 8 12/16 12	
Nominal input values	Voltage		48 V			24 V	
	Current		10.5 mA			16.5 mA	
	Sensor supply (ripple included)		38...60 V			19.2...30 V	
Input limit values	At state 1	Voltage	> 30 V			> 11 V	
		Current	> 6 mA			> 6 mA	
	At state 0	Voltage	12 V			5 V	
		Current	2.5 mA			2.5 mA	
	Continuous reverse voltage		60 V			30 V	
Max voltage for 1 min		± 110 V			± 48 V		
Input impedance			4.275...4.720 k			1.380...1.520 k	
Logic			Positive current drawn (1)				
Response time			DET 8 13	DET 16 13	DET 16 33	DET 8 12	DET 16 12
	Change from state 0 to state 1		5...8 ms	5...20 ms	0.5...2 ms	5...8 ms	5...20 ms
	Change from state 1 to state 0		2.5...4 ms	2.5...10 ms	0.25...1 ms	2.5...4 ms	2.5...10 ms
Coupling capacitance at ~ 220 V			30 nF max			30 nF max	
Dissipated power	Per point at state 1		0.52 W			0.43 W	
Display lamp	State of each input		Sensor side				
Sensor common			On power supply "+"				
Compatible output modules			TSX DST 4 17/8 17			TSX DST 4 17/8 17 TSX DST 16 12/16 82 TSX DST 8 35/8 82	
External line	Line resistance		0...500				
	Open line leakage resistance		30 k minimum				
Isolation	Between points or groups of points		1500 V rms 50-60 Hz				
	Between points and internal bus		1500 V rms 50-60 Hz				
	Type		Opto-coupler				

Type of module			TSX DET 4 66				
Nominal input values	Voltage		Namur (8.2 V)				
	Current		4 mA				
	Sensor supply (ripple included)		17...30 V				
Input limit values	At state 1	Current	2.1...9 mA				
	At state 0	Current	0...1.2 mA				
Logic			Positive current drawn				
Response time	Change from state 0 to state 1		0.5...2 ms				
	Change from state 1 to state 0		0.5...2 ms				
No-load voltage	Of inputs		7.7...9 V				
Current	On power break		< 0.15 mA				
	Short-circuit		> 6 mA				
Resistance	Internal		1000				
	In series with conductors		> 50				
	Shunt on conductors		> 100 k				
Display lamp	State		1 lamp per point				
	Fault		1 lamp per point				
Sensor common			On power supply "+"				
Compatible output modules			-				
External line	Line resistance		0...500				
	Open line leakage resistance		30 k minimum				
Isolation	Between points or groups of points		1500 V rms 50-60 Hz				
	Between points and internal bus		1500 V rms 50-60 Hz				
	Type		Opto-coupler				

(1) Negative logic, current emitted possible for TSX DET 8 12 with independent point connections (TSX BLK 1).

Discrete I/O modules

General :
pages 42304/2 and 42304/3
References :
pages 42304/10 and 42304/11
Connections :
pages 42304/12 to 42304/15

Characteristics of d.c. outputs

Type of module		TSX DST 32 92	TSX DST 24 72
Loads	Voltage	24 V	24 V
	Nominal current	100 mA	0.5 A
	Limitation and detection current	–	1.5 A
	Tungsten filament lamp	1 W max	8 W max
Limit values	Voltages (ripple included)	19...30 V	19...30 V
Logic		Positive current emitted	
Response time	Change from state 0 to state 1	20 µs max	typically 10 µs
	Change from state 1 to state 0	30 µs max	typically 50 µs
Leakage current	At state 0	100 µA	1 mA
Residual voltage	At state 1	2 V max	1.2 V max
Built-in protection	Against overloads	–	Limiter
	Against inductive overvoltages	Discharge diode	Diode and capacitor
	Against reverse polarity	Series diode	Series diode
Current		150 mA	200 mA
Display lamp	State of each output	PLC side	
Load common		On power supply “-”	
Capacitance of external source	Single phase 2 half-waves	–	
	3-phase 2 half-waves	–	
Compatible input modules		TSX DET 32 42	
Loads		Resistive or inductive	
Fault display	On front panel	–	
Isolation	Between groups of points	1500 V rms 50-60 Hz	
	Between points and internal bus	1500 V rms 50-60 Hz	
	Type	Opto-coupler	

Type of module		TSX DST 16 34	TSX DST 16 32	
Loads	Voltage	48...130 V	24 V	
	Power	Resistive	6 W P 50 W	0.2 W P 50 W
		Inductive (L/R < 63 ms)	6 W P 25 W	0.2 W P 25 W
	Durability	10 ⁶ operating cycles	10 ⁶ operating cycles	
Limit values	Voltages (ripple included)	38 V U 142 V	10 V U 30 V	
	Total load 40 °C	16 relays	16 relays	
	on the module 40...60 °C (derated)	8 relays	8 relays	
Logic		Positive current emitted		
Response time	Change from state 0 to state 1	15 ms max	15 ms max	
	Change from state 1 to state 0	20 ms max	20 ms max	
Leakage current	At state 0	0.2 mA max	0.2 mA max	
Built-in protection	Against overloads and short-circuits	None (1)	None (1)	
	Against inductive overvoltages	None (2)	Included (except supply)	
Compatible input modules		TSX DET 8 14	TSX DET 16 12	
Loads		Resistive or inductive (3)		
Display lamps		State of each output		
Load common		On power supply “-”		
Isolation	Between groups of points	1500 V rms 50-60 Hz		
	Between points and internal bus	1500 V rms 50-60 Hz		
	Type	Relay		

(1) External semi-time-delayed fuse (1.6 A for **TSX DST 16 34**, 4 A for **TSX DST 16 32**).

(2) External discharge diode. Caution, it is essential to place a diode across the load terminals to maintain the durability of the contacts.

(3) Capacitive load not allowed.

Discrete I/O modules

General :
pages 42304/2 and 42304/3
References :
pages 42304/10 and 42304/11
Connections :
pages 42304/12 to 42304/15

Characteristics of a.c. inputs

Type of module		TSX DET 8 02	TSX DET 8 03	TSX DET 16 03	
Loads	Voltage	24 V	42/48 V	48 V	
	Current	21.5 mA	18...20.5 mA	22...26 mA	
	Sensor supply	20.4...26.5 V	35.7...53 V	40...53 V	
Input limit values	At state 1	Voltage	> 12 V	> 25 V	> 30 V
		Current	> 7.6 mA	> 8 mA	> 16 mA
	At state 0	Voltage	5 V	11 V	14 V
		Current	3 mA	3 mA	6 mA
	Frequency		47...63 Hz	47...63 Hz	47...63 Hz
Input impedance		1.1...1.25 k	2.1...2.4 k	1.5...3 k	
Response time	Change from state 0 to state 1	11...20 ms	12...21 ms	11...32 ms	
	Change from state 1 to state 0	14...23 ms	12...22 ms	10...22 ms	
Coupling capacitance	Open line	300 nF max	220 nF max	420 nF	
	Open line at ~ 220 V	30 nF max	220 nF max	80 nF	
Dissipated power	Per point at state 1	0.35 W	1 W	0.5 W	
Display lamp	State of each input	Sensor side			
External line	Line resistance	0.. 500			
	Open line leakage resistance	30 k minimum			
Isolation	Between points or group of points	1500 V rms 50-60 Hz			
	Between points and internal bus	1500 V rms 50-60 Hz			
	Type	Opto-coupler			

Type of module		TSX DET 16 04	TSX DET 8 24	TSX DET 8 05	
Nominal input values	Voltage	110/120 V	115 V	220/240 V	
	Current	16...20.5 mA	13.6 mA	14.5...15.8 mA	
	Frequency	50-60 Hz	50-60 Hz	50 Hz	
	Sensor supply	93.5...132 V	93.5...132 V	187...264 V	
Input limit values	At state 1	Voltage	> 74 V	> 75 V	> 154 V
		Current	> 6 mA	> 8 mA	> 9.4 mA
	At state 0	Voltage	20 V	33 V	67 V
		Current	4 mA	3.5 mA	4.9 mA
	Frequency		47...63 Hz	47...63 Hz	47...53 Hz
Input impedance		5.5...7.8 k	8...8.9 k	14.4...16.6 k	
Response time	Change from state 0 to 1	12...23 ms	12...22 ms	12...28.6 ms	
	Change from state 1 to 0	12...22 ms	12...23 ms	12...22 ms	
Coupling capacitance	Open line	100 nF max	100 nF max	80 nF max	
	Open line at ~ 220 V	40 nF max	40 nF max	80 nF max	
Dissipated power	Per point at state 1	0.3 W	1.45 W	0.5 W	
No-load voltage	Of inputs	–	–	7.7...9 V	
Current	Breaking	–	–	< 0.15 mA	
	Short-circuit	–	–	> 6 mA	
Resistance	Internal	–	–	1000	
	In series with conductors	–	–	> 50	
	Shunt on conductors	–	–	> 100 k	
Display lamp	State of each input	Sensor side			
External line	Line resistance	0...500			
	Open line leakage resistance	30 k minimum		60 k minimum	
Isolation	Between points or groups of points	1500 V rms 50-60 Hz			
	Between points and internal bus	1500 V rms 50-60 Hz			
	Type	Opto-coupler			

Discrete I/O modules

General :
pages 42304/2 and 42304/3
References :
pages 42304/10 and 42304/11
Connections :
pages 42304/12 to 42304/15

Characteristics of a.c. outputs

Type of module		TSX DST 8 04	TSX DST 16 04	TSX DST 8 05
Loads	Voltage	110/127 V	110/120 V	110/240 V
	Current	2 A	1 A	2 A
	Frequency	50-60 Hz	50-60 Hz	50-60 Hz
Limit values	Voltage	93.5...140 V	93.5...140 V	93.5...264 V
	Peak switch-on current	15 A (1)	10 A (1)	15 A (1)
	Minimum current	10 mA	25 mA	20 mA
	Total load	16 A	8 A max	16 A
	in the module	40 °C 60 °C (derated)	0.4 A/°C	0.1 A/°C
Response time	Change from state 0 to state 1	< 0.5 ms	0.5 ms	< 1/2 period
	Change from state 1 to state 0	< 1/2 period	< 1/2 period	< 1/2 period
Leakage current	At state 0	4 mA max at 140 V	3 mA max at 140 V	6 mA max at 264 V
Residual voltage	At state 1	I < 35 mA : 1.4 V	I < 50 mA : 3 V	I < 50 mA : 8 V
		I > 35 mA : 11 V	I > 25 mA : 13 V	I > 300 mA : 2 V
Display lamp	State of each output	PLC side		
Built-in protection	Against overloads and short-circuits	3.15 A fuses	–	3.15 A fuses
	Against inductive overvoltages	RC and G MOV	RC and G MOV	RC and G MOV
Triac switch-on	At zero voltage	No	No	Yes
Compatible input modules		TSX DET 8 24/16 04	TSX DET 8 24/16 04	TSX DET 8 05
Loads		Inductive	Inductive	Resistive or inductive
Fault display	On front panel	1 lamp	–	1 lamp
Isolation	Between points or groups of points	1500 V rms 50-60 Hz		
	Between points and internal bus	1500 V rms 50-60 Hz		
	Type	Optotriac	Optotriac	Opto-coupler

Type of module		TSX DST 8 35	TSX DST 16 35	TSX DST 16 33
Loads	Voltage	24...240 V	24...240 V	24...240 V
	Current	U 127 V : 2 A (2) U 240 V : 1 A (2)	U 127 V : 1.1 A (3) U 240 V : 1 A (3)	Resistive : 0.2 A (4) Inductive : 0.2 A (5)
Limit values	Switch on current	10 In for 2 cycles category AC-15	10 In for 2 cycles category AC-15	–
	Total load	8 relay	16 relay	16 relay
	in the module	40 °C 60 °C (derated)	8 relay	8 relay
Response time	Change from state 0 to state 1	3...15 ms	15 ms max	15 ms max
	Change from state 1 to state 0	3...18 ms	20 ms max	20 ms max
Leakage current	At state 0	2.5 mA max	2.5 mA max	0.1 mA max
Display lamp	State of each output	PLC side		
Built-in protection	Against overloads and short-circuits	3.15 A fuses	–	–
	Against inductive overvoltages	RC and G MOV	RC and G MOV	–
Compatible input modules		TSX DET 8 02/8 03/8 05/8 24 and 16 04		TSX DET 8 05
Loads		Resistive or inductive		
Fault display	On front panel	1 lamp	–	–
Isolation	Between points or groups of points	1500 V rms 50-60 Hz		
	Between points and internal bus	1500 V rms 50-60 Hz		
	Type	Relay		

(1) Over 2 cycles once per second

(2) Permissible current for 1×10^6 operations; for 1.5×10^6 operations : U 48 V : 2 A - U 127 V : 1 A - U 240 V : 0.50 A

(3) Permissible current for 0.35×10^6 operations; for 1×10^6 operations : U 127 V : 0.35 A - U 240 V : 0.25 A

(4) Category AC-12 : 0.2 A for 2×10^6 operations; 1 A for 0.4×10^6 operations

(5) Category AC-15 : 0.2 A for 1×10^6 operations; 1 A for 0.3×10^6 operations

Discrete I/O modules

Discrete inputs

General :
pages 42304/2 and 42304/3
Characteristics :
pages 42304/4 to 42304/9
Connections :
pages 42304/12 to 42304/15

References



TSX DET 8 ●●



TSX BLK 1



TSX MNC 16

Discrete inputs

Type of current	Input voltage	Modularity (no. of points)	Compatibility CENELEC 2-wire prox. sens.	Reference	Weight kg
=	24 V	8	Yes	TSX DET 8 12	0.350
		16	Yes	TSX DET 16 12	0.360
		32 fast (1)	Yes (IEC 1131 type 2)	TSX DET 32 32	0.410
		32 (1)	Yes (IEC 1131 type 2)	TSX DET 32 42	0.410
	48 V	32 (1) (3)	No (2)	TSX DET 32 52	0.410
		8	Yes	TSX DET 8 13	0.350
		16	Yes	TSX DET 16 13	0.360
	130 V	16 (4)	Yes	TSX DET 16 33	0.360
		8	Yes	TSX DET 8 14	0.350
	~ 50-60 Hz	24 V	8	No (2)	TSX DET 8 02
42/48 V		8	Yes	TSX DET 8 03	0.360
48 V		16	No (2)	TSX DET 16 03	0.450
110/120 V		16	Yes	TSX DET 16 04	0.440
~ 50 Hz	220/240 V	8	Yes	TSX DET 8 05	0.400
	= or ~	= 110 V ~ 115 V 50/60 Hz	8	Yes	TSX DET 8 24
4			Namur proximity switch and line check	TSX DET 4 66	0.530

Connection terminal blocks

Type of connection	Number of points	Reference	Weight kg
Independent points	4 and 8	TSX BLK 1	0.350
Two wires per point	4 and 8	TSX BLK 2	0.350
External commons	4, 8 and 16	TSX BLK 1	0.350
	8 (5)	TSX BLK 3	0.200
	32 inputs	TSX BLK 7	0.200

Simulation blocks

Use	Number of points	Reference	Weight kg
For discrete inputs	4 and 8	TSX MNC 15	0.400
	16	TSX MNC 16	0.450

(1) When a direct extension assembly is connected to a local or remote extension rack, or a TSX 47-10/20/25 base configuration, placing a 24 or 32-point module in slot n of the local or remote extension rack prohibits the use of the corresponding slot n in the TSX RKE● direct extension assembly.

(2) Telemecanique compatibility :

- TSX DET 8 02 : 2-wire proximity sensor d.c. non-polarised
- TSX DET 16 03 : 2-wire proximity sensor a.c.
- TSX DET 32 52 : 2-wire proximity sensor d.c.

(3) Inputs not isolated.

(4) TSX DET 16 33 : do not use with volt-free contacts (response time 0.5 to 2 ms).

(5) The TSX BLK 3 terminal block reduces external wiring of the commons.

Discrete I/O modules

General :
pages 42304/2 and 42304/3
Characteristics :
pages 42304/4 to 42304/9
Connections :
pages 42304/12 to 42304/15

Discrete outputs

References



TSX DST 16 ●●



TSX DST 32 92



TSX BLK 1



TSX BLK 9

Discrete outputs

Type of current	Output voltage	Modularity (no. of points)	Characteristics of points	Reference	Weight kg
= transistor	5/12/24 V	16	0.4 A - 24 V non-protected negative logic	TSX DST 16 12	0.580
	24 V	8	2 A protected	TSX DST 8 82	0.700
		16	0.5 A protected	TSX DST 16 82	0.680
		24 (1)	0.5 A protected	TSX DST 24 72	0.410
	24/48 V	32 (1)	0.1 A non-protected	TSX DST 32 92	0.420
4		2 A protected	TSX DST 4 17	0.620	
		8	0.5 A protected	TSX DST 8 17	0.600
= relay	48/130 V	16 relay 1 "N/O"	Non-protected 50 W resistive 25 W inductive	TSX DST 16 34	0.660
	24 V	16 relay 1 "N/O"	Non-protected 2 A resistive 1 A inductive	TSX DST 16 32	0.660
~ transistor 50/60 Hz	110/127 V	8	2 A protected	TSX DST 8 04	0.660
	110/120 V	16	1 A non-protected	TSX DST 16 04	0.660
	110/240 V	8	2 A protected	TSX DST 8 05	0.660
~ relay	~ 24/240 V and = 24 V	4 relay 1 "N/O"	Protected	TSX DST 8 35	0.350
		4 relay 1 "C/O"			
	24/240 V	16 relay 1 "N/O"	Non-protected	TSX DST 16 35	0.370
			Non-protected (2)	TSX DST 16 33	0.360

Connection terminal blocks

Type of connection	Number of points	Reference	Weight kg
Independent points	4 and 8 (3)	TSX BLK 1	0.350
Two wires per point	4 and 8	TSX BLK 2	0.350
External commons	4, 8 and 16	TSX BLK 1	0.350
	8 (4)	TSX BLK 3	0.200
	24 outputs	TSX BLK 8	0.200
	32 outputs	TSX BLK 9	0.200

(1) When a direct extension assembly is connected to a local or remote extension rack, or a TSX 47-10/20/25 base rack, placing a 24 or 32-point module in slot n of the rack prohibits the use of the corresponding slot n in the TSX RKE● direct extension rack.

(2) Low leakage current module, this requires a protection device (RC or peak limiter) to be placed across the terminals of each load.

(3) TSX DST 8 17/8 82 modules cannot be used as independent points.

(4) The TSX BLK 3 terminal block reduces external wiring of the commons.

Discrete I/O modules

General :
 Pages 42304/2 and 42304/3
 Characteristics :
 Pages 42304/4 to 42304/9
 References :
 Pages 42304/10 and 42304/11

Connections

Connections for 4-point modules

Grouped points
TSX DET 4 66 (1)

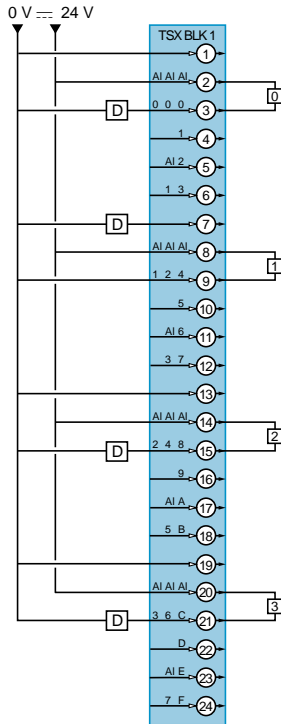

2 wires per point
TSX DET 4 66

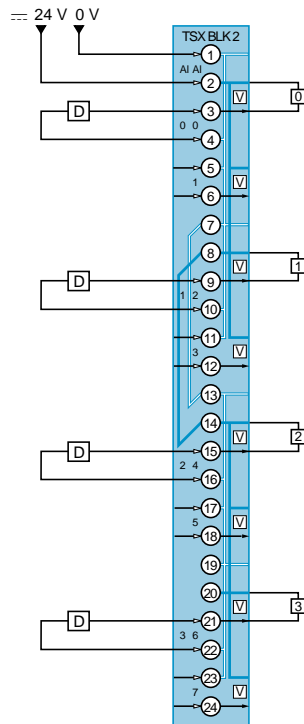

Grouped points
TSX DST 4 17 (1)

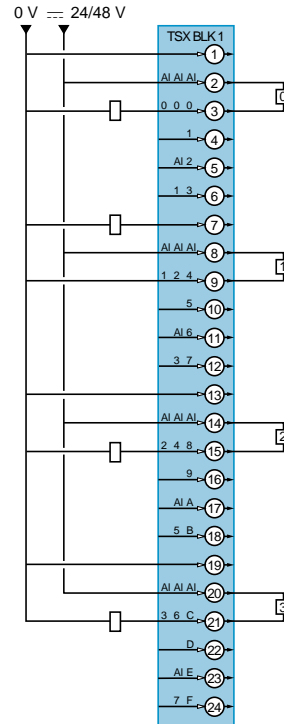

2 wires per point
TSX DST 4 17

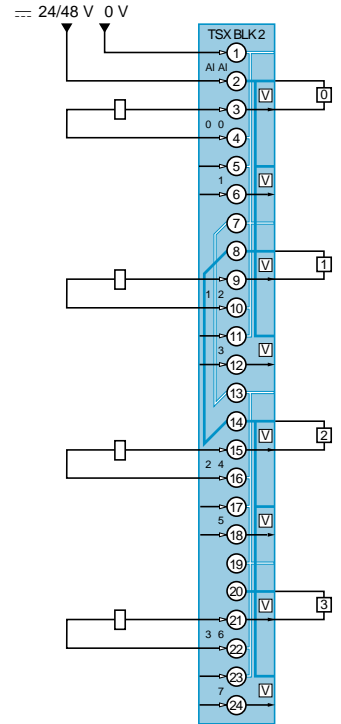

(1) The TSX BLK 1 terminal block enables points to be connected independently.

Connections for 8-point input modules

d.c. and a.c. inputs

Independent points
TSX DET 8 12/8 13/8 14
TSX DET 8 02
TSX DET 8 03/8 05
TSX DET 8 24

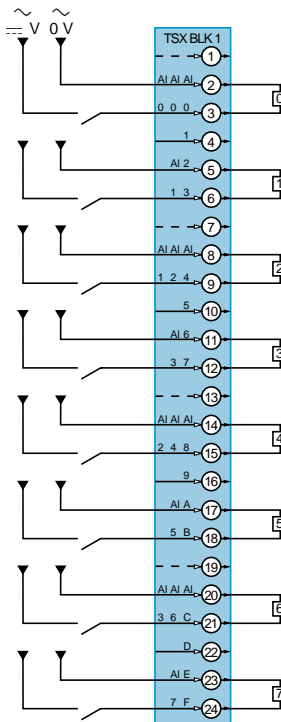

Grouped points
TSX DET 8 12/8 13/8 14
TSX DET 8 02
TSX DET 8 03/8 05
TSX DET 8 24

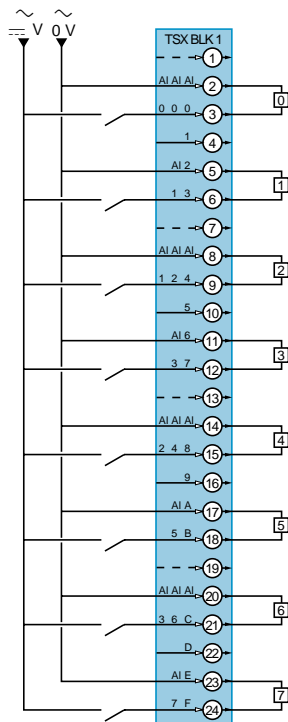

Commons in terminal block
TSX DET 8 12/8 13/8 14
TSX DET 8 02
TSX DET 8 03/8 05
TSX DET 8 24

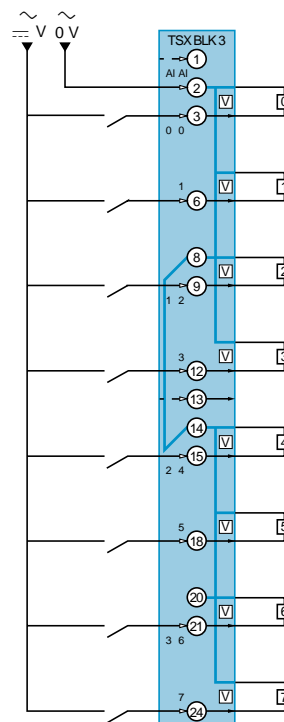

2 wires per point
TSX DET 8 12/8 13/8 14
TSX DET 8 02
TSX DET 8 03/8 05
TSX DET 8 24

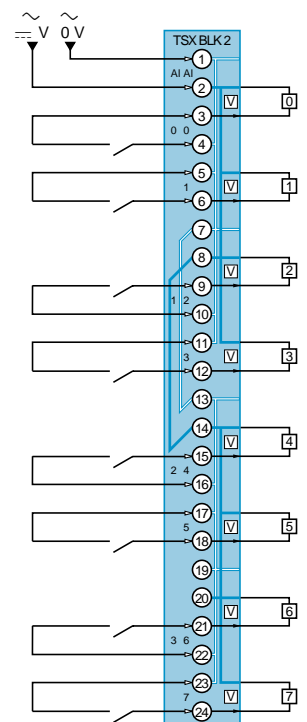

Discrete I/O modules

General :
 Pages 42304/2 and 42304/3
 Characteristics :
 Pages 42304/4 to 42304/9
 References :
 Pages 42304/10 and 42304/11

Connections

Connections for 8-point output modules

a.c. relay outputs

External commons

TSX DST 8 04/8 05 (1)

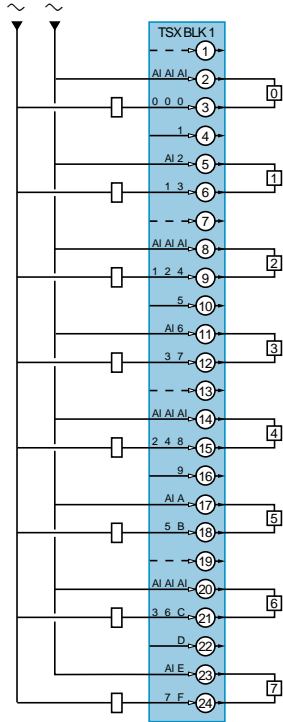

Independent points - Relay outputs

TSX DST 8 35 (2)

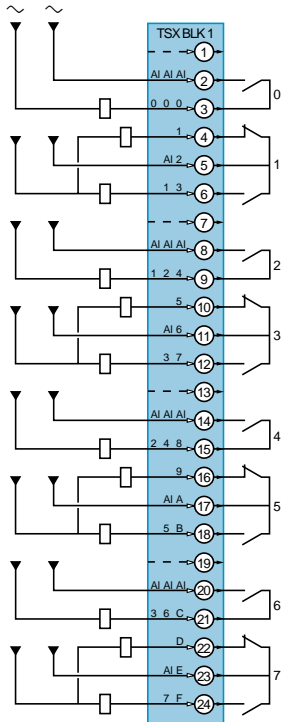

2 wires per point
 TSX DST 8 04/8 05
 TSX DST 8 35

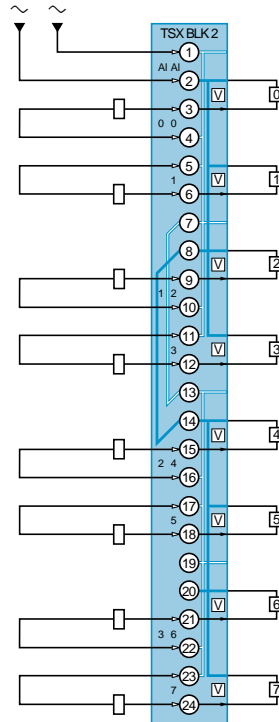

Commons in terminal block
 TSX DST 8 04/8 05
 TSX DST 8 35

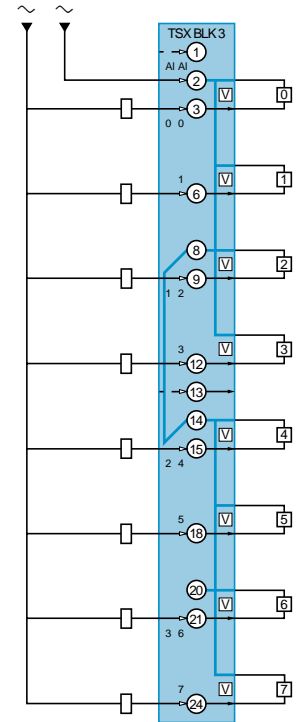

- (1) The TSX BLK 1 terminal block enables points to be connected independently.
- (2) Use "N/C" contacts.

Connections for 8-point output modules

d.c. outputs

External commons

TSX DST 8 17 (1)

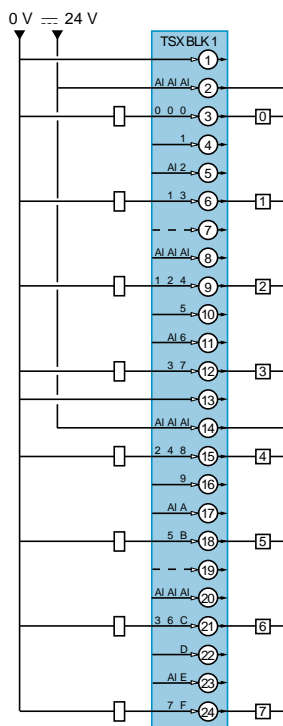

TSX DST 8 82

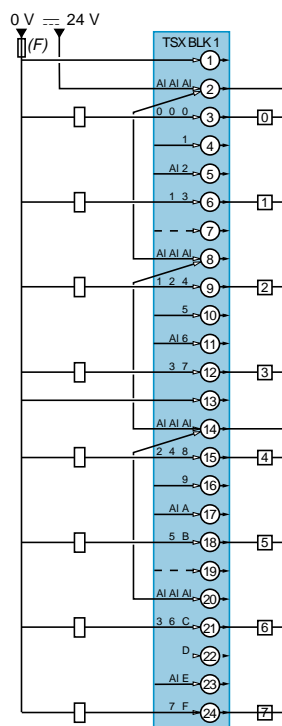

2 wires per point
 TSX DST 8 17

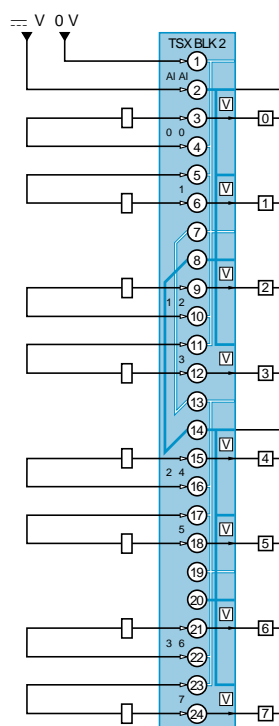

Commons in terminal block
 TSX DST 8 17

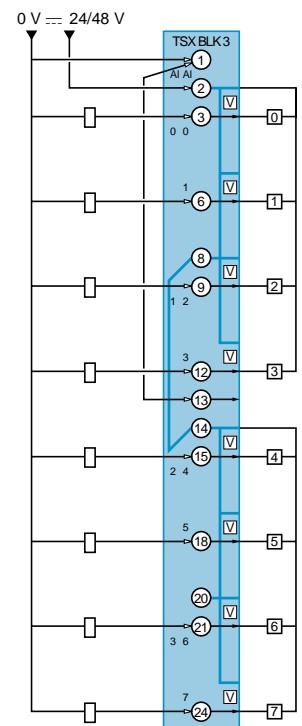

- (1) The TSX BLK 1 terminal block enables points to be connected independently.

Discrete I/O modules

General :
 Pages 42304/2 and 42304/3
 Characteristics :
 Pages 42304/4 to 42304/9
 References :
 Pages 42304/10 and 42304/11

Connections (continued)

Connections for 16-point modules

d.c. and a.c. inputs

TSX DET 16 12
TSX DET 16 13/16 33
TSX DET 16 03/16 04

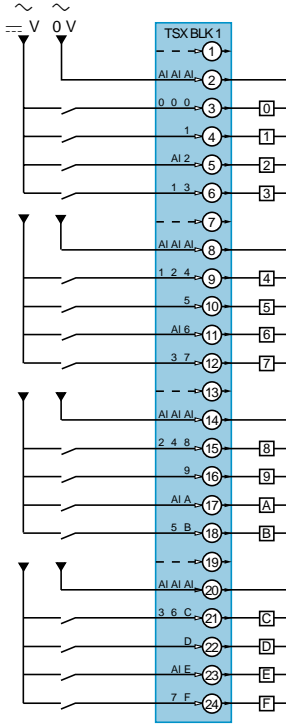

Negative logic d.c. outputs
TSX DST 16 12

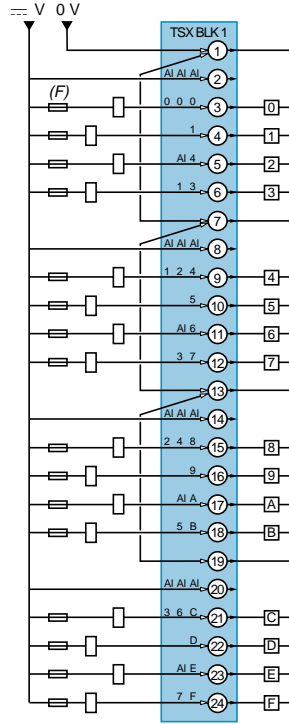

Positive logic d.c. outputs
TSX DST 16 82

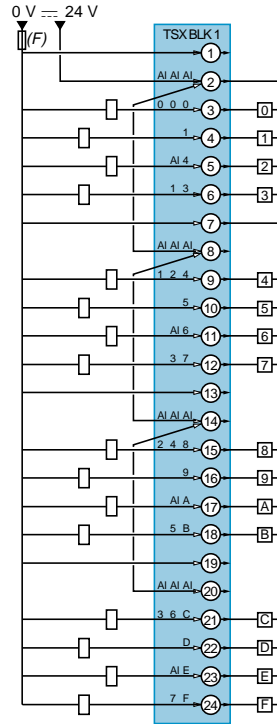

Relay and a.c. outputs
TSX DST 16 35
TSX DST 16 04

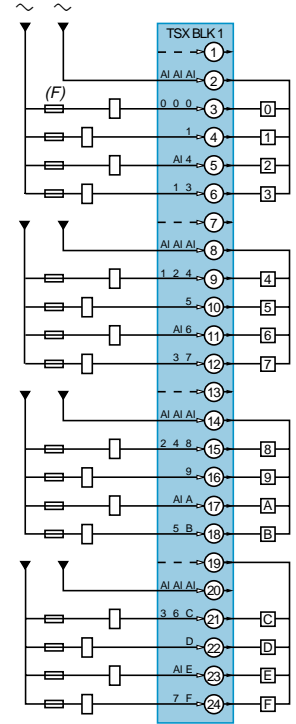

d.c. inputs
 Resistive loads
TSX DST 16 34

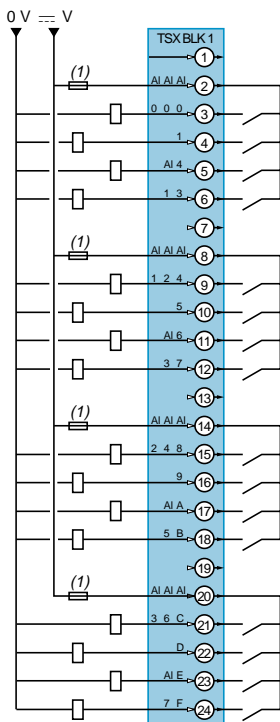

Inductive loads
TSX DST 16 34

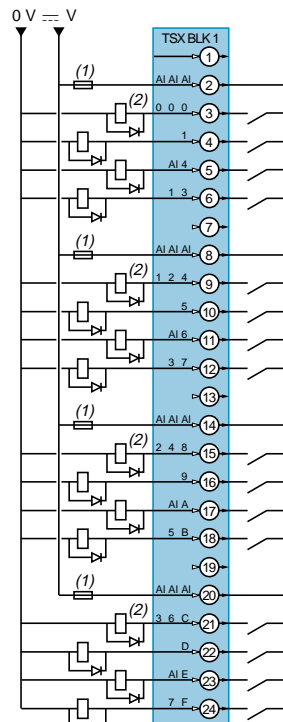

Resistive or inductive loads
TSX DST 16 32

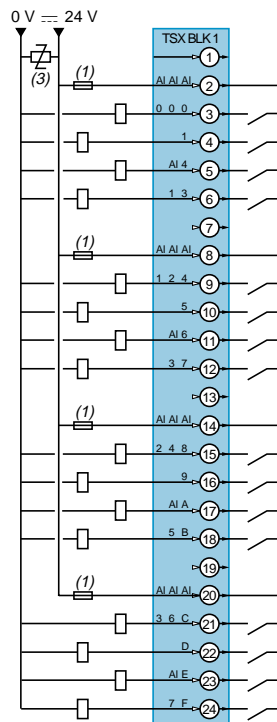

TSX DST 16 33

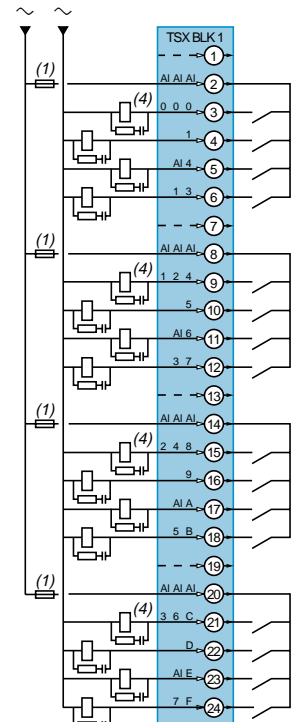

- (1) External semi-time-delayed fuse (1.6 A for TSX DST 16 34, 4 A for TSX DST 16 32).
- (2) External discharge diode. Caution, it is essential to place a diode across the terminals to maintain the durability of the contacts.
- (3) Peak limiter supplied with module TSX DST 16 32.
- (4) Protection device (RC or peak limiter not supplied) essential with inductive loads. Not required with resistive loads.

Discrete I/O modules

General :
 Pages 42304/2 and 42304/3
 Characteristics :
 Pages 42304/4 to 42304/9
 References :
 Pages 42304/10 and 42304/11

Connections

Connections for 24 and 32-point modules

d.c. inputs

TSX DET 32 32/32 42/32 52

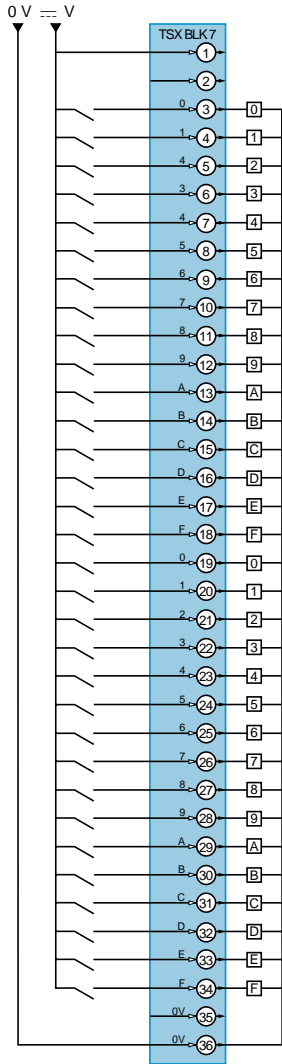

d.c. outputs

TSX DST 24 72

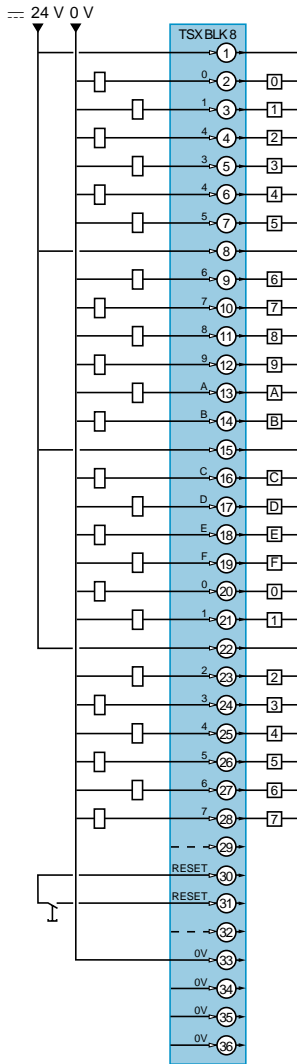

TSX DST 32 92

