

be in motion be in motion

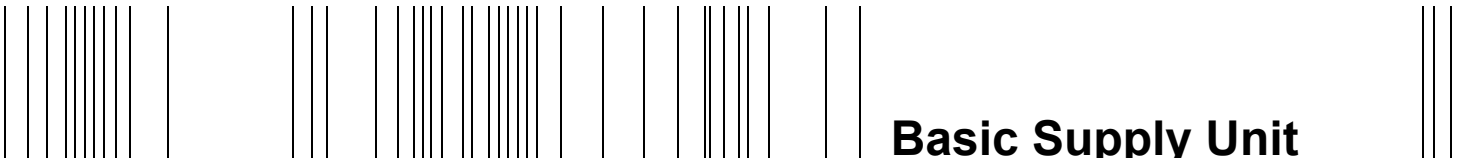

POWER CONVERSION EQUIPMENT



LISTED
38WA



Basic Supply Unit

BUG 622, 623

Manual

E

5.94034.07a



BAUMÜLLER

Titel	Manual
Product	Basic Supply Unit BUG 622, 623
Version	5.94034.07a
Copyright	<p>These operating instructions may be copied by the owner in any quantity but only for internal use. For other purposes these operating instructions and extracts thereof must not be copied or reproduced.</p> <p>Use and disclosure of information contained in these operating instructions are not permitted.</p> <p>Designations and company marks contained in these operating instructions may be brand names, the use of which by third parties for their own purposes may violate the rights of the holders.</p>
Obligatory	<p>These operating instructions are part of the equipment/machine. These operating instructions must be available to the operator at all times and must be in a legible condition. If the equipment/machine is sold or moved to a different location these operating instructions must be passed on by the owner together with the equipment/machine.</p> <p>After any sale of the equipment/machine this original and all copies must be handed over to the buyer. After disposal or any other end of use this original and all copies must be destroyed.</p> <p>When the present operating instructions are handed over, corresponding sets of operating instructions of a previous version are automatically invalidated. Please notice that specifications/data/information are current values according to the printing date. These statements are not legally binding according to the measurement, computation and calculations.</p> <p>Baumüller Nürnberg GmbH reserves the right, in developing its products further, to change the technical specifications and the handling of the products concerned without prior notice.</p> <p>No liability can be accepted concerning the correctness of the operating instructions unless otherwise specified in the General Conditions of Sale and Delivery.</p>
Manufacturer	<p>Baumüller Nürnberg GmbH Ostendstr. 80 - 90 D-90482 Nürnberg Germany Tel. +49 9 11 54 32 - 0 Fax: +49 9 11 54 32 - 1 30 www.baumueller.de</p>

TABLE OF CONTENTS

1 Safety Notes 5

2 Technical data 9

 2.1 General 9

 2.1.1 Function description 10

 2.1.2 Block diagram 11

 2.2 Electrical Data 12

 2.3 Type code 15

3 Transport, Removal of Packaging 17

4 Assembly 19

 4.1 Dimensions 20

 4.2 Assembly notes 21

 4.3 Attachment 22

5 Installation 23

 5.1 Hazard notes 23

 5.2 Applicable standards 24

 5.3 EMC notes 26

 5.4 Terminal diagram 34

 5.5 Connector pin assignment 37

 5.5.1 Power terminals 37

 5.5.2 Control terminals 39

 5.6 Accessories 40

6 Commissioning 41

 6.1 Danger information 41

 6.2 Operation 43

 6.3 Mains failure 43

 6.4 Messages and warnings 44

 6.5 Flow chart 46

7 Maintenance 47

 7.1 Maintenance information 47

 7.2 Environmental conditions 48

 7.3 Recommissioning 48

 7.4 Disposal 49

8 Appendix 51

 8.1 Manufacturer’s declaration 51

 8.2 Declaration of Conformity 52

 8.3 General Conditions of Sale and Delivery 53

 8.4 Index 56

ABBREVIATIONS

AC	Alternating current
AM	Asynchronous motor
a.m.s.l.	above mean sea level
BBint	ready (internal)
BBext	ready (external)
BUC	Baumüller Feed/Feed back Unit
BUG	Baumüller Basic supply Unit
BUM	Baumüller Mono Power Unit
BUS	Baumüller Power Module
DC	Direct current
DIN	Deutsches Institut für Normung e.V. (German Standardisation Authority)
EMC	Electromagnetic compatibility
EN	European Standard
FI	Residual current
HS	Main conductor
PE	Protective earth
PELV	Protective extra-low voltage
SELV	Safe extra-low voltage
SM	Synchronous motor
VBG	Verwaltungs-Berufsgenossenschaft (German professional trade association)
VDE	Verband deutscher Elektrotechniker (German Association of electrician)
ZK	DC link

1 Safety Notes

Foreword

Relatively high leakage to earth occurs in the converter and the motor, i.e. the drive may be incompatible with residual current protective devices. During operation, the principles on which the converter and motor work, lead to leakage currents to earth which are dissipated via specified protective earth connections and which may result in a current-operated e.l.c.b. on the input side blowing prematurely.

A DC component in the fault current may occur in the event of a short-circuit to frame or earth fault which makes a triggering of the higher-level current-operated e.l.c.b. more difficult or even impossible.

The connection of the current controller to the mains using only the current-operated e.l.c.b. is prohibited (EN 50178 / VDE 0160 /11.94, sections 5.2.11 and 5.3.2.1)

The units are protected against direct contact by being installed into common switching cabinets which meet the minimum protection requirements according to EN 50178 / VDE 0160 / 4.98, section 5.2.4.

Sheets of plastic covering the control electronics, the power stage and the device connection, additionally prevent accidental contact during commissioning and casual use of control elements located close to the equipment (DIN VDE 0106 Part 100, Accident Prevention Regulation VBG4 "Electrical Systems and Equipment).

The protective measures and safety regulations according to DIN/VDE are binding for personal security.

Neglecting to fit PE connections on the equipment or the motor will result in serious personal injury and/or considerable damage to material assets.

It is only permitted to use the devices on earth-protected supply mains.

The discharge time of live parts is > 1 min. and depends on the connected DC link capacity.

This devices are not short-circuit-proof.

General Notes

This manual contains the necessary information for normal operation of the products described therein. It is intended for technically-qualified personnel who are specially trained and are familiar in detail with all warnings and maintenance tasks.

The units are finished to the highest standard and are safe and reliable. They can be installed and operated safely, and function without problem if the following cautionary notes in this manual are observed.



DANGER

Due to the nature of electrical equipment, certain parts of this unit carry dangerous voltage during operation.

Serious injury and/or damage to property can result from non-compliance with these safety notes and warnings.

Only qualified personnel familiar with the safety instructions, and instructions regarding assembly, maintenance and operation are to work on this unit.

Safety Notes

Hazard notes

The following notes are for your personal safety on the one hand, and on the other, the protection of the described product or connected equipment from damage.

The terms used have the following definitions both within the scope of this handbook and in the notes on the product itself:



DANGER

This means that **death, serious injury or considerable material damage will** occur if the safety precautions are not met.



WARNING

This means that **death, serious injury or considerable material damage may** occur if the safety precautions are not met.

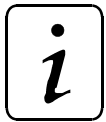

NOTE

This points to **important information** on the product, the manipulation of the product, or a particular part of the documentation.

Qualified Personnel

Qualified personnel, in the sense of the safety notes in this manual or on the products themselves, are persons who are familiar with the installation, assembly, commissioning and operation of the product and are correspondingly qualified, i.e.

- are trained or authorised to commission, earth and designate electrical circuits and appliances according to the required safety standards.
- are trained or authorised in the care and operation of applicable safety equipment according to the required safety standards.

Normal use



WARNING

The unit/system may only be used as specified in the system handbook, and only with other units and components recommended or approved by BAUMÜLLER NÜRNBERG GmbH.

Unauthorised conversion of the unit/system is not permitted for safety reasons.

The user is obliged to report any changes which may affect the safety of the unit/system immediately.

Voltage test

BAUMÜLLER carries out a voltage test according to EN 50178 / VDE 0160 /4.98, Section 9.4.5 for each unit.

Subsequent high-voltage tests must only be carried out by BAUMÜLLER NÜRNBERG GmbH.



WARNING

If you want to carry out high-voltage tests for complete switch cabinet installations, disconnect all cables from BAUMÜLLER units prior to the test.

2 TECHNICAL DATA

2.1 General

The basic units BUG 622 and BUG 623 are basic supply units for the DC link supply of the power modules BUS 62x.

For control tasks controller modules for Baumüller power units are available. Thus the units can adapted to a wide variety of requirements.

There are two types of controller.

The BUS 6 V controller for highly demanding control tasks

BUS 6 M controller for highly demanding multi axis tasks

With the digital drive controllers of the BUS 6 series, both asynchronous and synchronous motors with different encoder systems can be driven by the same unit.

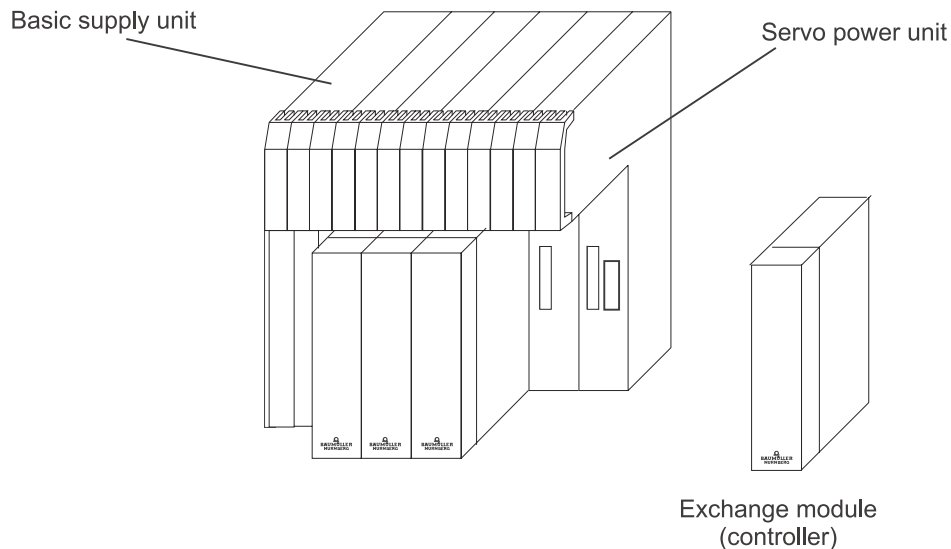

The basic supply units are divided into two classes, 18 kW and 36 kW.

The basic supply units without return feed are designed for wide range voltage connection between 400 - 460 V (for units of development stages 000, 001, 100, 110) or 400 - 480 V (for all other development stages) $\pm 10\%$, 50/60 Hz. Starting current load relief and DC link reactor are integrated into the unit.

The basic supply units may contain a ballast circuitry to convert the drives brake energy. There are units available in version E for connection of a external resistance (see type code).

An external extra low voltage 24 V_{DC} (SELV / PELV) is necessary for operating.

2.1.1 Function description

- Input rectifier

The input rectifier is a non-controlled rectifier. To mains with a nominal voltage from 400 V to 460 V (for units of development stages 000, 001, 100, 110) or 400 - 480 V (for all other development stages) the unit can be connected without transformer and series reactor.

- Starting current load relief

If precautions are not taken, the DC link capacitors produce inadmissibly-large charging current surges from the mains. In order to avoid these surges, the starting current is restricted by a load relief device.

To this purpose, a resistance is integrated into the DC link which restricts the charging current to a maximum of 100 A (with the exception of temporary mains failure), and is bypassed once the DC link is charged.

The cycle time for connect the unit in circuit again is 10 min.

2.1.2 Block diagram

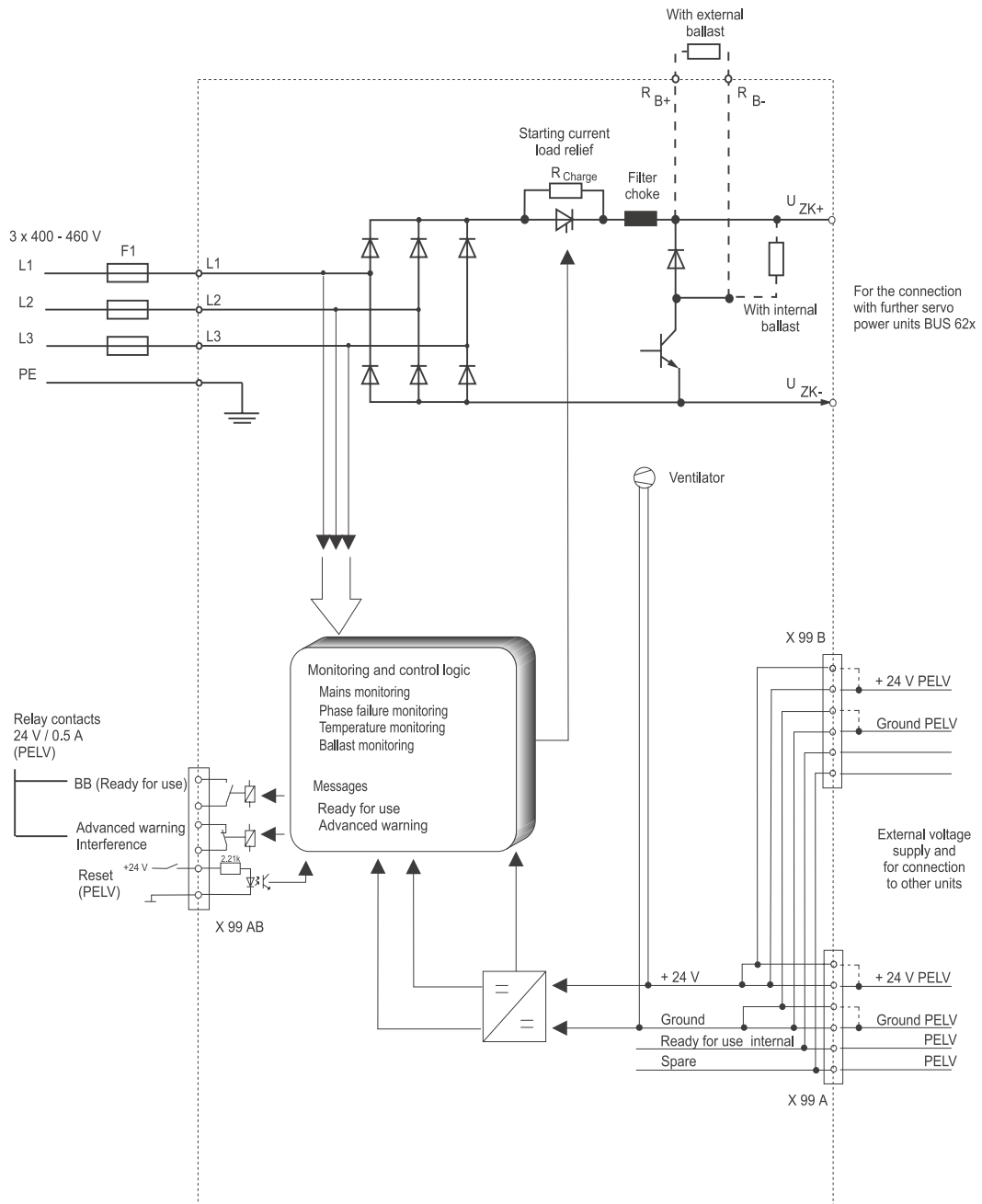

2.2 Electrical Data

Basic supply unit	BUG 622	BUG 623
Connection voltage (Line) ¹⁾	min. 3 x 400 V _{AC} ± 10 % 50 Hz max. 3 x 460 V _{AC} +10 % 50/60 Hz (for units of development stages 000, 001, 100, 110, see type code) or max. 3 x 480 V _{AC} +10 % 50/60 Hz (for all other development stages)	
Nominal input current ²⁾	28 A	56 A
Semi-conductor fuse (external) ³⁾	80 A	100 A
Nominal power ²⁾	18 kW	36 kW
Maximum power for 1 s (S6 40 %)	27 kW	54 kW
Nominal DC link voltage ²⁾	540 V DC	
Total connectable capacitors in the DC link (incl. supply unit)	2200 µF	2200 µF
Capacitor in the DC link	500 µF	750 µF
Switch on: Ready for use after	≤ 1,5 s	≤ 1,5 s
cycle time for connect the unit in circuit again	10 min	
Low voltage supply ⁴⁾	+ 24 V _{DC} – 10 % +20 %	
Power absorption (monitoring functions)	9 W	12 W
Ballast resistance R _B peak power output for t < 1.2 s internal external (model external ballast) ⁵⁾	18 kW 26 Ω / 300 W > 16 Ω / power according requirements until nominal power	36 kW 16 Ω / 450 W > 16 Ω / power according requirements until nominal power
Ballast application at	750 V	750 V
Power loss in nominal use without ballast	200 W	410 W
Operational environment temperature range T _B	0 ... 40 °C (with power reduction 55 °C)	
Power reduction	3 % / °C	
Installation height ⁶⁾	1000 m above sea level	
Relative air humidity	15 % ... 85 % no dew	
Storage temperature range	-30 °C ... +70 °C	
Short circuit proof	not short circuit proof	
Protection	IP 20	
Dimensions (BxHxD)	99 x 360 x 280 mm	132 x 360 x 280 mm
Weight	12 kg	16 kg

1. Voltage difference between phases must no exceed +/- 1 %.

2. Mains supply voltage $\neq 400 \text{ V}_{AC}$, see characteristic curve 1, 2, 3 and 4

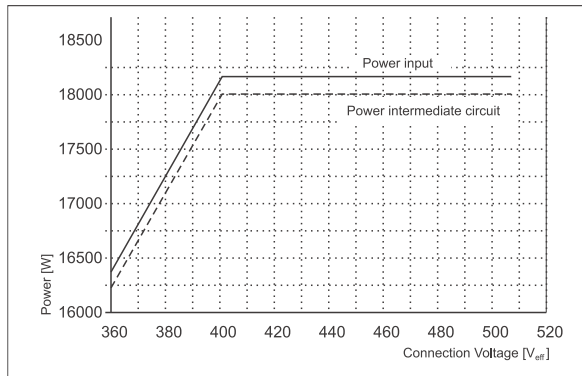

Characteristic curve 1: Load curve BUG 622 at $T_K = 25 \text{ }^\circ\text{C}$

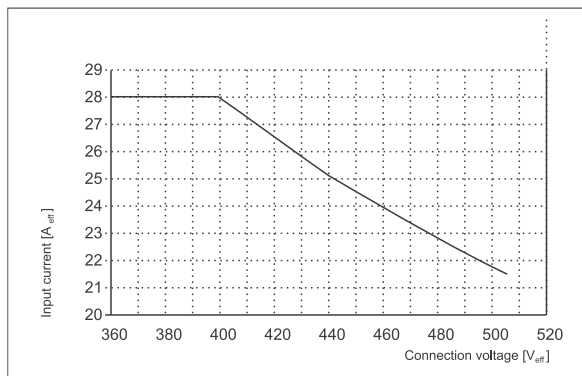

Characteristic curve 2: Power-/Voltage curve BUG 622 at $T_K = 25 \text{ }^\circ\text{C}$

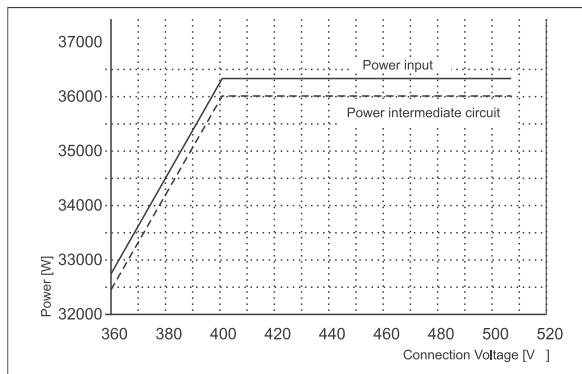

Characteristic curve 3: Load curve BUG 623 at $T_K = 25 \text{ }^\circ\text{C}$

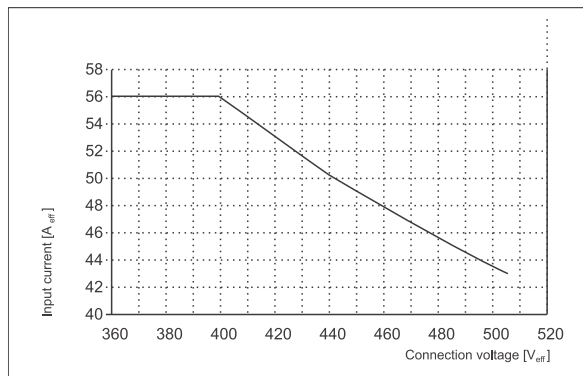

Characteristic curve 4: Power-/Voltage curve BUG 623 at $T_K = 25\text{ °C}$

3. see Accessories on page 40
4. According to EN 61131-2, Table 5. With a supply voltage $< 24\text{ V}$ the fan power is reduced. Therefore, it may be necessary to reduce the output current as well.
- 5.



WARNING

The minimal resistance must not fall below $16\ \Omega$, otherwise the units could be damaged.
The power of the external ballast resistances is to be dimensioned on the machine.

6. Installation height $> 1000\text{ m}$ see characteristic curve 6.

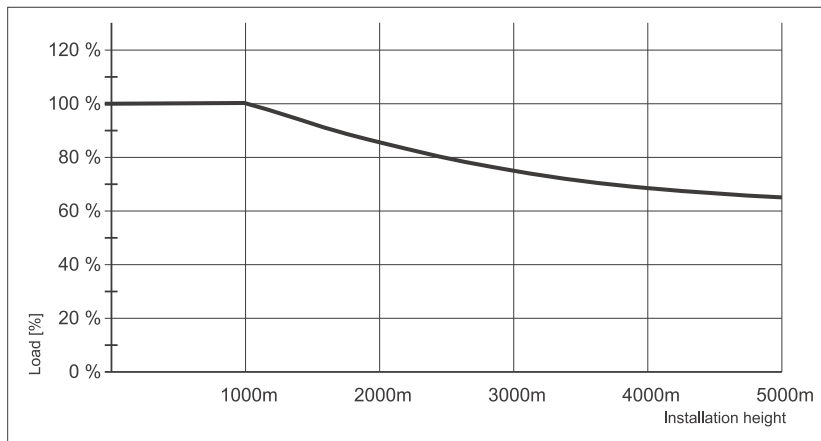

Characteristic curve 6: Load Values in relation to the installation height

2.3 Type code

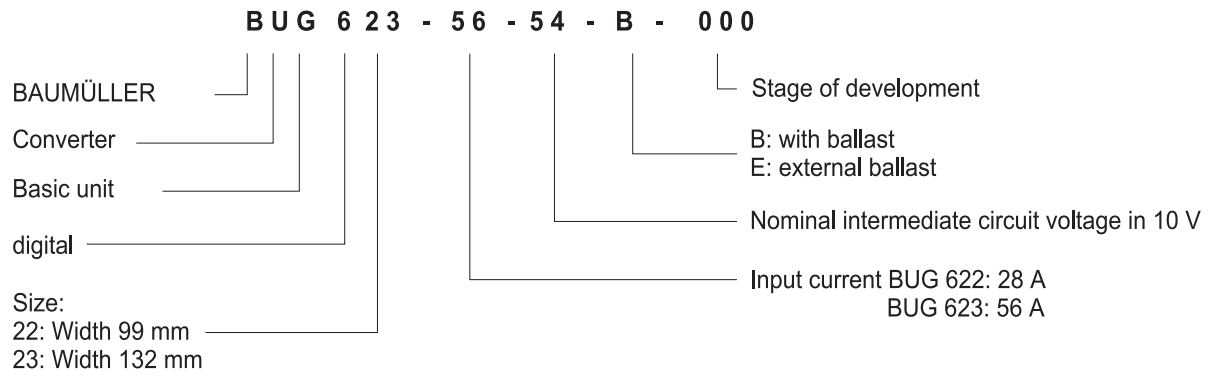

3 TRANSPORT, REMOVAL OF PACKAGING

The units are packed at the factory in accordance with the order.

Avoid strong shaking during transportation and shocks, e.g. when setting the units down.

After unpacking the units and checking that the shipment is complete and undamaged, you can start assembly.

The packing consists of fibreboard, corrugated cardboard and/or wood. It can be disposed according to the local regulations.

Report any transport damage without delay.



DANGER

If you detect a transport damage on the unit, it must not be connected unless an appropriate voltage test has been carried out.

Ignoring this information can result in death, severe personal injury or considerable damage to material assets.

4 ASSEMBLY



WARNING

The user is responsible for the assembly of the converter power unit, the motor, and the other components according to applicable safety standards (e.g. DIN, VDE) and all other relevant national or local regulations regarding conductor dimensions and fusing, grounding, circuit breakers, overcurrent protection etc.

A space must be left above and below the units, and sufficient cool air and air circulation is to be provided, otherwise, the unit may be overheated

The units are protected against direct contact by being installed into common switching cabinets which meet the minimum protection requirements according to EN 50178 / VDE 0160 / 4.98, section 5.2.4.

Sheets of plastic covering the control electronics, the power stage and the device connection, additionally prevent accidental contact during commissioning and casual use of control elements located close to the equipment. (DIN VDE 0106 Part 100, Accident Prevention Regulation VBG4 "Electrical Systems and Equipment).

Pollution degree 3 and 4 according to EN 50178/VDE0160/4.98 Section. 5.2.15.2 must be avoided. The units are suitable for the installation in closed operating rooms (VDE 0558 Part 1a, Section 5.4.3.2.1 and 5.4.3.2.2).

4.1 Dimensions

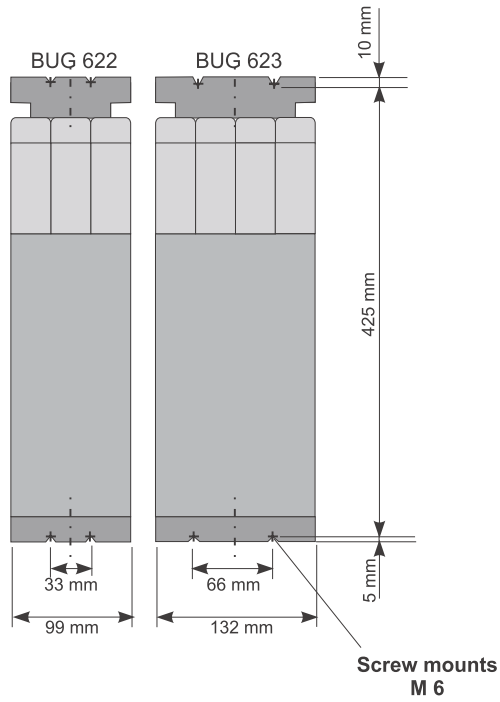

Mounting attached individually as a separate part.

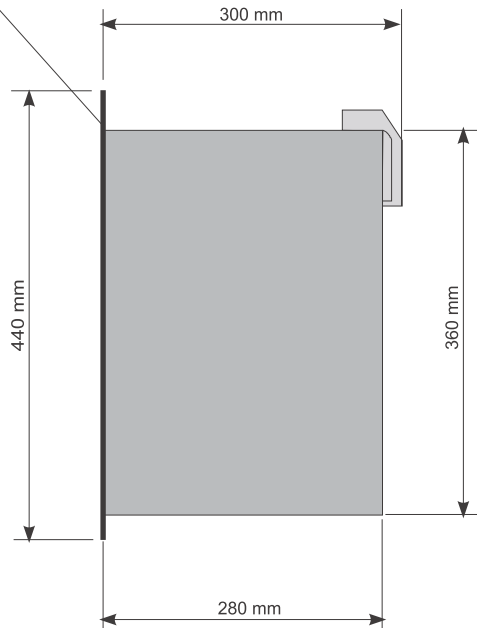

4.2 Assembly notes



WARNING

Inappropriate lifting can cause personal injury or damage to material assets. Qualified personnel only may lift the unit using suitable equipment.

- The units must be installed in the switch cabinet vertically. The power modules BUS 62x must be arranged near to the basic supply unit and the DC link must be connected by the connection rails supplied with the unit. When delivered, the connection bars are fastened to the front bars of the units BUS 62x.



DANGER

Longer connections as by the connection bars supplied with the unit are not permitted, as they may cause damage to the equipment.

The discharge time of live parts is > 1 min



WARNING

The following measures must be strictly observed to avoid the danger of device overheating.

- Ventilation must be in the direction from bottom to top.
- Unrestricted ventilation must be guaranteed.
- A space of at least 100 mm must be left above and below the units, and sufficient cool air and air circulation is to be provided.
- Coolant temperature 50 mm under the units, up to 40 °C. With higher temperatures (up to max. 55 °C), power output of the units must be reduced by 3% per °C.
- Do not locate any additional sources of heat above or below the units.

4.3 Attachment

1. Attach the mounting plate to the control cabinet (for sizes, see "Dimensions").

The mounting plate can be used as a mounting and drilling template. The mounting plate of neighboring units must be placed directly next to one another.

2. Push back the plate spring and hang the unit in place.
The unit is then held fast between the mounting backplate and the back wall.
3. To dismount the unit, press the plate spring in direction back wall and lift out upwards.

5 INSTALLATION

5.1 Hazard notes



WARNING

This unit carries dangerous voltage and contains dangerous rotating machine parts (ventilators). This means that death, serious injury or considerable material damage can occur if the safety and warning notes are not heeded.

The user is responsible for the assembly of the converter power unit, the motor, the mains filter and the other components according to applicable safety standards (e.g. EN, DIN) and all other relevant national or local regulations regarding conductor dimensions and fusing, grounding, circuit breakers, overcurrent protection etc.

Relatively high leakage to ground occurs in the converter and the motor, i.e. the drive may be incompatible with residual current protective devices (EN 50178:1998 section 5.2.11.2).

Variable-speed drives may only be used if their use conforms to valid EN regulations.



DANGER

The DC link carries electrical potential: it is imperative that the provided cover is used.

Special care is needed when touching the drive shaft, directly or indirectly (by hand). This should only be done in a voltage free state and whilst the drive is stationary.

Safety equipment must under no circumstances be shut down.

5.2 Applicable standards

The power units of the series BUG 62x are built-in devices according to EN 50178 / VDE 0160 / 4.98, Section 5.2.6 and DIN VDE 0558 Part 1/07.87, Section 5.4.3.2.1. If the units are to be installed in closed electrical premises that meet the safety demands of EN 50178/VDE 0160/4.98, Section 5.2.4 (IP 2X, resp. even IP4X according to EN 60529/ 5.1).

Sheets of plastic covering the power connections, additionally prevent accidental contact during commissioning and casual use of control elements located close to the equipment (DIN VDE 0106 part 100, Accident Prevention Regulation VBG4 "Electrical Systems and Equipment).

If the units are to be installed in closed electrical premises according to EN 50178/VDE 0160/4.98, Section 5.2.7 and DIN VDE 0558 Part 1/07.87, Section 5.4.3.2.2, the user must ensure by additional measures that the requirements according to EN 50178/VDE 0160/4.98, Section 5.2.4 are met.

The power unit is provided for the fixed mains connection to TN and TT mains according to DIN VDE 0100, Part 410/11.83 with a linked mains voltage of up to $3 \times 500 V_{\text{eff}}$ ("and not more than 5000 rms symmetrical amperes", if UL508C has to be observed (Nov 27, 1996, Tab. 44.1)).

The power unit can be connected to IT mains under certain circumstances. Baumüller will provide the appropriate information on request.

During operation, the principles on which the converter and motor work, lead to leakage currents to earth which are dissipated via specified protective earth connections and which may result in a current-operated e.l.c.b. on the input side blowing prematurely. A DC component in the fault current may occur in the event of a short-circuit to frame or earth fault which makes a triggering of the higher-level current-operated e.l.c.b. more difficult or even impossible. The connection of the converter to the mains using only the current-operated e.l.c.b. is prohibited (standard EN 50178 / VDE 0160 /4.98, sections 5.2.11 and 5.3.2.1).

Concerning climatic conditions, the units of the climatic category 3K3 for sheltered locations acc. to EN 50178/VDE 0160/4.98, Section 6.1, Table 7, Line 3 or acc. to Table 1 of EN 60721-3-1,2,3,4 under consideration of Note 1 and 3 of EN 50178/ VDE 0160/4.98, Section 6.1. The actual operating temperature range is between 0 to +55 °C. For storage and transport, the specifications of Table 7 (lines 5 and 6) of EN 50178/VDE 0160/4.98, Section 6.1 apply.

Unlike these specifications, the storage and transport temperature of the units may adopt values between -30 and +70 °C (see technical data).

The type of protection of the units is IP 20 acc. to EN 60529 (DIN VDE 0470-1).

The power units are equipment of protection class I according to IEC 536/3 and DIN VDE 0106 Part 1 (EN 50178/VDE 0160/4.98, Section 5.2.9).

Equipment of protection class I is equipment, in which the protection against shock currents does not only consist of the basic insulation and which includes an additional safety measure. This additional protection is ensured by the connection and other parts to the PE so that no voltage is applied if the basic insulation should fail. The entire insulation of these inverters acc. to EN 50178 / VDE 0160/4.98, Section 5.2.9.1 complies at least to a basic insulation. This also applies to the insulation between the individual circuits.

The control connections of the power units are safely separated from the mains and are designed for the connection of PELV/SELV circuits.

The following criteria were considered for the dimensioning of the air and creepage distances:

- Pollution degree 2 acc. to EN 50178/VDE0160/4.98, Section 5.2.15.2, Table 2, line 3
Normally, only non-conductive pollution occurs. If the units are not in operation, a casual, short-term conductivity caused by condensation is possible.
- Overvoltage category III acc. to IEC 664-1, Table 1 for air distances of mains circuits to their environments acc. to EN 50178/VDE0160/4.98, Section 5.2.16.1.
- Voltage range of the mains circuit for TN and TT mains acc. to HD 384.4.4152/DIN VDE 0100/410:1996 with a phase-to-earth voltage of 500 V.
Insulating material IIIa for creepage distances acc. to EN 50178/VDE0160/4.98, Section 5.2.17.

The power units of the series BUG 62x are not short circuit proof according to EN 50178/VDE 0160/4.98, section 6.3.4.

5.3 EMC notes

General information on converters

Baumüller units are equipped with IGBTs. Due to their rapid switching operation the power loss in the converter is minimized. The size of the power modules is thus more and more decreased. The rapid switching operation of the IGBTs on the other hand leads to electromagnetic influences of other parts.

Interferences may be caused by:

- capacitive fault currents. This is caused by high voltage peaks and switching of bipolar transistors and IGBTs.
- high currents and current peaks in the motor cables The interfering energy bound in magnetic fields reaches frequencies of a few Hertz up to approx. 30 MHz. Due to the high voltage peaks, additional electromagnetic fields occur with frequencies of up to approx. 600 MHz.
- high chopping rates and fast logic circuits (electromagnetic field / 16 MHz .. 1 GHz).

German EMC Law (EMVG)

This converter corresponds to EMVG §6 Section 9 of EMVG (German EMC Law) dated 18 Sept.98.

"Devices, which are exclusively manufactured or stocked as vendor parts or spare parts for further processing by industrial companies or craftsmen or by other specialists in the field of electromagnetic compatibility do not need to comply with the protective requirements of Paragraph 4, Section 1 no. 1 to 3 and 5.

This takes into account that EMC is essentially dependent on the subassemblies of the individual modules and components in the switch cabinet.

Measure to ensure EMC safety

To minimise the above mentioned electromagnetic influences certain conditions have to be observed when laying and shielding cables and when connecting filters.

The information on the next pages is intended to allow the user to configure his plant according to the latest knowledge in the field of EMC and to comply with legal regulations.

Cabling

- To suppress noise emission outside the converter always screen **all** connected cables. If the screening attenuation of the switch cabinets is sufficient (see limit values of radio disturbance emissions according to EMVG (german EMC law) for your plant) and the EMC inside the switch cabinet is guaranteed (this you may presume when all project planning notes given in this chapter are observed) the control leads may be mounted unshielded.

Also observe the items in Chapter "Screening".

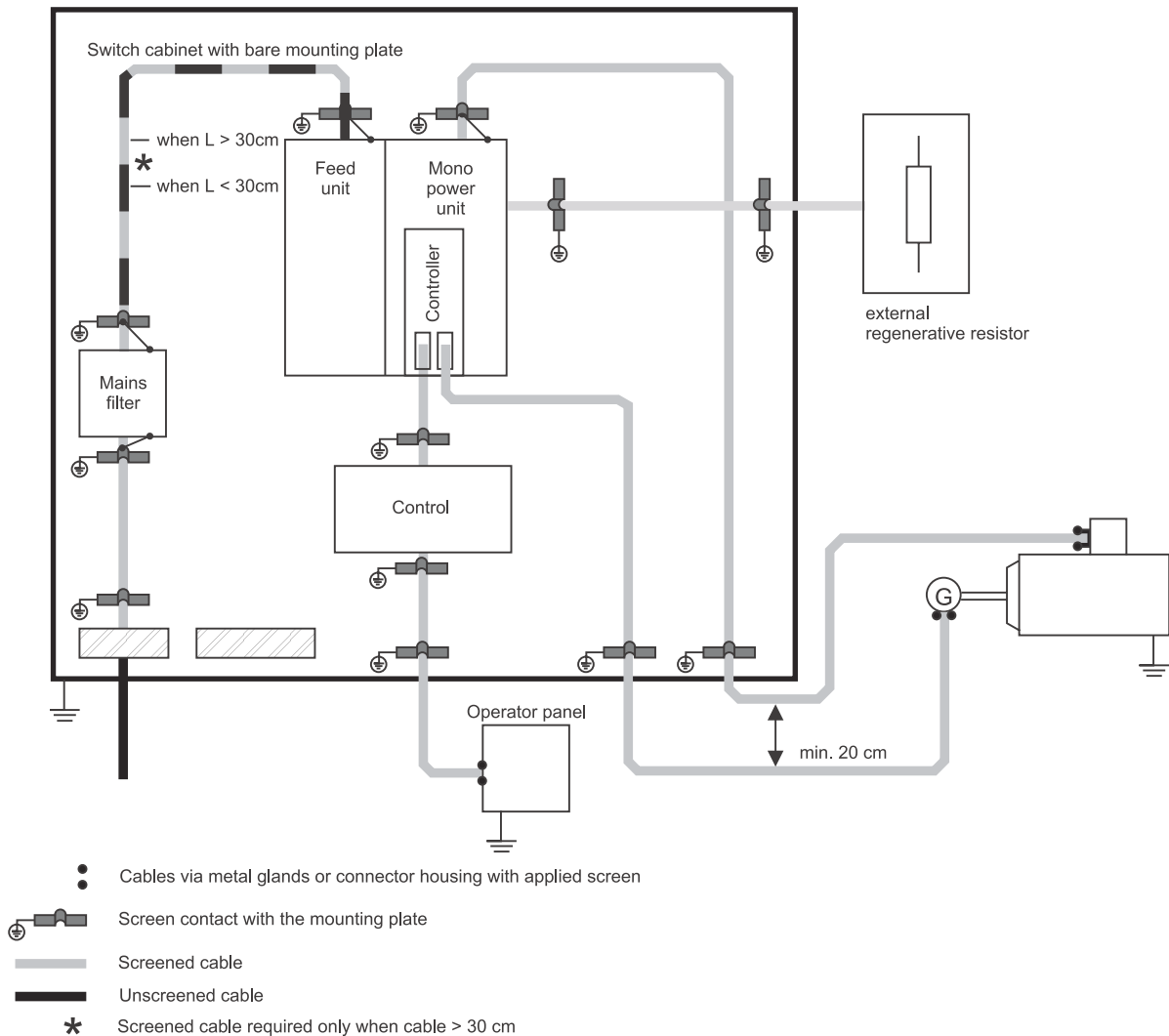

Installation

- You achieve the smallest possible effective antenna height by laying the cable directly on the ground of the metallic rack

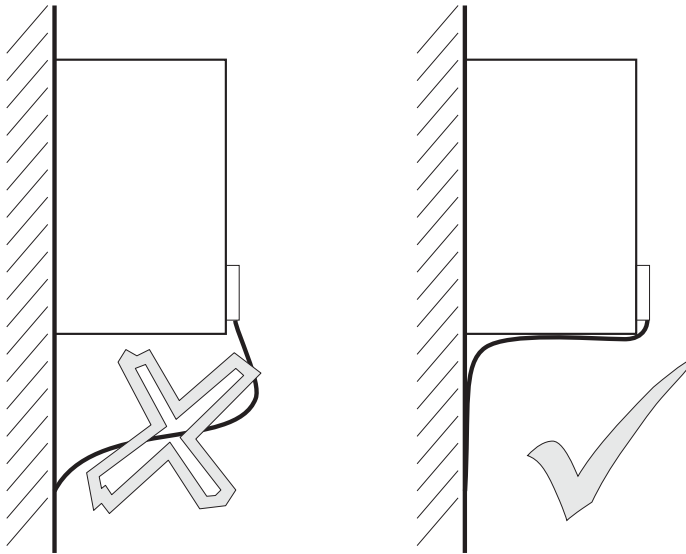

- You should lay all cables as close as possible to the conductors of the ground system to reduce the effective loop area for magnetic coupling.

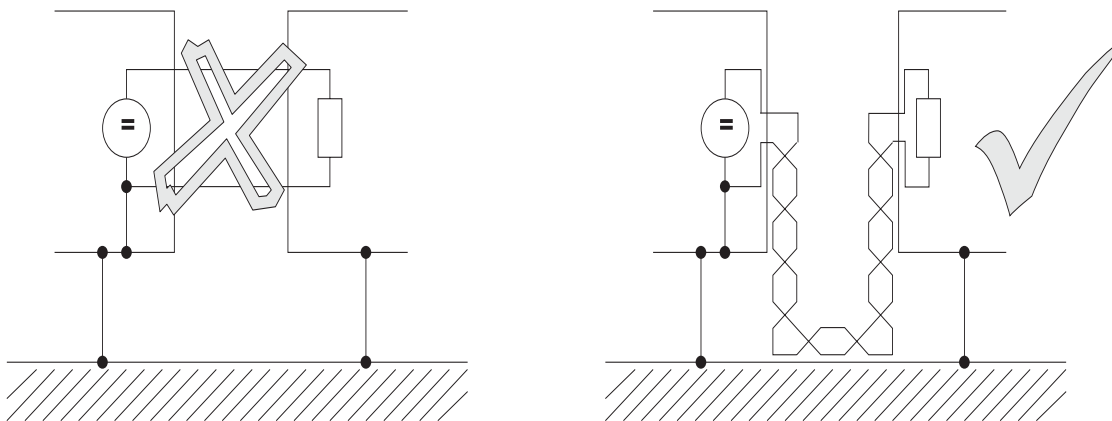

- When laying signal and control cables in parallel across power cables, maintain a minimum distance of 20 cm between the conductors.
- Cables of different EMC categories should only cross at an angle of 90°.
- For symmetrical signal transmission (e.g. differential amplifier inputs for the speed setpoint), twist the conductors of each pair together and twist the pairs of wires together.
- The connection between converter and ground plate should be as short as possible (< 30 cm). Use large cross-sections (>10 mm²).
- Sources of noise such as fuses, transformers, chokes and noise-sensitive modules such as microprocessors, bus systems, etc. should be located at least 20 cm away from the converter and its cabling.
- Avoid reserve loops on long cables.
- The grounding of reserve wires in cables is mandatory (additional screening, avoidance of capacitively coupled, hazardous contact voltages).

Grounding

- To meet EMC requirements, the classical star grounding is no longer sufficient to reduce the noise of high frequencies caused by converter operation. Better results can be achieved by a reference surface which must be linked to the units' ground (e.g. bare metal mounting plate and housing parts).
- If a large reference surface is not possible the main equipotential bonding strip should be arranged directly at the power unit which generates the largest potential steps compared to the other components in the switch cabinet (ground connection < 30 cm if possible).
- To avoid earth loops, apply all ground connectors and screens as close as possible above the ground.
- If it is possible to ground the controller reference potential of the power unit, make the connection with as large a cross-section as possible and a short cable (< 30 cm).
- Remove insulating layers such as paint, adhesives, etc. from the ground connections. If necessary, use serrated lock washers (DIN 6798) or similar measures to ensure a permanent, conductive contact. To prevent corrosion on ground connections, use suitable metal combinations (electrochemical series of metals) and keep conductive electrolytes away from the connection by a protective coating (e.g. grease).
- Always connect screens at both ends over a large surface and conductive to ground. This is the only way to suppress the effects of magnetic or high-frequent noise. If earth loops occur (e.g. double insulation of the setpoint conductor screen), apply the receiver side galvanically and the transmitter side capacitively.
- When laying external cable screens through panels separating different EMC areas, make contact to the cable screens.
Cables which are passed through the panels of screening housings without special measures (e.g. filtering), may impair the screening effect of these housings. For this reason, you must make a conductive connection of the cable screens at the point at which the cable enters the housing. The distance of the last screen contact point to the exit of the cabinet must be as short as possible.

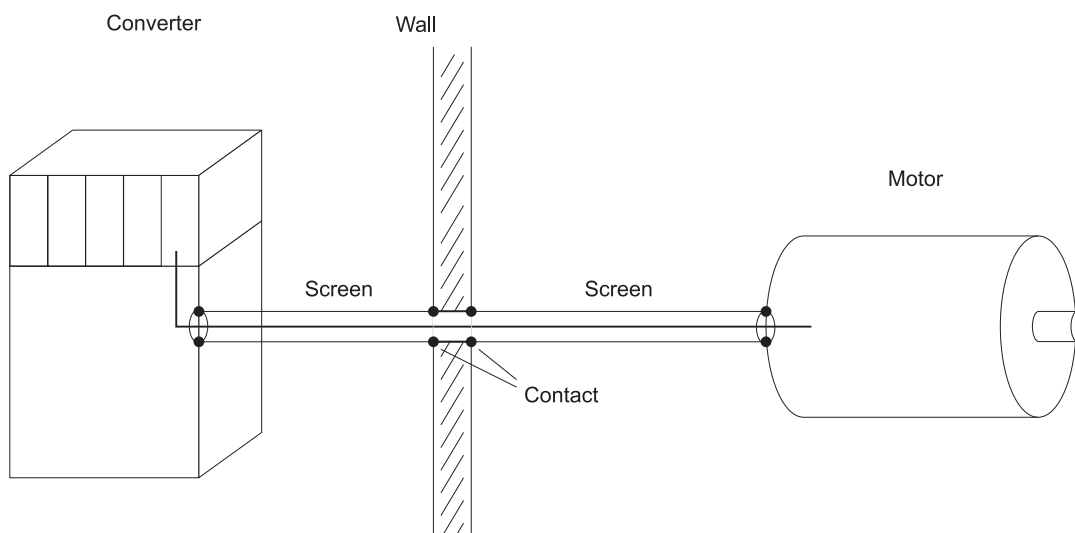

Shielding

- The screen is effective against magnetic fields when it is connected to ground at both ends.

With electrical fields, the screening is effective if the screen is connected to ground at one end.

Fields with high frequencies (depending on the cable length) are always electromagnetic. It doesn't matter if the field basically is electric or magnetic. Always apply the screen at both ends for fields with high frequencies.

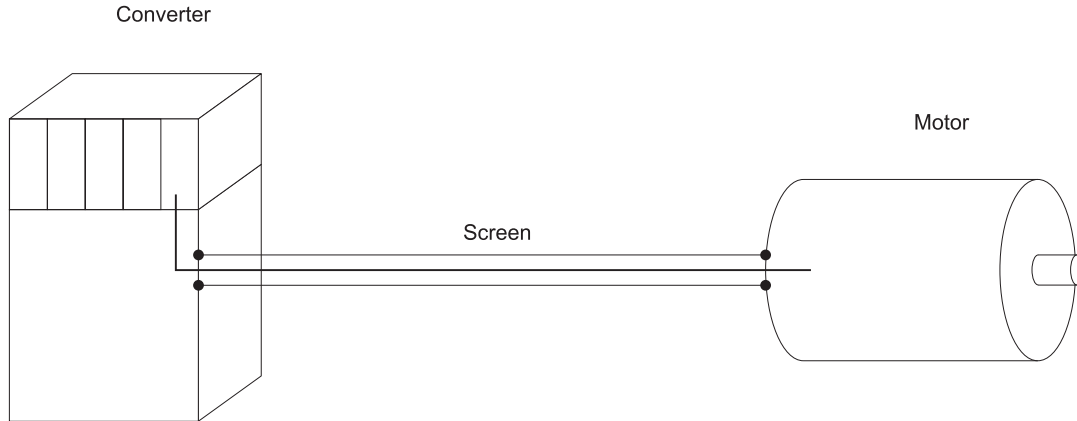

If you apply the screen to ground at both ends, the cable does not leave the screening "system housing".

- If you connect cable screens to ground at both ends, the effect of earth loops (potential difference on the ground system) cannot be excluded totally. However, these are very rare if you observe the measures of the above chapters "Cabling" and "Grounding".

The HF connection of a screen to ground can also be capacitive. This prevents low-frequent noise caused by earth loops.

Screen cables passing through different EMC areas must not be separated at the terminals, otherwise the screening would be reduced considerably. They should be led to the next module without interruption.

The screen connection should be of low impedance and over a large surface. Cable tails with a length of only 3 cm (1 cm wire = 10 nH) reduce the screening of up to 30 dB when noise occur in the MHz range!

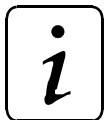

NOTE

The screen braid must have a coverage of at least 85%.

The following cables have a particularly high interference potential:

- Motor cable
- Cable to external regenerative resistors
- Cable between mains filter and converter

Proposal for the screen connection:

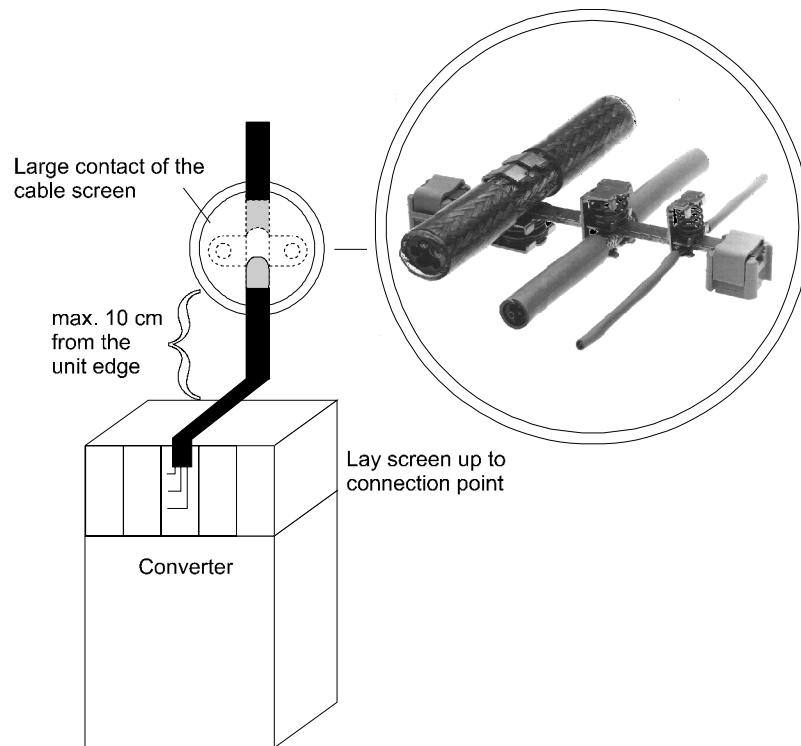

Installation

Shield clamps for grounding

	cable diameter \varnothing (mm)	Item no.
	2 x 2 - 6 mm	226752
	3 - 8 mm	226741
	4 - 13,5 mm	226745
	10 - 20 mm	226749
	larger diameters on request	

Filtering

No filters are necessary for the function of the converter. To maintain EMC regulations, filters at the input or output side may be required.

If you have any queries about the filter dimensioning, please ask for the description "5.95237.xx Baumüller Filters for Mains Applications BFN".

Filter assembly

- Mount the filter next to the converter. If the cables are longer than 30 cm, screen the mains cable between converter and filter (grounding at both ends).
- Input and output cables of the filter must be separated physically (distance > 30 cm).
- Connect the filter housing to ground over a large surface.

Leakage currents

Due to the principle of operation, stray capacitances in the filter, power stage, motor cable and motor winding cause leakage currents of 100 mA and higher.

This means that converters with current-operated e.l.c.b. can be incompatible!

Observe the safety information in EN 50178/VDE 0160/4.98 Section 5.2.11.2.

5.4 Terminal diagram

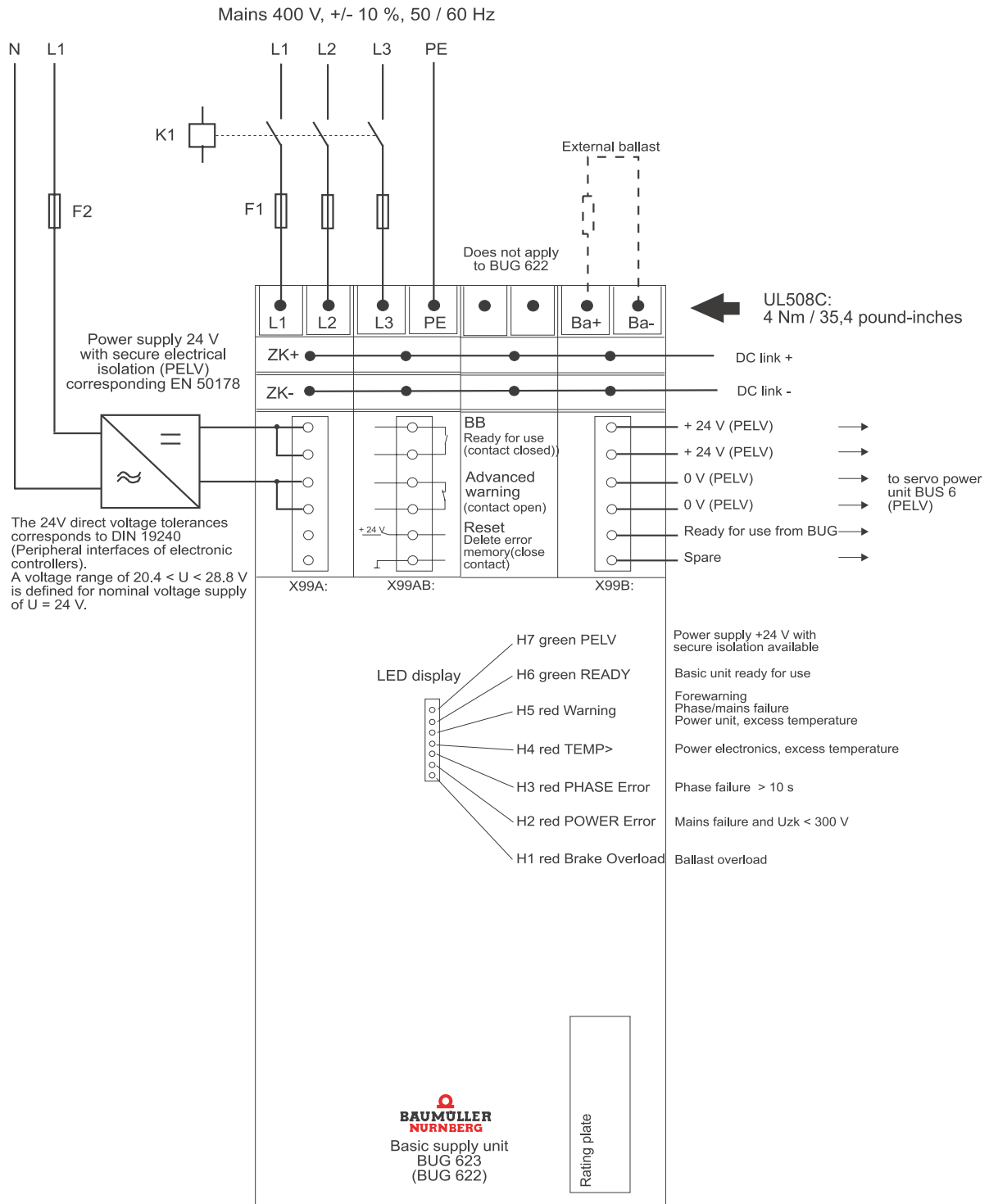

Terminal notes

F1	<p>BUG 623: 100 A semi-conductor fuse BUG 622: 80 A semi-conductor fuse 35 A circuit-breaker fuse (see Accessories on page 40)</p>
F2	Fuse dependant on power supply
Ground leakage circuit-breaker	<p>Relatively high leakage to ground occurs in the converter and the motor, i.e. the drive may be incompatible with residual current protective devices.</p> <p>Reference should be made to EN 50178/VDE160/4.98 sect. 5.2.11 before configuration.</p>
K1	Mains contactor with auxiliary contact for controller enabling (optional, not absolutely necessary).
L1, L2, L3,	<p>Mains connection profile according to EN 60204-1/VDE0113, part 1 / 11.97 section 13 Laid see EMC notes.</p> <p>If UL508C has to be observed: Use 60°C / 75° C copper conductors only (UL508C, Nov 27, 1996, Tab. 39.2). Nominal tightening torque of the terminal screws: 4 Nm resp. 35,4 pound-inches.</p>
ZK+, ZK-	<p>DC link connection of further power modules BUS 62x, up to a total power rating of 18 kW (BUG 622), or 36 kW (BUG 623).</p> <p>If UL508C has to be observed: Nominal tightening torque of the terminal screws: 4 Nm resp. 35,4 pound-inches.</p>
	<h2 style="margin: 0;">DANGER</h2> <div style="background-color: #f0f0f0; padding: 10px; margin-top: 10px;"> <p>The DC link carries electrical potential: it is imperative that the provided cover is used.</p> </div>
Ba+, Ba-	> 16 Ω, power according to requirements (up to nominal power of basic supply unit)
Power supply 24 V	<p>24 V_{DC} voltage supply for protective low voltage with secure isolation (SELV / PELV) according to EN 50178 for supplying the electronic part.</p> <p>Current consumption of the basic unit: 0.5 A</p>



NOTE

The BUG 62x has capacitors at its input; which means, on switching the 24 V supply, charging current is present!

The 24 V power supply is connected to the power modules BUS 62x, thus the current input rises. At continuous operation below 24 V the cooling power of the internal ventilator is reduced. Power reduction of supply unit on request.

5.5 Connector pin assignment

5.5.1 Power terminals

- **L1, L2, L3, PE**

L1, L2, L3:	Unit input voltage 400 V _{AC} - 460 V _{AC}
PE:	Control cabinet ground M 6 terminals

If UL508C has to be observed: Use 60°C / 75° C copper conductors only (UL508C, Nov 27, 1996, Tab. 39.2).

Nominal tightening torque of the terminal screws: 4 Nm resp. 35,4 pound-inches.

- **ZK+, ZK-**

Connect the servo power unit BUS 62x with the supply BUG 62x through the supplied connection. When the unit leaves the factory, the supplied connections (rails) are fastened to the frontrails of the BUS 62x.

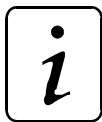

NOTE

Longer connections as by the supplied connections are not permitted, as this may cause damage to the equipment.

M 6 terminals

If UL508C has to be observed: Nominal tightening torque of the terminal screws: 4 Nm resp. 35,4 pound-inches.

- **Ba+, Ba-**

Ballast resistance terminal on a basic supply unit BUG 622, 623 with "external ballast".

M 6 terminals

If UL508C has to be observed: Use 60°C / 75° C copper conductors only (UL508C, Nov 27, 1996, Tab. 39.2).

Nominal tightening torque of the terminal screws: 4 Nm resp. 35,4 pound-inches.



WARNING

A resistance lower than 16 Ω are not permitted, as this may cause damage to the equipment.

The power of the external ballast resistance depends on the motor and is not monitored by the unit.

5.5.2 Control terminals

- All control voltages applied externally must comply with the regulations for PELV or SELV
- Sub-unit terminal X99A/X99B**

Terminal no.	Assignment
1, 2	+ 24 V (PELV) Terminal for power supply to the units, both terminals internally bypassed, 2nd terminal with power supply current > 10 A
3, 4	Ground 24 V (PELV) Terminal for power supply to the units, both terminals internally bypassed, 2nd terminal with power supply current > 10 A
5	Ready for use, internal (PELV) Ready for use message from the supply converter to all units attached to the DC link.
6	Reserve (PELV)

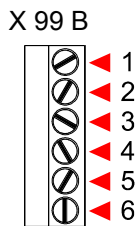
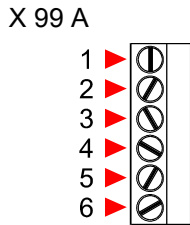

All terminals are connected to each other. Because of this they can be used as BUS-connection from one Baumüller unit to the other.

The signals can be executed as a bus connection, due to the connection of X99A with X99B of the next unit in the line.

Recommended connection lead length 44 mm:

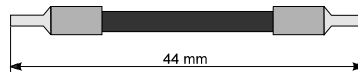

WARNING

A maximum current greater than 10 A per single terminal may cause damage to the equipment. If higher currents are needed do build a multiple feeder system.

Installation

- **Sub-unit terminal X99AB**

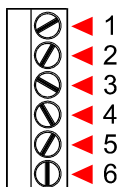

Terminal no..	Assignment
1, 2	Ready for use (SELV / PELV) Relay output,: ready for use supply converter 24 V 0.5 A max.
3, 4	Forewarning (SELV / PELV) Relay output: Forewarning supply converter 24 V 0.5 A max
5	+ Reset with 24-V-Signal (SELV / PELV) Error message reset input of the supply converter (potential-free optocoupler input, 8 ... 15 mA)
6	Ground reset (SELV / PELV) Error message reset reference point of the supply converter (potential-free optocoupler input)

5.6 Accessories

- **Fuses**

	BUG 622	BUG 623
Semi-conductor fuses	80 A / 1000 V	100 A / 1000 V
Part no.	19008531	19008526
Size according DIN 43620	0	0
mains fuses	35 A medium time-lag	only with reduced cross section

- **EMC**

on requirement available:

- EMC Filter
- shielded cables
- shield clamps

6 COMMISSIONING

6.1 Danger information



WARNING

This unit carries dangerous voltage and contains dangerous rotating machine parts (fans). This means that death, serious injury or considerable material damage can occur if the safety and warning notices are not heeded.

The user is responsible for the assembly of the converter power unit, the motor, mains filter and the other components according to applicable safety standards (e.g. DIN, VDE) and all other relevant national or local regulations regarding conductor dimensions and fusing, grounding, circuit breakers, overcurrent protection etc.

The protective measures and safety regulations according to DIN/VDE are binding for personal security. If there are **no PE connections** on the unit, the mains filter or the motor, **personal injury** may be caused since the surface may carry hazardous voltage.

During operation, the principles on which the converter and motor work, lead to leakage currents to earth which are dissipated via specified protective earth connections and which may result in a current-operated e.l.c.b. on the input side blowing prematurely.

A DC component in the fault current may occur in the event of a short-circuit to frame or earth fault which makes a triggering of the higher-level current-operated e.l.c.b. more difficult or even impossible. Make the PE connection according to DIN EN 60204-1 / VDE 0113 Part 1 / 01.97, Section 8.2.2. considering EN 50178 / VDE 0160/4.98, Sections 5.3.2.1 and 8.3.4.4.

Before commissioning check whether the plastic covers over the live parts (power part connections) are in place.

When an error occurs, the drive is de-energised and the motor coasts to stop. This fact must be taken into account particularly for hoist and lifting drives.



WARNING

Prior to connecting the drive, carefully check all higher-level safety equipment for perfect functioning, to avoid personal injury.

Behavior of the drive in the event of error

Faulty or uncontrolled drive and machine element movement can not be ruled out during initial commissioning. Hence special care must be taken.

Protection against contact according to Paragraph 4 Section 4 VBG 4

Protection against direct contact comprises all measures against danger which can result from touching the active parts of electrical equipment.

Sheets of plastic covering the control electronics, the power stage and the device connection, additionally prevent accidental contact during commissioning and casual use of control elements located close to the equipment (DIN VDE 0106 Part 100, Unfallverhütungsvorschrift „Elektrische Anlagen und Betriebsmittel“ VBG4).

Switch cabinet must have emergency stop facilities using which all voltages causing dangerous situations, can be switched off. This does not include equipment which, if switched off, would cause another dangerous situation. The releasing element for the emergency stop facility must be arranged such that it can easily be reached in case of danger. In the event of work which is considerably more dangerous than usual, another person must be present.

The user is to ensure that no unauthorised persons work on the machine.

The user is obliged to report any changes which may affect the safety of the machine.

On dismantling safety equipment during commissioning, repair and maintenance, the machine is to be shut down exactly according to instructions. After completion of commissioning, repair and maintenance work the safety equipment is to be reinstalled and checked immediately.

6.2 Operation

Resetting of operating messages, which are stored by the basic supply unit:

- Set reset input at terminal strip X99AB (attach + 24 V)
- Switch off the +24V supply voltage

Error saving can be cancelled (function "Speicher löschen" - flush memory) by constant triggering of reset input.

Previous messages are retained.



NOTE

If the message "mains failure" is active and only +24 V low voltage supply is applied the message is not saved. The message is saved only when the main supply has been applied.

Setting the basic supply unit BUG 622, 623 is not necessary.

6.3 Mains failure

It is possible to enable an automatic restart of the basic supply unit after a mains failure:

For that purpose

At terminal strip X99AB attach
Terminal no. 5: to +24 V
Terminal no. 6: to ground 24 V

This corresponds to reset (message memory).

- In the case of voltage failure (DC link voltage lower than 300 V) the basic supply unit generates the message voltage failure (power error H2).
- The supply unit's "ready for use" signal is taken away.
- The message voltage failure is deleted automatically if the mains voltage returns. The supply unit's status is now "ready for use".



WARNING

If you enable an automatic start of the drive, you cause a severe danger of the operating personnel. If you enable an automatic start of the drive, you must provide a protection on the machine side!

6.4 Messages and warnings

To use the monitoring the +24 V power supply (X99A or X99B) must be available.

Following features are monitored:

- | | |
|-------------------------------|---------------------|
| – Overload ballast | H1 (Brake Overload) |
| – Voltage failure | H2 (Power Error) |
| – Phase failure | H3 (Phase Error) |
| – High temperature (overload) | H4 (Temp >) |

- **Ballast monitoring H1**

The ballast monitoring function monitors the collector-emitter voltage of the ballast transistor, and in the case of equipment with internal ballast, the switch-on time of the ballast resistance. On exceeding the permitted limits, the error is saved, and in the case of overload an internal and external "ready for use" message is prevented.

The ballast message cannot be reset by a common reset. Due to safety reasons the DC link has to be discharged ($U_{ZK} < 20 \text{ V}$) to reset this message.

- **Mains monitoring H2/H5 H5 Warning**

This prevents an internal and external "ready for use" message if at least one phase is missing in the mains voltage.



NOTE

After switching on the +24V electronics supply, the operation of the mains monitoring is only saved when:

- the mains is reported OK for the first time
- the DC link has dropped below 300 V.

- **Phase failure monitoring H3/H5 H5 Warning**

The phase failure monitoring function recognises that a phase is missing in the supply voltage and gives an error message.

After 10 seconds the error is saved and an internal and external "ready for use" message is prevented.

- **Temperature monitoring H4/ H5 H5 Warning**

The temperature of the cooling element is monitored and a warning is given in cases of overload, i.e. excess temperature.

After 10 seconds the error is saved and an internal and external "ready for use" message is prevented.

H5 Warning

The relay "warning" opens message contact X99AB:3,4, if either of the phase failure, mains failure or temperature monitoring functions generate a warning.

Thus the machine can be set to a defined operating mode, in the event of error, before the unit prevents "ready for use" and shuts itself down.

H6 Ready for use

The relay "ready for use" closes the message contact X99AB if no of the following messages are generated: phase error, mains error, ballast, temperature.

SELV / PELV H7

Displays it safe extra-low voltage +24 V is present.

Reset

The error message memory of the supply unit is erased by operating the reset input (supply +24 V at X99AB/5 and M24V at X99AB/6, optocoupler input), without having to switch off the +24V auxiliary voltage supply (funktion "Speicher löschen" - flush memory).



NOTE

Errors that are still active cannot be erased!

Error saving can be cancelled by continual operation of the reset input if an automatic start, e.g. after mains failure, is to occur.



WARNING

Protection is to be provided at the machine-side.

6.5 Flow chart

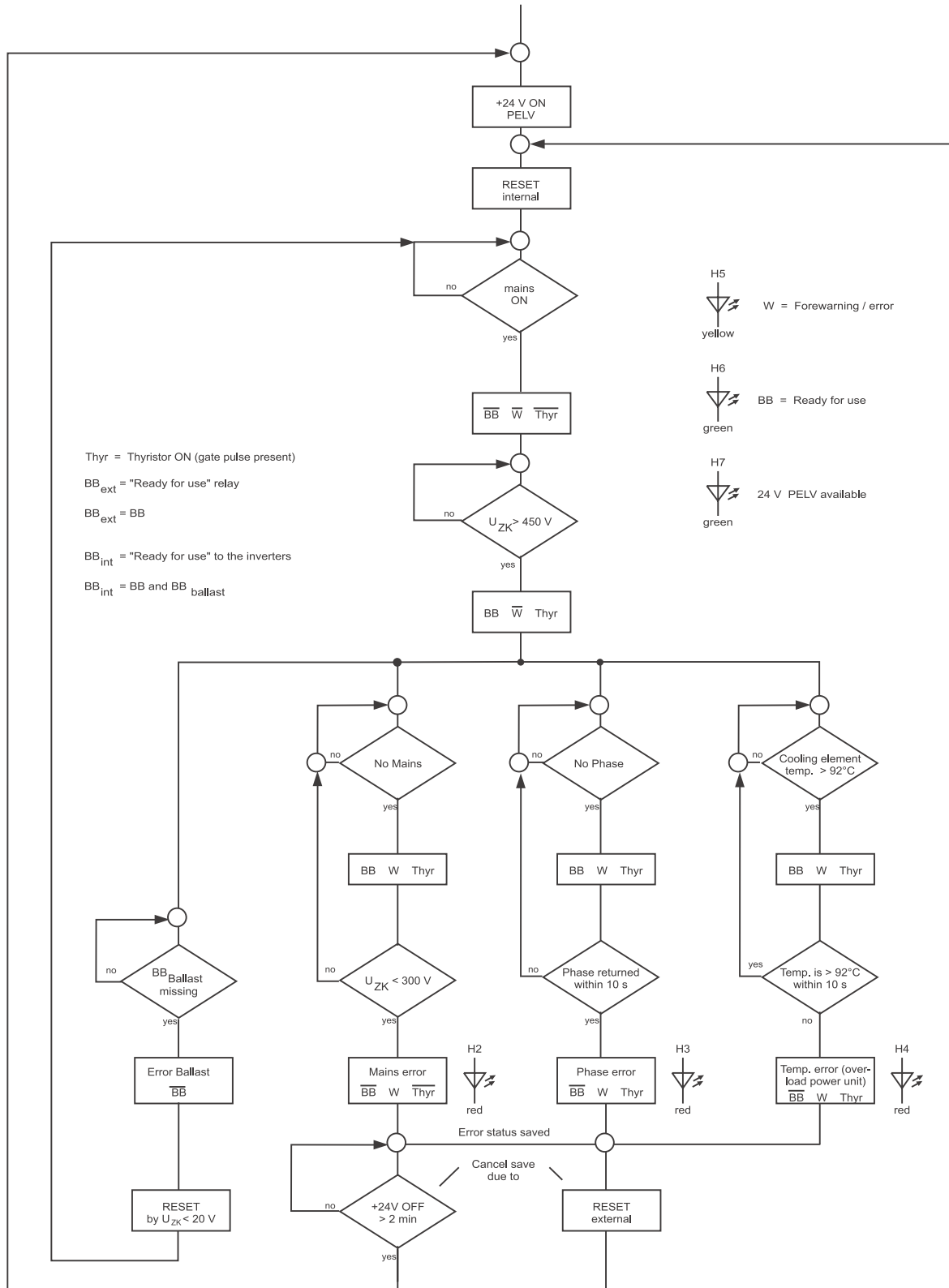

7 MAINTENANCE



WARNING

This power unit carries dangerous voltage and contains dangerous rotating parts (fans). Ignoring the safety and warning information may result in death, severe personal injury or damage to material assets.

All maintenance and service work must only be carried out when the unit is de-energised.

Do not begin work on the DC link or other parts of the power unit until you have made sure that neither potential nor voltage (residual charge) is applied.

When dismantling safety equipment during commissioning, repair and maintenance, ensure that the machine is taken out of commission in accordance with applicable regulations. Remount and check the safety equipment immediately after completing commissioning, repair and maintenance work.

After carrying out any work on the machine – regardless of whether this involves the motor, the revolution detection or the power unit – the owner must carry out acceptance testing of the entire drive and document this chronologically in the machine log.

Failure to do this may result in the owner being faced with consequences relating to liability.

7.1 Maintenance information

The supplied power unit is free of maintenance.

Prohibition of unauthorised modifications

For safety reasons, you must not modify or add components on/to the drive.

7.2 Environmental conditions

If you keep to the environmental conditions during the entire period of storage, you can assume, that the device will not be damaged.



WARNING

From six months storage period on, the capacitors are destroyed during commissioning, if they are not reformed beforehand.

Reform the capacitors by supplying the device ready-for use for at least 48 hours with supply voltage, but no impulse enable.

7.3 Recommissioning

Carry out commissioning as with a new device.



WARNING

From six months storage period on, the capacitors are destroyed during commissioning, if they are not reformed beforehand.

Reform the capacitors by supplying the device ready-for use for at least 48 hours with supply voltage, but no impulse enable.

7.4 Disposal

The units consist essentially of the following components and materials:

Component	Material
Housing	Sheet-steel, aluminium
Chokes	Copper, transformer magnetic sheet-steel
Various spacers, housing of current converter and unit fan, etc.	Plastic
PCBs on which all the open- and closed-loop electronics are mounted	Base material: Epoxy-resin fiberglass woven material, copper-coated on both sides and plated-through, various electronic components such as condensers, resistors, relays, semiconductors, etc.

Electronic elements may contain dangerous material.

If the components are used as directed, there is no danger for human beings or to the environment.

Hazardous materials may be created or released in case of fire.

Electronic components must not be opened, since beryllium oxide is used as internal insulation e.g. in diverse semiconductors.

The beryllium dust set free when the components are opened, is dangerous to your health.

The units and modules must be recycled at the end of their service life.

If recycling is not possible dispose the units and modules according to the national regulations and the regional and local ordinances.

8 APPENDIX

8.1 Manufacturer's declaration

HERSTELLERERKLÄRUNG IN SINNE DER EG-MASCHINENRICHTLINIE 89/392/EWG, ANHANG IIB

Manufacturer Declaration in Accordance with the EC-Machine Guidelines 89/392/EEC, Appendix II B

Hiermit erklären wir, dass es sich bei dieser Lieferung um die nachfolgend bezeichnete Maschinenkomponente handelt und dass ihre Inbetriebnahme solange untersagt ist, bis festgestellt wurde, dass die Maschine, in die diese Komponente eingebaut ist, den Bestimmungen der EG-Maschinenrichtlinie 89/392/EWG, Anhang II B entspricht.

We herewith declare that this delivery includes the following specified machine component and that its putting into operation is prohibited until the declaration is made that the machine, in which this component is built in, complies with the regulations of the EC-machine guideline 89/392/EWG, appendix II B.

Bezeichnung der Maschinenkomponente:
Specification of the machine component:

Typenbezeichnung:
Type:

Grund-Einspeise-Einheit BUG 622, 623

BUG 62.. - ..

Nürnberg, 28.12.2004

Hersteller-Unterschrift:

Signature of the Manufacturer:

 11/1/2005

Andreas Baumüller

Geschäftsleitung
Head Division

 10.1.2005

ppa. Dr. Peter Heidrich

Entwicklungsleiter
Head of Development

8.2 Declaration of Conformity

**KONFORMITÄTSERKLÄRUNG IM SINNE DER
EG-NIEDERSPANNUNGSRICHTLINIE 73/23/EWG**

EG Declaration of conformity of equipment regarding low voltage directive 73/23/EWG

Bezeichnung der Maschinenkomponente:
Specification of the machine component:

Typenbezeichnung:
Type:

Basic Supply Unit BUG 622, 623

BUG 62.. - / .. - .. -

Die Übereinstimmung des bezeichneten Produkts mit den Vorschriften der Richtlinie wird nachgewiesen durch die Einhaltung folgender Normen:

Conformity of the signficated product with the guidelines will be proved by following rules:

EN 50178: 1994 (VDE 0160/11.94)

"Ausrüstung von Starkstromanlagen mit elektronischen Betriebsmitteln"
"Equipment of power installation concerned electronic operating materials"

Nürnberg, 28.12.2004

Hersteller-Unterschrift:
Signature of the Manufacturer:

11/1/2005

Andreas Baumüller
Geschäftsleitung
Head Division

10.1.2005

ppa. Dr. Peter Heidrich
Entwicklungsleiter
Head of Development

8.3 General Conditions of Sale and Delivery

1. Obligation and Conclusion of Contract

- a) Deliveries of goods and provision of services shall be effected exclusively based on these trading conditions. They are an essential component of the contracts for delivery and shall be considered as having been accepted by the placing of an order. In the case of constant business relations, they also apply for the future contracts.
- b) Agreements diverging from the contract and verbal collateral agreements shall only be binding if they have been confirmed in writing by Baumüller Nürnberg GmbH (hereinafter referred to as Baumüller). Diverging trading conditions on the behalf of the purchaser shall be without obligation, even where these have not been expressly objected to. These General Conditions of Sale and Delivery shall be considered as having been accepted by the purchaser at the latest when the delivery is accepted.
- c) In as far as deliveries of goods are subject to separate external obligations in accordance with the Law Concerning Foreign Trade and Payments with respect to the Federal Office for Economics, the purchaser has to observe the relevant conditions at his/her own responsibility.

2. Price and Offers

Offers are subject to confirmation, not binding and apply subject to material supply possibilities. Supplements and amendments require written confirmation. Prices are ex works and are subject to confirmation. Invoicing takes place in accordance with the prices valid on the date of delivery.

3. Extent of Delivery and Delivery Time

- a) Specified delivery periods/dates are without obligation, in as far as nothing else to the contrary has been expressly agreed upon in writing. Delivery periods do not commence until the purchaser has fulfilled all duties of co-operation, in particular regarding details of performance. In the event that the agreed deposits for orders are delayed, then the delivery time shall be extended accordingly.
- b) The purchaser is entitled, in particular in the event of a delay in delivery of longer than 3 months, to set an appropriate period of grace and after its expiry, to withdraw from the order. Claims to compensation due to non-fulfilment or delay shall be excluded, in as far as Baumüller is not responsible for intent or gross negligence.
- c) Baumüller is entitled at any time to effect partial deliveries and partial services, as well as to invoice these accordingly

4. Delivery Problems

- a) Delays/preventions in the delivery of goods or the provision of services due to force majeure entitle Baumüller to delay the production and delivery by the duration of the obstruction plus an appropriate period of time or to withdraw in part or in whole from the order.
- b) Industrial disputes or other circumstances which substantially impede or render impossible the delivery, such as, in particular, disturbances in the operating processes, problems in procuring materials, official directives also apply as force majeure, irrespective of

whether they arise with regard to Baumüller or suppliers.c) In these cases, Items 4 a), b), the purchaser shall have no claim to compensation due to non-fulfilment or delay of the delivery.

5. Packaging

Items for sale and delivery items are packaged and transport insurance policies are taken out according to the instructions of and at a cost to the purchaser. Upon demand, the packaging material has to be returned without delay, free of freight charges and expenses.

6. Dispatch and Passing of Risk

Deliveries shall be made ex works. The dispatch shall be effected at a cost to and at the risk of the recipient of the service/the purchaser. The risk passes to the recipient of the delivery/purchaser as soon as the delivery items leave the works. This shall apply at the latest, from the transferral of the delivery items to the person carrying out the transport, forwarding agent or carrier.

7. Warranty

In the event that a delivery item is defective, Baumüller shall deliver an additional replacement or make a subsequent improvement at its own choice. Multiple subsequent improvements are permissible. Other warranty claims on the behalf of the purchaser, in particular also due to direct or indirect consequential damage are excluded. The pre-condition for any warranty is the normal contractual use of the delivery items. In the event of the utilisation of warranty services, the motor, the replacement part or the device has to be sent in free of freight charges, packaging costs or customs duties after prior co-ordination with Baumüller. Baumüller is exempted from any warranty if the party ordering returns the goods complained about without prior co-ordination or contrary to agreement. Warranty claims expire one month after rejection of a defect on which notice is given, in as far as the purchaser remains silent in this respect.

8. Notification of Defects

- a) The purchaser shall examine the subject matter of the contract and delivery items immediately and give notice of any defects without delay, however, no later than 7 days after receipt of the delivery. In case of non-obvious defects notice has to be given in writing without delay after their discovery, however, no later than 6 months from the point of delivery. In the event that the purchaser does not give notice of any defects in writing within this period of time, then the subject matter of the contract shall be considered as having been approved.
- b) The purchaser shall allow Baumüller a suitable inspection of defects of which notice is given and shall place all necessary/requested technical information, in particular, inspection records and test reports at Baumüller's disposal. In the event that the purchaser fails to do so, then the delivery items shall be considered as not having been complained about and as being approved. In the event that the purchaser alters the delivery items, then he/she shall lose his/her warranty claims.
- c) In the event of an established material defect or performance defect, Baumüller can eliminate the defect or supply a replacement. The purchaser can demand

rescission or a reduction after the expiry of an appropriately set period of grace. Further claims on the behalf of the purchaser, in particular to the reimbursement of dismantling costs or installation costs are excluded. The same applies to damages which do not affect the delivery item itself.

- d) Natural wear and tear and damage which arises after the transferral of risk, in particular also due to incorrect or negligent handling, excessive demands or other unsuitable use not in conformity with the contract are excluded from the warranty. The same applies in particular for defects which are attributable to atmospheric discharges, overvoltages and chemical influences.
- e) If no case of warranty is in existence or in the event that this subsequently turns out to be the case, the purchaser shall remunerate the utilisation or the use of an item or of a right, as well as services provided and expenses to an appropriate amount. Baumüller is entitled to a right of control as referred to in §§ 315 ff. BGB [German Civil Code].

9. Liability

Contractual or legal claims on the behalf of the purchaser against Baumüller are limited to intent and gross negligence. This does not apply in as far as claims from the ProdHaftG [Product Liability Act] have been enforced. Baumüller shall only be held liable to the amount of the damage foreseeable in accordance with the purpose of the contract. Material damage which exceeds the value of a delivery/service is not foreseeable in this sense. The liability is limited in terms of amount to the remuneration contractually owed.

10. Payments

- a) Invoices are payable at the time agreed in the contract, at the latest within 30 days after the invoice date, in cash and without deductions. The purchaser can only offset with claims which are final and absolute or undisputed. The same applies to the exercising of rights of retention.
- b) In the event of a delay in payment on the behalf of the purchaser, interest to the rate of 4 % above the respective minimum lending rate of the German Federal Bank, however at least 10 % has to be paid without separate proof being required.
- c) Failure to comply with the terms of payment or circumstances which endanger the credit worthiness of the purchaser result in all claims immediately becoming due. In these cases, deliveries shall only be made against payment in advance.
- d) Cash payments, bank transfers or cheque and bill payments shall not be considered as payment/fulfilment of the obligation before the amount due for payment has been irrevocably received by Baumüller or credited to Baumüller's account.
- e) Payments have to be made directly to Baumüller. The field staff are not entitled to accept payments or to issue extensions or waivers without separate written authority.

11. Reservation of Ownership

- a) The ownership of delivery items remains reserved up to the fulfilment of all existing claims against the purchaser from the business relation. Any bundling with other items shall be effected by the purchaser for Baumüller. Then, the entire product shall be considered as reserved goods.
- b) The purchaser is entitled to sell the reserved goods in orderly business transactions. All claims to which the purchaser is entitled from this sale or other legal grounds shall be assigned by him/her in advance to Baumüller. Baumüller shall accept the assignment. In the event that the reserved goods are bundled or sold with other items

standing in the possession of third parties, then the assignment shall only apply to the amount of the invoice value of the reserved goods. The purchaser is authorised to collect these assigned claims. Upon request, he/she has to make notice of the assignment to the debtor.c)The purchaser shall inform Baumüller without delay of impending and enforced access on the behalf of third parties to the reserved goods or to the assigned claims. The purchaser shall bear the costs incurred by this.

- d) The authorisation on the behalf of the purchaser to dispose of the reserved goods and to collect assigned claims expires in the event that the terms of payment are not complied with, in particular, also in the case of bill and cheque protests. In this case, Baumüller is entitled to take possession of the reserved goods. The purchaser bears the costs incurred by this. The taking back of goods shall only represent a withdrawal from the contract when this is expressly stated.
- e) In the event that the value of the securities granted exceeds the secured claims in terms of amount by more than 20 %, then Baumüller shall renounce the securities exceeding this value.

12. Drawings and Documentation

Baumüller is entitled to the exclusive property right and copyright to cost estimates, drawings and all other documentation. These documents may not be made accessible to third parties without prior written consent. In the event that a contract is not concluded, not implemented or otherwise ended, then all documents have to be returned immediately and unsolicited. There shall be no right to retention to these documents.

13. Copyright (in particular Software / Licence)

- a) Baumüller is exclusively entitled to all rights to the software/edited versions, in particular property rights and copyrights to the relinquished software, in particular for the controlling of machines, systems and installations.
- b) Baumüller grants the purchaser/buyer the non-exclusive, non-transferable right to use the relinquished software in the framework of the contractual purpose at the contractually intended location/on the places in existence at the time of purchase (single licence). The software shall only be used on the associated purchased contractual item. Any use extending beyond this is prohibited. In the event of a use extending beyond this, Baumüller shall have the rights referred to in Items 14 c), 14 d).
- c) It is prohibited to make copies of the relinquished software, whether in whole or in part, in as far as the making of copies of the machine-readable material in the framework of the required data backup or as copies for internal company use has not separately been agreed upon with prior written consent from Baumüller. Processing of the relinquished software, in particular by means of alteration, translation or by bundling with other programs shall only be permitted after prior written consent from Baumüller. Protection notices from Baumüller on/in the software may not be removed and also have to be adopted onto copies and edited versions. Copies produced contrary to this condition shall come under the possession and copyright of Baumüller. Baumüller can prohibit the use of such copies and elect to demand the immediate surrender or complete destruction with proof of this destruction.
- d) The buyer is not permitted to extend the licence in terms of location/work places/machines/machine types or to grant rights of utilisation or grant sub-licences. The extension of the licence shall be permitted by Baumüller exclusively against a separate remuneration which has to be agreed

upon in writing.

14. Applicable Law

The law of the Federal Republic of Germany is authoritative for all rights and obligations from and in connection with this contract. The regulations of the UN Sales Convention (CISG) are excluded.

15. Place of Performance and Place of Jurisdiction

The place of performance for delivery and payment is the seat of Baumüller. The place of jurisdiction for all disputes from and in connection with this contract, in particular also for cheque and bill liabilities is the seat of Baumüller.

16. Miscellaneous

In the event that individual or several conditions of these Conditions of Sale and Delivery should be or become ineffective in part or in whole, then the validity of the remaining conditions shall remain unaffected by this. The parties shall complement/replace the ineffective or incomplete condition with an appropriate regulation which most extensively corresponds to the economic purpose of the contractually desired regulation. The same applies for the case of the presence of a gap in the regulations.

For the case that acceptance and installation are also agreed upon, then the following conditions, Items 18 and 19 shall also apply:

17. Acceptance

- a) The inspection of the delivery items ready for acceptance shall take place in the Baumüller works. The purchaser shall bear the costs of this inspection. In the event that the purchaser fails to perform the inspection, then the delivery items shall be considered as having been delivered in conformity with the contract when they leave the works.
- b) The purchaser is obliged to take delivery of goods and services from Baumüller without delay. Immaterial defects do not entitle the purchaser to refuse the acceptance.
- c) In the event that the purchaser does not declare within 7 days after notification of the readiness for acceptance on the behalf of Baumüller or after receipt of the contractual service in writing and with exact, examinable specification of reasons that he/she refuses the acceptance, then the acceptance shall be considered as having been declared and the orderly performance of the contract as having

been ascertained.

- d) The agreed service shall be considered as having been accepted when the item delivered has been put into operation by the purchaser himself/herself or upon his/her instructions by third parties beyond the functional test required to carry out the acceptance. This also applies in the event that the purchaser refuses the functional test/the acceptance without sufficient cause.
- e) Experts to be designated by both parties shall take part in the acceptance inspection. The result of the functional test shall be entered in a record to be signed by the purchaser in consideration of the technical specifications.

18. Erection and Installation

Erection and installation shall only be effected in the case of express agreement at the following further conditions:

- a) The purchaser makes required workers and material available at his/her own expense.
- b) Before the commencement of installation works the purchaser shall make available unsolicited all required specifications, in particular concerning the location of power lines which have been laid such that they are hidden and similar installations, as well as the required static specifications.
- c) Before the commencement of the erection/installation, the delivery items required for the commencement of works have to be on site and all preliminary works progressed to the extent that the erection/installation can immediately begin and be completely carried out without interruption.
- d) In the event that the erection, installation or putting into operation is delayed due to circumstances for which Baumüller is not responsible, then the purchaser shall bear the costs for idle time and journeys required on the behalf of the installation personnel.
- e) The installation personnel working time has to be certified weekly by the purchaser. The purchaser shall present to the installation personnel a written certification regarding the ending of the erection/installation without delay.
- f) Baumüller shall not be held liable for the installation personnel works, in as far as the works are not connected to the delivery and the erection or installation.
- g) Trial runs on systems not supplied by Baumüller shall not be carried out by the installation personnel.

8.4 Index

A

Assembly	19
Assembly notes	21
Attachment	22

B

Ballast resistor	12
Block diagram	11

C

Cabling	27
Commissioning	41
Conditions of Sale and Delivery	53
Connection voltage	12

D

DC link capacitor	12
Declaration of Conformity	52
Dimensions	20
Disposal	49

E

Elektrical Data	12
EMC	40
EMC Law	26
EMC notes	26
Environmental conditions	48

F

Filter assembly	33
Function description	10
Fuses	40

G

Grounding	29
-----------	----

I

Input rectifier	10
Installation	23
Installation height	12

L

Leakage currents	33
Leitungsschutzsicherung	35
Low voltage supply	12

M

Mains failure	43
Maintenance	47
Maintenance information	47
Messages	44

P

Pollution degree	19
Power loss	12
Power reduction	12

R

Recommissioning	48
Removal of packaging	17

S

Safety notes	5
--------------	---

Semi-conductor fuse	35
Shielding	30
Sources of heat	21
Starting current load relief	10
Sub-unit terminal X99A/X99B	39
Sub-unit terminal X99AB	40

T

Technical data	9
Terminal diagram	34
Terminal notes	35
Total connectable capacitors in the DC link	12
Transport	17
Transport damage	17
Type code	15

Z

ZK+, ZK-	37
----------	----

be in motion

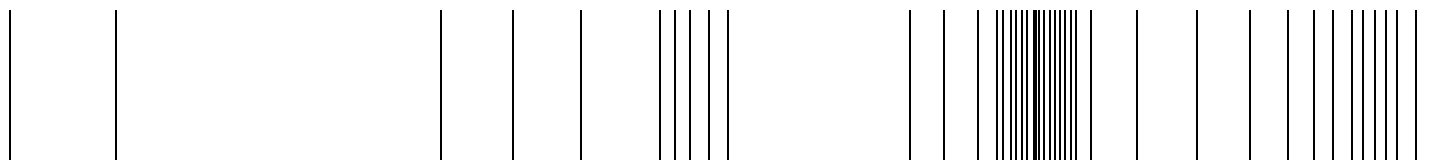

Baumüller Nürnberg GmbH Ostendstraße 80-90 90482 Nürnberg T: +49(0)911-5432-0 F: +49(0)911-5432-130 www.baumueller.de

All information given in this manual is customer information, subject to change without notice. We reserve the right to further develop and actualize our products continuously using our permanent revision service. Please notice, that specifications/data/information are current values according to the printing date. These statements are not legally binding according to the measurement, computation and calculations. Before you make any information given in this manual to the basis of your own calculations and/or applications, please make sure that you have the latest edition of the information in hand. No liability can be accepted concerning the correctness of the information.