

Reflective Object Sensor

OPB710, OPB710F, OPB730, OPB730F



Features:

- Choice of phototransistor or photodarlington output
- Unfocused for sensing diffuse surface
- Mounted on standard TO-72 header
- Available in clear encapsulating epoxy (OPB710, OPB730)
- Filtered to reduce the effect of visible or fluorescent light (OPB710F, OPB730F)

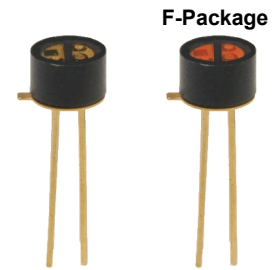

Description:

OPB710 and **OPB710F** consist of a gallium arsenide infrared emitting diode and an NPN silicon phototransistor. **OPB730** and **OPB730F** consist of a gallium arsenide infrared emitting diode and an NPN silicon photodarlington.

On each sensor, the emitting diode and detector are mounted side-by-side on parallel axes in a standard TO-72 header. A black plastic sleeve is attached and filled with encapsulating epoxy to cover the emitter and detector.

The **OPB710F** and **OPB730F** ("F" versions) have a filtering material added to the epoxy to reduce the effect of ambient light. The package contains an internal barrier which prevents diode emissions from reaching the sensor directly.

Custom electrical, wire and cabling and connectors are available. Contact your local representative or OPTEK for more information.

Applications:

- Non-contact reflective object sensor
- Assembly line automation
- Machine automation
- Machine safety
- End of travel sensor
- Door sensor

Part Number	LED Peak Wavelength	Sensor	Reflection Distance
OPB710	935 nm	Transistor	0.250" (6.35mm)
OPB710F			
OPB730		Darlington	
OPB730F			

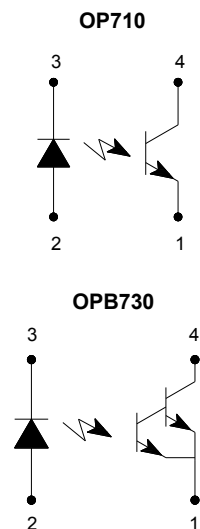
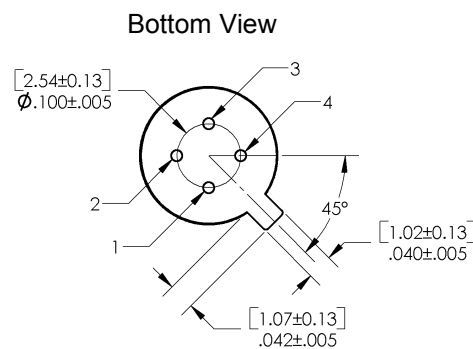
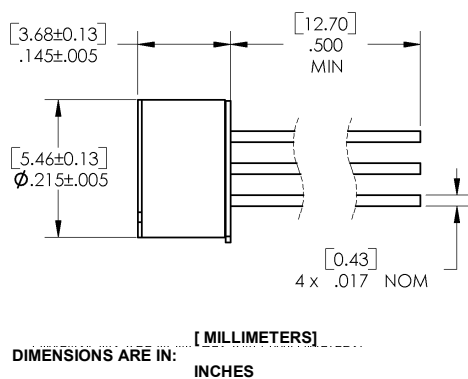

Pin #	LED	Pin #	Transistor
3	Cathode	4	Collector
2	Anode	1	Emitter



General Note
TT Electronics reserves the right to make changes in product specification without notice or liability. All information is subject to TT Electronics' own data and is considered accurate at time of going to print.

OPTEK Technology, Inc.
1645 Wallace Drive, Carrollton, TX 75006 | Ph: +1 972 323 2200
www.optekinc.com | www.ttelectronics.com

Reflective Object Sensor

OPB710, OPB710F, OPB730, OPB730F



Absolute Maximum Ratings ($T_A = 25^\circ\text{C}$ unless otherwise noted)						
Storage Temperature Range						-20° C to +85° C
Operating Temperature Range						0° C to +70° C
Lead Soldering Temperature [1/16 inch (1.6mm) from the case for 5 sec. with soldering iron] ⁽¹⁾						260° C
Input Diode						
Forward DC Current						50 mA
Peak Forward Current (1 μs pulse width, 300 pps)						3 A
Reverse DC Voltage						3 V
Power Dissipation ⁽²⁾						75 mW
Output Photosensor						
Collector-Emitter Voltage OPB710, OPB710F OPB730, OPB730F						30 V 15 V
Emitter-Collector Voltage						5 V
Collector DC Current						25 mA
Power Dissipation ⁽³⁾						150 mW
Electrical Characteristics ($T_A = 25^\circ\text{C}$ unless otherwise noted)						
SYMBOL	PARAMETER	MIN	TYP	MAX	UNITS	TEST CONDITIONS
Input Diode (see OP165W for additional information)						
V_F	Forward Voltage	-	-	1.5	V	$I_F = 50\text{ mA}$
I_R	Reverse Current	-	-	100	μA	$V_R = 3\text{ V}$
Output Phototransistor (See OP505W for additional information)						
$V_{(BR)CEO}$	Collector-Emitter Breakdown Voltage	30	-	-	V	$I_C = 1\text{ mA}$
$V_{(BR)ECO}$	Emitter-Collector Breakdown Voltage	5	-	-	V	$I_E = 100\ \mu\text{A}$
I_{CEO}	Collector Dark Current OPB710, OPB710F OPB730, OPB730F	- -	- -	100 250	nA	$V_{CE} = 5\text{ V}, I_F = 0, E_E \leq 0.1\ \mu\text{W}/\text{cm}^2$
Combined						
I_{CX}	Crosstalk ⁽⁵⁾ OPB710, OPB710F OPB730, OPB730F	- -	- -	100 500	nA	$I_F = 50\text{ mA}, V_{CE} = 5\text{ V}$ (no reflecting surface)
$I_{C(ON)}$	On-State Collector Current ⁽⁴⁾ OPB710, OPB710F OPB730, OPB730F	150 1	- -	- -	μA mA	$I_F = 50\text{ mA}, V_{CE} = 5\text{ V}, d = 0.250''$ (6.35 mm)

Notes:

- (1) RMA flux is recommended. Duration can be extended to 10 seconds maximum when flow soldering.
- (2) Derate linearly 1.67 mW/°C above 25 ° C.
- (3) Derate linearly 3.33 mW/°C above 25 ° C.
- (4) Measured using Eastman Kodak neutral white test card having 90% diffuse reflectance located .250 inch (6.35 mm) from the face of the OPB710/ OPB730. Reference: Eastman Kodak, Catalog #E 152 7795.
- (5) Crosstalk (ICX) is the collector current measured with the indicated current on the input diode and with no reflecting surface. Ambient light is excluded with a black box.

General Note
TT Electronics reserves the right to make changes in product specification without notice or liability. All information is subject to TT Electronics' own data and is considered accurate at time of going to print.

OPTEK Technology, Inc.
1645 Wallace Drive, Carrollton, TX 75006 | Ph: +1 972 323 2200
www.optekinc.com | www.ttelectronics.com

Reflective Object Sensor

OPB710, OPB710F, OPB730, OPB730F



OPB710 - Normalized Collector Current vs. Object Distance

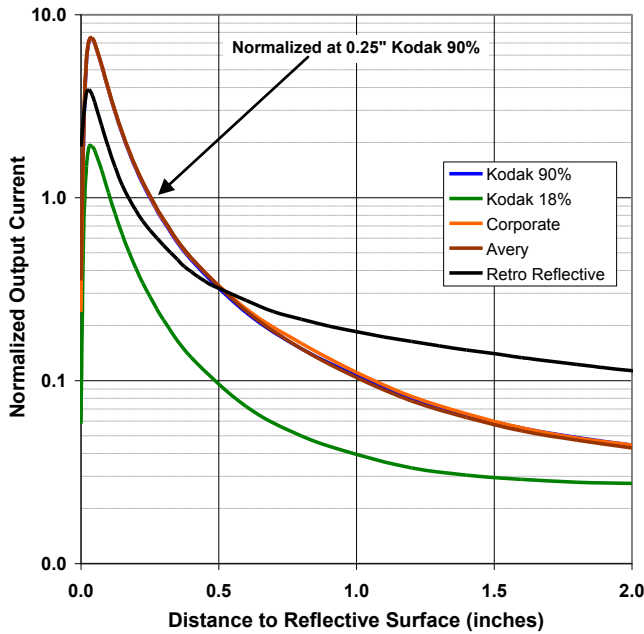

OPB710 - Forward Voltage vs Forward Current vs Temp

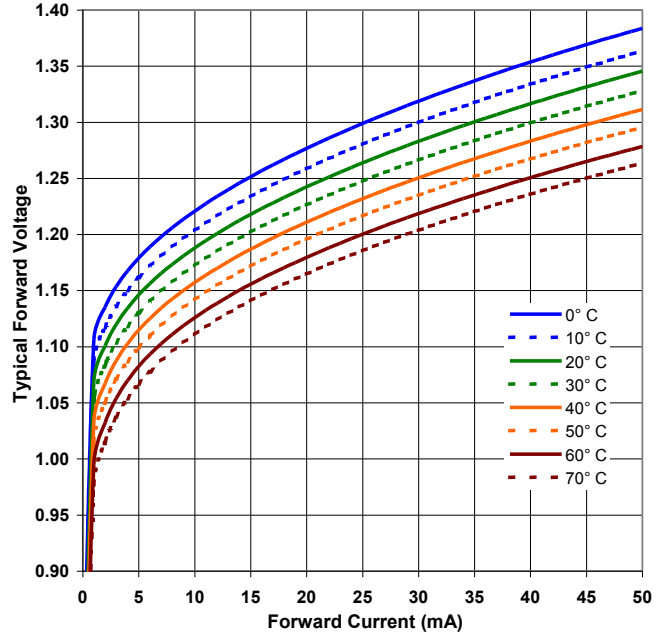

OPB710 - Output vs Forward Current vs Temp

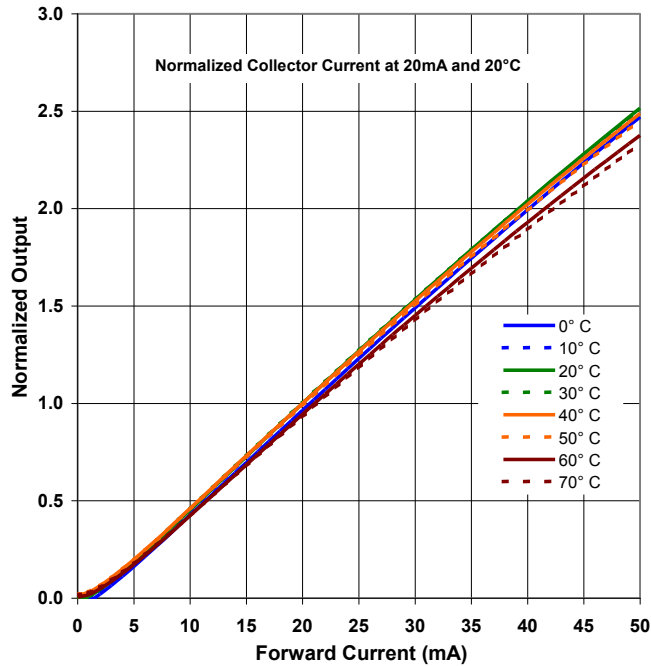

General Note
 TT Electronics reserves the right to make changes in product specification without notice or liability. All information is subject to TT Electronics' own data and is considered accurate at time of going to print.

OPTEK Technology, Inc.
 1645 Wallace Drive, Carrollton, TX 75006 | Ph: +1 972 323 2200
www.optekinc.com | www.ttelectronics.com

Reflective Object Sensor

OPB710, OPB710F, OPB730, OPB730F



OPB730 - Normalized Collector Current vs. Object Distance

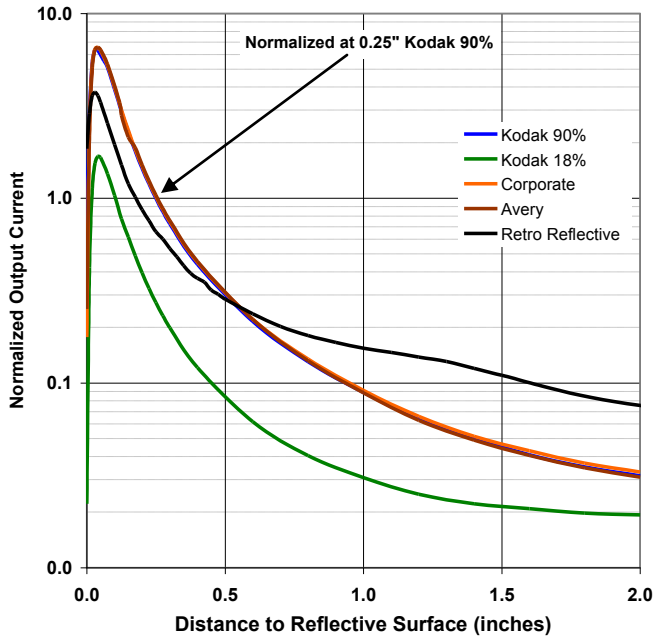

OPB730 - Forward Voltage vs Forward Current vs Temp

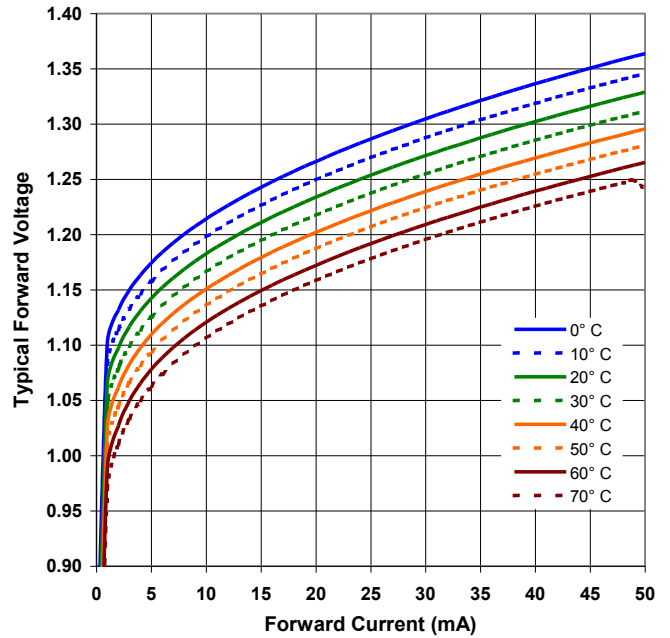

OPB730 - Output vs Forward Current vs Temp

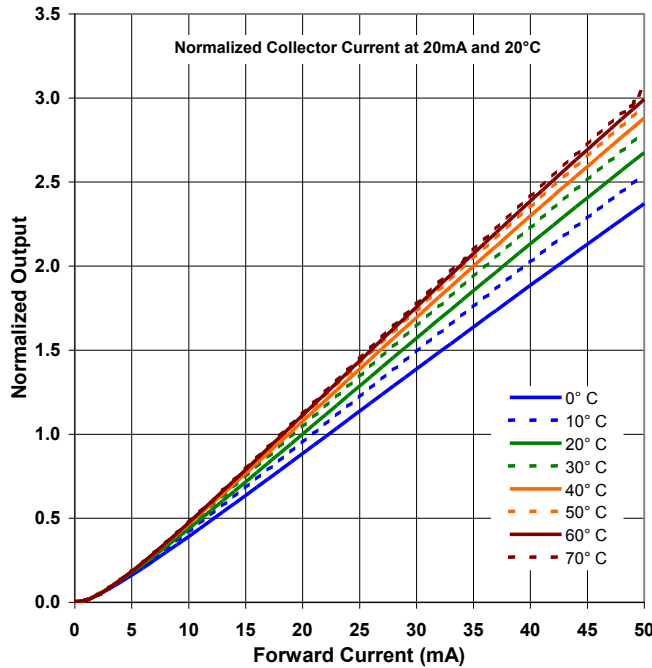

General Note
 TT Electronics reserves the right to make changes in product specification without notice or liability. All information is subject to TT Electronics' own data and is considered accurate at time of going to print.

OPTEK Technology, Inc.
 1645 Wallace Drive, Carrollton, TX 75006 | Ph: +1 972 323 2200
www.optekinc.com | www.ttelectronics.com