

SIEMENS

SIMATIC HMI

OP27, OP37 Operator Panels

Equipment Manual

Preface, Contents

		1
Part I	Introduction	▽
		2
Part II	Functions	▽
		11
Part III	Installation and Commissioning	▽
		12
Part IV	Equipment Description and Maintenance	▽
		16
		19
Part V	Appendices	▽
		A
		F

Glossary, Index

6AV3991-1AK01-0AB0

Release 05/99

Safety Guidelines

This manual contains notices which you should observe to ensure your own personal safety, as well as to protect the product and connected equipment. These notices are highlighted in the manual by a warning triangle and are marked as follows according to the level of danger:



Warning

indicates that death, severe personal injury or substantial property damage **can** result if proper precautions are not taken.



Caution

indicates that minor personal injury or property damage can result if proper precautions are not taken.

Note

draws your attention to particularly important information on the product, handling the product, or to a particular part of the documentation.

Qualified Personnel

Equipment may be commissioned and operated only by **qualified personnel**. Qualified personnel within the meaning of the safety notices in this manual are persons who are authorized to commission, ground and identify equipment, systems and circuits in accordance with safety engineering standards.

Correct Usage

Note the following:



Warning

The equipment may be used only for the applications stipulated in the catalog and in the technical description and only in conjunction with other equipment and components recommended or approved by Siemens.

Startup must not take place until it is established that the machine, which is to accommodate this component, is in conformity with the guideline 89/392/EEC.

Faultless and safe operation of the product presupposes proper transportation, proper storage, erection and installation as well as careful operation and maintenance.

Approvals

The approvals that apply to the device are detailed in the Chapter *Technical Data*.

Trademarks

SIMATIC®, ProTool/Lite®, ProTool® and ProTool/Pro® are registered trademarks of Siemens AG.

Some of the other designations used in these documents are also registered trademarks; the owner's rights may be violated if they are used by third parties for their own purposes.

Impressum

Editor and Publisher: A&D PT1

Copyright © Siemens AG 1999 All rights reserved

The reproduction, transmission or use of this document or its contents is not permitted without express written authority. Offenders will be liable for damages. All rights, including rights created by patent grant or registration of a utility model or design, are reserved.

Siemens AG,
Bereich Automation & Drives
SIMATIC Human Machine Interface
A&D PT1
Postfach 4848, D-90327 Nuernberg

Disclaimer of Liability

We have checked the contents of this manual for agreement with the hardware and software described. Since deviations cannot be precluded entirely, we cannot guarantee full agreement. However, the data in this manual are reviewed regularly and any necessary corrections included in subsequent editions. Suggestions for improvement are welcomed.

Technical data subject to change.
© Siemens AG 1999

Preface

Purpose

This equipment manual provides operation, installation, configuration and system personnel with information concerning functionality, operation and technical design of the Operator Panels OP27 and OP37.

Organization of the manual

The "OP27 , OP37 Operator Panel" equipment manual is organized into the following chapters:

Part	Chapters	Contents
I	1 - 2	Overview of features and functional scope of the OP in tabular form.
II	3 - 11	Step-by-step instructions on how to operate the OP using the standard screens.
III	12 - 15	<ul style="list-style-type: none">- Mechanical and electrical installation,- Commissioning- OP37 in DOS Mode
IV	16 - 19	Detailed information on the OP and its maintenance.
V	Appendix A - F	<ul style="list-style-type: none">- Technical data,- Interface assignments,- Hardware test,- System messages,- SIMATIC HMI documentation,- ESD guidelines,- Glossary of terms

Conventions

The following conventions are used throughout this manual:

<i>Motor off</i>	Text which appears in the OP display is presented in this typewriter font.
<i>Variable</i>	Symbolic names representing variable values on the screen are presented in this italic typewriter font
<i>Screens</i>	Functions selected by the user are presented in this standard italic font.
ESC	The labels of buttons are presented in a different font.

History

The various releases of the equipment manual correspond to the following firmware and versions:

Release	Remarks	ProTool Version
09/96	First release of the OP37 equipment manual	V 2.5 and later
11/97	Inclusion of the OP27 and revision according to the new documentation concept	V 4.0 and later
05/99	New standard screen for printing messages; troubleshooting	V 5.0 and later

Other support

In the case of technical queries, please contact your local Siemens in the subsidiaries and branches responsible for your area. Refer to Appendix E of this equipment manual for a list of addresses.

SIMATIC Customer Support Hotline

Available worldwide, at all times:

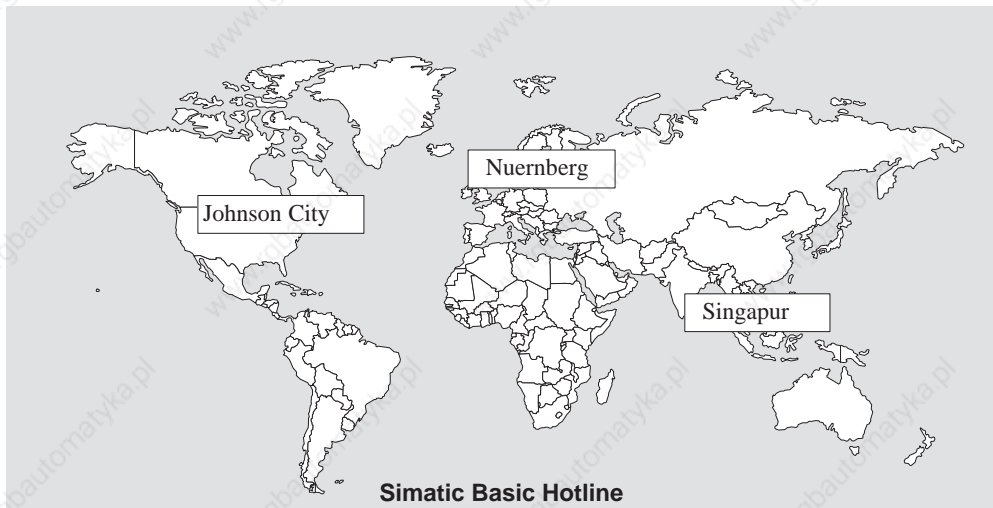
**Nuernberg****SIMATIC BASIC Hotline**

Local time:
Mon - Fri 8:00 to 18:00

Telephone:
+49 (911) 895-7000

Fax: +49 (911) 895-7002

E-Mail: simatic.support@nbgm.siemens.de

SIMATIC Premium Hotline

(charged, only with
SIMATIC Card)

Time:
Mon - Fri 0:00 to 24:00

Telephone:
+49 (911) 895-7777

Fax:
+49 (911) 895-7001

Johnson City**SIMATIC BASIC Hotline**

Local time:
Mon - Fri 8:00 to 17:00

Telephone:
+1 423 461-2522

Fax: +1 423 461-2231

E-Mail: simatic.hotline@sea.siemens.com

Singapur**SIMATIC BASIC Hotline**

Local time:
Mon - Fri 8:00 to 17:30

Telephone:
+65 740-7000

Fax: +65 740-7001

E-Mail: simatic@singnet.com.sg

SIMATIC Customer Online Services

SIMATIC Customer Support offers comprehensive additional information concerning SIMATIC products through its Online services as follows:

- Up-to-date general information is provided
 - in **Internet** under <http://www.ad.siemens.de/simatic>
 - via **Fax-Polling** under 08765-93 02 77 95 00
- Up-to-date product information and downloads for practical use can be found:
 - in **Internet** under <http://www.ad.siemens.de/support/html-00/>
 - via the **Bulletin Board System (BBS)** in Nürnberg (*SIMATIC Customer Support Mailbox*) under +49 (911) 895-7100

In order to contact the mailbox, please use a modem with up to 28.8 kBaud (V.34) capacity. Set the parameters as follows: 8, N, 1, ANSI, or dial for connection via ISDN (x.75, 64 kBit).

Abbreviations

The abbreviations used in this equipment manual have the following meaning:

AM	Alarm Message
ANSI	American National Standards Institute
AS511	Protocol of the PU interface to SIMATIC S5
ASCII	American Standard Code for Information Interchange
AU	Automation Unit
CPI	Control Panel Interface
CPU	Central Processing Unit
DIL	Dual-In-Line (package)
DP	Decentral Periphery
DRAM	Dynamic Random Access Memory
DKM	Direct Key Module
EM	Event Message
ESD	Electrostatic Sensitive Device
JEIDA	Japan Electronic Industry Development Association
LCD	Liquid Crystal Display
LED	Light-Emitting Diode
MPI	Multipoint Interface (SIMATIC S7)
PC	Personal Computer
PCMCIA	Personal Computer Memory Card International Association
PLC	Programmable Logic Controller
PU	Programming Unit
PPI	Point to Point Interface (SIMATIC S7)
SRAM	Static Random Access Memory
STN	Super Twisted Nematic
TFT	Thin Film Transistor
TP	Touch Panel
TTL	Transistor-Transistor Logic

Contents

Part I: Introduction

1	Product Description	1-1
1.1	Visualizing and Controlling Processes	1-3
1.2	The OPs at a Glance	1-6
2	Functionalty	2-1

Part II: Functions

3	General Operation	3-1
3.1	Changing the Active Window	3-3
3.2	Integrated Keyboard	3-4
3.3	Enter Values	3-8
3.3.1	Entering Numeric Values	3-9
3.3.2	Entering Alphanumeric Values	3-10
3.3.3	Entering Symbolic Values	3-11
3.4	Help Text	3-14
4	Screens	4-1
4.1	Screen Elements	4-1
4.2	Standard Screens	4-3
5	Password Protection	5-1
5.1	Password Level and Access Permissions	5-1
5.2	Logging In and Out on the OP	5-3
5.3	Password Management	5-4
6	Messages	6-1
6.1	Types of Message	6-2
6.1.1	Event Messages and Alarm Messages	6-2
6.1.2	Alarm Messages	6-6
6.1.3	System Messages	6-7
6.2	Displaying Messages	6-8
6.3	Deleting Messages	6-11
6.4	Printing Messages	6-13

6.5	Standard Screens for Messages	6-15
6.5.1	“Edit Message” Standard Screen	6-15
6.5.2	“Output Messages” Standard Screen	6-17
6.5.3	“System Settings” Standard Screen	6-19
7	Printing	7-1
8	Recipes	8-1
8.1	Standard Screens for Recipes	8-3
8.1.1	Creating, Editing and Saving Data Records	8-8
8.1.2	Transferring Data Records	8-13
8.2	Record Sets	8-15
9	Storing and Loading Data	9-1
9.1	Data Types, Data Media and Storage Principle	9-1
9.2	Clear/Initialize Storage Medium	9-3
9.3	Backup/Restore	9-5
10	Status/Force Tag Using the OP	10-1
10.1	Status Tag	10-2
10.2	Force Tag	10-5
11	System Settings	11-1
11.1	Setting an Operating Mode	11-3
11.2	Blanking the Screen	11-4
11.3	Other Settings	11-5

Part III: Installation and Commissioning

12	Mechanical Installation	12-1
12.1	Installing the OP27	12-2
12.2	Installing the OP37	12-3
13	Electrical Installation	13-1
13.1	Power Supply and Relay Contacts	13-3
13.1.1	Connecting the Configuration Computer	13-4
13.1.2	Connecting the PLC	13-5
13.1.3	Connecting a Printer	13-7
14	Commissioning	14-1
14.1	Initial Startup	14-2
14.2	Recommissioning	14-3
14.3	Startup Behavior	14-6
14.4	Testing a Configuration in OFFLINE Mode	14-7
14.5	Testing the Configuration in Conjunction with the PLC	14-8

15	OP37 in DOS Mode	15-1
15.1	Specific OP37 Settings in BIOS Setup	15-2
15.2	Changing Between OP and DOS Modes	15-4

Part IV: Equipment Description and Maintenance

16	OP27 Unit Description	16-1
16.1	Dimensions	16-1
16.2	Operating and Display Elements	16-2
16.3	Connection Elements	16-3
16.4	Communication Options	16-4
16.5	Labeling Function Keys	16-5
17	OP37 Unit Description	17-1
17.1	Dimensions	17-2
17.2	Operating and Display Elements	17-3
17.3	Connection Elements	17-4
17.4	Communication Options	17-5
17.5	Labeling Function Keys	17-6
18	Options	18-1
18.1	AT Expansion Slot (OP37 only)	18-2
18.2	Direct Key Module	18-4
18.2.1	Installing the Direct Key Module	18-5
18.2.2	Connection and Adjusting Elements	18-7
18.3	Control Panel Interface	18-10
18.3.1	Installing the Control Panel Interface	18-11
18.3.2	Connection and Adjusting Elements	18-14
19	Maintenance/Upkeep	19-1
19.1	Cleaning the Screen and Keyboard Overlay	19-1
19.2	Replacing the Backup Battery	19-2
19.3	Other Maintenance Work on OP27	19-4
19.3.1	Replacing the Display on the OP27M	19-5
19.3.2	Replacing the Back-Lighting of the OP27C	19-7
19.4	Other Maintenance Work on OP37	19-10
19.4.1	Opening the OP37 Housing	19-10
19.4.2	Replacing the Back-Lighting of the OP37	19-12
19.4.3	Replacing the Floppy Disk Drive	19-14

Part V: Appendix

A	Technical Data	A-1
B	Interface Assignments	B-1
C	Test Functions	C-1
	C.1 Hardware Test	C-1
	C.1.1 Individual Tests	C-3
	C.1.2 Test Adapters	C-6
D	System Messages	D-1
E	SIMATIC HMI Documentation	E-1
F	ESD Guidelines	F-1

Part I

INTRODUCTION

- 1 Product Description**
- 2 Functionality**

Product Description

Use of OP27 and OP37

The implementation of Operator Panels OP27 and OP37 enables operating statuses, current process values and faults in respect of a connected PLC to be graphically represented and the machine or system to be monitored easily operated. In order to do this, the OPs are equipped with a large number of standard functions. The method of display and operation of the OPs can be customized using the ProTool configuration software to achieve optimum results in respect of process requirements.

The OPs can be used to

- control and monitor the process by means of the menu system. In this way, setpoints can be entered, for example, in the form of value input or pressing configured function keys or to control positioning elements;
- display processes, machines and systems on full-graphic and semi-graphic screens;
- visualize event messages, alarm messages and process variables, such as output fields, bar graphs, trends or status display;
- intervene directly in the process by means of the integrated keyboard.

Installation possibilities

The OPs are installation units for use directly at the machine location. The degree of protection is high (front panel IP65), so the devices are suitable for use in hostile industrial environments.

Installation locations for the units may be as follows:

OP27	OP37
Panels/Consoles	Panels/Consoles
–	19" panels/racks

Set up data areas

Before commissioning the OPs, they must be prepared for the task of visualizing data from the PLC. To do this, data areas must be created in the PLC's memory in the configuration; the data areas are used by the OP to communicate with the PLC.

Configuration using ProTool

Graphics and texts to be displayed on the OP must be created beforehand using a configuration computer (PC or PU) implementing the configuration software ProTool. Before downloading the configuration data to the OP, connect the configuration computer to the OP (refer to the configuration phase in Figure 1-1).

Once the configuration has been successfully downloaded, disconnect the configuration computer and then connect the OP to the PLC. The OP now communicates with the PLC and reacts to program execution on the PLC in accordance with the configured requirements (refer to the process control phase in Figure 1-1).

Figure 1-1 outlines the configuration and process control phase.

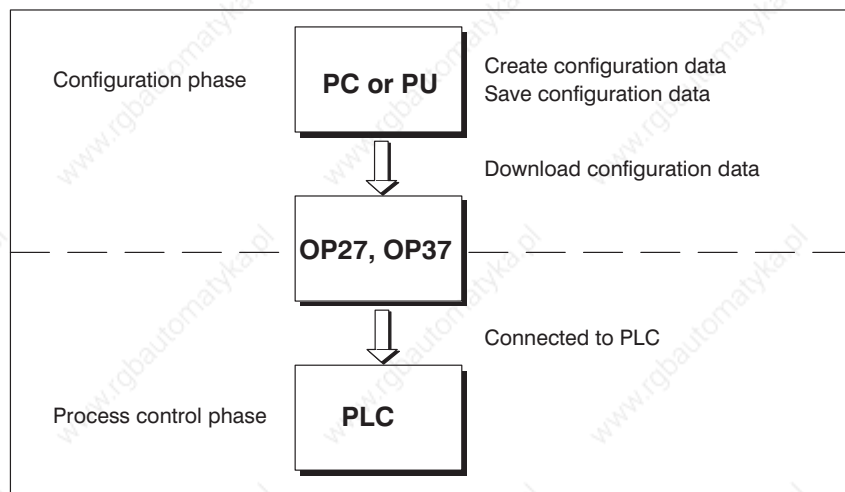

Figure 1-1 Configuration and process control phase

Further information

Information regarding configuration of the OP is provided in the *User's Guide, ProTool Configuring Graphics Displays*. The *Communication User's Manual* provides information on the connection between the OP and PLC.

1.1 Visualizing and Controlling Processes

Display and operating functions

The basic functions of the OP27 und OP37 Operator Panels are the visualization of process statuses and the operation of processes. The following display and operating functions can be configured:

- screens
- input/output of process values
- bar graphs and trends
- text or graphics lists
- messages
- logging
- print
- text
- help text
- recipes
- multiple languages
- password protection
- functions for function keys and soft keys.

Screens

Logically related process data from the PLC can be compiled, displayed on a screen and individual parts of it modified. Screens may contain soft keys, graphics, texts and values.

The OPs can display machines and systems as **full-graphics screens**. This makes it easier for the operator to find his way around.

Input / Output

Numeric, alphanumeric or symbolic values can be entered in input fields on the OP which are then transferred to the PLC. Current values of the PLC are displayed in output fields in alphanumeric form.

Bar graphs and trend curves

Current process values can be output as numeric values, symbolic text, symbolic graphs or in the form of bar graphs and trend curves.

- **Bar graphs**
represent a value as a rectangular area. Bar graphs can be used to display fill levels or quantities, for example.
- **Trends**
display a value continuously. This display mode is useful when displaying values that vary with time, variations in temperature or pressure, for example.

Symbol lists

Various graphic elements (bitmaps) or texts can be called into the display depending on the process status. In this way, for example, the current setting of a valve can be visualized on the OP screen by means of symbolic graphics, or text can be modified according to the situation.

Messages

Messages are displayed on the OP in plain text. The message text may also contain current process values. Incoming messages are stored in a message buffer together with their date and time.

- **Event messages**
provide information and operating notes on current processes or machine states, for example
Motor running at 3000 revs.
- **Alarm messages**
provide information on critical machine states, for example
Motor speed too high.

Alarm messages must be acknowledged on account of their urgency.

Messages are classified as event messages or alarm messages during configuration.

Recording

All message events can be additionally recorded by being printed out in online mode on a connected printer. Messages which have accumulated in the event and alarm buffers can also be printed out.

Print

It is possible to print the current status of a screen by pressing PRINT SCREEN. It is possible to configure a function which enables up to 20 screens to be printed simultaneously.

Texts

Texts identify individual parts of the screen in order to be able to assign the fields displayed to the process.

Help texts

Help texts represent additional information and notes for the operator which can be configured in respect of the screens, input fields and messages. The help text relating to an alarm message may display information on the cause of a malfunction and how to clear it.

Recipe

Complete machine data records can be stored as recipes in the OP. A recipe defines the data structure in a configuration. Data is assigned to the configured structure on the OP.

The purpose of recipes is to transfer several items of data collectively to the PLC. In this respect, it is immaterial whether actual recipes, specifications of quantities, distances to be traversed or temperature variations are involved.

Multiple languages

Message texts, texts in screens, help texts and system messages can be stored in three languages simultaneously in the OP and selected online.

Password protection

The password protection feature prevents unauthorized operation of the OP. Different passwords can be assigned to different users or user groups, thus authorizing or prohibiting access to specific control functions by assigning different password levels.

**Functions for
function keys and
soft keys**

The OPs are equipped with a range of function keys which can be assigned operating functions, such as message logging on/off, screen selection and print screen during configuration. The function keys may be assigned globally or locally. Globally means that the assignment applies to the whole configuration. Locally means that the assignment applies only to a single screen. A function key whose assignment changes from one screen entry to another is known as a soft key.

1.2 The OPs at a Glance

The following unit models are available:

- OP27M with STN monochrome display for screens with gray shading
- OP27C with STN color display
- OP37 with STN color display
- OP37 with TFT color display

Hardware		OP27M	OP27C	OP37
Display	Monochrome display	✓	–	
	Color display	–	✓	
	Type	STN LCD		STN LCD TFT LCD
	Resolution (pixels)	320 x 240		640 x 480
	Colors	8 gray scales	8	
Backlighting		✓		
Membrane keyboard	System keys with permanent functions	24 (4 with LEDs)	32 (4 with LEDs)	
	Function keys with configurable functions (can also be used as DP direct keys)	24 (18 with LEDs)	36 (28 with LEDs)	
	For use as soft keys	14	20	
	Key labeling for function keys	System-specific labeling using labeling strips		

Hardware		OP27M	OP27C	OP37
Interfaces	Serial communications port for connection to PLC, PC/PU, printer	2 x RS232/TTY (active/passive) 1 x RS422/RS485		2 x RS232/TTY (active/passive) 1 x RS422/RS485 1 x TTY (passive) / RS422/RS485
	Parallel interface for connecting a printer	-		1 x TTL (Centronics)
Processor	Type	80486		Pentium
	Clock rate (MHz)	33		100
Memory	Flash EPROM for firmware and user data (MB)	1	2	
	DRAM main memory (MB)	2	4	8
	Buffered SRAM (KB)	128		

Hardware		OP27M	OP27C	OP37
Special features	Hardware clock (battery-backed)	✓		
	Relay output for temperature monitoring	-		✓
	Use of an external MF2 keyboard	-		✓ ¹⁾
	Use of an external PS2 keyboard	-		✓ ¹⁾
	Use of an external PS2 mouse	-		✓ ²⁾
	DOS mode	-		✓
	Module slot for PCMCIA/ JEIDA cards	1		2 (Slot A and Slot B) ³⁾
¹⁾ Can only be used for BIOS setup and in DOS mode ²⁾ Can only be used in DOS mode ³⁾ Slot A can only be used for DOS mode, Slot B for OP and DOS modes				

Options		OP27M	OP27C	OP37
Direct key module	Digital outputs, triggered optionally by means of <ul style="list-style-type: none"> • direct keys • configurable outputs 			
		8		12
		8		16
Control Panel Interface⁴⁾	Digital inputs/outputs	16 or 32		

Product Description

Options		OP27M	OP27C	OP37
Floppy disk drive	Storage capacity	–	–	1.44 MB
Hard disk⁵⁾	Storage capacity	–	–	≥ 2 GB
AT extension slot⁵⁾	Plug-in $\frac{2}{3}$ length, 16-bit AT cards	–	–	2
4) Can only be used in conjunction with SIMATIC S7 PLC				
5) Can only be used in DOS mode				

2

Functionalty

The following table presents an overview of the functions of operator panels OP27 and OP37. The values specified are the maximum values that can be managed by the respective OP. The values are limited by the size of the working memory.

Functions		OP27	OP37
Event messages	Number	2000	
	Display	in message line/message window	
	View all pending messages	in message page	
	Length message text per line	35 characters	70 characters
	Lines per message	2	1
	Process values in message text	8	
Alarm messages	Number	2000	
	Display	in message line/message window	
	Display type	First value/last value, selectable	
	View all pending messages	in message page	
	Length message text per line	35 characters	70 characters
	Lines per message	2	1
	Process values in message text	8	
	Acknowledge individual alarm messages	✓	
	Acknowledge several alarm messages simultaneously	16 acknowledgment groups	
Message logging	Output to printer	✓	
Message archive	Capacity	512 message events	
	View buffered event/alarm messages	✓	
	Delete	✓	
	Buffer overflow warning	✓	
	Automatic printout on buffer overflow	✓	
	Message events queued simultaneously (max.)		
• Event messages	500		
or			
• Alarm messages	250		

Functions		OP27	OP37
Message acquisition	Time of occurrence	Date and time	
	Message events	Arrive, depart, acknowledge	
Screens	View	✓	
	Printout	✓	
	Static screen elements	Pixel graphics Text Character graphics	
	Input/output elements	Numeric/alphanumeric input fields Numeric/alphanumeric output fields Combined input/output fields Symbolic text input fields Symbolic text/graphics output fields Bar graphs Trends	
	Operator prompting	Icons for soft key functions	
	Fixed window	✓	
Limit value monitoring	Inputs/outputs	✓	
Conversion functions	Inputs/outputs	✓	
Text attributes	Display	Flashing, inverse, underscore	
	Printer (messages)	Bold, italic, underscore	
Help text	Lines/characters	7/35	
	For messages	✓	
	For input fields	✓	
	For screens	✓	
Print functions	Hardcopy of screen contents (screen dump)		
	• character mode (ASCII)	✓	
	• graphics mode	✓	
	Direct message logging	✓	
Print screen lists in	• character mode (ASCII)	✓	
	• graphics mode	✓	
Password protection	Number of passwords	50	
	Password levels	10 (0..9)	

Functions		OP27	OP37
Recipes	Number	255	
	Data records per recipe	500	
	Entries per data record	500 3000 (SIMATIC S7)	
	Save (create) data records	PLC/OP → data medium	
	Load data records	Data medium → OP/PLC	
	Delete data records	On data medium	
	Modify (edit) data records	On data medium	
	Transfer current values	PLC → OP OP → PLC	
	Transfer data records	Data medium → OP OP → Data medium	
	Record sets	✓	
Backup	Backup/Restore for memory card	✓	
Online language change	Number of languages	3	
	Loadable character sets per language	3	
	Language-independent character set (incl. character-graphic characters)	1	
	Character size in pixels	8 x 8 to 64 x 64	
PU functions (Status/Control Tag)	SIMATIC S5	✓	
	SIMATIC S7	✓	
Display	Blank screen	✓	
	Contrast	✓	✓ (C-STN display only)
DP direct keys¹⁾	Number of input	24	36
	Number of outputs (LEDs)	18	28
	Inputs/outputs with Control Panel Interface upgradeable by	16 or 32	
¹⁾ = Configuration, refer to Communication User's Manual			

Functions		OP27	OP37
Communication	SIMATIC S5 – AS511 – FAP – PROFIBUS-DP		✓ ✓ ✓
	SIMATIC S7/M7 – PPI (S7 driver) – MPI (S7 driver) – PROFIBUS-DP (S7 driver)		✓ ✓ ✓
	SIMATIC 500/505 – NITP		✓
	Block driver – Free Serial		✓
	Loadable NATIVE drivers (optional) – AEG/Modicon (Modbus) – Allen Bradley (DF1) – Mitsubishi (FX) – Omron – Telemecanique (Adjust, Uni-Telway)		✓ ✓ ✓ ✓ ✓

FUNCTIONS

- 3 General Operation**
- 4 Screens**
- 5 Password Protection**
- 6 Messages**
- 7 Printing**
- 8 Recipes**
- 9 Storing and Loading Data**
- 10 Status/Control Tag with the OP**
- 11 System Settings**

Part II

General Operation

Operating concept It is possible to observe the operating status of the machine or system being monitored using the OP screen and directly intervene in the process running via the OP keyboard.

Screen partitioning A screen occupies the entire display. An example of screen partitioning is illustrated in Figure 3-1.

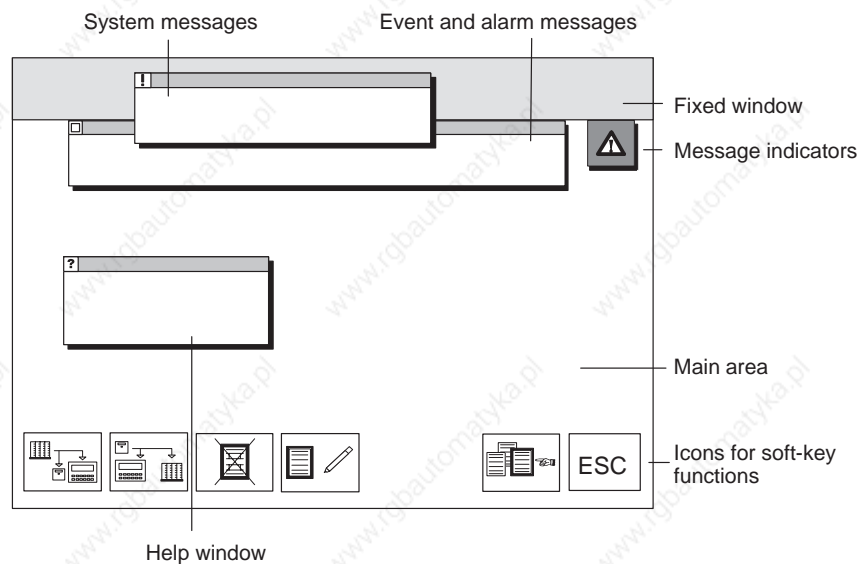

Figure 3-1 Screen partitioning on the OP (example OP37)

Fixed window The fixed window can be used to display important process magnitudes or date and time, since the contents are not affected by the screen currently open.

Main area The main area comprises the entire display. It is superimposed by all other areas (fixed window, message window etc.). The main area contains the current contents of the screen that is currently open.

Icons Icons are used as symbols of specific screen functions. Icons are located above or next to soft key function keys in order to describe the functionality of the key. The configured function is triggered after pressing the function key.

Message indicator

The message indicator indicates that alarm messages have been received.

Not flashing: Alarm messages have been received.

Flashing: Alarm messages have been received which have not been acknowledged.

Window

Message window:

By default, the window for system messages is displayed in the top part of the screen area. If another window occupies this position on the OP37, the system message window appears at a vacant position. The locations of the event message and alarm message windows can be configured.

Help window:

The window for displaying configured help texts appears at the bottom left of the screen.

3.1 Changing the Active Window

Overview

It is possible to have several windows open at the same time on the OP. It is possible to switch between the following windows:

- main screen
- fixed window
- message line/message window

Window selection

Use the middle cursor key to switch between the various windows.

Key	Description
	The cursor moves from one window to the next each time the key is pressed.

The window in which the cursor is located is the active window, i.e. the one in which entries and operator inputs can be performed. It is not possible to access windows which do not have input fields.

Static and dynamic windows

The OP27 and OP37 react differently in respect of operation of an input field when a window is open::

- OP27: The positions of windows displayed are static due to the small size of the display; meaning that if an alarm message or pop-up window is displayed, the input field beneath it cannot be operated. Generally speaking, no input is possible until all windows have been closed.
- OP37: When a dynamic window position is configured for the OP37, any window being displayed automatically jumps to a position in which the input field and the cursor are not concealed. In this way, input is always possible, regardless of display contents.

3.2 Integrated Keyboard

Keypads

The OP keyboard consists of two functional keypads:

- the function keys/soft keys and
- the system keys.

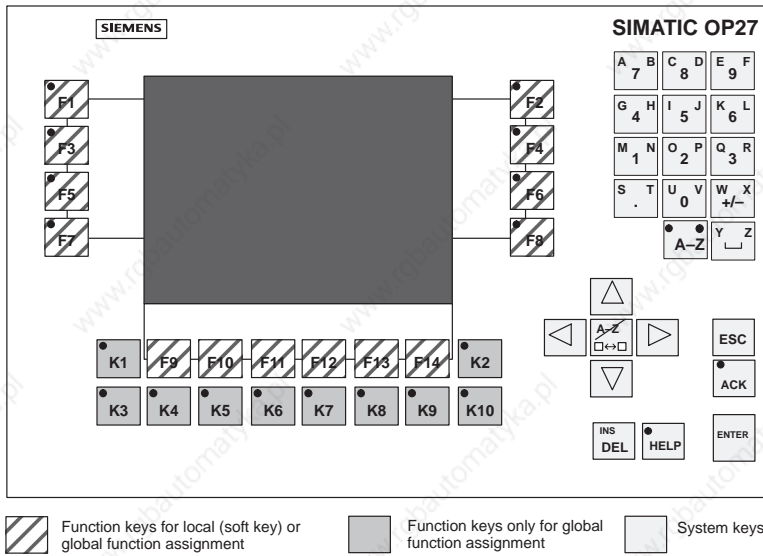

Figure 3-2 Arrangement of keypads on the OP27

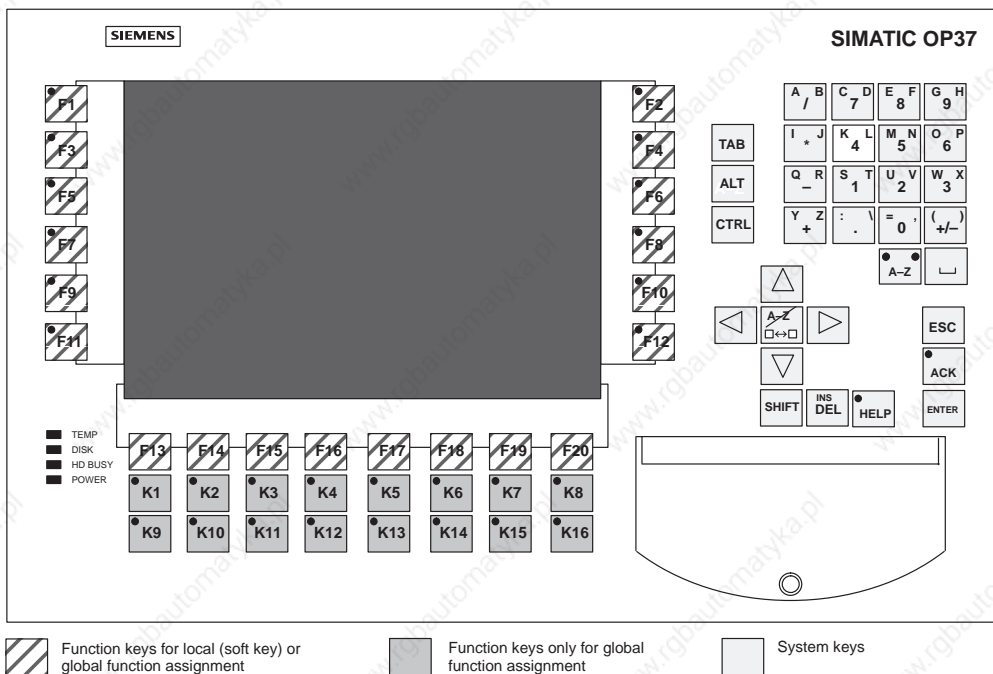

Figure 3-3 Arrangement of keypads on the OP37

Function keys for global function assignment

A “function key for global function assignment” always triggers the same action on the OP or PLC, regardless of the screen currently open (global significance on OP). These actions can be:

- opening a screen
- displaying current alarm messages
- initiating a screen printout (Print Screen)
- displaying the time window.

The following keys can be assigned globally:

- on the OP27 → K1 to K10 and F1 to F14 (Figure 3-2),
- on the OP37 → K1 to K16 and F1 to F20 (Figure 3-3).

Function keys for local function assignment (soft keys)

A “function key for local function assignment”, referred to as a “soft key”, means that the respective function keys have a significance only related to a specific screen (local).



The function of a soft key may differ from screen to screen. The function of a soft key is displayed in the corresponding icon on the border of the current screen.





The following keys can be assigned locally:

- on the OP27 → F1 to F14 (Figure 3-2),
- on the OP37 → F1 to F20 (Figure 3-3).

System keys

The system keys are used to enter input on the OP. The OP system keys have the following functions:

Key	Function	Purpose
	SHIFT	SHIFT is used to switch the input keys from numeric to alphanumeric assignment. The key has two LEDs for indicating its current status: <ul style="list-style-type: none"> • If neither of the LEDs is on, numeric assignment of the input keys is active. Pressing the key once switches the input keys to alphanumeric assignment. • When the left or right LED is on, the left or right alphanumeric assignment of the input keys is active. The alphanumeric assignment of the input keys changes from left to right and back again every time the key is pressed.
	Switch/ Change Window	This key: <ul style="list-style-type: none"> • changes the active window. • switches back from alphanumeric to numeric assignment of the input keys.

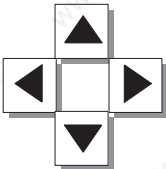

















Key	Function	Purpose
	Activate Edit mode, insert/delete characters (Insert/Delete)	This key can be used to: <ul style="list-style-type: none"> activate Edit mode insert and/or delete individual characters Characters are deleted when numeric keyboard assignment is active. To insert characters, switch to alphanumeric keyboard assignment using SHIFT.
	Cancel (Escape)	Actions which have been initiated can be stopped by pressing the key; e.g. <ul style="list-style-type: none"> characters which have already been entered as input for a value are deleted a pending system message is deleted.
	Acknowledge	This key is used to acknowledge the alarm message currently being displayed or all messages within an acknowledgment group. The LED remains on until all alarm messages have been acknowledged.
	Display help text (Help)	HELP opens a window with Help information on the object selected – for example, message or input field. The LED goes on when Help is available for the object selected. Close the Help window by pressing any key.
	Enter	Use ENTER TO <ul style="list-style-type: none"> apply and terminate input open a pop-up window for symbolic input.
	Move cursor	Use the ARROW keys to: <ul style="list-style-type: none"> move the cursor to the individual input fields on a screen move the cursor within an input field select an entry in the message buffer select a value in a pop-up window.

Note

The keys TAB, ALT and CTRL only have a function in DOS mode for the OP37.

Key combinations





The following table indicates key combinations which can be used to define settings on the OP27 and OP37.

Key Combination	OP27	OP37
 + 	Display contrast is increased.	Display contrast is increased. (STN displays only).
 + 	Display contrast is reduced.	Display contrast is reduced. (STN displays only).
Key combinations after OP startup		
 +  	Loading of firmware and configuration is aborted and the system switches to Download mode. It is possible to quit Download mode provided data is not being downloaded from the PC or PU to the OP.	
 + 	Toggle between Online and Offline modes .	
 +  + 	All the data in the OP FLASH is deleted. This includes the firmware the configuration and where available data records. Confirm by pressing DEL. The OP enters Download mode.	
 +  + 	-	Toggle between OP mode and DOS mode.
 +  + 	The selection screen for the hardware test is opened.	

3.3 Enter values

Procedure

Use the input fields on the OP to enter values which can then be downloaded to the PLC. Carry out the following steps to do this:

Step	Action
1	First, call the screen required, as described in Section 4.1.
2	Use the cursor keys to position the cursor on the necessary input field.
3	Enter the appropriate value. Depending on how the field is configured, values can be entered as <ul style="list-style-type: none"> • Entering Numeric Values (refer to Chapter 3.3.1), • Entering Alphanumeric Values (refer to Chapter 3.3.2), • Entering Symbolic Values (refer to Chapter 3.3.3).
4	<p>Confirm the entry with the system key </p> <p>Cancel incorrect input by pressing the system key. </p> <p>The original value is then entered automatically in the field. Repeat input using the correct value.</p> <p>Correct any incorrect input by inserting or deleting individual characters at the cursor position by pressing </p> <p>Confirm the correction by pressing the system key </p>

3.3.1 Entering Numeric Values

Input using the system keys

Numeric values are entered character for character using the input keys on the system keyboard. If a value is already present in the field, it disappears completely from the field when the first character is entered. After starting entering input, it is not possible to exit from the field concerned until the input is either confirmed or cancelled.

Possible values

The following values can be entered in numeric input fields:

Possible values	Keys	Description
Decimal value		The input keys of the system keypad are to be found in the numeric key assignment.
Hex value		To enter the characters A to F, switch to the input keys of the alphanumeric key assignment.
Digital value		The input keys are to be found in the numeric key assignment.

Right justified input

Input in numeric fields is generally aligned to the right. Digits entered move to the left (pocket calculator format).

Limit values check







Limit values can be configured for numeric input. A limit value check is performed in these fields. Entered values are only applied if they are within the configured limits. If a value entered is outside these limits, a system message is issued. After confirming the message, the original input value is transferred into the field.

Decimal places

If a field is configured with a specific number of **decimal places**, too many decimal places are ignored and too few filled with 0s following confirmation of the input.

Correct input

In the case of an incorrect entry, the following possibilities are available with which to correct it before confirmation. Call in Edit mode.

Incorrect Input	Action	Using Key
Incorrect digit	Position the cursor on the digit and overwrite it. The cursor remains at this position.	 
One digit too many	Delete the digit at the cursor position. The gap is closed from the left.	
One digit too few	<ol style="list-style-type: none"> Switch to alphanumeric key assignment. Insert a blank at the cursor position. Input moves to the left of the cursor position. Revert to the numeric input key assignment. Overwrite the space. 	  







3.3.2 Entering Alphanumeric Values



Input using the system keys

Alphanumeric values are entered character for character using the system keyboard input keys.

Alphanumeric input can be used to enter digits and letters in any order. Spaces are also allowed.

Carry out the following steps to enter alphanumeric values:

Step	Keys	Description
1	 ...   , 	The input keys of the system keypad are to be found in the numeric key assignment.
	  ... 	Switch to the alphanumeric key assignment.





Step		Keys	Description
2	Apply input or		<ul style="list-style-type: none"> The input becomes valid. Revert from the alphanumeric to the numeric key assignment.
	Cancel input		<ul style="list-style-type: none"> The input cursor is deleted. Revert from the alphanumeric to the numeric keyboard assignment. The "old" input becomes valid once more.

Left justified input

Input is generally aligned to the left in alphanumeric fields. The cursor moves one position to the right following each entry. If the maximum number of places is exceeded, the OP overwrites the last input with each subsequent entry.

Correct input

In the case of an incorrect entry, the following possibilities are available with which to correct it before confirmation. Call in Edit mode.

Incorrect Input	Action	Using Keys
Incorrect character	Position the cursor on the character and overwrite it. The cursor moves one position to the right after the character has been overwritten.	 
One character too many	Delete the character at the cursor position. The gap is closed from the right.	
One character too few	<ol style="list-style-type: none"> Switch to Alpha mode. Insert a blank at the cursor position. The input moves to the right of the cursor position. Overwrite the space. 	 

Example of alphanumeric input

Carry out the following steps to enter the name "Valve 05":









Key	Display
,	
,	
,	
,	
,	
,	
	Apply input

3.3.3 Entering Symbolic Values

Input

Symbolic values are entered via a pop-up menu, which provides items for selection.

Carry out the following steps to enter symbolic values:

Step	Keys	Description
1	Open pop-up window 	
2	Select entry     	Move cursor one line at a time Move the cursor page by page (OP37 only)
3	Apply input or Cancel input  	<ul style="list-style-type: none"> The value associated with the selected entry becomes valid. The pop-up window is closed. The "old" value becomes valid once more. The pop-up window is closed.

Example

Proceed as follows to activate Mixer 3 via a symbolic input.



The pop-up window is displayed.

Mixer 3 "Off" is selected



Select Mixer 3 "On"

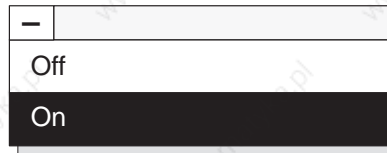

The input selected is applied

3.4 Help Text

Purpose

Help texts are created during configuration using ProTool and provide additional information on the respective subject in the language selected on the OP. Help texts can be configured for

- event and alarm messages
- screens
- input and combined input/output fields.

Help texts can provide information to the user on the permissible range of values for the input field selected, for instance. Help texts referring to an alarm message may, for example, contain supplementary details on possible causes and on rectifying the problem.

Calling help texts

The help text configured for messages and input fields can be called to the screen. Carry out the following steps to do this.



Step	Action
1	<p>In order to call in help text for a message in the message window or message line, position the cursor on the message by pressing:</p>  <p>In order to call in help text concerning a message into a message page, in respect of a message in the message buffer or an input field in a screen, position the cursor on the corresponding message or input field using:</p> 
2	<p>Press the system key illustrated on the right. The Help information configured for a selected message or selected input field is displayed.</p>  <p>If work is currently being carried out involving a screen and the key is pressed a second time, the help text for the entire screen is displayed.</p>

Figure 3-4 depicts an example of an output window.

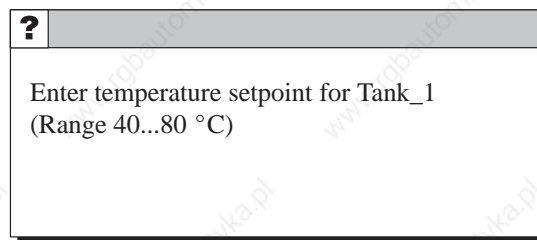

Figure 3-4 Window with help text (example)

Screens

Process control and monitoring

Processes (e.g. a processing machine or mixing station) are displayed on and can be influenced by screens which appear on the OP. These screens are created during configuration with ProTool for specific applications.

Logically related process values are compiled on screens and thus provide an overview of a process or a system. Apart from this graphic mapping of processes, screens provide an opportunity of entering new process values and, thus, of controlling the process.

4.1 Screen Elements

Screen sections

Various screen elements are used to display and control screens:

- text
- graphics
- character graphics
- input fields for process values
- output fields for process values
- combined input/output fields
- bar graphs
- trends
- text or graphic lists
- icons.

The different screen elements are presented on the basis of the following examples.

Example

Part of the contents of various tanks are filled and mixed in a mixing unit of a fruit juice mixing system. The liquid levels in the tanks and in the mixer are displayed. The intake valves can be opened and closed by means of operator inputs on the OP. The motor for the mixer can be turned on and off in a similar manner.

Figure 4-1 illustrates how the configured screen might appear on the OP.

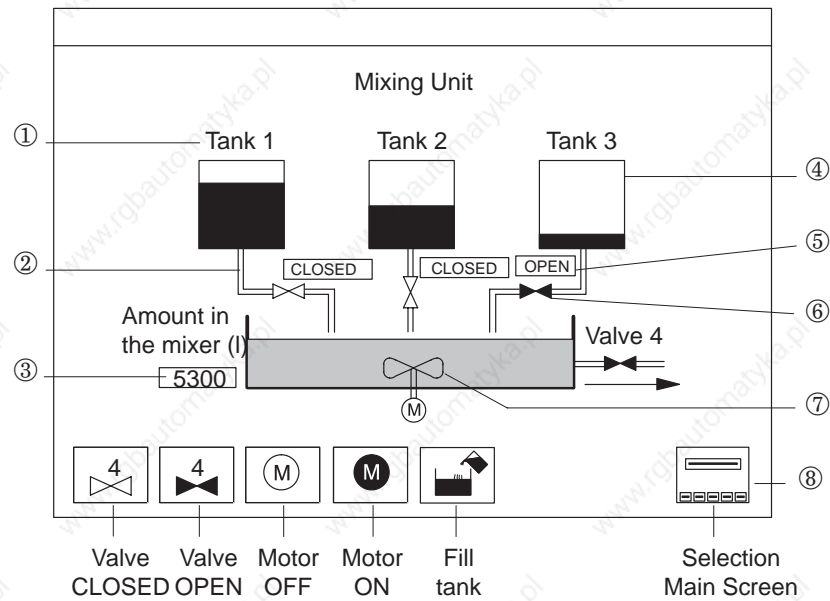

- ① Text
- ② Character graphics
- ③ Numeric output field
- ④ Bar graph (tank load)
- ⑤ Symbolic input field for opening and closing the valve
- ⑥ Symbolic graphic indicates the status of the valve (open/closed)
- ⑦ Graphic
- ⑧ Icons for soft-key functions

Figure 4-1 Configured screen for a mixing unit (example)

Selecting a screen

Screens can be viewed, processed and printed via the OP. Before these actions can be performed, however, the screen has to be selected. Select a screen by means of a

- **Function key**
Pressing a function key opens the screen assigned to it in the configuration.
- **Input field**
Enter the number of the screen to be opened in the input field.
- **PLC job**
This is a special application provided to the operator. The PLC calls a screen on the OP depending on the state of the process or the system, thus specifying the procedure for the operator to follow.

4.2 Standard Screens

Purpose

A standard configuration containing standard screens is supplied with the configuration software ProTool for the OP27 and OP37. The functions needed for basic operation of the OP have been implemented on the screens. They include, for example, Call Message Buffer, Edit Passwords and Change Parameters Online. The individual functions are described in this manual on the basis of the standard screens.

Process-specific implementation, such as event messages or screens for the process, are not included in the standard screens.

Main screen

The standard screens are called in via soft keys on the main screen. Figure 4-2 provides an example of the main screen of the OP37.

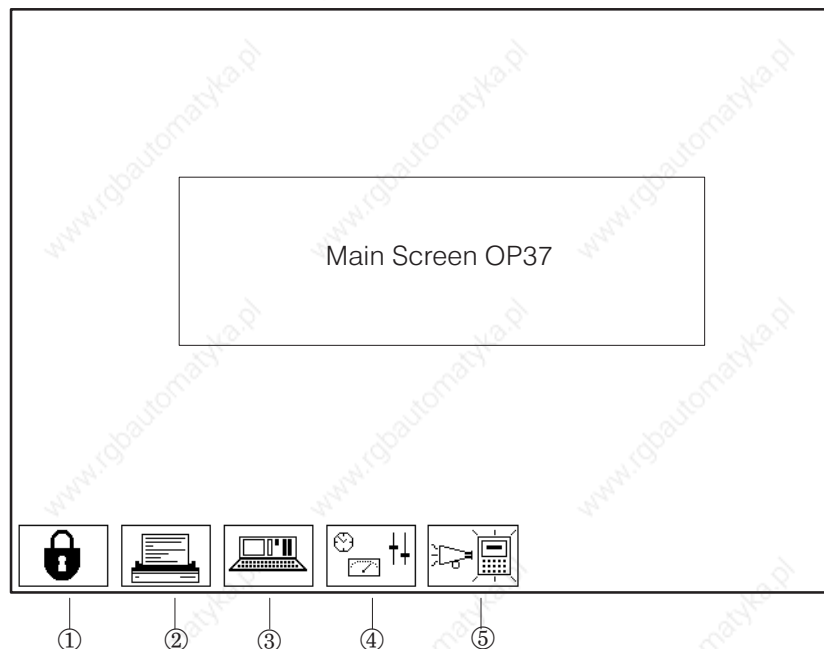

- ① Edit Password (Chapter 5)
- ② Printer Settings (Chapter 7)
- ③ Status/Control Tag (Chapter 10)
- ④ System Settings (Chapter 11)
- ⑤ Messages (Chapter 6)

Figure 4-2 Main screen of the OP37 (example)

Figure 4-3 illustrates the standard screen hierarchy. Detailed information on the functions and operation of standard screens is provided in the corresponding sections of this manual.

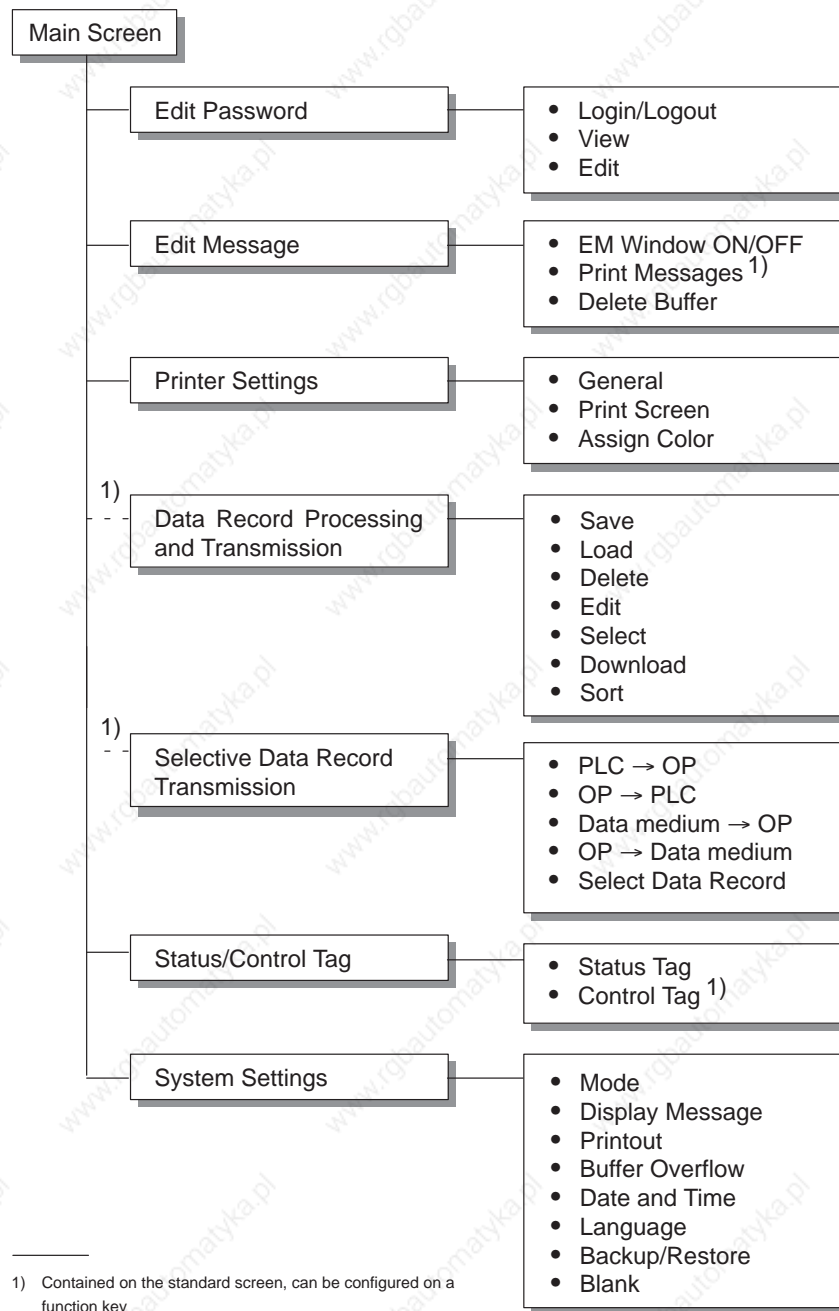

Figure 4-3 Standard screen hierarchy

Calling functions

Functions are called in on the OP by means of configured function keys. To prevent unauthorized access, some functions have to be protected beforehand by means of a password at a specific password level (see Chapter 5).

Password Protection

Access protection Password protection can be configured for function keys/soft keys and input fields to prevent operation of the OP by unauthorized personnel.

5.1 Password Level and Access Permissions

Password hierarchy

During the configuration phase with ProTool, the configurer assigns the function keys/soft keys and input fields hierarchically ascending password levels from 0 to 9. When a password is assigned to an individual user or to a whole user group, the permission to execute functions at a specific level is assigned simultaneously.

After logging in with a password of a certain password level on the OP, permission to execute functions is granted at that password level and at lower levels.

Password level 0

If a function is configured with password level 0, no password need be entered in order to execute this function. The functions assigned at this level, the lowest in the hierarchy, have little or no effect on operation. These functions do not normally have input options; an example of this is Open Message Pages.

If an attempt is made to call a function which has been assigned to a higher level, the OP requests a password.

Password level 1 – 8

Levels 1 to 8 should be assigned by the configurer according to the significance of the respective function. The supervisor (superuser) is responsible for assigning a password level to a password as part of his password management duties.

Password level 9

Only the superuser has the rights to execute functions assigned to password level 9. The superuser has access to all the functions on the OP. Only the superuser is authorized to perform password management on the OP. Password management involves assigning and changing passwords.

Superuser password

The superuser password is defined during configuration. The default value in the standard configuration is “100”. This setting can be changed using the OP.

Format

The passwords for levels 1 to 8 must be assigned on the OP, not during the configuration. Use the *Password Processing* standard screen (refer to Chapter 5.3). The password must be at least three and not more than eight characters long. Passwords can be composed of digits and characters A to Z. Leading zeroes are not permitted.

Standard screen

The *Password Processing* standard screen (Figure 5-1) provides the following functions:

- Login/logout on the OP
- Change and delete passwords,
- View password list.

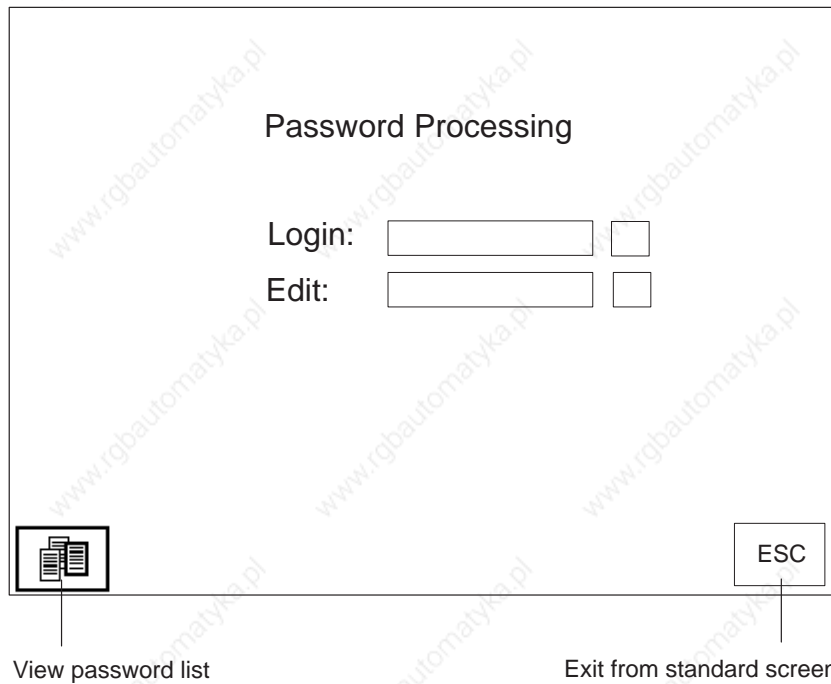

Figure 5-1 Standard screen *Password Processing*



5.2 Logging In and Out on the OP

Login

Login on the OP

- using the *Password Processing* standard screen
- by calling a function for which the current password level is too low. In this case the OP automatically requests a password.

Logging in on standard screen

Step	Action	Result
1	Call the standard screen <i>Password Processing</i> .	The standard screen is displayed (Figure 5-1).
2	Enter your password in the <i>Login</i> input field.	Input commences aligned to the left. Each character entered is represented by an asterisk (*).
3	Confirm the entry by pressing  Or cancel the input by pressing 	The input disappears. If the password is valid, the corresponding password level is displayed next to the <i>Login</i> input field.

Automatic call

If a password level higher than the current one is required for operating a function key/soft key or an input field, the OP automatically requests the entry of an appropriate password beforehand.

Logout

If no key is pressed on the OP within a configured time, the current password level is automatically reset to zero. This prevents unauthorized operation.

It is also possible to logout from the OP using the *Password Processing* standard screen. Carry out the following steps to do this:

Logging off on standard screen

Step	Action	Result
1	Call the standard screen <i>Password Processing</i> .	The standard screen is displayed (Figure 5-1).
2	Enter an invalid password and confirm by pressing 	Once it has been confirmed, zero is the active, current password level.

5.3 Password Management

Functions

The *Password Processing* standard screen provides the following functions for password management:



- create passwords and assign password levels,
- delete passwords,
- change passwords and password levels,
- view password list.

These functions can only be called in from password level 9 (exception: view password list). Therefore, log in beforehand by means of the *Login* input field using the superuser password.

Creating a password

A maximum of 50 different passwords can be set up on the OP. Password level 9 (superuser) can only be assigned once.



Carry out the following steps to assign a password and password level:

Step	Action	Result
1	Enter an unused password in the <i>Edit</i> input field and confirm it by pressing 	The cursor moves to the first character position in the input field.
2	Move to the adjacent input field by pressing 	Either the default password level 0 appears in the field, or the password level of the last password to be edited is displayed flashing inversely.
3	Overwrite the password level value (between 1 and 8) and confirm by pressing 	The new password is saved on the OP and is retained even in the event of a power failure.

Note

If a new password has been created and the OP should then be turned off, exit from the *Password Processing* standard screen to ensure the information remains confidential. The password is then no longer displayed. In all other cases, the password is still visible on the *Password Processing* standard screen after the OP has been turned on.

Deleting a password

Step	Action	Result
1	Enter the password to be deleted in the <i>Edit</i> input field and confirm by pressing 	The cursor moves to the first character position in the input field. If the password level in the adjacent input field is set to 0, the password has already been deleted.
2	Alternatively, move to the adjacent input field by pressing 	The password level of the last password to be edited is displayed flashing inversely.
3	Overwrite the existing password level with 0 and confirm by pressing 	The password is deleted following confirmation.



Changing a password

It is not possible to change a password on the OP directly. To change a password, the existing one must be deleted and a new one entered.

Exception:

The superuser password can be changed by overwriting it directly.





Changing password levels

Step	Action	Result
1	Enter the password, to which a new password level is to be assigned, in the <i>Edit</i> input field and confirm the entry by pressing 	The cursor moves to the first character position in the input field.
2	Move to the adjacent input field by pressing 	Either, the default password level 0 appears in the field, or the password level of the last password to be edited is displayed flashing inversely.
3	Overwrite the password level with a new value and confirm by pressing 	Once it has been confirmed, the new level is assigned to the password.

Viewing the password list

The password list contains all the passwords set up on the OP. The only passwords displayed are those with a password level lower or equal to the one assigned to the password used to login on the OP. The supervisor password is not displayed.

The following table explains how to call, view and terminate the password list. Figure 5-2 illustrates a password list.

Step	Action	Result
1	Press the function key assigned to the icon <i>View Password List</i> during the configuration. 	The password list window opens (Figure 5-2).
2	Use the arrow keys to scroll line by line through the list, if required.   Scroll through the list page by page by simultaneously pressing (OP37 only): 	The password and password level at the current cursor position are displayed in inverse screen colors.
3	Terminate the operation by pressing the system key 	The password list window is closed.

	Serial number	Password	Password level
1	1049		3
2	19FF27		4
3	1A740K		4
4	22CE51		1
5	3D36M1Z7		8
6	723		5
7	97BC1		4
8	A0YC3		1
9	MIRROR		1

Figure 5-2 Password list

Messages

Overview

Messages on the OP indicate events and statuses related to control processes. A message consists of static text, at least. It may also contain tags.

The following types of message are displayed on the OP:

- event messages
- alarm messages
- system messages

Once issued, alarm messages and event messages are stored on the OP in a message buffer which is protected against a power failure. Messages in the buffer can be called into the display and printed out on a connected printer. The OP can still be operated when messages are waiting to be displayed.

Message states

Alarm and event messages may contain the following information:

- **Arrived:**
Denotes the occurrence of a message.
- **Departed:**
The reason for the message no longer exists.
- **Acknowledged** (alarm messages only):
The message has been noted by the operator or the PLC, acknowledged and confirmed.

The OP records the exact time of the message states and indicates them when a message page or message buffer is displayed.

6.1 Types of Message

Event and alarm messages

Event and alarm messages must be configured. Event messages indicate a status in the process, whereas alarm messages indicate faults or errors. Event messages and alarm messages are issued by the PLC. Alarm messages have to be acknowledged on account of their significance.

System messages

System messages are triggered by the OP. They do not have to be configured. System messages provide information on operating status of the OP and on maloperations or malfunctions in communication.

6.1.1 Event Messages and Alarm Messages

Definition

The configuration defines whether a process status is indicated by an event message or alarm message. Messages referring to regular sequences of events or states should be categorized as event messages; for example

□	
0000031	10:53:27 04.04.97 11
Mixing operation completed	
Filing level in mixer: 5000 l	

Messages relating to disturbances of the process or status should be categorized as alarm messages; for example

△	
0000017	10:59:53 04.04.97 QGR 04 3
Bottling operation aborted	
Bottling valve closed	

Alarm messages have to be acknowledged on account of their urgency. By doing so, the operator confirms that he has taken note of the alarm message. Alarm messages can also be acknowledged by the PLC.

Operational hints can be configured as event messages or alarm messages, in addition to status messages. If, for example, the machine operator wishes to start the filling operation but has forgotten to open the bottling valve on the mixer, he can be requested to rectify the error by means of an event message; for example

□	
0000037	11:01:02 04.04.97 11
Open bottling valve	

Presentation

Alarm messages and event messages can be configured so that text components may be distinguished from the rest of the message text by flashing or underlining.

Messages may contain text and tag fields. Tag fields display current PLC values in alphanumeric form.

Standby message

A sub-category of the event message is the standby message. The standby message is the event message number 0. It is displayed when no other event message is waiting to be displayed on the OP.

Display mode

A current event or alarm message can be displayed in either a message line or message window. One of the following combinations can be defined in the configuration:

- **Window/window**

Event messages and alarm messages are displayed in separate windows.

The alarm message window is opened automatically when an alarm message arrives. When the alarm message is acknowledged, the alarm message window disappears.

The event message window can only be opened by pressing a configured function key.

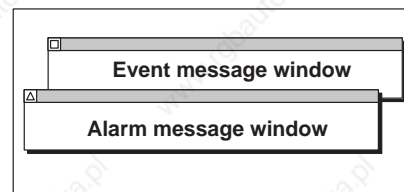

- **Window/line**

An event message is displayed in the message line, whereas an alarm message is displayed in the message window. The alarm message window is opened automatically when an alarm message occurs. When an alarm message is acknowledged, the alarm message window disappears if no other alarm messages are waiting.

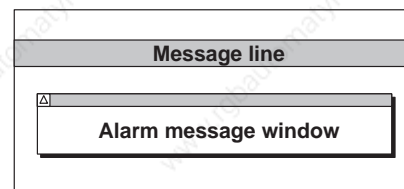

- **Window/hide**

An alarm message is displayed in the message window. Event messages are not displayed.

When the alarm message is acknowledged, the alarm message window is closed.



- Line/line**
 An event message or an alarm message is displayed on the message line. The message line is permanently visible. If there are no messages waiting, the standby message is displayed.

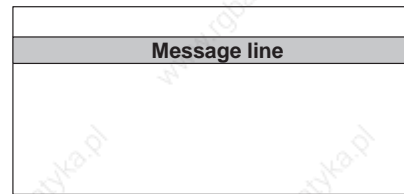

Message line

When a message line has been configured, it is always displayed, regardless of the screen selected. If *line/line* has been configured, an event or alarm message is displayed in the message line. Alarm messages flash to distinguish them from event messages. If *window/line* has been configured, an event message is displayed in the message line. An alarm message is displayed by means of a window.

Display priorities:

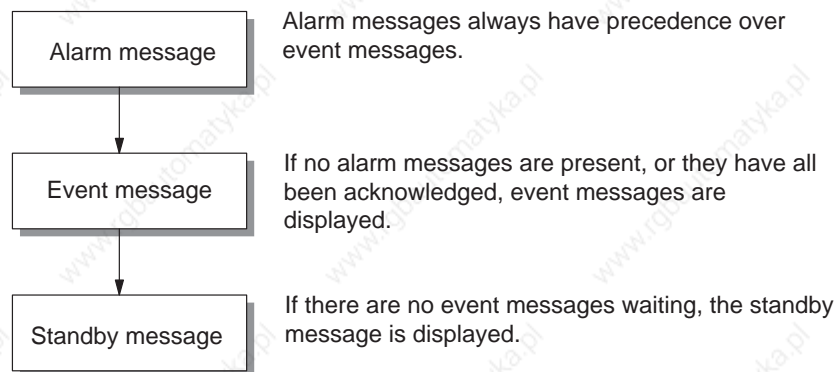

Only configured text appears in the message line.

Message window

Messages in the configured message window contain additional information on the message, such as message number and date/time the message arrived.

Alarm message window:

The alarm message window (Figure 6-1) automatically appears whenever an alarm message is issued. When an alarm message is acknowledged, the alarm message window disappears if no other alarm messages are waiting.

An alarm message is acknowledged by pressing the system key depicted on the right. The LED integrated in the system key remains on while an unacknowledged alarm message is waiting to be displayed.



In the case of the OP27, input is not possible while an alarm message window is open.

Message number	Time	Date	Acknowledgment group	Number of unacknowledged messages
0000048	11:34:02	27.03.97	QGR 01	2
Boiler 25: Temperature 156 degrees				
Summon Shift Engineer. Tel.: 9456				
Process value				

Figure 6-1 Alarm message window (example)

Event message window:

The event message window must be selected and then deselected by the operator. If an event message is not currently waiting, the standby message is displayed.

Activate the event message window by pressing the function key assigned to the icon depicted on the right in the *Message Processing* standard screen.

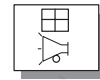

Close the event message window by pressing this function key a second time.

Message archive

Alarm and event messages are written in the OP message archive when they arrive. The message archive is a buffer in which all message events are entered in chronological order. Message events consist of:

- arrival of a message
- acknowledgment of an alarm message
- departure of a message.

The message archive is implemented as a FIFO buffer. When the buffer is full, the oldest messages are deleted.

Overflow warning

During configuration, it is possible to define a remainder buffer size for the message archive. As soon as this remaining buffer capacity is reached, the OP automatically issues an overflow warning (system message). Messages continue to be entered in the message archive even after the remaining buffer capacity has been reached.

Message bit procedure

If the conditions for issuing a message have been fulfilled in the process currently running, e.g. a value has been reached, a bit is set in the data area by the PLC application program for an event or alarm message. The OP reads the data area after a configured polling time. In this way, a message is detected as having “arrived”. The bit is reset by the PLC when the condition for issuing the message no longer exists. The message is then regarded as having “departed”.

6.1.2 Alarm Messages

Acknowledging alarm messages

Alarm messages must be acknowledged because of their urgency and importance. This can be done manually or automatically by the PLC. Information on the acknowledgment of alarm messages by the PLC is provided in the Communication User's Manual.

Acknowledge an alarm message manually by pressing the system key depicted on the right.



Unacknowledged alarm messages flash in the alarm message line.

If several alarm messages are waiting to be displayed, the next alarm message is displayed after one has been acknowledged. Each message must be acknowledge in turn.

Message indicator

The display of a message indicator can be enabled in the configuration. As long as the symbol depicted on the right is displayed, at least one alarm message waiting to be displayed on the OP.



The message indicator does not go out until all the alarm messages have departed. This means that a pending alarm message is not forgotten.

Acknowledgment groups, group acknowledgement

During configuration, several alarm messages can be combined to so called acknowledgment groups. This means that by acknowledging the first alarm (e.g. cause of the malfunction) all the other alarm messages in the same acknowledgment group are acknowledged simultaneously (consequential malfunctions) without them being issued in succession for acknowledgment on the OP (group acknowledgement). Up to 16 acknowledgment groups can be configured.

If alarm messages are not assigned to an acknowledgment group, only the message currently displayed is acknowledged when more than one are waiting.

6.1.3 System Messages

Definition

System messages indicate internal OP operating statuses. They indicate, for example, maloperations or communication malfunctions.

Close the system message window by pressing the system key depicted on the right.



Structure

A system message consists of a message number and text, e.g.:

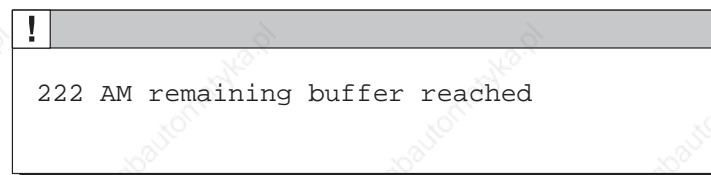

Message text may contain internal system tags for defining the cause of the message more precisely. Some system messages expect an acknowledgement or a decision to be made. A prompt appears in the system message window for determining the further course of action – for example:

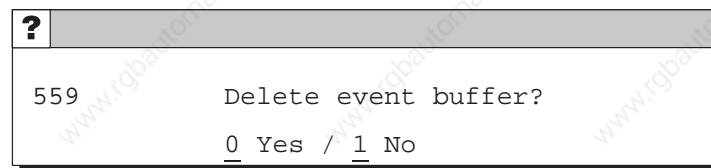

Serious and non-serious system messages

System messages are categorized into serious and non-serious messages. A serious system message is initiated by an error which can only be remedied by a cold or warm restart of the OP. All other errors generate non-serious system messages – for example, an entry does not comply with a configured limit value or the current password level is too low for the operator input required.

If a non-serious system error is not hidden automatically after a short time, hide it by pressing the system key depicted on the right.



The message display can be terminated automatically after a configurable display time expires.

A list of system messages, with explanations, is provided in Appendix D of this manual.

6.2 Displaying Messages

Message archive

All message events are written in the message archive in chronological order. Message events are composed of the arrival, departure and acknowledgment of a message. Up to 512 message events can be stored in the message archive of the OP. Every message event is stored with the following information:

- message number
- event identifier
(*K* for arrived, *G* for departed, *Q* for acknowledged),
- time of the event with date and time of day
- acknowledgment group (alarm messages)
- message text
- values of tags at the time of arrival or departure.

If a message contains process values, the values stored in the message archive are those which were available when the message event arrived or departed. The OP does not record any current process values for the *Acknowledged* message status. The value is replaced by ### characters. Figure 6-2 illustrates the structure of the message archive.

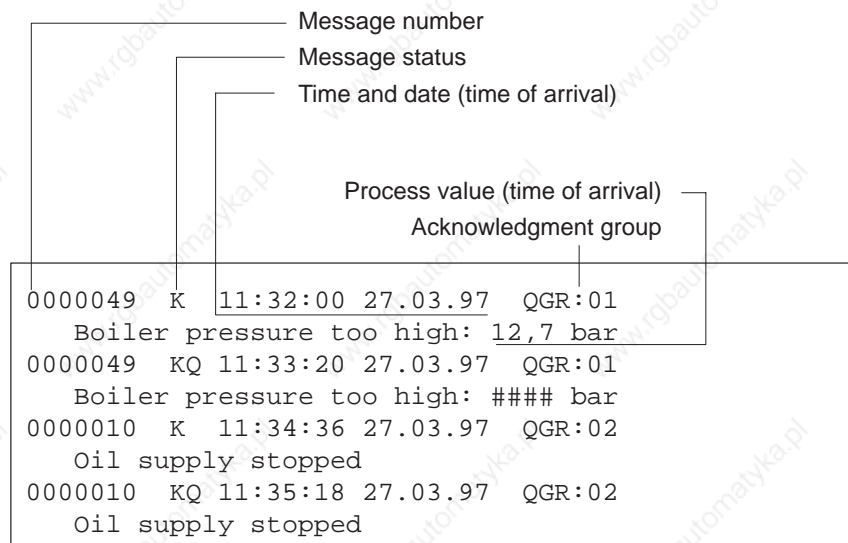

Figure 6-2 Storing message events in the message archive

Display

The message events in the message archive can be filtered according to various criteria and displayed on the OP (Figure 6-3).

- All waiting event messages are displayed on the event message page.
- All message events for event messages are displayed in the event buffer. The events related to message events are Arrived and Departed.
- All waiting alarm messages are displayed on the alarm message screen.
- All message events for alarm messages are displayed in the alarm buffer. These message events are Arrived, Departed and Acknowledged.

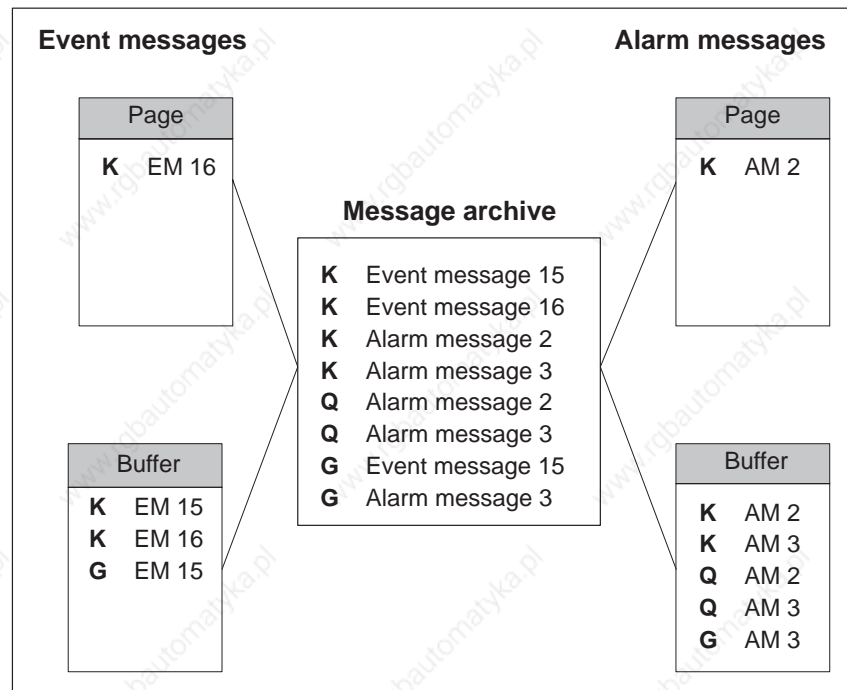

Figure 6-3 Displaying message events on the OP

Priority

Within the alarm and event messages, it is possible to configure message priorities according to their importance.

- 1 (low) to
- 16 (high).

If several messages having the same display priority are waiting, they are displayed according to their message priority – the highest first and the lowest last.

Message page structure

The event message screen is sorted chronologically. The sorted order of the alarm message screen also depends on the *First/Last* parameters set on the *System Settings* standard page. Figure 6-4 depicts an example of an alarm message screen.

```
0000049  K  11:32:00 27.03.97  QGR:01
  Boiler pressure too high: 12,7 bar
0000049  KQ 11:33:20 27.03.97  QGR:01
  Boiler pressure too high: #### bar
0000010  K  11:34:36 27.03.97  QGR:02
  Oil supply stopped
0000010  KQ 11:35:18 27.03.97  QGR:02
  Oil supply stopped
```

Figure 6-4 Alarm message page on the OP37 (example)

Message buffer structure

The message buffers list all the message events which have occurred in the OP in chronological order. The basic structure does not differ from the alarm message page, an example of which is provided in Figure 6-4.

Call in message page / message buffer

All the functions for calling in the message page or message buffer are configured in the *Message Processing* standard screen (refer to Chapter 6.5.1).

6.3 Deleting Messages

Purpose

All message events from event and alarm messages are stored automatically in the message archive. The message archive can contain as many as 512 message events. Message events are deleted

- automatically in the case of buffer overflow
- by means of the *Message Processing* standard screen.

Overflow warning

On reaching the configured remaining buffer size, (default setting 10%), an overflow warning is issued by default. Issue of the overflow warning can be enabled or disabled on the OP by means of the *System Settings* standard screen. To do so, open the input window in the BUFFER OVERFLOW WARNING symbolic input field and select either of the parameters OFF or ON.

Deleting on buffer overflow

If the message archive is no longer capable of recording more message events, message events are automatically deleted until the capacity configured for the remaining buffer size is reached. Deletion occurs in the following sequence:

- The oldest messages which have already departed.
The message events Arrived and Departed for an event message which has departed are deleted. The message events Arrived, Departed and Acknowledged are deleted in respect of alarm messages which have been cleared.
- Messages still waiting.
If the capacity is still not sufficient for new messages, the oldest waiting messages are deleted. This triggers the issue of a system message.

Automatic printout

In the case of a buffer overflow, a printout of all the alarm and event messages deleted is automatically triggered if

- “Printout on overflow” is configured,
- message logging is disabled on the OP and
- a printer which is ready to operate is connected.

Deleting via standard screen

The following messages can be deleted from the message archive via the *Message Processing* standard screen:

- all (not individual) acknowledged and departed alarm messages,
- all (not individual) arrived and departed event messages.

Delete alarm messages by pressing the function key assigned to the icon depicted on the right in the *Message Processing* standard screen.

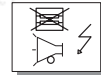

Delete event messages with the function key assigned to the icon depicted on the right.

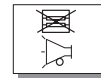

The message events for messages which have not departed remain in the message archive.

6.4 Printing Messages

How to print

Alarm and event messages can be printed out

- automatically, following buffer overflow (see Chapter 6.3),
- automatically, as direct message logging.
- manually (refer to Chapter 6.5.1).

Set the printer parameters in the *Printer Settings* standard screen. The standard screen is described in Chapter 7.

Note

If the message buffer overflows as a result of a messages overload, it is possible that messages cannot be printed. If this happens “*****” appears in the printout instead of messages.

Direct message logging

Alarm and event messages can be printed out directly on arrival and departure (alarm messages too, following acknowledgement) when this has been defined in the message configuration. System messages are not logged.

Direct message logging on/off

Direct message logging can be enabled/disabled online via the OP using the *System Settings* standard screen. To do so, open the input window in the MESSAGE LOGGING symbolic input field and select the required parameter OFF or ON.

The table shows the relationships between the settings on the OP and those configured in ProTool.

Setting in ProTool	Setting on OP	
	Message Logging ON	Message Logging OFF
Message event	Messages are logged	Messages are not logged
Buffer overflow	Messages are logged	Buffer overflow is printed
Off	Messages are logged	No effect

Note

If Asian character sets are used for messages, the messages are printed in graphics mode.

Manual printout of buffer content

The buffer contents can be printed out in the following ways:

- The *Message Processing* standard screen (see Chapter 6.5.1) has a function key/soft key to print out alarm and event messages.
- The *Output Messages* standard screen (see Chapter 6.5.2) has a function key/soft key to print out alarm and event messages. In addition, it is possible to enter filter criteria to restrict the messages to be printed.

6.5 Standard Screens for Messages

Overview

The standard standard screens below are significant for messages:

- *Message Processing*
- *Output messages*
- *System Settings*

6.5.1 “Message Processing” Standard Screen

Purpose

Functions are configured in the *Message Processing* standard screen which are necessary to view and delete messages (Figure 6-5).

Open the *Message Processing* standard screen from the main screen. To do this, press the function key assigned to the icon depicted on the right.



Structure

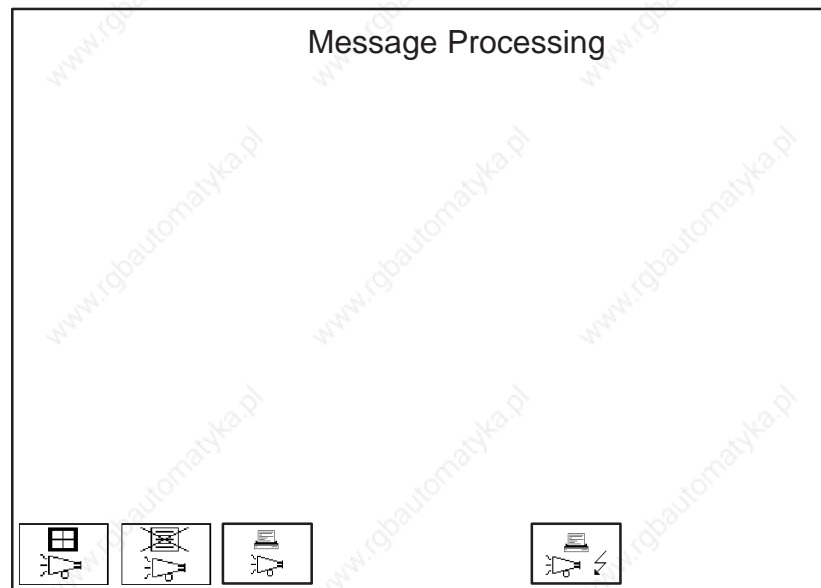













Figure 6-5 *Message Processing* standard screen (example: OP37)

Meaning of operating elements

Control	Meaning
	Open/close event message window.
	Reciprocally open event message page and event buffer.
	Close event message screen / event buffer.
	Delete event buffer.
	Print event buffer.
 OP37	Reciprocally open alarm message page and alarm buffer.
 OP27	
	Close alarm message page / alarm message buffer.
	Delete alarm buffer.
	Print alarm message buffer.
	Exit from standard screen.

6.5.2 “Output Messages” Standard Screen

Condition

In order to select and print messages via the OP according to filter criteria, the *Output Messages* standard screen must be integrated in the configuration.

Purpose

The *Output Messages* standard screen enables the selection and printing of messages according to various, user-defined filter criteria (Figure 6-6).

Structure

Output Messages

Output medium:

Message event:

Priority:

Date:

Text:

Acknowledgment group:



 

Figure 6-6 *Output Messages* standard screen (example: OP37)

Meaning of operating elements

Output medium

PRINTER

The factory setting for output from units OP27 and OP37 is to a printer.

Message event

ALL

All the alarm messages or event message buffer contents are printed out. This includes all message events which have Arrived, Departed or been Acknowledged.

ARRIVED ONLY

Only the Arrived messages events stored in the buffer are printed.

DEPARTED ONLY

Only the Departed messages events stored in the buffer are printed.

ACKNOWLEDGED ONLY

Only the Acknowledged messages events stored in the buffer are printed.

ARRIVED AND DEPARTED

Only the Arrived and Departed messages events stored in the buffer are printed.

ARRIVED AND ACKNOWLEDGED

Only the Arrived and Acknowledged messages events stored in the buffer are printed.

DEPARTED AND ACKNOWLEDGED

Only the Departed and Acknowledged messages events stored in the buffer are printed.

Priority

0 to 16

Only those message events are printed which have at least the specified priority.

Date

Only those message events with the specified date are printed.

Text

Only those message events are printed which contain the specified character string. Upper/lower case is not considered.

Acknowledgment group

0 to 16

Only those message events are printed which belong to the specified acknowledgement group.

6.5.3 “System Settings” Standard Screen

Purpose

Different settings can be defined for messages using the symbolic input fields in the *System Settings* standard screen. Open the *System Settings* standard screen from the main screen by pressing the key assigned to the icon depicted on the right.



Structure

System Settings

Operating mode:

Display message :

Message logging:

Buffer overflow warning:

Date:

Time:

ESC

Figure 6-7 *System Settings* standard screen (example OP37)

Meaning of operating elements

Only the operating elements of interest as regards messages are listed below. See Chapter 11 for a description of the other fields and keys.

Message display

- FIRST
The oldest message is displayed first.
- LAST
The most recent message is displayed first.

Message logging

For a description refer to the Table on page 6-13.

Buffer overflow warning

- ON
A system message is issued when the remaining buffer size is reached.
- OFF
No message is issued when the remaining buffer size is reached.

ESC

Exit from standard screen

Printing

Connecting a printer

A black and white or color printer can be connected to the OP. Configuration of the connection is described in Section 13.1.3. Descriptions of the interfaces is provided in Appendix B.

Print functions

The following print functions are provided on the OP:

- **Print Messages** (see Section 6.4).
Screen prints (hardcopies) and screens can be printed during message logging.
- **Print Buffer**
The entire event message or alarm message buffer contents are printed on the printer. Filter criteria can be defined for the printout (see Chapter 6.5.2).
- **Print Screen**
To use this function on the OP, assign the PRINT SCREEN function to a function key during configuration. The screen displayed is printed after pressing the function key. Windows currently displayed on the screen, e.g. the message window, are not printed together with the screen. Once initiated, cancel printing of the screenshot by pressing the function key once more.
- **Print Screen List**
To use this function on the OP, assign the PRINT SCREEN LIST function to a function key during configuration. This function can be used to print up to twenty screens in succession at one page per screen. If there are output fields on a screen for process values, the values valid at the time of printing are read out from the PLC.
In order to print all the screens selected using the *Print Screen List* function in Graphics mode, it must be defined in the configuration using the global function *Automatic Graphics Printing*.
Printing is performed in the background, so that the OP can still be operated.
ASCII is the default printing mode; in other words, graphic elements such as graphics, trend curves and bar graphs are not printed. Print Screen is not possible while printing is in progress. If the GRAPHICS MODE UPON PRINTING SCREEN LIST function has been configured for individual screens, all the elements of these screens are printed when the screen list is printed.

Standard screen

The settings configured for printer type and printer parameters can be modified online via the symbolic input fields:

- with the OP27 on standard screens *General Printer Settings*, *Print Screen* and *Assign Color* (Figure 7-1).
- with the OP37 on standard screen *Printer Settings* (Figure 7-2).

Make sure that the parameters on the OP37 comply with those of the printer.

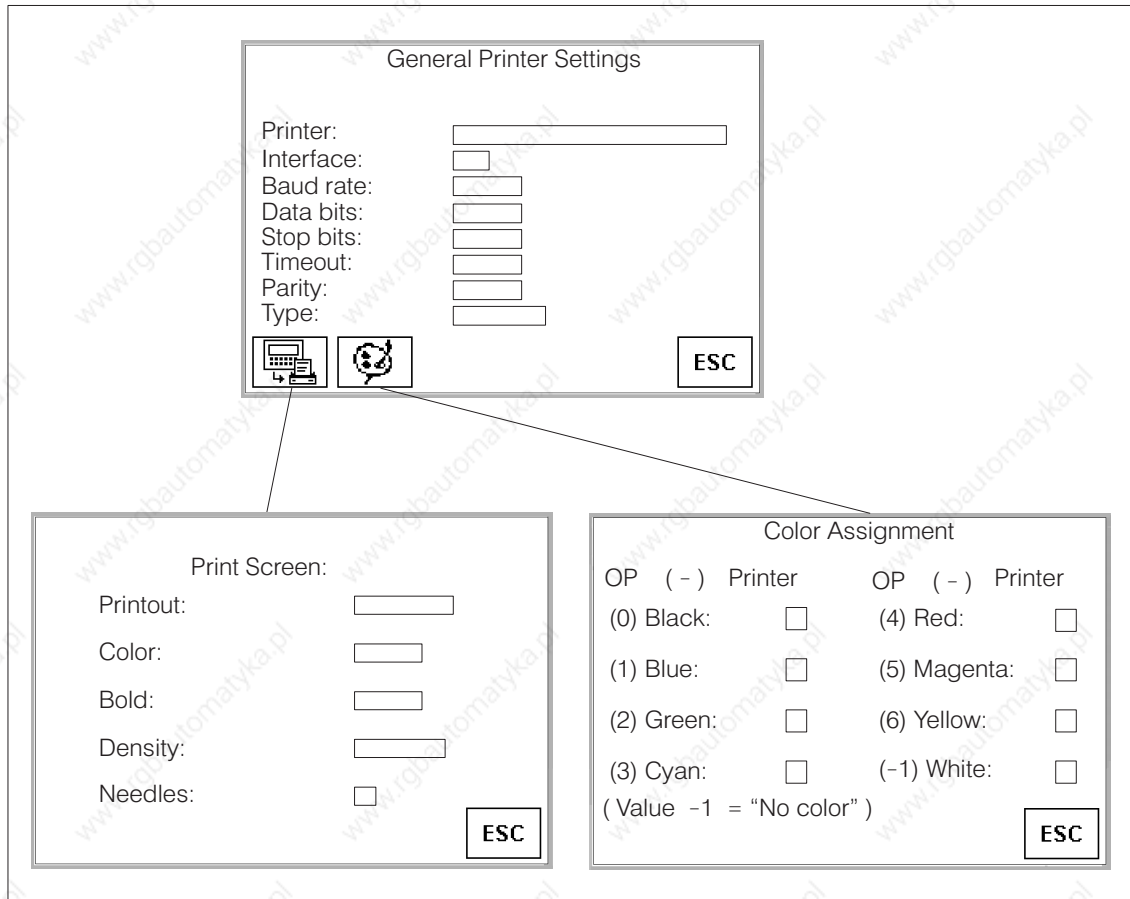

Figure 7-1 Standard screens for printer settings (example OP27)

Printer Settings

General:

Interface:

Baud rate:

Data bits:

Stop bits:

Timeout (s):

Parity:

Type:

Printer:

Hardcopy:

Printout:

Color:

Bold:

Density:

Matrix prt.:

Color Assignment

OP	<->	Printer	<->	OP		Printer
(0) Black		<input type="text"/>		(4) Red:		<input type="text"/>
(1) Blue:		<input type="text"/>		(5) Magenta:		<input type="text"/>
(2) Green:		<input type="text"/>		(6) Yellow:		<input type="text"/>
(3) Cyan:		<input type="text"/>		(-1) White:		<input type="text"/>

(Value -1 = "no color")

ESC

Figure 7-2 Standard screen for printer settings (example OP37)

Meaning of operating elements

Interface

Set printer interface:

- IF2 (serial)
- LPT (parallel, OP37 only)

Transfer Parameters

Standard setting (serial):

- BAUD RATE: 9600
- DATA BITS: 8
- STOP BITS: 1
- PARITY: None
- TIMEOUT (S): 60

Do not change the parameters unless they do not correspond to the transfer parameters of the printer.

Printer

Select a printer from the list of configured printers.

Print Screen

- ASCII (default setting):
Only ASCII characters are printed in a screen printout (no graphics or character graphics). Printing in ASCII format is significantly quicker than graphics printing. A screen which contains text characters belonging to an Asiatic character set is always printed in graphics mode, irrespective of the default ASCII setting.
- GRAPHICS:
All elements on the screen are printed in a screen print, including graphics, trends and bar graphs.

Color Assignment

Disable individual colors (-1) or modify color assignment.

Example:

In order to use black (0) as the color instead of blue (1).



Switch to *Print Screen* standard screen (OP27 only).



Switch to *Color Assignment* standard screen (OP27 only).



Exit from standard screen

Recipes

Purpose

Recipes consist of combinations of tags for a specific application. The purpose of recipes is to transfer several items of data collectively to the PLC. On doing so, the OP and the PLC are synchronized.

Data records

The data structure is defined with the data record in the configuration. Data is assigned to the structure on the OP. This data structure (recipe) can be used more than once and different data can be assigned to it. Data which has been assigned to a recipe is referred to as “data records”. Data records are stored on the OP. This saves memory space on the PLC.

Example of a recipe

The same bottling machine of a fruit juice filling system is to be used to produce orange nectar, an orange drink and orange juice. The mixing ratios are different for each drink, though the ingredients are always the same. The production details are configured in this example as the “Mixture” recipe.

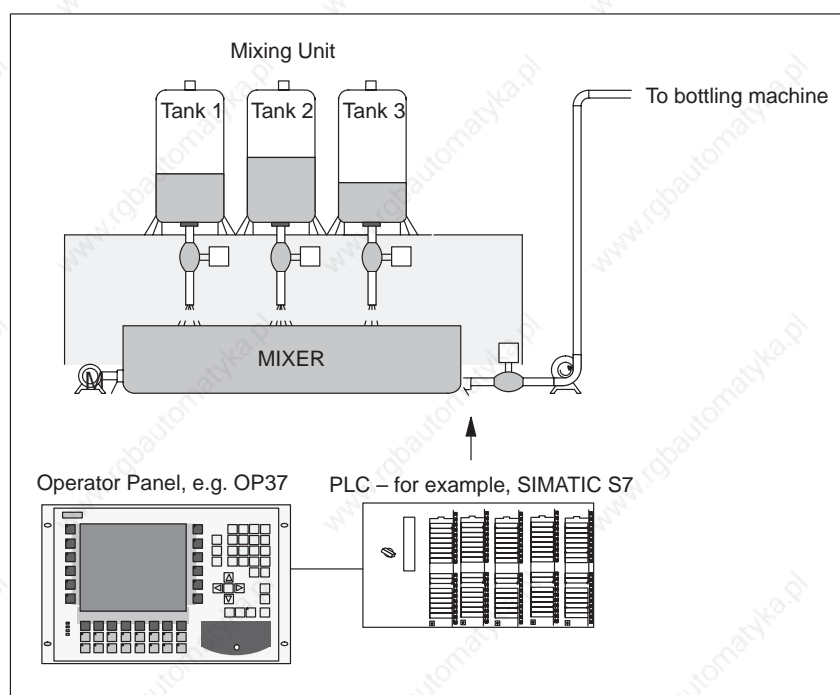

Figure 8-1 Example: Fruit juice system

Ingredients of a recipe

A recipe consists of a series of recipe entries. Each entry contains no more than one input field (tag).

The *Mixture* recipe might contain the following entries:

Name:	<input type="text"/>	
Orange:	<input type="text"/>	l
Water:	<input type="text"/>	l
Sugar:	<input type="text"/>	kg
Flavor:	<input type="text"/>	g

|
Input fields (variables)

Data records on the OP

Values are assigned to the input field tags on the OP and stored. Together, these values form one data record of the recipe.

Several data records can be created for one recipe. This enables the fruit juice system, for example, to produce drinks of different kinds. It uses a different data record for each drink:

Name:	Beverage	Nectar	Juice
Orange:	90 l	70 l	95 l
Water:	10 l	30 l	5 l
Sugar:	1.5 kg	1.5 kg	0.5 kg
Flavor:	200 g	400 g	100 g
"Mixture" recipe entries	Data record 1	Data record 2	Data record 3

All data records are stored in the OP. Only the currently active data record is stored on the PLC. This saves memory space on the PLC.

Identifying recipes

A recipe is created under a symbolic name in the configuration. The recipe is also selected using this symbolic name on the OP.

8.1 Standard Screens for Recipes

Condition

In order to create, save and download data records using the OP, the *Data Record Processing* standard screen must be integrated in the configuration. The standard screen *Selection Data Record Transmission* is only required in the configuration when current data needs to be transferred directly between the OP and PLC.

Purpose

Data records are created, modified and deleted using the standard screen *Data Record Processing*. This standard screen can also be used to Selection Data Record Transmissions from data media (flash, memory cards) to the PLC or vice versa. The standard screen *Selection Data Record Transmission* is only required when data records need to be transferred between specific OPs, data media or PLCs. A detailed description of handling standard screens is provided in Section 8.1.1.

Standard screen Data Record Processing

Use the standard screen *Data Record Processing* (Figure 8-2) to

- create data records on the OP and store them on a data medium,
- transfer the records from data media to the main memory of the OP and from there to the PLC,

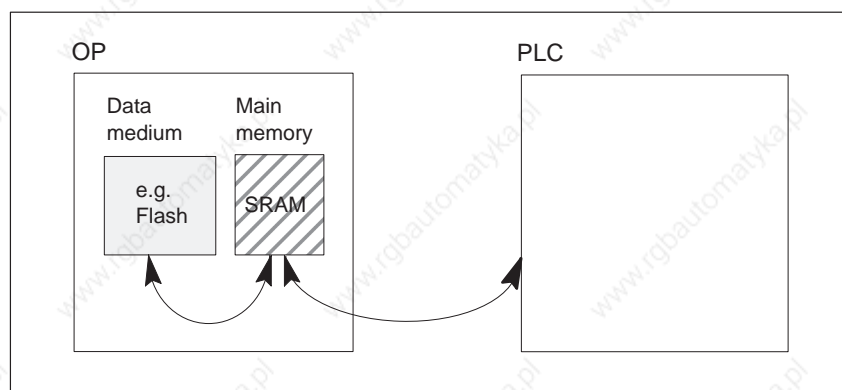

- delete data records on the data medium
- Data Record Processing on the OP.

The structure of a recipe cannot be modified on the OP.

Data Record Processing

Recipe:





Data record name:

Comment:

Sort order:

Data medium:

Format

ESC

Figure 8-2 Input fields and soft keys in the standard screen *Data Record Processing* (example: OP37)

Meaning of operating elements



Copy current values from the PLC to the main memory of the OP and save them as a data record on one of the following data media:

OP27	OP37
<ul style="list-style-type: none"> • flash • module (memory card) 	<ul style="list-style-type: none"> • flash • module (memory card) • disk



Load selected data records from data medium to the main memory of the OP and transfer from there to the PLC.



Delete selected data record on the data medium.



Create and modify selected data record on the data medium.



Select data record from recipe data.



Exit from standard screen

- Recipe** Select a recipe from the list of configured recipes.
- Data record name** Enter or select the name of the new data record or the data record to be edited.
- Comment** Enter a comment in respect of the data record to be edited. The comment entered is only accepted when the data record is stored on the data medium. It is not accepted if the data record is saved a second time. In this case, the comment must be entered in the Edit window (refer to Figure 8-4 on Page 8-10).

- Sort order** Define the sorting criteria for the list of data records. Select from the following sorting criteria:
 - unsorted,
 - alphabetic,
 - alphabetic reversed,
 - chronological,
 - chronological reversed.

- Data medium** Select one of the following data media:

OP27	OP37
<ul style="list-style-type: none"> • flash • module (memory card) 	<ul style="list-style-type: none"> • flash • module (memory card) • disk

Format the data medium using the *Format* list box.

**Standard screen
Selection Data Record Transmission**

Current values can be downloaded from the OP to the PLC and vice versa, without having to store them on a data medium. This makes the startup phase of a process easier, for example. Similarly, transfer between the OP and data medium is also possible.

Using the standard screen *Selection Data Record Transmissions* (Figure 8-3) it is possible to

- transfer the current values from the PLC to the main memory of the OP,
- transfer the current values from the main memory of the OP to the PLC,
- load data records from data medium into the main memory of the OP,
- Selection Data Record Transmissions from the main memory of the OP to a data medium.

Selection Data Record Transmissions





Recipe:

Data record name:

Comment:

Sort order:

Data medium:

ESC

Figure 8-3 Input fields and soft keys in the standard screen *Data Record Processing* (example: OP37)

Meaning of operating elements



Download current values from the PLC to the main memory of the OP (update values in the OP).



Download current values from the main memory of the OP to the PLC.



Download data records from data medium to the main memory of the OP.



Download data records from the main memory of the OP to the data medium.



Select data record.



Exit from standard screen

Recipe

Select a recipe from the list of configured recipes.

Data record name

Enter or select the name of the data record to be downloaded.

Comment

Enter a comment in respect of the data record to be edited.

Sort order

Define the sorting criteria for the data records to be transferred. Select from the following sorting criteria:

- unsorted,
- alphabetic,
- alphabetic reversed,
- chronological,
- chronological reversed.

Data medium

Select one of the following data media here:

OP27	OP37
<ul style="list-style-type: none"> • flash • module (memory card) 	<ul style="list-style-type: none"> • flash • module (memory card) • disk

8.1.1 Creating, Editing and Saving Data Records

In this section

The data structure is defined with the recipe during configuration. Initially, there are no data records. They are created, edited and stored on data media directly on the OP using the *Data Record Processing* standard screen.







How to operate the standard screen *Data Record Processing* is the subject of this section.

Formatting data media





Before a data record can be stored, the data medium must be formatted. To do this, use the formatting function in the input field beneath the data medium selection.

Note





Any data records on the data medium are deleted by the formatting operation. Formatting of a data medium cannot be undone.

Step	Action
1	Position the cursor in the <i>Data Record Processing</i> standard screen on the symbolic input field <i>Format</i> :  
2	Open the selection window with: 
3	Select the formatting function from the selection window with:  
4	Confirm the selection with: 
5	Confirm the confirmation request in the following two system message with "Yes" by entering 0 or cancel the action with: 

Creating a new data record

Step	Action
1	Position the cursor in the <i>Data Record Processing</i> standard screen on the symbolic input field <i>Recipe</i> . Select the recipe for the new data record in the selection window.
2	Position the cursor on the symbolic input field <i>Data Medium</i> . Select from the selection window the data medium on which you want to save the new data record.
3	Position the cursor on the alphanumeric input field <i>Data Record Name</i> . Enter the name of a data record, which does not yet exist, in the input window . The length is limited to 11 characters.
4	Press the function key assigned to the icon. 
5	The system asks whether this data record is to be newly created. Enter 0 for "Yes".
6	Enter the respective values in the edit window (Figure 8-4). Confirm each entry by pressing: 
7	In order to save the data record, press the same key again:  Otherwise, discard the data record by pressing: 
8	When the following system request appears <i>Save Data Record?</i> Enter 0 for "Yes". The data record is then saved on the data medium selected.

Editing a data record

Step	Action
1	Position the cursor in the <i>Data Record Processing</i> standard screen on the symbolic input field <i>Recipe</i> . Select the recipe for the data record to be edited from the selection window.
2	Position the cursor on the symbolic input field <i>Data Medium</i> . Select the data medium from the selection window on which the edited data record should be saved .
3	Select the name of the data record which you which to edit. There are two ways of doing this: <ul style="list-style-type: none"> Press the function key, assigned to the icon depicted on the right, in the standard screen <i>Data Record Processing</i> and select the data record from the selection window.  Position the cursor on the alphanumeric input field <i>Data Record Name</i>. Enter the name of a data record in the input window.
4	Press the function key assigned to the icon: 
5	Modify the values in the edit window (Figure 8-4). Confirm the change by pressing: 
6	In order to save the modified data record, press the same key again:  Otherwise, discard the data record by pressing: 
7	When the following system request appears <i>Save Data Record?Enter 0 for "Yes"</i> . The data record is then saved on the data medium selected.

Edit window

The entries of the selected data record are listed in the Edit window (Figure 8-4). Each line contains the configured name on the left and the editable value of the entry on the right.

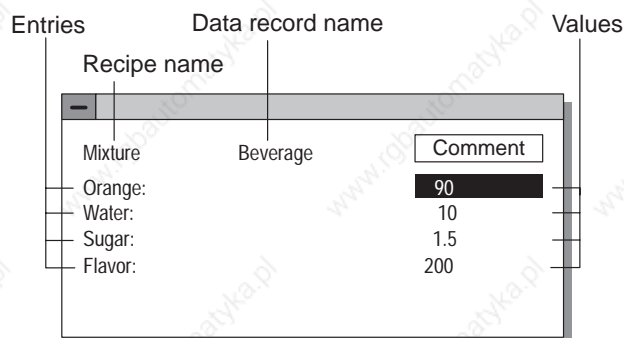



Figure 8-4 Data record editing window

Saving data records

Current values can be copied from the PLC to the OP main memory and saved as a data record on a data medium. The time at which the data record was saved is also stored.

Step	Action
1	Position the cursor in the <i>Data Record Processing</i> standard screen on the symbolic input field <i>Recipe</i> . Select the recipe for the data record to be saved from the selection window.
2	Position the cursor on the symbolic input field <i>Data Medium</i> . Select the data medium from the selection window on which the edited data record should be saved.
3	Select the name of the data record to be saved (see <i>Editing a data record</i> , Step 3, Page 8-10).
4	Press the function key assigned to the icon:  If a data record with this name does not exist, it is created. If a data record with this name already exists, the system asks whether the existing data record should be overwritten.
5	Confirm with “Yes” by entering 0 or enter 1 for “No” to cancel the action.
6	Repeat steps 1 to 5 for each data record to be saved on the data medium.

Loading data records

Proceed as follows to load data records from data media in the main memory of the OP and download them to the PLC:

Step	Action
1	Position the cursor in the <i>Data Record Processing</i> standard screen on the symbolic input window <i>Recipe</i> . Select a recipe for the data record to be loaded from the selection window.
2	Select the name of the data record to be loaded (see <i>Editing a data record</i> , Step 3, Page 8-10).
3	Position the cursor on the symbolic input field <i>Data Medium</i> . Select the data medium from which the data record is to be loaded from the selection window .
4	Press the function key assigned to the icon depicted on the right.  The data record is copied first of all in the main memory of the OP and then downloaded to the PLC where it overwrites the old data record.

Deleting data records

The following section describes the sequence for deleting individual data records from the selected data medium. If all the data records on the data medium are to be deleted, it is more practical to use the Format function (see Page 8-8).

If the data record to be deleted from the data medium is active on the PLC, it remains active on the PLC even after it has been deleted.

Step	Action
1	Position the cursor in the <i>Data Record Processing</i> standard screen on the symbolic input field <i>Recipe</i> . Select a recipe for the data record to be delete from the selection window.
2	Position the cursor on the symbolic input field <i>Data Medium</i> . Select the data medium containing the data record to be deleted from the selection window .
3	Select the name of the data record to be deleted (see <i>Editing a data record</i> , Step 3, Page 8-10).
4	Press the function key assigned to the icon: 
5	Confirm the subsequent confirmation request with “Yes” by entering 0 or 1 for “No” to cancel the action.

8.1.2 Transferring Data Records

In this section

The following section describes how to operate the *Selection Data Record Transmission* standard screen. This standard screen contains special functions configured for transferring data records between the OP and PLC and between the OP and data medium. As opposed to transfer using standard screen *Data Record Processing*, intermediate steps are provided here for the transfer process. This means that it is possible to load a data record from the PLC in the main memory of the OP, edit the data record and then transfer the record back to the PLC with modified values.

PLC → OP

Proceed as follows to update the values in the data record in the OP main memory with values from the PLC:

Step	Action
1	Position the cursor in the <i>Data Record Processing</i> standard screen on the symbolic input window <i>Recipe</i> . Select the recipe for the data record to be updated from the selection window.
2	Select the name of the data record to be loaded in the OP (refer to <i>Editing a data record</i> , Step 3, Page 8-10).
3	Press the function key assigned to the icon:  The data record is copied from the PLC in the main memory of the OP.

OP → PLC

Proceed as follows to transfer the current values in the main memory of the OP to the PLC:

Step	Action
1	Position the cursor in the <i>Data Record Processing</i> standard screen on the symbolic input window <i>Recipe</i> . Select a recipe for the data record to be transferred from the selection window.
2	Select the name of the data record to be loaded in the PLC (refer to <i>Editing a data record</i> , Step 3, Page 8-10).
3	Press the function key assigned to the icon:  The data record is copied from the main memory of the OP to the PLC.

Data medium → OP

Proceed as follows to load a data record from a data medium in the main memory of the OP:

Step	Action
1	Position the cursor in the <i>Data Record Processing</i> standard screen on the symbolic input window <i>Recipe</i> . Select a recipe for the data record to be loaded from the selection window.
2	Position the cursor on the symbolic input field <i>Data Medium</i> . Select the data medium from which the data record is to be loaded from the selection window .
3	Select the name of the data record to be loaded in the OP (refer to <i>Editing a data record</i> , Step 3, Page 8-10).
4	Press the function key assigned to the icon:  The data record is copied from the data medium to the main memory of the OP.

OP → data medium

Proceed as follows to save a data record in the main memory of the OP on the data medium:

Step	Action
1	Position the cursor in the <i>Data Record Processing</i> standard screen on the symbolic input window <i>Recipe</i> . Select the recipe for the data record to be saved from the selection window.
2	Position the cursor on the symbolic input field <i>Data Medium</i> . Select the data medium on which the data record is to be saved from the selection window .
3	Select the name of the data record to be saved (see <i>Editing a data record</i> , Step 3, Page 8-10).
4	Press the function key assigned to the icon:  The data record is copied from the main memory of the OP to the data medium.

8.2 Record Sets

Definition

A record set combines one data record from several different recipes under a common name.

In its data records, a record set contains all the values required to set up a machine or system. This means, for example, that the basic settings for machines which operate simultaneously can be loaded to produce different products.

Example

In order to simplify the general overview, the ORANGE fruit juice system used in this chapter is extended by the production lines GRAPEFRUIT and LEMON. To do this, the recipes GRAPEFRUIT and LEMON are set up. Each of these recipes has a data record called "Drink". These three data records form the record set called "Drink".

The data record "Drink" for all three recipes can be downloaded simultaneously to the PLC in a single transfer action, thus starting production of the "Drink".

Editing

A record set is edited in the *Edit Data Record* standard screen in the same way as a data record.

The editing options are:

- Select
- Save (Create)
- Load
- Delete

Selecting

Select the recipe name *Record Set* from the selection window. If "Record Set" has been chosen as the recipe, all the data records of all recipes are displayed following selection of the data record. Record sets (data records which are present in several recipes) are identified by a * in front of their name.

Save (Create)

A record set can be created in standard screen *Data Record Processing* in two different ways, i.e. saved on a data medium:

1. Save a data record for each recipe

Step	Action
1	Select <i>RecordSet</i> as the recipe.
2	Define the data record name and the data medium.
3	Save the record set as with a data record. A data record is created for each recipe.
4	Delete any data records not required.

2. Save a data record individually for selected recipes

Step	Action
1	Select the recipe name, e.g. <i>ORANGE</i> .
2	Define the data record name (e.g. <i>Drink</i>) and data medium. Each data record name must be created with the same name (= <i>Drink</i>).
3	Edit the data record and save it.
4	Repeat steps 1 and 3 for each data record.

Load

During the loading procedure all the data records with the selected name located on the data medium are loaded in the main memory of the OP and transferred on to the PLC. The sequence of steps corresponds to the procedure described on Page 8-12 under *Loading data records*.

Note

- It may take a relatively long time to upload a record set from the data medium to the PLC, depending on the size of the recipes. A record set should, therefore, only contain essential recipes.
 - During the following downloading procedure, **all** current values of **all** recipe tags are transferred, and not just the data records with the same name:
 - PLC → OP
 - PLC → Data medium
 - OP → PLC
-

Delete

- **Complete record set:**

The sequence of steps corresponds to the procedure described on Page 8-12 under *Deleting data records*.

- **Partial record set:**

Delete the data records with the corresponding name individually from the selected data records. The sequence of steps corresponds to the procedure described on Page 8-12 under *Deleting data records*.

Modify

Record sets cannot be modified. Only the individual data records in the record set can be modified. The sequence of steps corresponds to the procedure described on Page 8-10 under *Editing data records*.

Storing and Loading Data

In this chapter

This chapter explains

- how to transfer data to different data media
- which settings have to be performed and
- what to bear in mind.

Purpose

Depending on the type and quantity, data is loaded onto data media to

- backup data
- read in stored data (restore),
- load or store recipe data records
- load data from the configuration computer to a different operator panel,
- transfer OP firmware (download).

9.1 Data Types, Data Media and Storage Principle

Data types

Data is divided into the following categories:

- configuration data
- firmware data and
- recipe data.

Data media

The following data media are available for the OP:

Data medium	Operator Panel	
	OP27	OP37
Internal flash memory	✓	✓
Memory card	✓	✓
3.5" floppy disk (optional)	–	✓

Internal flash memory

The internal flash memory is a standard storage medium in the OP. The storage capacity is 1 MB in the case of the OP27M and 2 MB in the case of the OP27C and OP37. All data types can be stored in the flash memory. Memory allocation depends on the size of the configuration, the firmware and the data area configured for data records.

Memory card

The memory card is an external memory medium, comparable to a disk. Compared to the internal flash memory, the memory card features the following advantages:

- The memory card is a portable storage medium. This means, for example, that recipe data can be transported from one OP to another. In this way, changes to configurations or firmware updates can be transferred to systems on which no configuration computer is immediately available for transferring such data.
- Configurations can be loaded directly from the memory card to the working memory since the OP detects an inserted card. In this case, the OP accesses the memory card first, before accessing the internal flash memory.
- Its storage capacity of up to 16 MB provides space for large configurations or a large number of recipe data records.



Caution

Memory cards containing stored configurations may only be used with OPs of the same type. Otherwise, a system crash is possible.

Disk, hard disk

The OP37 can be supplied with optional 3.5" floppy disk and hard disk drives.

Note

A floppy disk can only be used to store recipe data records in OP mode (Section 11.1).

The hard disk can only be used in DOS mode (Chapter 15).

When loading new or modified recipe data on the system is frequently necessary, but the configuration remains unchanged, the 3.5" floppy disk drive is a very manageable and beneficial solution, since it can be accessed from the front of the OP37.

Storage principle

Data can only be saved in the following combinations for practical purposes:

- firmware, configuration and recipe data records or
- firmware and configuration¹⁾ or
- recipe data.

¹⁾ This function is not contained on the standard screen and has to be configured.

9.2 Clear/Initialize Storage Medium

Delete flash/ memory card







Before beginning making a backup copy of new recipe data or a modified configuration, delete or initialize the target data medium. This establishes a defined status for the data medium.

Make sure that the storage module is not inserted when the flash memory is to be deleted because the OP accesses the storage module when switching to Download mode.

Note

All data on the data medium is lost as a result of deletion. All existing configurations are deleted on initialization, but the recipe data records are retained.

Perform the following steps to clear or initialize memory:

Step	Action
1	Switch off the power supply to the OP. Press the adjacent key combination to restart.  +  + 
2	Insert the memory card to delete or initialize data on it. The following messages appear in succession on the OP: Press 'DEL' to erase total Flash Press 'DEL' to init Flash Press 'DEL' to erase total Modules Press 'DEL' to init Module
3	Scroll to the next message using the keys depicted on the right.  OR 
4	Confirm the selected function with the keys depicted on the right. 

Reserved memory area for recipe data

A memory area, with the following default settings, is reserved for recipe data in the flash memory and on the memory card:

- 64 kB (flash memory)
- 128 kB (memory card).

If the default values are not sufficient, they can be reset in ProTool. Remember, however, that there is less space available for the configuration if the reserved area is enlarged.

Note

Remember that, in addition to the reserved area for recipe data records, 64 kB are required on the internal flash memory and 128 kB on the memory card for management data.

9.3 Backup/Restore

Standard screen

The *Backup/Restore* standard screen (Figure 9-1) is opened from the *System Settings* standard screen using the function key assigned to this icon.

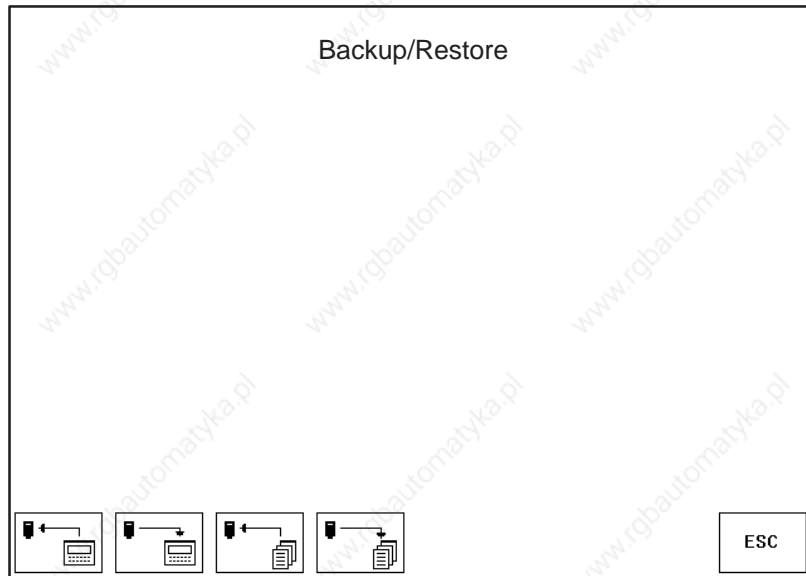

Figure 9-1 *Backup/Restore* standard screen (example OP37)

Meaning of operating elements



Backup:
Firmware + configuration + data records



Restore:
Firmware + configuration + data records



Backup:
Data records



Restore:
Data records



Exit from standard screen

Inserting memory card

Use Slot A for inserting the memory card on the OP27, and Slot B on the OP37 (refer to Chapters 16.3 and 17.3).

Backup flash → module

A backup Flash → Module can be carried out in normal operation of the OP:

Step	Action
1	Insert the memory card in Slot A of the OP27 or Slot B of the OP37.
2	Delete or initialize the memory card prior to backup.
3	Press the function key, depicted on the right, in the <i>Backup/Restore</i> standard screen, thus initiating the Backup function. A message is issued on the OP following successful transfer. 
4	Remove the memory card from the OP.

Restore module → flash

If a memory card only contains recipe data records, they can be transferred back in normal operation of the OP:

Step	Action
1	Insert the memory card in Slot A of the OP27 or Slot B of the OP37.
2	Press the function key, depicted on the right, in the <i>Backup/Restore</i> standard screen, thus initiating the Backup function.  The recipe data records in the internal flash memory are overwritten by the data records stored on the memory card.
3	Remove the memory card from the OP.

Note

Recipe data records stored on the memory card with the backup function must be restored to the internal flash memory on the OP before they can be edited.

Recipe data records created directly on the memory card (e.g. by using the standard screens *Data Record Processing and Transmission* and *Selective Data Record Transmission*), **cannot** be transferred back to the internal flash memory by means of the restore function.

**Restore firmware/
configuration**

Perform the following steps to load a backup of the firmware/configuration onto the OP:

Step	Action
1	Insert the memory card containing the firmware/configuration in Slot A of the OP27 or Slot B of the OP37.
2	Restart the OP. The OP is then started up with the firmware/configuration contained on the memory card.
3	Press the function key, depicted on the right, in the <i>Backup/Restore</i> standard screen to call in the Restore function. The memory contents of the internal flash memory are overwritten by the firmware/configuration contained on the memory card.
4	Remove the memory card from the OP.

**Automatic
restoring of
firmware/
configuration**

If the function *Backup/Restore* is added to the insertion point "Initialization" in the configuration, the function is called in each time the OP is started up, being loaded from the memory card. The system then asks whether the internal flash memory should be overwritten by the data stored on the memory card.

Step	Action
1	Insert the memory card containing the backup into the corresponding slot of the system.
2	Start the OP.
3	Confirm initiation of the restore function by answering "OK" at the prompt.
4	Remove the memory card from the OP.

10

Status/Force Tag Using the OP

Purpose

The Operator Panels provide two functions, namely *Status Tag* and *Force Tag*, which enable operand values from the connected PLC to be displayed in a standard screen and modified in a second screen.

This means that PLC operands can be edited directly on the OP in online mode without having to connect a programming unit to the PLC to do it.

Status Tag

Status Tag enables the status of SIMATIC S5/S7 operands to be displayed.

Force Tag

Force Tag enables SIMATIC S5/S7 operands to be controlled through modifying their values and transferring them back to the PLC.

10.1 Status Tag

Standard screen Status Variable

The *Status Variable* standard screen is selected from the basic screen by means of a soft key.

Status Variable					
MPI	Operand			Format	Value
12	DB, DBB	100	10	BIN =	00000000 00000000
1	??????		0	??????????	0
1	??????		0	??????????	0
1	??????		0	??????????	0
1	??????		0	??????????	0
1	??????		0	??????????	0
1	??????		0	??????????	0
1	??????		0	??????????	0
1	??????		0	??????????	0
1	??????		0	??????????	0

123	Status: Running	ESC
-----	--------------------	-----

Start/Stop update
Back to main screen

Figure 10-1 Status Variable standard screen (example: OP37 with SIMATIC S7)

Operands for SIMATIC S5

Figure 10-2 illustrates the structure of a line for the SIMATIC S5 in the form of an example:

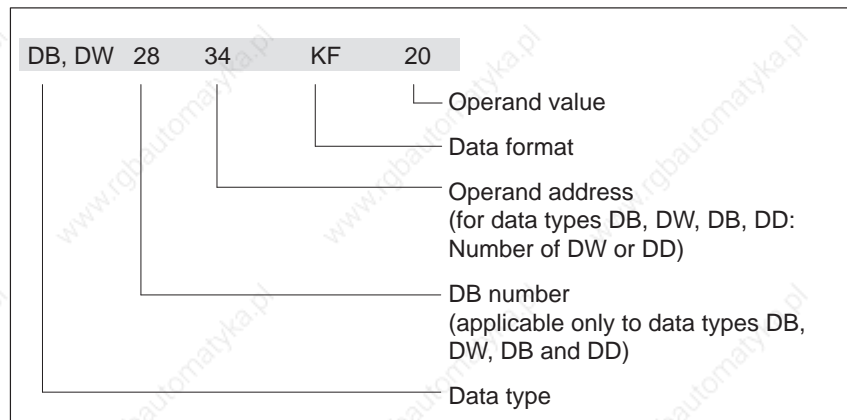

Figure 10-2 Display of PLC operands for the SIMATIC S5

Operands for SIMATIC S7

Figure 10-3 illustrates the structure of a line for the SIMATIC S7 in the form of an example:

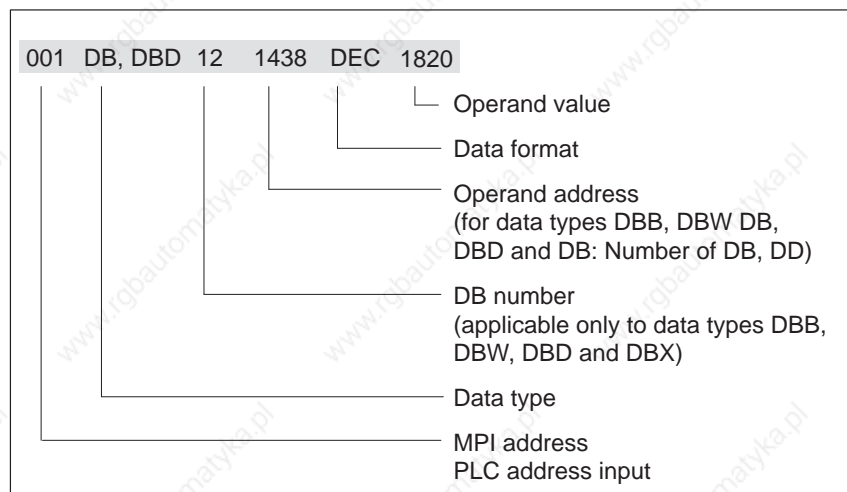



Figure 10-3 Display of PLC operands for the SIMATIC S7

Operating sequence

Carry out the following steps to view operand values on the PLC:

Step	Action
1	<p>Enter operands</p> <p>Once the screen has been selected, status processing is at <i>Status Stop</i>. Make the following steps:</p> <ol style="list-style-type: none"> 1. Enter the data type for the first operand (symbolic via pop-up window, refer to Chapter 3.3.3) 2. Enter the operand address for first operand (for data types DB, DW and DB, DD, also DB number) 3. Enter the data format for the first operand (symbolic via pop-up window, as under 1.) 4. Repeat the entries for operands 2 to x. <hr/> <p>Note</p> <p>A system message is issued if input is incorrect (e.g. the data format does not match the type entered). By default, the first entry in the pop-up window is then applied to the field.</p>
2	<p>START updating</p> <p>Press the function key assigned to the icon shown on the right, and set status processing to Status Running. The OP then displays the values of the operands in the final column of the standard screen. The display is updated cyclically.</p> 
3	<p>STOP updating</p> <p>After pressing the function key again, status processing reverts to Status Stop.</p> 

10.2 Force Tag

Function

In addition to the functions provided by *Status Tag* operand values can be modified using the Force Variable standard screen (^=control).

Standard screen Force Variable

The standard screen *Force Variable* is not integrated in the ProTool standard screens and must, therefore, be assigned to a function key.

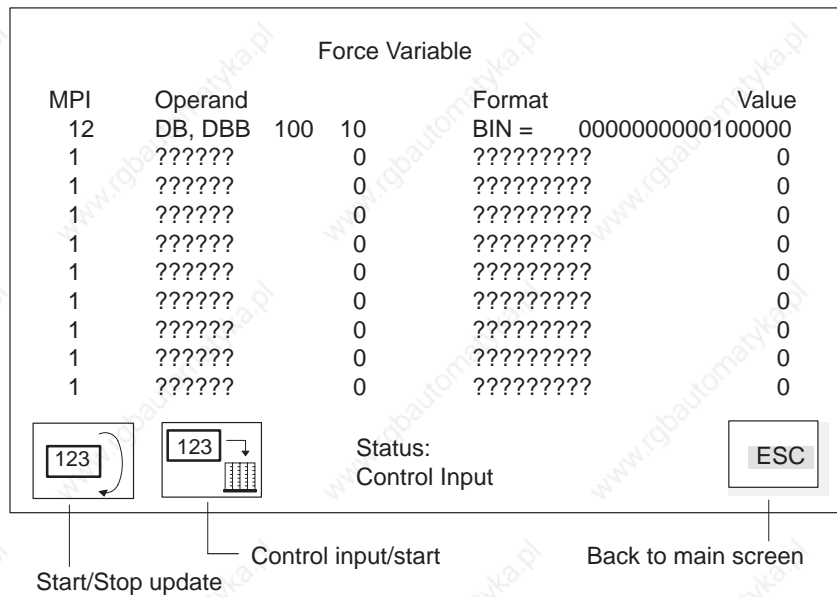





Figure 10-4 Force Variable standard screen (example: OP37 with SIMATIC S7)

The structure of a line in the *Force Variable* standard screen corresponds to a line in standard screen *Status Variable*.

Operating sequence

Carry out the following steps to force operand values:

Step	Action
1	<p>START updating</p> <p>Press the function key assigned to the icon shown on the right, and set status processing to Status <i>Running</i>.</p> 
2	<p>Force INPUT</p> <p>Switch status processing to the Force Input state using: Status processing is stopped and input is possible.</p> 
3	<p>Enter/modify operand value</p> <p>If you modify the value of an operand, a change mark appears in the final column of the line.</p> <div style="border: 1px solid gray; padding: 5px; width: fit-content; margin: 10px auto;"> <p>FW 250 KT 93.0 X</p> <p style="text-align: right; margin-right: 20px;">└ Change mark</p> </div>
4	<p>Force START</p> <p>As soon as you press the function key assigned to the icon on the right a second time</p> <ul style="list-style-type: none"> • all values of the operands assigned a change mark are transferred to the PLC • the change marks are reset, and • the system reverts automatically to status processing (Status: <i>Status Running</i>). <p>or</p> <p>Cancel input</p> <p>Press the system key shown on the right.</p>  <p>Modified values are no longer transferred to the PLC after exiting from the <i>Force Variable</i> standard screen or switching to the <i>Status Running</i> state.</p> 

System Settings

Standard screen

The standard screen *System Settings* is configured with functions which can be used to influence general settings on the OP. The following settings are possible:

- Blank screen
- Select language
- Perform backup/restore
- Set mode
- Set parameters for messages
- Set date/time.

Figure 11-1 depicts the *System Settings standard screen*. Open the System Settings standard screen from the main screen by pressing the function key depicted to the right.



System Settings

Operating mode:



Display message :

Message logging:

Buffer overflow warning:

Date:

Time:

ESC

Figure 11-1 Standard screen *System Settings* (example OP37)

Meanings of operating elements

Operating mode

The OP can be set to one of the following modes:

- Online
- Offline
- Serial Download,
- MPI Download (S7),

Display message

For a description, refer to Chapter 6

Message logging

For a description, refer to Chapter 6

Buffer overflow warning

For a description, refer to Chapter 6

Date and time

Set current date and time of day



Blank screen



Switch language



Call Backup/Restore function
(for a description, refer to Section 9.3)



Exit standard screen

11.1 Setting an Operating Mode

The OP27 can only be used in OP mode, whereas the OP37 can also be used in DOS mode.

OP mode

In OP mode, the entire functionality of the OP is available for operating and monitoring a system or process. It consists of the following modes

- Online
- Offline
- Serial Download
- MPI Download (S7),

Online

This is the standard operating mode for unrestricted process operation and process visualization. In Online mode, there is a logical connection between the OP and the PLC, or the OP attempts to establish one.

Offline

In Offline mode, there is no logical connection between the OP and PLC. The OP does not attempt to establish a connection. The OP can still be operated. Process control and process visualization are not possible.

Download

In Download mode, data can be downloaded from the configuration computer to the OP (refer to Chapter 14.2). In this mode, there is no logical connection between the PLC and the OP. The OP cannot be operated in Download mode.

Changing the operating mode

- In routine operation
Position the cursor on the *System Settings* standard screen at the *Mode* symbolic input field and select the mode required from the selection box. The OP saves the current operating mode in a non-volatile memory. When subsequently powered up, the OP automatically reactivates the most recent operating mode.
- During the startup phase of the OP
The procedure for setting the OP to Download mode in the startup phase is described in Section 14.2

DOS mode

The OP37 can also be used for applications which run under DOS or Windows. The points which need to be taken into account in DOS mode, and the procedure for changing from OP to DOS mode, are described in Chapter 15.

11.2 Blanking the Screen

Purpose

The brightness of the LCD back-lighting is reduced during the course of time due to technological reasons. To extend the useful life of the back-lighting:

- reduce its brightness on the OP27,
- switch it off on the OP37.

Action

- **Trigger using the standard screen**

Press the button assigned to the icon, depicted on the right, in the *System Settings* standard screen. This blanks the screen.



- **Automatic triggering**

If the OP is not operated within a configured period of time, the OP screen is blanked automatically.



The screen is only blanked automatically if this function has been configured in ProTool.

The back-lighting is turned back on after pressing a button.

11.3 Other Settings

Date/Time

The current date and time can be set on the OP in order, for example, to make adjustments for summer and winter time. Any changes affect all the fields which display a date and time variable. The display format for date and time is set in the configuration and cannot be changed later on the OP.

Step	Action
1	Position the cursor on the <i>System Settings</i> standard screen at the <i>Date</i> or <i>Time</i> numeric input field .
2	Enter the current values. Enter the dots as well. Note the conventions for date and time since the old value must be deleted before the new one can be entered.
3	Confirm the entry by pressing: 
4	or cancel the action by pressing: 

After setting the time, do not switch the OP off for at least 30 seconds. During this time the OP saves the date and time in the non-volatile memory.

Language

The configuration can be loaded onto the OP in up to three languages simultaneously. It is possible to switch to any of the languages at any time in Online mode. After switching to another language, all passages of language-dependent text are displayed in the new language.

Step	Action
1	Press the button assigned to the icon shown on the right on the <i>System Settings</i> standard screen. 
2	The language is changed cyclically every time the key is pressed.

The OP saves the current language setting in the non-volatile memory. The next time the OP is switched on, all the language-dependent texts are displayed in the last language set.

INSTALLATION AND COMMISSIONING

Part III

12 Mechanical Installation

13 Electrical Installation

14 Commissioning

15 OP37 in DOS Mode

Mechanical Installation

Location and installation conditions

The OP27 is designed for vertical installation in the front panels of switching cabinets.

The OP37 can also be installed in 19" panels/racks.

Cut a mounting slot in the front panel in preparation for installation of the OP. The thickness of the front panel must not exceed 6 mm. No other drilled holes are required for mounting.

Details on the mounting depth and mounting cutout are provided in Chapters 16 and 17.



Caution

- The OP must be brought to room temperature before it is commissioned. If condensation forms, do not switch on the OP until it is absolutely dry.
 - To prevent the OP from overheating during operation,
 - the angle of inclination specified in the technical data must not be exceeded,
 - do not expose the OP to direct sunlight,
 - make sure that the ventilation slots in the housing remain free after installation.
 - When the cabinet is opened, certain parts of the system that may conduct hazardous voltage are exposed.
 - The OP was function-tested before shipping. Nevertheless, if a fault does occur, please enclose a full account of the fault when returning the OP.
-

Degree of protection

The IP65 degree of protection for the front panel can only be assured when the seal on the front plate of the OP fits properly.

Before installing

If the labeling of the function keys needs to be modified, replace the labeling strips before installing the OP. Information on replacing the labeling strips is provided in Chapters 16 and 17.

12.1 Installing the OP27

Installation in switching cabinets / consoles

Step	Action
1	<p>Slip the seal over the housing from the rear and, working from the front, position the OP27 in the mounting cutout prepared.</p> <p>Make sure the OP cannot drop out of the front panel before it has been secured.</p>
2	<p>Place the hooks of the screw-type clamps ❶ enclosed in the corresponding recesses in the housing of the OP27.</p> <div data-bbox="730 656 1238 1227" data-label="Image"> </div> <p>Screw type clamps are only required at positions ❷ and ❸ when the IP65 degree of protection is to be maintained with an uneven front panel. A mounting bracket has to be screwed to the mounting rail for position ❸.</p>
3	<p>Working from the rear, tighten the clamps to secure the OP27 in the front panel ❷ using a hexagonal socket screw key.</p> <p>For information: Make sure the seal is seated correctly against the front panel. Do not overtighten the screws.</p> <div data-bbox="730 1514 1299 1776" data-label="Image"> </div>

12.2 Installing the OP37

The OP37 is designed for vertical installation in:

- 19" panels/racks,
- front panels of cabinets and consoles.

Installing in 19" cabinets/racks

When installing in 19" panels or racks, use the shaped rails from the panel or rack manufacturer concerned. The mounting dimensions and the method of securing the OP37 are shown in the following table.

Mounting Dimensions	
Mounting dimensions for a standard 19" panel:	
• Width	19" (482.6 mm)
• Height	7 height modules (310 mm)
Securing the OP	Four screws on the shaped rails

Installing in front panels of cabinets and consoles

Step	Action
1	Working from the front, insert the OP37 in the mounting cutout prepared. Make sure the OP cannot drop out of the front panel before it has been secured.
2	Insert the hooks of the six enclosed screw-type clamps ❶ in the corresponding recesses in the housing of the OP37.

The diagram illustrates the installation of the OP37 unit into a front panel. The front panel has a rectangular cutout. The OP37 unit is shown being inserted into this cutout. Six screw-type clamps, labeled with a circled '1' (❶), are shown being inserted into the housing of the OP37 unit. The clamps are positioned at the top and bottom edges of the unit. Labels 'Front panel' and 'OP37' are used to identify the respective components.

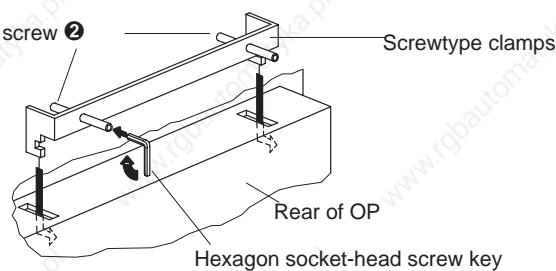
Step	Action
3	<p>Working from the rear, tighten the grub screws ② against the front panel, as illustrated.</p>  <p>Note:</p> <ul style="list-style-type: none"> • Make sure the seal is seated correctly against the front panel. • Do not overtighten the screws.

Electrical Installation

Electrical connections

The OP requires electrical connections

- to the power supply
- to the configuration computer (PU or PC)
- to the PLC.

The electrical connection to the PU or PC is required purely for downloading the firmware and the configuration. Following the configuration and test phases, a serial printer can be connected to the OP instead of the configuration computer.

EMC compatible design

A precondition for error-free operation is an EMC compatible hardware design of the PLC and the use of interference-proof cables. The guidelines on interference-free design of the PLCs apply equally to installation of the OP.



Caution

- Only shielded cables are allowed for all signal connections.
 - Screw or lock all plug connections.
 - Do not install signal lines in the same cable ducts as power cables.
 - Siemens AG refuses to accept liability for malfunctions and damage arising from use of self-made cables or cables from other manufacturers.
-

Reverse battery protection

The operating units have reverse battery protection. This has no effect if a connection already exists to another unit via RS 232. Therefore, proceed as follows when commissioning the operating unit:

1. Connect the power supply.
2. Switch on the operating unit. If the operating unit does not power up, swap the connections because the poles are reversed.
3. When the operating unit has been powered up, connect the configuration computer or periphery equipment.

Configuration options

Figure 13-1 illustrates a number of configuration options for OP, PLC and periphery equipment.

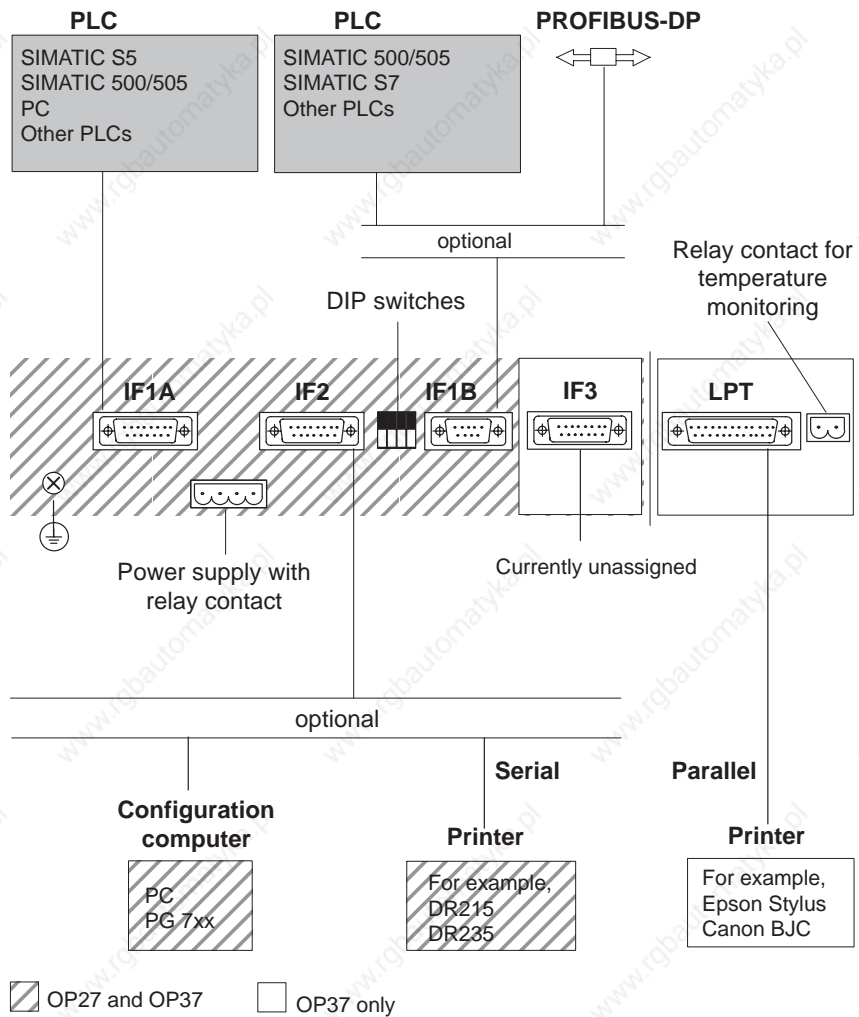

Figure 13-1 Configuration options

Detailed information on connection options is provided in the sections below. The connection plug pin assignment for the interfaces are provided in Appendix B of this manual.

13.1 Power Supply and Relay Contacts

Power supply

Connect the power supply for the OP to the 4-pin plug connector on the underside of the OP. Use the 4-pin terminal block supplied with the OP for this purpose. The terminal block is designed for cables having a cross-section not larger than 2.5 mm². Please refer to the technical data in Appendix A for information on the power supply requirements.

Relay contacts

Messages on the OP can trigger visual or acoustic signals (light, flashing light, buzzer, horn, siren etc.) by tripping an internal relay, if configured. The relay contacts are also carried to the 4-pin plug connector.

The illustration shows the assignment of the 4-pin plug connector for the power supply and the relay contacts.

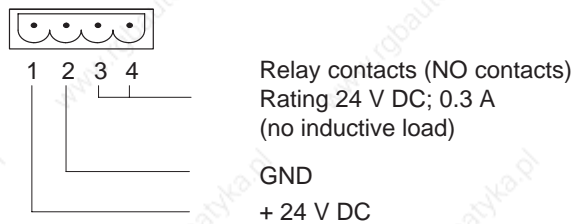

Caution

- With a 24 V supply, make sure that the extra-low voltage is safely isolated. Use only power supply units complying with IEC 364-4-41 or HD 384.04.41 (VDE 0100, Part 410).
- The supply voltage must be within the specified voltage range. Voltages outside this range can cause malfunctions.

Temperature monitoring for OP37

A sensor monitors the temperature on the inside of the OP37. The contacts of the internal relay close if the temperature exceeds the permissible limit value. The relay contacts are carried to a 2-pin plug connector. This connector can be used to drive an external fan, for instance.

The diagram illustrates the assignment of the 2-pin plug connector.



Ground connection

Connect the ground connection  of the OP to the cabinet ground. To do so, use the grounding screwdriver supplied with the OP.

13.1.1 Connecting the Configuration Computer

Connection configuration

In order to download the configuration, a connection between the configuration computer (PU or PC) and OP must be established. There are two connection options available for this:

- the serial connection of a configuration computer to the OP interface IF2 (serial downloading),
- the connection of a configuration computer to the OP interface IF1B (MPI downloading). In this case, the configuration computer and OP are connected to the MPI network. A condition for this is that a configuration already exists on the OP.

Both connections serve for downloading the firmware and configuration data (Chapter 14.2). Standard cables are available for the connections shown (refer to the ST80.1 catalog).

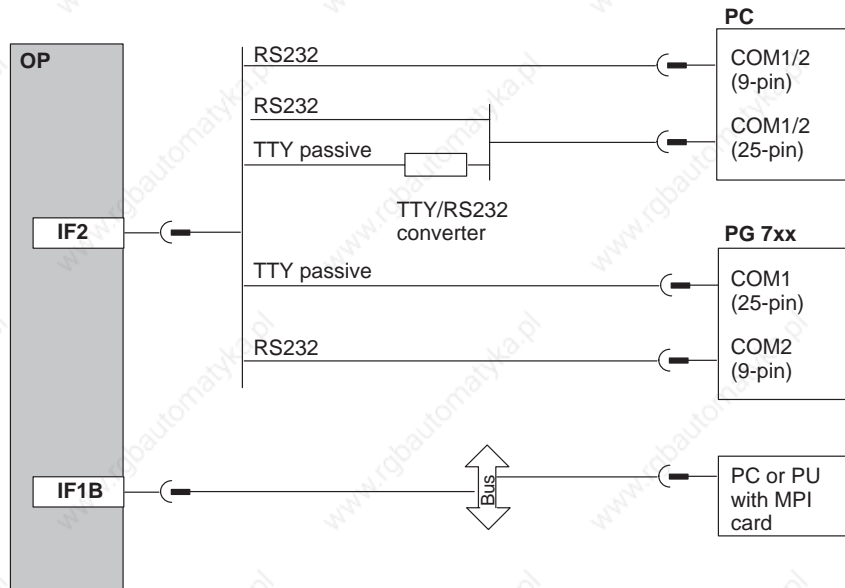
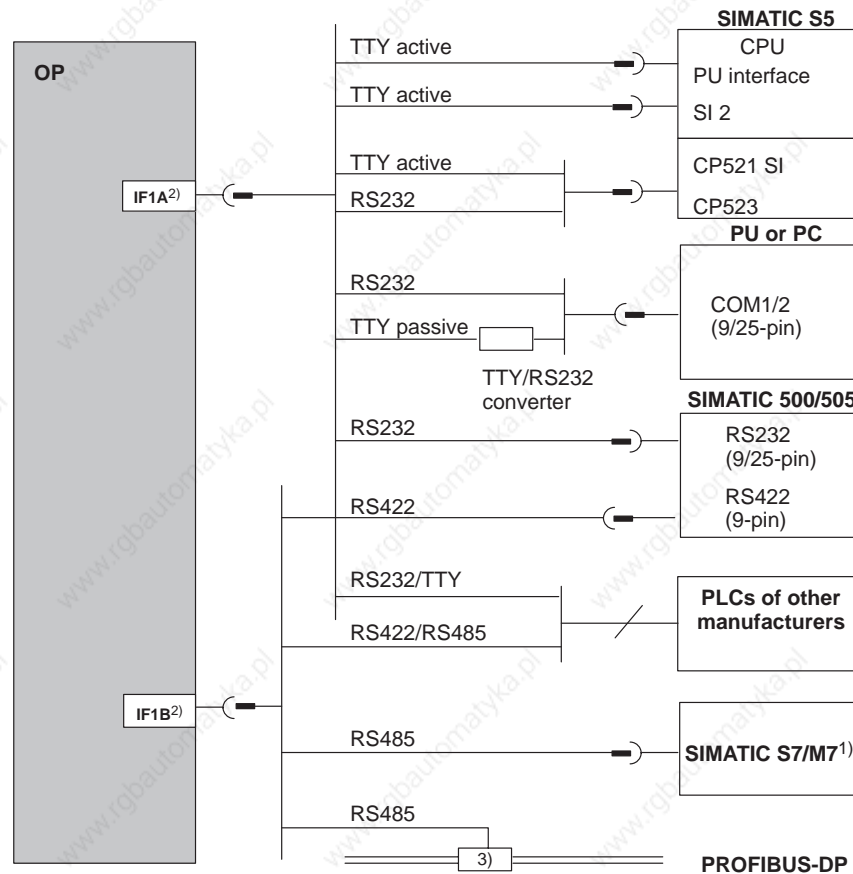

Figure 13-2 Connection configuration diagram for configuration computer

13.1.2 Connecting the PLC

Connection configuration

Figure 13-3 illustrates the basic connection possibilities between the OP and PLC. Standard cables are available for the connections shown (refer to the ST80.1 catalog).







- 1) Use only the approved cables for connection to SIMATIC S7/M7.
- 2) For operation via the serial interface, connect either IF1A (RS232/TTY) or IF1B (RS422/485), but not both. The IF1B interface is configured by means of DIL switches.
- 3) Any PROFIBUS-DP bus terminal (except FSK)

Figure 13-3 Connection configuration diagram for PLCs

Configure interface IF1B

The IF1B interface can be configured by using the DIL switches, located beside the 9-pin Sub-D connector. This interchanges the RS422 receive data and the RTS signal. By default, the RTS signal is not required by the communication peer.

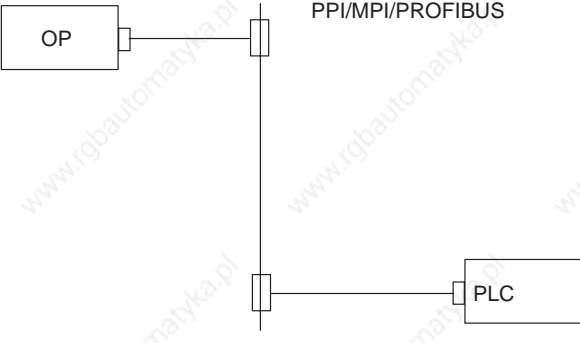
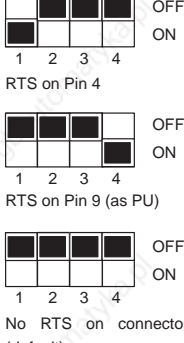
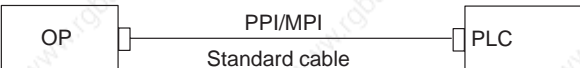
The table shows the permissible DIL switch settings.

Communication	Switch Setting
	
	
	

13.1.3 Connecting a Printer

Connection configuration

Figure 13-4 illustrates the connection of a printer to the serial and parallel printer interfaces of the OP:

- Serial connection: **IF2**
- Parallel connection: **LPT (OP37 only)**

Cable sets are available for connecting Siemens printers (refer to the ST80.1 catalog). When connecting printers from other manufacturers, use the cables supplied or specially made cables.

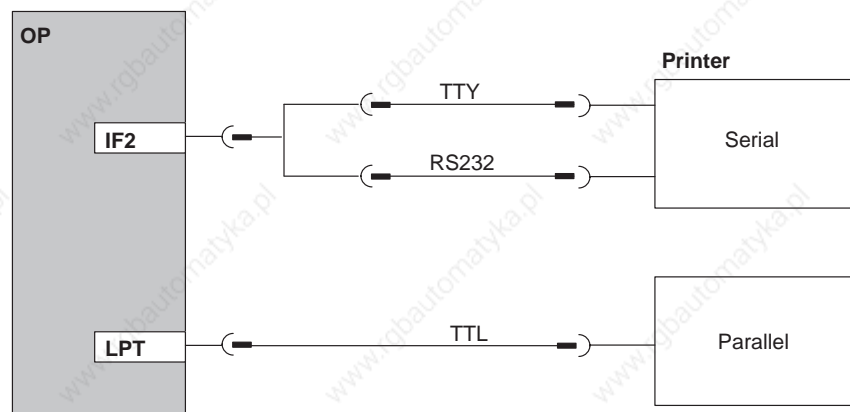

Figure 13-4 Connection configuration diagram for printers

Note

Use only a cable with braided metal shield grounded at each end for connecting the OP and the printer.

Printer settings

Set the printer type and the transfer parameters on the OP using the *Printer Settings* standard screen (refer to Chapter 7).

With some printers, it may also be necessary to define the ASCII character set used in the configuration on the printer, too.

14

Commissioning

Flowchart

The commissioning guide below explains the individual steps for commissioning the OP27 and OP37. Figure 14-1 provides a diagram of the most important steps for initial startup, recommissioning and normal operation of the OP.

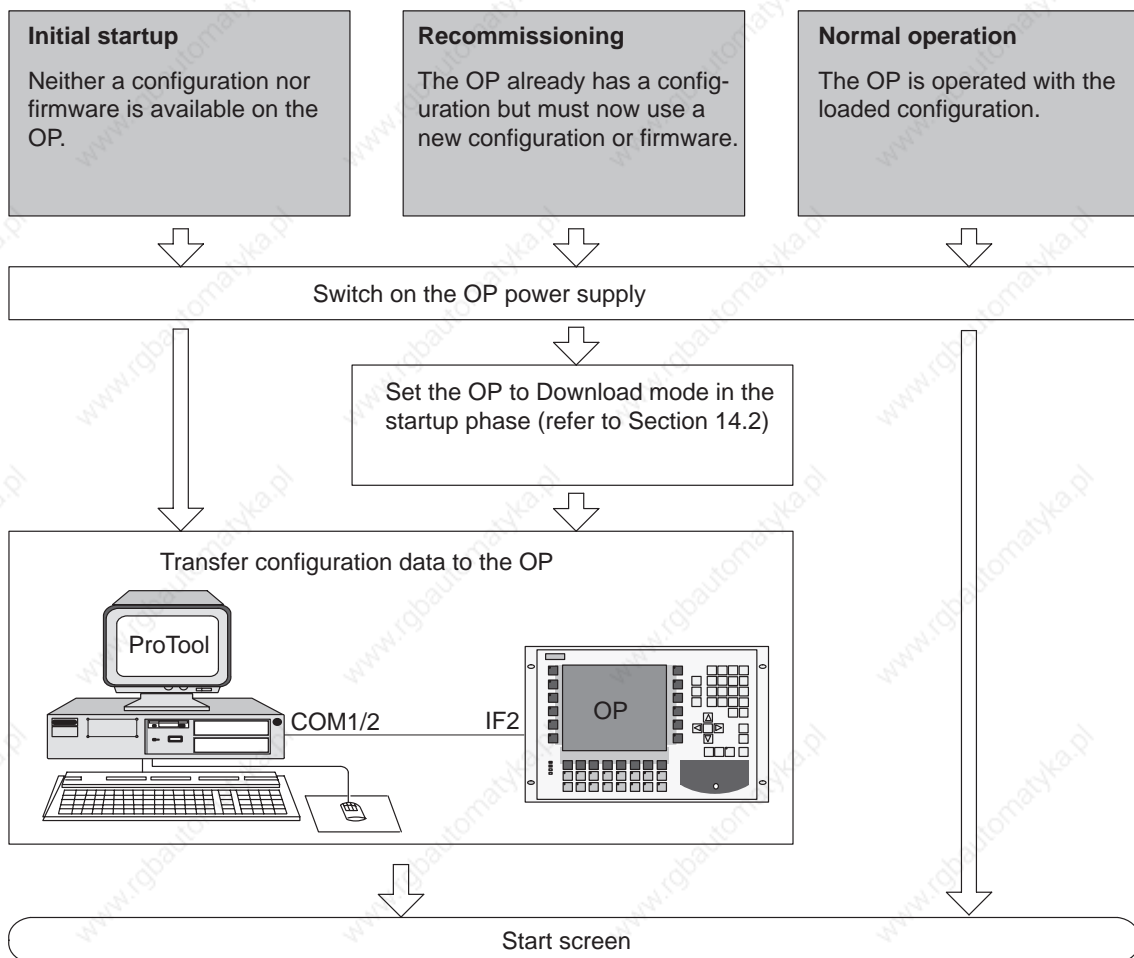

Figure 14-1 Commissioning flowchart

Before commissioning



Before commissioning the OP, please observe the following:

Caution

- With the SIMATIC S5, compression of the internal program memory on the PLC (PU “Compress” function, integrated FB COMPR) is not allowed when an OP is connected. Compression modifies the absolute addresses of the blocks in the program memory. Since the OP only reads the address list during startup, it does not detect any address modifications and accesses the wrong memory areas.

If compression is inevitable during routine operation, switch off the OP prior to compression.

- In hazardous areas, always de-energize the OP before unplugging connectors.

14.1 Initial Startup

Procedure

The firmware and configuration must be downloaded to the OP when it is started up for the first time. Proceed as follows:

Step	Action
1	Switch on the OP power supply. As a configuration has not yet been loaded, the OP automatically switches to Download mode and waits for data to be downloaded from the PC or PU. The message <code>READY FOR SERIAL TRANSFER</code> appears. The OP cannot be operated in Download mode.
2	Connect the IF2 interface (RS232/TTY) on the OP to the PU or PC by means of a suitable standard cable.
3	Start the download operation on the PC or PU to the OP. The OP checks the connection to the PC or PU. If the connection is not available, or not functioning correctly, the OP issues the corresponding error message. If the connection is in order, downloading of the configuration commences. The OP firmware is downloaded automatically. Following successful downloading, the OP restarts and displays the start screen of the configuration that has just been loaded.

Note

For information on which settings are required for the downloading operation, please refer to the *User's Guide ProTool Configuring Graphics Displays*.

14.2 Recommissioning





Types of downloading

When recommissioning, the configuration/firmware already loaded in the OP is replaced by another. Downloading can be performed by means of

- serial download or
- MPI download (for SIMATIC S7).



Serial download

In the case of a serial downloading operation, the configuration/firmware is transferred from the PC/PG to the OP via an RS232/TTY connection.

Step	Action
1	Switch on the OP power supply.
2	<p>Connect the IF2 interface (RS232/TTY) on the OP to the PU or PC by means of a suitable standard cable.</p> <p>There are two ways of setting the OP to Download mode:</p> <ul style="list-style-type: none"> • In routine operation The method of changing to Download mode online using the <i>System Settings</i> standard screen is described in Chapter 11.1. • In the startup phase of the OP Continue at Step 3.
3	<p>Press the following key combination during startup:</p>  <p>The OP changes to Download mode. The uppermost line of the display shows Download mode.</p> <p>Exit from Download mode by using the key depicted on the right provided data is not being downloaded between the PC or PU and the OP.</p>  <p>If the connection is in order, downloading of the configuration commences. The OP firmware is downloaded automatically.</p> <p>Following successful downloading, the OP restarts and displays the start screen of the configuration that has just been loaded.</p> <p>To reset the OP to a defined initial state before downloading the configuration, press the key combination depicted on the right before the OP changes to Download mode.</p>  <p>It is now possible to erase or initialize the data medium. A detailed description of how to do this is provided in Section 9.2.</p> <p>Press the key shown on the right to confirm that the data medium should be erased or initialized:</p>  <p>After an erase/initialize operation, the OP changes to Download mode.</p>

MPI download

If a configuration is already loaded for the SIMATIC S7 on the OP, other S7 configurations can be downloaded to the OP via an MPI connection.

Step	Action
1	Switch on the OP power supply.
2	Connect interface IF1B on the OP to the PC or PU using a standard cable (refer to Section 13.1.2, <i>Configuring interface IF1B</i>). If the OP and PC or PU have been incorporated on the MPI bus, it is not necessary to switch cables for the download operation.
3	Position the cursor on the <i>System Settings</i> standard screen at the <i>Operating Mode</i> symbolic input field. Select <i>MPI Download</i> mode from the selection box.
4	The OP restarts, displaying the menu illustrated in Figure 14-2 and waits for data to be downloaded from the PU or PC. Providing data is not being downloaded to the OP, it is possible to: <ul style="list-style-type: none"> exit from the MPI download operation by pressing the key depicted on the right and continue the boot operation  or press the key assigned to the icon depicted on the right to start the serial download operation. 
5	Before downloading, select a baud rate between 9.6 kBd and 1.5 MBd, selecting from the <i>MPI baud rate</i> input field, if necessary. The same baud rate must be set on the OP as on the PC/PU.
6	Start the download operation to the OP on the PC or PU. The procedure is described in the <i>ProTool User's Guide Configuring Graphics Displays</i> . The OP checks the connection to the PC or PU. If the connection is not available, or not functioning correctly, the OP issues the corresponding error message. If the connection is in order, downloading of the configuration firmware commences. Following successful downloading, the OP restarts and displays the start screen of the configuration that has just been loaded.

M P I D O W N L O A D	
MPI Baud Rate:	187.5 kBaud
MPI OP Station Address:	2
Tel.:	FF
Download Address:	FF
serial-Downl.	ESC

Figure 14-2 Settings in operating mode *MPI Download***Fault diagnosis**

A fault occurring during commissioning or operation is normally displayed on the OP by means of a system message.

Appendix D of this manual contains a list of some of the most important system messages and explanations on how to eliminate them.

Data backup

The operating data of the OP (tag values, message buffer) is stored in a buffered SRAM and retained even in the event of a power failure. Operating data is not lost if the power supply is turned off or fails.

14.3 Startup Behavior

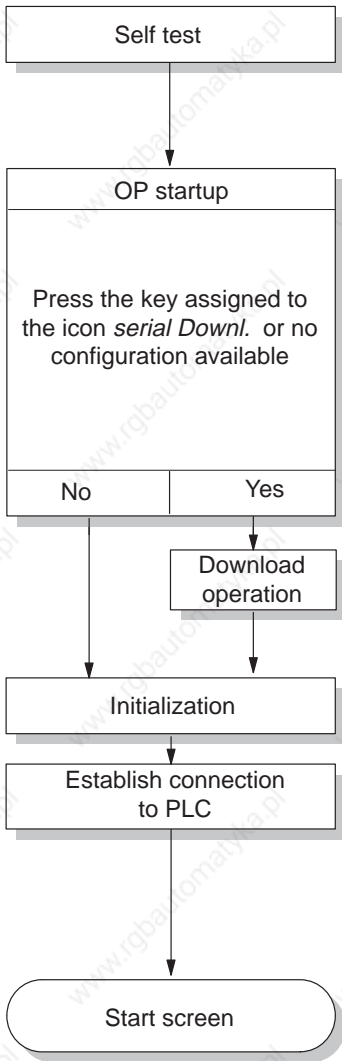

After the power supply has been switched on, the OP performs a self test. In the test, it checks the operability of the most important OP components and displays the test results. The test results are then deleted.

If a configuration is not present, the OP automatically switches to Serial Download mode.

The OP then performs various internal initializations.

In this phase of startup, the OP attempts to establish a connection to the PLC.

If communication is not possible (e.g. cable to the PLC has not been connected) the OP displays a system message.

Following startup, the OP displays the configured start screen.

14.4 Testing a Configuration in OFFLINE Mode

Purpose

In operating mode *OFFLINE*, individual functions and configurations downloaded from the PC/PU to the OP can be tested without being influenced by the PLC. Variables are not updated in *OFFLINE* mode.

Action

Step	Action
1	Set the <i>OP</i> to <i>OFFLINE</i> mode using the System Settings standard screen.
2	Check all the configured screens for correct presentation.
3	Check the screen hierarchy.
4	Check the input fields.
5	Test the soft keys.
6	Test the function keys.

End of test

If faults occur when executing the individual steps, download the configuration again.

14.5 Testing the Configuration in Conjunction with the PLC

Test with PLC connected

Test the OP interaction with the connected PLC. This checks that the correct data areas have been configured.

Step	Action
1	Connect the OP to the PLC. A message on the OP indicates that it has been connected successfully.
2	Acknowledge this message.
3	Set the OP in <i>ONLINE</i> mode using the <i>System Settings</i> standard screen. All the items contained in the configuration that are necessary for communication with the PLC can then be tested. Depending on the configuration, these might be: <ul style="list-style-type: none">• event and alarm messages• buffers for event messages and alarm messages• print functions• automatic message logging• screen selection etc.

OP37 in DOS Mode

Use

The OP37 is also designed for use in DOS mode. It can be used for different applications. The default settings apply to operation with a configuration created in ProTool. The OP37 can be used for applications which run under both DOS or Windows. These applications might be:

- programming software
- a standard application or
- a customized application.

Conditions

In order that the OP37 can be used in DOS mode, a data medium, such as disk, hard disk or PCMCIA hard disk must be available. Set one of these data media as the boot medium in Setup. Also, connect a keyboard and possibly a mouse as well. An MF2 keyboard can be connected to the front connector. A PS2 connector is available at the rear of the OP37 for connecting a PS2 keyboard, and there is another connector for connecting a PS2 mouse.

15.1 Specific OP37 Settings in BIOS Setup

In order that the OP37 can be used flexibly, a page containing the OP37-specific settings has been added to the general BIOS Setup. These extensions are described in the following paragraphs. All the other pages in the BIOS Setup contain the default settings for PCs and should not be modified.

The page containing the OP37-specific settings is called *OP Extension*. The most important setting on this page is the boot medium setting. This is used to change between OP mode and DOS mode. It is also possible to customize the interfaces.

Startup

The boot medium is set up at this point. The parameters have the following significance:

- **OP firmware**
The OP37 starts up with this setting in OP mode.
- **DISK**
The OP37 starts up with this setting in DOS mode. If there is a floppy disk in the drive, the OP37 boots from floppy disk. If there is no floppy disk, the OP37 boots from hard disk.
- **PCMCIA:HD**
The OP37 starts up with this setting in DOS mode. The OP boots from PCMCIA hard disk.

Interface

If modules or applications are installed which require a specific setting for the serial interfaces, the interfaces can be correspondingly configured. The UART address (COM1 to COM4), the interrupt and the physical level can be freely assigned.

Parallel port



The address and the interrupt for the parallel interface can be set in the same way as with the serial interfaces.

ASPC2

The interrupt for the interface module which supports the PROFIBUS-DP is set here.

Call BIOS setup

In order to call in and operate the Setup, an MF2 keyboard must be connected. Call the *OP Extension* Setup page in the following manner:

Step	Action
1	Turn on the OP37 and wait until RAM testing starts .
2	Press the following keys on the MF2 keyboard at the same time: 
3	Using the arrow keys, select the menu item <i>OP Extension</i> from the main menu and confirm the selection by pressing:  The <i>OP Extension</i> page is opened.

Operate BIOS setup

Operations can only be carried out in Setup via the keyboard.

Individual input fields in the BIOS Setup are selected by pressing:



Apply the setting specified by pressing:



Scroll through the definable values with the arrow keys. Some fields allow direct input from the keyboard.

Default button

After clicking on the *Default* button, the PC standard configuration and operating mode OP mode (OP firmware) are set.

15.2 Changing Between OP and DOS Modes

Change from OP mode to DOS mode

Proceed as follows to switch from OP mode to DOS mode:

Step	Action
1	Press the three arrow keys depicted on the right simultaneously while the OP is starting up. 
2	The OP then requests the boot medium. Select: <ul style="list-style-type: none"> • Disk for hard disk/floppy disk drive • PCMCIA: HD for memory module.
3	The OP then boots from the medium specified and starts up again, this time in DOS mode. This presupposes that the medium has been formatted as a boot medium. The DOS mode setting remains stored for future startups of the OP37.

Changing from DOS mode to OP mode

Switching from DOS mode to OP mode is performed using the BIOS Setup, as described in Chapter 15.1.

EQUIPMENT DESCRIPTION AND MAINTENANCE

Part IV

16 Equipment Description OP27

17 Equipment Description OP37

18 Options

19 Maintenance

16

OP27 Unit Description

In this chapter

This chapter provides information on:

- dimensions
- operating and display elements
- connection elements and
- communication options

16.1 Dimensions

Equipment dimensions

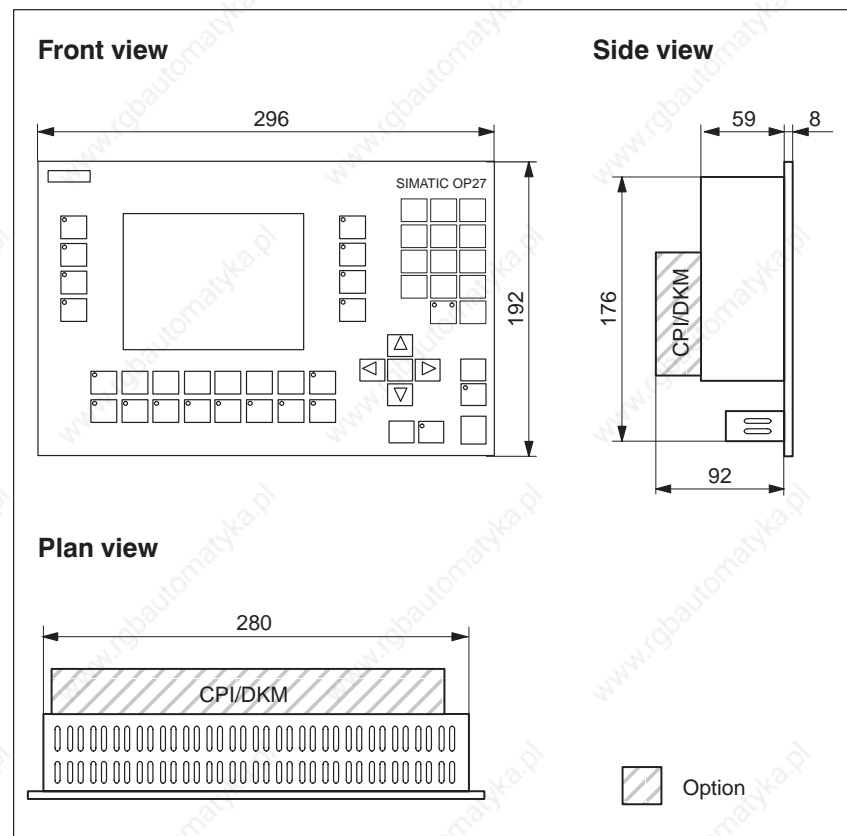

Mounting cutout

The OP27 requires a mounting cutout (WxH) of 282^{+1} mm x 178^{+1} mm.

16.2 Operating and Display Elements

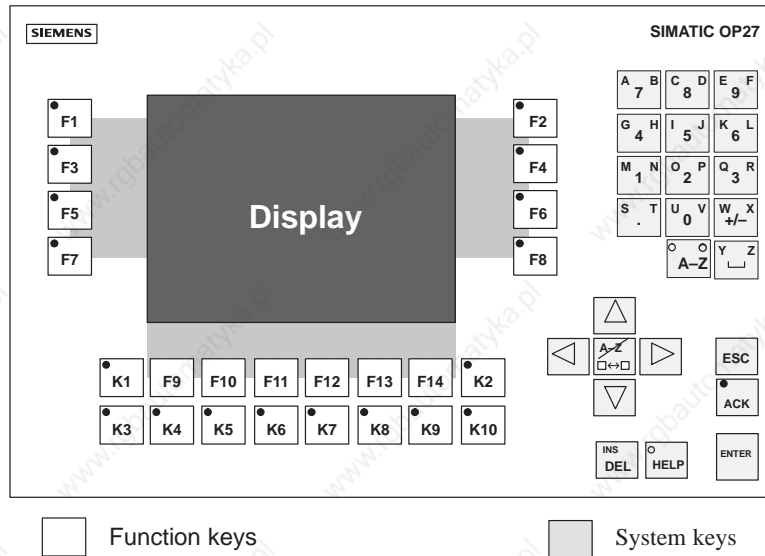

Figure 16-1 Operating and display element arrangement

Name	Description
Display	LC display (color or monochrome STN) with back-lighting. The resolution is 320x240 pixels.
System keys	24 system keys with permanent functions
Function keys	24 configurable function keys (18 having an LED) User-specific labeling by means of labeling strips

16.3 Connection Elements

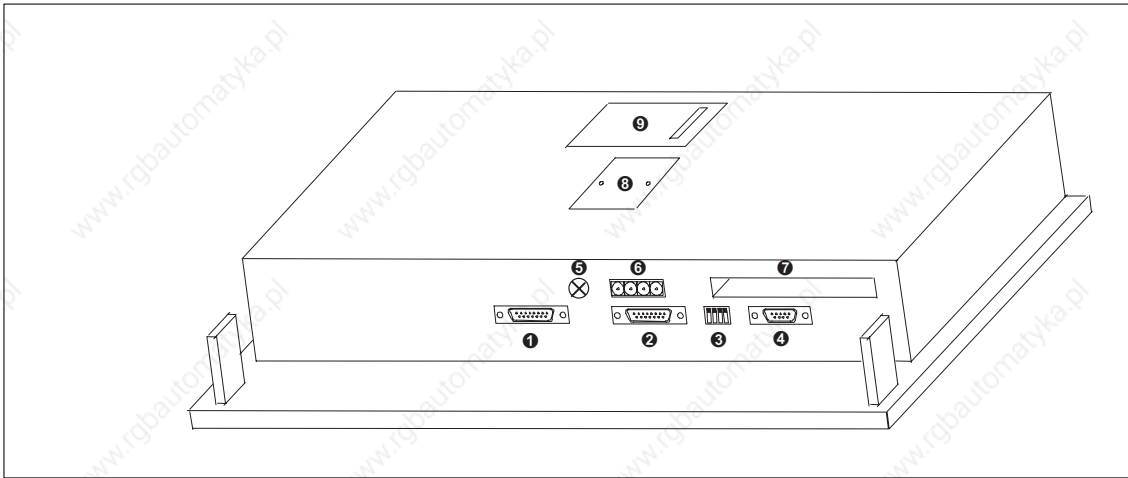

Figure 16-2 OP27: Arrangement of connections

No.	Name/Purpose	Description	
① ② ④	Serial interfaces ¹⁾ : • IF1A • IF2 • IF1B	Level	Usage
		RS232/TTY (active/passive)	PLC
		RS232/TTY (active/passive)	PC, PU, printer
③	DIL switch	RS422/RS485	PLC
⑤	Chassis ground	For setting serial interface IF1B (refer to Appendix B). Set and check with the table in Section 13.1.2, <i>Configuring the IF1B interface</i> .	
⑥	Power supply/relay output	-	
⑦	PCMCIA slot	Power supply (+ 24 V DC) and contact assemblies (For pin assignment, refer to Section 13.1).	
⑧	DKM or CPI (optional)	For JEIDA/PCMCIA cards.	
⑨	Battery compartment (covered)	For connecting a direct key module with 8 digital outputs or a control panel interface with max. 16/32 digital inputs/outputs.	
		-	

1) The connection plug pin assignment is described in Appendix B.

16.4 Communication Options

Connection	Interface
SIMATIC S5 – AS511 (TTY) – FAP (TTY/RS232) – PROFIBUS-DP	IF1A IF1A IF1B
SIMATIC S7/M7 – PPI – MPI – PROFIBUS-DP	IF1B IF1B IF1B
SIMATIC 500/505 – RS232 – RS422/RS485	IF1A IF1B
Other PLCs – RS232/TTY – RS422/RS485	IF1A IF1B
PC or PU (TTY/RS232)	IF2
Printer – TTY/RS232	IF2

16.5 Labeling Function Keys

State on delivery

The function keys on the OP27 are labeled ex-works as follows:

- F1 to F14
- K1 to K10

A set of unlabeled strips is enclosed with the OP. This means that the keys on the OP can be labeled according to individual systems.

Replacing labeling strips

Proceed as follows to replace the labeling strips:

1. Lay down the device with its front plate facing downwards.
2. Remove the labeling strips to be replaced from the unit.
3. Insert the new strips **1** with the inscription facing downwards into the slits at the rear of the front plate (see Figure 16-3).

Note

Labeling on strips must be smudge-proof before they are inserted. If a keyboard overlay is soiled on the inside, it cannot be cleaned and has to be returned to the works for replacement.

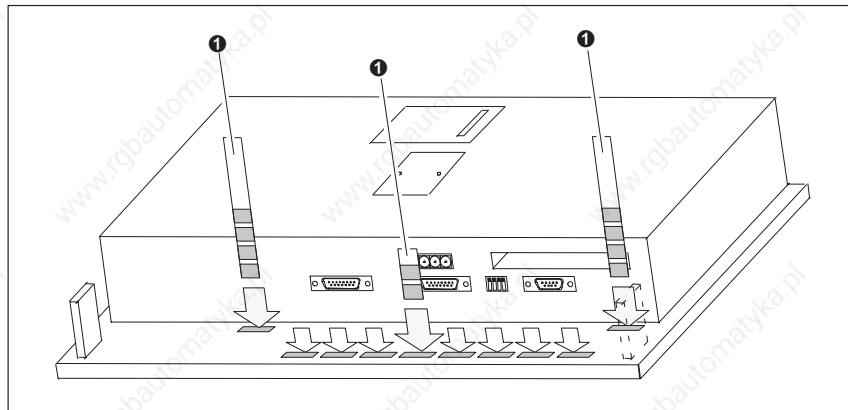

Figure 16-3 Inserting labeling strips

Make labeling strips

Use transparent foil to make labeling strips so that the LEDs in the function keys remain visible. Use a printer or a smudge-proof foil pen to label the foil. Cut the strips as shown in the examples illustrated in Figure 16-4.

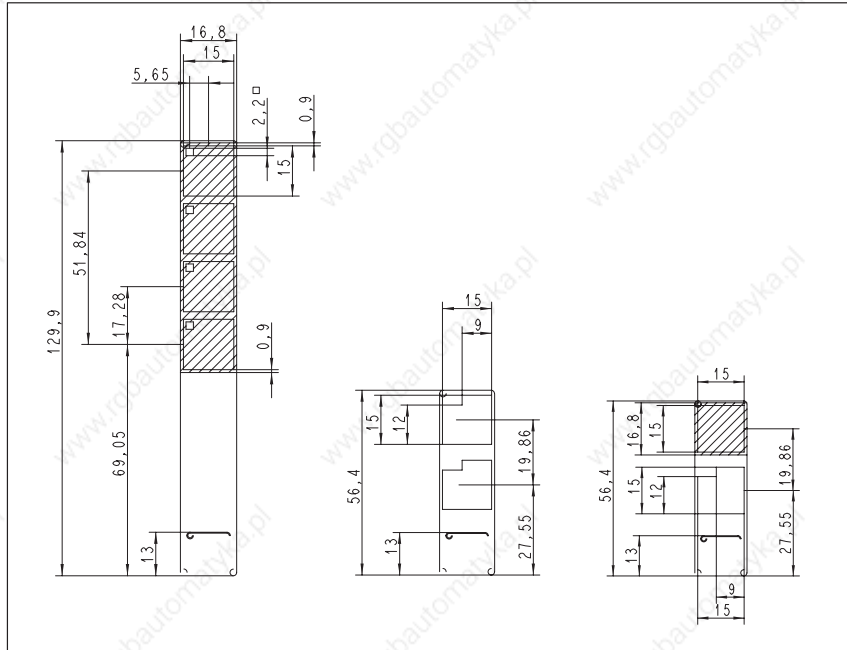

Figure 16-5 Dimensions of labeling strips for OP27

File

Included with the ProTool configuration software is the directory PROTOOL\UTILITY containing the Word[®] file SLIDE_27.DOC. The file contains formatted samples for labeling the function keys on the OP27. This means individual labeling strips can be edited and printed.

OP37 Unit Description

In this chapter

This chapter provides information on:

- dimensions
- operating and display elements
- connection elements and
- Communication options

17.1 Dimensions

Unit Dimensions The following figure illustrates the OP37, with dimensions, in three views.

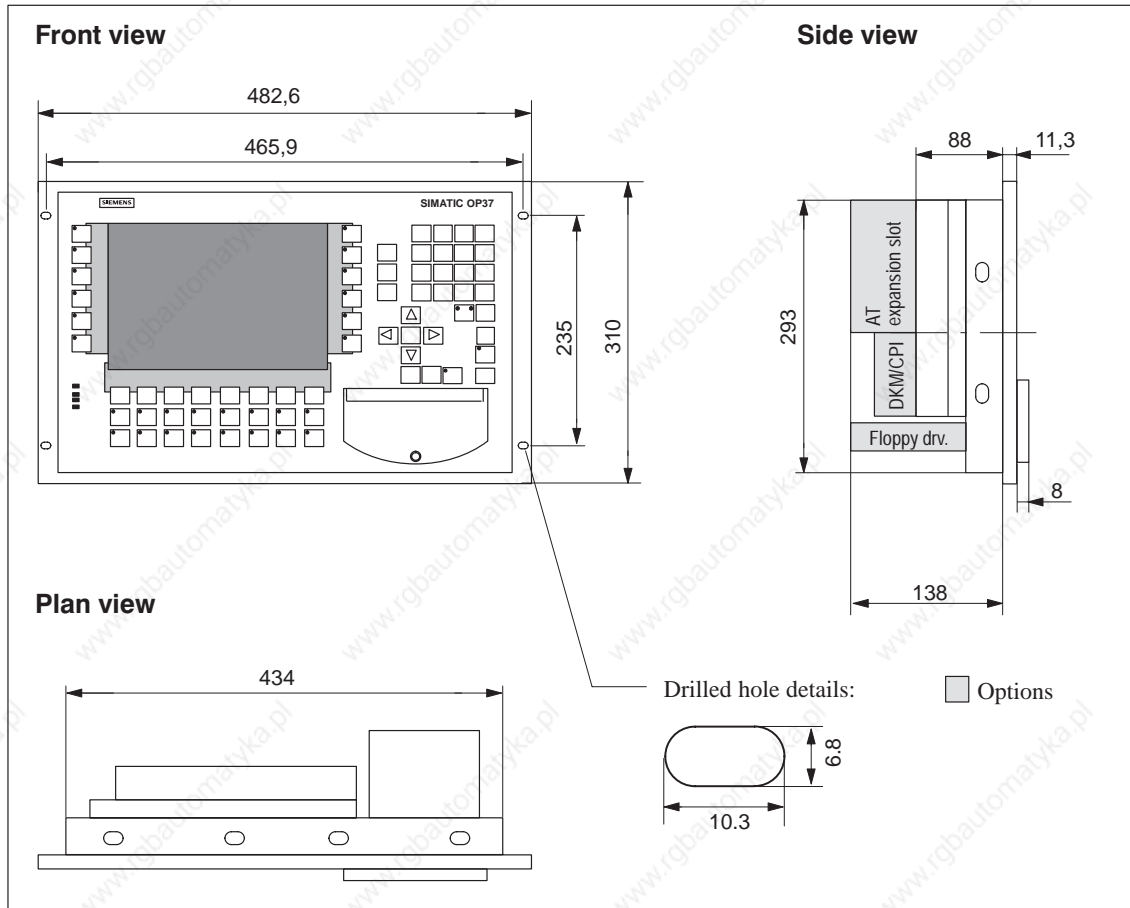

Mounting cutout

The OP37 requires a mounting cutout (WxH) of 436^{+1} mm x 295^{+1} mm.

17.2 Operating and Display Elements

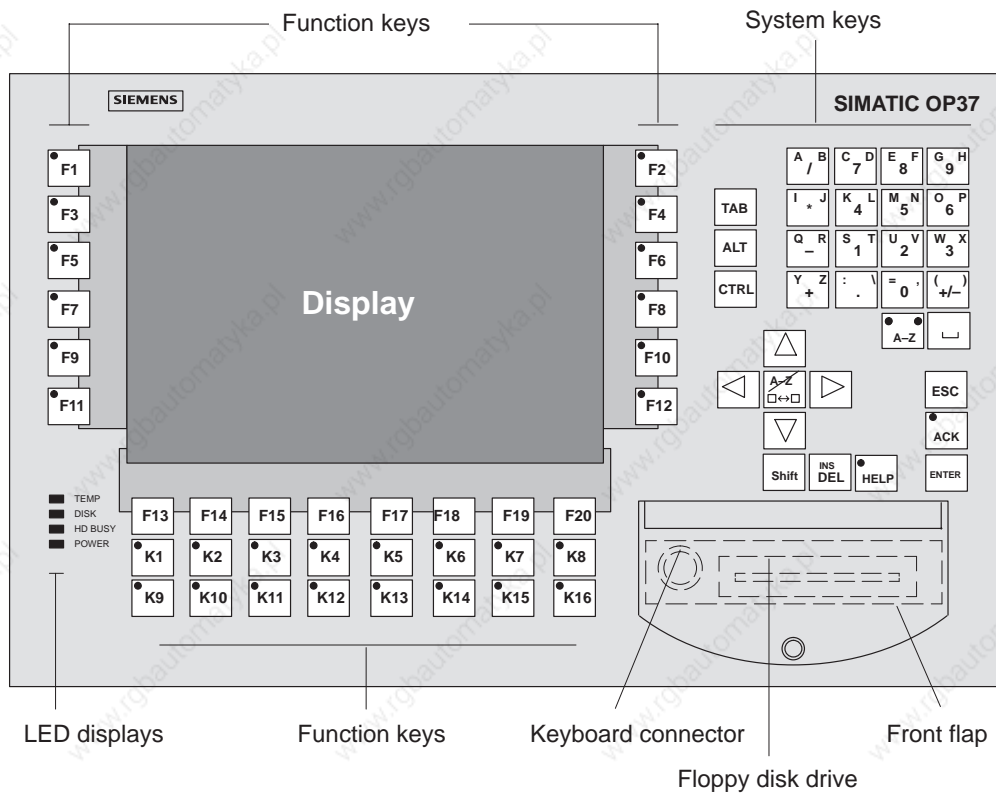

Figure 17-1 Operating and Display Element Arrangement

Name	Description
Display	LC display (color TFT/C-STN) with back-lighting The definition is 640x480 pixels.
System keys	32 system keys with permanent functions
Function keys	36 configurable function keys (28 having an LED) User-specific labeling by means of labeling strips
LED displays	TEMP Internal temperature above permissible limit values DISK Write/read access to PCMCIA module HD BUSY Write/read access to hard disk POWER OP The OP is operating.
Floppy disk drive (Option)	3½" drive for HD floppy disks (1.44 MB)
Keyboard connection	MF2 keyboard for BIOS Setup and DOS mode
Front flap	When closed, IP65 degree of protection

17.3 Connection Elements

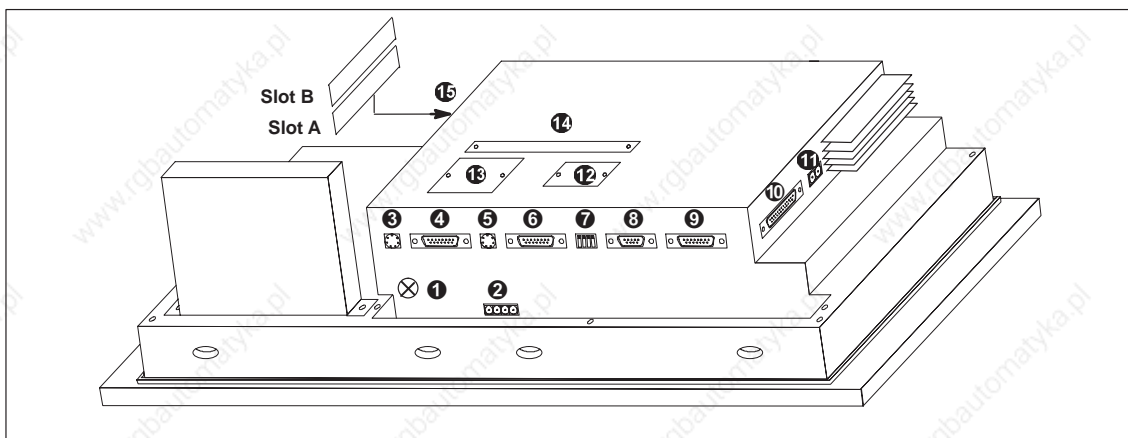

Figure 17-2 OP37: Arrangement of connections

No	Name	Description	
1	Chassis ground	-	
2	Power supply/Relay output	Power supply (+ 24 V DC) and contact assemblies for driving a horn or a light, for example.	
3	PS2 keyboard connection	For DOS mode only	
4 6 8 9	Serial interfaces IF1A IF2 IF1B IF3	Level	Usage
		V.24/TTY (active/passive)	PLC
		V.24/TTY (active/passive)	PC, PU, printer
		RS422/RS485	PLC
9	IF3	TTY (passive)/RS422/RS485	Not used at present
5	PS2 mouse connection	For DOS mode only	
7	DIP switch	For setting serial interface IF1B (refer to Appendix B). Set and check with the table in Section , 13.1.2Configuring the IF1B interface.	
10	Parallel interface LPT1	For parallel printer	
11	Relay output	Contact assembly for temperature monitoring and driving a light or an auxiliary blower, for example. The relay is tripped when the outside temperature reaches 45 °C.	
12	Battery compartment (covered)	-	
13	Direct key module or CPI (optional)	For connecting a direct key module with 12/ 16 digital outputs or a control panel interface with max. 16/32 digital inputs/outputs.	
14	AT expansion slot connection	Connection of an AT expansion slot for accommodating two short AT cards. (The AT expansion slot is not supported by the OP firmware.)	
15	PCMCIA Slot A and Slot B	For JEIDA/PCMCIA cards (Slot A is for DOS mode only, Slot B for OP and DOS modes)	

17.4 Communication Options

Connection	Interface
SIMATIC S5 – AS511 (TTY) – FAP (TTY/RS232) – PROFIBUS-DP	IF1A IF1A IF1B
SIMATIC S7/M7 – PPI – MPI – PROFIBUS-DP	IF1B IF1B IF1B
SIMATIC 500/505 – RS232 – RS422/RS485	IF1A IF1B
Other PLCs – RS232/TTY – RS422/RS485	IF1A IF1B
PC or PU (TTY/RS232)	IF2
Printer – TTY/RS232 – TTL	IF2 LPT

17.5 Labeling Function Keys

Labeling OP37 Function Keys

The function keys on the operator panel are labeled ex works as follows:

- F1 to F20 and
- K1 to K16.

A set of unlabeled strips is enclosed with the OP. This means that keys on the OP can be labeled according to individual systems.

Replacing labeling strips



Proceed as follows to replace the labeling strips:

1. Set the unit down with its front plate facing downwards.

Caution

Make sure that the OP is disconnected from the power supply.

2. Remove the screws indicated in Figure 17-3 as ① .

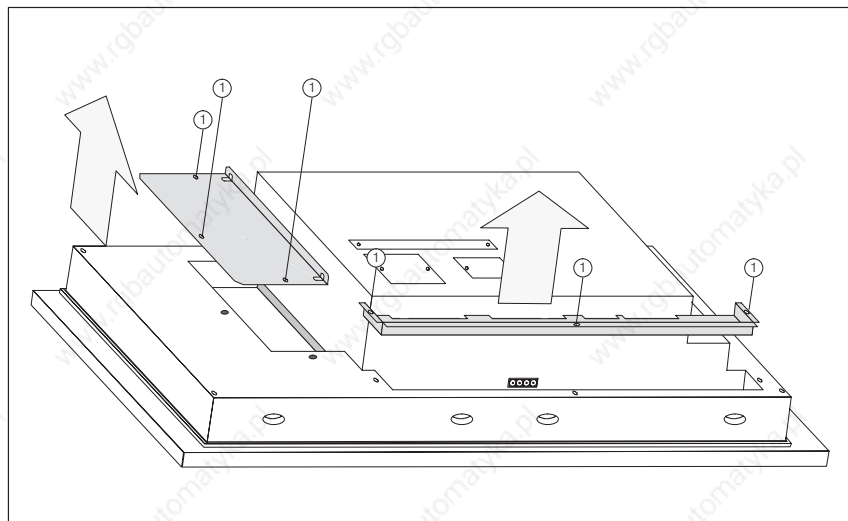

Figure 17-3 Undo screws

3. Remove the covers.
4. Extract the labeling strips to be replaced.
5. Insert the new strips ② with the inscription facing downwards into the slits on the front plate (see Figure 17-4).

Note

Labeling on strips must be smudge-proof before they are inserted. If a keyboard overlay is soiled on the inside, it cannot be cleaned and has to be returned to the works for replacement.

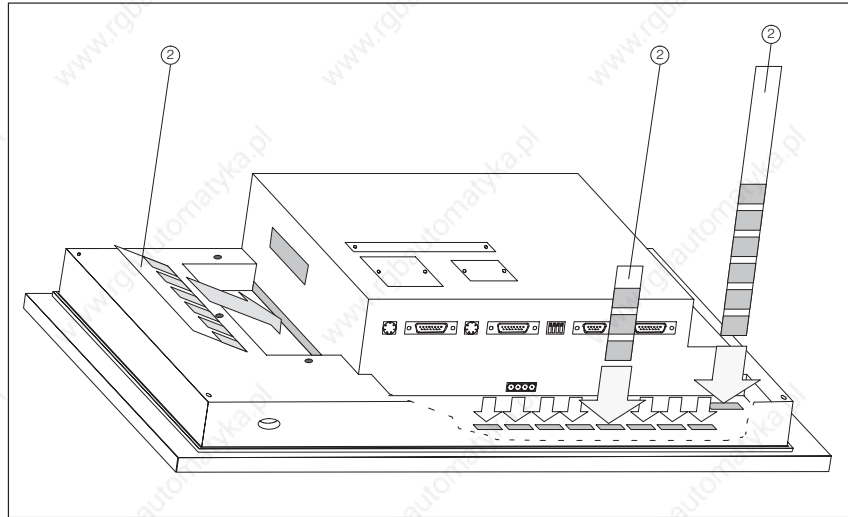

Figure 17-4 Inserting Labeling Strips

6. Screw the covers back on after inserting the labeling strips.

Make labeling strips

Use transparent foil to make labeling strips so that the LEDs in the function keys remain visible. Use a printer or a smudge-proof foil pen to label the foil. Cut the strips as illustrated in the examples in Figure 17-5.

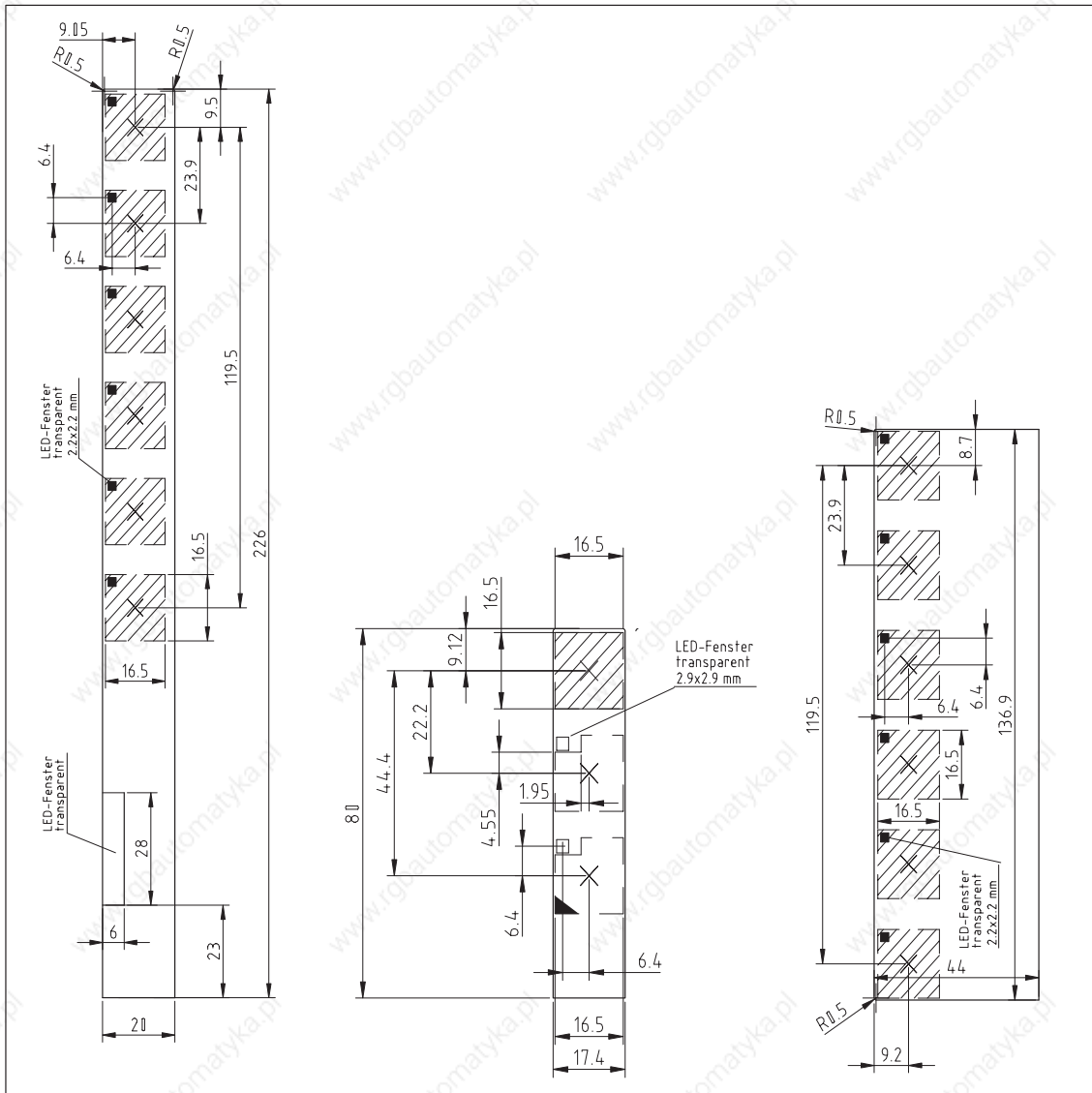

Figure 17-6 Dimensions of Labeling Strips for OP37

File

Included with the ProTool configuration software is the Word™ file SLIDE_37.DOC. The file contains formatted samples for labeling the function keys on the OP37. This means labeling strips can be individually edited and printed.

Options

18

This chapter contains descriptions of the following units which can be optionally connected:

- AT expansion slot (for OP37 only)
- Direct Key Module (DKM)
- Control Panel Interface (CPI)

18.1 AT Expansion Slot (OP37 only)

The optionally available AT expansion slot for the OP37 can be installed to accommodate two 2/3-long 16-bit AT cards.

The AT expansion slot is screwed to the rear of the OP37. It can be retrofitted at any time.

Functionality of the AT slots

The slots are not supported by the OP37 firmware. AT cards which can be inserted include communication cards (CP5411, CP5412, MPI card), for example.

Installing AT expansion slots and AT cards



Carry out the following steps to install an AT expansion card:

Caution

- Make sure that the OP is disconnected from the power supply.
- Always follow the ESD guidelines in the Appendix when working on open equipment.

1. Set the unit down with its front plate facing downwards.
2. Remove the two screws ❶ and then remove the cover ❷ indicated in Figure 18-1 from the rear panel of the OP. Return the screws to the same position in the housing.

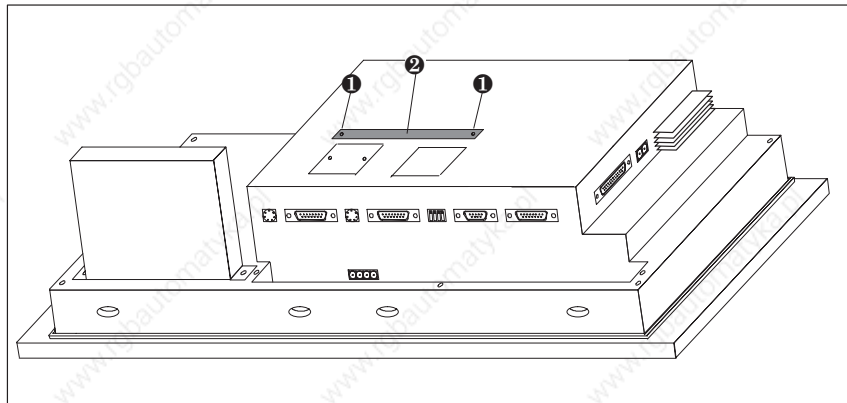

Figure 18-1 Remove the cover

3. Insert the AT expansion slot using the plug-and-socket device into the socket located under the cover ❷ in Figure 18-1.

- Secure the AT expansion slot to the OP (Figure 18-2) using two of the four screws enclosed ④.

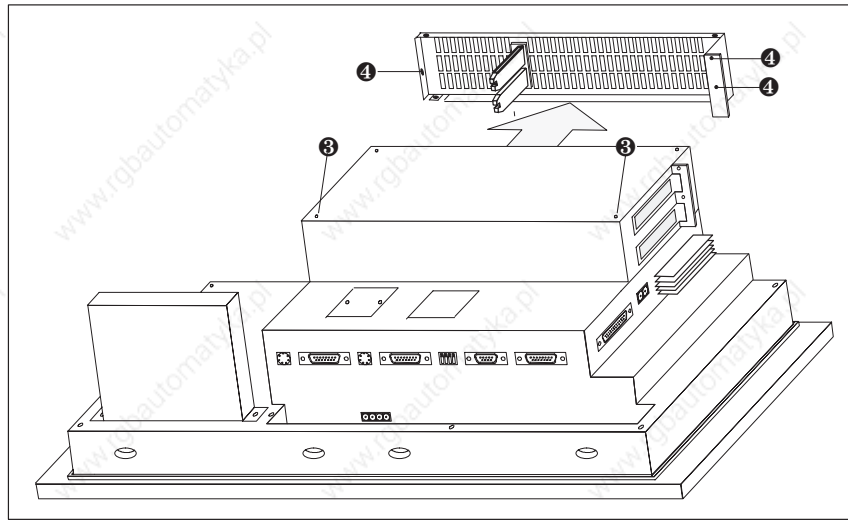

Figure 18-2 Remove the side panel

- Undo the three screws ④ (see Figure 18-2) and remove the side panel.
- Insert the AT cards carefully into the expansion slot so that the interface sockets are positioned at the AT expansion slot interface cutout designed for them. The fixing bracket of the AT card must be flush with the front support for the side panel.

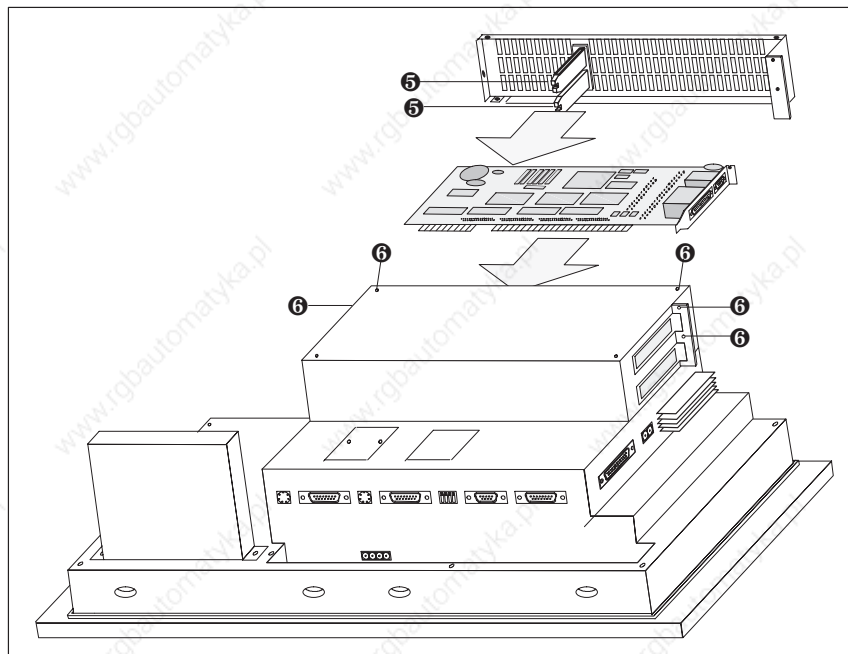

Figure 18-3 Insert the AT Card and secure the side panel

7. Fit the side panel so that the sliders **5** firmly position the edges of the inserted AT cards. Secure the side panel using five screws **6** (Figure 18-3).
8. Connect the peripheral unit to the AT cards.

The AT cards and the AT expansion slots are disassembled in the reverse order.

18.2 Direct Key Module

A Direct Key Module (DKM) is available as an option for connection to operator panels OP27 and OP37. The following versions are possible:

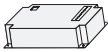
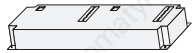
Operating unit	Direct key module with	
	8 outputs	16 outputs
OP27		—
OP37	—	

The housing is screwed to the rear of the OP. It can be retrofitted at any time.

Function of the direct key module

The Direct Key Module (DKM) must be implemented where fast keyboard operation is required without any communication-related delays. Example: Direct key control for jog operation.

The direct keys can be driven by hardware or software.

- The hardware-based operation of the direct keys (typing mode) is performed by the directly wired OP function keys located to the left and right of the display. There are eight function keys on the OP27 and twelve on the OP37.
- Direct keys can also be operated via software using messages, if configured in ProTool.

The direct key module provides the following digital outputs:

- for operation via software – 1 x 8 (OP27) or 2 x 8 (OP37) and
- for operation via hardware – 1 x 8 (OP27) or 2 x 6 (OP37)

Use the DIL switch on the direct key module to select whether operation is to be via software or hardware.

External power supply

The digital outputs are galvanically isolated from the OP by means of opto-couplers. Consequently, the boards require a dedicated voltage supply.

18.2.1 Installing the Direct Key Module

An OP27 or an OP37 can accommodate either a direct key module or a control panel interface (Section 18.3). The procedure for installing a direct key module is as follows:



Caution

- Make sure that the OP is disconnected from the power supply.
- Always follow the ESD guidelines in the Appendix when working on open devices.

1. Set the OP down with its front plate facing downwards.
2. Release the two pop rivets ❶ and then remove the cover ❷ indicated in Figure 18-4 from the rear panel of the OP.

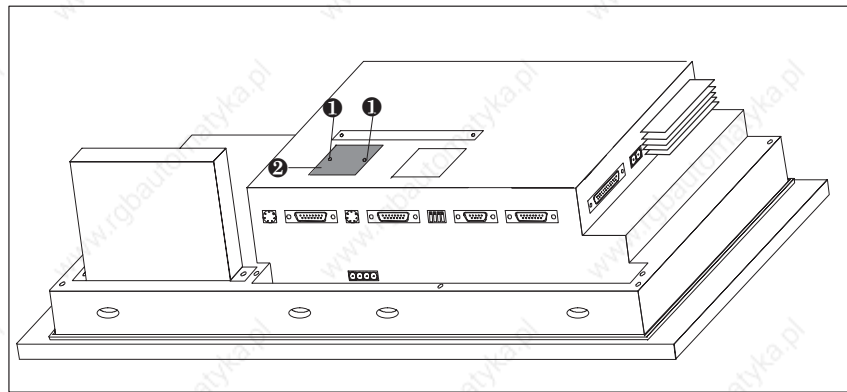

Figure 18-4 Removing the cover (example OP37)

3. Connect the connector of the DKM ribbon cable to the plug connector of the OP in such a way that the color-coded side of the ribbon cable is facing toward the center of the unit (see Figure 18-5).

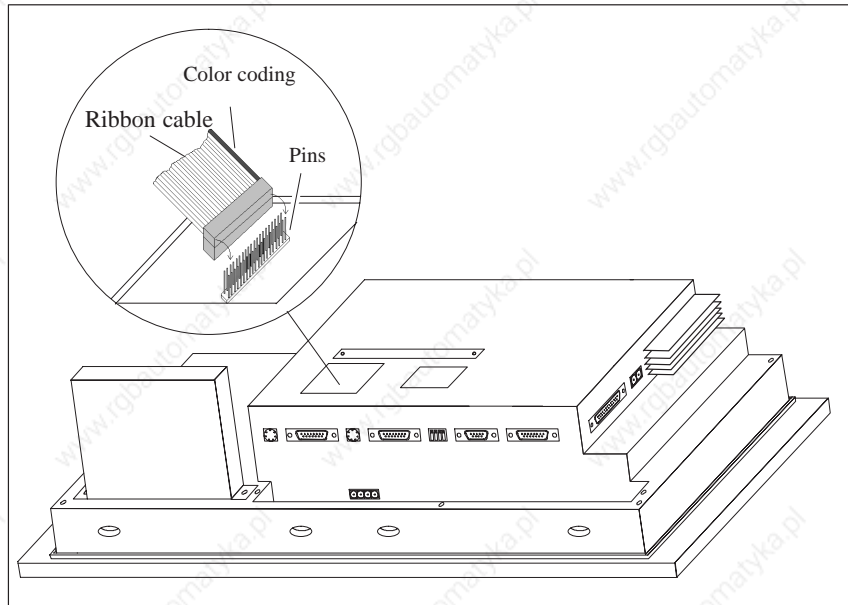

Figure 18-5 Connecting the plug of the direct key module (example OP37)

4. Secure the direct key module to the OP using the four screws supplied ③ (see Figure 18-6).

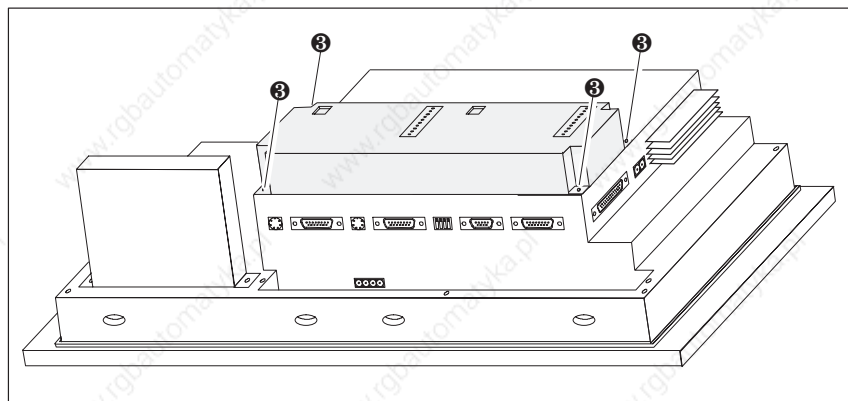

Figure 18-6 Securing the direct key module to the OP (example OP37)

Remove in the reverse sequence of the installation procedure.

18.2.2 Connection and Adjusting Elements

Each module has

- a 10-pin plug connector for connecting the outputs and the external power supply
- a DIL switch for defining whether the outputs are determined by the stroke of a key or by software.

When installed, the plug connector and the DIL switch are located on the rear panel of the OP.

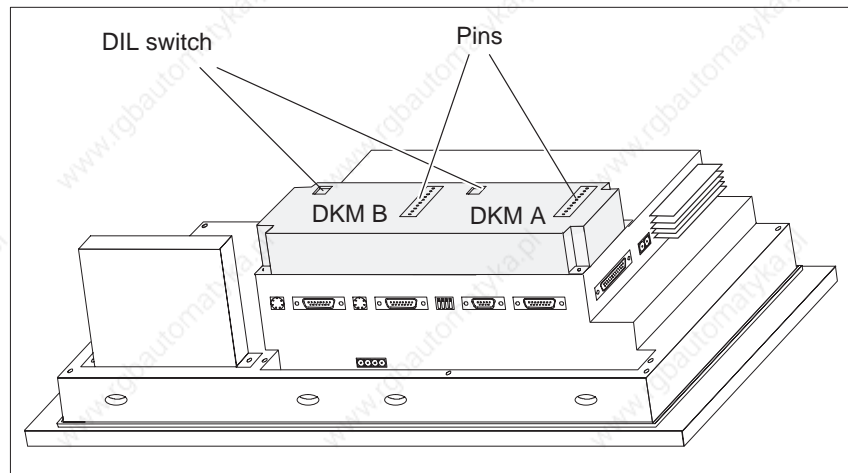
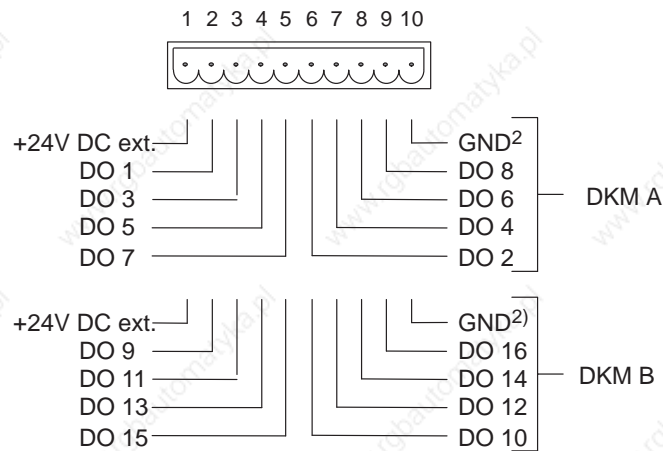

Figure 18-7 Location of connection and adjustment elements on large module housing (example OP37)

Pin array

The pin arrays of the module boards DKM A and DKM B have the following pin assignment:



- 2) Optocouplers electrically isolate the digital outputs from the OP.

The components to be driven (e.g. relays, signaling indicators, etc.) are connected by means of the five-pin connectors supplied:

- Connect the wires (conductor cross-sections 0.5 to 2.5 mm²)
- Seat the terminal blocks on the pins of the DKM

DIL switch

The DIL switch setting determines how the digital outputs of the DKM are controlled:

- in the OFF position, by pressing function keys
- in the ON position, by software

Software can control up to 16 DKM outputs, whereas only twelve can be controlled by function keys.

Setting the DIL switch:

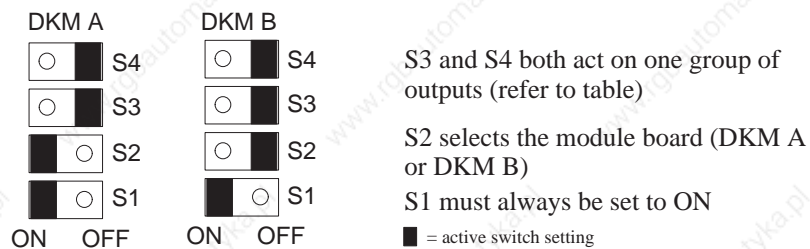

		OFF	ON	On
DKM A	S3	F1/F3/F5/F7 act as direct keys	DO 1/DO 3/DO 5/DO 7 controlled via software	OP27, OP37
	S4	F2/F4/F6/F8 act as direct keys	DO 2/DO 4/DO 6/DO 8 controlled via software	OP27, OP37
DKM B	S3	F9/F11 act as direct keys	DO 9/DO 11/DO 13/DO 15 controlled via software	OP37
	S4	F10/F12 act as direct keys	DO 10/DO 12/DO 14/DO 16 controlled via software	OP37
The function key assignment in this table refers to the default key assignment without insertion strips.				

When switches S3 and S4 are set in the OFF position, the digital outputs are permanently assigned to keys F1 to F12:

Key F1 sets output DO 1





Key F2 sets output DO 2

•
•

Key F12 sets output DO 12.

18.3 Control Panel Interface

A Control Panel Interface (CPI) is available as an option for operator panels OP27 and OP37 connected to SIMATIC S7 PLCs. The following versions are possible:

Operating unit	Control Panel Interface with		
	16 inputs/outputs	16 inputs/outputs	32 inputs/outputs
OP27			
OP37	—		

The control panel interface extends the 24 DP direct keys on the OP27 and the 36 DP direct keys on the OP37 by 16 and 32 digital inputs/outputs, respectively.

Function of the control panel interface

The Control Panel Interface must be implemented where fast key operation is required without any communication-related delays (jog operation < 100 ms). It communicates via the PROFIBUS-DP bus and can only be used in conjunction with the SIMATIC S7 PLC.

Each module provides 16 digital inputs/outputs. An external keypad with controls and light indicators can be connected for each module board. The assignment of the digital inputs/outputs to the control and light indicators of the external keypads is configured in the PLC (also refer to *User's Manual Communication*).

Cable lengths

The cable between the OP and the external keypad with control and light indicators must not be more than 1 m long.

External power supply

The Control Panel Interface requires its own power supply. Note, however, that the digital inputs/outputs are not isolated from the OP.

18.3.1 Installing the Control Panel Interface

An OP27 or an OP37 can accommodate either a control panel interface or a direct key module (Section 18.2). The procedure for installing a control panel interface is as follows:

1. Set the OP down with its front plate facing downwards.



Caution

- Make sure that the OP is disconnected from the power supply.
 - Always follow the ESD guidelines in the Appendix when working on open devices.
-

2. Release the two pop rivets ❶ and then remove the cover ❷ indicated in Figure 18-8 from the rear panel of the OP.

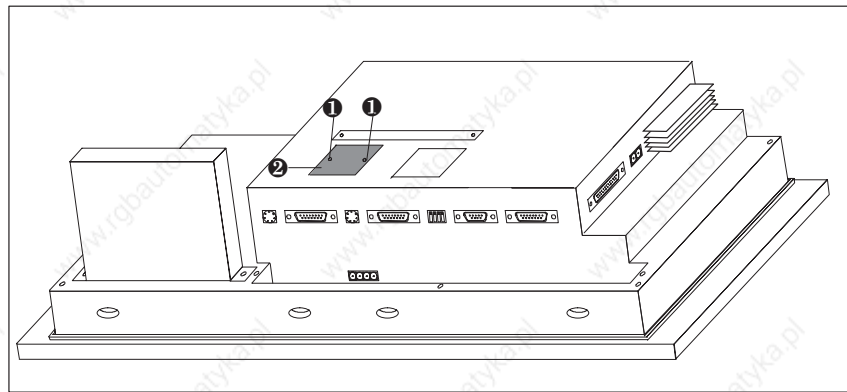

Figure 18-8 Removing the cover (example OP37)

3. Connect the connector of the DKM ribbon cable to the plug connector of the OP in such a way that the color-coded side of the ribbon cable is facing toward the center of the unit (see Figure 18-9).

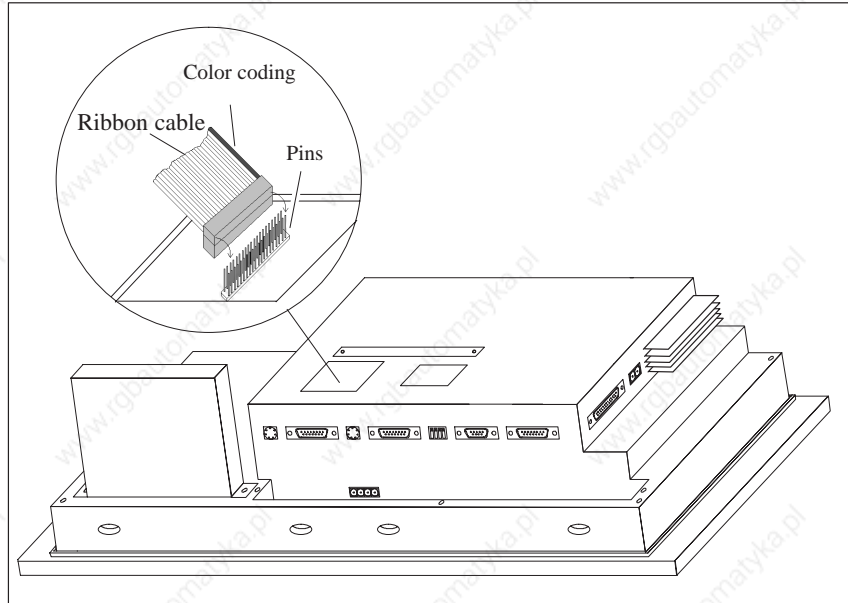

Figure 18-9 Connect the control panel interface plug (example OP37)

- Use the four screws supplied **3** to secure the control panel interface to the OP (see Figure 18-10).

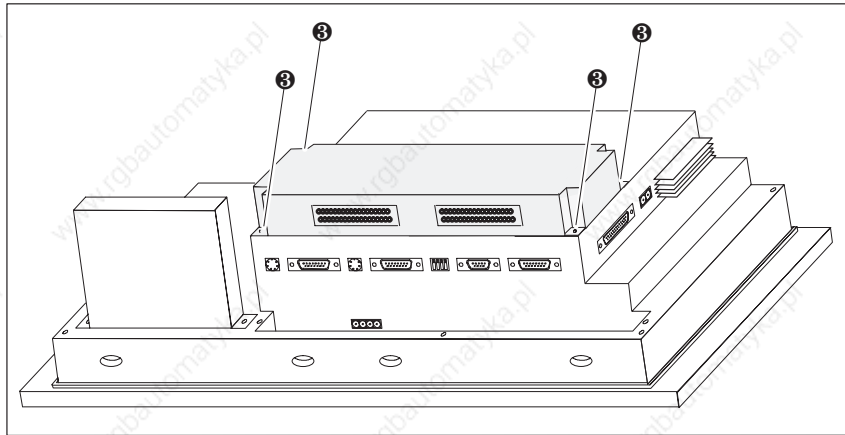

Figure 18-10 Securing the control panel interface to the OP (example OP37)

Remove in the reverse sequence of the installation procedure.

18.3.2 Connection and Adjusting Elements

Each of the two module boards has a 36-pin adapter for connecting the inputs/ outputs and the external voltage supply.

When installed, the connectors are at the rear of the OP.

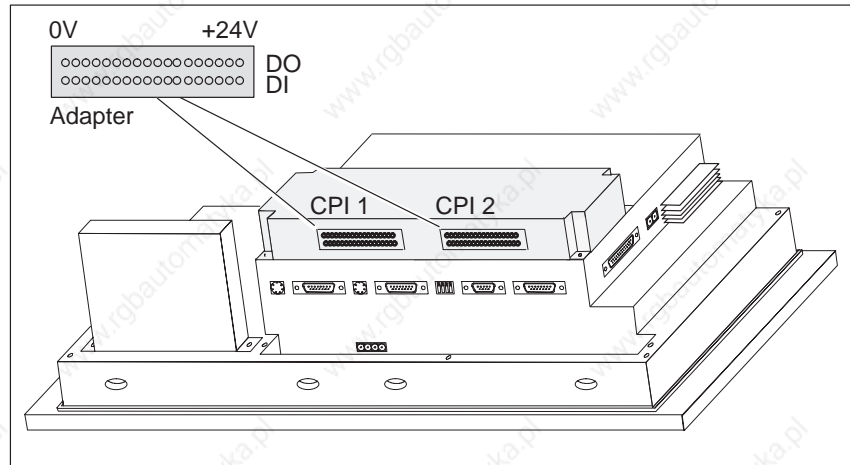
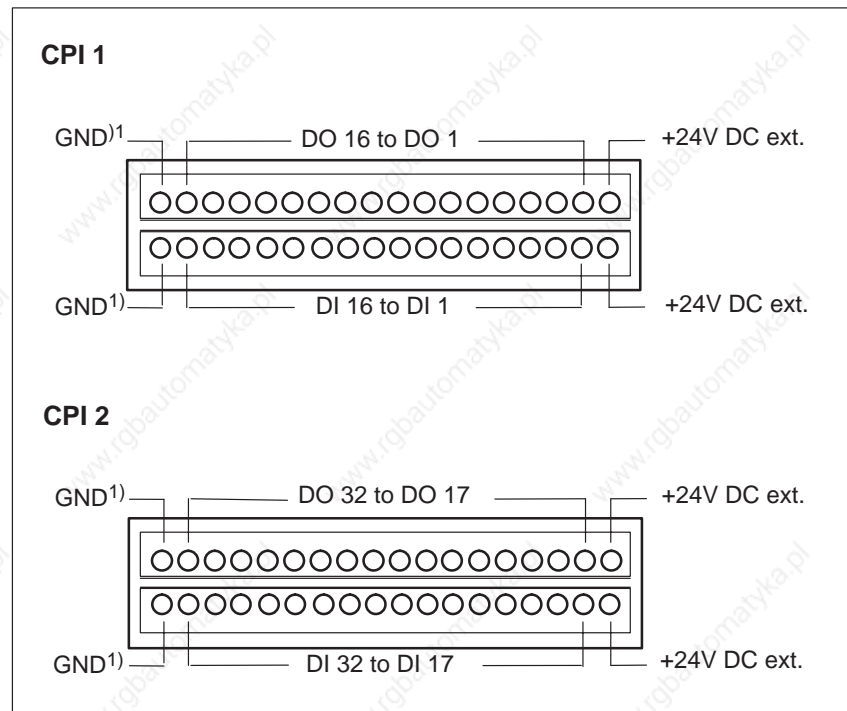

Figure 18-11 Location of connection elements on large module housing (example: OP37)

Connector

The connectors of modules CPI 1 and CPI 2 have the following pin assignments:



1) Non-floating

The controls and light indicators to be driven are connected by means of the 9-pin connectors supplied.

- Make the cable terminal connections (conductor cross-sections 0.5 to 2.5 mm²)
- Seat the terminal blocks on the adapters of the CPI module boards.

Maintenance/Upkeep

Scope Operator Panels OP27 ad OP37 are designed for low-maintenance operation. Maintenance of the OP is limited to

- regular cleaning of the keyboard overlay and screen
- changing the backup battery and
- replacing the display back-lighting.

The table below lists units which users can install or replace themselves.

Parts	OP27	OP37
Direct key module (DKM)	✓	✓
Control Panel Interface	✓	✓
AT expansion slot and AT cards	–	✓
Hard disk	–	✓
Floppy disk drive	–	✓

A description of fitting the direct key module, the control panel interface, the AT expansion slot and the AT cards is provided in Chapter 18.

19.1 Cleaning the Screen and Keyboard Overlay

Preparation Clean the OP screen and keyboard foil overlay at regular intervals with a damp cloth. Do not clean the device while it is turned on. This ensures that functions are not triggered inadvertently by coming into contact with the keyboard overlay.

Cleaning agents Use only water and washing-up liquid to dampen the cloth. Never use aggressive solvents or abrasive cleaning agents.

19.2 Replacing the Backup Battery

Function

The backup battery ensures that, in the event of a power failure

- the operating data in the SRAM of the OP are retained and
- the hardware clock does not stop.

Service life

A lithium battery is used in the OP. It is already fitted when the device is supplied. It has a typical service life under normal operating conditions of approximately four years. An exhausted battery is indicated in routine operation by a system message on the OP. Replace the backup battery as quickly as possible after the message is issued.

Source of supply

The battery can be ordered via the Siemens spare parts service. It is shipped ready for installation with a lead and connector. Refer to our catalog ST80.1 for the order number.

Before changing the battery



Observe the following before changing the battery:

Caution

- Change the battery with the power supply switched on, in order to prevent losses of data – for example, passwords.
 - The battery must be changed by a suitably qualified person.
 - Before replacing the battery, note the ESD guidelines in Appendix F of this manual.
-

Action

Step	Action
1	If a direct key module or control panel interface is connected to the OP37, remove it (refer to Section 18.2 or 18.3) in order to gain access to the cover of the battery compartment. Switch off the voltage supply before removing the DKM or CPI. After removing the direct key module or the control panel interface, switch on the voltage supply before removing the battery.
2	Remove the gray, plastic cover of the battery compartment at the rear of the OP.
3	Remove the battery lead connector from the two-pin plug connector on the OP.
4	Remove the dead battery from the holder and insert the new battery. The snap-in plastic holder secures the battery in the battery compartment.
5	Insert the battery lead connector back into the plug connector. The connector is coded and thus protected against polarity reversal.
6	Stow the lead in the battery compartment and close the battery compartment.

General notes

Please observe the following safety notes to ensure correct handling and disposal of lithium batteries:

**Warning**

- If the lithium battery is not handled properly, there is risk of explosion.
- Batteries
 - should never be charged
 - should not be opened
 - should not be short-circuited
 - should be safeguarded against polarity reversal
 - should not be exposed to temperatures in excess of 100 °C
 - should be protected against direct sunlight.
- Do not allow condensation to form on batteries.
- Should shipping become necessary, packing must comply with the Dangerous Chemicals Ordinance for the carrier concerned (coding obligation).
- Treat used lithium batteries as special waste. Pack them in separate leak-proof plastic bags to dispose of them.

19.3 Other Maintenance Work on OP27

Other maintenance work is necessary only if the back-lighting fails:

- In the case of the OP27M, the monochrome display needs to be replaced.
- In the case of the OP27C, only a CCFL tube has to be replaced.

Service life

The service life of the fluorescent tubes can be increased by blanking the screen (refer to Section 11.2).

Before replacing

The unit must be opened up in order to replace the display and back-lighting. Observe the following notes on safety for opening the OP:



Warning

- Repairs to the OP must be performed by suitably qualified and authorized technical personnel.
 - The user may be exposed to considerable risk as a result of unauthorized opening of the OP and unqualified repairs.
 - The display back-lighting operates at voltages > 1000 V. Make sure that the OP27 is disconnected from the power supply before the unit is opened.
 - Crystal liquid may leak from a damaged display.
Do not allow liquid to touch your skin; do not inhale vapors. If you come into contact with crystal liquid, wash your skin immediately with alcohol. Consult a doctor without delay.
 - Before working on an open unit, observe the ESD guidelines in the Appendix F of this manual.
-



Caution

One of the screws in the back panel of the device is sealed. The warranty for your device ceases if the seal is broken. If the manufacturer's warranty for your device has not expired, you should have the back-lighting or display replaced by your local Siemens branch office.

19.3.1 Replacing the display on the OP27M

Procedure

Carry out the following steps in order to replace the monochrome display of the OP27M:

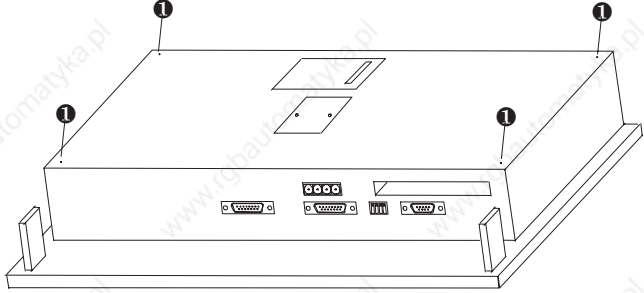
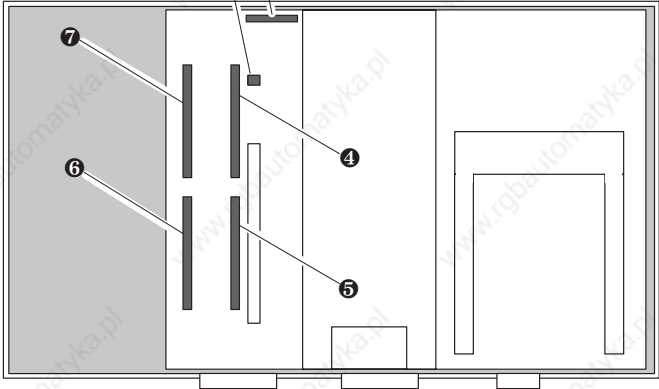
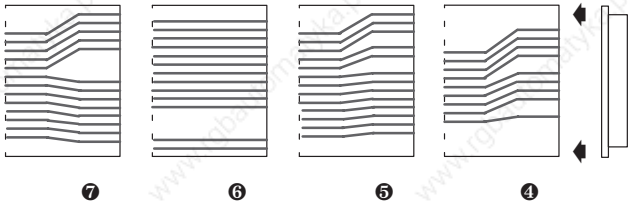
Step	Action
1	Lay down the device with its front plate facing downwards.
2	Remove the four screws ❶ from the housing.
	
3	Carefully remove the housing rear panel and lay it down with its inside facing upwards.
4	Remove the battery connector ❷ from the electronic assembly.
	
5	Remove the connector ❸ from the display socket on the electronic assembly (see figure in Step 4).
6	Open the connectors belonging to the ribbon cables ❹, ❺, ❻ and ❼ by gently lifting the at both sides of the front side (see figure in Step 4). Pull out the ribbon cables.
	

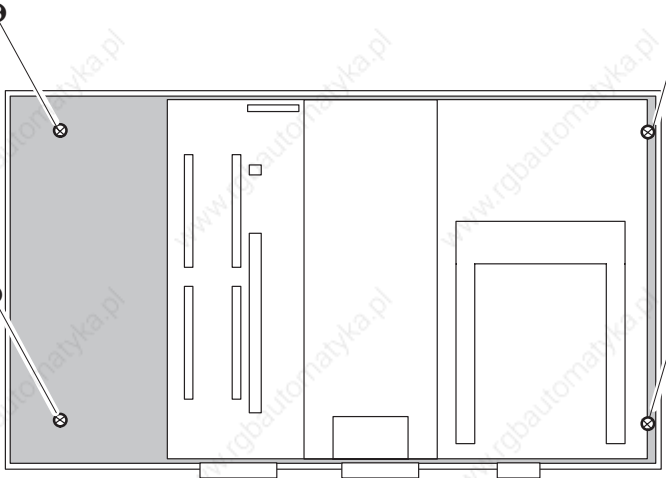
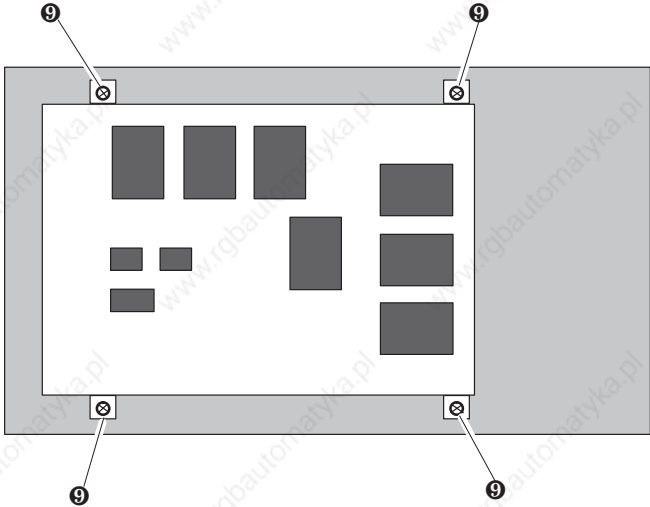
Step	Action
7	<p>Remove the four screws ⑧</p> 
8	<p>Carefully remove the angle bracket with the electronic assembly and lay it down next to the OP with its underside facing upwards.</p>
9	<p>The electronics module is still connected to the display assembly by means of two cables. Remove the connector on the bottom side of the angle bracket.</p>
10	<p>Remove the four screws ⑨</p> 
11	<p>Remove the display with the defective back-lighting, install the new display and reassemble in reverse order.</p>

19.3.2 Replacing the Back-Lighting of the OP27C

Procedure

Carry out the following steps to replace the back-lighting on the OP27C with a color display:

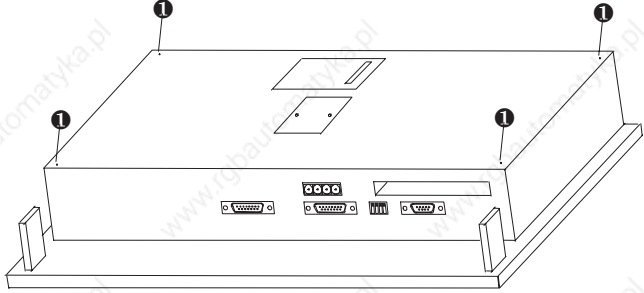
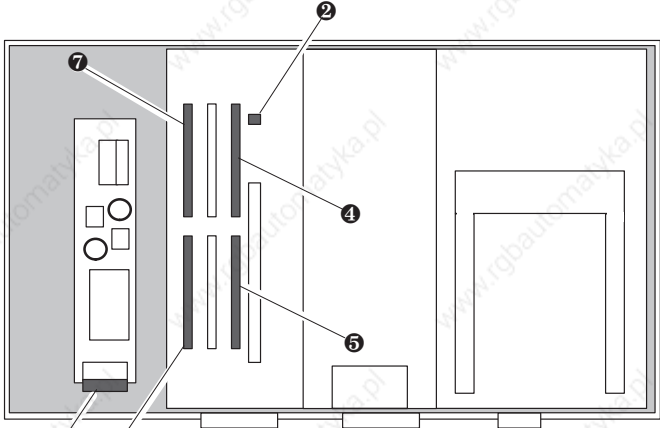
Step	Action
1	Lay down the device with its front plate facing downwards.
2	Remove the four housing screws 1 .
	
3	Carefully remove the housing rear panel and lay it down with its inside facing upwards.
4	Remove the battery connector 2 from the electronic assembly.
	
5	Remove the connector 3 from the back-lighting socket on the electronic assembly (see figure in Step 4).
6	Open the labeled connectors 4 , 5 , 6 and 7 by gently lifting the at both sides of the front side (see figure in Step 4). Pull out the ribbon cables.

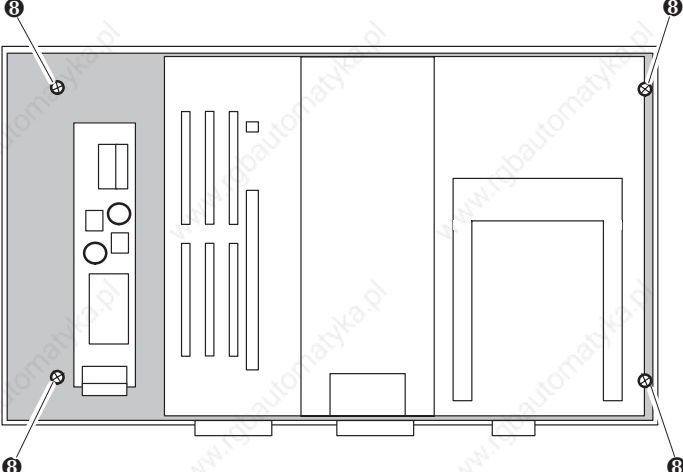
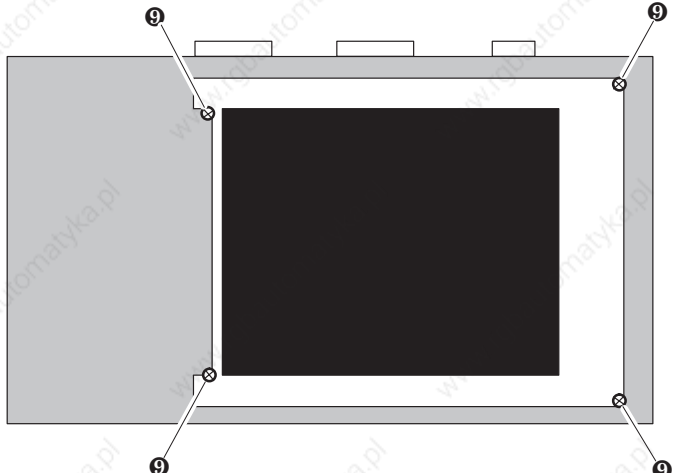
Step	Action
7	<p>Remove the four screws ⑧</p> 
8	<p>Carefully remove the angle bracket with the electronic assembly and lay it down next to the OP with its underside facing upwards.</p>
9	<p>Remove the four screws ⑨ connecting the display to the angle bracket.</p> 
10	<p>Carefully turn the display around. Make sure that the display is still connected to the electronic assembly by means of a cable.</p>

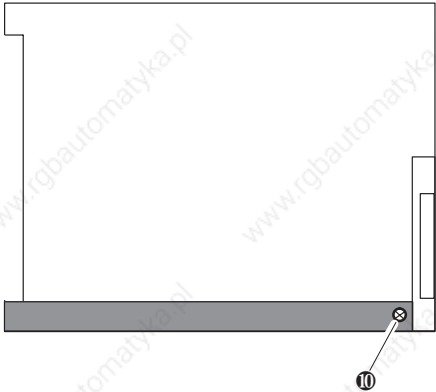
Step	Action
11	Remove the screw ⑩ at the rear of the display from the tube holder.  A technical drawing of a rectangular tube holder assembly. It consists of a main rectangular frame with a smaller vertical section on the right side. A horizontal bar is attached to the bottom of the main frame. A screw, labeled with a circled number 10, is shown passing through the horizontal bar and into the bottom of the main frame. A leader line points from the circled number 10 to the screw.
12	Remove the tube holder with the defective tube and fit the new tube holder and the new tube.
13	Reassemble in reverse order.

19.4 Other Maintenance Work on OP37

Other maintenance/service work on the OP37 involves replacing the back-lighting and floppy disk drive. To do this, however, the housing must be opened.

19.4.1 Opening the OP37 housing

Safety notes

Observe the following safety notes before starting to open the housing:



Warning

- Repairs to the OP must be performed by suitably qualified and authorized technical personnel.
 - The user may be exposed to considerable risk as a result of unauthorized opening and unqualified repairs.
-



Caution

- The back-lighting operates at voltages > 1000 V. Make sure that the OP is disconnected from the power supply.
 - Always follow the ESD guidelines in the Appendix when working on open devices.
 - Do not undo any sealed screws. The manufacturer's warranty for your device ceases if the seal is broken.
-

Opening the OP37 housing

Carry out the following steps to open the housing of the OP37:

Step	Action
1	Lay down the device with its front plate facing downwards.
2	Remove the eight housing screws ① .
3	Remove the rear panel. → Refer to Section 19.4.3, Page 19-14 to replace the floppy disk drive.
4	Remove two screws ② which hold a hinged plate.
5	Gently lift the hinged plate and remove the ribbon cable from the connector secured beneath the plate cutout ③ (see figure in Step 4).
6	Turn the plate to its final position (90 degrees). → To remove the back-lighting – Refer to Chapter 19.4.2, Page 19-12.

19.4.2 Replacing the Back-Lighting of the OP37

Service life

The brightness of the LCD back-lighting decreases during the course of time for technological reasons.

Increase the service life of the two fluorescent tubes by blanking the screen (refer to Section 11.2).

The difference in brightness between a new fluorescent tube and an old one is clearly obvious on the screen. Replace both tubes simultaneously when one fails. This will save having to open up the OP a second time when the second tube fails.

The back-lighting can only be replaced for an OP37 with TFT display. In the case of an OP37 with STN display, the complete display must be replaced.

Before replacing

Observe the following safety notes when replacing the back-lighting:



Warning



Crystal liquid may leak from a damaged display.

Do not allow liquid to touch your skin; do not inhale vapors. If you come into contact with crystal liquid, wash your skin immediately with alcohol.

Consult a doctor without delay.

Procedure

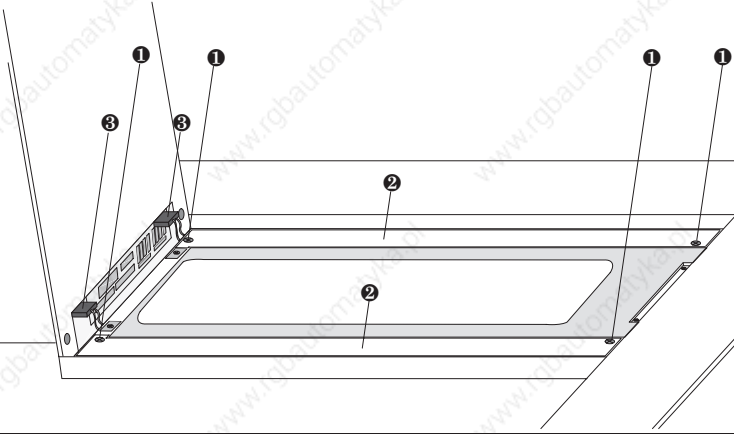
Carry out the following steps to replace the back-lighting tubes:

Step	Action
1	Open the OP37, as described in Section 19.4.1, and study the safety notes contained in that section.
2	Undo the four screws 1 . 
3	Remove the covers 2 (see figure in Step 2).
4	Remove the two connectors 3 (see figure in Step 2).
5	Carefully remove the tubes at the two rubber-buffered ends from the holders. <hr/> <p style="text-align: center;">Caution</p>  <p>If you hold the glass to remove a tube, the tube may burst with a corresponding a risk of injury.</p> <hr/>
6	Insert the new tubes, as described, in the holders and reassemble the device.

19.4.3 Replacing the Floppy Disk Drive

To replace the floppy disk drive, perform the following steps:

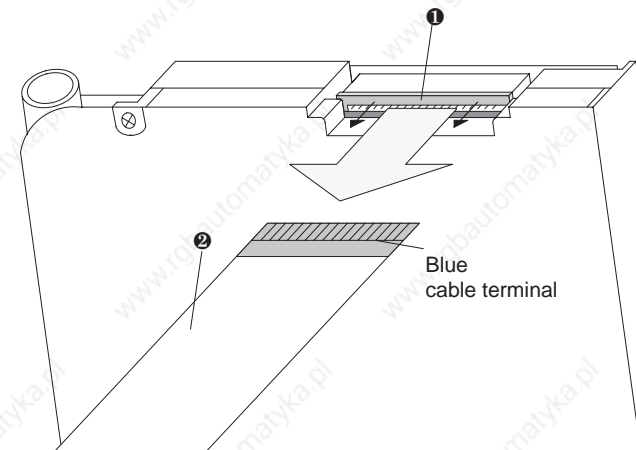
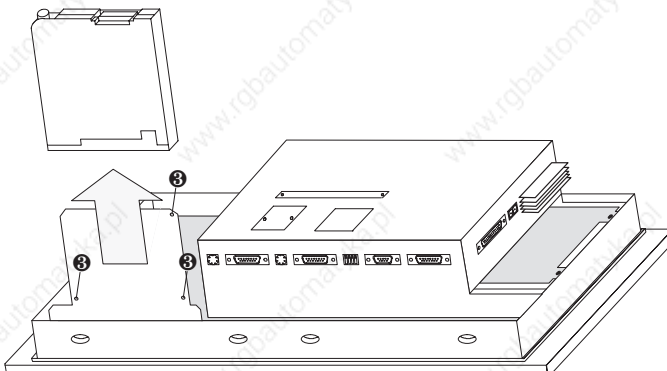
Step	Action
1	Open the OP37, as described up to and including Step 3 in Section 19.4.1. Study the safety notes contained in that section.
2	<p>Open the clamp lock ❶ by drawing it carefully with your fingertips on both sides (see black arrows) in the direction of the arrow until it reaches its end position.</p> <p>Caution</p> <p> Do not tilt the clamp lock or pull it too sharply, because it may break.</p> 
3	Remove the ribbon cable ❷ (see figure in Step 2). When the cable is inserted in the in the terminal piece of the replacement floppy disk drive, ensure the cable side with the blue terminal is facing upwards and the cable contacts are facing downwards.
4	<p>Remove the three screws ❸ at the rear of the floppy disk drive holder and remove the floppy disk drive.</p> 
5	Fit the new floppy disk drive and reassemble the unit in the reverse sequence.

APPENDICES

Part V

- A Technical Data**
- B Interface Assignment**
- C Test Functions**
- D System Messages**
- E SIMATIC HMI Documentation**
- F ESD Guidelines**

A

Technical Data

Housing	OP27	OP37
External dimensions W x H	296 mm x 192 mm	482.6 mm x 310.3 mm
Mounting cutout W x H	282 ⁺¹ mm x 178 ⁺¹ mm	436 ⁺¹ mm x 295 ⁺¹ mm
Mounting depth without option	59 mm	85 mm
• with direct key module and cable	92 mm	118 mm
• with floppy disk drive	–	118 mm
• with AT expansion slot	–	138 mm
Degree of protection	IP65	
• Front panel	IP20	
• Rear panel		
Weight without option approx.	1.85 kg	8 kg

Processor	OP27	OP37
Type	80486	Pentium
Clock frequency	33 MHz	100 MHz

Memory	OP27M	OP27C	OP37
Flash	1 MB	2 MB	
DRAM	2 MB	4 MB	8 MB
SRAM, battery-backed	128 kB		
Floppy disk drive	–		1.44 MB (optional)
Hard disk	–		≥ 1.6 GB (optional)
Memory card	For flash/SRAM ≥ 1 MB		For hard disk ≥ 170 MB
• Slot A	–		For flash/SRAM ≥ 1 MB
• Slot B	–		For flash/SRAM ≥ 1 MB

Technical Data

Display	OP27M	OP27C	OP37	
LCD type	Monochrome STN	Color STN	Color STN	TFT
Resolution (horizontal x vertical)	320 x 240		640 x 480	
Active screen area (mm x mm)	115 mm x 86 mm		211 mm x 158 mm	
Back-lighting Service life ¹⁾ approx.	1 CCFL tube 22,000 h	1 CCFL tube 25,000 h	2 CCFL tubes 25,000- 50,000 h	2 CCFL tubes 25,000 h

1) The back-lighting tube for the display is subject to wear and is therefore not covered by the warranty. Its service life is approximately 10,000 to 25,000 hours, depending on operating temperature and type. In unfavorable operating conditions we recommend replacing the tube after the period has elapsed. The tube is available as a spare part.

Keyboard	OP27	OP37
Type	Membrane keyboard	
System keys with permanent functions	24 (4 having an LED)	32 (4 having an LED)
Function keys having configurable functions those included as soft keys	24 (18 having an LED) 14	36 (28 having an LED) 20

Power supply	OP27	OP37
Rated voltage (VDC)	+ 24 V DC	
Permissible range (VDC)	+18.0 to +30.0 V DC	
Max. permissible transients	35 V (500 msec)	
Time between two transients	50 sec minimum	
Typical power consumption at 24 V	Approx. 0.3 A	Approx. 1.6 A (without AT cards)
Switch-on current I ² t	0.45 A ² s	0.55 A ² s
Fuse, internal	Miniature fuse	

Backup battery	OP27	OP37
Type	Lithium battery	
Voltage/capacity ¹⁾	3.6 V/approx. 1.5 Ah	
Service life	> 4 years	

1) Subject to modification.

Contact assembly for power supply connection	OP27	OP37
Switching power	24 V DC, 0.3 A (no inductive load)	

Contact assembly for temperature monitoring	OP27	OP37
Switching power	–	24 V DC, 0.3 A (no inductive load)

Direct key module (DKM)	OP27	OP37
Voltage supply for outputs, load voltage supply and internal logic circuitry		
Voltage supply <ul style="list-style-type: none"> rated value permissible range value at $t < 0.5$ sec 	+ 24 V DC +18.0 to +30.0 V 35 V	
Power consumption of logic circuitry	50 mA	
Short-circuit protection upon polarity reversal of load voltage	✓	
Outputs¹⁾		
No. of outputs	8 per module	
Output voltage <ul style="list-style-type: none"> with signal “0” with signal “1” 	Max. 2 V (idling) Min. (voltage supply –3 V)	
Output current <ul style="list-style-type: none"> with signal “0” with signal “1” 	Max. 1 mA Max. 300 mA per output	
Switch rate at <ul style="list-style-type: none"> resistive load inductive load lamp load 	Max. 100 Hz Max. 0.5 Hz Max. 8 Hz	
Short-circuit current	Max. 500 mA per output	
Note: With inductive loads, an external free-wheeling diode must be used directly on the load.		

1) Outputs are isolated by means of optocouplers.

Control Panel Interface	OP27	OP37
Voltage supply for outputs, load voltage supply and internal logic circuitry		
Voltage supply <ul style="list-style-type: none"> rated value permissible range value at $t < 0.5$ sec 	+ 24 V DC +18.0 to +30.0 V 35 V	
Power consumption of logic circuitry	40 mA	
Short-circuit protection upon polarity reversal of load voltage	✓	
Connection of	Lamps (inductive load not permitted)	
Outputs		
No. of outputs <ul style="list-style-type: none"> in groups of output DO1 to DO4 output DO5 to DO8 output DO9 to DO12 output DO13 to DO16 	16 4 Group 1 Group 2 Group 3 Group 4	
Optical isolation	-	
Output voltage <ul style="list-style-type: none"> with signal "0" with signal "1" 	Max. 2 V (idling) Min. (voltage supply -3 V)	
Output current <ul style="list-style-type: none"> with signal "0" with signal "1" 	Max. 1 mA Max. 500 mA per group 1 output of 200 mA, the remainder 100 mA	
Switch rate at <ul style="list-style-type: none"> resistive load lamp load 	Max. 100 Hz Max. 8 Hz	
Load current per group <ul style="list-style-type: none"> aggregate current on short-circuit 	500 mA Complete group deenergized	
Cable length	Max. 1 m	
Voltage supply for inputs		
Voltage supply <ul style="list-style-type: none"> rated value permissible range value at $t < 0.5$ sec 	+ 24 V DC +18.0 to +30.0 V 35 V	
Connection of	Pushbuttons, switches (inductive load not permitted)	



Control Panel Interface	OP27	OP37
Inputs		
No. of inputs	16	
Optical isolation from intern. logic circuitry	-	
Input voltage <ul style="list-style-type: none"> rated value with signal "0" with signal "1" 	24 V DC 0 to 5 V 15 to 30 V	
Input current with signal "1"	Typic. 5 mA at 24 V	
Input delay	0.3 msec	
Connection of mechanical switches	Possible	
Bounce time	≤ × 10 msec	
Cable length of sensors, unshielded	1 m	

Ambient conditions	OP27	OP37
Location <ul style="list-style-type: none"> Max. permissible angle of inclination without forced ventilation 	Vertical ± 35°	(FDD = floppy disk drive) without FDD: ± 35° with FDD: ± 25°
max. permissible ambient temperature at <ul style="list-style-type: none"> operation up to 10° angle of inclination operation up to 35° angle of inclination shipping, storage 	0 ... 50° C 0 to 40° C -20 to 60° C	4 to 45° C 4 to 40° C -20 to 60° C
Relative humidity <ul style="list-style-type: none"> operation shipping, storage 	≤ 95%, no condensation ≤ 95%	
Shock loading <ul style="list-style-type: none"> operation shipping, storage 	15 g/11 msec 25 g/6 msec	5 g/11 msec for floppy disk or hard disk access, otherwise 15 g/11 msec 25 g/6 msec
Vibration <ul style="list-style-type: none"> operation shipping, storage 	0.075 mm (10 Hz to 58 Hz) 1 g (58 Hz to 500 Hz) 3.5 mm (5 Hz to 9 Hz) 1 g (9 Hz to 500 Hz)	0.035 mm (10 Hz to 58 Hz) 1 g (58 Hz to 500 Hz) 0.5 g with floppy disk drive/hard disk 3.5 mm (5 Hz to 9 Hz) 1 g (9 Hz to 500 Hz)
Max. pressure difference (front/rear)	2 hPa	
Barometric pressure <ul style="list-style-type: none"> operation shipping, storage 	706 to 1030 hPa 581 to 1030 hPa	

The conformity of the product described with the regulations of Directive 89/336 EEC is proved by compliance with the following standards:

Noise immunity EN 50082-1	OP27	OP37
Static discharge (contact/atmospheric discharge)	EN 61000-4-2 Class 3	
RF irradiation	ENV 50140 Class 3	
Pulse modulation	ENV 50204 (900 MHz ± 5 MHz)	
RF conduction	ENV 50141 Class 3	
Burst interference	ENV 61000-4-4 Class 3	

Radio interference	OP27	OP37
RFI suppression level in accordance with EN 55011	Class A	

Certifications	OP27	OP37
UL certification	UL Recognition Mark Underwriters Laboratories (UL) complying to Standard UL 508, File E 120869	
CSA certification	CSA Certification Mark Canadian Standard Association (CSA) in compliance with Standard C 22.2 No. 142, File LR 89077-19	
FM certification	<p>FM Certification Complying with Factory Mutual Approval Standard Class Number 3611 Hazardous (classified) Locations Class I, Division 2, Group A, B, C, D</p> <hr/> <p> Warning Personal injury and material damage may occur. Personal injury and material damage may occur in hazardous areas if plug connections are disconnected during the routine operation of a OP. In hazardous areas, always de-energize the OP before unplugging connectors.</p> <hr/> <p> Warning WARNING – DO NOT DISCONNECT WHILE CIRCUIT IS LIVE UNLESS LOCATION IS KNOWN TO BE NONHAZARDOUS.</p>	

B

Interface Assignments

IF1A and IF2

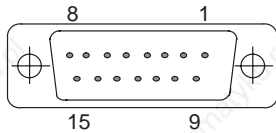

Pin assignment of the 15-pin Sub-D socket:

Pin	General	RS232	TTY
1	Housing		
2			RxD-
3		RxD	
4		TxD	
5		CTS	
6			TxD+
7			TxD-
8	Housing		
9			RxD+
10		RTS	
11			+20 mA ¹⁾
12	GND		
13			+20 mA ¹⁾
14	+5 V		
15	GND		

¹⁾ Not IF2

IF1B

Pin assignment of the 9-pin Sub-D socket
(Configuration via DIL switch, see Chapter 13.1.2):

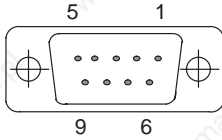

Pin	General	PROFIBUS-DP MPI	RS422	RS485
1				
2				
3		Data B	TxD (B)	Data B
4			RxD (B)	
5	GND (floating)			
6	+5 V (floating)			
7				
8	Housing	Data A	TxD (A)	Data A
9			RxD (A)	

**IF3 (TP37)
only**

Pin assignment of the 15-pin Sub-D socket:

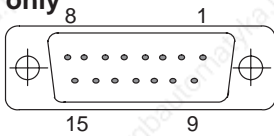

Pin	General	TTY	RS42	RS485
1	Housing			
2		RxD-		
3			RxD (B)	
4			TxD (B)	Data B
5			RxD (A)	
6		TxD+		
7		TxD-		
8	Housing			
9		RxD+		
10			TxD (A)	Data A
11	+24 V			
12	GND (5 V)			
13				
14	+5 V			
15	GND (24 V)			

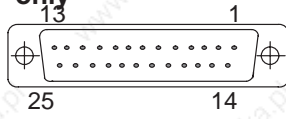
LPT (TP37)**only**

Pin assignment of the 25-pin Sub-D socket:

Pin	TTL (Centronics)
1	- Strobe
2	+ Data Bit 0
3	+ Data Bit 1
4	+ Data Bit 2
5	+ Data Bit 3
6	+ Data Bit 4
7	+ Data Bit 5
8	+ Data Bit 6
9	+ Data Bit 7
10	- Acknowledge
11	+ Busy
12	+ Paper End
13	+ Select
14	- Auto Feed
15	- Error
16	- Init Printer
17	- Select Input
18...25	Ground (0 V)

C

Test Functions





Overview

The OP27 and OP37 automatically test the most important hardware components when power is switched on or voltage applied.

In addition, the OP27 has a test program for testing hardware components as and when necessary.

C.1 Hardware Test

Start hardware test Carry out the following steps to start the hardware test:

Step	Action
1	Press the following key combination while the unit is starting up: Keep the keys pressed until a system request appears on the screen asking whether the hardware test should be started.  +  + 
2	If the test should be started, press the system key depicted on the right. The selection screen is opened.  If the system test should be canceled, press the following system key: 

Test procedure

Settings can be defined in the selection screen which affect the user interface and relay output. The following hardware tests can be performed:

- test the internal memory,
- test the serial interfaces,
- test the keyboard and display and
- test internal functional units – for example, watchdogs or real-time clock

The tests can also be started by pressing one of the function keys depicted on the right.

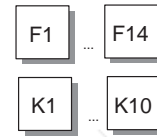

The result of the test appears in the display as each test is completed:

OK: Test completed without error.

DEF : The functional unit tested is defective.

Return to the selection screen by pressing one of the following system keys:







Terminate test program

The test program can only be terminated by switching off the power supply to the OP27.

C.1.1 Individual Tests

Performing settings on the selection screen

Contrast	Increase or decrease the contrast of the selected screen using the arrow keys depicted on the right.	 
Brightness	Blank or brighten the screen by pressing the arrow keys depicted on the right. This function corresponds to the <i>Blank Screen</i> function on the <i>System Settings</i> standard screen.	 
Relay on/off	Press this button to activate and deactivate the contact assembly integrated in the power supply connector:	

Internal/External memory





The OP memory modules are checked by means of read/write tests. Should an error occur, the faulty memory address is displayed on the screen.

Note

With SRAM, EEPROM and flash memory, the memory contents are saved to DRAM prior to testing. Consequently, you should begin by testing the DRAM for errors.

If the test reveals an error, the data copied prior to the test is not re-imported. This means that the content of the memory which failed the test is corrupted. The same applies if the power supply fails.

The individual RAM tests:

RAM Test	Initiated by Key	Result
DRAM		Test each bit in the memory area.
EPROM		A checksum test is performed to validate the integrity of the data stored in memory.
SRAM		Test each bit in the memory area.
EEPROM		

RAM Test	Initiated by Key	Result
FLASH	F12	<p>The contents of the flash memory are erased during flash memory testing. When you press the function key, you are asked whether you really wish to erase the flash memory.</p> <p>If you do not want to erase the flash memory, press: ESC</p> <p>The selection screen is displayed again.</p> <p>If you do want to erase the flash memory, press: ACK</p> <p>The flash memory is erased and the memory area tested bit by bit.</p>
CARD	F13	<p>The interface to the memory module is tested. This is possible only if an SRAM module ≥ 512 Kb has been inserted.</p>





Serial interfaces

These tests are only possible when self-made adapters have been connected to the respective connectors. The adapter pinout is explained in Section C.1.2 on Page C-6.

Interface Test	Initiated by Key	Requirements
IF1	F14	<p>An adapter has to be inserted on both IF1A and IF1B for the IF1 test.</p> <p>V.24 signals: Adapter 1 on IF1A and adapter 3 on IF1B</p> <p>TTY signals: Adapter 2 on IF1A and adapter 3 on IF1B</p>
IF2	K2	<p>V.24 signals: Adapter 1</p> <p>TTY signals: Adapter 2</p>

Keyboard and display

Keyboard Test	Initiated by Key	Result
KEYB/LED	K5	<p>The keys required to be tested are displayed one after the other – for example, "F3".</p> <p>Press the key displayed within 10 seconds.</p> <p>If an LED has been assigned to a key, it will now be on, and the next key is displayed.</p>

Display Test	Initiated by Key	Result
DISPLAY	K7	<p>The display test consists of the following four individual tests, each of which can be performed on its own:</p> <p>White </p> <p>Pixel test of the screen surface, the entire display goes white.</p> <p>Black </p> <p>Pixel test of the screen surface, the entire display is blanked.</p> <p>Grid </p> <p>The grid lines are displayed.</p> <p>Characters </p> <p>The character set is displayed.</p>

Internal functional units

Functional Unit Test	Initiated by Key	Result
WATCH-DOG	K8	This test verifies whether the watchdog, once triggered, initiates a restart when the trigger stops.
RTC/BATTERY	K9	The battery connection and hardware clock are tested (floating bit test).
TEST ENTRIES	K10	This function is reserved and must not be selected.

C.1.2 Test adapters

Make up the test adapters in such a way that the pins listed below are connected or jumpered, as described:

Adapter 1

15-pin Sub-D connector

3 — 4
5 — 10

Adapter 2

15-pin Sub-D connector

2 — 12
6 — 13
7 — 9

Adapter 3

9-pin Sub-D connector

3 — 4
8 — 9

D

System Messages

Message number

OP system messages can be subdivided into various categories.

The information as to which category a system message belongs to is contained in the message number as indicated below.

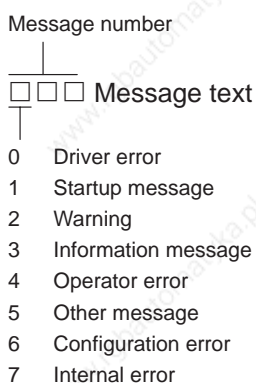

The message category enables you to identify the general area in which the cause of the fault is to be found.

Below you will find a selection of system messages listed together with details of under what circumstances they occur and, where applicable, how the cause of the fault can be eliminated.

Self-explanatory system messages are not included.

Note

System messages are displayed in the language selected in the configuration. If the OP does not have access to any configuration data, the messages are displayed in English.

Procedure for "internal errors"

In the case of all system messages that relate to "internal errors", please follow the procedure outlined below.

- a) Switch off the OP, set the PLC to STOP mode and then restart both units.
- b) During startup, set the OP to download mode, download the configuration again and then restart the OP and PLC again.
- c) If the fault recurs, please contact your nearest Siemens representative. When doing so, please quote the number of the error that has occurred and any variables referred to in the message.

Message	Cause	Remedy
Please wait	Mode change in progress or recipe function started.	
Ready for transfer	Waiting for data from PU/PC	
Data transfer	Data transfer between PU/PC and OP in progress	
Firmware not compatible	The firmware can not be used for the current configuration	
EPROM memory failure	Memory module defective or internal hardware fault	Send unit for repair quoting details of error message
RAM memory failure		
Flash memory failure	Memory module defective or transmission error	Retransfer configuration or send OP for repair

Message	Cause	Remedy:
026...029	Storage medium not ready, contains errors or status undefinable.	Reset hardware, remove then refit Flash memory module or carry out hardware test.
030	Storage medium not initialized.	Switch to download mode.
032	Error accessing module, Flash may not be supported or initialized by incorrect OP.	Check whether module is properly inserted and compatible. If restoring: repeat backup with correct OP.
033	Internal Flash memory initialized; configuration data deleted, some recipe data preserved.	Retransfer configuration.
034	Inserted module initialized, all stored data deleted.	Retransfer configuration.
035	Size of selected recipe memory has been reduced.	The reduced-size recipe memory can not be used and all data records must be deleted. The recipe memory is only initialized when requested.
040	Driver error If FAP is set, the character delay time setting may be too short.	Check physical connection with PLC. Modify character delay time.
041	Fault in connection with PLC. Possible causes: – Fault on the transmission link, e.g. connecting cable defective – Incorrect interface parameters set on OP or on communication peer.	
043	Data transfer error. A variable indicating the cause of the fault is transferred with this message. Variable: 0 Timeout error 1 Framing error (receiving) 2 Overrun error 3 Parity error 4 No connection established 5 Checksum error (receiving) 6 Unexpected characters received 7...11 Internal error 12 Receive data block too large 13 Memory area not available on PLC	Repeat the data transfer. Before doing so, check the physical connection/configured interface parameters if necessary.
044	Fault in connection with PLC. Possible causes: – Fault on the transmission link, e.g. connecting cable defective – Incorrect interface parameters set on OP or on communication peer.	
114	PLC has been restarted.	
115	Establishment of logical link with PLC in progress.	
117	Connection with PLC is OK again following a fault.	
119	Automatic restart.	
136	PLC not responding.	Check program sequence on PLC. Check physical connection.
138	Data block not available on PLC	Set up relevant memory area.

System Messages

Message	Cause	Remedy:
200	Battery power no longer sufficient for internal data buffer on OP. Battery on memory is discharged, data may no longer be readable.	Replace battery. Note: Replace the battery while the unit is switched on in order to prevent loss of data.
210	<i>Internal error</i> OP co-ordination area not receivable during startup.	Press restart button.
212	<i>Internal error</i> Bit for changing operating mode has been inverted erroneously.	Restart OP.
213	Offline mode not possible at present.	Try change of operating mode again later.
214	The job number sent by the PLC or configured in a function field is too large.	Check PLC program and configured screen.
217, 218	Overlapping specified/actual values.	Check configuration of actual/specified values in the process link.
230	The minimum value is greater than the maximum value for variable limits.	Correct the limit settings.
231	The minimum value is equal to the maximum value for variable scales.	Correct the scale on the OP.
250	You can not switch to the desired operating mode.	Check parameters of PLC job.
251	Error transferring data record to PLC.	Check recipe configuration.
252	Function can not be executed as a function of the same group has not yet been completed (e.g.: setpoint entry is active, password list can not be opened).	Wait until preceding function has been completed (or terminate function) and then invoke desired function again.
253	Access to data medium is not possible.	<ol style="list-style-type: none"> 1. Floppy drive not present, 2. Floppy is read only, 3. Disk is not formatted.
254	The disk must be formatted before a data record can be saved for the first time.	First format the disk.
255	Not enough space on disk for this data record.	Delete data records that are no longer required.
256	Not enough system memory available to execute the desired function.	<p>Try activating function again. Check configuration.</p> <ol style="list-style-type: none"> 1. Move function to a different screen 2. Simplify screen structure 3. Do not use trends on screen in conjunction with this function
257	Data record has been stored with a different version stamp than defined in the current configuration.	<p>If the data records are to continue to be used, the old version number must be entered in the recipe configuration.</p> <p>Caution: The structure of the recipe determines the assignment of data to a data record.</p>
258	A parameter record has been selected as a recipe. Parameter records can not be edited directly.	Only individual data records of a parameter record can be edited.

Message	Cause	Remedy:
259	Transfer of a data record to the PLC is taking too long. Example: PLC is not acknowledging data record or very large data records are being transferred.	Check PLC program. In the case of large data records no modifications are necessary as the function is being processed correctly.
260	Operating mode of PLC does not match the configuration.	Change operating mode of PLC.
261	The data in this data record is no longer consistent and it can therefore no longer be used.	Edit data record and check that all entries are correct.
262	Password or query window already in use by another function.	Complete first function then execute desired function again.
263	Specified remaining buffer space for messages has been reached!	Configure smaller remaining buffer, delete event/alarm message buffers.
264	Message buffer overflow.	The overflow messages are printed out if so specified in the configuration.
265	The number of passwords issued has already reached 50. You can not enter any more passwords.	If you wish to issue additional passwords, you must first delete some of the existing ones.
266	The field configured in the PLC job does not exist.	Change the parameters of the PLC job and retransfer the configuration.
303	Fault in connection with PLC. S5: this error may occur when transferring large data records. In such cases the watchdog is activated.	Check PLC status. S5: set value in data word 98 to at least 2000.
305	Data block number missing.	Set up data block or change configuration.
306	Incorrect CPU specified under "PLC -> Parameters".	Change configuration and retransfer.
307 ... 311	Variable not present on PLC	Check configuration of process link.
316	Active password level insufficient for menu item	Enter password with higher password level.
339	Startup completed.	Communication with PLC has been resumed.
340	Status processing in progress on PU/PC. The OP can not be used while this is going on.	
341	<i>Internal error</i> With non-Siemens connections: data block error	
342	Network node has illegal address.	Max. addresses: S7-MPI: 32 PROFIBUS-DP: 128
343	You are attempting to edit a variable of a type that can not be edited in a recipe: currently applies to ARRAY variables only.	
350	PLC is performing initialization. You can not enter any setpoints during initialization. Scrolling of screens is possible.	This operating mode may be set by the PLC programmer.
351	PLC has completed initialization. You can resume entering setpoints once this message has appeared.	

Message	Cause	Remedy:
352	You are attempting to select a screen that does not exist or has been disabled by the function Hide.	
353	The minimum value is greater than the maximum value for variable scales.	Minimum and maximum values are being confused by OP. To prevent this, enter correct minimum and maximum values.
354	You are attempting to enter a value in an input field when the current password level is insufficient for input.	Log on with a higher password level.
355	Entry of this variable has not been configured for the current PLC mode.	
356	A print function has been initiated on the OP. When attempting to print it has been ascertained that the printer is offline.	Switch the printer online. Check the connection between the OP and the printer. Has the printer been connected to the correct interface?
357	You are attempting to enter a setpoint that contains an illegal character.	Enter the value correctly.
358	The OP is currently executing a function which does not permit use of the OP while it is in progress.	Wait until the function has been completed. This message may appear in the case of recipe functions, for example.
365	Incorrect index.	A multiplex index is outside the defined range.
370	Hard copy print-out has been cancelled manually.	
371	Print function disabled at present.	
372	The function started has been cancelled.	
383	For information: transfer of data records completed.	
384	Data record required is not on data medium.	Check the data record selection parameters (recipe, data record name, data medium) or use the Select function to select the data record.
385	Information message: transfer of data records from OP to data medium or vice versa has been initiated.	One possible reason is that operation is no longer possible: The PLC has not reset the corresponding control and acknowledgment bit, which deactivates the recipe mailbox lock, in the interface area.
386	Information message: transfer of data records from OP to PLC or vice versa has been initiated.	
387	Data record not found.	There is no data record relating to the selected recipe on the data medium.
388	Activating selected function.	
389	De-activating selected function.	
391	No Help text configured.	Check configuration.

Message	Cause	Remedy:
442	Data block error x DB no. y This message indicates a data block error. The variables x and y identify the cause of the fault (X) and the number of the receive block concerned (Y). Variable x: 0 incorrect block length entered in receive block No. y . 1 incorrect block number entered in receive block No. y .	Correct the block length/block number as necessary or send the correct data block.
450	When entering a value, you have attempted to press a key that is not compatible with the defined input field.	
451	You have entered a setpoint that is below the configured lower limit.	Enter a value that is greater than or equal to the limit.
452	You have entered a setpoint that is above the configured upper limit.	Enter a value that is less than or equal to the limit.
453	Time not entered correctly.	Enter time correctly
454	Interface parameters incorrectly set, e.g. when specifying parameters for printer interface	Enter valid value for interface parameters. The following values are valid: – Baud rate: 300, 600, 1200, 2400, 4800, 9600, 19200 – Data bits: 5,6,7,8 – Stop bits: 1,2 – Timeout: 1...600
455	You have set graphics printing on the OP but the corresponding ESC sequence has not been configured.	Select a different printer or check printer configuration in ProTool.
456	You have entered an incorrect value, e.g. a variable with a user function that blocks certain input values.	Enter permissible value.
458	You have entered a value that is too great or too small for the variable type concerned, e.g. a value greater than 32767 for a variable of the type Integer.	Enter a value that is within the permissible range.
459	You are attempting to enter an illegal character (e.g. letter in a numerical value) The input is rejected and the existing entry retained.	Enter permissible value.
500...503	Scheduler, counter, date or time data can not be sent.	This error can occur if the PLC is temporarily overloaded or if the function block is not invoked for more than 1.5 s.
504	Free ASCII Protocol: operator input value could not be sent.	
505	The data record can not be sent as the recipe disable bit on the PLC is set or because transfer of a recipe is still in progress.	Try sending again later when the PLC has released the recipe mailbox.
506	Overload: too many message blocks with the same block number in transit.	This error occurs if the PLC sends too many jobs using 'collect message area' within a certain period of time.
507	Transfer of the data record was not acknowledged by the PLC within a certain period.	Checking of data records by the user at the PLC end must be carried out more quickly (< 10 s).
509	Firmware version is different from standard FB version.	Please contact the SIMATIC Hotline.
510	Data record not present.	A process link with a non-existent data block has been configured in a recipe or the recipe data contains errors.

Message	Cause	Remedy:
512	Configured data block length is too short. The variable transferred with the message identifies the number of the data block.	Change configuration and retransfer.
541 ... 550	Specified variable not available on PLC	Change configuration and retransfer.
551	An MPI/PPI connection to the PLC cannot be established using the specified station address.	Check MPI station addresses and wiring.
552	Query: safety check as to whether the selected data record is to be deleted. The data record is only deleted if 0 is entered. If not the function is cancelled.	This query is also used when backing up or restoring configurations. In that case, it relates to deletion of all data records in the system memory.
553	Information message: selected data record has been deleted.	
554	Query: 1st safety check as to whether the data medium for storing data records is to be formatted. Any data records already on the disk will be deleted when the function is executed! The function is only executed if 0 is entered.	
555	Query: 2nd safety check as to whether the data medium for storing data records is to be formatted. Any data records already on the disk will be deleted when the function is executed! The function is only executed if 0 is entered.	
556	Information message: disk has been formatted.	
557	Query: if 0 is entered the data record will be adopted with the new values. If anything else is entered, you may continue editing.	
558	Query: if 0 is entered the edited data record is rejected. The data remains as it was before editing. If anything else is entered, you may continue editing.	
559	Query as to whether the event message buffer should be cleared.	
560	Query as to whether the alarm message buffer should be cleared.	
561	A global data record (rel. 3.0 or higher) is being edited and does not have all the entries defined in the current recipe.	The data record can only be saved if the marked entries are edited. If no entries are marked, only the version number has changed.
562	Information as to which mode was set using the function "First/Last Message".	
563	Information as to which mode was set using the function "First/Last Message".	
564	Query: if 0 is entered the data record is created. If anything else is entered, the function is cancelled.	

Message	Cause	Remedy:
565	On transferring a global data record, it is established that not all entries are present. You have the following options: 1: read the missing entries from the PLC 2: edit the missing entries 3: cancel the Download operation.	Only returned in the case of data records that are transferable from one recipe to another. rel. 3.0 or higher, plastic functions.)
566	Data record contains array that does not fit the current recipe structure.	The following question appears: Save yes/no ? If you elect to save, the array data is set to 0.
567, 568	If the message buffer has to be cleared, pending event/ alarm messages also have to be deleted in order to make space for new message events.	Check configuration. Too many messages are pending.
569	Fault on CPI module.	<ul style="list-style-type: none"> – CPI no.: defective CPI module – Error: <ul style="list-style-type: none"> 1 = Voltage too low 2 = Current too high 3 = Temperature too high 4 = Module not present (failed during operation)
571	S7 system diagnosis/ALARM_S returns error if OP logs on/off.	CPU operating system out of date.
572	Query: data record already exists on data medium.	If 0 is entered the data record will be overwritten with the new values.
604	Message does not exist.	Configure message.
605	Process link is only configured symbolically.	Change configuration and retransfer.
606	Too many message variables configured.	
607	Data type configured does not exist.	
613	Data block not available or too short.	Create data block of required length on the PLC.
622	Configured recipe does not fit in recipe mailbox on PLC (> 512 data words).	Reduce configured size of recipe and retransfer configuration.
623	<i>Internal error</i> Screen object for "Send Recipe" is not a recipe type (fixed by COM TEXT).	If the fault is not corrected by performing a restart, please contact the SIMATIC Hotline.
624	No recipe entries found.	Set up area pointers and retransfer configuration.
625	Recipe number does not exist.	Reconfigure recipe.
626	No setpoints have been configured.	
627	<i>Internal error</i> Configured keyboard block number too high.	Correct the block number.
628	Recipe does not fit in mailboxes.	Increase configured size of recipe mailbox or succeeding recipe mailbox.

Message	Cause	Remedy:
636	Event message is not configured	Configure event message (-> message number) fully.
640	Alarm message is not configured	Configure alarm message (-> message number).
645	<i>Internal error</i> PLC co-ordination area not receivable during startup.	Press key to restart. If the fault is not corrected by performing a restart, please contact the SIMATIC Hotline.
649	<i>Internal error</i> Driver number configured can not be interpreted.	If the fault is not corrected by performing a restart, please contact the SIMATIC Hotline.
650	Missing area pointer.	Configure an area pointer.
653	The configured user version number does not match the version number stored on the PLC.	Change configuration and retransfer.
655	PLC acknowledgement area does not physically follow on from the alarm messages area (-> no startup).	
657	Configured PLC protocol is not possible.	Use current firmware version or configure different protocol.
667	Configuration error: Variable x: 1 Data type is not DB 2 DB number is greater than 15 3 DB length is greater than 1024 4 DW is in data block header 5 Actual value not in send block 6 Setpoint not in receive block 7 Setpoint/actual value not in receive block 8 Initial value not in send block 9 Data type is not DB 10 DB number is greater than 15 11 DB length is greater than 1024 12 DW is in data block header 13 Area is in wrong DB 14 Sum of data blocks too great	x = 1..8: Change the configuration of the process link and retransfer. x = 9..13: Change configuration of area pointer and retransfer x = 14: Restrict configuration and retransfer.
668	Incorrect configuration. Meaning of variables: 1: Incompatible PLC types configured 2: No PLC configured 3: Incorrect baud rate configured	Change configuration and retransfer.
669	Too many actual values (> 512) have been configured for cyclic reading in a screen/variable.	
670	Too many variables requested simultaneously.	Lengthen standard clock pulse or configure fewer variables on screen.
671	Configuration of message variables incompatible. Differences between configuration and PLC.	Check S7 programs, check message server configuration, modify configuration and download again.
672	Message not configured.	
680	Selection of a recipe not defined in the project.	Select a valid recipe.

Message	Cause	Remedy:
681	Overload caused by too many variables (setpoints/actual values). Fault in connection between the OP and PLC.	Check the interface parameters.
682	Incorrect interface parameters configured.	Configure fewer process links for the screen displayed.
683	Configuration error: upper limit = lower limit	Correct the limits and retransfer configuration.
684	Non-existent trend switch buffer requested.	Check PLC program/OP configuration. Only use trend request area 2 for trends with switch buffer.
701	<i>Internal error</i> Incorrect assignment of "head → res" when receiving variable.	
702	Job can not be executed.	Change interface or configure area pointer.
703	Flash memory full.	Restrict the configuration.
704	Incorrect CPU specified under "PLC → Parameters".	Change configuration and retransfer.
706	Recipe request will not be processed as another request is already active.	
722	<i>Internal error</i> Incorrect mailbox type received (OP15 → OP5)	
723	<i>Internal error</i> OP5: more than 500 messages are specified in the area pointer lists.	Change area pointer list.
724	<i>Internal error</i> Mailbox type not implemented.	
771	<i>Internal error</i> Error during communication (→ messages).	
779	<i>Internal error</i> Internal error during MPI download; possibly due to buffer problems.	Reset and repeat MPI download.
780	<i>Internal error</i> Undefined error from communication with PLC.	
781	An "Online Setter" function has been incorrectly defined in ProTool.	

SIMATIC HMI Documentation

E

Target groups

This manual is part of the SIMATIC HMI documentation. The documentation is aimed at the following target groups:

- Newcomers
- Users
- Configurers
- Programmers
- Commissioning engineers

How the documentation is organized

The SIMATIC HMI documentation consists of the following components:

- User's Guides / User's Manuals for:
 - Configuration software
 - Runtime software
 - Communication between PLCs and operating units
- Equipment Manuals for the following operating units:
 - MP (Multi Panel)
 - OP (Operator Panel)
 - TP (Touch Panel)
 - TD (Text Display)
 - PP (Push Button Panel)
- Online Help on the configuration software
- Start-up Guides
- First Steps

Overview of complete documentation

The following table provides an overview of the SIMATIC HMI documentation and shows you when you require the different documents.

Documentation	Target Group	Content
First Steps with ProTool Product Brief	Newcomers	This documentation guides you step by step through the configuration of <ul style="list-style-type: none"> • a screen with various objects • changing from one screen to another • a message. This documentation is available for: <ul style="list-style-type: none"> • OP3, OP5, OP7, OP15, OP17 • OP25, OP27, OP35, OP37, TP27, TP37 • Windows-based systems
ProTool Configuring Windows-based Systems User's Guide	Configurers	Provides information on working with the ProTool/Pro configuration software. It contains <ul style="list-style-type: none"> • information on installation • basic principles of configuration • a detailed description of configurable objects and functions. This documentation is valid for Windows-based systems.
ProTool Configuring Graphics Displays User's Guide	Configurers	Provides information on working with the ProTool configuration software. It contains <ul style="list-style-type: none"> • information on installation • basic principles of configuration • a detailed description of configurable objects and functions. This documentation is valid for graphic display operating units.
ProTool Configuring Text-based Displays User's Guide	Configurers	Provides information on working with the ProTool/Lite configuration software. It contains <ul style="list-style-type: none"> • information on installation • basic principles of configuration • a detailed description of configurable objects and functions. This documentation is valid for text-based display operating units.
ProTool Online Help	Configurers	Provides information on the configuration computer while working with ProTool. Online Help contains <ul style="list-style-type: none"> • context-sensitive help • detailed instructions and examples • detailed information • all the information from the user guide.
ProTool/Pro Runtime User's Guide	Commissioning engineers, Users	Provides information on working with ProTool/Pro Runtime software. It contains <ul style="list-style-type: none"> • installation of the ProTool/Pro Runtime visualization software • commissioning and running the software on Windows-based systems.
Copy Protection Start-up Guide	Commissioning engineers, Users	The ProTool/Pro Runtime visualization software is a copy-right product. This manual contains information on the installation, repair and uninstallation of authorizations.

Documentation	Target Group	Content
Application Example Start-up Guide	Newcomers	ProTool is supplied with example configurations and the corresponding PLC programs. This documentation describes how you <ul style="list-style-type: none"> load the examples onto the operating unit and PLC run the examples and upgrade the connection to the PLC to suit your own specific application.
MP270 Equipment Manual	Commissioning engineers, Users	Describes the hardware and the general operation of Multi Panel MP270. It contains <ul style="list-style-type: none"> installation and commissioning instructions a description of the equipment operating instructions instructions for connecting the PLC, printer and programming computer, maintenance instructions.
OP37/Pro Equipment Manual	Commissioning engineers, Users	Describes the hardware, installation and inclusion of upgrades and options for the OP37/Pro.
TP27, TP37 Equipment Manual OP27, OP37 Equipment Manual OP25, OP35, OP45 Equipment Manual OP7, OP17 Equipment Manual OP5, OP15 Equipment Manual TD17 Equipment Manual	Commissioning engineers, Users	Describes the hardware and general operation. It contains <ul style="list-style-type: none"> installation and commissioning instructions operating unit description connecting the PLC, printer and programming computer operating modes operation description of the standard screens supplied with the operating unit and how to use them fitting options maintenance and fitting of spare parts.
OP3 Equipment Manual	Commissioning engineers, Users, Programmers	Describes the hardware of the OP3, its general operation and the connection to the SIMATIC S7.
PP7, PP17 Equipment Manual	Commissioning engineers, Users	Describes the hardware, installation and commissioning of push-button panels PP7 and PP17.
Communication User's Manual	Programmers	Provides information on connecting text-based and graphics displays to the following PLCs: <ul style="list-style-type: none"> SIMATIC S5 SIMATIC S7 SIMATIC 500/505 drivers for other PLCs This documentation describes the <ul style="list-style-type: none"> configuration and parameters required for connecting the devices to the PLC and the network user data areas used for exchanging data between operating unit and PLC.

Documentation	Target Group	Content
Communication for Windows-based Systems User's Manual	Programmers	Provides information on connecting Windows-based systems to the following PLCs: <ul style="list-style-type: none"> • SIMATIC S5 • SIMATIC S7 • SIMATIC 505 • Allen Bradley PLC 5/SLC 500 This documentation describes the <ul style="list-style-type: none"> • configuration and parameters required for connecting devices to the PLC and the network • user data areas used for exchanging data between operating unit and PLC.
Other PLCs Online Help	Programmers	Provides information on connecting devices to PLCs, such as: <ul style="list-style-type: none"> • Mitsubishi • Allen Bradley • Telemecanique • Modicon • Omron • SIMATIC WinLC When the drives are installed, the relevant Online Help is installed at the same time.
ProAgent for OP User's Manual	Configurers	Provides the following information about the ProAgent optional package (process diagnosis) for OPs <ul style="list-style-type: none"> • configuring system-specific process diagnosis • detecting, locating the cause of and eliminating process errors, • customizing standard diagnostic screens supplied with the software.

ESD Guidelines

F

What does ESD mean?

Virtually all present-day modules incorporate highly integrated MOS devices or components. For technological reasons, these electronic components are very sensitive to overvoltages and consequently therefore to electrostatic discharge:

These devices are referred to in German as Elektrostatisch Gefährdeten Baelemente/ Baugruppen: "EGB"

The more frequent international name is:

"ESD" (Electrostatic Sensitive Device)

The following symbol on plates on cabinets, mounting racks or packages draws attention to the use of electrostatic sensitive devices and thus to the contact sensitivity of the assemblies concerned:

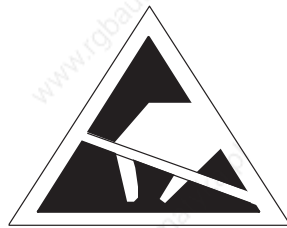

ESDs may be destroyed by voltages and energies well below the perception threshold of persons. Voltages of this kind occur as soon as a device or an assembly is touched by a person who is not electrostatically discharged. Devices exposed to such overvoltages cannot immediately be detected as defective in the majority of cases since faulty behavior may occur only after a long period of operation.

Precautions against electrostatic discharge

Most plastics are capable of carrying high charges and it is therefore imperative that they be kept away from sensitive components.

When handling electrostatic sensitive devices, make sure that persons, workplaces and packages are properly grounded.

Handling ESD assemblies

A general rule is that assemblies should be touched only when this cannot be avoided owing to the work that has to be performed on them. Under no circumstances should you handle printed-circuit boards by touching device pins or circuitry.

You should touch devices only if

- you are grounded by permanently wearing an ESD wrist strap or
- you are wearing ESD shoes or ESD shoe-grounding protection straps in conjunction with an ESD floor.

Before you touch an electronic assembly, your body must be discharged. The simplest way of doing this is to touch a conductive, grounded object immediately beforehand – for example, bare metal parts of a cabinet, water pipe etc.

Assemblies should not be brought into contact with charge-susceptible and highly insulating materials such as plastic films, insulating table tops and items of clothing etc. containing synthetic fibers.

Assemblies should be deposited only on conductive surfaces (tables with an ESD coating, conductive ESD cellular material, ESD bags, ESD shipping containers).

Do not place assemblies near visual display units, monitors or television sets (minimum distance to screen > 10 cm).

Measuring and modifying ESD assemblies

Perform measurements on ESD assemblies only when

- the measuring instrument is grounded – for example, by means of a protective conductor – or
- the measuring head has been briefly discharged before measurements are made with a potential-free measuring instrument – for example, by touching a bare metal control cabinet.

When soldering, use only grounded soldering irons.

Shipping ESD assemblies

Always store and ship assemblies and devices in conductive packing – for example, metallized plastic boxes and tin cans.

If packing is not conductive, assemblies must be conductively wrapped before they are packed. You can use, for example, conductive foam rubber, ESD bags, domestic aluminum foil or paper (never use plastic bags or foils).

With assemblies containing fitted batteries, make sure that the conductive packing does not come into contact with or short-circuit battery connectors. If necessary, cover the connectors beforehand with insulating tape or insulating material.

Glossary

A

Alarm message

Calls attention to high-priority operating states and has therefore to be acknowledged.

Alarm time

Time between the arrival and departure of an alarm message.

Area pointer

Required for data exchange between the OP and the PLC. It contains information concerning the length and size of data areas on the PLC.

Arrival of a message

The point in time at which a message is issued by the PLC or OP.

AT expansion slot

Option for the OP37 for accommodating two 2/3-length 16 bit AT cards.

Automation systems

PLCs of the SIMATIC S7 series – for example, SIMATIC S7-200/300/400

B

BIOS Setup

Contains basic settings for the OP37 in DOS mode.

Blanking

Automatic turn-off of display back lighting.

Boot

A load operation which transfers the operating system to working memory on the OP.

C

Configuration

Definition of system-specific basic settings, messages and screens using the ProTool configuration software.

Control panel interface Option for the OP27 with a maximum of one block and for the OP37 with a maximum of two blocks of 16 digital inputs/outputs for high-speed key operation without communication-related delays. May be used under SIMATIC S7 and PROFIBUS-DP.

D

Departure of a message The point in time at which a message is withdrawn by the PLC.

Direct key module Option for the OP27 with a maximum of one block and for the OP37 with a maximum of two blocks of 8 digital outputs for high-speed key operation without communication-related delays.

Display function Function causing the contents of the display to be modified – for example, Display Message Level, Display Alarm Buffer And Display Process Screen.

DOS mode An OP operating mode allowing MS-DOS and Windows applications to be loaded and edited.

Download mode Operating mode of the OP during which data are downloaded from the PU or PC to the OP.

Duration of display The time between the arrival and departure of a message.

E

Event message Draws attention to specific operating states on machines or systems connected to the PLC.

F

Field Reserved area in configured and non-configurable text for the output and/or input of values.

Flash memory Programmable memory which can quickly be deleted and then re-written.

Forced printout Printout of alarm messages or event messages which were deleted as a result of a buffer overflow.

I

Information text Additional, configurable information for messages, screens, screen entries and list boxes.

M

Message log Printout of alarm messages and event messages simultaneously with their output to the display.

N

Normal mode Operating mode of the OP during which messages can be displayed and screens can be controlled by the operator.

O

Output field Field for displaying a setpoint.

P

Password, Password level To control a protected function, a password of a specific password level has to be entered. The password level determines the privileges of the operator. The requisite password level can be configured, 0 being the lowest level and 9 the highest.

PCMCIA

Personal Computer Memory Card International Association

An association of computer companies whose aim is the establishment of an international standard for memory cards and PC expansion cards. Co-operates with **JEIDA**.

PLC

Generic term for devices and systems with which the OP communicates – for example, SIMATIC S5/S7 or PCs.

PLC job

Function triggered by the PLC.

Printout

Output of the contents of the display to an attached printer.

Process screen Representation of process values and process sequences in the form of screens, which may contain graphics, pieces of text and values.

S

Screen Form of displaying logically associated process data which may be shown collectively on the OP and modified individually.

Screen entry Element of a screen, consisting of the entry number, text and variables.

Selection field Field for the value setting of a parameter (one value can be selected as the default value).

Startup test Checks the state of the CPU and memories every time the power supply voltage is turned on.

System message Calls attention to internal states on the OP and on the PLC.

Index

A

- Access permissions, 5-1
- Access protection, 5-1
- Acknowledge, alarm message, 6-4
- acknowledge , alarm message, 6-2
- acknowledged, message event, 6-8
- Acknowledged message, 6-1
- Acknowledging , Alarm message, 6-6
- Acknowledgment group
 - alarm message, 6-5
 - Set, 6-18
- acknowledgment group, 6-8
- Acknowledgment groups, 6-6
- acknowledgment groups, alarm message, 2-1
- additional information, 1-4
- Alarm buffer, deleting, 6-16
- Alarm message
 - acknowledging, 6-4, 6-6
 - alarm message, 6-2, 6-6
 - alarm message buffer
 - close, 6-16
 - print, 6-16
 - alarm message page, close, 6-16
- Alarm message window, 6-4
- alarm messages, 1-4, 2-1
- Alphanumeric field, 3-11
- alphanumeric input, example, 3-12
- Alphanumeric values, entering, 3-10
- angle of inclination, 12-1, A-5
- Applications, 1-1
- Appropriate installation, 12-1
- Arrived, message, 6-1
- arrived, message event, 6-8
- AS511, connection, 16-4, 17-5
- ASCII
 - character set, 13-7
 - Hardcopy, 7-4
- assign, printer colors, 7-4
- assignment, interfaces, B-1
- AT expansion slot, 18-2
 - connection, 17-4
 - installing, 18-2
- atmospheric discharge, A-6
- authorization, 5-1

B

- Back-lighting, 11-4, A-2
 - replacing
 - OP27C, 19-7
 - OP37, 19-12
- Backup, Flash module, 9-6
- backup, 2-3
- Backup battery, changing, 19-2
- backup battery, A-2
- Backup/Restore, Standard screen, 9-5
- bar graph, 1-3
- barometric pressure, A-5
- Basic functions, 1-3
- Battery, change, 19-2
- Battery , connection, 17-4
- battery compartment, 19-3
- Baud rate, printer, 7-3
- Blanking, screen, 11-4
- Block driver, 2-4
- Boot operation, 14-4
- bottling machine, example, 8-1
- Brightness, back lighting, 19-12
- burst interference, A-6

C

- Calculator format, 3-9
- call, Function, 4-4
- Call in
 - message buffer, 6-10
 - message page, 6-10
- Call setup, CTRL+ALT+ESC, 15-2
- calling, help text, 3-14
- Cancel incorrect input, 3-8
- capacity
 - backup battery, A-2
 - message buffer, 2-1
- Category, System message, D-1
- category, messages, 6-2
- cause of malfunction, acknowledging, 6-6
- Causes, System message, D-2
- Centronics interface, B-3
- Certifications, A-6

- Change
 - language, 11-5
 - operating mode, 11-3
 - change
 - password, 5-5
 - password level, 5-5
 - character sets, 2-3
 - number, 2-3
 - character size, character set, 2-3
 - Chassis ground, 13-3
 - chassis ground, 17-4
 - Clean, 19-1
 - screen, 19-1
 - Cleaning agents, 19-1
 - Clear, data medium, 9-3
 - Clock frequency, A-1
 - Close, event message window, 6-16
 - close
 - alarm message buffer, 6-16
 - alarm message page, 6-16
 - event buffer, 6-16
 - event message screen, 6-16
 - event message window, 6-5
 - color assignment, printer, 7-4
 - Combination, Message window/Message line, 6-3
 - combination, variables, 8-1
 - commissioning, 14-1
 - communication, 1-2, 2-4
 - Communication options, 16-4, 17-5
 - Compress, internal program memory, 14-2
 - concept, operating, 3-1
 - Condensation, 12-1
 - conduction, RF, A-6
 - Configuration, 1-2
 - loading, 14-2
 - testing in Offline mode, 14-7
 - testing with PLC, 14-8
 - Configuration computer, connecting, 13-4
 - configuration computer, 1-2
 - configuration data, download, 1-2
 - Configuration options, 13-2
 - configuration software, 1-1
 - Configure, interface IF1B, 13-6
 - Confiruation using ProTool, 1-2
 - Connect
 - PC or PU, 16-4, 17-5
 - printer, 16-4
 - connect, printer, 17-5
 - Connecting
 - configuration computer, 13-4
 - ground, 13-3
 - light, siren etc., 13-3
 - PLC, 13-5
 - power supply, 13-3
 - printer, 13-7
 - PU or PC, 13-4
 - connection
 - AT expansion slot, 17-4
 - Battery , 17-4
 - MF2 keyboard, 17-4
 - PS2 mouse, 17-4
 - Connection configuration, Printer, 13-7
 - Connection configuration diagram
 - configuration computer, 13-4
 - PLC, 13-5
 - printer, 13-7
 - Connection elements, 16-3, 17-4
 - Connection options, 13-5
 - connections, Electrical, 13-1
 - Connector, battery, 19-2
 - consequential malfunction, acknowledging, 6-6
 - Contact assemblies
 - power supply connection, A-2
 - temperature monitoring, A-3
 - contact discharge, A-6
 - contrast, set, 3-7
 - Control panel interface, installing, 18-11
 - Control Tag, 10-1
 - Operating sequence, 10-6
 - Standard screen, 10-2
 - control tag, standard screen, 10-5
 - Conversion functions, 2-2
 - Correct, incorrect input, 3-8
 - Create, Record set, 8-16
 - create
 - data record, 8-9
 - Labeling strips, 16-6, 17-8
 - password, 5-4
 - CSA-certification, A-6
 - cut, Labeling strips, 17-8
 - cut out, Labeling strips, 16-6
- D**
- Data, technical, A-1

- data
 - loading, 9-1
 - storing, 9-1
- data areas, set up, 1-1
- data bits, printer, 7-3
- Data media, 9-1
- data medium, format, 8-8
- Data record
 - Download, 8-12
 - Load, 8-12, 8-14
 - Save, 8-14
 - Update, 8-13
- data record
 - creating, 8-9
 - deleting, 8-12
 - edit window, 8-10
 - editing, 8-10
 - saving, 8-11
- Data records, 8-1
- data structure, 1-4, 8-1
- Data types, 9-1
- Date, Set, 6-18
- date, message, 6-5
- Date/time, setting, 11-5
- Decimals, 3-9
- Degree of protection, 12-1
- degree of protection, A-1
- Delete, 14-3
 - alarm buffer, 6-16
 - event buffer, 6-16
- delete
 - data record, 8-12
 - messages, 6-11
 - password, 5-5
 - record set, 8-17
- Deleting, messages, 6-12
- Deleting messages, buffer overflow, 6-11
- Deletion, messages, 6-11
- Departed, message, 6-1
- departed, message event, 6-8
- Departed messages, 6-1
- Description
 - OP27, 16-1
 - OP37, 17-1
- Design, interference free, 13-1
- Digital inputs/outputs, 18-10
 - via control panel interface, 16-3
- Digital inputs-/outputs, Via control panel interface, 17-4
- Digital outputs, 18-4
 - Via direct key module, 17-4
 - via direct key module, 16-3
- DIL switch, 13-6, 16-3
- Dimensions, 16-1, 17-2, A-1
- DIP-switch, 17-4
- Direct key module, 18-4
 - installing, 18-5
- direct message logging, 6-13
- disable
 - message logging, 6-13, 6-20
 - overflow warning, 6-20
- discharge, static , A-6
- disk, 9-2
- Display, 1-6, 16-2, 17-3
 - replacing, 19-5
- display, 2-3, A-2
 - alarm messages, 2-1
 - event messages, 2-1
 - fill level, 1-3
 - messages, 6-8
 - pressure variation, 1-3
 - quantities, 1-3
 - temperature variation, 1-3
- Display contrast, set, 3-7
- Display elements, 16-2, 17-3
- Display functions, 1-3
- Display mode, messages, 6-3
- Display priorities, messages, 6-4
- display type, alarm messages, 2-1
- displaying, graphic elements, 1-3
- displaying the time window, 3-5
- Disposal, lithium battery, 19-3
- Documentation, E-1
- DOS -mode, 15-1
- DOS mode, 11-3
- Download, Data record, 8-12
- download
 - configuration data, 1-2
 - Serial, 14-3
- Download mode, 11-3, 14-2
- DP direct keys, 2-3
- DRAM, A-1
- Driver
 - SIMATIC 500/505, 2-4
 - SIMATIC S5, 2-4
 - SIMATIC S7/M7, 2-4
- Dynamic window, 3-3

E

- edit
 - data record, 8-10
 - password, 5-5
 - record set, 8-15
- Edit Data Record, Standard screen, 8-6
- Edit Data Records, Standard screen, 8-4
- Edit Message, Standard screen, 6-12
- Edit mode, 3-6
- Edit Password, Standard screen, 5-2
- Edit window, Data records, 8-10
- Electrical connections, 13-1
- Electrical Installation, 13-1
- EMC compatible installation, 13-1
- enable
 - message logging, 6-13, 6-20
 - overflow warning, 6-20
- Enlarge, memory area, 9-4
- enter, password, 5-3
- Entering alphanumeric values, 3-8
- Entering numeric values, 3-8
- Entering values
 - alphanumeric, 3-8
 - numeric, 3-8
 - symbolic, 3-8
- Equipment dimensions, 16-1
- Error handling, D-2
- Errors, internal, D-2
- ESD Guidelines, F-1
- Event buffer, deleting, 6-16
- event buffer
 - close, 6-16
 - open, 6-16
 - print, 6-16
- event message, 6-2
 - inhibiting, 6-3
- event message screen
 - close, 6-16
 - open, 6-16
- Event message window, 6-5
 - closing, 6-16
 - opening, 6-16
- event message window, opening, 6-5
- event messages, 1-4, 2-1
- example
 - alphanumeric input, 3-12
 - Enter symbolic values, 3-13
- Exchange, backup battery, 19-2
- External dimensions, A-1
- External power supply, 18-4, 18-10

F

- Fan, 13-3
- FAP connection, 16-4, 17-5
- Fields
 - alphanumeric, 3-11
 - numeric, 3-9
- File, Labeling strips, 16-6
- file, Labeling strips, 17-8
- fill level, display, 1-3
- Firmware, 13-1
 - loading, 14-2
- Fitting, 12-3
- Fixation, OP27, 12-2
- Fixed window, 3-1
- Flash, 9-2, A-1
 - alarm message, 6-4
- Flash memory, clearing, 9-3
- Floppy disk drive, 17-3, A-1
 - replacing, 19-14
- Fluorescent tube, 19-12
- FM-certification, A-6
- format
 - data medium, 8-8
 - password, 5-2
- Front flap, 17-3
- Front view, 16-1, 17-2
- Function, call, 4-4
- Function key, 4-2
- Function keys, 16-2, 17-3
- function keys, 3-5
- functionality, 2-1
- Functions, Password management, 5-4
- Fuse, A-2
- fuse, A-2

G

- general operation, 3-1
- generate, data record, 8-9
- graphic elements, display, 1-3
- Graphics, Hardcopy, 7-4
- Grounding screwdriver, 13-3
- group acknowledgement, 6-6

H

- Hard disk, A-1
- hard disk, 9-2
- hardware -test , start, C-1

- Hardware clock, 19-2
 - Hardware test
 - display test, C-4
 - internal functional unit test, C-5
 - keyboard test, C-4
 - procedure, C-1
 - setting on selection screen, C-3
 - terminate, C-2
 - test memory, C-3
 - test serial interfaces, C-4
 - HELP, 3-14
 - Help Text, 3-14
 - help text, 2-2
 - Help texts, 1-4
 - Help window, 3-2
 - help window, 3-1
 - hide
 - event messages, 6-3
 - system message, 6-7
 - hierarchy
 - Password, 5-1
 - standard screens, 4-4
 - hints on operation, messages, 6-2
 - housing, A-1
 - humidity, A-5
- I**
- Icon, 3-1
 - identify, recipe, 8-2
 - IF1A interface, 16-3
 - Assignment, B-1
 - IF1B interface, 16-3
 - Assignment, B-2
 - IF2 interface, 16-3
 - Assignment, B-1
 - IF3 interface, Assignment, B-2
 - Incorrect input, correcting, 3-8
 - Indicator, alarm messages, 6-6
 - ingredients, recipe, 8-2
 - inhibit, event message, 6-3
 - Initial startup, 14-2
 - initial startup, 14-1
 - Initialize
 - data medium, 9-3
 - OP, 14-6
 - Input
 - alphanumeric values, 3-10
 - left justified, 3-11
 - numeric, 3-9
 - right justified, 3-9
 - symbolic, 3-13
 - input field, 1-3, 4-2
 - Input window, 3-1
 - Insert, memory card, 9-6
 - Install
 - device, 12-1
 - OP37, 12-3
 - Installation, 12-1
 - 19"- panels/racks, 12-3
 - Electrical, 13-1
 - mechanical, 12-1
 - installation, 12-2
 - OP27, 12-2
 - Installation conditions, 12-1
 - installation position, 12-1
 - Installation possibilities, 1-1
 - Installation site, A-5
 - Integrated Keyboard, 3-4
 - Interface
 - IF1A, 16-4
 - IF1B, 13-6, 16-4
 - IF2, 16-4
 - MPI, 16-4
 - PPI, 16-4
 - serial, 16-3
 - interface, 1-7
 - IF1A, 17-5, B-1
 - IF1B, 17-5, B-2
 - IF2, 17-5, B-1
 - IF3, B-2
 - LPT, 17-5, B-3
 - MPI, 17-5
 - parallel, 17-4
 - PPI, 17-5
 - interface assignment, B-1
 - Interface test, OP27, C-4
 - interfaces, Serial, 17-4
 - Interference free design, 13-1
 - Internal errors, D-2
 - internal operating state, 6-7
 - irradiation, RF, A-6

issue, password, 5-4

J

Job, PLC, 4-2

K

Key functions, 3-5, 3-7

Key labeling, 16-5, 17-6

system specific, 16-5, 17-6

Keyboard, A-2

cleaning, 19-1

function keys, 3-4

system keys, 3-4

Keyboard connection (front panel), 17-3

L

Labeling example, function keys, 16-6

Labeling strips, 16-5, 17-6

Language, changing, 11-5

language change, 2-3

languages, 1-4

number, 2-3

LCD back lighting, 19-12

LCD back-lighting, 11-4

LED displays, 17-3

Left justified input, 3-11

length

alarm messages, message text, 2-1

event messages, message text, 2-1

Lighting, screen, 11-4

Limit value, 3-9

Limit value check, 3-9

limit value monitoring, 2-2

Line, messages, 6-4

line, messages, 6-3

lines per message

alarm messages, message text, 2-1

event messages, message text, 2-1

List

passwords, 5-6

printer, 7-3

System messages, D-1

Literature, E-1

Lithium battery, 19-3

Load

configuration, 14-2

Data record, 8-12, 8-14

firmware, 14-2

Record set, 8-16

load, data, 9-1

logging, messages, 6-13

Logging out, OP, 5-3

Logical link, OP – PLC, 11-3

Login, 5-3

login on OP, 5-3

Logout, 5-3

LPT interface, Assignment, B-3

M

Main area, 3-1

main area, 3-1

Main screen, 4-3

maintenance, 19-1

make, Labeling strips, 16-6, 17-8

management, passwords, 5-4

master copy, Labeling strips, 16-6, 17-8

master labeling copy, function keys, 17-8

Measurements, A-1

Mechanical installation, 12-1

Membrane keyboard, 1-6

Memory, 1-7

memory, A-1

Memory area, Reserved , 9-4

Memory card, 9-2

clearing, 9-3

inserting, 9-6

memory card, A-1

Memory test, OP27, C-3

Message, 1-4

message, 6-1

delete, 6-12

deleting, 6-11

display, 6-3

displaying, 6-8

printing, 6-13

message acquisition, 2-2

Message archive, 2-1, 6-8

Message bit procedure, 6-5

- message buffer, 1-4, 6-5
 - Alarm messages, 2-1
 - Call in, 6-10
 - event messages, 2-1
 - structure, 6-10
 - message display, setting, 6-20
 - Message event, 6-5
 - Set, 6-18
 - message event
 - acknowledgment of alarm message, 6-5
 - arrival of message, 6-5
 - departure of a message, 6-5
 - message events, 2-2
 - number, 2-1
 - printing, 1-4
 - Message indicator, 6-6
 - message indicator, 3-2
 - Message line, 6-3, 6-4
 - message line
 - Alarm messages, 2-1
 - event messages, 2-1
 - Message logging, 6-13
 - message logging, 2-1
 - enabling and disabling, 6-20
 - Message number, D-1
 - message number, 6-5, 6-8
 - message page
 - Alarm messages, 2-1
 - Call in, 6-10
 - event messages, 2-1
 - structure, 6-10
 - Message states, 6-1
 - message text, 6-8
 - Message window, 3-2, 6-3, 6-4
 - MF2 keyboard, connection, 17-4
 - mixing unit, example, 4-1, 4-2
 - Modify
 - memory addresses, 14-2
 - Record set, 8-17
 - Monitor, temperature, 13-3
 - Mounting cutout, 16-1, 17-2, A-1
 - Mounting depth, A-1
 - Mounting location, 12-1
 - MPI, connection, 16-4, 17-5
 - MPI Download, 14-5
 - MPI download, 14-4
 - Multiple languages, 1-4
- N**
- NATIVE drivers, 2-4
 - noise immunity, A-6
- Non-Siemens PLC, connection, 16-4, 17-5
 - normal operation, 14-1
 - Number, message, 6-5
 - number
 - alarm messages, 2-1
 - character sets, 2-3
 - characters
 - alarm message, 2-1
 - event message, 2-1
 - data records per recipe, 2-3
 - entries per data record, 2-3
 - event messages, 2-1
 - languages, 2-3
 - message, 6-8
 - password levels, 2-2
 - passwords, 2-2
 - recipes, 2-3
 - Numeric field, 3-9
- O**
- Offline mode, 11-3
 - Online mode, 11-3
 - OP mode, 11-3
 - OP27
 - installation, 12-2
 - Test adapters, C-6
 - OP37, installing, 12-3
 - Open, event message window, 6-16
 - open
 - alarm message buffer, 6-16
 - alarm message page, 6-16
 - event buffer, 6-16
 - event message screen, 6-16
 - event message window, 6-5
 - opening, Help window, 3-14
 - operate, process, 1-3
 - Operating concept, 3-1
 - Operating elements, 16-2, 17-3
 - operating functions, 1-3
 - Operating mode
 - Change, 11-3
 - setting, 11-3
 - operating mode
 - change, OP → DOS, 15-4
 - changing, DOS → OP, 15-4
 - operating state, internal, 6-7
 - Operating temperature, A-5
 - operation, general, 3-1
 - operator permission, 5-1
 - operator process control, 1-5
 - operator prompting, 2-2

- Options, 1-7, 18-1
- Other PLCs, connection, 16-4
- other PLCs, connection, 17-5
- output field, 1-3
- Output medium, Set, 6-18
- overall reset, 14-3
- Overflow warning, 6-5
 - switch on/off, 6-11
- overflow warning, enabling and disabling, 6-20
- Overview, 1-6
- overwrite, password, 5-5

P

- Parallel interface, 17-4
- Parallel printer connection, 13-7
- Parameter, Printer, 7-3
- parity, printer, 7-3
- Partitioning, Screen, 3-1
- password
 - changing, 5-5
 - creating, 5-4
 - deleting, 5-5
 - enter, 5-3
 - format, 5-2
 - supervisor, 5-2
- Password hierarchy, 5-1
- password level, 5-1
 - changing, 5-5
- password levels, number, 2-2
- password list, view, 5-6
- password management, 5-4
- Password protection, 1-4
- password protection, 1-4, 2-2, 5-1
- passwords, number, 2-2
- PC, connecting, 13-4
- PC or PU
 - Connecting, 17-5
 - connecting, 16-4
- PCMCIA Slots, 17-4
- PCMCIA slots, 16-3
- permission, password protection, 5-1
- Plan view, 16-1, 17-2
- PLC, connecting, 13-5
- PLC job, 4-2
- Pop-up window, symbolic field, 3-13
- Position, window, 3-2
- power consumption, A-2
- Power supply, 16-3
 - connecting, 13-3
 - OP37, 17-4
- power supply, A-2
- Power supply unit, 13-3
- PPI, connection, 16-4, 17-5
- presentation, message, 6-3
- Pressure difference, A-5
- pressure variation, display, 1-3
- Principle, Data storage, 9-2
- Print
 - Buffer, 7-1
 - print screen, 7-1
- print, 1-4
 - alarm message buffer, 6-16
 - event buffer, 6-16
 - Labeling strips, 16-6, 17-8
 - messages, 6-11, 6-13, 7-1
 - screen list, 7-1
- Print buffer, 7-1
- Print functions, 2-2, 7-1
- Print screen, 7-1
- print screen, parameters, 7-4
- Printer, connecting, 13-7, 16-4, 17-5
- Printer interface, Set, 7-3
- Printer Settings, standard screen, 7-2
- Printer type, 7-3
- Priority, 6-9
 - Set, 6-18
- priority, messages, 6-4
- Process
 - control, 4-1
 - controlling, 1-1
 - monitoring, 1-1, 4-1
- process
 - operating, 1-3
 - visualize, 1-3
- process control phase, 1-2
- process disturbance, reporting, 6-2
- process state, reporting, 6-2
- process values
 - alarm messages, 2-1
 - event messages, 2-1
 - messages, 6-5
- process variable, visualizing, 1-1
- processor, 1-7
- processor type, A-1
- Product description, 1-1

PROFIBUS–DP, 16-4, 17-5
ProTool, 1-1
PS2 mouse, connection, 17-4
PU, connecting, 13-4
PU functions, Status/Control Tag, 2-3
pulse modulation, A-6

Q

quantities, display, 1-3

R

radio interference, A-6
rated voltage, A-2
Recipes, 1-4
recipes, 1-4, 2-3, 8-1
 identifying, 8-2
Recommissioning, 14-3
recommissioning, 14-1
Record sets, 8-15
Recording, 1-4
relative humidity, A-5
Relay contacts, 13-3
Relay output, 16-3
 OP37, 17-4
remaining buffer size, 6-5, 6-11
Remedies, System message, D-2
Replace, back–lighting
 OP27C, 19-7
 OP37, 19-12
replacing, Display, 19-5
report, process state, 6-2
Reserved memory area, 9-4
resolution, screen, A-2
Restore
 Firmware/Configuration, 9-7
 Module – Flash, 9-6
Reverse battery protection, 13-1
RF conduction, A-6
RF irradiation, A-6
RFI suppression level, A-6
Right justified input, 3-9
RS232, connection, 16-4, 17-5
RS422, connection, 16-4, 17-5
RS485, connection, 16-4, 17-5
RTS signal, 13-6

S

Save
 Data record, 8-14
 Record set, 8-16
save, data record, 8-11
Screen
 blinking, 11-4
 cleaning, 19-1
screen, select, 4-2
screen elements, 4-1
Screen partitioning, 3-1
Screen saver, 11-4
Screen sections, 4-1
Screens, 1-3
 print, 1-4
screens, 1-3, 2-2, 4-1
Screwtype clamps, 12-2, 12-3
Sections of a screen, 4-1
Securing
 OP, 12-3
 OP37, 12-3
Select, printer, 7-3
select
 record set, 8-15
 screen, 4-2
Self test, 14-6
Serial download, 14-3
Serial interfaces, 16-3, 17-4
Serial printer connection, 13-7
serious system message, 6-7
Service life
 Back–lighting, 19-4, 19-12
 backup battery, 19-2
Set
 Acknowledgment group, 6-18
 Date, 6-18
 date/time, 11-5
 language, 11-5
 Message event, 6-18
 operating mode, 11-3
 Output medium, 6-18
 Printer interface, 7-3
 Priority, 6-18
 Text, 6-18
set
 message display, 6-20
 printer colors, 7-4

- set up, data areas, 1-1
- Settings
 - ASCII character set, 13-7
 - printer, 13-7
- settings
 - printer, 7-2
 - system, 6-19
- Setup, 15-2
 - OP extension, 15-2
 - OP specific settings, 15-2
- shipping conditions, A-5
- shock loading, A-5
- Side view, 16-1, 17-2
- Signaling relay, A-2
- significance, messages, 6-9
- SIMATIC 500/505, connection, 16-4, 17-5
- SIMATIC HMI documentation, E-1
- SIMATIC M7, connection, 16-4, 17-5
- SIMATIC S5, connection, 16-4, 17-5
- SIMATIC S7, connection, 16-4, 17-5
- SLIDE.DOC
 - File, 17-8
 - file, 16-6
- Soft keys, 3-5
- soft keys, 1-6
- sort order, messages, 6-10
- Source of supply, Backup battery, 19-2
- Spare parts service, 19-2
- SRAM, A-1
- SS number, Printer, 7-3
- standard configuration, 4-3
- Standard screen
 - Backup/Restore, 9-5
 - control tag, 10-5
 - Edit Data Record, 8-6
 - Edit Data Records, 8-4
 - Edit Message, 6-12
 - Edit Password, 5-2
 - Output Messages, 6-17
 - Status Tag, 10-2
 - System Settings, 11-1
- standard screen
 - Edit Message, 6-15
 - Printer Settings, 7-2
 - System Settings, 6-19
- standard screens, 4-3
- standby message, 6-3
- Startup behavior, 14-6
- static discharge, A-6
- static window, 3-3
- status, message, 6-1
- status disturbance, reporting, 6-2
- Status Tag, 10-1, 10-2
- Status tag, Operating sequence, 10-4
- Status/Control Tag, 2-3
- stop bits, printer, 7-3
- storage, A-5
- Storage medium, 9-2
- store
 - data, 9-1
 - data record, 8-11
- Structure
 - alarm message page, 6-10
 - Standard screen
 - Backup/Restore, 9-5
 - Edit Data Record, 8-6
 - Edit Data Records, 8-4
 - System Settings, 11-1
 - standard screen
 - edit message, 6-15
 - system settings, 6-19
 - System message, 6-7
- structure
 - alarm message, 6-5
 - message buffer, 6-10
 - message page, 6-10
 - standard screen
 - Edit Message, 6-17
 - Printer Settings, 7-2
- Structure of the documentation, E-1
- Sub-D socket, B-1, B-2
- Summer and winter time, 11-5
- Sunlight, 12-1
- superuser, 5-1
- supervisor, 5-1
 - password change, 5-5
- Switch, interface IF1B, 13-6
- switching power, relay contacts, A-2, A-3
- symbol, message indicator, 6-6
- Symbol lists, 1-3
- Symbolic, Entering values, 3-8
- symbolic name, recipe, 8-2
- Symbolic values
 - entering, 3-13
 - example, 3-13
- System keys, 3-5, 16-2, 17-3
- system message, 6-7
- System message window, 6-7
- System messages, List of, D-1
- System Settings
 - Standard screen, 11-1
 - standard screen, 6-19

T

- Target groups, E-1
- Technical data, A-1
- Temperature monitoring, 13-3
- temperature variation, display, 1-3
- Template, Labeling strips, 16-6
- template, Labeling strips, 17-8
- Terminal block, 13-3
- Test, configuration
 - Offline mode, 14-7
 - With PLC, 14-8
- Test adapters, OP27, C-6
- Test functions, C-1
- Text, Set, 6-18
- text attributes, 2-2
- Texts, 1-4
- time
 - message, 6-5
 - message event, 6-8
- Time/date, setting, 11-5
- Timeout, printer, 7-3
- transfer, data record, 8-13
- Transfer parameters, Printer, 7-3
- transients, A-2
- Transparent foil, 16-6, 17-8
- trends, 1-3
- Trigger hardcopy, 3-5
- Triggering printout, automatically, buffer overflow, 6-11
- TTL connection, 17-5
- TTY connection, 16-4, 17-5
- Type, printer, 7-3
- type, message, 6-2
- Types of downloading, 14-3

- types of message, 6-2

U

- UL-certification, A-6
- Unit description
 - OP27, 16-1
 - OP37, 17-1
- Unit variants, 1-6
- Update, Data record, 8-13
- upkeep, 19-1
- Use, 1-1
- user group, 5-1

V

- Ventilation slots, 12-1
- vibration, A-5
- view, password list, 5-6
- visualize
 - process, 1-3
 - process variables, 1-1
- Voltage, backup battery, A-2

W

- Weight, A-1
- window
 - dynamic, 3-3
 - messages, 6-3
 - select, 3-3
 - static, 3-3
- Window positions, 3-2

