

Absolute Maximum Ratings		Values	Units
Symbol	Conditions ¹⁾		
V _{CES}		1200	V
V _{CGR}	R _{GE} = 20 kΩ	1200	V
I _C	T _{case} = 25/65 °C	50 / 40	A
I _{CM}	T _{case} = 25/65 °C; t _p = 1 ms	100 / 80	A
V _{GES}		± 20	V
P _{tot}	per IGBT, T _{case} = 25 °C	220	W
T _j , (T _{stg})		-40 ... +150 (125)	°C
V _{isol}	AC, 1 min.	2500	V
humidity	DIN 40 040	Class F	
climate	DIN IEC 68 T.1	40/125/56	
Inverse Diode			
I _F = -I _C	T _{case} = 25/80 °C	45 / 30	A
I _{FM} = -I _{CM}	T _{case} = 25/80 °C; t _p = 1 ms	100 / 80	A
I _{FSM}	t _p = 10 ms; sin.; T _j = 150 °C	350	A
I ² t	t _p = 10 ms; T _j = 150 °C	600	A ² s

SEMITRANS® M Low Loss IGBT Modules

SKM 40 GD 124 D



Sixpack

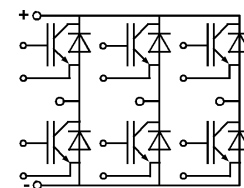

GD

Features

- MOS input (voltage controlled)
- N channel, homogeneous Silicon structure (NPT- Non punch-through IGBT)
- Low loss high density chips
- Low tail current
- High short circuit capability, self limiting to 6 * I_{Cnom}
- Latch-up free
- Fast & soft inverse CAL diodes ⁸⁾
- Isolated copper baseplate using DCB Direct Copper Bonding Technology without hard mould
- Large clearance (9 mm) and creepage distances (13 mm)

Typical Applications

- Switched mode power supplies
- Three phase inverters for AC motor speed control

Characteristics		min.	typ.	max.	Units
Symbol	Conditions ¹⁾				
V _{(BR)CES}	V _{GE} = 0, I _C = 0,8 mA	≥ V _{CES}	-	-	V
V _{GE(th)}	V _{GE} = V _{CE} , I _C = 1 mA	4,5	5,5	6,5	V
I _{CES}	V _{GE} = 0 } T _j = 25 °C V _{CE} = V _{CES} } T _j = 125 °C	-	0,1	1	mA
I _{GES}	V _{GE} = 20 V, V _{CE} = 0	-	-	200	nA
V _{CESat}	I _C = 25 A } V _{GE} = 15 V; I _C = 40 A } T _j = 25 (125) °C	-	2,1(2,4)	2,45(2,85)	V
V _{CESat}	I _C = 40 A } T _j = 25 (125) °C	-	2,6(3,1)	-	V
g _{fs}	V _{CE} = 20 V, I _C = 25 A	12	-	-	S
C _{CHC}	per IGBT	-	-	300	pF
C _{ies}	V _{GE} = 0	-	1900	2100	pF
C _{oes}	V _{CE} = 25 V	-	250	300	pF
C _{res}	f = 1 MHz	-	110	150	pF
L _{CE}		-	-	60	nH
t _{d(on)}	V _{CC} = 600 V	-	60	-	ns
t _r	V _{GE} = +15 V / -15 V ³⁾	-	49	-	ns
t _{d(off)}	I _C = 25 A, ind. load	-	380	-	ns
t _f	R _{Gon} = R _{Goff} = 40 Ω	-	37	-	ns
E _{on} ⁵⁾	T _j = 125 °C	-	3,7	-	mWs
E _{off} ⁵⁾		-	2,9	-	mWs
Inverse Diode ⁸⁾					
V _F = V _{EC}	I _F = 25 A } V _{GE} = 0 V; I _F = 40 A } T _j = 25 (125) °C	-	2,0(1,8)	2,5	V
V _F = V _{EC}	I _F = 40 A } T _j = 25 (125) °C	-	2,3(2,1)	-	V
V _{TO}	T _j = 125 °C	-	1,1	1,2	V
r _t	T _j = 125 °C	-	-	44	mΩ
I _{RRM}	I _F = 25 A; T _j = 125 °C ²⁾	-	22	-	A
Q _{rr}	I _F = 25 A; T _j = 125 °C ²⁾	-	3,7	-	μC
Thermal Characteristics					
R _{thjc}	per IGBT	-	-	0,56	°C/W
R _{thjc}	per diode	-	-	1,0	°C/W
R _{thch}	per module	-	-	0,05	°C/W

¹⁾ T_{case} = 25 °C, unless otherwise specified

²⁾ I_F = -I_C, V_R = 600 V, -di_F/dt = 500 A/μs, V_{GE} = 0 V

³⁾ Use V_{GEoff} = -5... -15 V

⁸⁾ CAL = Controlled Axial Lifetime Technology

Case and mech. data → B 6 – 80

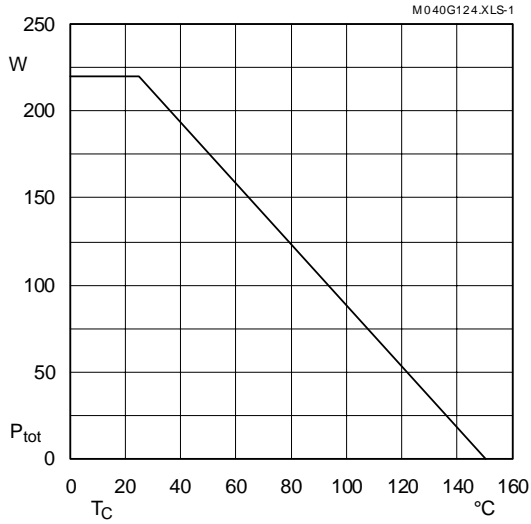

Fig. 1 Rated power dissipation $P_{tot} = f(T_C)$

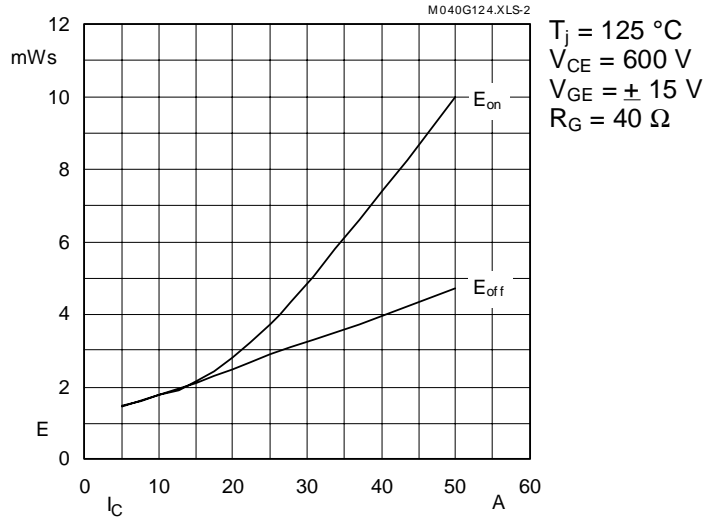

Fig. 2 Turn-on /-off energy $= f(I_C)$

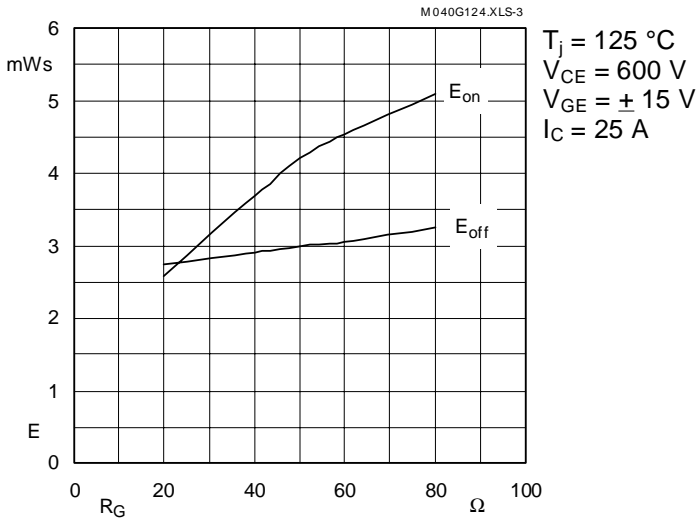

Fig. 3 Turn-on /-off energy $= f(R_G)$

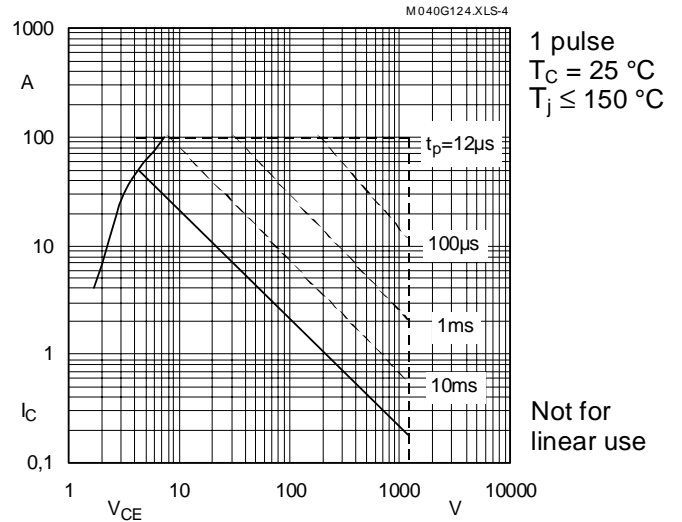

Fig. 4 Maximum safe operating area (SOA) $I_C = f(V_{CE})$

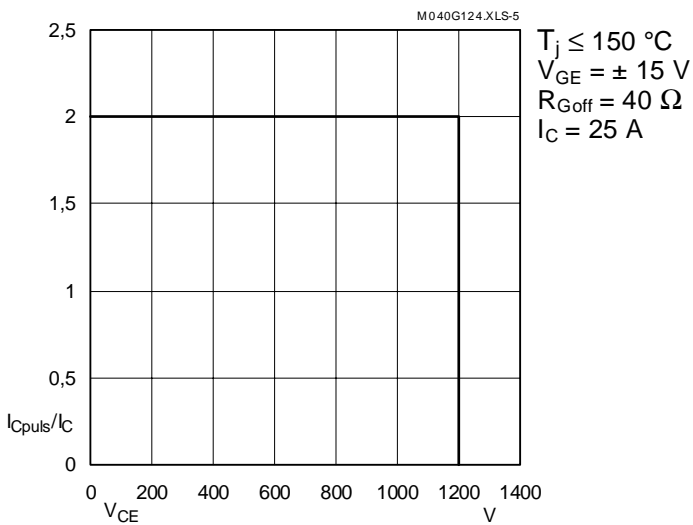

Fig. 5 Turn-off safe operating area (RBSOA)

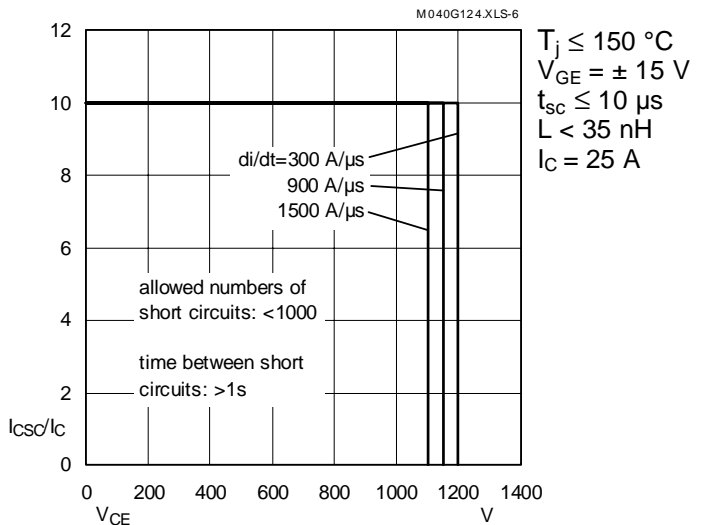

Fig. 6 Safe operating area at short circuit $I_C = f(V_{CE})$

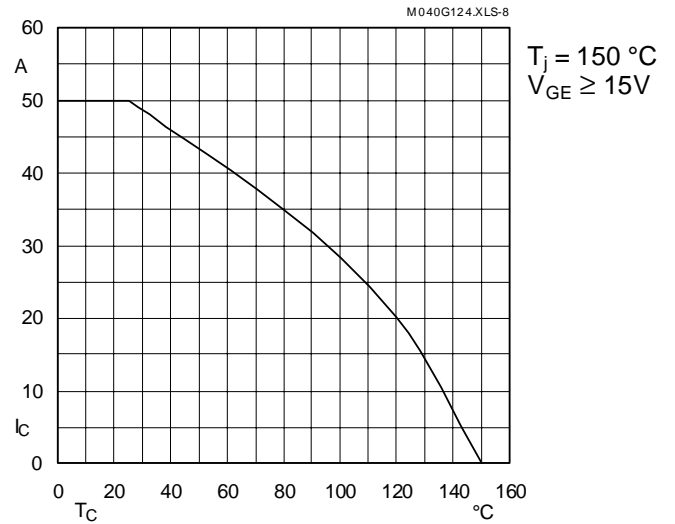

Fig. 8 Rated current vs. temperature $I_C = f(T_C)$

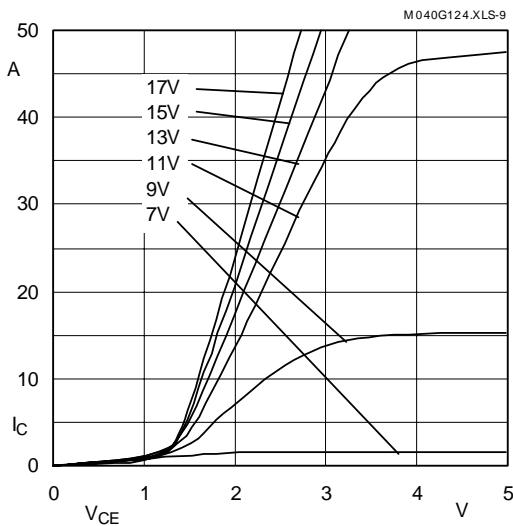

Fig. 9 Typ. output characteristic, $t_p = 80 \mu s$; $25 \text{ }^\circ\text{C}$

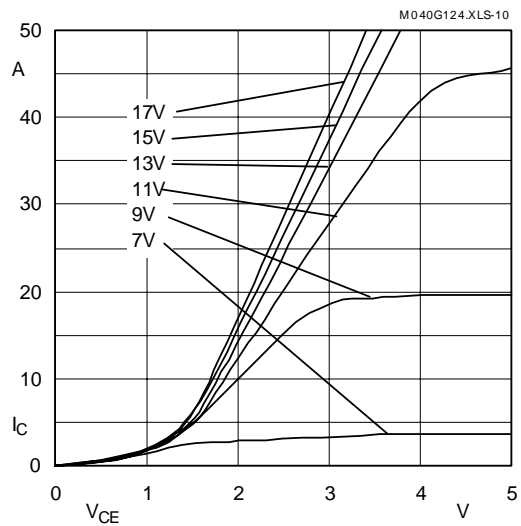

Fig. 10 Typ. output characteristic, $t_p = 80 \mu s$; $125 \text{ }^\circ\text{C}$

$$P_{\text{cond}(t)} = V_{\text{CEsat}(t)} \cdot I_{\text{C}(t)}$$

$$V_{\text{CEsat}(t)} = V_{\text{CE(TO)(Tj)}} + r_{\text{CE(Tj)}} \cdot I_{\text{C}(t)}$$

$$V_{\text{CE(TO)(Tj)}} \leq 1,3 + 0,0005 (T_j - 25) \text{ [V]}$$

$$\text{typ.: } r_{\text{CE(Tj)}} = 0,032 + 0,00010 (T_j - 25) \text{ [\Omega]}$$

$$\text{max.: } r_{\text{CE(Tj)}} = 0,046 + 0,00014 (T_j - 25) \text{ [\Omega]}$$

$$\text{valid for } V_{\text{GE}} = +15 \frac{+2}{-1} \text{ [V]; } I_{\text{C}} \geq 0,3 I_{\text{Cn}}$$

Fig. 11 Saturation characteristic (IGBT)
Calculation elements and equations

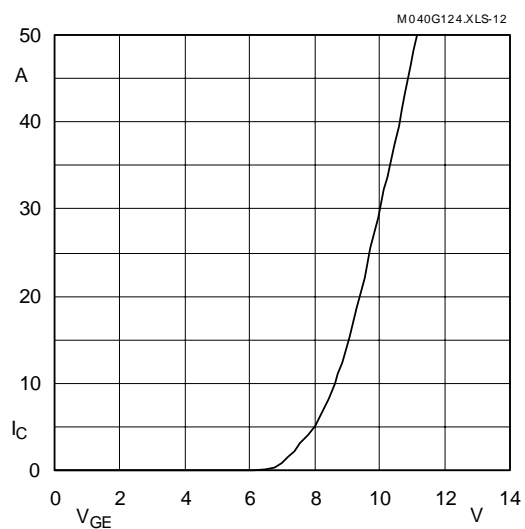

Fig. 12 Typ. transfer characteristic, $t_p = 80 \mu s$; $V_{\text{CE}} = 20 \text{ V}$

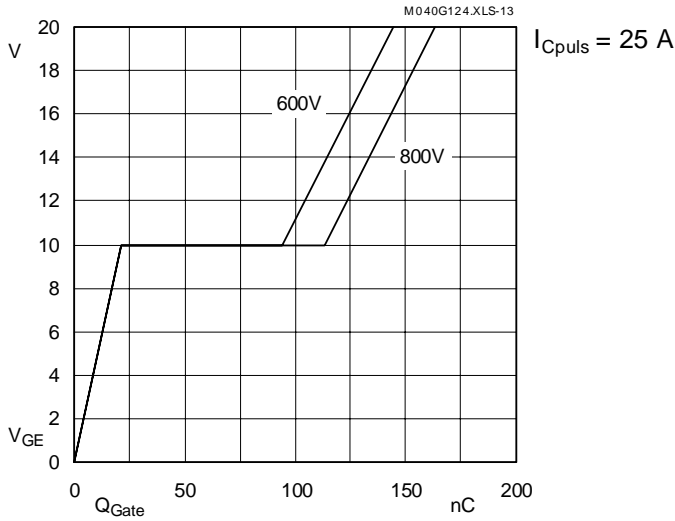

Fig. 13 Typ. gate charge characteristic

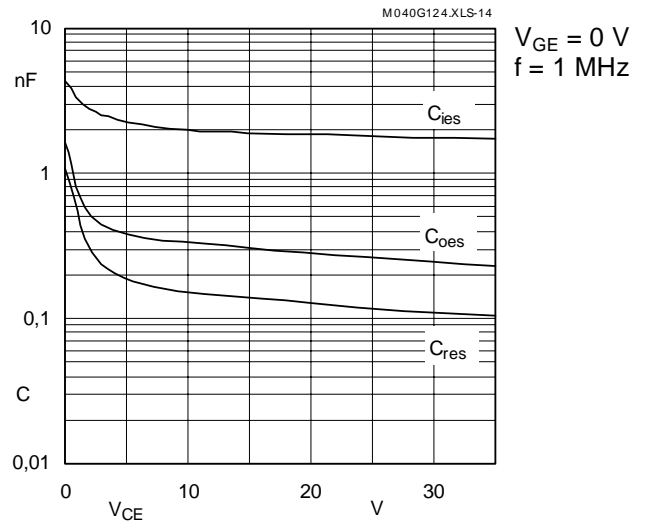

Fig. 14 Typ. capacitances vs. V_{CE}

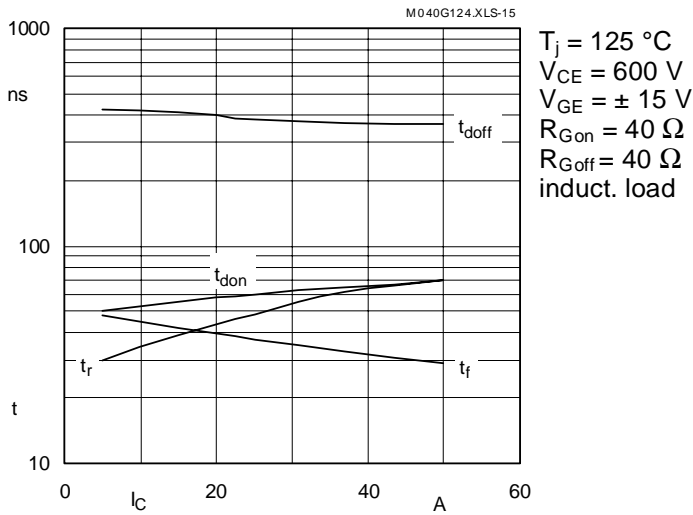

Fig. 15 Typ. switching times vs. I_C

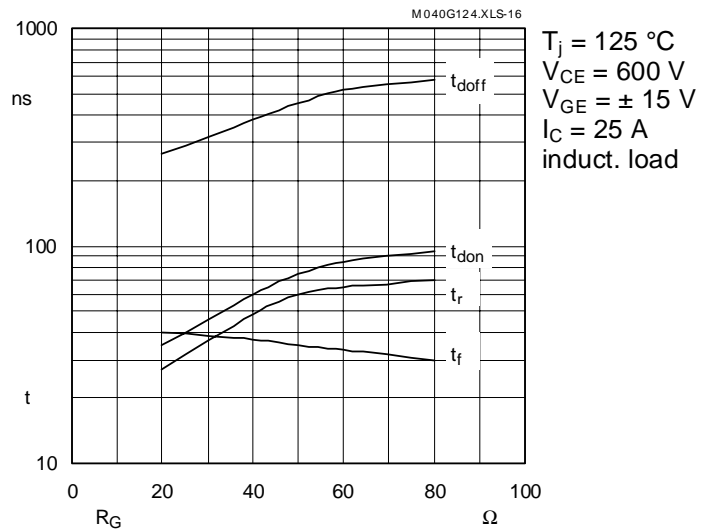

Fig. 16 Typ. switching times vs. gate resistor R_G

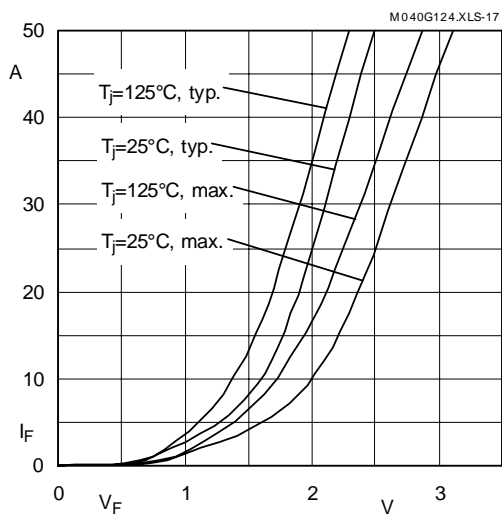

Fig. 17 Typ. CAL diode forward characteristic

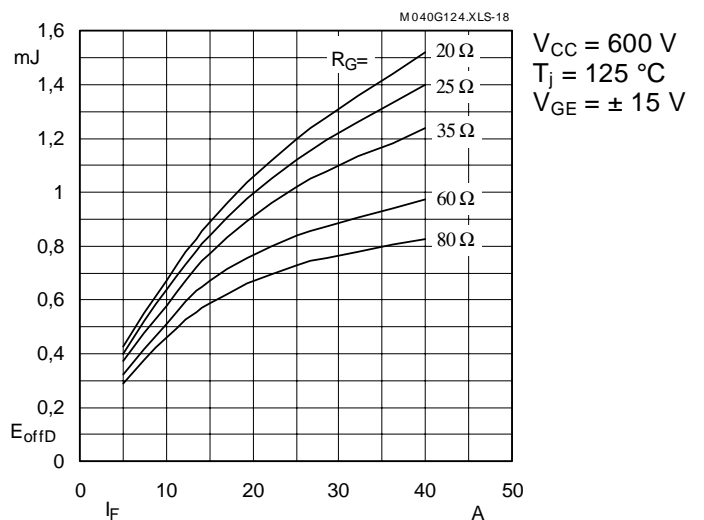

Fig. 18 Diode turn-off energy dissipation per pulse

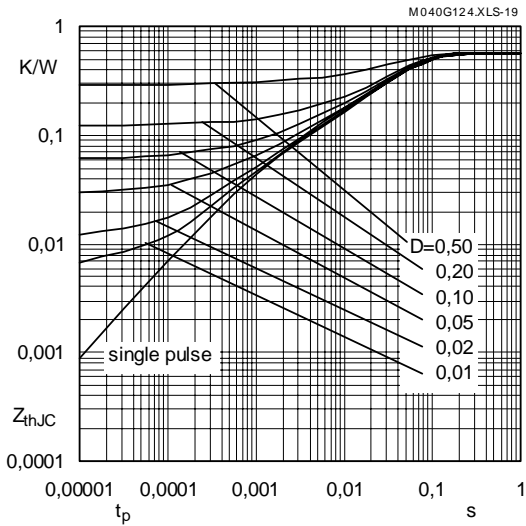

Fig. 19 Transient thermal impedance of IGBT
 $Z_{thJC} = f(t_p)$; $D = t_p / t_c = t_p \cdot f$

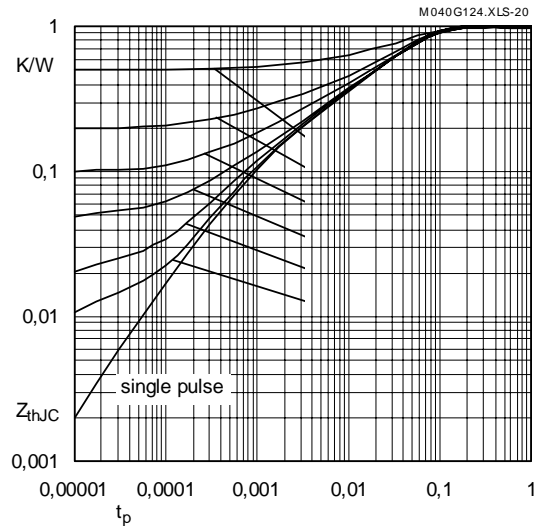

Fig. 20 Transient thermal impedance of inverse CAL diodes
 $Z_{thJC} = f(t_p)$; $D = t_p / t_c = t_p \cdot f$

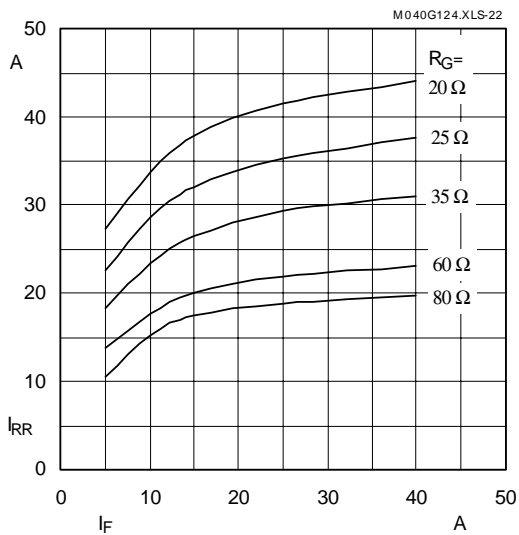

Fig. 22 Typ. CAL diode peak reverse recovery current $I_{RR} = f(I_F; R_G)$

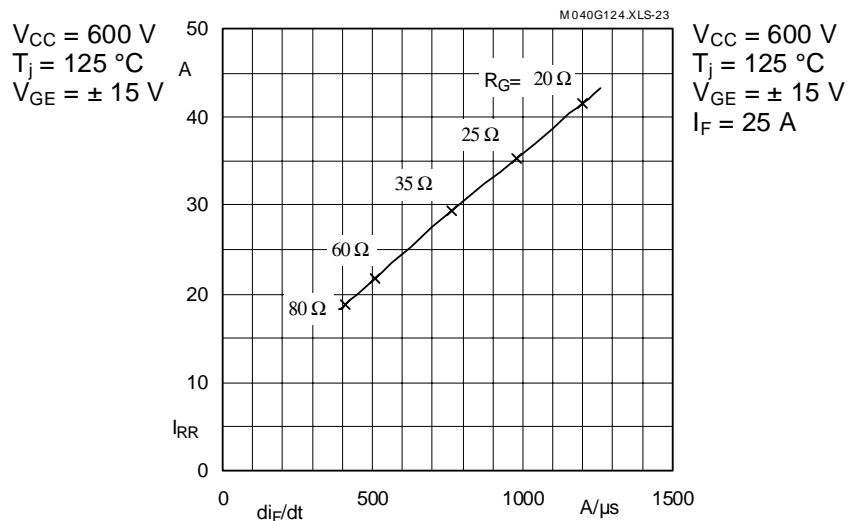

Fig. 23 Typ. CAL diode peak reverse recovery current $I_{RR} = f(di_F/dt)$

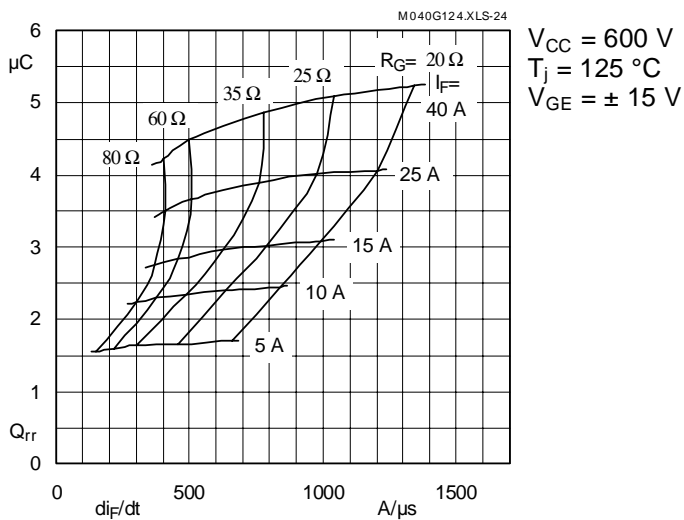
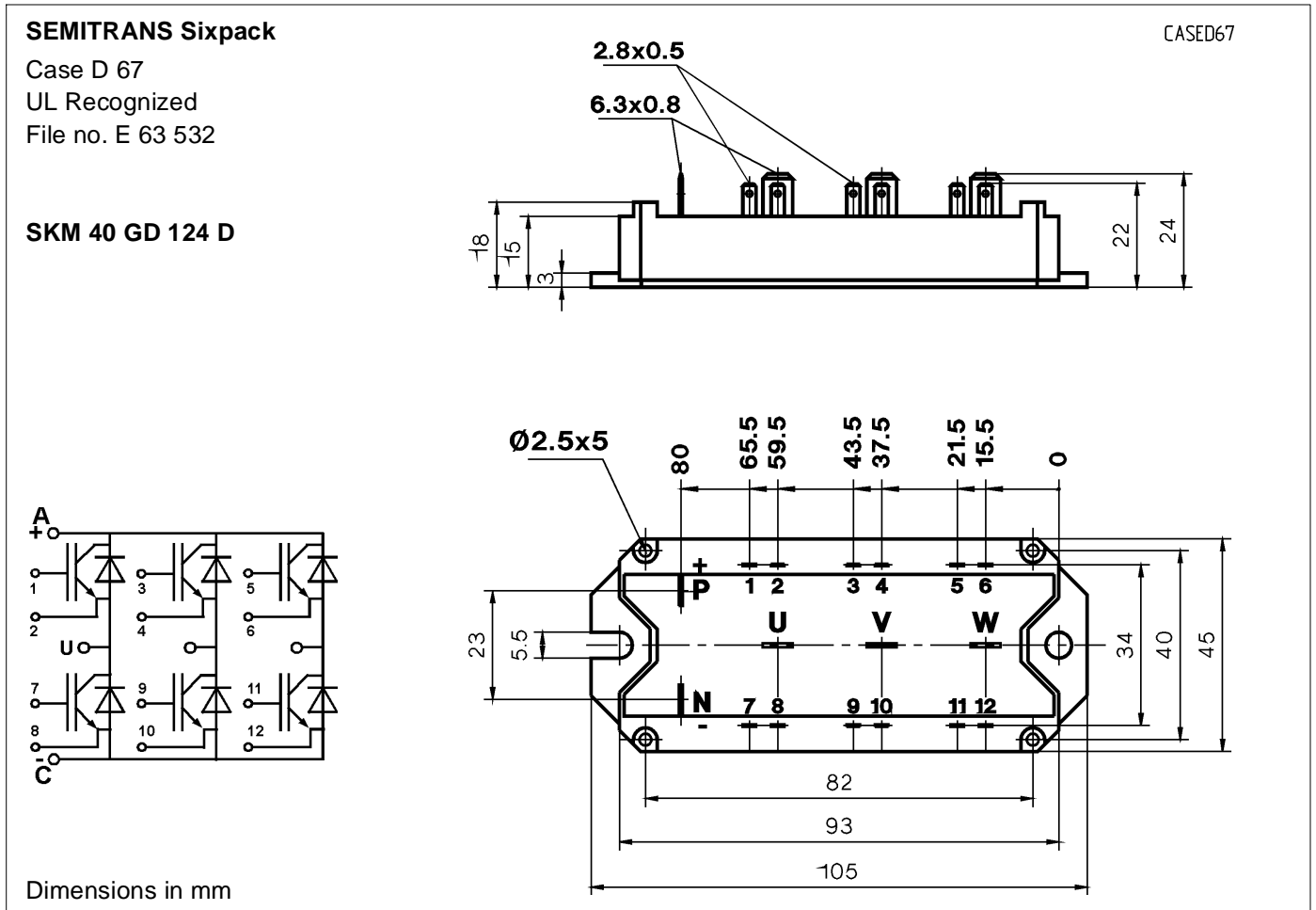

Fig. 24 Typ. CAL diode recovered charge

SKM 40 GD 124 D



Case outline and circuit diagram

Mechanical Data			Values			Units
Symbol	Conditions		min.	typ.	max.	
M ₁	to heatsink, SI Units	(M5)	4	–	5	Nm
	to heatsink, US Units		35	–	44	lb.in.
a			–	–	5x9,81	m/s ²
w			–	–	175	g

This is an electrostatic discharge sensitive device (ESDS). Please observe the international standard IEC 747-1, Chapter IX.

Two devices are supplied in one SEMIBOX A.

Larger packing units (10 and 20 pieces) are used if suitable SEMIBOX → C – 1.