

## FEATURES

- ESD Protection over  $\pm 10\text{kV}$
- Low Power:  $I_{CC} = 1.8\text{mA Typ}$
- 28ns Typical Driver Propagation Delays with 4ns Skew
- Designed for RS485 or RS422 Applications
- Single 5V Supply
- $-7\text{V}$  to  $12\text{V}$  Bus Common-Mode Range Permits  $\pm 7\text{V}$  Ground Difference Between Devices on the Bus
- Thermal Shutdown Protection
- Power-Up/Down Glitch-Free Driver Outputs
- Driver Maintains High Impedance in Three-State or with the Power Off
- Combined Impedance of a Driver Output and Receiver Allows up to 32 Transceivers on the Bus
- 60mV Typical Input Hysteresis
- Pin Compatible with the SN75176A, DS75176A, and SN75LBC176

## APPLICATIONS

- Low Power RS485/RS422 Transceiver
- Level Translator

## DESCRIPTION

The LTC<sup>®</sup>1485 is a low power differential bus/line transceiver designed for multipoint data transmission standard RS485 applications with extended common-mode range ( $12\text{V}$  to  $-7\text{V}$ ). It also meets the requirements of RS422.

The CMOS with Schottky design offers significant power savings over its bipolar counterpart without sacrificing ruggedness against overload or ESD damage.

The driver and receiver feature three-state outputs, with the driver outputs maintaining high impedance over the entire common-mode range. Excessive power dissipation caused by bus contention or faults is prevented by a thermal shutdown circuit which forces the driver outputs into a high impedance state. I/O pins are protected against multiple ESD strikes of over  $\pm 10\text{kV}$ .

The receiver has a fail-safe feature which guarantees a high output state when the inputs are left open.

Both AC and DC specifications are guaranteed from  $-40^{\circ}\text{C}$  to  $85^{\circ}\text{C}$  and  $4.75\text{V}$  to  $5.25\text{V}$  supply voltage range.

 LTC and LT are registered trademarks of Linear Technology Corporation.

## TYPICAL APPLICATION

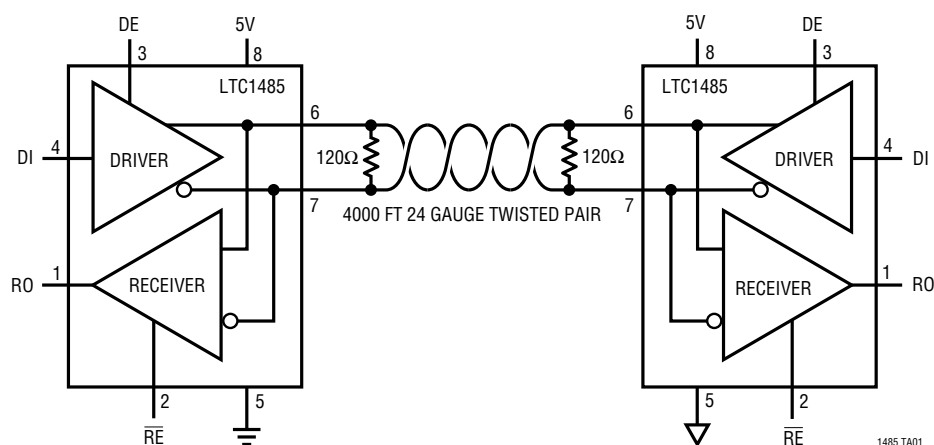

1485 TA01

**ABSOLUTE MAXIMUM RATINGS**

(Note 1)

Supply Voltage ( $V_{CC}$ )	12V
Control Input Voltages	-0.5V to $V_{CC} + 0.5V$
Control Input Currents	-50mA to 50mA
Driver Input Voltages	-0.5V to $V_{CC} + 0.5V$
Driver Input Currents	-25mA to 25mA
Driver Output Voltages	$\pm 14V$
Receiver Input Voltages	$\pm 14V$
Receiver Output Voltages	-0.5V to $V_{CC} + 0.5V$
Operating Temperature Range	
LTC1485C	0°C to 70°C
LTC1485I	-40°C to 85°C
Storage Temperature Range	-65°C to 150°C
Lead Temperature (Soldering, 10 sec.)	300°C

**PACKAGE/ORDER INFORMATION**

TOP VIEW

N8 PACKAGE      S8 PACKAGE  
8-LEAD PLASTIC DIP    8-LEAD PLASTIC SOIC

T<sub>JMAX</sub> = 125°C,  $\theta_{JA}$  = 100°C/W (N)  
T<sub>JMAX</sub> = 150°C,  $\theta_{JA}$  = 150°C/W (S)

ORDER PART NUMBER

LTC1485CN8  
LTC1485IN8  
LTC1485CS8  
LTC1485IS8

---

S8 PART MARKING

1485  
1485I

Consult factory for Military grade parts.

**DC ELECTRICAL CHARACTERISTICS**

$V_{CC} = 5V$  (Notes 2, 3), unless otherwise noted.

SYMBOL	PARAMETER	CONDITIONS	MIN	TYP	MAX	UNITS
$V_{OD1}$	Differential Driver Output Voltage (Unloaded)	$I_O = 0$	●	5	V	
$V_{OD2}$	Differential Driver Output Voltage (With Load)	R = 50 $\Omega$ , (RS422) R = 27 $\Omega$ , (RS485) (Figure 1)	●	2 1.5	5	V
$\Delta V_{OD}$	Change in Magnitude of Driver Differential Output Voltage for Complementary Output States	R = 27 $\Omega$ or R = 50 $\Omega$ (Figure 1)	●		0.2	V
$V_{OC}$	Driver Common-Mode Output Voltage	R = 27 $\Omega$ or R = 50 $\Omega$ (Figure 1)	●		3	V
$\Delta V_{OC}$	Change in Magnitude of Driver Common-Mode Output Voltage for Complementary Output States	R = 27 $\Omega$ or R = 50 $\Omega$ (Figure 1)	●		0.2	V
$V_{INH}$	Input High Voltage	DI, DE, $\overline{RE}$	●	2.0		V
$V_{INL}$	Input Low Voltage	DI, DE, $\overline{RE}$	●		0.8	V
$I_{IN1}$	Input Current	DI, DE, $\overline{RE}$	●		$\pm 2$	$\mu A$
$I_{IN2}$	Input Current (A, B)	$V_{CC} = 0V$ or 5.25V, $V_{IN} = 12V$ $V_{CC} = 0V$ or 5.25V, $V_{IN} = -7V$	●		1.0 -0.8	mA
$V_{TH}$	Differential Input Threshold Voltage for Receiver	$-7V \leq V_{CM} \leq 12V$	●	-0.2	0.2	V
$\Delta V_{TH}$	Receiver Input Hysteresis	$V_{CM} = 0V$	●	60		mV
$V_{OH}$	Receiver Output High Voltage	$I_O = -4mA$ , $V_{ID} = 0.2V$	●	3.5		V
$V_{OL}$	Receiver Output Low Voltage	$I_O = 4mA$ , $V_{ID} = -0.2V$	●		0.4	V
$I_{OZR}$	Three-State Output Current at Receiver	$V_{CC} = \text{Max } 0.4V \leq V_O \leq 2.4V$	●		$\pm 1$	$\mu A$
$I_{CC}$	Supply Current	No Load; DI = GND or $V_{CC}$ Outputs Enabled Outputs Disabled	●	1.8 1.7	2.3 2.3	mA
$R_{IN}$	Receiver Input Resistance	$-7V \leq V_{CM} \leq 12V$	●	12		k $\Omega$
$I_{OSD1}$	Driver Short-Circuit Current, $V_{OUT} = \text{High}$	$V_O = -7V$	●		250	mA
$I_{OSD2}$	Driver Short-Circuit Current, $V_{OUT} = \text{Low}$	$V_O = 10V$	●		250	mA
$I_{OSR}$	Receiver Short-Circuit Current	$0V \leq V_O \leq V_{CC}$	●	7	85	mA

# SWITCHING CHARACTERISTICS

V<sub>CC</sub> = 5V (Notes 2, 3), unless otherwise noted.

SYMBOL	PARAMETER	CONDITIONS	MIN	TYP	MAX	UNITS	
t <sub>PLH</sub>	Driver Input to Output	R <sub>DIFF</sub> = 54Ω, C <sub>L1</sub> = C <sub>L2</sub> = 100pF (Figures 2, 5)	●	10	30	50	ns
t <sub>PHL</sub>	Driver Input to Output	R <sub>DIFF</sub> = 54Ω, C <sub>L1</sub> = C <sub>L2</sub> = 100pF (Figures 2, 5)	●	10	30	50	ns
t <sub>SKEW</sub>	Driver Output to Output	R <sub>DIFF</sub> = 54Ω, C <sub>L1</sub> = C <sub>L2</sub> = 100pF (Figures 2, 5)	●		4	10	ns
t <sub>r</sub> , t <sub>f</sub>	Driver Rise or Fall Time	R <sub>DIFF</sub> = 54Ω, C <sub>L1</sub> = C <sub>L2</sub> = 100pF (Figures 2, 5)	●	5	15	25	ns
t <sub>ZH</sub>	Driver Enable to Output High	C <sub>L</sub> = 100pF (Figures 4, 6) S2 Closed	●		40	70	ns
t <sub>ZL</sub>	Driver Enable to Output Low	C <sub>L</sub> = 100pF (Figures 4, 6) S1 Closed	●		40	70	ns
t <sub>LZ</sub>	Driver Disable Time from Low	C <sub>L</sub> = 15pF (Figures 4, 6) S1 Closed	●		40	70	ns
t <sub>HZ</sub>	Driver Disable Time from High	C <sub>L</sub> = 15pF (Figures 4, 6) S2 Closed	●		40	70	ns
t <sub>PLH</sub>	Receiver Input to Output	R <sub>DIFF</sub> = 54Ω, C <sub>L1</sub> = C <sub>L2</sub> = 100pF (Figures 2, 7)	●	15	25	50	ns
t <sub>PHL</sub>	Receiver Input to Output	R <sub>DIFF</sub> = 54Ω, C <sub>L1</sub> = C <sub>L2</sub> = 100pF (Figures 2, 7)	●	20	30	55	ns
t <sub>SKEW</sub>	t <sub>PLH</sub> - t <sub>PHL</sub>   Differential Receiver Skew	R <sub>DIFF</sub> = 54Ω, C <sub>L1</sub> = C <sub>L2</sub> = 100pF (Figures 2, 7)	●		5	15	ns
t <sub>ZL</sub>	Receiver Enable to Output Low	C <sub>L</sub> = 15pF (Figures 3, 8) S1 Closed	●		30	45	ns
t <sub>ZH</sub>	Receiver Enable to Output High	C <sub>L</sub> = 15pF (Figures 3, 8) S2 Closed	●		30	45	ns
t <sub>LZ</sub>	Receiver Disable from Low	C <sub>L</sub> = 15pF (Figures 3, 8) S1 Closed	●		30	45	ns
t <sub>HZ</sub>	Receiver Disable from High	C <sub>L</sub> = 15pF (Figures 3, 8) S2 Closed	●		30	45	ns

The ● denotes specifications which apply over the operating temperature range.

**Note 1:** Absolute Maximum Ratings are those values beyond which the safety of the device cannot be guaranteed.

**Note 2:** All currents into device pins are positive. All currents out of device pins are negative. All voltages are referenced to device ground unless otherwise specified.

**Note 3:** All typicals are given for V<sub>CC</sub> = 5V and T<sub>A</sub> = 25°C.

# TYPICAL PERFORMANCE CHARACTERISTICS

Receiver Output Low Voltage vs Output Current

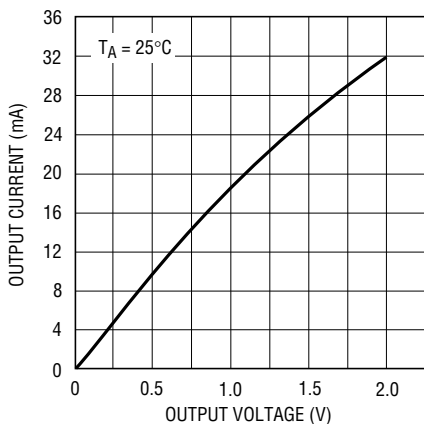

1485 G01

Receiver Output High Voltage vs Output Current

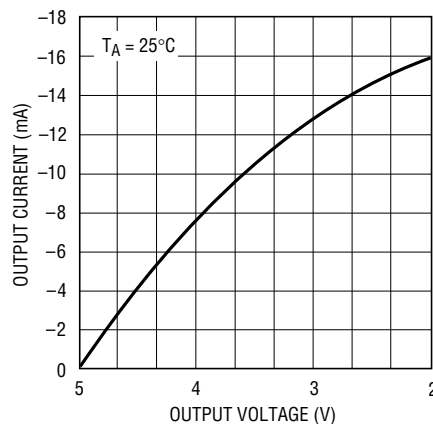

1485 G02

Receiver Output High Voltage vs Temperature

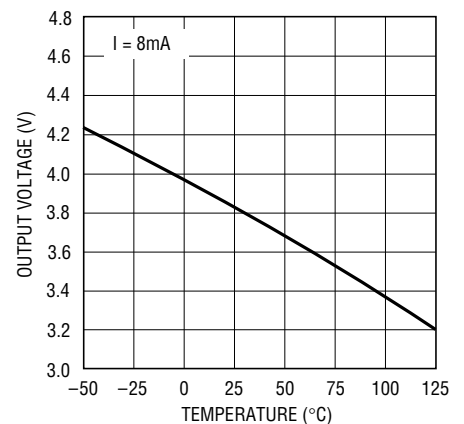

1485 G03

# TYPICAL PERFORMANCE CHARACTERISTICS

**Receiver Output Low Voltage vs Temperature**

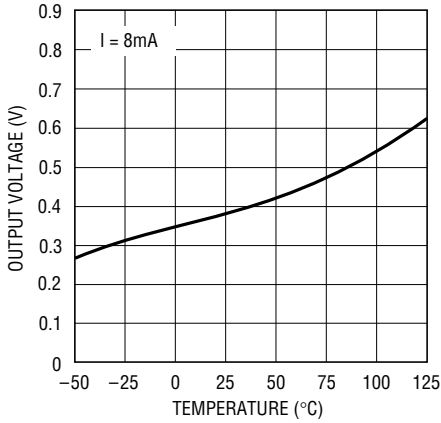

1485 G04

**Driver Differential Output Voltage vs Output Current**

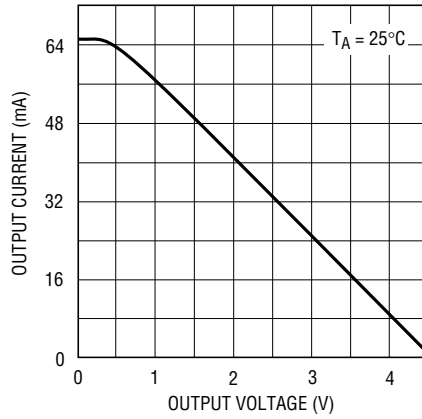

1485 G05

**Driver Differential Output Voltage vs Temperature**

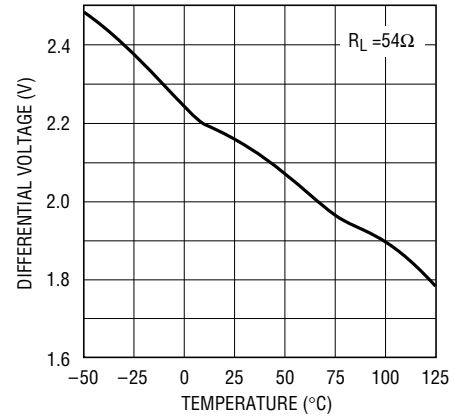

1485 G06

**Driver Output Low Voltage vs Output Current**

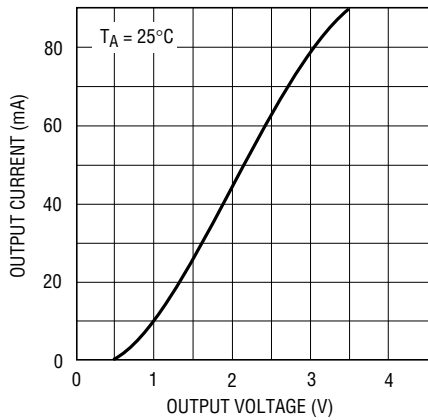

1485 G07

**Driver Output High Voltage vs Output Current**

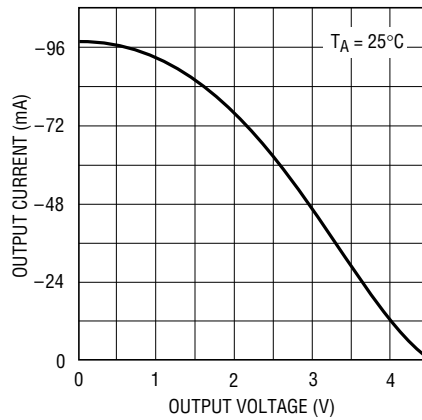

1485 G08

**TTL Input Threshold vs Temperature**

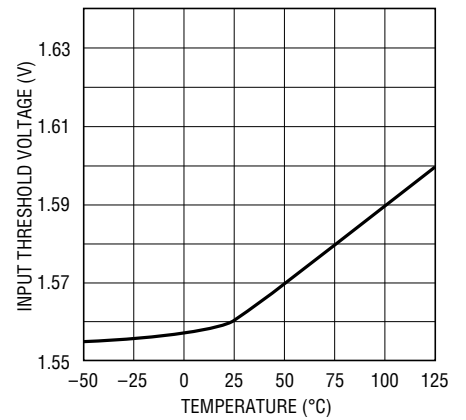

1485 G09

**Receiver |t<sub>PLH</sub> - t<sub>PHL</sub>| vs Temperature**

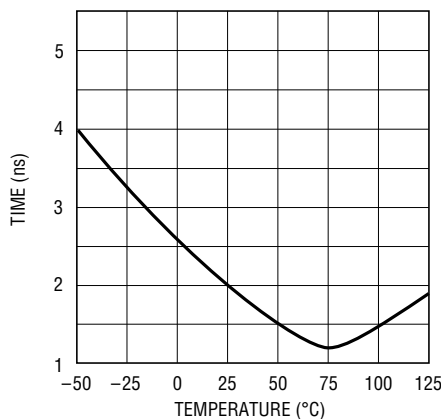

1485 G10

**Driver Skew vs Temperature**

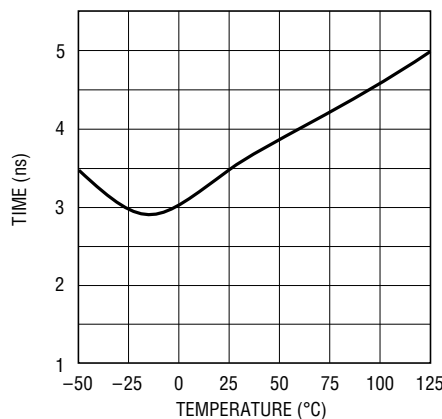

1485 G11

**Supply Current vs Temperature**

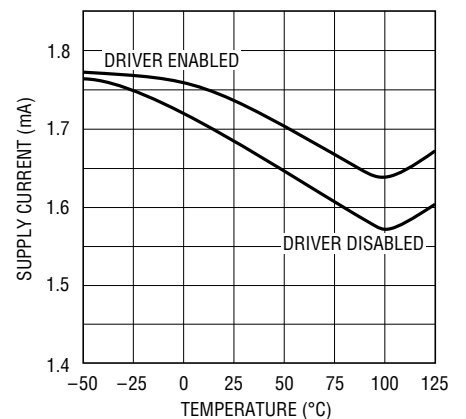

1485 G12

## PIN FUNCTIONS

**RO (Pin 1):** Receiver Output. If the receiver output is enabled ( $\overline{RE}$  low), then if  $A > B$  by 200mV, RO will be high. If  $A < B$  by 200mV, then RO will be low.

**$\overline{RE}$  (Pin 2):** Receiver Output Enable. A low enables the receiver output, RO. A high input forces the receiver output into a high impedance state.

**DE (Pin 3):** Driver Output Enable. A high on DE enables the driver outputs, A and B. A low input will force the driver outputs into a high impedance state.

**DI (Pin 4):** Driver Input. If the driver outputs are enabled (DE high), then a low on DI forces the driver outputs A low and B high. A high on DI will force A high and B low.

**GND (Pin 5):** Ground Connection.

**A (Pin 6):** Driver Output/Receiver Input.

**B (Pin 7):** Driver Output/Receiver Input.

**$V_{CC}$  (Pin 8):** Positive Supply.  $4.75V \leq V_{CC} \leq 5.25V$ .

## TEST CIRCUITS

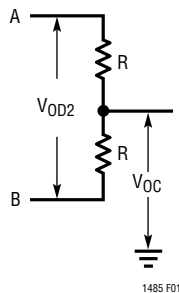

Figure 1. Driver DC Test Load

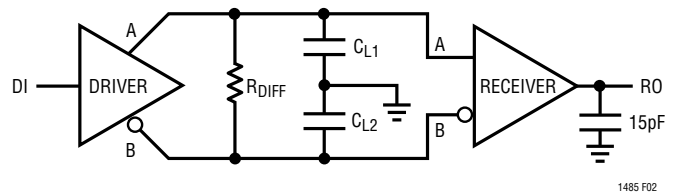

Figure 2. Driver/Receiver Timing Test Circuit

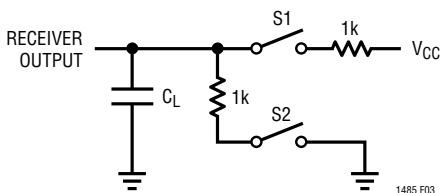

Figure 3. Receiver Timing Test Load

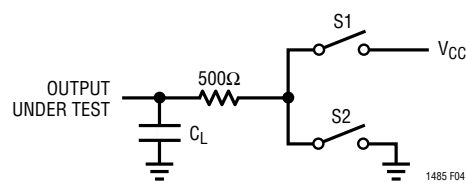

Figure 4. Driver Timing Test Load

# SWITCHING TIME WAVEFORMS

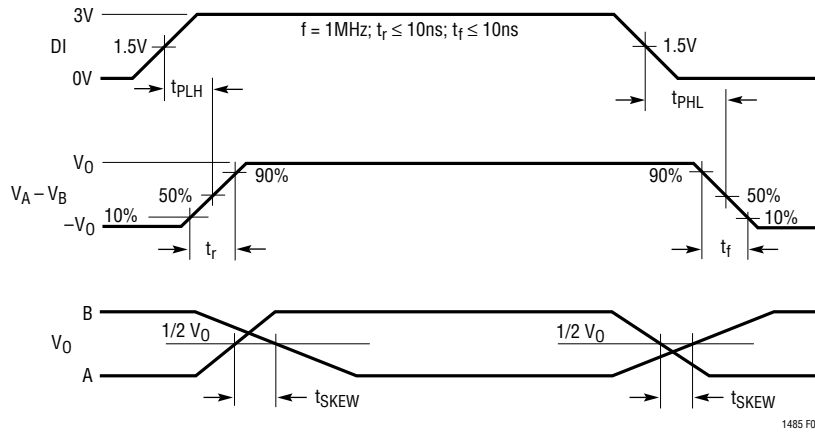

Figure 5. Driver Propagation Delays

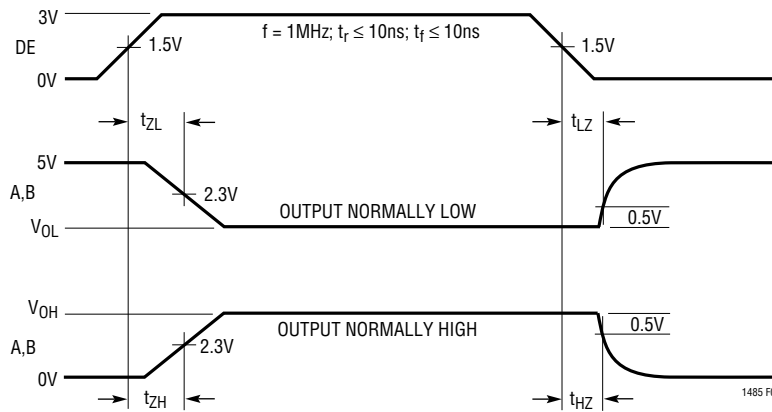

Figure 6. Driver Enable and Disable Times

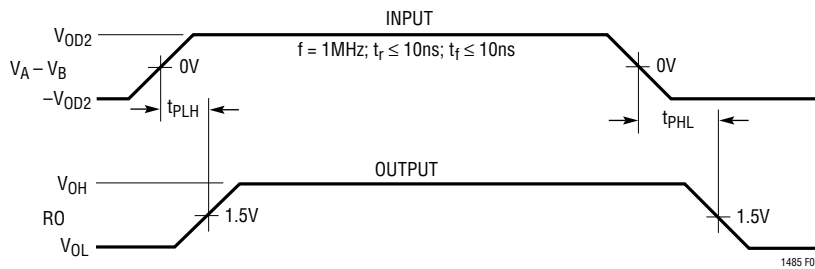

Figure 7. Receiver Propagation Delays

## SWITCHING TIME WAVEFORMS

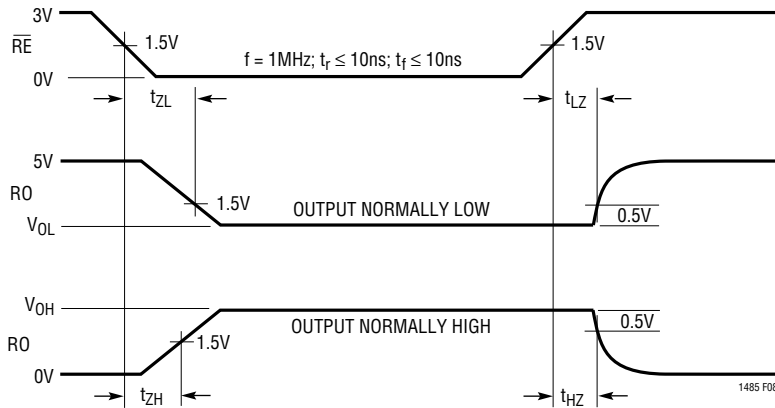

Figure 8. Receiver Enable and Disable Times

## APPLICATIONS INFORMATION

### Typical Application

A typical connection of the LTC1485 is shown in Figure 9. Two twisted pair wires connect up to 32 driver/receiver pairs for half duplex data transmission. There are no restrictions on where the chips are connected to the wires and it isn't necessary to have the chips connected at the ends. However, the wires must be terminated only at the

ends with a resistor equal to their characteristic impedance, typically 120Ω. The input impedance of a receiver is typically 20k to GND, or 0.6 unit RS485 load, so in practice 50 to 60 transceivers can be connected to the same wires. The optional shields around the twisted pair help reduce unwanted noise, and are connected to GND at one end.

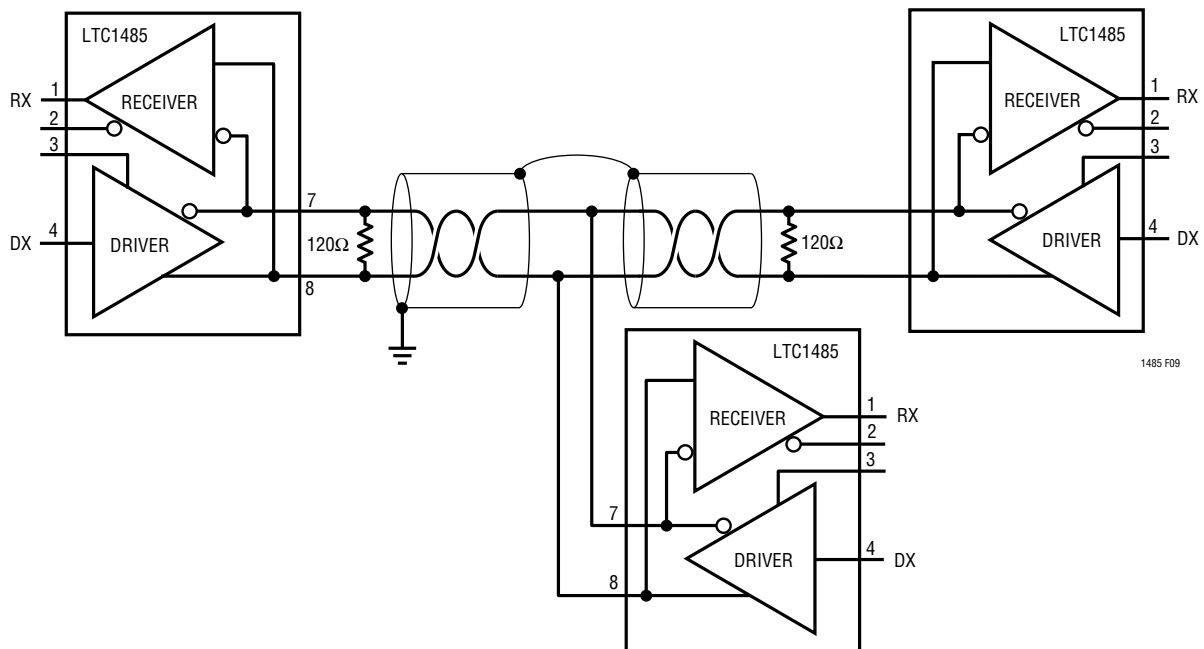

Figure 9. Typical Connection

## APPLICATIONS INFORMATION

### Thermal Shutdown

The LTC1485 has a thermal shutdown feature which protects the part from excessive power dissipation. If the outputs of the driver are accidentally shorted to a power supply or low impedance source, up to 250mA can flow through the part. The thermal shutdown circuit disables the driver outputs when the internal temperature reaches 150°C and turns them back on when the temperature cools to 130°C. If the outputs of two or more LTC1485 drivers are shorted directly, the driver outputs can not supply enough current to activate the thermal shutdown. Thus, the thermal shutdown circuit will not prevent contention faults when two drivers are active on the bus at the same time.

### Cables and Data Rate

The transmission line of choice for RS485 applications is a twisted pair. There are coaxial cables (twinaxial) made for this purpose that contain straight pairs, but these are less flexible, more bulky, and more costly than twisted pairs. Many cable manufacturers offer a broad range of 120Ω cables designed for RS485 applications.

Losses in a transmission line are a complex combination of DC conductor loss, AC losses (skin effect), leakage, and AC losses in the dielectric. In good polyethylene cables such as the Belden 9841, the conductor losses and dielectric losses are of the same order of magnitude, leading to relatively low overall loss (Figure 10).

When using low loss cables, Figure 11 can be used as a guideline for choosing the maximum line length for a given data rate. With lower quality PVC cables the dielectric loss factor can be 1000 times worse. PVC twisted pairs have terrible losses at high data rates (>100kbs), and greatly reduce the maximum cable length. At low data rates however, they are acceptable and much more economical.

### Cable Termination

The proper termination of the cable is very important. If the cable is not terminated with its characteristic impedance, distorted waveforms will result. In severe cases, distorted (false) data and nulls will occur. A quick look at the output of the driver will tell how well the cable is terminated. It is best to look at a driver connected to the

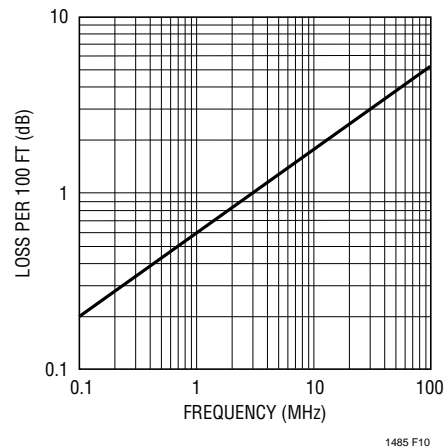

Figure 10. Attenuation vs Frequency for Belden 9481

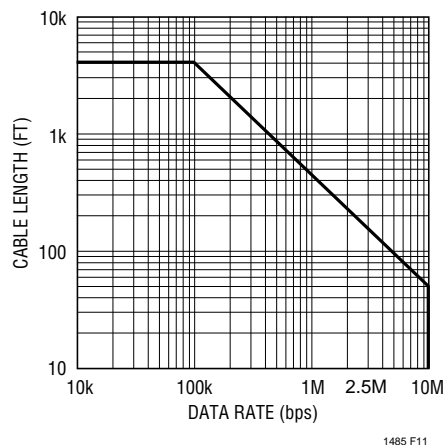

Figure 11. Cable Length vs Data Rate

end of the cable, since this eliminates the possibility of getting reflections from two directions. Simply look at the driver output while transmitting square wave data. If the cable is terminated properly, the waveform will look like a square wave (Figure 2).

If the cable is loaded excessively (47Ω) the signal initially sees the surge impedance of the cable and jumps to an initial amplitude. The signal travels down the cable and is reflected back out of phase because of the mistermination. When the reflected signal returns to the driver, the amplitude will be lowered. The width of the pedestal is equal to twice the electrical length of the cable (about 1.5ns/foot). If the cable is lightly loaded (470Ω) the signal reflects in phase and increases the amplitude at the driver output. An input frequency of 30kHz is adequate for tests out to 4000 feet of cable.



## APPLICATIONS INFORMATION

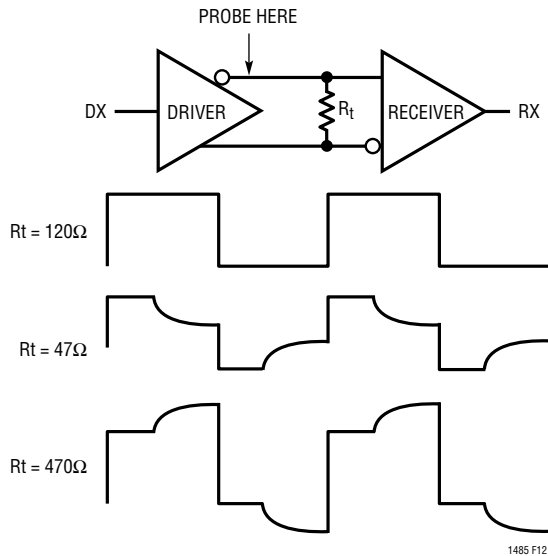

Figure 12. Termination Effects

### AC Cable Termination

Cable termination resistors are necessary to prevent unwanted reflections, but they consume power. The typical differential output voltage of the driver is 2V when the cable is terminated with two 120Ω resistors, causing 33mA of DC current to flow in the cable when no data is being sent. This DC current is about 10 times greater than the supply current of the LTC1485. One way to eliminate the unwanted current is by AC-coupling the termination resistors as shown in Figure 13.

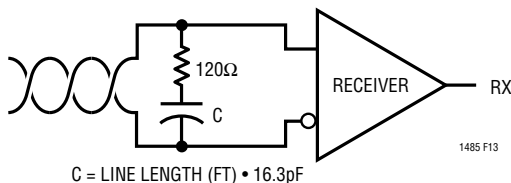

Figure 13. AC-Coupled Termination

The coupling capacitor must allow high frequency energy to flow to the termination, but block DC and low frequencies. The dividing line between high and low frequency depends on the length of the cable. The coupling capacitor must pass frequencies above the point where the line represents an electrical one-tenth wavelength. The value

of the coupling capacitor should therefore be set at 16.3pF per foot of cable length for 120Ω cables. With the coupling capacitors in place, power is consumed only on the signal edges and not when the driver output is idling at a 1 or 0 state. A 100nF capacitor is adequate for lines up to 400 feet in length. Be aware that the power savings start to decrease once the data rate surpasses  $1/(120\Omega \cdot C)$ .

### Receiver Open-Circuit Fail-Safe

Some data encoding schemes require that the output of the receiver maintains a known state (usually a logic 1) when the data is finished transmitting and all drivers on the line are forced into three-state. The receiver of the LTC1485 has a fail-safe feature which guarantees the output to be in a logic 1 state when the receiver inputs are left floating (open-circuit).

If the receiver output must be forced to a known state, the circuits of Figure 14 can be used.

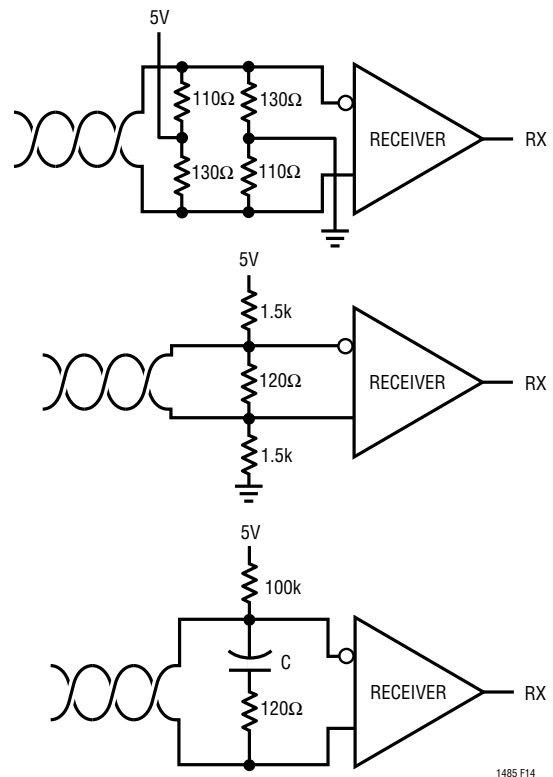

Figure 14. Forcing "0" When All Drivers Are Off

## APPLICATIONS INFORMATION

The termination resistors are used to generate a DC bias which forces the receiver output to a known state, in this case a logic 0. The first method consumes about 208mW and the second about 8mW. The lowest power solution is to use an AC termination with a pull-up resistor. Simply swap the receiver inputs for data protocols ending in logic 1.

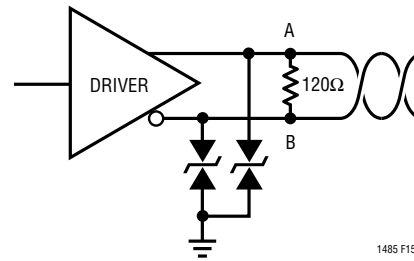

Figure 15. ESD Protection with TransZorbs

### Fault Protection

All of LTC’s RS485 products are protected against ESD transients up to 2kV using the human body model (100pF, 1.5kΩ). However, some applications need more protection. The best protection method is to connect a bidirectional TransZorb® from each line side pin to ground (Figure 15).

A TransZorb is a silicon transient voltage suppressor that has exceptional surge handling capabilities: fast response

time and low series resistance. They are available from General Semiconductor Industries and come in a variety of breakdown voltages and prices. Be sure to pick a breakdown voltage higher than the common-mode voltage required for your application (typically 12V). Also, don’t forget to check how much the added parasitic capacitance will load down the bus.

TransZorb is a registered trademark of General Instruments, GSI

## TYPICAL APPLICATIONS

### RS232 Receiver

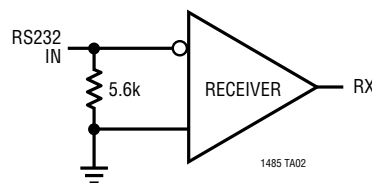

### RS232 to RS485 Level Translator with Hysteresis

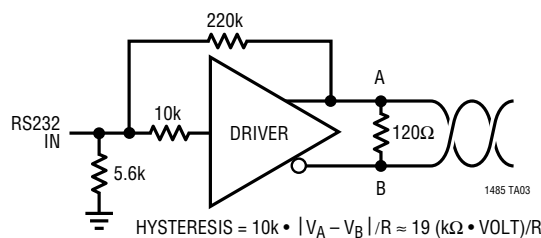

**PACKAGE DESCRIPTION** Dimensions in inches (millimeters) unless otherwise noted.

**N8 Package  
8-Lead Plastic DIP**

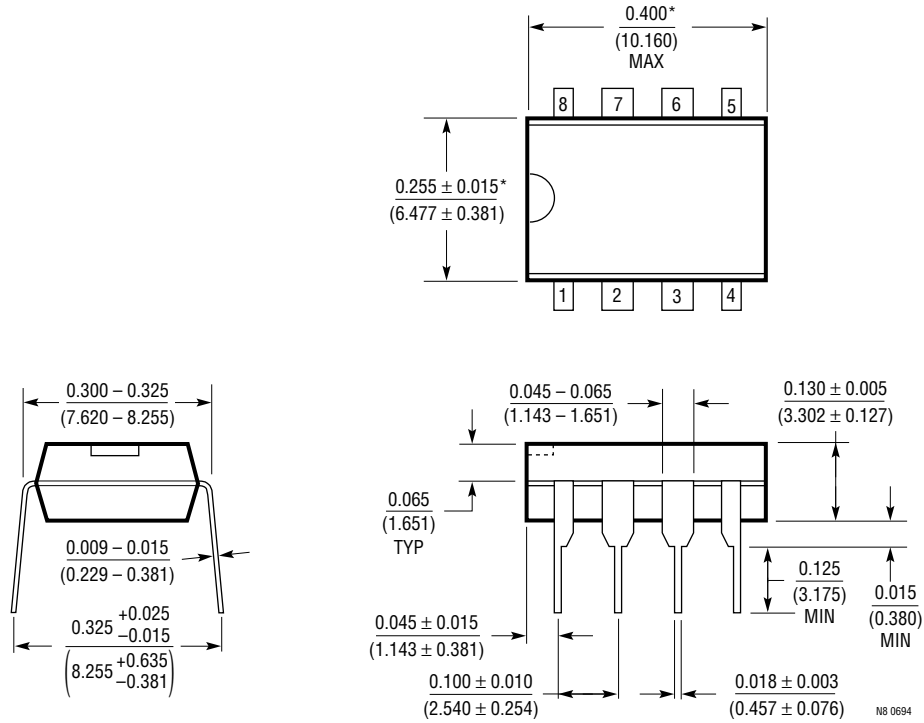

\*THESE DIMENSIONS DO NOT INCLUDE MOLD FLASH OR PROTRUSIONS.  
MOLD FLASH OR PROTRUSIONS SHALL NOT EXCEED 0.010 INCH (0.254mm).

NS 0694

**PACKAGE DESCRIPTION** Dimensions in inches (millimeters) unless otherwise noted.

**S8 Package  
8-Lead Plastic SOIC**

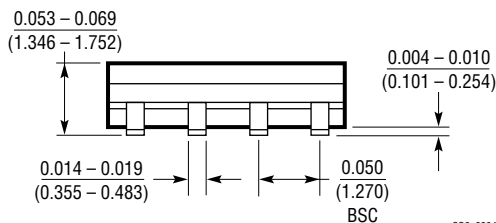
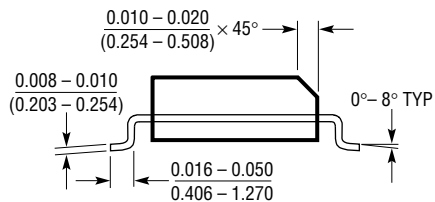
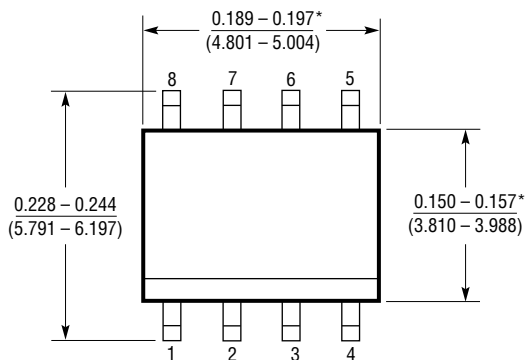

\*THESE DIMENSIONS DO NOT INCLUDE MOLD FLASH OR PROTRUSIONS.  
MOLD FLASH OR PROTRUSIONS SHALL NOT EXCEED 0.006 INCH (0.15mm).

S08 0294

**RELATED PARTS**

PART NUMBER	DESCRIPTION	COMMENTS
LTC486	Quad RS485 Driver	Fits 75172 Pinout, Only 110µA I <sub>Q</sub>
LTC488	Quad RS485 Receiver	Fits 75173 Pinout, Only 7mA I <sub>Q</sub>
LTC490	Full Duplex RS485 Transceiver	Fits 75179 Pinout, Only 300µA I <sub>Q</sub>
LTC1481	Ultra-Low Power Half Duplex RS485 Transceiver	Fits 75176 Pinout, 80µA I <sub>Q</sub>