

2011/12

EMC/EMI Components
Solutions for Commercial Power Systems

SCHAFFNER
energy efficiency and reliability



Product Selection Chart

EMC & output filters

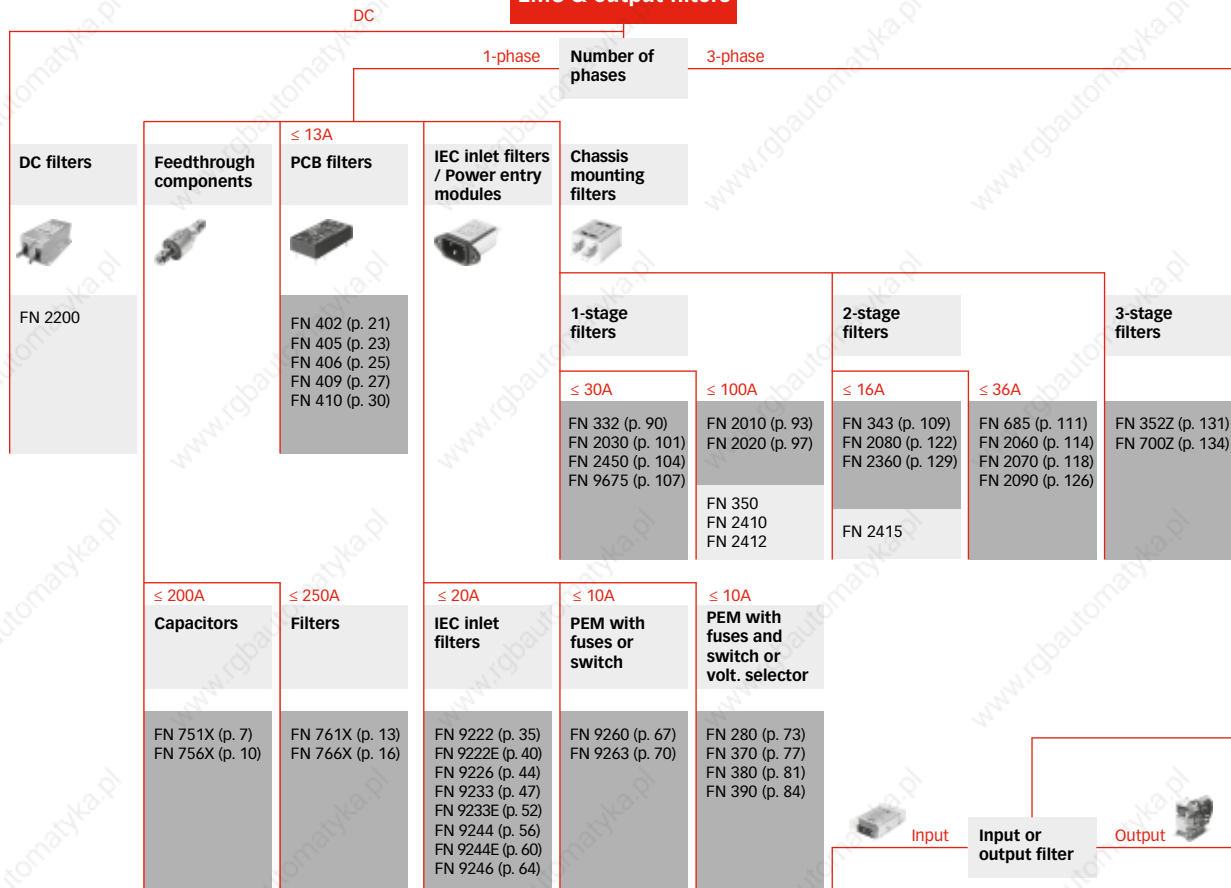

Harmonic filters

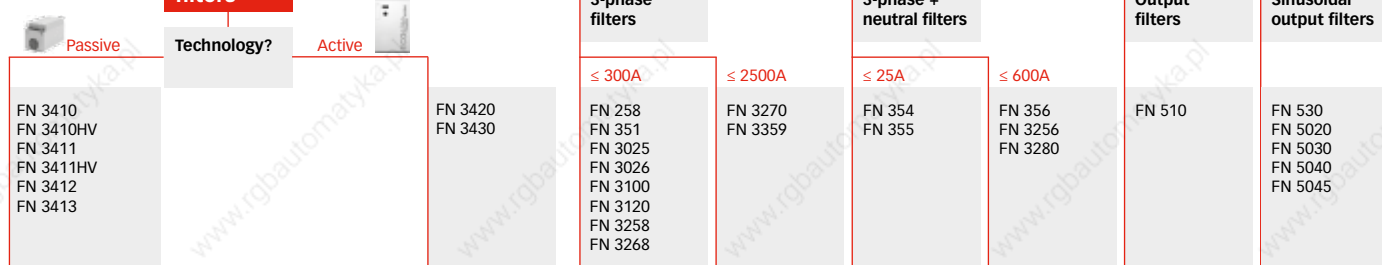

3-phase reactors

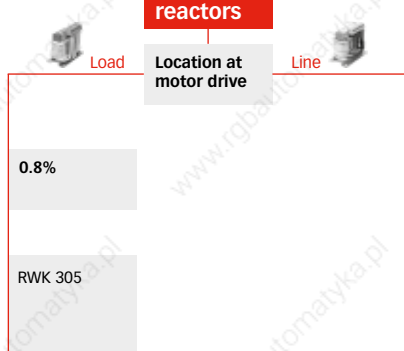



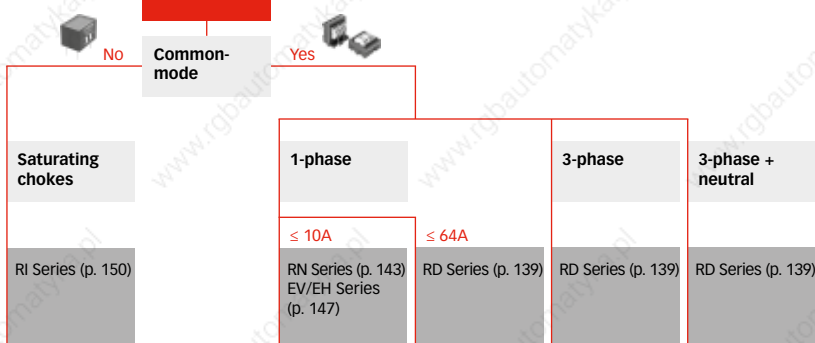



















Chokes



EMC/EMI Components – Solutions for Commercial Power Systems

EMC and Power Quality – Solutions for Industrial Power Systems (see separate catalog)

												
Typical applications	Transportation – Rail vehicles – Locomotives – Electric car propulsion – Diesel-electric ship propulsion	EDP & office – PCs – Printers – PC periphery – Fax machines – Copy machines – Monitors – Plotters – Mainframe computers	Drives & controls – AC & DC motor drives – SCR drives – Servo drives – Regenerative drives – Rectifiers (AC-DC) – Converters (AC-AC, DC-DC) – Inverters (DC-AC) – Battery chargers	Process automation – Robotics – Conveyors – Assembly lines – Control units – Mining industry – Chemical industry – Oil production – Metal processing	Elevators & cranes – Elevators for people and goods – Escalators – Cranes – Lifts – Hoists – Dumbwaiters	Convenience – Amplifiers, audio, video, TV, screens – Receivers, decoders – Laundry machines – Tumblers – Cooking equipment – Induction heaters – Exercise machines – Vending and gaming-machine	Medical – X-ray equipment – CAT scanners – Defibrillators – Laboratory equipment – Analyzers – Measurement devices – MRI, MS, EEG, ECG – Test equipment – Hospitals	Military – Security systems – Surveillance equipm. – Communication equipment – Aircraft, ships, tanks, submarines – Radar systems – Navigation systems	Building automation – HVAC – Security systems – Control units – Pumps – Self-ballasted lighting equipment – Autom. window shades – Water treatment – Office buildings	Power & energy – SMPS, UPS – DC/DC converters – Gen-sets – Wind turbines – Fuel cells – Gas turbines – UPS – PV systems	Telecom & datacom – Base stations for GSM, UMTS, GPRS – Power line communications – Network technology – Servers – Telephone installations – Broadcast installations – Data centers	Machinery – Machine tools – Printing machines – Packaging machines – Extruders – Wood working mach. – Milling/drilling mach. – Laser cutting machines – Welding machines – Grinding machines
Single-phase filters and DC filters 	Custom designs for hybrid and electric cars		FN 350 FN 2410/12 FN 2200	FN 350 FN 2410/12 FN 2415	FN 241X				FN 350	FN 2200		FN 350 FN 2410/12 FN 2415
Three-phase filters 		FN 3025/26 FN 3258 FN 3268	FN 258 FN 3025/26 FN 3100 FN 3258 FN 3268 FN 3270 FN 3359	FN 258 FN 3025/26 FN 31xx FN 3258 FN 3268 FN 3270 FN 3359	FN 258 FN 3100 FN 3258 FN 3268	FN 3025/26 FN 3258 FN 3268	FN 258P FN 258L FN 3025/26	FN 258 FN 3258 FN 3268 FN 3359	FN 258 FN 351 FN 3025/26 FN 3258 FN 3268	FN 258 FN 3025/26 FN 3100 FN 3120 FN 3258 FN 3268 FN 3359	Customized three-phase telecom filters	FN 258 FN 3100 FN 3120 FN 3258 FN 3270 FN 3359
Three-phase and neutral line filters 		FN 354 FN 355 FN 3256	FN 356 FN 3256 FN 3280	FN 356 FN 3256 FN 3280		FN 354 FN 355	FN 354 FN 355	FN 354	FN 3256	FN 356 FN 3256 FN 3280	FN 354	FN 356 FN 3256 FN 3280
Output filters and load reactors 	Customized magnetics for rail vehicles and ship propulsion		FN 510 FN 50XX FN 530 RWK 305	FN 510 FN 50XX RWK 305	FN 510 FN 50XX RWK 305			FN 510 FN 530 FN 50XX RWK 305	FN 510 FN 50XX RWK 305	Customized reactor and filter solutions for (renewable) energy production and feeding power into the network		FN 510 FN 50XX RWK 305
Line reactors and harmonic filters 	Customized magnetics for rail vehicles and ship propulsion	FN 3430	FN 3410/11 FN 3412/13 RWK 212	FN 3410/11 FN 3412/13 FN 3420 RWK 212	FN 3410/11 FN 3412/13 FN 3420 RWK 212		FN 3430		FN 3410/11 FN 3412/13 FN 3420 FN 3430	FN 3420 Customized reactor and filter solutions for (renewable) energy production and feeding power into the network		FN 3410/11 FN 3412/13 FN 3420 RWK 212
Feedthrough components 	Customized feed-through solutions for automotive applications	FN 756X (page 10) FN 766X (page 16)		FN 751X (page 7) FN 761X (page 13)			FN 751X (page 7) FN 756X (page 10) FN 761X (page 13) FN 766X (page 16)	FN 751X (page 7) FN 756X (page 10) FN 761X (page 13) FN 766X (page 16)		FN 751X (page 7) FN 756X (page 10) FN 761X (page 13) FN 766X (page 16)	FN 751X (page 7) FN 756X (page 10) FN 761X (page 13) FN 766X (page 16)	FN 751X (page 7) FN 761X (page 13)
PCB filters 	Customized PCB filters for automotive applications	FN 402 (page 21) FN 405 (page 23) FN 406 (page 25) FN 410 (page 30)									FN 409 (page 27)	
IEC inlet filters and Power entry modules 		FN 280 (page 73) FN 390 (page 84) FN 922X (page 35 ff) FN 9233(E) (page 47 ff) FN 9244(E) (page 56 ff) FN 926X (page 67 ff)				FN 280 (page 73) FN 3X0 (page 77 ff) FN 9222(E) (page 35 ff) FN 9233(E) (page 47 ff) FN 9246 (page 64) FN 9260 (page 67) FN 9263 (page 70)	FN 280B (page 73) FN 2450 (page 104) FN 9222(E)B (page 35 ff) FN 9233(E)B (page 47 ff) FN 9244(E)B (page 56 ff) FN 9246B (page 64) FN 9260B (page 67)	Customized filter solutions with military connectors	FN 9246 (page 64)	FN 280 (page 73) FN 3X0 (page 77 ff) FN 922X (page 35 ff) FN 9233(E) (page 47 ff) FN 9244(E) (page 56 ff) FN 9260 (page 67) FN 9263 (page 70)	FN 9246 (page 64)	
Single-phase filters 	Custom designs for hybrid and electric cars	FN 343 (page 109) FN 20X0 (page 93 ff) FN 2360 (page 129)	FN 2070 (page 118) FN 2080 (page 122) FN 2090 (page 126)	FN 2070 (page 118) FN 2080 (page 122) FN 2090 (page 126)	FN 685 (page 111) FN 2070 (page 118) FN 2080 (page 122)	FN 332 (page 90) FN 20X0 (page 93 ff) FN 2360 (page 129)	FN 332 (page 90) FN 20X0B (page 93 ff) FN 2360 (page 129) FN 2450 (page 104) FN 700Z (page 134)	FN 352Z (page 131) FN 700Z (page 134)	FN 2060 (page 114) FN 2070 (page 118) FN 2090 (page 126)	FN 2030 (page 101) FN 2060 (page 114) FN 2070 (page 118) FN 2090 (page 126)	FN 700Z (page 134) Customized single-phase telecom filters	FN 2070 (page 118) FN 2080 (page 122)
EMC/EMI chokes 		EV/EH Series (page 147) RD Series (page 139) RN Series (page 143)	RD Series (page 139) RN Series (page 143)	RD Series (page 139)	RD Series (page 139)	EV/EH Series (page 147) RD Series (page 139) RN Series (page 143)	EV/EH Series (page 147) RD Series (page 139) RN Series (page 143)	RD Series (page 139) RN Series (page 143)	EV/EH Series (page 147) RD Series (page 139) RI Series (page 150) RN Series (page 143)	EV/EH Series (page 147) RD Series (page 139) RN Series (page 143)	EV/EH Series (page 147) RD Series (page 139) RN Series (page 143)	RD Series (page 139)
Pulse transformers 		IT Series (page 155)	IT Series (page 155)				IT Series (page 155)	IT Series (page 155)	IT Series (page 155)	IT Series (page 155)	IT Series (page 155)	

This illustration only contains a few typical products and applications. Schaffner is also active in numerous other industry segments. Most standard components can be customized to meet special requirements.

SCHAFFNER GROUP

Schaffner is the international leader in the fields of electromagnetic compatibility and power quality, supplying components that support the efficient and reliable use of electric energy. Customers benefit from the technological know-how of the Schaffner Group in the development, manufacturing and marketing of high-performance products that offer optimized and fault-free operation and compliance with all major quality and performance standards. With its products and services, the Schaffner Group plays a key role in promoting technologies that support renewable energies, ensures the reliable functioning of electronic equipment and systems and meets the requirements for greater energy efficiency.

A global one-stop shop

EMC/EMI filters

- PCB filters
- IEC inlet filters / Power entry modules
- Single-phase filters
- Three-phase filters
- Three-phase + neutral line filters
- Open frame filters

EMC/EMI chokes

Feedthrough filters and capacitors

Automotive components

Customized solutions

Power Quality

- Line reactors
- dv/dt reactors and filters
- Sine wave filters
- Harmonic filters
- Regen reactors and filters
- Transformers

Customized solutions

With the EMC and power quality components it develops and its global services for OEM customers, equipment manufacturers and systems integrators, the Schaffner Group plays a key role in the promotion of technologies and the generation of renewable energies and enables the development of systems that meet the requirements of energy efficiency.

The Schaffner Group offers its expertise and services worldwide in the fields of development consultancy, EMC testing, application support and production. Through its worldwide network of sales, application and production centers, as well as research and development teams and efficient logistics management, Schaffner provides local support to regional and global customers.

Contents

Product overview



Feedthrough Components

5



PCB Filters

19



IEC Inlet Filters / Power Entry Modules

33



Single-phase Filters

87



EMC/EMI Chokes

137



Pulse Transformers

153

Basics in EMC and Power Quality

162

I	Introduction	165
II	Annotations to filter specifications	196
III	Typical applications	206
IV	Abbreviations	214
V	Index	215

Product index **217**

Ordering information **218**

Important safety note

This publication contains statements about the suitability of Schaffner products for certain areas of application.

These are based upon typical known system requirements. However, such statements cannot be regarded as binding statements about the suitability of a Schaffner product for a particular customer application.

It is always incumbent on the customer to check and decide whether a Schaffner product is suitable for use in a particular customer application.

Overloading of EMC/EMI filters, such as with circuits able to cause resonances, impermissible voltages at high frequencies etc can lead to system reliability issues, material damage, or bodily injury.

Such overloading can be avoided by proper power systems engineering. Schaffner application engineers are globally available to support customers with system engineering questions, proper Schaffner product selection and product design-in.



Feedthrough Components

FN 751X	7
FN 756X	10
FN 761X	13
FN 766X	16

Feedthrough Components.

Interference suppression up into the GHz range for high-tech applications such as IT, telecom, server and networking equipment.

Approvals *



Capacitance [nF]
 Rated current [A]
 Attenuation performance

Features

Typical applications

Feedthrough capacitors	Max. voltage	Capacitance [nF]						Features				Typical applications												
		0	1000	2000	3000	4000	5000	AC capacitors	DC capacitors	AC filters	DC filters	Very high performance	Y2 capacitor class	Y4 capacitor class	Medical equipment	Professional power supplies	Power electronic equipment	Telecommunication	Military (radar, communic.)	Aeronautic	Security systems	IT, server and network		
FN 7510 p. 7	300VAC	2.2 - 47																						
FN 7511 p. 7	300VAC	4.7 - 220																						
FN 7512 p. 7	300VAC	47 - 100																						
FN 7513 p. 7	300VAC	100																						
FN 7560 p. 10	130VDC	10 - 100																						
FN 7561 p. 10	130VDC	47 - 470																						
FN 7562 p. 10	130VDC	100 - 1000																						
FN 7563 p. 10	130VDC	470 - 4700																						

Feedthrough filters

standard high very high

Feedthrough filters	Max. voltage	Capacitance [nF]						Features				Typical applications												
		0	1000	2000	3000	4000	5000	AC capacitors	DC capacitors	AC filters	DC filters	Very high performance	Y2 capacitor class	Y4 capacitor class	Medical equipment	Professional power supplies	Power electronic equipment	Telecommunication	Military (radar, communic.)	Aeronautic	Security systems	IT, server and network		
FN 7611 p. 13	300VAC	10																						
FN 7612 p. 13	300VAC	10																						
FN 7660 p. 16	130VDC	10																						
FN 7661 p. 16	130VDC	10																						

* Products evaluated by one or more of the above certification agencies. For details please consult the detailed data sheet.

AC Feedthrough Capacitor

SCHAFFNER
energy efficiency and reliability



- IEC/EN 60384-14 approval
- Rated currents from 10 to 200A
- 5kV pulse test capability
- Class Y2 capacitor

Approvals



ROHS

Technical specifications

Maximum continuous operating voltage:	250VAC, 50/60Hz (UL)
	300VAC, 50/60Hz (ENEC)
	1000VDC max.
Rated currents:	10 to 200A @ 60°C max.
Capacitor class:	Y2
High potential test voltage:	3000VDC for 2 sec
Insulation resistance (100VDC after 60 sec):	< 0.33μF, R > 1500MΩ
	> 0.33μF, τ > 5000s
Temperature range (operation and storage):	-40°C to +100°C (40/100/21)
Flammability corresponding to:	UL 94V-2 or better
MTBF @ 60°C/300V (Mil-HB-217F):	< 200A: > 1,600,000 hours
	≥ 200A: > 850,000 hours

Typical electrical schematic

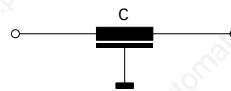

Feedthrough capacitors offer a high insertion loss across a broad band of frequencies from a few tens of kHz up to the GHz region. The construction of feedthrough capacitors cause a better suppression performance over a much wider frequency range than a conventional two-wire capacitor of equivalent value. Different versions are available offering a wide selection on operating currents and performance levels. AC feedthrough capacitors are designed and approved for up to 300VAC 50/60Hz operation.

Features and benefits

- Very low internal series inductance.
- Very high self-resonant frequency.
- Self-healing dielectric.
- High quality and reliability.
- Through-bulkhead mounting.
- Anti-twist protection.
- Custom-specific or dual-versions on request.

Typical applications

- Power line filter for 110/240VAC power lines
- Increasing system and information security
- Power supplies
- Switching and cellular equipment
- Computer servers
- UPS power supplies
- Medical equipment
- Shielded rooms

Feedthrough selector table

Feedthrough	Rated current @ 60°C	Leakage current* @ 250VAC/50Hz	Capacitance** C	DC resistance*** R @ 25°C	Weight
	[A]	[mA]	[nF]	[mΩ]	[g]
FN 7510-10-M3	10	0.21	2.2	0.8	15
FN 7511-10-M3	10	0.44	4.7	0.8	15
FN 7510-16-M4	16	0.44	4.7	0.5	28
FN 7511-16-M4	16	0.94	10	0.52	28
FN 7512-16-M4	16	4.4	47	0.62	33
FN 7513-16-M4	16	9.4	100	0.58	65
FN 7510-20-M4	20	0.44	4.7	0.5	28
FN 7510-32-M4	32	0.44	4.7	0.52	28
FN 7511-32-M4	32	0.94	10	0.52	28
FN 7512-32-M4	32	3.1	33	0.62	34
FN 7514-32-M4	32	9.4	100	0.58	65
FN 7512-63-M6	63	9.4	100	0.3	70
FN 7510-100-M8	100	4.4	47	0.23	100
FN 7511-100-M8	100	9.4	100	0.23	100
FN 7511-200-M10	200	20.7	220	0.16	157

* Tolerance +20%
 ** Tolerance ±20%
 *** Tolerance +15%

Typical filter attenuation

50Ω system

10A types

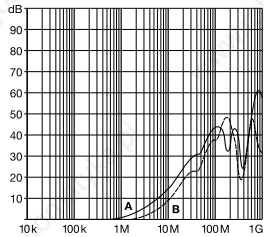

A = FN 7511-10-M3
 B = FN 7510-10-M3

16 and 20A types

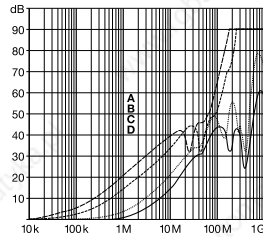

A = FN 7513-16-M4
 B = FN 7512-16-M4
 C = FN 7511-16-M4
 D = FN 7510-16-M4
 FN 7510-20-M4

32A types

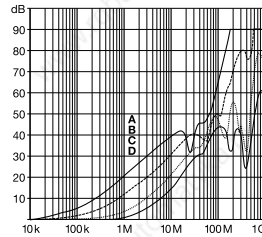

A = FN 7514-32-M4
 B = FN 7512-32-M4
 C = FN 7511-32-M4
 D = FN 7510-32-M4

63A types

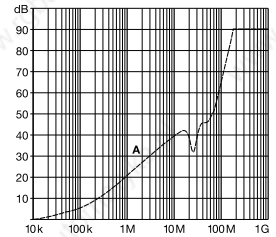

A = FN 7512-63-M6

100A types

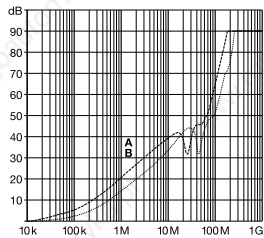

A = FN 7511-100-M8
 B = FN 7510-100-M8

200A types

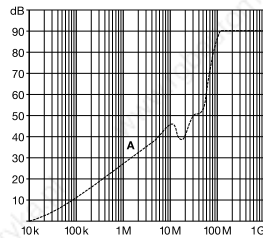

A = FN 7511-200-M10

Mechanical data

10A types

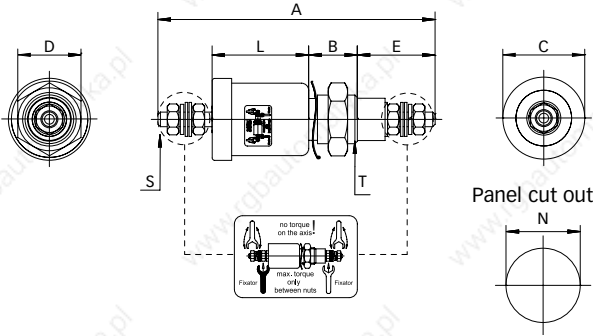

16 to 32A types

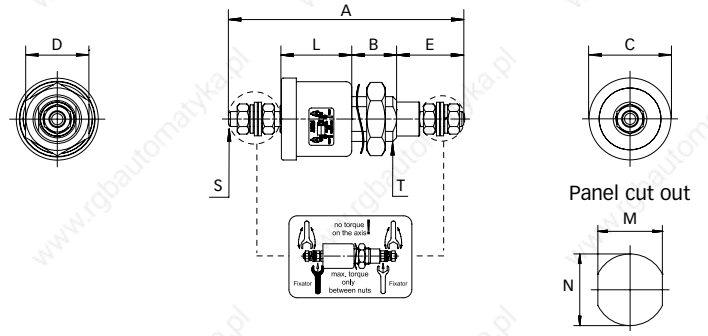

63 to 200A types

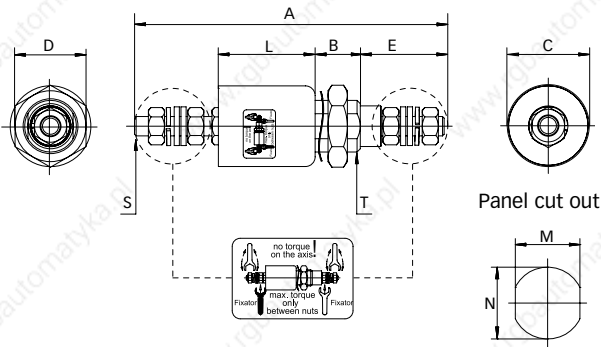

Dimensions

	A	B	C	D	E	L	M	N	S	T
FN 7510-10-M3	57	10	16.85 ±0.3	13	16 ±2.0	19.85 ±0.5		Ø10.3	M3	M10x1
FN 7511-10-M3	57	10	16.85 ±0.3	13	16 ±2.0	19.85 ±0.5		Ø10.3	M3	M10x1
FN 7510-16-M4	63	12	21.95 ±0.3	17	18 ±2.0	18.85 ±0.5	10.3	Ø12.3	M4	M12x1
FN 7511-16-M4	63	12	21.95 ±0.3	17	18 ±2.0	18.85 ±0.5	10.3	Ø12.3	M4	M12x1
FN 7512-16-M4	75	12	21.95 ±0.3	17	18 ±2.0	30.85 ±0.5	10.3	Ø12.3	M4	M12x1
FN 7513-16-M4	77	14	26.95 ±0.3	22	18 ±2.0	30.85 ±0.5	14.3	Ø16.3	M4	M16x1
FN 7510-20-M4	63	12	21.95 ±0.3	17	18 ±2.0	18.85 ±0.5	10.3	Ø12.3	M4	M12x1
FN 7510-32-M4	63	12	21.95 ±0.3	17	18 ±2.0	18.85 ±0.5	10.3	Ø12.3	M4	M12x1
FN 7511-32-M4	63	12	21.95 ±0.3	17	18 ±2.0	18.85 ±0.5	10.3	Ø12.3	M4	M12x1
FN 7512-32-M4	75	12	21.95 ±0.3	17	18 ±2.0	30.85 ±0.5	10.3	Ø12.3	M4	M12x1
FN 7514-32-M4	77	14	26.95 ±0.3	22	18 ±2.0	30.85 ±0.5	14.3	Ø16.3	M4	M16x1
FN 7512-63-M6	96	14	25	22	26 ±2.0	30	14.3	Ø16.3	M6	M16x1
FN 7510-100-M8	113	16	32	27	32 ±2.0	33	18.3	Ø20.3	M8	M20x1
FN 7511-100-M8	113	16	32	27	32 ±2.0	33	18.3	Ø20.3	M8	M20x1
FN 7511-200-M10	130	19	38	27	40 ±2.0	33	22.3	Ø24.3	M10	M24x1
Tolerances					±2		±0.2			

All dimensions in mm; 1 inch = 25.4mm
 Tolerances according: ISO 2768-m / EN 22768-m

Recommended torque

	M3	M4	M6	M8	M10	M10x1	M12x1	M16x1	M20x1	M24x1
Terminal thread	0.5Nm	1.2Nm	2.5Nm	5Nm	8Nm					
Mounting thread						2Nm	3Nm	4Nm	7Nm	8Nm

DC Feedthrough Capacitor

SCHAFFNER
energy efficiency and reliability



- IEC/EN 60384-14 approval
- Rated currents from 10 to 200A
- 2.5kV pulse test capability
- Class Y4 capacitor

Approvals



ROHS

Technical specifications

Maximum continuous operating voltage:	130VDC (UL, ENEC) 130VAC, 50/60Hz (UL, ENEC) 650VDC max.
Rated currents:	10 to 200A @ 60°C max.
Capacitor class:	Y4
High potential test voltage:	1700VDC for 2 sec
Insulation resistance (100VDC after 60 sec):	< 0.33μF, R > 1500MΩ > 0.33μF, τ > 5000s
Temperature range (operation and storage):	-40°C to +100°C (40/100/21)
Flammability corresponding to:	UL 94V-2 or better
MTBF @ 60°C/130V (Mil-HB-217F):	< 200A: > 1,400,000 hours ≥ 200A: > 450,000 hours

Typical electrical schematic

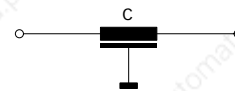

Feedthrough capacitors offer a high insertion loss across a broad band of frequencies from a few tens of kHz up to the GHz region. The construction of feedthrough capacitors cause a better suppression performance over a much wider frequency range than a conventional two-wire capacitor of equivalent value. Different versions are available offering a wide selection on operating currents and performance levels. DC feedthrough capacitors are designed and approved for 130VDC/130VAC 50/60Hz operation.

Features and benefits

- Very low internal series inductance.
- Very high self-resonant frequency.
- Self-healing dielectric.
- High quality and reliability.
- Through-bulkhead mounting.
- Anti-twist protection.
- Custom-specific or dual-versions on request.

Typical applications

- Power line filter for 48VDC battery power
- Increasing system and information security
- Telecom base stations
- Switching and cellular equipment
- Computer servers
- UPS power supplies
- Medical equipment

Feedthrough selector table

Feedthrough	Rated current @ 60°C	Leakage current* @ 130VAC/50Hz	Capacitance** C	DC resistance*** R @ 25°C	Weight
	[A]	[mA]	[nF]	[mΩ]	[g]
FN 7560-10-M3	10	0.49	10	0.8	15
FN 7562-16-M4	16	4.9	100	0.62	34
FN 7563-16-M4	16	23	470	0.63	78
FN 7562-32-M4	32	4.9	100	0.62	34
FN 7563-32-M4	32	23	470	0.63	79
FN 7560-63-M6	63	0.49	10	0.3	70
FN 7561-63-M6	63	2.3	47	0.3	70
FN 7562-63-M6	63	4.9	100	0.3	70
FN 7563-63-M6	63	23	470	0.43	103
FN 7560-100-M8	100	2.3	47	0.23	145
FN 7561-100-M8	100	4.9	100	0.23	145
FN 7562-100-M8	100	23	470	0.23	145
FN 7563-100-M8	100	49	1000	0.25	192
FN 7560-200-M10	200	4.9	100	0.16	160
FN 7561-200-M10	200	23	470	0.16	160
FN 7562-200-M10	200	49	1000	0.18	268
FN 7563-200-M10	200	230	4700	0.14	490

- * Tolerance +20%
- ** Tolerance ±20%
- *** Tolerance +15%

Typical filter attenuation

50Ω system

10A types

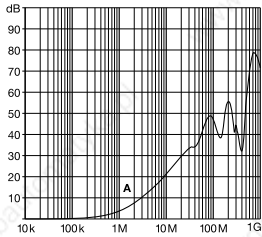

A = FN 7560-10-M3

16A types

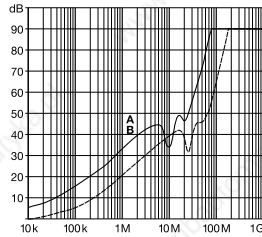

A = FN 7563-16-M4
B = FN 7562-16-M4

32A types

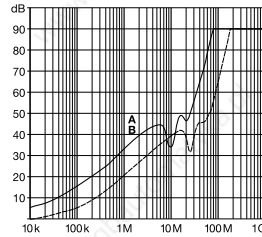

A = FN 7563-32-M4
B = FN 7562-32-M4

63A types

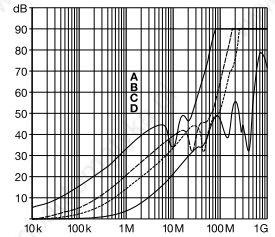

A = FN 7563-63-M6
B = FN 7562-63-M6
C = FN 7561-63-M6
D = FN 7560-63-M6

100A types

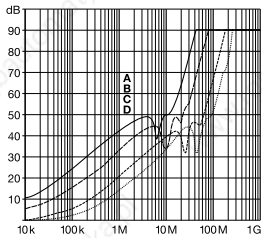

A = FN 7563-100-M8
B = FN 7562-100-M8
C = FN 7561-100-M8
D = FN 7560-100-M8

200A types

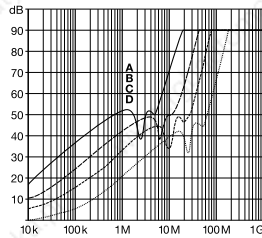

A = FN 7563-200-M10
B = FN 7562-200-M10
C = FN 7561-200-M10
D = FN 7560-200-M10

Mechanical data

10A types

16 to 32A types

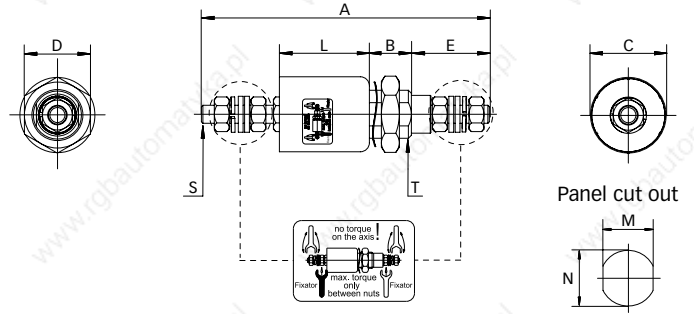
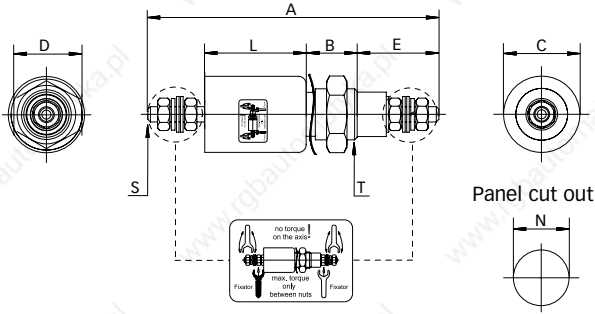

Dimensions

	A	B	C	D	E	L	M	N	S	T
FN 7560-10-M3	57	10	15	13	16	19		Ø10.3	M3	M10x1
FN 7562-16-M4	75	12	20	17	18	30	10.3	Ø12.3	M4	M12x1
FN 7563-16-M4	82	16	32	27	18	33	18.3	Ø20.3	M4	M20x1
FN 7562-32-M4	75	12	20	17	18	30	10.3	Ø12.3	M4	M12x1
FN 7563-32-M4	82	16	32	27	18	33	18.3	Ø20.3	M4	M20x1
FN 7560-63-M6	96	14	25	22	26	30	14.3	Ø16.3	M6	M16x1
FN 7561-63-M6	96	14	25	22	26	30	14.3	Ø16.3	M6	M16x1
FN 7562-63-M6	96	14	25	22	26	30	14.3	Ø16.3	M6	M16x1
FN 7563-63-M6	99	16	32	27	26	33	18.3	Ø20.3	M6	M20x1
FN 7560-100-M8	113	16	32	27	32	33	18.3	Ø20.3	M8	M20x1
FN 7561-100-M8	113	16	32	27	32	33	18.3	Ø20.3	M8	M20x1
FN 7562-100-M8	113	16	32	27	32	33	18.3	Ø20.3	M8	M20x1
FN 7563-100-M8	133	19	38	27	32	50	22.3	Ø24.3	M8	M24x1
FN 7560-200-M10	130	19	32	27	40	33	22.3	Ø24.3	M10	M24x1
FN 7561-200-M10	130	19	32	27	40	33	22.3	Ø24.3	M10	M24x1
FN 7562-200-M10	147	19	38	27	40	50	22.3	Ø24.3	M10	M24x1
FN 7563-200-M10	165	19	54	41	40	68	24.3	Ø27.3	M10	M27x1.5
Tolerances					±2		±0.2			

All dimensions in mm; 1 inch = 25.4mm
Tolerances according: ISO 2768-m / EN 22768-m

Recommended torque

	M3	M4	M6	M8	M10	M10x1	M12x1	M16x1	M20x1	M24x1	M27x1.5
Terminal thread	0.5Nm	1.2Nm	2.5Nm	5Nm	8Nm						
Mounting thread						2Nm	3Nm	4Nm	7Nm	8Nm	12Nm

AC Feedthrough Filter

energy efficiency and reliability



- IEC/EN 60939 approval
- Rated currents from 10 to 250A
- 5kV pulse test capability
- Class Y2 capacitor

Approvals



ROHS

Technical specifications

Maximum continuous operating voltage:	300VAC, 50/60Hz (ENEC) 250VAC, 50/60Hz (UL) 1000VDC max.
Rated currents:	10 to 250A @ 60°C max.
Capacitor class:	Y2
High potential test voltage:	3000VDC for 2 sec
Insulation resistance (100VDC after 60 sec):	< 0.33μF, R > 15,000MΩ > 0.33μF, τ > 5000s
Temperature range (operation and storage):	-40°C to +100°C (40/100/21)
Flammability corresponding to:	UL 94V-2 or better
MTBF @ 60°C/300V (Mil-HB-217F):	< 200A: > 675,000 hours ≥ 200A: > 494,000 hours

Typical electrical schematic

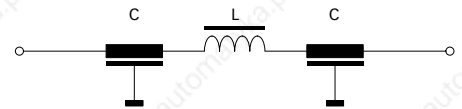

Feedthrough filters offer a high insertion loss across a broad band of frequencies from a few tens of kHz up to the GHz region. In general, feedthrough filters offer a higher level of EMI suppression than feedthrough capacitors of the same current rating. This is particularly relevant to applications where source impedance is smaller than 50Ω.

Different versions are available offering a wide selection on operating currents and performance levels. AC feedthrough filters are designed and approved for up to 300VAC 50/60Hz operation.

Features and benefits

- Very low internal series inductance.
- Very high self-resonant frequency.
- Self-healing dielectric.
- High quality and reliability.
- Through-bulkhead mounting.
- Anti-twist protection.
- Custom-specific or dual-versions on request.

Typical applications

- Power line filter for 110/240VAC power lines
- Increasing system and information security
- Power supplies
- Switching and cellular equipment
- Computer servers
- UPS power supplies
- Medical equipment
- Shielded rooms

Feedthrough selector table

Feedthrough	Rated current @ 60°C [A]	Leakage current* @ 250VAC/50Hz [mA]	Capacitance** C [nF]	Inductance L @ 10kHz [nH]	DC resistance*** R @ 25°C [mΩ]	Weight [g]
FN 7611-10-M3	10	1.89	10	70	1.2	55
FN 7612-10-M3	10	8.86	47	70	1.52	70
FN 7611-16-M4	16	4.15	22	70	0.65	80
FN 7612-16-M4	16	18.85	100	70	0.92	90
FN 7611-32-M4	32	4.15	22	70	0.65	80
FN 7612-32-M4	32	18.85	100	70	0.92	90
FN 7611-63-M6	63	28.3	150	186	0.47	250
FN 7612-63-M6	63	88.6	470	124	0.53	500
FN 7612-100-M8	100	188	1000	124	0.23	750
FN 7611-250-M12	250	88.6	470	169	0.23	1086

* Tolerance +20%
 ** Tolerance ±20%
 *** Tolerance +15%

Typical filter attenuation

Full load, 50Ω system

10A types

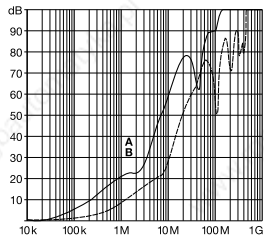

A = FN 7612-10-M3
 B = FN 7611-10-M3

16A types

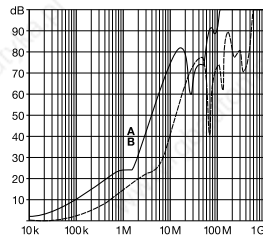

A = FN 7612-16-M4
 B = FN 7611-16-M4

32A types

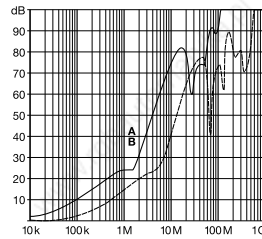

A = FN 7612-32-M4
 B = FN 7611-32-M4

63A types

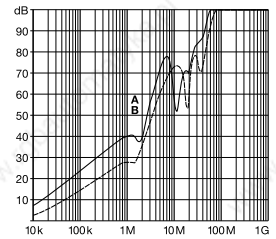

A = FN 7612-63-M6
 B = FN 7611-63-M6

100A types

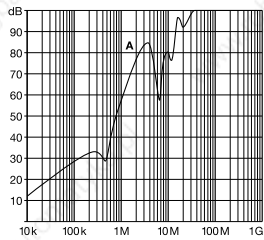

A = FN 7612-100-M8

250A types

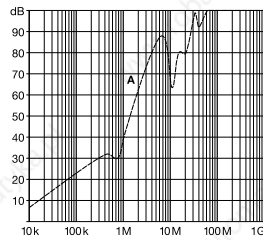

A = FN 7611-250-M12

Mechanical data

Panel cut out

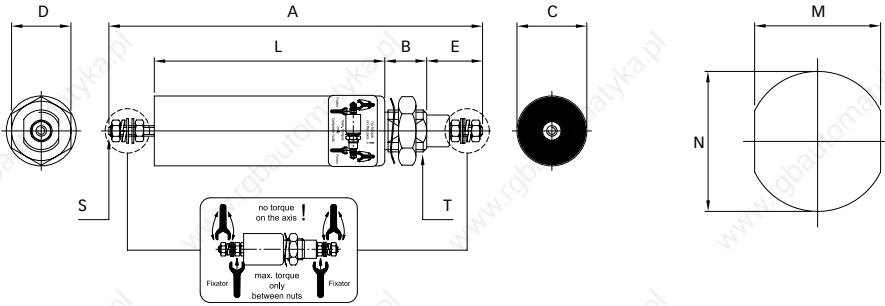

Dimensions

	A	B	C	D	E	L	M	N	S	T
FN 7611-10-M3	107	12	20	17	16	66	10.3	Ø12.3	M3	M12x1
FN 7612-10-M3	140	12	20	17	16	99	10.3	Ø12.3	M3	M12x1
FN 7611-16-M4	116	14	25	22	18	69	14.3	Ø16.3	M4	M16x1
FN 7612-16-M4	148	14	25	22	18	101	14.3	Ø16.3	M4	M16x1
FN 7611-32-M4	116	14	25	22	18	69	14.3	Ø16.3	M4	M16x1
FN 7612-32-M4	148	14	25	22	18	101	14.3	Ø16.3	M4	M16x1
FN 7611-63-M6	173	16	32	27	26	105	18.3	Ø20.3	M6	M20x1
FN 7612-63-M6	189	19	54	41	26	118	24.3	Ø27.3	M6	M27x1.5
FN 7612-100-M8	227	19	54	41	32	144	24.3	Ø27.3	M8	M27x1.5
FN 7611-250-M12	267	19	54	41	46	160	29.3	Ø32.3	M12	M32x1.5
Tolerances					±2		±0.2			

All dimensions in mm; 1 inch = 25.4mm
 Tolerances according: ISO 2768-m / EN 22768-m

Recommended torque

	M3	M4	M6	M8	M12	M12x1	M16x1	M20x1	M27x1.5	M32x1.5
Terminal thread	0.5Nm	1.2Nm	2.5Nm	5Nm	11Nm					
Mounting thread						3Nm	4Nm	7Nm	12Nm	14Nm

DC Feedthrough Filter

SCHAFFNER
energy efficiency and reliability



- IEC/EN 60939 approval
- Rated currents from 10 to 200A
- 2.5kV pulse test capability
- Class Y4 capacitor

Approvals



ROHS

Technical specifications

Maximum continuous operating voltage:	130VDC (UL, ENEC) 130VAC, 50/60Hz (UL, ENEC) 650VDC max.
Rated currents:	10 to 200A @ 60°C max.
Capacitor class:	Y4
High potential test voltage:	1700VDC for 2 sec
Insulation resistance (100VDC after 60 sec):	< 0.33μF, R > 15,000MΩ > 0.33μF, τ > 5000s
Temperature range (operation and storage):	-40°C to +100°C (40/100/21)
Flammability corresponding to:	UL 94V-2 or better
MTBF @ 60°C/130V (Mil-HB-217F):	< 200A: 680,000 hours ≥ 200A: 356,000 hours

Typical electrical schematic

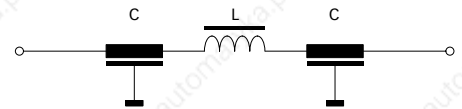

Feedthrough filters offer a high insertion loss across a broad band of frequencies from a few tens of kHz up to the GHz region. In general, feedthrough filters offer a higher level of EMI suppression than feedthrough capacitors of the same current rating. This is particularly relevant to applications where source impedance is smaller than 50Ω.

Different versions are available offering a wide selection on operating currents and performance levels. DC feedthrough filters are designed and approved for 130VDC/130VAC 50/60Hz operation.

Features and benefits

- Very low internal series inductance.
- Very high self-resonant frequency.
- Self-healing dielectric.
- High quality and reliability.
- Through-bulkhead mounting.
- Anti-twist protection.
- Custom-specific or dual-versions on request.

Typical applications

- Power line filter for 48VDC battery power
- Increasing system and information security
- Telecom base stations
- Switching and cellular equipment
- Computer servers
- UPS power supplies
- Medical equipment

Feedthrough selector table

Feedthrough	Rated current @ 60°C [A]	Leakage current* @ 130VAC/50Hz [mA]	Capacitance** C [nF]	Inductance L @ 10kHz [nH]	DC resistance*** R @ 25°C [mΩ]	Weight [g]
FN 7660-10-M3	10	0.98	10	58	1.06	48
FN 7661-10-M3	10	9.8	100	70	1.2	55
FN 7661-16-M4	16	9.8	100	70	0.7	58
FN 7660-32-M4	32	0.98	10	70	0.65	58
FN 7661-32-M4	32	9.8	100	70	0.7	58
FN 7660-63-M6	63	9.8	100	70	0.42	120
FN 7661-63-M6	63	46	470	186	0.47	250
FN 7660-100-M8	100	46	470	124	0.25	280
FN 7661-100-M8	100	98	1000	186	0.28	320
FN 7660-200-M10	200	46	470	124	0.24	410
FN 7661-200-M10	200	460.7	4700	124	0.24	655

* Tolerance +20%

** Tolerance ±20%

*** Tolerance +15%

Typical filter attenuation

Full load, 50Ω system

10A types

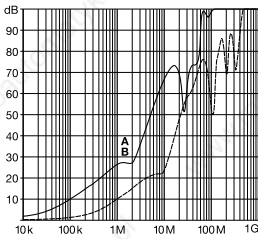

A = FN 7661-10-M3
B = FN 7660-10-M3

16A types

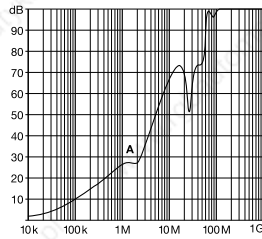

A = FN 7661-16-M4

32A types

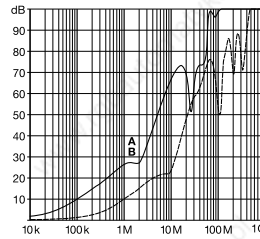

A = FN 7661-32-M4
B = FN 7660-32-M4

63A types

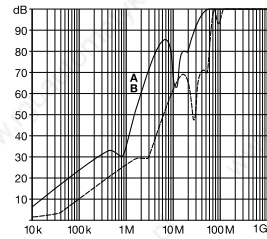

A = FN 7661-63-M6
B = FN 7660-63-M6

100A types

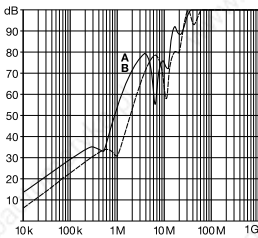

A = FN 7661-100-M8
B = FN 7660-100-M8

200A types

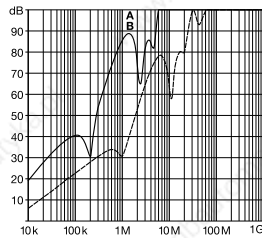

A = FN 7661-200-M10
B = FN 7660-200-M10

Mechanical data

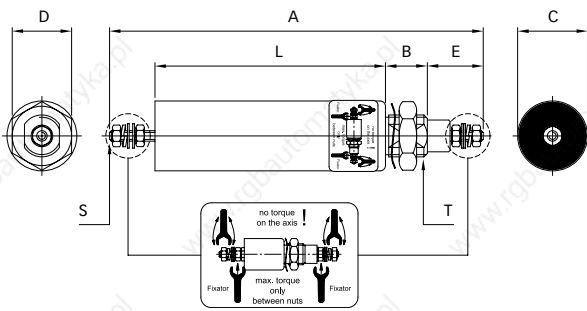

Panel cut out

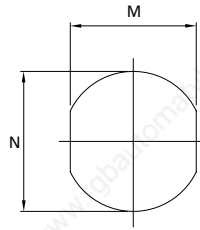

Dimensions

	A	B	C	D	E	L	M	N	S	T
FN 7660-10-M3	90	12	20	17	16	49	10.3	Ø12.3	M3	M12x1
FN 7661-10-M3	107	12	20	17	16	66	10.3	Ø12.3	M3	M12x1
FN 7661-16-M4	106	12	20	17	18	61	10.3	Ø12.3	M4	M12x1
FN 7660-32-M4	98	12	20	17	18	53	10.3	Ø12.3	M4	M12x1
FN 7661-32-M4	106	12	20	17	18	61	10.3	Ø12.3	M4	M12x1
FN 7660-63-M6	160	14	25	22	26	94	14.3	Ø16.3	M6	M16x1
FN 7661-63-M6	173	16	32	27	26	105	18.3	Ø20.3	M6	M20x1
FN 7660-100-M8	184	16	32	27	32	104	18.3	Ø20.3	M8	M20x1
FN 7661-100-M8	200	16	32	27	32	120	18.3	Ø20.3	M8	M20x1
FN 7660-200-M10	209	19	38	27	40	112	22.3	Ø24.3	M10	M24x1
FN 7661-200-M10	209	19	54	41	40	112	24.3	Ø27.3	M10	M27x1.5
Tolerances					±2		±0.2			

All dimensions in mm; 1 inch = 25.4mm
 Tolerances according: ISO 2768-m / EN 22768-m

Recommended torque

	M3	M4	M6	M8	M10	M12x1	M16x1	M20x1	M24x1	M27x1.5
Terminal thread	0.5Nm	1.2Nm	2.5Nm	5Nm	8Nm					
Mounting thread						3Nm	4Nm	7Nm	8Nm	12Nm

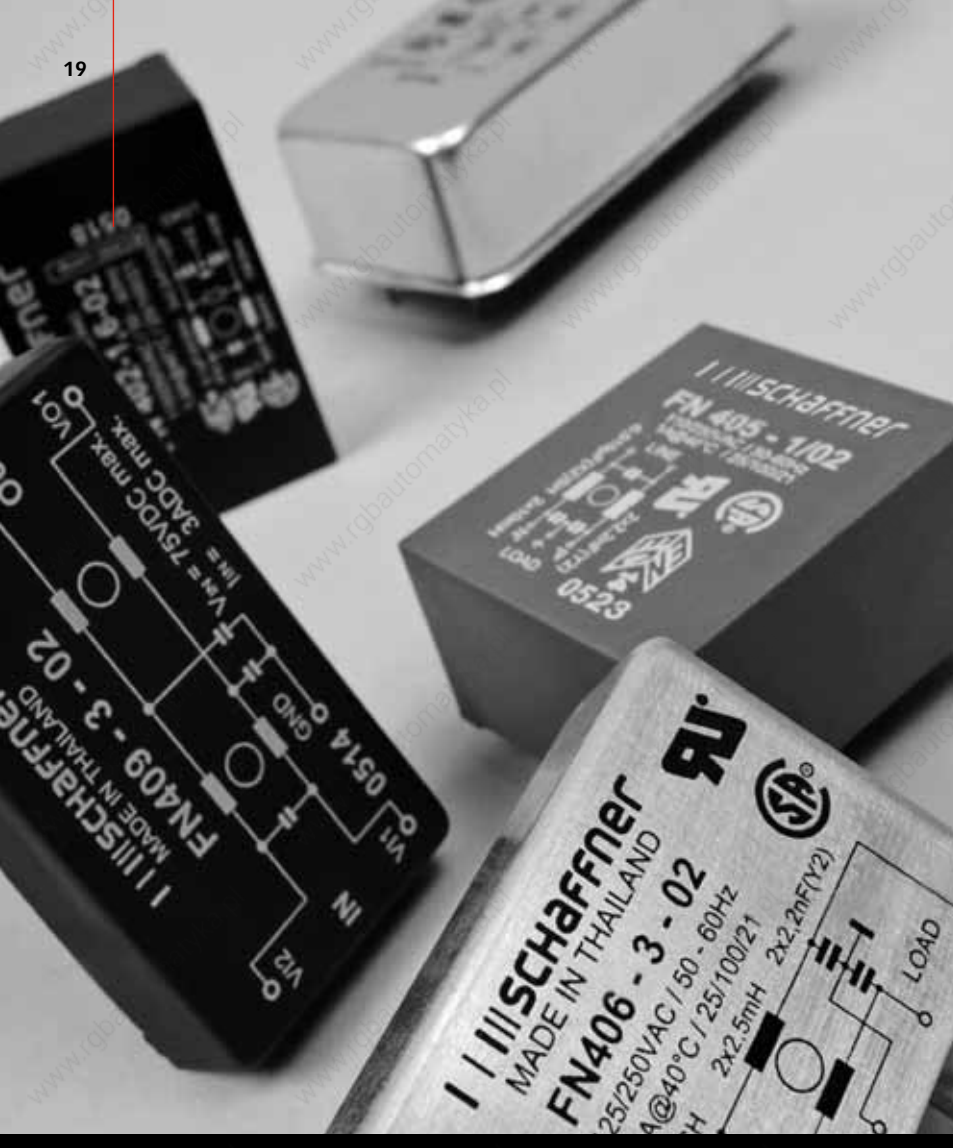

PCB Filters

FN 402	21
FN 405	23
FN 406	25
FN 409	27
FN 410	30

PCB Filters. Very compact EMI suppression components can directly be mounted on printed circuit boards of low-power office, medical, telecom and IT equipment, DC/DC converters and power supplies etc. Ideal low cost solution for manufacturers who have planned for EMC compliance throughout the equipment design process already.

Approvals *



Filter family	Max. voltage	Performance		Features										Typical applications									
		Attenuation performance	Rated current [A]	1-stage filter circuit	2-stage filter circuit	For DC applications only	PCB mounting	With metal case	Low profile	Small footprint	Automotive	DC/DC converters	IT and telecom applications	Building automation	Power supplies	Medical devices	Office automation equipment	General applications	Consumer electronics				
FN 402 p. 21	250VAC	0.5 - 6.5	0.5 - 6.5	■			■		■		■			■	■	■	■	■	■				
FN 405 p. 23	250VAC	0.5 - 10	0.5 - 10	■			■		■		■			■	■	■	■	■	■				
FN 406 p. 25	250VAC	0.5 - 8.4	0.5 - 8.4	■			■	■	■		■	■	■	■	■	■	■	■	■				
FN 409 p. 27	75VDC	3 - 13	3 - 13		■	■	■	■	■		■	■	■	■									
FN 410 p. 30	250VAC	0.5 - 6	0.5 - 6		■		■	■	■		■	■	■	■		■			■				

* Products evaluated by one or more of the above certification agencies. For details please consult the detailed data sheet.

Low Cost PCB Filter



energy efficiency and reliability

- Rated currents from 0.5 to 6.5A
- Compact PCB-mountable design
- Very low profile
- Optional medical versions (B type)

Approvals



Technical specifications

Maximum continuous operating voltage:	250VAC, 50/60Hz
Operating frequency:	dc to 400Hz
Rated currents:	0.5 to 6.5A @ 40°C max.
High potential test voltage:	P → PE 2000VAC for 2 sec (standard types) P → PE 2500VAC for 2 sec (B types) P → N 760VAC for 2 sec
Temperature range (operation and storage):	-25°C to +100°C (25/100/21)
Design corresponding to:	UL 1283, CSA 22.2 No. 8 1986, IEC/EN 60939
Flammability corresponding to:	UL 94V-0
MTBF @ 40°C/230V (Mil-HB-217F):	1,900,000 hours

Typical electrical schematic

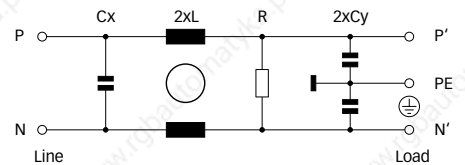

The FN 402 PCB filter is a single-phase filter designed for easy and fast PCB-mounting. Choosing the FN 402 product line brings you the rapid availability of a standard filter associated with the necessary safety acceptance. Standard PCB single-phase filters are a practical solution helping you to pass EMI system approval in a short time. A selection on amperage ratings and medical types are designed to offer you the desired standard product.

Features and benefits

- Good conducted attenuation performance, based on chokes with high saturation resistance and excellent thermal behavior.
- PCB through hole mounting.
- Low cost low profile.
- Custom specific versions on request.

Typical applications

- Electrical and electronic equipment
- Small to medium-sized machines and household equipment
- Single-phase power supplies, switch-mode power supplies
- Test and measurement equipment
- Medical equipment

Filter selection table

Filter	Rated current @ 40°C (25°C)	Leakage current* @ 230VAC/50Hz	Inductance L	Capacitance		Resistance R	Input/Output connections	Weight [g]
	[A]	[µA]	[mH]	Cx [nF]	Cy [nF]	[kΩ]		
FN 402-0.5-02	0.5 (0.6)	373	40	100	2.2	1000	-02	40
FN 402-1-02	1 (1.2)	373	10	100	2.2	1000	-02	40
FN 402-1.6-02	1.6 (1.9)	373	6	100	2.2	1000	-02	40
FN 402-2.5-02	2.5 (3)	373	2	100	2.2	1000	-02	40
FN 402-4-02	4 (4.7)	373	1	100	2.2	1000	-02	40
FN 402-6.5-02	6.5 (7.5)	373	1	100	2.2	1000	-02	40
FN 402B-0.5-02	0.5 (0.6)	2	40	100		1000	-02	40
FN 402B-1-02	1 (1.2)	2	10	100		1000	-02	40
FN 402B-1.6-02	1.6 (1.9)	2	6	100		1000	-02	40
FN 402B-2.5-02	2.5 (3)	2	2	100		1000	-02	40
FN 402B-4-02	4 (4.7)	2	1	100		1000	-02	40
FN 402B-6.5-02	6.5 (7.5)	2	1	100		1000	-02	40

* Maximum leakage under normal operating conditions. Note: if the neutral line is interrupted, worst case leakage could reach twice this level.

Product selector

FN 402x-yy-..

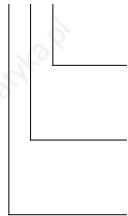

- 02: PCB through hole mounting
- 0.5 to 6.5: Rated current
- Blank: Standard version
- B: Medical version (without Y2-capacitor)

For example: FN 402-0.5-02, FN 402B-6.5-02

Typical filter attenuation

Per CISPR 17; A = 50Ω/50Ω sym; B = 50Ω/50Ω asym; C = 0.1Ω/100Ω sym; D = 100Ω/0.1Ω sym

0.5 to 1.6A types

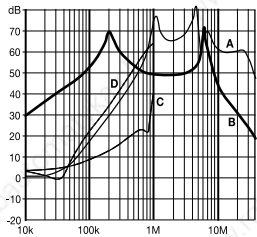

2.5 to 6.5A types

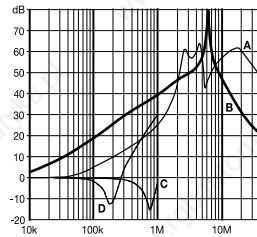

Mechanical data

FN 402

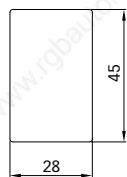
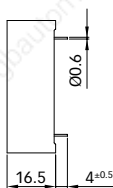
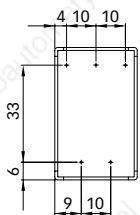

FN 402B

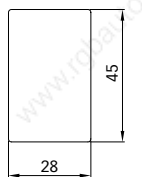
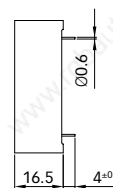
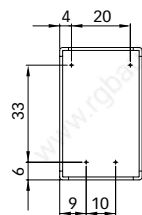

All dimensions in mm; 1 inch = 25.4mm
Tolerances according: ISO 2768-m / EN 22768-m

PCB-mounting Filter

energy efficiency and reliability

- Rated currents from 0.5 to 10A
- Compact PCB-mountable design
- Low profile

Approvals



Technical specifications

Maximum continuous operating voltage:	250VAC, 50/60Hz
Operating frequency:	dc to 400Hz
Rated currents:	0.5 to 10A @ 40°C max.
High potential test voltage:	P → PE 2000VAC for 2 sec P → N 760VAC for 2 sec
Temperature range (operation and storage):	-25°C to +100°C (25/100/21)
Design corresponding to:	UL 1283, CSA 22.2 No. 8 1986, IEC/EN 60939
Flammability corresponding to:	UL 94V-0
MTBF @ 40°C/230V (Mil-HB-217F):	1,600,000 hours

Typical electrical schematic

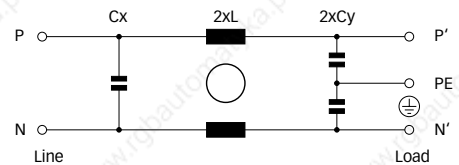

The FN 405 PCB filter is a single-phase filter designed for easy and fast PCB-mounting. Choosing the FN 405 product line brings you the rapid availability of a standard filter associated with the necessary safety acceptance. Standard PCB single-phase filters are a practical solution helping you to pass EMI system approval in a short time. A selection on amperage ratings are designed to offer you the desired standard product.

Features and benefits

- Good conducted attenuation performance, based on chokes with high saturation resistance and excellent thermal behavior.
- PCB through hole mounting.
- Low profile.
- Custom specific versions on request.

Typical applications

- Electrical and electronic equipment
- Small to medium-sized machines and household equipment
- Single-phase power supplies, switch-mode power supplies
- Test and measurement equipment

Filter selection table

Filter	Rated current @ 40°C (25°C)	Leakage current* @ 230VAC/50Hz	Inductance L	Capacitance Cx Cy		Resistance R	Input/Output connections	Weight [g]
	[A]	[μA]	[mH]	[nF]	[nF]	[kΩ]		
FN 405-0.5-02	0.5 (0.6)	373	24	15	2.2		-02	40
FN 405-1-02	1 (1.2)	373	10	15	2.2		-02	40
FN 405-3-02	3 (3.6)	373	2	15	2.2		-02	40
FN 405-6-02	6 (6.9)	373	0.8	15	2.2		-02	40
FN 405-10-02	10 (11.5)	373	0.5	15	2.2		-02	40

* Maximum leakage under normal operating conditions. Note: if the neutral line is interrupted, worst case leakage could reach twice this level.

Product selector

FN 405-yy-..

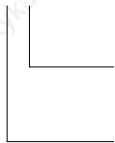

02: PCB through hole mounting

0.5 to 10: Rated current

For example: FN 405-0.5-02, FN 405-10-02

Typical filter attenuation

Per CISPR 17; A = 50Ω/50Ω sym; B = 50Ω/50Ω asym; C = 0.1Ω/100Ω sym; D = 100Ω/0.1Ω sym

0.5 and 1A types

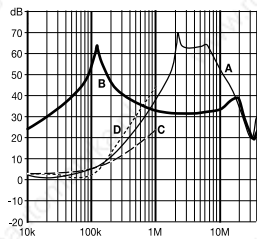

3 and 6A types

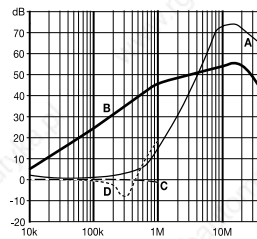

10A types

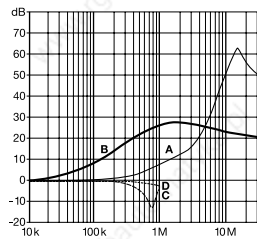

Mechanical data

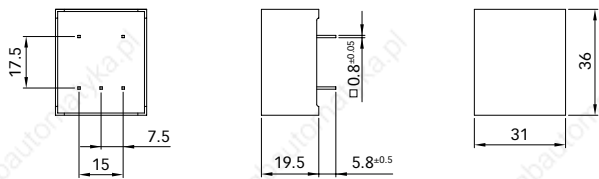

All dimensions in mm; 1 inch = 25.4mm
Tolerances according: ISO 2768-m / EN 22768-m

Ultra Compact EMC Filter



energy efficiency and reliability

- Rated currents from 0.5 to 8.4A
- Aluminum case
- Very compact PCB-mountable design
- Low profile
- Optional medical versions (B type)

Approvals



Technical specifications

Maximum continuous operating voltage:	250VAC, 50/60Hz
Operating frequency:	dc to 400Hz
Rated currents:	0.5 to 8.4A @ 40°C max.
High potential test voltage:	P → PE 2000VAC for 2 sec (standard types) P → PE 2500VAC for 2 sec (B types)
	P → N 760VAC for 2 sec
Temperature range (operation and storage):	-25°C to +100°C (25/100/21)
Design corresponding to:	UL 1283, CSA 22.2 No. 8 1986, IEC/EN 60939
Flammability corresponding to:	UL 94V-0
MTBF @ 40°C/230V (Mil-HB-217F):	1,900,000 hours

Typical electrical schematic

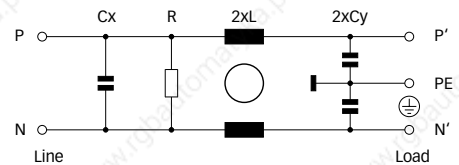

The FN 406 PCB filter is a single-phase filter designed for easy, fast and compact PCB-mounting. Choosing the FN 406 product line brings you the rapid availability of a standard filter associated with the necessary safety acceptance. Standard PCB single-phase filters are a practical solution helping you to pass EMI system approval in a short time. A selection on amperage ratings and medical types are designed to offer you the desired standard product.

Features and benefits

- Good conducted attenuation performance, based on chokes with high saturation resistance and excellent thermal behavior.
- PCB through hole mounting.
- Low profile.
- Custom specific versions on request.

Typical applications

- Electrical and electronic equipment
- Small to medium-sized machines and household equipment
- Single-phase power supplies, switch-mode power supplies
- Test and measurement equipment
- Medical equipment

Filter selection table

Filter	Rated current @ 40°C (25°C)	Leakage current* @ 230VAC/50Hz	Inductance L	Capacitance		Resistance R	Input/Output connections	Weight [g]
	[A]	[µA]	[mH]	Cx [nF]	Cy [nF]	[kΩ]		
FN 406-0.5-02	0.5 (0.6)	373	24	100	2.2	1000	-02	36
FN 406-1-02	1 (1.2)	373	12	100	2.2	1000	-02	36
FN 406-3-02	3 (3.6)	373	2.5	100	2.2	1000	-02	36
FN 406-6-02	6 (6.9)	373	0.78	100	2.2	1000	-02	36
FN 406-8.4-02	8.4 (9.6)	373	0.3	100	2.2	1000	-02	36
FN 406B-0.5-02	0.5 (0.6)	2	24	100		1000	-02	36
FN 406B-1-02	1 (1.2)	2	12	100		1000	-02	36
FN 406B-3-02	3 (3.6)	2	2.5	100		1000	-02	36
FN 406B-6-02	6 (6.9)	2	0.78	100		1000	-02	36
FN 406B-8.4-02	8.4 (9.6)	2	0.3	100		1000	-02	36

* Maximum leakage under normal operating conditions. Note: if the neutral line is interrupted, worst case leakage could reach twice this level.

Product selector

FN 406x-yy-...

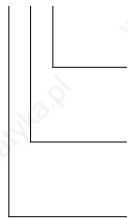

- 02: PCB through hole mounting
- 0.5 to 8.4: Rated current
- Blank: Standard version
- B: Medical version (without Y2-capacitor)

For example: FN 406-0.5-02, FN 406B-8.4-02

Typical filter attenuation

Per CISPR 17; A = 50Ω/50Ω sym; B = 50Ω/50Ω asym; C = 0.1Ω/100Ω sym; D = 100Ω/0.1Ω sym

0.5 to 3A types

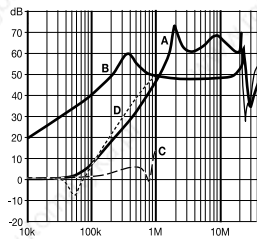

6A types

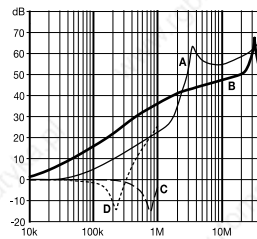

8.4A types

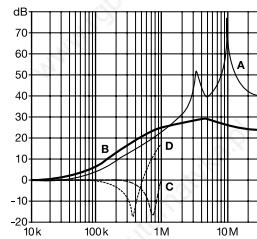

Mechanical data

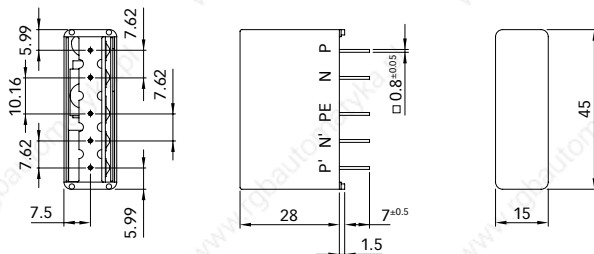

All dimensions in mm; 1 inch = 25.4mm
Tolerances according: ISO 2768-m / EN 22768-m

75VDC Input PCB0 Filter

energy efficiency and reliability

- Rated currents from 3 to 13A, 75VDC
- Very compact PCB-mounting design
- Exceptional attenuation performance
- High frequency noise compression

Approvals



Technical specifications

Maximum continuous operating voltage:	75VDC
Rated currents:	3 to 13A
High potential test voltage:	VI1/VI2 → GND 2000VDC for 2 sec VI1 → VI2 100VDC for 2 sec
Temperature range (operation and storage):	-40°C to +100°C (25/100/21)
Design corresponding to:	UL 1283, CSA 22.2 No. 8 1986, IEC/EN 60939
Flammability corresponding to:	UL 94V-0
MTBF @ 40°C/75V (Mil-HB-217F):	4,450,000 hours

Typical electrical schematic

3 and 6.5A types

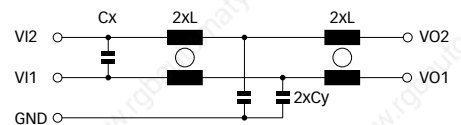

13A types

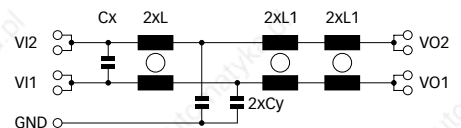

FN 409 PCB filters are designed to suppress common and differential-mode noise on DC voltage lines. The suppression performance is special designed to fulfill the requirements for high frequency switching DC/DC converter modules. FN 409 filters can also be used to filter the output current of switch-mode power supplies in applications with intelligent power distribution.

Features and benefits

- High common and differential-mode noise suppression.
- Rated currents up to 15A at 75VDC.
- Small form factor.
- Good thermal conductance.

Typical applications

- Input or output filter for high frequency DC/DC converters
- DC output filter for switch-mode power supplies
- Computer and office automation equipment
- Telecom equipment
- Input/output filter within DC power distribution networks

Filter selection table

Filter	Rated current @ 50°C (40°C)	Inductance		Capacitance		DC Resistance R @ 25°C per path	Input/Output connections	Weight
		L	L1	Cx	Cy			
	[A]	[mH]	[mH]	[nF]	[nF]	[mΩ]		[g]
FN 409-3-02	3 (3.2)	2.9		4700	4.7	86	-02	30
FN 409-6.5-02	6.5 (7)	0.5		4700	4.7	18	-02	30
FN 409-13-02	13 (14)	0.08	0.18	4700	4.7	7.8	-02	47

Typical filter attenuation

Per CISPR 17; A = 50Ω/50Ω sym; B = 50Ω/50Ω asym; C = 0.1Ω/100Ω sym; D = 100Ω/0.1Ω sym

3A types

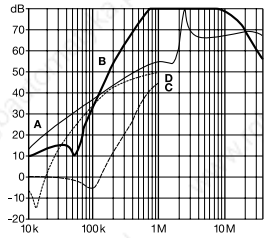

6.5A types

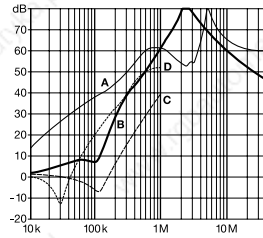

13A types

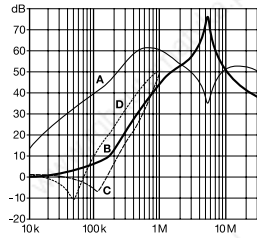

Mechanical data

3 and 6.5A types

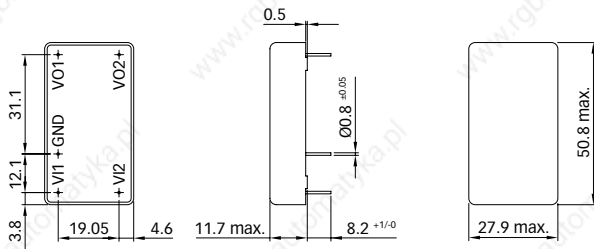

13A types

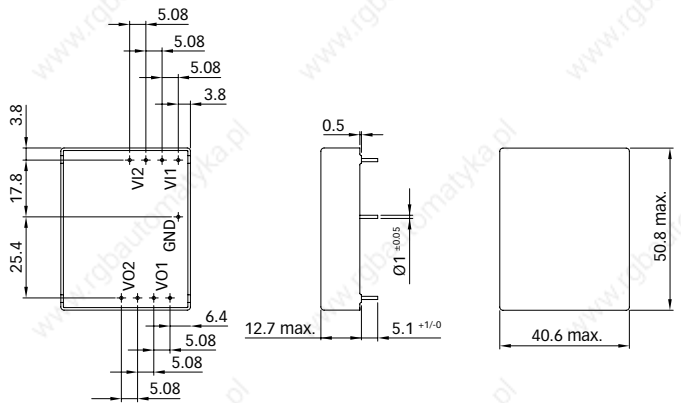

All dimensions in mm; 1 inch = 25.4mm
Tolerances according: ISO 2768-m / EN 22768-m

Application

The filters are intended to be used in DC applications per EN/IEC 60950, where no transient on the DC bus occurs. To protect the filter against transient voltages a varistor

(VDR, fig. 1) or a transient diode (fig. 2) must be placed at the input side of the filter module. For protection against overcurrent place a fuse on each input lead (VI+, VI-). When AC

voltage is superimposed on DC voltage, VP-P or VO-P, whichever is larger, should be maintained within the rated voltage range.

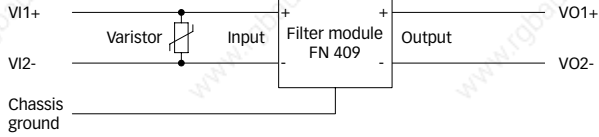

Figure 1: transient protection with a varistor

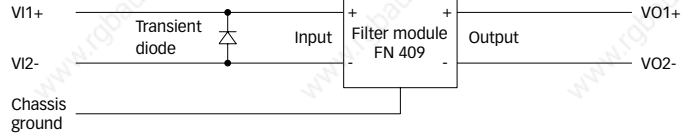
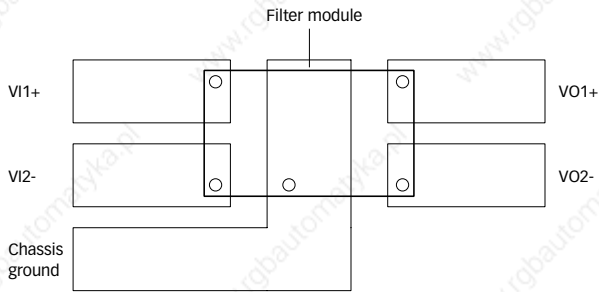

Figure 2: transient protection with a transient diode

Recommended layout



Note: avoid routing signal tracks or planes under the filter module

High Performance Two-stage PCB-mounting EMC Filter

SCHAFFNER
energy efficiency and reliability



- Rated currents from 0.5 to 6A
- High attenuation two-stage design
- PCB-mountable design

Approvals



ROHS

Technical specifications

Maximum continuous operating voltage:	250VAC, 50/60Hz
Operating frequency:	dc to 400Hz
Rated currents:	0.5 to 6A @ 40°C max.
High potential test voltage:	P → PE 2000VAC for 2 sec P → N 760VAC for 2 sec
Temperature range (operation and storage):	-25°C to +100°C (25/100/21)
Design corresponding to:	UL 1283, CSA 22.2 No. 8 1986, IEC/EN 60939
Flammability corresponding to:	UL 94V-2 or better
MTBF @ 40°C/230V (Mil-HB-217F):	675,000 hours

Typical electrical schematic

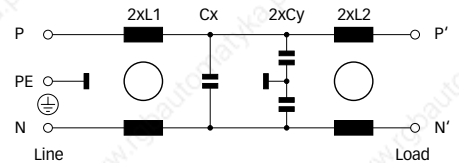

The FN 410 PCB filter is a single-phase, two-stage filter designed for easy and fast PCB-mounting. Choosing the FN 410 product line brings you the rapid availability of a standard high performance filter associated with the necessary safety acceptance. Standard PCB single-phase filters are a practical solution helping you to pass EMI system approval in a short time. A selection on amperage ratings are designed to offer you the desired standard product.

Features and benefits

- Very good conducted attenuation performance, based on chokes with high saturation resistance and excellent thermal behavior.
- Two-stage single-phase design.
- PCB through hole mounting.
- Custom specific versions on request.

Typical applications

- Electrical and electronic equipment
- Small to medium-sized machines and household equipment
- Single-phase power supplies, switch-mode power supplies
- Test and measurement equipment

Filter selection table

Filter	Rated current @ 40°C (25°C)	Leakage current* @ 230VAC/50Hz	Inductance		Capacitance		Resistance	Input/Output connections	Weight
	[A]	[μA]	L1 [mH]	L2 [mH]	Cx [nF]	Cy [nF]	R [kΩ]		
FN 410-0.5-02	0.5 (0.6)	373	24	24	33	2.2		-02	85
FN 410-1-02	1 (1.2)	373	10	10	33	2.2		-02	85
FN 410-3-02	3 (3.6)	373	2	2	33	2.2		-02	85
FN 410-6-02	6 (6.9)	373	0.8	0.8	33	2.2		-02	85

* Maximum leakage under normal operating conditions. Note: if the neutral line is interrupted, worst case leakage could reach twice this level.

Product selector

FN 410-yy-..

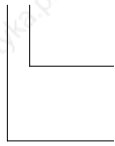

02: PCB through hole mounting

0.5 to 6: Rated current

For example: FN 410-0.5-02, FN 410-6-02

Typical filter attenuation

Per CISPR 17; A = 50Ω/50Ω sym; B = 50Ω/50Ω asym; C = 0.1Ω/100Ω sym; D = 100Ω/0.1Ω sym

0.5 and 1A types

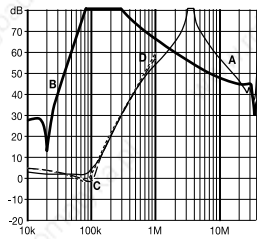

3 and 6A types

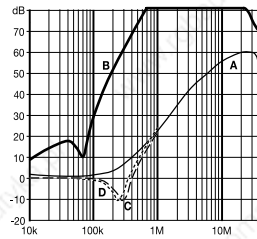

Mechanical data

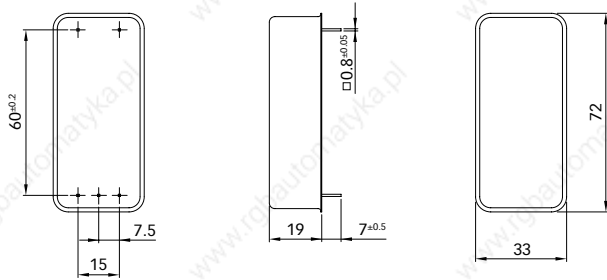

All dimensions in mm; 1 inch = 25.4mm
Tolerances according: ISO 2768-m / EN 22768-m





IEC Inlet Filters / Power Entry Modules

FN 9222	35	FN 9246	64
FN 9222E	40	FN 9260	67
FN 9226	44	FN 9263	70
FN 9233	47	FN 280	73
FN 9233E	52	FN 370	77
FN 9244	56	FN 380	81
FN 9244E	60	FN 390	84

IEC Inlet Filters / Power Entry Modules.

All the advantages of IEC connector, EMC/EMI filter, fuses, switch and voltage selector combined in a powerful compact all-in-one solution. Ideal for computers, monitors and office equipment like printers and copy machines.

Approvals *				Features		Typical applications														
Filter family	Max. voltage	Attenuation performance		With earth line choke	For fuse(s)	With switch	With voltage selector	IEC 60950-compliant	For PCB mounting	Snap-in version	Extra wide mounting	IT equipment	Medical equipment	Switch-mode power supplies	Office equipment	Prof. audio, TV, VCR	Telecommunication	Light industrial equipment	General purpose	
		standard	high																	very high
FN 9222 p. 35	250VAC	1	8	20																
FN 9222E p. 40	250VAC	1	8	15																
FN 9226 p. 44	250VAC	1	8	10																
FN 9233 p. 47	250VAC	1	8	15																
FN 9233E p. 52	250VAC	1	8	15																
FN 9244 p. 56	250VAC	1	8	15																
FN 9244E p. 60	250VAC	1	8	15																
FN 9246 p. 64	250VAC	1	8	20																
FN 9260 p. 67	250VAC	1	8	10																
FN 9263 p. 70	250VAC	1	8	10																
FN 280 p. 73	250VAC	1	8	10																
FN 370 p. 77	250VAC	2	6	6																
FN 380 p. 81	250VAC	2	6	6																
FN 390 FN 1390 p. 84	250VAC	1	8	10																

* Products evaluated by one or more of the above certification agencies. For details please consult the detailed data sheet.

General Performance IEC Inlet Filter



energy efficiency and reliability

- Rated currents up to 20A
- Excellent performance/size ratio
- Optional medical versions (B type) according to IEC/EN 60601-1
- Snap-in versions (S and S1 type)
- Hot inlet versions (HI type)
- Optional overvoltage protection (Z type)

Approvals



except HI-types



Technical specifications

Maximum continuous operating voltage:	250VAC, 50/60Hz
Operating frequency:	dc to 400Hz
Rated currents:	1 to 20A @ 50°C
Approvals by rated current:	1 to 10A (ENEC, CQC) 16A (ENEC, CQC) for 16 and 20A types 1 to 20A (UL, CSA)
High potential test voltage:	P → PE 2000VAC for 2 sec (standard types) P → PE 2500VAC for 2 sec (B types) P → N 1000VAC for 2 sec (1 to 10A types, not Z types) P → N 250VAC for 2 sec (all Z types) P → N 1100VDC for 2 sec (16 and 20A types, not Z types)
Protection category:	IP40 according to IEC 60529
Temperature range (operation and storage):	-25°C to +85°C (25/85/21)
Design corresponding to:	UL 1283, CSA 22.2 No. 8 1986, IEC/EN 60939 (X to XX A, not Z types)
Flammability corresponding to:	UL 94V-2 or better
Surge pulse protection (optional):	2kV, IEC 61000-4-5
MTBF @ 40°C/230V (Mil-HB-217F):	≤15A: 3,040,000 hours ≥16A: 2,256,000 hours

Typical electrical schematic

Standard, R and B types

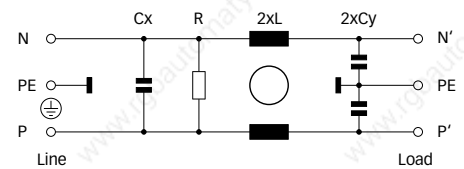

Z types

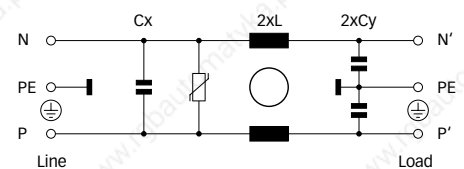

The FN 9222 IEC inlet filter combines an IEC inlet and mains filter with excellent filter attenuation in a small form factor. Choosing the FN 9222 product line brings you the rapid availability of a standard filter associated with the necessary safety acceptances. Standard IEC connector filters are a practical solution helping you to pass EMI system approval in a short time. A wide selection on amperage ratings, output connections, mounting possibilities and filters for medical applications are designed to offer you the desired solution.



Features and benefits

- Exceptional conducted attenuation performance, based on chokes with high saturation resistance and excellent thermal behavior.
- Rear/front or snap-in mounting.
- Wide mounting flanges available.
- Optional medical versions (B type) comply with the requirements of IEC/EN 60601-1 for creepage and clearance, leakage current and high potential testing.
- 12 and 15A types with hot inlet available.
- Optional surge pulse protection.
- Different output connections offering maximum flexibility for assembly.
- Custom-specific versions are available on request.

Typical applications

- Portable electrical and electronic equipment
- Small to medium-sized machines and household equipment
- Single-phase power supplies, switch-mode power supplies
- Test and measurement equipment
- Medical equipment
- Rack mounting equipment

Filter selection table

Filter	Rated current @ 50°C (25°C)	Leakage current* @ 250VAC/50Hz	Inductance L	Capacitance Cx Cy		Resistance R	Output connections		Weight
	[A]	[μA]	[mH]	[μF]	[nF]	[kΩ]			[g]
FN 9222x-1-..	1 (1.2)	373	12	0.1	2.2		-06	-07	40
FN 9222x-3-..	3 (3.5)	373	2.5	0.1	2.2		-06	-07	40
FN 9222x-6-..	6 (7.2)	373	0.78	0.1	2.2		-06	-07	40
FN 9222x-8-..	8 (10.6)	373	0.5	0.1	2.2		-06	-07	40
FN 9222x-10-..	10 (11.6)	373	0.225	0.1	2.2		-06	-07	40
FN 9222x-12-..	12 (12)	373	0.11	0.1	2.2		-06	-07	40
FN 9222x-15-..	15 (15)	373	0.075	0.1	2.2		-06	-07	40
FN 9222x-12-..HI	12 (12)	373	0.11	0.1	2.2		-06	-07	40
FN 9222x-15-..HI	15 (15)	373	0.075	0.1	2.2		-06	-07	40
FN 9222xR-1-..	1 (1.2)	373	12	0.1	2.2	1000	-06	-07	40
FN 9222xR-3-..	3 (3.5)	373	2.5	0.1	2.2	1000	-06	-07	40
FN 9222xR-6-..	6 (7.2)	373	0.78	0.1	2.2	1000	-06	-07	40
FN 9222xR-8-..	8 (10.6)	373	0.5	0.1	2.2	1000	-06	-07	40
FN 9222xR-10-..	10 (11.6)	373	0.225	0.1	2.2	1000	-06	-07	40
FN 9222xR-12-..	12 (12)	373	0.11	0.1	2.2	1000	-06	-07	40
FN 9222xR-15-..	15 (15)	373	0.075	0.1	2.2	1000	-06	-07	40
FN 9222xR-16-06	16 (18.5)	373	0.54	0.33	2.2	1000	-06		100
FN 9222xR-20-06	20 (23)	373	0.4	0.33	2.2	1000	-06		100
FN 9222xR-12-..HI	12 (12)	373	0.11	0.1	2.2	1000	-06	-07	40
FN 9222xR-15-..HI	15 (15)	373	0.075	0.1	2.2	1000	-06	-07	40
FN 9222xB-1-..	1 (1.2)	2	12	0.1		1000	-06	-07	40
FN 9222xB-3-..	3 (3.5)	2	2.5	0.1		1000	-06	-07	40
FN 9222xB-6-..	6 (7.2)	2	0.78	0.1		1000	-06	-07	40
FN 9222xB-8-..	8 (10.6)	2	0.5	0.1		1000	-06	-07	40
FN 9222xB-10-..	10 (11.6)	2	0.225	0.1		1000	-06	-07	40
FN 9222xB-12-..	12 (12)	2	0.11	0.1		1000	-06	-07	40
FN 9222xB-15-..	15 (15)	2	0.075	0.1		1000	-06	-07	40
FN 9222xB-16-06	16 (18.5)	2	0.54	0.33		1000	-06		100
FN 9222xB-20-06	20 (23)	2	0.4	0.33		1000	-06		100
FN 9222xB-12-..HI	12 (12)	2	0.11	0.1		1000	-06	-07	40
FN 9222xB-15-..HI	15 (15)	2	0.075	0.1		1000	-06	-07	40
FN 9222UZ-1-06	1 (1.2)	373	12	0.1	2.2		-06		43
FN 9222UZ-3-06	3 (3.5)	373	2.5	0.1	2.2		-06		43
FN 9222UZ-6-06	6 (7.2)	373	0.78	0.1	2.2		-06		43
FN 9222UZ-8-06	8 (10.6)	373	0.5	0.1	2.2		-06		43
FN 9222UZ-10-06	10 (11.6)	373	0.225	0.1	2.2		-06		43
FN 9222UZ-12-06	12 (12)	373	0.11	0.1	2.2		-06		43
FN 9222UZ-15-06	15 (15)	373	0.075	0.1	2.2		-06		43

* Maximum leakage under normal operating conditions. Note: if the neutral line is interrupted, worst case leakage could reach twice this level.

Product selector

FN 9222xx-yy-..HI-zz

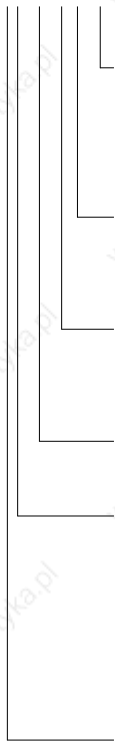

- Snap-in range for S version only
- Blank: Snap-in range 0.7 to 1.5mm
- 20: Snap-in range 1.5 to 2.2mm
- Blank: Standard IEC inlet type C14 (1 to 15A types), C20 (16 and 20A types)
- HI: Hot IEC inlet type C16 (12 and 15A types only)
- 06: Faston 6.3 x 0.8mm (spade/soldering)
- 07: Wire leads
- 1 to 20: Rated current
- Blank: Standard version
- R: Bleed resistor
- B: Medical version (with bleed resistor and without Y2-capacitor)
- Z: Optional surge pulse protection with additional varistor (MOV)
(Z types have longer housings, only available for FN 9222UZ-yy-06)
- Blank: Standard housing with mounting flanges
- U: Housing with wider mounting flanges
- S: Snap-in version, snapper on vertical side (1 to 15A types only)
- S1: Snap-in version, snapper on horizontal side (1 to 15A types only)

For example: FN 9222-15-07, FN 9222S1B-10-06-20, FN 9222R-12-06HI, FN 9222UZ-15-06

Typical filter attenuation

Per CISPR 17; A = 50Ω/50Ω sym; B = 50Ω/50Ω asym; C = 0.1Ω/100Ω sym; D = 100Ω/0.1Ω sym

1 and 3A types

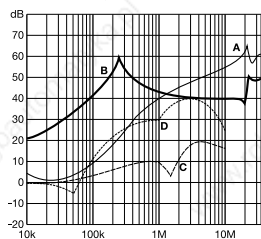

6 to 10A types

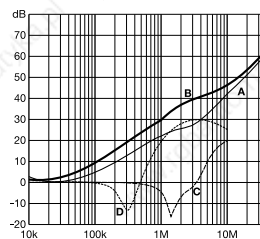

12 and 15A types

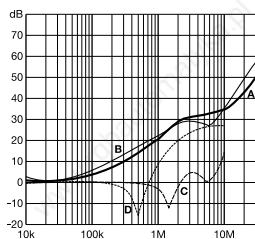

16 and 20A types

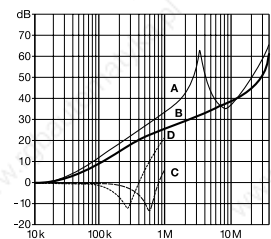

Mechanical data

FN 9222, 1 to 15A types

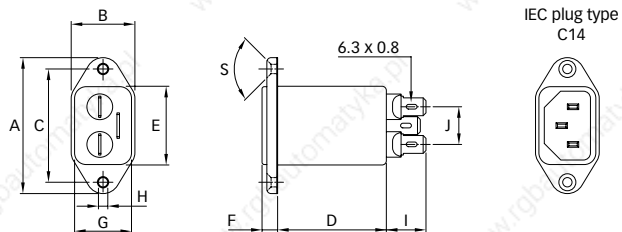

FN 9222, 16 and 20A types

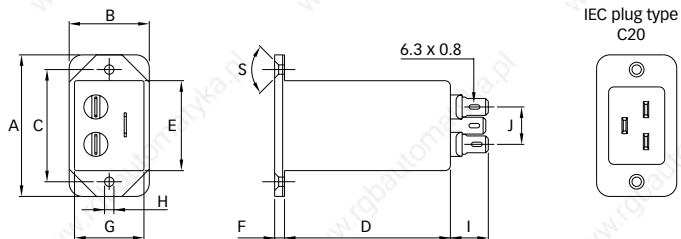

FN 9222S

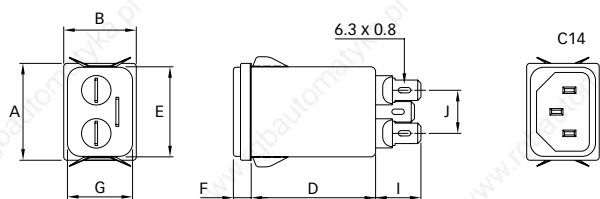

FN 9222S1

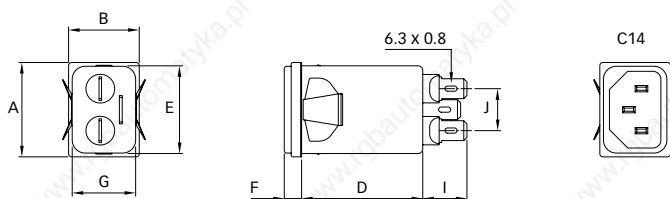

FN 9222-HI

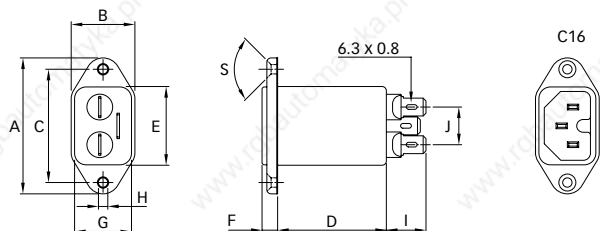

FN 9222U

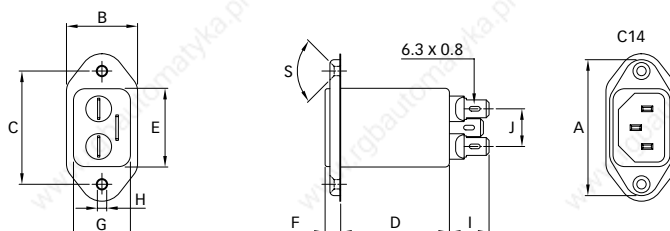

-07 connection style

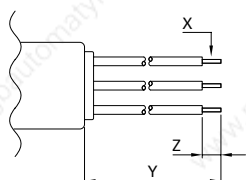

Installation

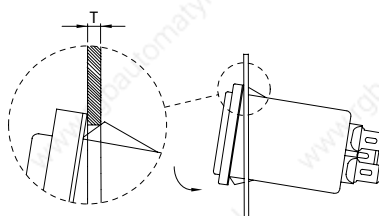

Panel cut out

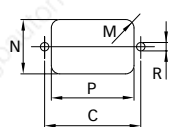

Dimensions

	FN 9222 1 to 8A	10 to 15A	16 and 20A	FN 9222U	FN 9222UZ	FN 9222S 1 to 8A	10 to 15A	FN 9222S1 1 to 8A	10 to 15A	FN 9222-HI 12 and 15A
A	48	48	53	51.85	51.85	29.9	29.9	29.9	29.9	48
B	22.5	22.5	30	25	25	22.4	22.4	22.4	22.4	22.5
C	40 ±0.2	40 ±0.2	42 ±0.2	40 ±0.2	40 ±0.2					40 ±0.2
D	38.4	38.4	66	38.25	46.8	38.4	38.4	38.4	38.4	38.4
E	27.8	27.8	34	27.8	27.8	27.8	27.8	27.8	27.8	27.8
F	5.5	5.5	4	5.5	5.5	5.5	5.5	5.5	5.5	5.5
G	20.1	20.1	26.5	20.1	20.1	20.1	20.1	20.1	20.1	20.1
H	Ø3.3	Ø3.3	Ø3.5	Ø3.3	Ø3.3					Ø3.3
I	14	14	14	14.1	14	14	14	14	14	14
J	13.3	13.3	13.3	13.3	13.3	13.3	13.3	13.3	13.3	13.3
M	R ≤ 3	R ≤ 3	R ≤ 3	R ≤ 3	R ≤ 3	R ≤ 1.5	R ≤ 1.5	R ≤ 1.5	R ≤ 1.5	R ≤ 3
N	21.5	21.5	27	21.5	21.5	20.8	20.8	21.9	21.9	21.5
P	28.5	28.5	34.7	28.5	28.5	29.4	29.4	28.5	28.5	28.5
R	M3	M3	M3	M3	M3					M3
S	90°	90°	90°	90°	90°					90°
T*						0.7 - 1.5	0.7 - 1.5	0.7 - 1.5	0.7 - 1.5	
T*						1.5 - 2.2	1.5 - 2.2	1.5 - 2.2	1.5 - 2.2	
X	AWG 18	AWG 16				AWG 18	AWG 16	AWG 18	AWG 16	AWG 16
Y	160	160				160	160	160	160	160
Z	6	6				6	6	6	6	6

* For selecting the panel thickness, please refer to the filter selection table.

All dimensions in mm; 1 inch = 25.4mm

Tolerances according: ISO 2768-m / EN 22768-m

General Performance IEC Inlet Filter with Earth Line Choke

SCHAFNER
energy efficiency and reliability



- Rated currents up to 15A
- Excellent performance/size ratio
- Integrated earth line choke
- Optional medical versions (B type) according to IEC/EN 60601-1
- Snap-in versions (S and S1 type)
- Optional wide mounting flanges

Approvals



except HI-types

ROHS

Technical specifications

Maximum continuous operating voltage:	250VAC, 50/60Hz
Operating frequency:	dc to 400Hz
Rated currents:	1 to 15A @ 50°C
Approvals by rated current:	1 to 10A (ENEC, CQC) 1 to 15A (UL, CSA)
High potential test voltage:	P → PE 2000VAC for 2 sec (standard types) P → PE 2500VAC for 2 sec (B types) P → N 1000VAC for 2 sec
Protection category:	IP40 according to IEC 60529
Temperature range (operation and storage):	-25°C to +85°C (25/85/21)
Design corresponding to:	UL 1283, CSA 22.2 No. 8 1986, IEC/EN 60939
Flammability corresponding to:	UL 94V-2 or better
MTBF @ 40°C/230V (Mil-HB-217F):	1,610,000 hours

Typical electrical schematic

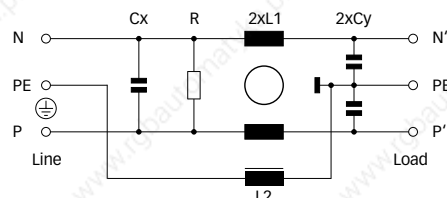

The FN 9222E IEC inlet filter combines an IEC inlet and mains filter with excellent filter attenuation in a small form factor and integrated earth line choke. Choosing the FN 9222E product line brings you the rapid availability of a standard filter associated with the necessary safety acceptances. Standard IEC connector filters are a practical solution helping you to pass EMI system approval in a short time. A wide selection on amperage ratings, output connections, mounting possibilities and filters for medical applications are designed to offer you the desired solution.

Features and benefits

- Exceptional conducted attenuation performance, based on chokes with high saturation resistance and excellent thermal behavior.
- Rear/front or snap-in mounting.
- Optional medical versions (B type) comply with the requirements of IEC/EN 60601-1 for creepage and clearance, leakage current and high potential testing.
- Wide mounting flanges available.
- Different output connections offering maximum flexibility for assembly.
- Without earth line choke see FN 9222 data sheet.
- Custom-specific versions are available on request.

Typical applications

- Portable electrical and electronic equipment
- Small to medium-sized machines and household equipment
- Single-phase power supplies, switch-mode power supplies
- Test and measurement equipment
- Medical equipment
- Rack mounting equipment

Filter selection table

Filter	Rated current @ 50°C (25°C) [A]	Leakage current* @ 250VAC/50Hz [μA]	Inductance		Capacitance		Resistance R [kΩ]	Output connections 	Weight [g]
			L1 [mH]	L2 [mH]	Cx [μF]	Cy [nF]			
FN 9222Ex-1-06	1 (1.2)	373	12	0.4	0.1	2.2		-06	46
FN 9222Ex-3-06	3 (3.5)	373	2.5	0.4	0.1	2.2		-06	46
FN 9222Ex-6-06	6 (7.2)	373	0.78	0.4	0.1	2.2		-06	46
FN 9222Ex-8-06	8 (10.6)	373	0.5	0.4	0.1	2.2		-06	46
FN 9222Ex-10-06	10 (11.6)	373	0.225	0.1	0.1	2.2		-06	46
FN 9222Ex-12-06	12 (12)	373	0.11	0.1	0.1	2.2		-06	46
FN 9222Ex-15-06	15 (15)	373	0.075	0.1	0.1	2.2		-06	46
FN 9222Ex-12-06HI	12 (12)	373	0.11	0.1	0.1	2.2		-06	46
FN 9222Ex-15-06HI	15 (15)	373	0.075	0.1	0.1	2.2		-06	46
FN 9222ExR-1-06	1 (1.2)	373	12	0.4	0.1	2.2	1000	-06	46
FN 9222ExR-3-06	3 (3.5)	373	2.5	0.4	0.1	2.2	1000	-06	46
FN 9222ExR-6-06	6 (7.2)	373	0.78	0.4	0.1	2.2	1000	-06	46
FN 9222ExR-8-06	8 (10.6)	373	0.5	0.4	0.1	2.2	1000	-06	46
FN 9222ExR-10-06	10 (11.6)	373	0.225	0.1	0.1	2.2	1000	-06	46
FN 9222ExR-12-06	12 (12)	373	0.11	0.1	0.1	2.2	1000	-06	46
FN 9222ExR-15-06	15 (15)	373	0.075	0.1	0.1	2.2	1000	-06	46
FN 9222ExR-12-06HI	12 (12)	373	0.11	0.1	0.1	2.2	1000	-06	46
FN 9222ExR-15-06HI	15 (15)	373	0.075	0.1	0.1	2.2	1000	-06	46
FN 9222ExB-1-06	1 (1.2)	2	12	0.4	0.1		1000	-06	46
FN 9222ExB-3-06	3 (3.5)	2	2.5	0.4	0.1		1000	-06	46
FN 9222ExB-6-06	6 (7.2)	2	0.78	0.4	0.1		1000	-06	46
FN 9222ExB-8-06	8 (10.6)	2	0.5	0.4	0.1		1000	-06	46
FN 9222ExB-10-06	10 (11.6)	2	0.225	0.1	0.1		1000	-06	46
FN 9222ExB-12-06	12 (12)	2	0.11	0.1	0.1		1000	-06	46
FN 9222ExB-15-06	15 (15)	2	0.075	0.1	0.1		1000	-06	46
FN 9222ExB-12-06HI	12 (12)	2	0.11	0.1	0.1		1000	-06	46
FN 9222ExB-15-06HI	15 (15)	2	0.075	0.1	0.1		1000	-06	46

* Maximum leakage under normal operating conditions. Note: if the neutral line is interrupted, worst case leakage could reach twice this level.

Product selector

FN 9222Exx-yy...HI-zz

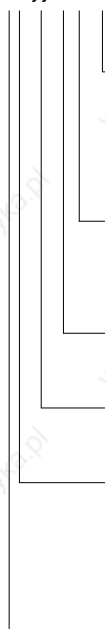

Snap-in range for S version only

Blank: Snap-in range 0.7 to 1.5mm

20: Snap-in range 1.5 to 2.2mm

Blank: Standard IEC inlet type C14

HI: Hot IEC inlet type C16 (12 and 15A types only)

06: Faston 6.3 x 0.8mm (spade/soldering)

1 to 15: Rated current

Blank: Standard version

R: Bleed resistor

B: Medical version (with bleed resistor and without Y2-capacitor)

 Blank: Standard housing with mounting flanges

 U: Housing with wider mounting flanges

 S: Snap-in version, snapper on vertical side

 S1: Snap-in version, snapper on horizontal side

For example: FN 9222E-15-06, FN 9222ES1B-10-06-20, FN 9222ER-12-06HI, FN 9222EUB-8-06-20

Typical filter attenuation

Per CISPR 17; A = 50Ω/50Ω sym; B = 50Ω/50Ω asym; C = 0.1Ω/100Ω sym; D = 100Ω/0.1Ω sym

1 and 3A types

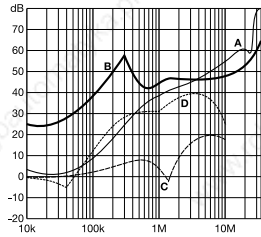

6 to 10A types

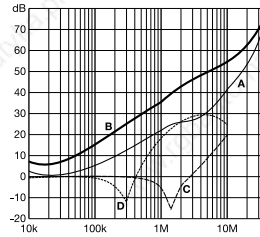

12 and 15A types

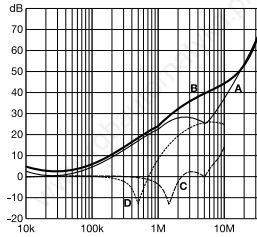

Mechanical data

FN 9222E

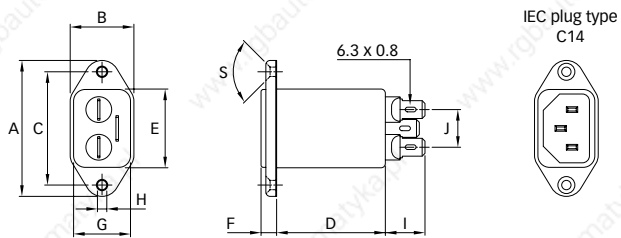

FN 9222E-HI

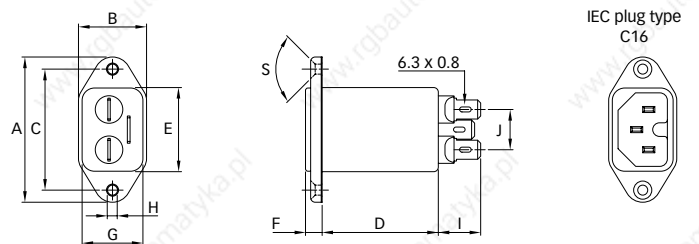

FN 9222ES

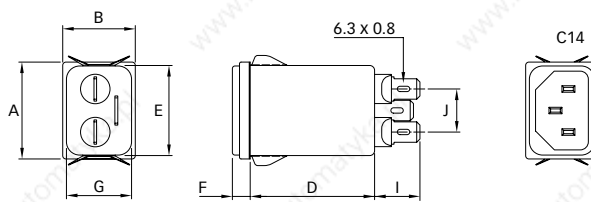

FN 9222ES1

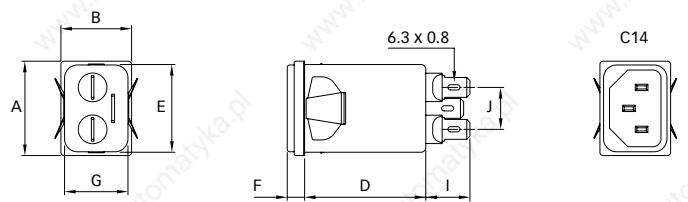

FN 9222EU

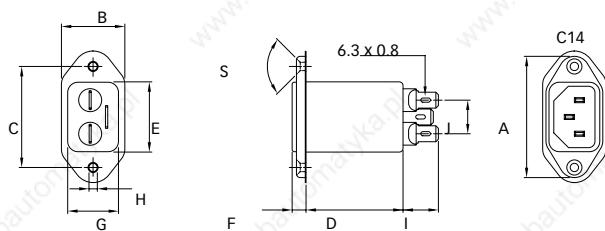

Installation

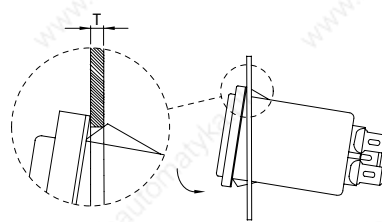

Panel cut out

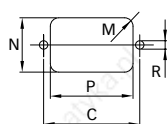

Dimensions

	FN 9222E	FN 9222EU	FN 9222ES	FN 9222ES1	FN 9222E-HI
A	48	53	29.9	29.9	48
B	22.5	30	22.4	22.4	22.5
C	40 ±0.2	40 ±0.2			40 ±0.2
D	46.8	46.8	46.8	46.8	46.8
E	27.8	27.8	27.8	27.8	27.8
F	5.5	5.5	5.5	5.5	5.5
G	20.1	20.1	20.1	20.1	20.1
H	Ø3.3	Ø3.3			Ø3.3
I	14	14	14	14	14
J	13.3	13.3	13.3	13.3	13.3
M	R ≤ 3	R ≤ 3	R ≤ 1.5	R ≤ 1.5	R ≤ 3
N	21.5	21.5	20.8	21.9	21.5
P	28.5	28.5	29.4	28.5	28.5
R	M3	M3			M3
S	90°	90°			90°
T*			0.7 - 1.5	0.7 - 1.5	
T*			1.5 - 2.2	1.5 - 2.2	

* For selecting the panel thickness, please refer to the filter selector table.

All dimensions in mm; 1 inch = 25.4mm

Tolerances according: ISO 2768-m / EN 22768-m

HF Performance IEC Inlet Filter



energy efficiency and reliability

- Rated currents up to 10A
- Faston connection
- Optional PCB through hole connection
- Good HF coupling to the equipment housing
- Optional medical versions (B type)

Approvals



Technical specifications

Maximum continuous operating voltage:	250VAC, 50/60Hz
Operating frequency:	dc to 400Hz
Rated currents:	1 to 10A @ 50°C
Approvals by rated current:	1 to 10A (ENEC, UL, CSA)
High potential test voltage:	P → PE 2000VAC for 2 sec (standard types) P → PE 2500VAC for 2 sec (B types) P → N 760VAC for 2 sec
Protection category:	IP40 according to IEC 60529
Temperature range (operation and storage):	-25°C to +85°C (25/85/21)
Design corresponding to:	UL 1283, CSA 22.2 No. 8 1986, IEC/EN 60939
Flammability corresponding to:	UL 94V-2 or better
MTBF @ 40°C/230V (Mil-HB-217F):	800,000 hours

Typical electrical schematic

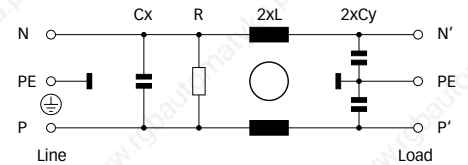

The FN 9226 IEC inlet filter combines an IEC inlet and mains filter with excellent filter attenuation in a small form factor. The FN 9226 is designed for printed circuit board mounting with good HF coupling to the equipment housing. Choosing the FN 9226 power entry module brings you the rapid availability of a standard filter associated with the necessary safety acceptances. Standard IEC connector filters are a practical solution helping you to pass EMI system approval in a short time. A wide selection on current ratings, output connections and low leakage versions for medical applications helps you to select the desired solution for your application.



Features and benefits

- High conducted attenuation performance, based on chokes with high saturation resistance and excellent thermal behavior.
- Rear flange mounting.
- Optional low leakage current versions for medical applications.
- Faston connection or PCB through hole pins.
- Good HF coupling.
- Rated currents up to 10A.
- Custom-specific versions are available on request.

Typical applications

- Portable electrical and electronic equipment
- Small to medium-sized machines and household equipment
- Single-phase power supplies, switch-mode power supplies
- Consumer goods
- Test and measurement equipment
- EDP and office equipment
- Medical equipment
- Rack mounting equipment

Filter selection table

Filter	Rated current @ 40°C (25°C)	Leakage current* @ 230VAC/50Hz	Inductance L	Capacitance		Resistance R	Output connections		Weight
	[A]	[μA]	[mH]	Cx [nF]	Cy [nF]	[kΩ]			[g]
FN 9226-1-..	1 (1.2)	373	4.65	47.0	2.2		-02	-06	40
FN 9226-3-..	3 (3.5)	373	1.24	47.0	2.2		-02	-06	40
FN 9226-6-..	6 (7.2)	373	0.52	47.0	2.2		-02	-06	40
FN 9226-10-..	10 (11.6)	373	0.27	47.0	2.2		-02	-06	40
FN 9226B-1-..	1 (1.2)	2	4.65	47.0		2200	-02	-06	40
FN 9226B-3-..	3 (3.5)	2	1.24	47.0		2200	-02	-06	40
FN 9226B-6-..	6 (7.2)	2	0.52	47.0		2200	-02	-06	40
FN 9226B-10-..	10 (11.6)	2	0.27	47.0		2200	-02	-06	40

* Maximum leakage under normal operating conditions. Note: if the neutral line is interrupted, worst case leakage could reach twice this level.

Product selector

FN 9226x-yy-..

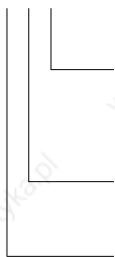

- 02: PCB through hole mounting
- 06: Faston 6.3 x 0.8mm (spade/soldering)

- 1 to 10: Rated current

- Blank: Standard version
- B: Medical version (with bleed resistor and without Y2-capacitor)

For example: FN 9226-6-02, FN 9226B-10-06

Typical filter attenuation

Per CISPR 17; A = 50Ω/50Ω sym; B = 50Ω/50Ω asym; C = 0.1Ω/100Ω sym; D = 100Ω/0.1Ω sym

1 and 3A types

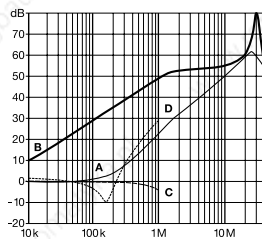

6 and 10A types

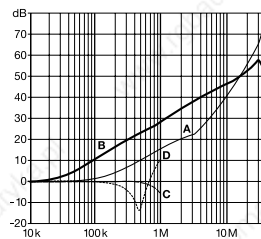

Mechanical data

Connection style -02

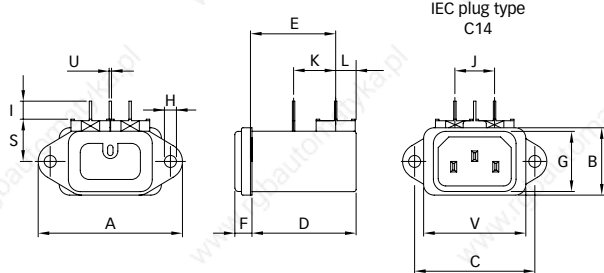

Connection style -06

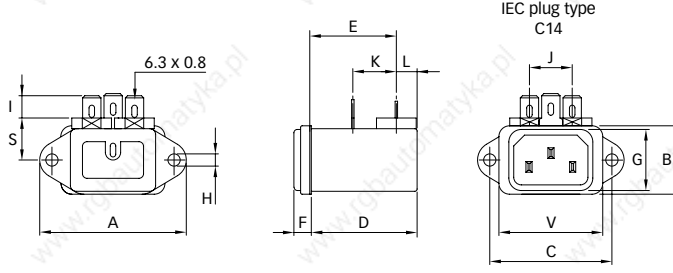

Panel cut out

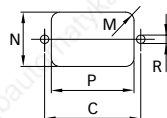

Dimensions

	FN 9226 Connection style -02	FN 9226 Connections style -06	Tolerances
A	48	48	±0.5
B	22.4	22.4	±0.3
C	40	40	±0.2
D	35.15	35.15	±0.3
E	28.35	28.35	±0.3
F	5.7	5.7	±0.3
G	20	20	±0.3
H	Ø4	Ø4	
I	6	7.3	
J	13.2	13.2	+0.6/-0
K	14	14.25	±0.5
L	6.8	6.8	±0.3
M	R ≤ 3.5	R ≤ 3.5	
N	22.6	22.6	+0.2/-0
P	34.4	34.4	+0.2/-0
R	Ø3.5	Ø3.5	
S	14	14	
U	∇0.8		±0.1
V	34	34	±0.3

All dimensions in mm; 1 inch = 25.4mm
Tolerances according: ISO 2768-m / EN 22768-m

High Performance IEC Inlet Filter

SCHAFNER
energy efficiency and reliability



- Rated currents up to 15A
- Excellent attenuation performance
- Optional medical versions (B type) according to IEC/EN 60601-1
- Snap-in versions (S and S1 type)
- Hot inlet versions (HI type)

Approvals

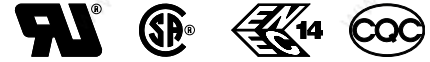

ROHS

Technical specifications

Maximum continuous operating voltage:	250VAC, 50/60Hz
Operating frequency:	dc to 400Hz
Rated currents:	1 to 15A @ 50°C
Approvals by rated current:	1 to 10A (ENEC, CQC) 1 to 15A (UL, CSA)
High potential test voltage:	P → PE 2000VAC for 2 sec (standard types) P → PE 2500VAC for 2 sec (B types) P → N 1000VAC for 2 sec
Protection category:	IP40 according to IEC 60529
Temperature range (operation and storage):	-25°C to +85°C (25/85/21)
Design corresponding to:	UL 1283, CSA 22.2 No. 8 1986, IEC/EN 60939
Flammability corresponding to:	UL 94V-2 or better
MTBF @ 40°C/230V (Mil-HB-217F):	2,540,000 hours

Typical electrical schematic

Standard, R and B types

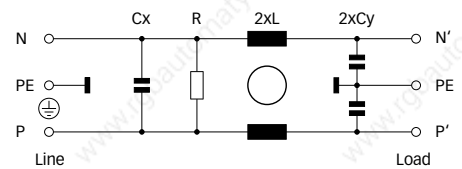

F2 types

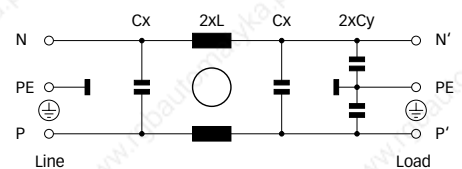

The FN 9233 IEC inlet filter combines an excellent IEC inlet and mains filter with excellent filter attenuation in a small form factor. Choosing the FN 9233 product line brings you the rapid availability of a standard filter associated with the necessary safety acceptances. Standard IEC connector filters are a practical solution helping you to pass EMI system approval in a short time. A wide selection on amperage ratings, output connections, mounting possibilities and filters for medical applications are designed to offer you the desired solution. For types with additional earth line choke please consult the FN 9233E data sheet.

Features and benefits

- Exceptional conducted attenuation performance, based on chokes with high saturation resistance and excellent thermal behavior.
- Rear/front or snap-in mounting.
- Optional earth line choke see FN 9233E data sheet.
- Optional medical versions (B type) comply with the requirements of IEC/EN 60601-1 for creepage and clearance, leakage current and high potential testing.
- Wide mounting flanges available.
- Different output connections offering maximum flexibility for assembly.
- Custom-specific versions are available on request.

Typical applications

- Portable electrical and electronic equipment
- Small to medium-sized machines and household equipment
- Single-phase power supplies, switch-mode power supplies
- Test and measurement equipment
- Medical equipment
- Rack mounting equipment

Filter selection table

Filter	Rated current @ 50°C (25°C)	Leakage current* @ 250VAC/50Hz	Inductance L	Cx1	Capacitance		Resistance R	Output connections 	Weight [g]
	[A]	[µA]	[mH]		[µF]	[nF]			
FN 9233x-1-06	1 (1.2)	373	22.5	0.1		2.2		-06	37
FN 9233x-3-06	3 (3.5)	373	4.6	0.1		2.2		-06	37
FN 9233x-6-06	6 (7.2)	373	1.6	0.1		2.2		-06	37
FN 9233x-8-06	8 (10.6)	373	0.9	0.1		2.2		-06	37
FN 9233x-10-06	10 (11.6)	373	0.45	0.1		2.2		-06	37
FN 9233x-12-06	12 (12)	373	0.27	0.1		2.2		-06	37
FN 9233x-15-06	15 (15)	373	0.2	0.1		2.2		-06	37
FN 9233x-12-06HI	12 (12)	373	0.27	0.1		2.2		-06	37
FN 9233x-15-06HI	15 (15)	373	0.2	0.1		2.2		-06	37
FN 9233xR-1-06	1 (1.2)	373	22.5	0.1		2.2	1000	-06	37
FN 9233xR-3-06	3 (3.5)	373	4.6	0.1		2.2	1000	-06	37
FN 9233xR-6-06	6 (7.2)	373	1.6	0.1		2.2	1000	-06	37
FN 9233xR-8-06	8 (10.6)	373	0.9	0.1		2.2	1000	-06	37
FN 9233xR-10-06	10 (11.6)	373	0.45	0.1		2.2	1000	-06	37
FN 9233xR-12-06	12 (12)	373	0.27	0.1		2.2	1000	-06	37
FN 9233xR-15-06	15 (15)	373	0.2	0.1		2.2	1000	-06	37
FN 9233xR-12-06HI	12 (12)	373	0.27	0.1		2.2	1000	-06	37
FN 9233xR-15-06HI	15 (15)	373	0.2	0.1		2.2	1000	-06	37
FN 9233xB-1-06	1 (1.2)	2	22.5	0.1			1000	-06	37
FN 9233xB-3-06	3 (3.5)	2	4.6	0.1			1000	-06	37
FN 9233xB-6-06	6 (7.2)	2	1.6	0.1			1000	-06	37
FN 9233xB-8-06	8 (10.6)	2	0.9	0.1			1000	-06	37
FN 9233xB-10-06	10 (11.6)	2	0.45	0.1			1000	-06	37
FN 9233xB-12-06	12 (12)	2	0.27	0.1			1000	-06	37
FN 9233xB-15-06	15 (15)	2	0.2	0.1			1000	-06	37
FN 9233xB-12-06HI	12 (12)	2	0.27	0.1			1000	-06	37
FN 9233xB-15-06HI	15 (15)	2	0.2	0.1			1000	-06	37
FN 9233UF2-1-06	1 (1.2)	560	22.5	0.047	0.047	3.3		-06	46
FN 9233UF2-3-06	3 (3.5)	560	4.6	0.047	0.047	3.3		-06	46
FN 9233UF2-6-06	6 (7.2)	560	1.6	0.047	0.047	3.3		-06	46
FN 9233UF2-8-06	8 (10.6)	560	0.9	0.047	0.047	3.3		-06	46
FN 9233UF2-10-06	10 (11.6)	560	0.45	0.047	0.047	3.3		-06	46
FN 9233UF2-12-06	12 (12)	560	0.27	0.047	0.047	3.3		-06	46
FN 9233UF2-15-06	15 (15)	560	0.2	0.047	0.047	3.3		-06	46

* Maximum leakage under normal operating conditions. Note: if the neutral line is interrupted, worst case leakage could reach twice this level.

Product selector

FN 9233xx-yy-..HI-zz

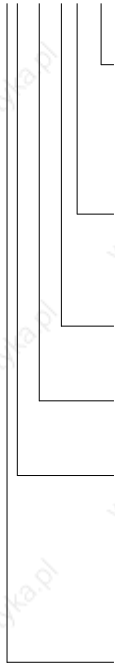

- Snap-in range for S version only
- Blank: Snap-in range 0.7 to 1.5mm
- 20: Snap-in range 1.5 to 2.2mm
- Blank: Standard IEC inlet type C14
- HI: Hot IEC inlet type C16 (12 and 15A types only)
- 06: Faston 6.3 x 0.8mm (spade/soldering)
- 1 to 15: Rated current
- Blank: Standard version
- R: Bleed resistor
- B: Medical version (with bleed resistor and without Y2-capacitor)
- F2: 2 X-capacitors and higher Y-capacitor value

- Blank: Standard housing with mounting flanges
- U: Housing with wider mounting flanges
- S: Snap-in version, snapper on vertical side
- S1: Snap-in version, snapper on horizontal side

For example: FN 9233-15-06, FN 9233S1B-10-06-20, FN 9233R-12-06HI

Typical filter attenuation

Per CISPR 17; A = 50Ω/50Ω sym; B = 50Ω/50Ω asym; C = 0.1Ω/100Ω sym; D = 100Ω/0.1Ω sym

FN 9233: 1 and 3A types

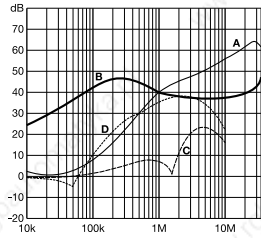

FN 9233: 6 to 10A types

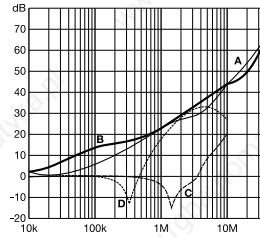

FN 9233: 12 and 15A types

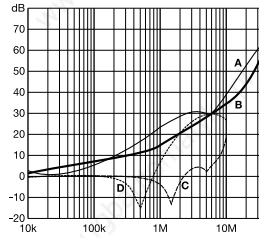

FN 9233UF2: 1 and 3A types

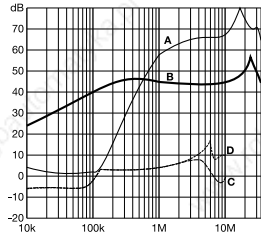

FN 9233UF2: 6 to 10A types

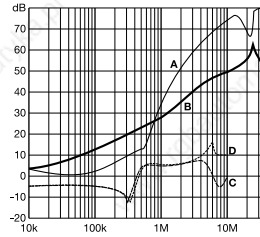

FN 9233UF2: 12 and 15A types

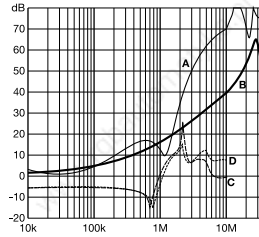

Mechanical data

FN 9233

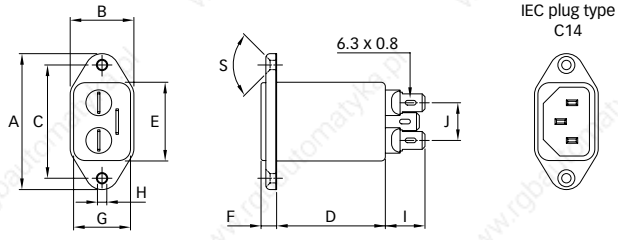

FN 9233-HI

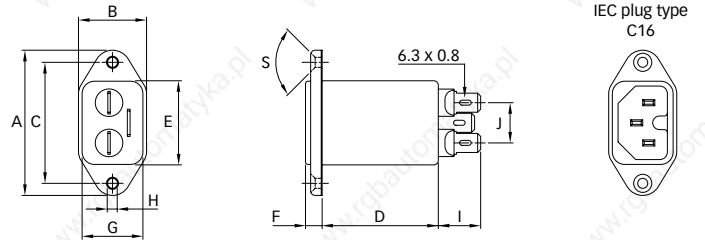

FN 9233S

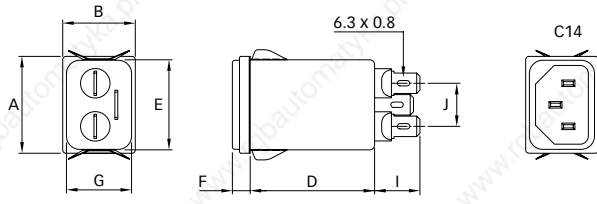

FN 9233S1

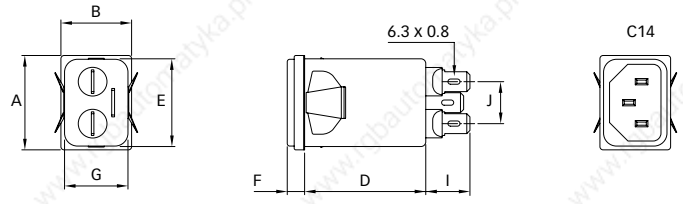

FN 9233U

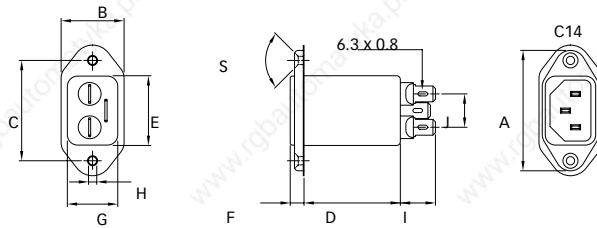

Installation

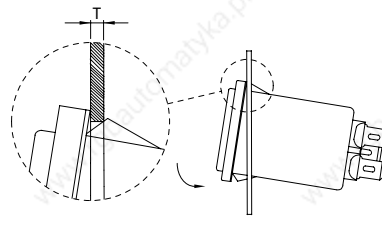

Panel cut out

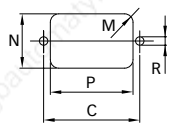

Dimensions

	FN 9233	FN 9233U	FN 9233UF2	FN 9233S	FN 9233S1	FN 9233-HI
A	48	51.85	51.85	29.9	29.9	48
B	22.5	25	25	22.4	22.4	22.5
C	40 ±0.2	40 ±0.2	40 ±0.2			40 ±0.2
D	38.4	38.25	46.8	38.4	38.4	38.4
E	27.8	27.8	27.8	27.8	27.8	27.8
F	5.5	5.5	5.5	5.5	5.5	5.5
G	20.1	20.1	20.1	20.1	20.1	20.1
H	Ø3.3	Ø3.3	Ø3.3			Ø3.3
I	14	14.1	14	14	14	14
J	13.3	13.3	13.3	13.3	13.3	13.3
M	R ≤ 3	R ≤ 3	R ≤ 3	R ≤ 1.5	R ≤ 1.5	R ≤ 3
N	21.5	21.5	21.5	20.8	21.9	21.5
P	28.5	28.5	28.5	29.4	28.5	28.5
R	M3	M3	M3			M3
S	90°	90°	90°			90°
T*				0.7 - 1.5	0.7 - 1.5	
T*				1.5 - 2.2	1.5 - 2.2	

* For selecting the panel thickness, please refer to the filter selector table.

All dimensions in mm; 1 inch = 25.4mm

Tolerances according: ISO 2768-m / EN 22768-m

High Performance IEC Inlet Filter with Earth Line Choke

SCHAFFNER
energy efficiency and reliability



- Rated currents up to 15A
- Excellent attenuation performance
- Integrated earth line choke
- Optional medical versions (B type) according to IEC/EN 60601-1
- Snap-in versions (S and S1 type)
- Hot inlet versions (HI type)

Approvals

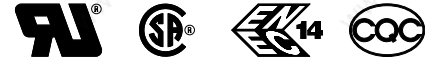

ROHS

Technical specifications

Maximum continuous operating voltage:	250VAC, 50/60Hz
Operating frequency:	dc to 400Hz
Rated currents:	1 to 15A @ 50°C
Approvals by rated current:	1 to 10A (ENEC, CQC) 1 to 15A (UL, CSA)
High potential test voltage:	P → PE 2000VAC for 2 sec (standard types) P → PE 2500VAC for 2 sec (B types) P → N 1000VAC for 2 sec
Protection category:	IP40 according to IEC 60529
Temperature range (operation and storage):	-25°C to +85°C (25/85/21)
Design corresponding to:	UL 1283, CSA 22.2 No. 8 1986, IEC/EN 60939
Flammability corresponding to:	UL 94V-2 or better
MTBF @ 40°C/230V (Mil-HB-217F):	1,710,000 hours

Typical electrical schematic

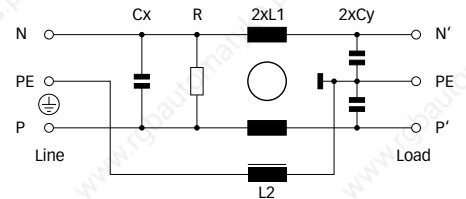

The FN 9233E IEC inlet filter combines an IEC inlet and mains filter with excellent filter attenuation in a small form factor. The FN 9233E high performance power entry module offers additional EMI suppression on the earth line. Choosing the FN 9233E product line brings you the rapid availability of a standard filter associated with the necessary safety acceptances. Standard IEC connector filters are a practical solution helping you to pass EMI system approval in a short time. A wide selection on amperage ratings, output connections, mounting possibilities and filters for medical applications are designed to offer you the desired solution. For types without additional earth line choke please consult the FN 9233 data sheet.

Features and benefits

- Exceptional conducted attenuation performance, based on chokes with high saturation resistance and excellent thermal behavior.
- Rear/front or snap-in mounting.
- Without earth line choke see FN 9233 data sheet.
- Optional medical versions (B type) comply with the requirements of IEC/EN 60601-1 for creepage and clearance, leakage current and high potential testing.
- Wide mounting flanges available.
- Different output connections offering maximum flexibility for assembly.
- Custom-specific versions are available on request.

Typical applications

- Portable electrical and electronic equipment
- Small to medium-sized machines and household equipment
- Single-phase power supplies, switch-mode power supplies
- Test and measurement equipment
- Medical equipment
- Rack mounting equipment











Filter selection table

Filter	Rated current @ 50°C (25°C)	Leakage current* @ 250VAC/50Hz	Inductance		Capacitance		Resistance R	Output connections 	Weight [g]
	[A]	[µA]	L1 [mH]	L2 [mH]	Cx [µF]	Cy [nF]			
FN 9233Ex-1-06	1 (1.2)	373	22.5	0.4	0.1	2.2		-06	46
FN 9233Ex-3-06	3 (3.5)	373	4.6	0.4	0.1	2.2		-06	46
FN 9233Ex-6-06	6 (7.2)	373	1.6	0.4	0.1	2.2		-06	46
FN 9233Ex-8-06	8 (10.6)	373	0.9	0.4	0.1	2.2		-06	46
FN 9233Ex-10-06	10 (11.6)	373	0.45	0.4	0.1	2.2		-06	46
FN 9233Ex-12-06	12 (12)	373	0.27	0.1	0.1	2.2		-06	46
FN 9233Ex-15-06	15 (15)	373	0.2	0.1	0.1	2.2		-06	46
FN 9233Ex-12-06HI	12 (12)	373	0.27	0.1	0.1	2.2		-06	46
FN 9233Ex-15-06HI	15 (15)	373	0.2	0.1	0.1	2.2		-06	46
FN 9233ExR-1-06	1 (1.2)	373	22.5	0.4	0.1	2.2	1000	-06	46
FN 9233ExR-3-06	3 (3.5)	373	4.6	0.4	0.1	2.2	1000	-06	46
FN 9233ExR-6-06	6 (7.2)	373	1.6	0.4	0.1	2.2	1000	-06	46
FN 9233ExR-8-06	8 (10.6)	373	0.9	0.4	0.1	2.2	1000	-06	46
FN 9233ExR-10-06	10 (11.6)	373	0.45	0.4	0.1	2.2	1000	-06	46
FN 9233ExR-12-06	12 (12)	373	0.27	0.1	0.1	2.2	1000	-06	46
FN 9233ExR-15-06	15 (15)	373	0.2	0.1	0.1	2.2	1000	-06	46
FN 9233ExR-12-06HI	12 (12)	373	0.27	0.1	0.1	2.2	1000	-06	46
FN 9233ExR-15-06HI	15 (15)	373	0.2	0.1	0.1	2.2	1000	-06	46
FN 9233ExB-1-06	1 (1.2)	2	22.5	0.4	0.1		1000	-06	46
FN 9233ExB-3-06	3 (3.5)	2	4.6	0.4	0.1		1000	-06	46
FN 9233ExB-6-06	6 (7.2)	2	1.6	0.4	0.1		1000	-06	46
FN 9233ExB-8-06	8 (10.6)	2	0.9	0.4	0.1		1000	-06	46
FN 9233ExB-10-06	10 (11.6)	2	0.45	0.4	0.1		1000	-06	46
FN 9233ExB-12-06	12 (12)	2	0.27	0.1	0.1		1000	-06	46
FN 9233ExB-15-06	15 (15)	2	0.2	0.1	0.1		1000	-06	46
FN 9233ExB-12-06HI	12 (12)	2	0.27	0.1	0.1		1000	-06	46
FN 9233ExB-15-06HI	15 (15)	2	0.2	0.1	0.1		1000	-06	46

* Maximum leakage under normal operating conditions. Note: if the neutral line is interrupted, worst case leakage could reach twice this level.

Product selector

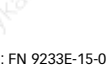
FN 9233Exx-yy-...HI-zz

	Snap-in range for S version only
Blank:	Snap-in range 0.7 to 1.5mm
20:	Snap-in range 1.5 to 2.2mm
	Standard IEC inlet type C14
HI:	Hot IEC inlet type C16 (12 and 15A types only)
	Faston 6.3 x 0.8mm (spade/soldering)
	1 to 15: Rated current
	Blank: Standard version
	R: Bleed resistor
	B: Medical version (with bleed resistor and without Y2-capacitor)
	Blank: Standard housing with mounting flanges
	U: Housing with wider mounting flanges
	S: Snap-in version, snapper on vertical side
	S1: Snap-in version, snapper on horizontal side

For example: FN 9233E-15-06, FN 9233ES1B-10-06-20, FN 9233ER-12-06HI, FN 9233EUB-8-06-20

Typical filter attenuation

Per CISPR 17; A = 50Ω/50Ω sym; B = 50Ω/50Ω asym; C = 0.1Ω/100Ω sym; D = 100Ω/0.1Ω sym

1 and 3A types

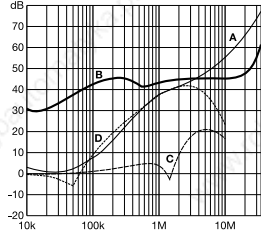

6 to 10A types

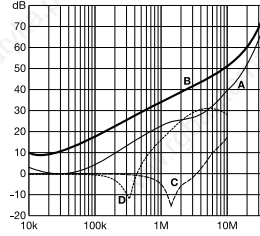

12 and 15A types

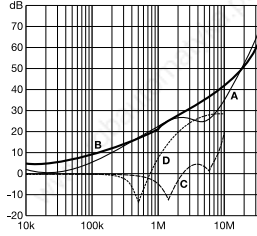

Mechanical data

FN 9233E

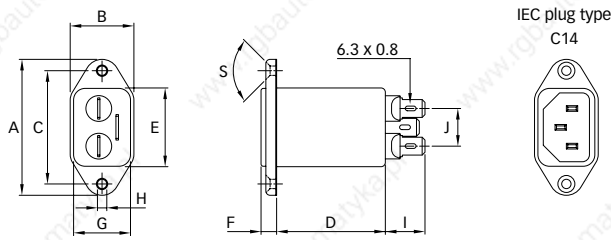

FN 9233E-HI

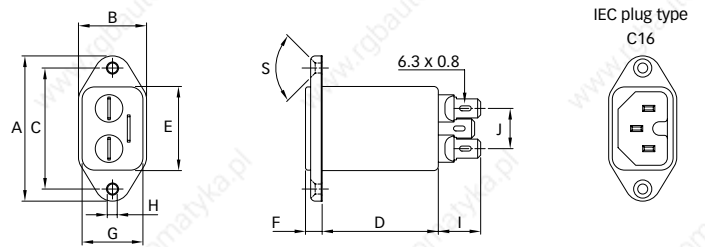

FN 9233ES

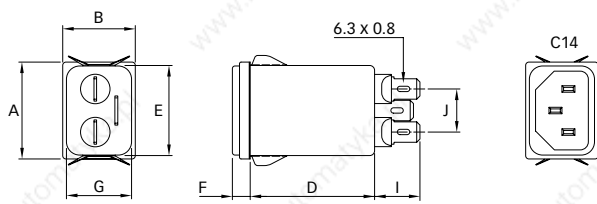

FN 9233ES1

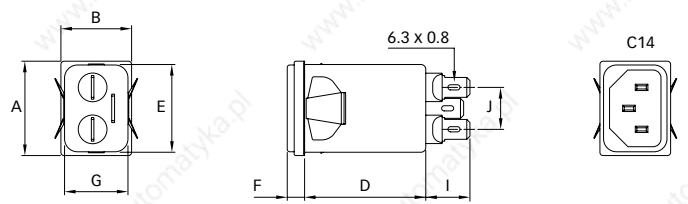

FN 9233EU

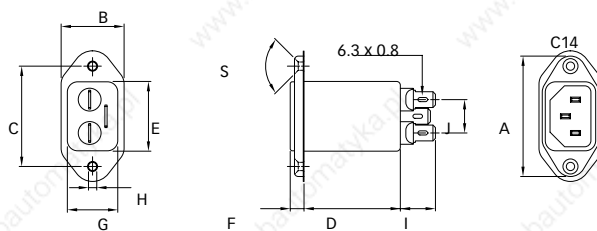

Installation

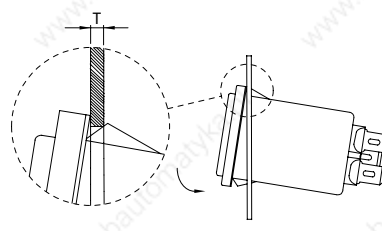

Panel cut out

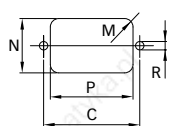

Dimensions

	FN 9233E	FN 9233EU	FN 9233ES	FN 9233ES1	FN 9233E-HI
A	48	51.85	29.9	29.9	48
B	22.5	25	22.4	22.4	22.5
C	40 ±0.2	40 ±0.2			40 ±0.2
D	46.8	46.8	46.8	46.8	46.8
E	27.8	27.8	27.8	27.8	27.8
F	5.5	5.5	5.5	5.5	5.5
G	20.1	20.1	20.1	20.1	20.1
H	Ø3.3	Ø3.3			Ø3.3
I	14	14.1	14	14	14
J	13.3	13.3	13.3	13.3	13.3
M	R ≤ 3	R ≤ 3	R ≤ 1.5	R ≤ 1.5	R ≤ 3
N	21.5	21.5	20.8	21.9	21.5
P	28.5	28.5	29.4	28.5	28.5
R	M3	M3			M3
S	90°	90°			90°
T*			0.7 - 1.5	0.7 - 1.5	
T*			1.5 - 2.2	1.5 - 2.2	

* For selecting the panel thickness, please refer to the filter selector table.

All dimensions in mm; 1 inch = 25.4mm

Tolerances according: ISO 2768-m / EN 22768-m

Excellent Performance IEC Inlet Filter



energy efficiency and reliability

- Rated currents up to 15A
- Superior attenuation performance
- Optional medical versions (B type) according to IEC/EN 60601-1
- Snap-in versions (S and S1 type)
- Hot inlet versions (HI type)

Approvals

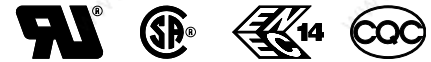

Technical specifications

Maximum continuous operating voltage:	250VAC, 50/60Hz
Operating frequency:	dc to 400Hz
Rated currents:	1 to 15A @ 50°C
Approvals by rated current:	1 to 10A (ENEC, CQC) 1 to 15A (UL, CSA)
High potential test voltage:	P → PE 2000VAC for 2 sec (standard types) P → PE 2500VAC for 2 sec (B types) P → N 1000VAC for 2 sec
Protection category:	IP40 according to IEC 60529
Temperature range (operation and storage):	-25°C to +85°C (25/85/21)
Design corresponding to:	UL 1283, CSA 22.2 No. 8 1986, IEC/EN 60939
Flammability corresponding to:	UL 94V-2 or better
MTBF @ 40°C/230V (Mil-HB-217F):	≤8A: 2,035,000 hours ≤15A: 1,035,000 hours

Typical electrical schematic

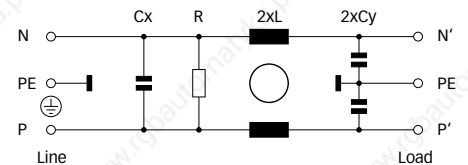

The FN 9244 IEC inlet filter combines an IEC inlet and mains filter with superior filter attenuation in a small form factor. Choosing the FN 9244 product line brings you the rapid availability of a standard filter associated with the necessary safety acceptances. Standard IEC connector filters are a practical solution helping you to pass EMI system approval in a short time. A wide selection on amperage ratings, output connections, mounting possibilities and filters for medical applications are designed to offer you the desired solution.

Features and benefits

- Exceptional conducted attenuation performance, based on chokes with high saturation resistance and excellent thermal behavior.
- Rear/front or snap-in mounting.
- Standard or wide mounting flange.
- Optional medical versions (B type) comply with the requirements of IEC/EN 60601-1 for creepage and clearance, leakage current and high potential testing.
- Optional earth line choke see FN 9244E data sheet.
- Custom-specific versions are available on request.

Typical applications

- Portable electrical and electronic equipment
- Small to medium-sized machines and household equipment
- Single-phase power supplies, switch-mode power supplies
- Test and measurement equipment
- Medical devices (MDD)
- In-vitro diagnostic medical devices (IVDD)
- Rack mounting equipment

Filter selection table

Filter	Rated current @ 50°C (25°C)	Leakage current* @ 250VAC/50Hz	Inductance L	Capacitance Cx Cy		Resistance R	Output connections	Weight
	[A]	[µA]	[mH]	[µF]	[nF]	[kΩ]		[g]
FN 9244x-1-06	1 (1.2)	373	59.53	0.1	2.2		-06	38
FN 9244x-3-06	3 (3.5)	373	13.45	0.1	2.2		-06	38
FN 9244x-6-06	6 (7.2)	373	4.1	0.1	2.2		-06	38
FN 9244x-8-06	8 (10.6)	373	2.3	0.1	2.2		-06	38
FN 9244x-10-06	10 (11.6)	373	1.02	0.1	2.2		-06	38
FN 9244x-12-06	12 (12)	373	0.58	0.1	2.2		-06	38
FN 9244x-15-06	15 (15)	373	0.4	0.1	2.2		-06	38
FN 9244x-12-06HI	12 (12)	373	0.58	0.1	2.2		-06	38
FN 9244x-15-06HI	15 (15)	373	0.4	0.1	2.2		-06	38
FN 9244xR-1-06	1 (1.2)	373	59.53	0.1	2.2	1000	-06	38
FN 9244xR-3-06	3 (3.5)	373	13.45	0.1	2.2	1000	-06	38
FN 9244xR-6-06	6 (7.2)	373	4.1	0.1	2.2	1000	-06	38
FN 9244xR-8-06	8 (10.6)	373	2.3	0.1	2.2	1000	-06	38
FN 9244xR-10-06	10 (11.6)	373	1.02	0.1	2.2	1000	-06	38
FN 9244xR-12-06	12 (12)	373	0.58	0.1	2.2	1000	-06	38
FN 9244xR-15-06	15 (15)	373	0.4	0.1	2.2	1000	-06	38
FN 9244xR-12-06HI	12 (12)	373	0.58	0.1	2.2	1000	-06	38
FN 9244xR-15-06HI	15 (15)	373	0.4	0.1	2.2	1000	-06	38
FN 9244xB-1-06	1 (1.2)	2	59.53	0.1		1000	-06	38
FN 9244xB-3-06	3 (3.5)	2	13.45	0.1		1000	-06	38
FN 9244xB-6-06	6 (7.2)	2	4.1	0.1		1000	-06	38
FN 9244xB-8-06	8 (10.6)	2	2.3	0.1		1000	-06	38
FN 9244xB-10-06	10 (11.6)	2	1.02	0.1		1000	-06	38
FN 9244xB-12-06	12 (12)	2	0.58	0.1		1000	-06	38
FN 9244xB-15-06	15 (15)	2	0.4	0.1		1000	-06	38
FN 9244xB-12-06HI	12 (12)	2	0.58	0.1		1000	-06	38
FN 9244xB-15-06HI	15 (15)	2	0.4	0.1		1000	-06	38

* Maximum leakage under normal operating conditions. Note: if the neutral line is interrupted, worst case leakage could reach twice this level.

Product selector

FN 9244xx-yy-..HI-zz

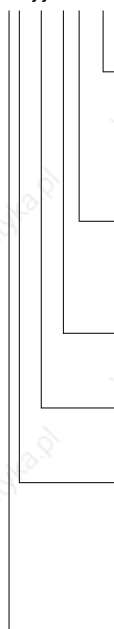

Snap-in range for S version only

Blank: Snap-in range 0.7 to 1.5mm

20: Snap-in range 1.5 to 2.2mm

Blank: Standard IEC inlet type C14

HI: Hot IEC inlet type C16 (12 and 15A types only)

06: Faston 6.3 x 0.8mm (spade/soldering)

1 to 15: Rated current

Blank: Standard version

R: Bleed resistor

B: Medical version (with bleed resistor and without Y2-capacitor)

 Blank: Standard housing with mounting flanges

 U: Housing with wider mounting flanges

 S: Snap-in version, snapper on vertical side

 S1: Snap-in version, snapper on horizontal side

For example: FN 9244B-15-06, FN 9244S1B-10-06-20, FN 9244R-12-06HI, FN 9244UB-8-06

Typical filter attenuation

Per CISPR 17; A = 50Ω/50Ω sym; B = 50Ω/50Ω asym; C = 0.1Ω/100Ω sym; D = 100Ω/0.1Ω sym

1 and 3A types

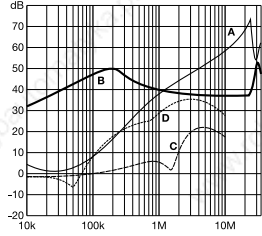

6 to 10A types

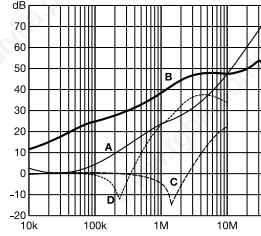

12 and 15A types

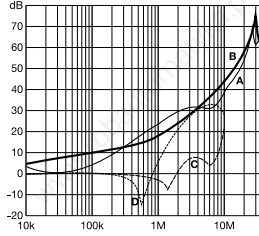

Mechanical data

FN 9244

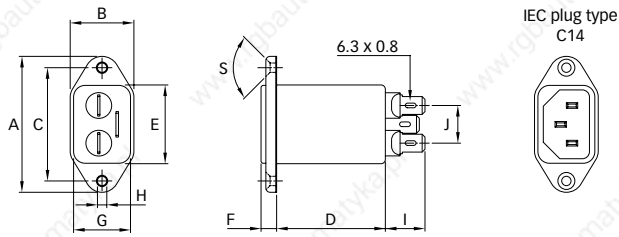

FN 9244-HI

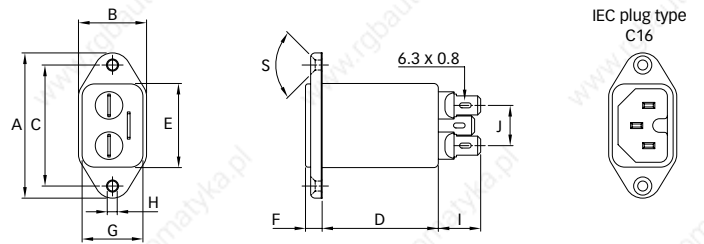

FN 9244S

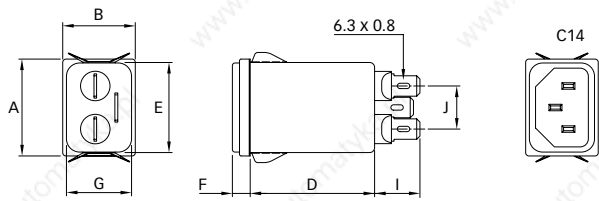

FN 9244S1

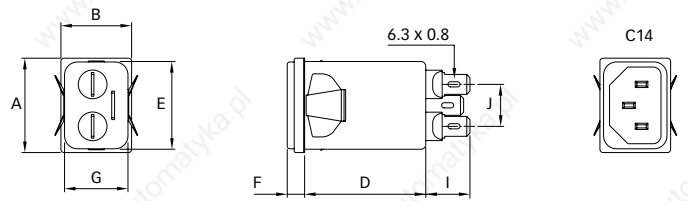

FN 9244U

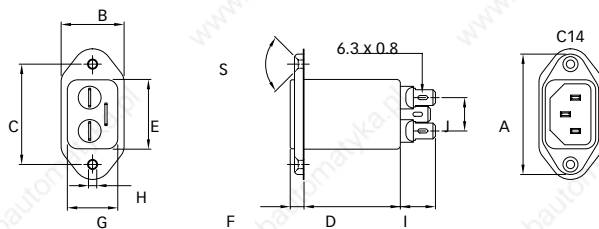

Installation

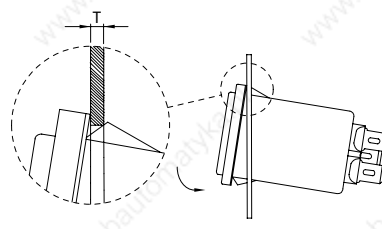

Panel cut out

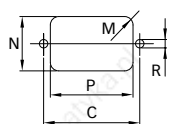

Dimensions

	FN 9244	FN 9244U	FN 9244S	FN 9244S1	FN 9244-HI
A	48	51.85	29.9	29.9	48
B	22.5	25	22.4	22.4	22.5
C	40 ±0.2	40 ±0.2			40 ±0.2
D	38.4	38.25	38.4	38.4	38.4
E	27.8	27.8	27.8	27.8	27.8
F	5.5	5.5	5.5	5.5	5.5
G	20.1	20.1	20.1	20.1	20.1
H	Ø3.3	Ø3.3			Ø3.3
I	14	14.1	14	14	14
J	13.3	13.3	13.3	13.3	13.3
M	R ≤ 3	R ≤ 3	R ≤ 1.5	R ≤ 1.5	R ≤ 3
N	21.5	21.5	20.8	21.9	21.5
P	28.5	28.5	29.4	28.5	28.5
R	M3	M3			M3
S	90°	90°			90°
T*			0.7 - 1.5	0.7 - 1.5	
T*			1.5 - 2.2	1.5 - 2.2	

* For selecting the panel thickness, please refer to the filter selector table.

All dimensions in mm; 1 inch = 25.4mm

Tolerances according: ISO 2768-m / EN 22768-m

Excellent Performance IEC Inlet Filter with Earth Line Choke

SCHAFFNER
energy efficiency and reliability



- Rated currents up to 15A
- Superior attenuation performance
- Integrated earth line choke
- Optional medical versions (B type) according to IEC/EN 60601-1
- Snap-in versions (S and S1 type)
- Hot inlet versions (HI type)

Approvals



ROHS

Technical specifications

Maximum continuous operating voltage:	250VAC, 50/60Hz
Operating frequency:	dc to 400Hz
Rated currents:	1 to 15A @ 50°C
Approvals by rated current:	1 to 10A (ENEC, CQC) 1 to 15A (UL, CSA)
High potential test voltage:	P → PE 2000VAC for 2 sec (standard types) P → PE 2500VAC for 2 sec (B types) P → N 1000VAC for 2 sec
Protection category:	IP40 according to IEC 60529
Temperature range (operation and storage):	-25°C to +85°C (25/85/21)
Design corresponding to:	UL 1283, CSA 22.2 No. 8 1986, IEC/EN 60939
Flammability corresponding to:	UL 94V-2 or better
MTBF @ 40°C/230V (Mil-HB-217F):	2,230,000 hours

Typical electrical schematic

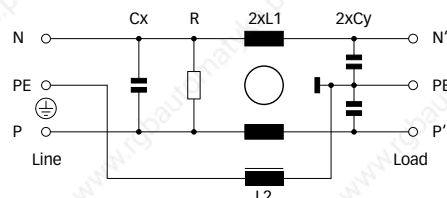

The FN 9244E IEC inlet filter combines an IEC inlet and mains filter with superior filter attenuation in a small form factor. The FN 9244E high performance power entry module offers additional EMI suppression on the earth line. Choosing the FN 9244E product line brings you the rapid availability of a standard filter associated with the necessary safety acceptances. Standard IEC connector filters are a practical solution helping you to pass EMI system approval in a short time. A wide selection on amperage ratings, output connections, mounting possibilities and filters for medical applications are designed to offer you the desired solution. For types without additional earth line choke please consult the FN 9244 data sheet.

Features and benefits

- Superior conducted attenuation performance, based on chokes with high saturation resistance and excellent thermal behavior.
- Rear/front or snap-in mounting.
- Without earth line choke see FN 9244 data sheet.
- Optional medical versions (B type) comply with the requirements of IEC/EN 60601-1 for creepage and clearance, leakage current and high potential testing.
- Wide mounting flanges available.
- Custom-specific versions are available on request.

Typical applications

- Electrical and electronic equipment
- Small to medium-sized machines and household equipment
- Single-phase power supplies, switch-mode power supplies
- Test and measurement equipment
- Medical devices (MDD)
- In-vitro diagnostic medical devices (IVDD)
- Rack mounting equipment

Filter selection table

Filter	Rated current @ 50°C (25°C) [A]	Leakage current* @ 250VAC/50Hz [µA]	Inductance		Capacitance		Resistance R [kΩ]	Output connections 	Weight [g]
			L1 [mH]	L2 [mH]	Cx [µF]	Cy [nF]			
FN 9244Ex-1-06	1 (1.2)	373	59.53	0.335	0.1	2.2		-06	46
FN 9244Ex-3-06	3 (3.5)	373	13.45	0.6	0.1	2.2		-06	46
FN 9244Ex-6-06	6 (7.2)	373	4.1	0.9	0.1	2.2		-06	46
FN 9244Ex-8-06	8 (10.6)	373	2.3	1.0	0.1	2.2		-06	46
FN 9244Ex-10-06	10 (11.6)	373	1.02	1.0	0.1	2.2		-06	46
FN 9244Ex-12-06	12 (12)	373	0.58	1.1	0.1	2.2		-06	46
FN 9244Ex-15-06	15 (15)	373	0.4	1.2	0.1	2.2		-06	46
FN 9244Ex-12-06HI	12 (12)	373	0.58	1.1	0.1	2.2		-06	46
FN 9244Ex-15-06HI	15 (15)	373	0.4	1.2	0.1	2.2		-06	46
FN 9244ExR-1-06	1 (1.2)	373	59.53	0.335	0.1	2.2	1000	-06	46
FN 9244ExR-3-06	3 (3.5)	373	13.45	0.6	0.1	2.2	1000	-06	46
FN 9244ExR-6-06	6 (7.2)	373	4.1	0.9	0.1	2.2	1000	-06	46
FN 9244ExR-8-06	8 (10.6)	373	2.3	1.0	0.1	2.2	1000	-06	46
FN 9244ExR-10-06	10 (11.6)	373	1.02	1.0	0.1	2.2	1000	-06	46
FN 9244ExR-12-06	12 (12)	373	0.58	1.1	0.1	2.2	1000	-06	46
FN 9244ExR-15-06	15 (15)	373	0.4	1.2	0.1	2.2	1000	-06	46
FN 9244ExR-12-06HI	12 (12)	373	0.58	1.1	0.1	2.2	1000	-06	46
FN 9244ExR-15-06HI	15 (15)	373	0.4	1.2	0.1	2.2	1000	-06	46
FN 9244ExB-1-06	1 (1.2)	2	59.53	0.335	0.1		1000	-06	46
FN 9244ExB-3-06	3 (3.5)	2	13.45	0.6	0.1		1000	-06	46
FN 9244ExB-6-06	6 (7.2)	2	4.1	0.9	0.1		1000	-06	46
FN 9244ExB-8-06	8 (10.6)	2	2.3	1.0	0.1		1000	-06	46
FN 9244ExB-10-06	10 (11.6)	2	1.02	1.0	0.1		1000	-06	46
FN 9244ExB-12-06	12 (12)	2	0.58	1.1	0.1		1000	-06	46
FN 9244ExB-15-06	15 (15)	2	0.4	1.2	0.1		1000	-06	46
FN 9244ExB-12-06HI	12 (12)	2	0.58	1.1	0.1		1000	-06	46
FN 9244ExB-15-06HI	15 (15)	2	0.4	1.2	0.1		1000	-06	46

* Maximum leakage under normal operating conditions. Note: if the neutral line is interrupted, worst case leakage could reach twice this level.

Product selector

FN 9244Exx-yy...HI-zz

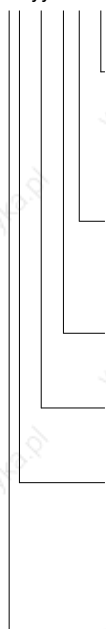

Snap-in range for S version only

Blank: Snap-in range 0.7 to 1.5mm

20: Snap-in range 1.5 to 2.2mm

Blank: Standard IEC inlet type C14

HI: Hot IEC inlet type C16 (12 and 15A types only)

06: Faston 6.3 x 0.8mm (spade/soldering)

1 to 15: Rated current

Blank: Standard version

R: Bleed resistor

B: Medical version (with bleed resistor and without Y2-capacitor)

 Blank: Standard housing with mounting flanges

 U: Housing with wider mounting flanges

 S: Snap-in version, snapper on vertical side

 S1: Snap-in version, snapper on horizontal side

For example: FN 9244E-15-06, FN 9244ES1B-10-06-20, FN 9244ER-12-06HI, FN 9244EUB-8-06

Typical filter attenuation

Per CISPR 17; A = 50Ω/50Ω sym; B = 50Ω/50Ω asym; C = 0.1Ω/100Ω sym; D = 100Ω/0.1Ω sym

1 and 3A types

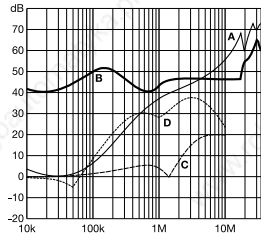

6 to 10A types

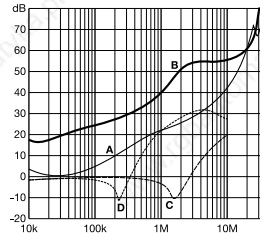

12 and 15A types

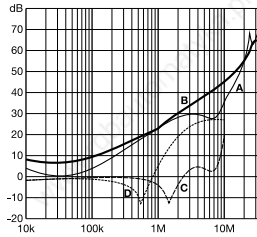

Mechanical data

FN 9244E

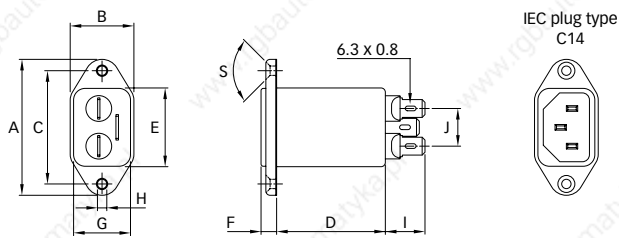

FN 9244E-HI

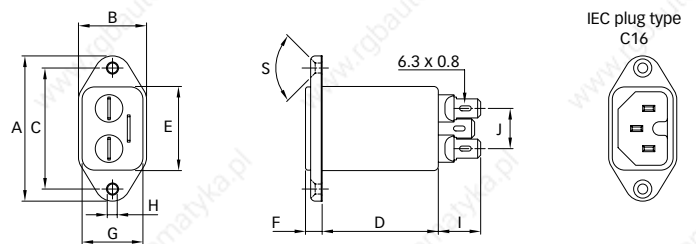

FN 9244ES

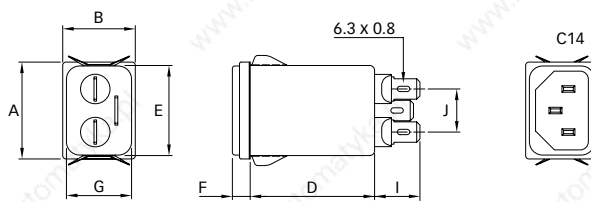

FN 9244ES1

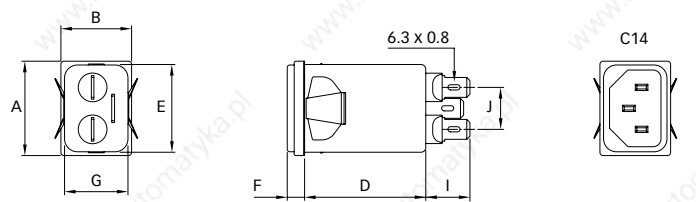

FN 9244EU

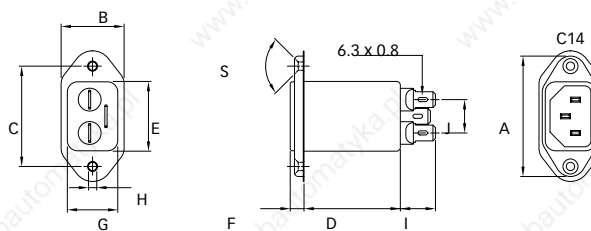

Installation

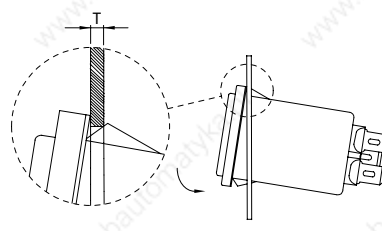

Panel cut out

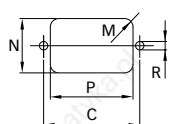

Dimensions

	FN 9244E	FN 9244EU	FN 9244ES	FN 9244ES1	FN 9244E-HI
A	48	51.85	29.9	29.9	48
B	22.5	25	22.4	22.4	22.5
C	40 ±0.2	40 ±0.2			40 ±0.2
D	46.8	46.8	46.8	46.8	46.8
E	27.8	27.8	27.8	27.8	27.8
F	5.5	5.5	5.5	5.5	5.5
G	20.1	20.1	20.1	20.1	20.1
H	Ø3.3	Ø3.3			Ø3.3
I	14	14.1	14	14	14
J	13.3	13.3	13.3	13.3	13.3
M	R ≤ 3	R ≤ 3	R ≤ 1.5	R ≤ 1.5	R ≤ 3
N	21.5	21.5	20.8	21.9	21.5
P	28.5	28.5	29.4	28.5	28.5
R	M3	M3			M3
S	90°	90°			90°
T*			0.7 - 1.5	0.7 - 1.5	
T*			1.5 - 2.2	1.5 - 2.2	

* For selecting the panel thickness, please refer to the filter selector table.

All dimensions in mm; 1 inch = 25.4mm

Tolerances according: ISO 2768-m / EN 22768-m

High Performance IEC Inlet Filter



energy efficiency and reliability

- Rated currents up to 20A
- Optional medical versions (B type)
- Rear mounting
- Excellent attenuation in the lower frequency range

Approvals



Technical specifications

Maximum continuous operating voltage:	250VAC, 50/60Hz
Operating frequency:	dc to 400Hz
Rated currents:	1 to 20A @ 50°C
Approvals by rated current:	1 to 10A (Semko) 16A (Semko) for 16 and 20A types 1 to 20A (UL, CSA)
High potential test voltage:	P → PE 2000VAC for 2 sec (standard types) P → PE 2500VAC for 2 sec (B types) P → N 1100VAC for 2 sec (1 to 10A types) P → N 1100VDC for 2 sec (16 and 20A types)
Protection category:	IP40 according to IEC 60529
Temperature range (operation and storage):	-25°C to +85°C (25/85/21)
Design corresponding to:	UL 1283, CSA 22.2 No. 8 1986, IEC/EN 60939
Flammability corresponding to:	UL 94V-2 or better
MTBF @ 40°C/230V (Mil-HB-217F):	1,600,000 hours

Typical electrical schematic

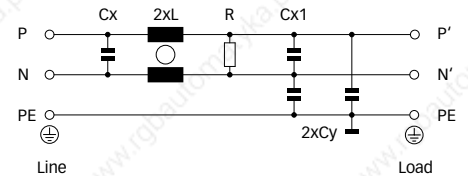

The FN 9246 IEC inlet filter combines an IEC inlet and mains filter with excellent filter attenuation in a small form factor. Choosing the FN 9246 product line brings you the rapid availability of a standard filter associated with the necessary safety acceptances. Standard IEC connector filters are a practical solution helping you to pass EMI system approval in a short time. A wide selection on current ratings and low leakage versions for medical applications are designed to offer you the desired solution.

Features and benefits

- Excellent conducted attenuation performance, based on chokes with high saturation resistance and excellent thermal behavior.
- Rear mounting.
- Optional low leakage current versions for medical applications.
- Rated currents up to 20A.
- Custom-specific versions are available on request.

Typical applications

- Electrical and electronic equipment
- Small to medium-sized machines and household equipment
- Single-phase power supplies, switch-mode power supplies
- Test and measurement equipment
- Building automation
- Medical equipment
- Lighting application

Filter selection table

Filter	Rated current @ 40°C (25°C)	Leakage current* @ 230VAC/50Hz	Inductance L	Capacitance Cx Cy		Resistance R	Output connections 	Weight [g]
	[A]	[μA]	[mH]	[μF]	[nF]	[kΩ]		
FN 9246-1-06	1 (1.2)	373	50	1.22	2.2	470	-06	140
FN 9246-3-06	3 (3.5)	373	14	1.22	2.2	470	-06	140
FN 9246-6-06	6 (7.2)	373	7	1.22	2.2	470	-06	140
FN 9246-10-06	10 (12)	373	3	1.22	2.2	470	-06	140
FN 9246-12-06	12 (14)	373	1.85	1.22	2.2	470	-06	140
FN 9246-15-06	15 (18)	373	0.89	1.22	2.2	470	-06	140
FN 9246-16-06	16 (18.5)	797	2.5	1.22	4.7	470	-06	275
FN 9246-20-06	20 (23)	797	1.5	1.22	4.7	470	-06	275
FN 9246B-1-06	1 (1.2)	2	50	1.22		470	-06	140
FN 9246B-3-06	3 (3.5)	2	14	1.22		470	-06	140
FN 9246B-6-06	6 (7.2)	2	7	1.22		470	-06	140
FN 9246B-10-06	10 (11.6)	2	3	1.22		470	-06	140
FN 9246B-12-06	12 (14)	2	1.85	1.22		470	-06	140
FN 9246B-15-06	15 (18)	2	0.89	1.22		470	-06	140
FN 9246B-16-06	16 (18.5)	2	2.5	1.22		470	-06	275
FN 9246B-20-06	20 (23)	2	1.5	1.22		470	-06	275

* Maximum leakage under normal operating conditions. Note: if the neutral line is interrupted, worst case leakage could reach twice this level.

Product selector

FN 9246x-yy-...

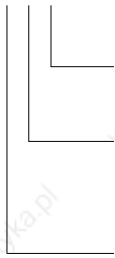

- 06: Faston 6.3 x 0.8mm (spade/soldering)
- 1 to 20: Rated current
Standard IEC inlet type C14 (1 to 15A types), C20 (16 and 20A types)
- Blank: Standard version
- B: Medical version (with bleed resistor and without Y2-capacitor)

For example: FN 9246-6-06, FN 9246B-10-06

Typical filter attenuation

Per CISPR 17; A = 50Ω/50Ω sym; B = 50Ω/50Ω asym; C = 0.1Ω/100Ω sym; D = 100Ω/0.1Ω sym

1A types

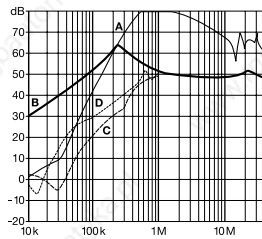

3 to 10A types

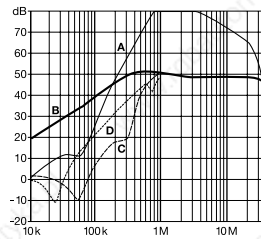

12 and 15A types

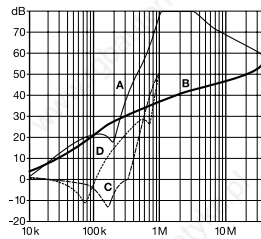

16 and 20A types

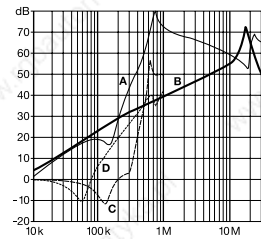

Mechanical data

1 to 15A types

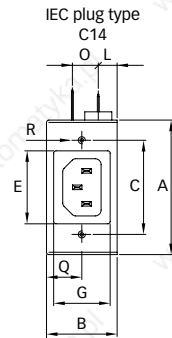
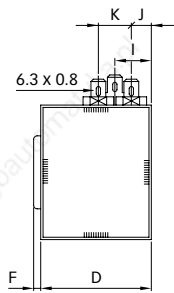

16 and 20A types

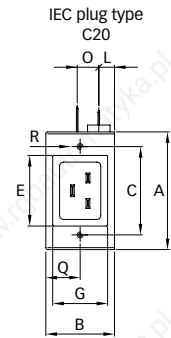
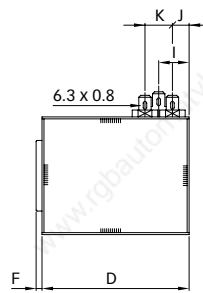

Panel cut out

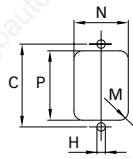

Dimensions

	1A	3A	6A	10A	12A	15A	16A	20A
A	57.15	57.15	57.15	57.15	57.15	57.15	60	60
B	30	30	30	30	30	30	35	35
C	40	40	40	40	40	40	45	45
D	47	47	47	47	47	47	75	75
E	31	31	31	31	31	31	36	36
F	3	3	3	3	3	3	3	3
G	24	24	24	24	24	24	28	28
H	Ø3.5	Ø3.5	Ø3.5	Ø3.5	Ø3.5	Ø3.5	Ø3.5	Ø3.5
I	15.5	15.5	15.5	15.5	15.5	15.5	15.5	15.5
J	8.5	8.5	8.5	8.5	8.5	8.5	8.5	8.5
K	14	14	14	14	14	14	14	14
L	8	8	8	8	8	8	8	8
M	R ≤ 1.5	R ≤ 1.5	R ≤ 1.5	R ≤ 1.5	R ≤ 1.5	R ≤ 1.5	R ≤ 1.5	R ≤ 1.5
N	25	25	25	25	25	25	29	29
O	11	11	11	11	11	11	11	11
P	32	32	32	32	32	32	37	37
Q	15	15	15	15	15	15	17.5	17.5
R	M3 x 10 max.							

All dimensions in mm; 1 inch = 25.4mm
Tolerances according: ISO 2768-m / EN 22768-m

General Purpose Power Entry Module with Fuses

SCHAFFNER
energy efficiency and reliability



- Rated currents up to 10A
- For one or two fuses
- Optional safety version (A type)
- Optional medical versions (B type) according to IEC/EN 60601-1
- Snap-in versions (S type)

Approvals



ROHS

Technical specifications

Maximum continuous operating voltage:	250VAC, 50/60Hz
Operating frequency:	dc to 400Hz
Rated currents:	1 to 10A @ 40°C max.
High potential test voltage:	P → PE 2000VAC for 2 sec (standard types) P → PE 2500VAC for 2 sec (B types) P → N 760VAC for 2 sec (standard types) P → N 1700VDC for 2 sec (B types)
Protection category:	IP40 according to IEC 60529
Temperature range (operation and storage):	-25°C to +85°C (25/85/21)
Design corresponding to:	UL 1283, CSA 22.2 No. 8 1986, IEC/EN 60939
Flammability corresponding to:	UL 94V-2 or better
MTBF @ 40°C/230V (Mil-HB-217F):	2,200,000 hours
Fuse holder:	1 or 2 fuses (Ø5 x 20mm)

Typical electrical schematic

FN 9260 (B types without Y-capacitors)

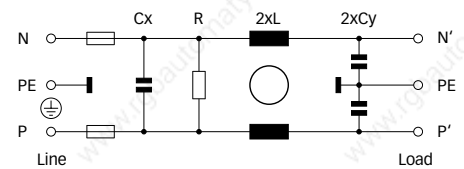

FN 261

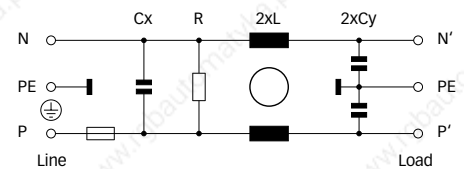

The FN 9260 power entry module combines an IEC inlet, mains filter with excellent filter attenuation and fuses in a small form factor. Choosing FN 9260 product line brings you rapid availability of a standard filter associated with the necessary safety acceptances. Standard IEC connector filters are a practical solution helping you to pass EMI system approval in a short time. A wide selection on amperage ratings, output connections, mounting possibilities and filters for medical applications are designed to offer you the desired solution.

Features and benefits

- Exceptional conducted attenuation performance, based on chokes with high saturation resistance and excellent thermal behavior.
- B types comply with the requirements of IEC/EN 60601-1 for creepage and clearance, leakage current and high potential testing.
- Versions up to 10A are available with fuse holder for one or two fuses.
- Custom-specific versions are available on request.

Typical applications

- Portable electrical and electronic equipment
- Medical equipment
- Small to medium-sized machines and household equipment
- Single-phase power supplies, switch-mode power supplies
- Test and measurement equipment

Filter selection table

Filter	Rated current @ 40°C (25°C)	Leakage current* @ 230VAC/50Hz	Inductance L	Capacitance		Resistance R	Input/Output connections	Fuses [Qty]	Weight [kg]
	[A]	[μA]	[mH]	Cx [μF]	Cy [nF]	[kΩ]			
FN 9260x-1-06-y	1 (1.2)	373	5.3	0.1	2.2	1000	-06	2	55
FN 9260x-2-06-y	2 (2.3)	373	2.7	0.1	2.2	1000	-06	2	55
FN 9260x-4-06-y	4 (4.6)	373	1.0	0.1	2.2	1000	-06	2	55
FN 9260x-6-06-y	6 (6.9)	373	0.3	0.1	2.2	1000	-06	2	55
FN 9260x-10-06-y	10 (11.5)	373	0.2	0.1	2.2	1000	-06	2	55
FN 9260xA1-1-06-y	1 (1.2)	37	5.3	0.1	0.22	1000	-06	2	55
FN 9260xA-2-06-y	2 (2.3)	74	2.7	0.1	0.47	1000	-06	2	55
FN 9260xA-4-06-y	4 (4.6)	74	1.0	0.1	0.47	1000	-06	2	55
FN 9260xA-6-06-y	6 (6.9)	74	0.3	0.1	0.47	1000	-06	2	55
FN 9260xA-10-06-y	10 (11.5)	74	0.2	0.1	0.47	1000	-06	2	55
FN 9260xB-1-06-y	1 (1.2)	2	5.3	0.1		1000	-06	2	55
FN 9260xB-2-06-y	2 (2.3)	2	2.7	0.1		1000	-06	2	55
FN 9260xB-4-06-y	4 (4.6)	2	1.0	0.1		1000	-06	2	55
FN 9260xB-6-06-y	6 (6.9)	2	0.3	0.1		1000	-06	2	55
FN 9260xB-10-06-y	10 (11.5)	2	0.2	0.1		1000	-06	2	55
FN 261x-1-06-y	1 (1.2)	373	5.3	0.1	2.2	1000	-06	1	55
FN 261x-2-06-y	2 (2.3)	373	2.7	0.1	2.2	1000	-06	1	55
FN 261x-4-06-y	4 (4.6)	373	1.0	0.1	2.2	1000	-06	1	55
FN 261x-6-06-y	6 (6.9)	373	0.3	0.1	2.2	1000	-06	1	55
FN 261x-10-06-y	10 (11.5)	373	0.2	0.1	2.2	1000	-06	1	55

* Maximum leakage under normal operating conditions. Note: if the neutral line is interrupted, worst case leakage could reach twice this level.

Product selector

FN 9260xx-yy-yy-y

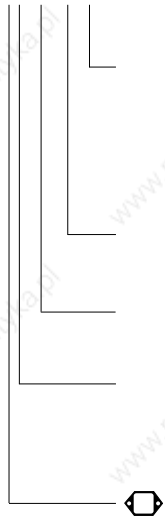

- Snap-in range for S version only
- 10: Snap-in range 0.6 to 1.5mm
- 20: Snap-in range 1.6 to 2.5mm
- 30: Snap-in range 2.6 to 3.5mm
- 06: Faston 6.3 x 0.8mm (spade/soldering)
- 1 to 10: Rated current
- Blank: Standard version
- A: Safety version
- B: Medical version (without Y-capacitor)
- Blank: Standard housing with mounting flanges
- S: Snap-in version, snapper on vertical side

For example: FN 9260-1-06-10, FN 9260SB-10-06-20, FN 261S-6-06-30

Typical filter attenuation

Per CISPR 17; A = 50Ω/50Ω sym; B = 50Ω/50Ω asym; C = 0.1Ω/100Ω sym; D = 100Ω/0.1Ω sym

FN 9260: 1 to 4A types

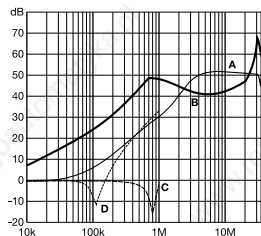

FN 9260: 6 and 10A types

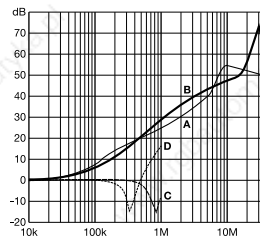

FN 261: 1 to 4A types

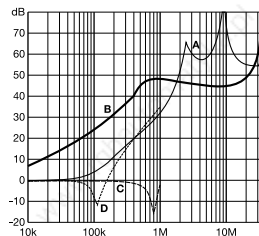

FN 261: 6 and 10A types

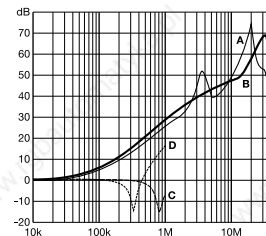

Mechanical data

FN 9260 / FN 261

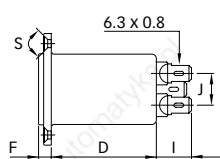
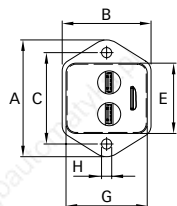

IEC plug type C14

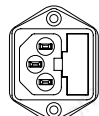

FN 9260S / FN 261S

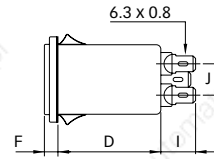
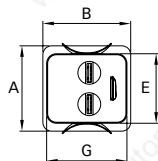

IEC plug type C14



Installation

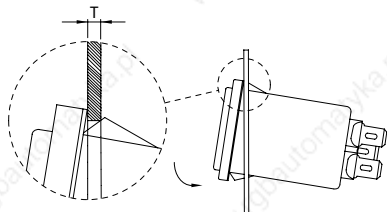

Panel cut out

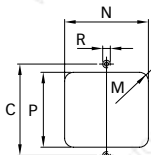

Dimensions

	FN 9260 FN 261	FN 9260S FN 261S	Tolerances
A	46	34	±0.3
B	35	35	±0.3
C	36		±0.3
D	41	41	±0.3
E	27.8	27.8	+0.3/-0
F	5.5	5.5	±0.3
G	32	32	+0.3/-0
H	Ø3.2		±0.1
I	13.8	13.8	
J	12.5	12.5	±0.3
M	R ≤ 3.5	R ≤ 3.5	
N	33	33	+0.3/-0
P	29	29.5	±0.3
R	M3		
S	90°		
T*		0.6 - 1.5	
T*		1.6 - 2.5	
T*		2.6 - 3.5	

* For selecting the panel thickness, please refer to the filter selector table.
 All dimensions in mm; 1 inch = 25.4mm
 Tolerances according: ISO 2768-m / EN 22768-m

General Purpose Power Entry Module with Mains Switch

SCHAFNER
energy efficiency and reliability



- Rated currents up to 10A
- 1-pole rocker switch
- Snap-in versions (S and S1 type)
- Compact to fit 1U rack size

Approvals



(CQC approval pending)

ROHS

Technical specifications

Maximum continuous operating voltage:	250VAC, 50/60Hz
Operating frequency:	50 to 400Hz
Rated currents:	1 to 10A @ 40°C max.
High potential test voltage for capacitors:	P → PE 2000VAC for 2 sec P → N 760VAC for 2 sec
Protection category:	IP40 according to IEC 60529
Temperature range (operation and storage):	-25°C to +85°C (25/85/21)
Design corresponding to:	UL 1283, CSA 22.2 No. 8 1986, IEC/EN 60939
Flammability corresponding to:	UL 94V-2, UL 94V-0 or better
MTBF @ 40°C/230V (Mil-HB-217F):	6,500,000 hours
Rocker switch description:	
Function:	1-pole, dark not illuminated
	Marking I - 0
Electrical specifications:	
	Inrush current 78A
	10,000 on-off operations according to UL 1054, TV 5
Switch ratings:	
USA (UL):	10A, 125VAC; 8A, 250VAC; 1/4HP
Canada (CSA):	10A, 250VAC; 1/4HP
Europe (ENEC):	10A (4A), 250VAC*

* Value in () relates to the inductive current charge: $\cos \varphi = 0.65$

Typical electrical schematic

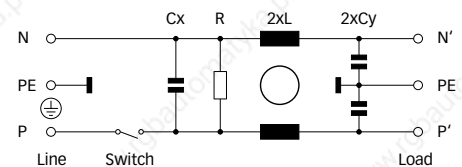

The FN 9263 power entry module combines an IEC inlet, mains filter with excellent filter attenuation and a mains switch in a small form factor. Choosing the FN 9263 product line brings you the rapid availability of a standard filter associated with the necessary safety acceptances. Standard IEC connector filters are a practical solution helping you to pass EMI system approval in a short time. A wide selection on amperage ratings and mounting possibilities are designed to offer you the desired solution.

Features and benefits

- Exceptional conducted attenuation performance, based on chokes with high saturation resistance and excellent thermal behavior.
- Rear/front or snap-in mounting.
- Small compact housing fitting 1U rack applications.
- Versions up to 10A are available with 1 pole rocker switch.
- Custom-specific versions are available on request.

Typical applications

- Portable electrical and electronic equipment
- Small to medium-sized machines and household equipment
- Single-phase power supplies, switch-mode power supplies
- Test and measurement equipment
- Rack mounting equipment

Filter selection table

Filter	Rated current @ 40°C (25°C)	Leakage current* @ 250VAC/50Hz	Inductance L	Capacitance		Resistance R	Output connections 	Weight [g]
	[A]	[µA]	[mH]	Cx [µF]	Cy [nF]	[kΩ]		
FN 9263x-1-06-y	1 (1.2)	373	5.3	0.1	2.2	1000	-06	55
FN 9263x-2-06-y	2 (2.3)	373	2.7	0.1	2.2	1000	-06	55
FN 9263x-3-06-y	3 (3.5)	373	2	0.1	2.2	1000	-06	55
FN 9263x-4-06-y	4 (4.6)	373	1	0.1	2.2	1000	-06	55
FN 9263x-6-06-y	6 (6.9)	373	0.3	0.1	2.2	1000	-06	55
FN 9263x-8-06-y	8 (9.2)	373	0.25	0.1	2.2	1000	-06	55
FN 9263x-10-06-y	10 (11.5)	373	0.2	0.1	2.2	1000	-06	55

* Maximum leakage under normal operating conditions. Note: if the neutral line is interrupted, worst case leakage could reach twice this level.

Product selector

FN 9263x-yy-yy-y

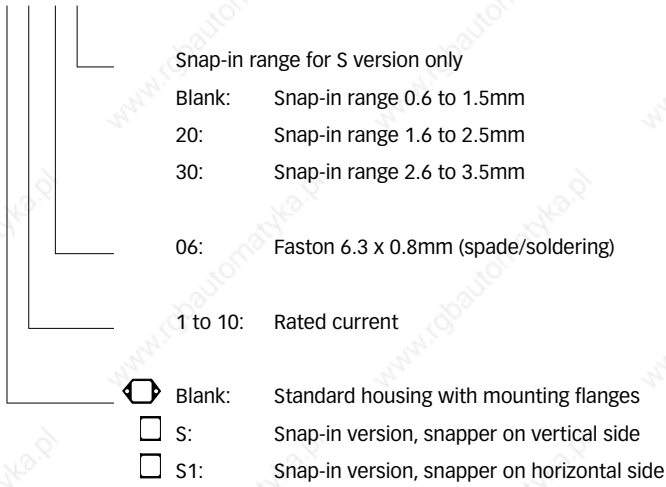

For example: FN 9263-1-06, FN 9263S-10-06-20, FN 9263S1-6-06-30

Typical filter attenuation

Per CISPR 17; A = 50Ω/50Ω sym; B = 50Ω/50Ω asym; C = 0.1Ω/100Ω sym; D = 100Ω/0.1Ω sym

1 to 4A types

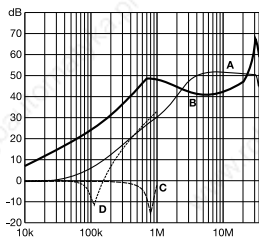

6 to 10A types

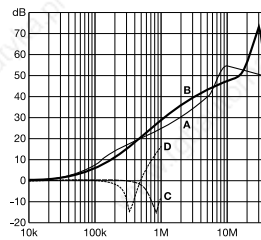

Mechanical data

FN 9263

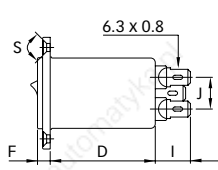
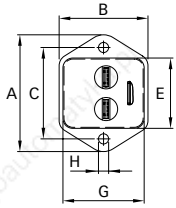
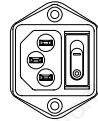
IEC plug type
C14

FN 9263S

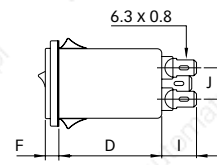
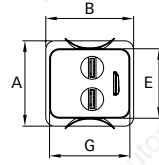
IEC plug type
C14

FN 9263S1

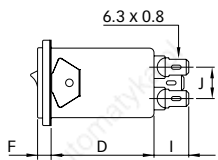
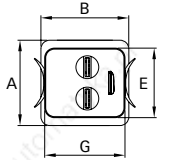

C14



Panel cut out

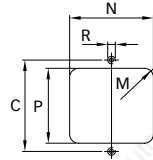

Installation

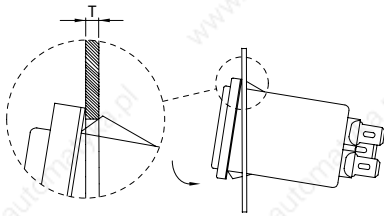

Dimensions

	FN 9263	FN 9263S	FN 9263S1	Tolerances
A	46	34	34	±0.3
B	35	35	35	
C	36			
D	41	41	41	±0.3
E	27.9	27.9	27.9	+0.2/-0
F	5.5	5.5	5.5	±0.3
G	32.2	32.2	32.2	+0/-0.2
H	Ø3.3			±0.1
I	13.8	13.8	13.8	
J	12.5	12.5	12.5	±0.3
M	R ≤ 3.5	R ≤ 3.5	R ≤ 3.5	
N	33.2	32.6	33.3	±0.1
P	29.2	29.0	28.3	±0.1
R	M3			
S	90°			
T*		0.6 - 1.5	0.6 - 1.5	
T*		1.6 - 2.5	1.6 - 2.5	
T*		2.6 - 3.5	2.6 - 3.5	

* For selecting the panel thickness, please refer to the filter selector table.

All dimensions in mm; 1 inch = 25.4mm

Tolerances according: ISO 2768-m / EN 22768-m

Compact Filtered Power Entry Module



energy efficiency and reliability

- Rated currents up to 10A
- Single or dual-fuse holder
- Fuses Ø5 x 20mm
- 2-pole rocker switch
- General purpose application
- Optional earth line choke (E type)
- Optional medical version (B type)

Approvals



(CQC approvals pending)



Technical specifications

Maximum continuous operating voltage:	250VAC, 50/60Hz
Operating frequency:	50 to 400Hz
Rated currents:	1 to 10A @ 40°C max.
High potential test voltage:	P → PE 2000VAC for 2 sec (standard types) P → PE 2500VAC for 2 sec (B types) P → N 760VAC for 2 sec
Protection category:	IP40 according to IEC 60529
Temperature range (operation and storage):	-25°C to +85°C (25/85/21)
Design corresponding to:	UL 1283, CSA 22.2 No. 8 1986, IEC/EN 60939
Flammability corresponding to:	UL 94V-2 or better
MTBF @ 40°C/230V (Mil-HB-217F):	1,500,000 hours
Fuse holder:	1 or 2 fuses (Ø5 x 20mm)
Marking:	 max. 250V ~ (text is print. below fuse symbol)
Rocker switch description:	
Function:	2-pole, dark not illuminated Marking I - 0
Electrical specifications:	Inrush current 82A 6,000 on-off operations according to UL 1054, TV 5 10,000 on-off operations according to ENEC
Mechanical life:	50,000 cycles
Switch ratings:	
USA (UL) and Canada (C-UL):	10A, 125VAC; 10A, 250VAC; 1/3HP
Europe (ENEC):	10A (4A), 250VAC*

* Value in () relates to the inductive current charge: $\cos \varphi = 0.65$

The FN 280 power entry module combines an IEC inlet, a mains filter with single or dual-fuse holder and a 2-pole rocker switch in a small form factor. Choosing FN 280 product line brings you the rapid availability of a standard filter associated with the necessary safety acceptances. Standard IEC connector filters are a practical solution helping you to pass EMI system approval in a short time. A wide selection on amperage ratings, fuse options, mounting possibilities and filters for medical applications are designed to offer you the desired solution.

Features and benefits

- High conducted attenuation performance, based on chokes with high saturation resistance and excellent thermal behavior.
- Rear/front or snap-in mounting.
- Single or dual-fuse holder.
- 2-pole rocker switch.
- Custom-specific versions are available on request.

Typical electrical schematic

Standard types

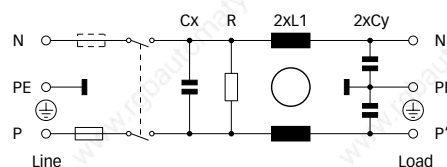

E types

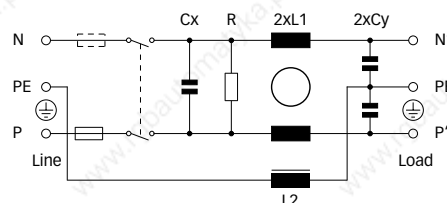

Typical applications

- Portable electrical and electronic equipment
- Consumer goods
- EDP and office equipment
- Single-phase power supplies, switch-mode power supplies
- Test and measurement equipment
- Medical equipment

Filter selection table

Filter	Rated current @ 40°C (25°C)	Leakage current* @ 230VAC/50Hz	Inductance L1 L2		Capacitance Cx Cy		Resistance R	Output connections	Fuses** [Qty]	Weight [g]
	[A]	[µA]	[mH]	[mH]	[nF]	[nF]	[kΩ]			
FN 281-1-06	1 (1.2)	373	7.5		220	2.2	1000	-06	1	140
FN 281-2-06	2 (2.4)	373	2		220	2.2	1000	-06	1	140
FN 281-4-06	4 (4.8)	373	1		220	2.2	1000	-06	1	140
FN 281-6-06	6 (7.2)	373	0.45		220	2.2	1000	-06	1	140
FN 281-10-06	10 (11.6)	373	0.34		220	2.2	1000	-06	1	140
FN 282-1-06	1 (1.2)	373	7.5		220	2.2	1000	-06	2	90
FN 282-2-06	2 (2.4)	373	2		220	2.2	1000	-06	2	90
FN 282-4-06	4 (4.8)	373	1		220	2.2	1000	-06	2	90
FN 282-6-06	6 (7.2)	373	0.45		220	2.2	1000	-06	2	90
FN 282-10-06	10 (11.6)	373	0.34		220	2.2	1000	-06	2	140
FN 283-1-06	1 (1.2)	373	7.5		220	2.2	1000	-06	1	140
FN 283-2-06	2 (2.4)	373	2		220	2.2	1000	-06	1	140
FN 283-4-06	4 (4.8)	373	1		220	2.2	1000	-06	1	140
FN 283-6-06	6 (7.2)	373	0.45		220	2.2	1000	-06	1	140
FN 283-10-06	10 (11.6)	373	0.34		220	2.2	1000	-06	1	140
FN 284-1-06	1 (1.2)	373	7.5		220	2.2	1000	-06	2	90
FN 284-2-06	2 (2.4)	373	2		220	2.2	1000	-06	2	90
FN 284-4-06	4 (4.8)	373	1		220	2.2	1000	-06	2	90
FN 284-6-06	6 (7.2)	373	0.45		220	2.2	1000	-06	2	90
FN 284-10-06	10 (11.6)	373	0.34		220	2.2	1000	-06	2	140
FN 285-1-06	1 (1.2)	373	7.5		220	2.2	1000	-06	1	140
FN 285-2-06	2 (2.4)	373	2		220	2.2	1000	-06	1	140
FN 285-4-06	4 (4.8)	373	1		220	2.2	1000	-06	1	140
FN 285-6-06	6 (7.2)	373	0.45		220	2.2	1000	-06	1	140
FN 285-10-06	10 (11.6)	373	0.34		220	2.2	1000	-06	1	140
FN 286-1-06	1 (1.2)	373	7.5		220	2.2	1000	-06	2	90
FN 286-2-06	2 (2.4)	373	2		220	2.2	1000	-06	2	90
FN 286-4-06	4 (4.8)	373	1		220	2.2	1000	-06	2	90
FN 286-6-06	6 (7.2)	373	0.45		220	2.2	1000	-06	2	90
FN 286-10-06	10 (11.6)	373	0.34		220	2.2	1000	-06	2	140
FN 283E-1-06	1 (1.2)	373	7.5	0.4	220	2.2	1000	-06	1	140
FN 283E-2-06	2 (2.4)	373	2	0.4	220	2.2	1000	-06	1	140
FN 283E-4-06	4 (4.8)	373	1	0.4	220	2.2	1000	-06	1	140
FN 283E-6-06	6 (7.2)	373	0.45	0.4	220	2.2	1000	-06	1	140
FN 284E-1-06	1 (1.2)	373	7.5	0.4	220	2.2	1000	-06	2	90
FN 284E-2-06	2 (2.4)	373	2	0.4	220	2.2	1000	-06	2	90
FN 284E-4-06	4 (4.8)	373	1	0.4	220	2.2	1000	-06	2	90
FN 284E-6-06	6 (7.2)	373	0.45	0.4	220	2.2	1000	-06	2	90
FN 282B-1-06	1 (1.2)	2	7.5		220		1000	-06	2	90
FN 282B-2-06	2 (2.4)	2	2		220		1000	-06	2	90
FN 282B-4-06	4 (4.8)	2	1		220		1000	-06	2	90
FN 282B-6-06	6 (7.2)	2	0.45		220		1000	-06	2	90
FN 282B-10-06	10 (11.6)	2	0.34		220		1000	-06	2	140
FN 284B-1-06	1 (1.2)	2	7.5		220		1000	-06	2	90
FN 284B-2-06	2 (2.4)	2	2		220		1000	-06	2	90
FN 284B-4-06	4 (4.8)	2	1		220		1000	-06	2	90
FN 284B-6-06	6 (7.2)	2	0.45		220		1000	-06	2	90
FN 284B-10-06	10 (11.6)	2	0.34		220		1000	-06	2	140
FN 286B-1-06	1 (1.2)	2	7.5		220		1000	-06	2	90
FN 286B-2-06	2 (2.4)	2	2		220		1000	-06	2	90
FN 286B-4-06	4 (4.8)	2	1		220		1000	-06	2	90
FN 286B-6-06	6 (7.2)	2	0.45		220		1000	-06	2	90
FN 286B-10-06	10 (11.6)	2	0.34		220		1000	-06	2	140





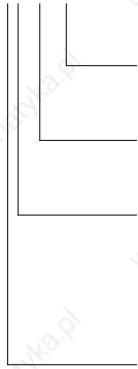

* Maximum leakage under normal operating conditions. Note: if the neutral line is interrupted, worst case leakage could reach twice this level.

** Filters are delivered without fuse.

Product selector

FN 28xx-yy-zz



- 06: Faston 6.3 x 0.8mm (spade/soldering)
- 1 to 10: Rated current
- Blank: Standard version
- E: Optional earth line choke
- B: Medical version (with bleed resistor and without Y2-capacitor)
-  1: Flange mounting version top/bottom, single-fuse
-  2: Flange mounting version top/bottom, dual-fuse
-  3: Flange mounting version left/right, single-fuse
-  4: Flange mounting version left/right, dual-fuse
-  5: Snap-in version, single-fuse
-  6: Snap-in version, dual-fuse

For example: FN 281-6-06, FN 283B-04-06, FN 283E-1-06

Typical filter attenuation

Per CISPR 17; A = 50Ω/50Ω sym; B = 50Ω/50Ω asym; C = 0.1Ω/100Ω sym; D = 100Ω/0.1Ω sym

1A types

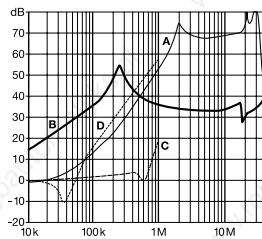

2 to 6A types

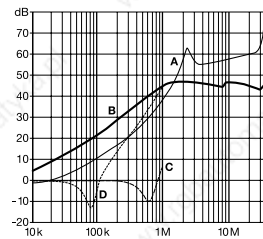

10A types

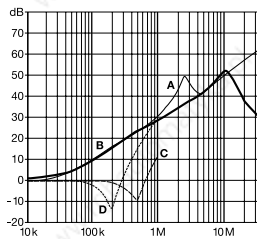

Mechanical data

FN 281 / FN 282

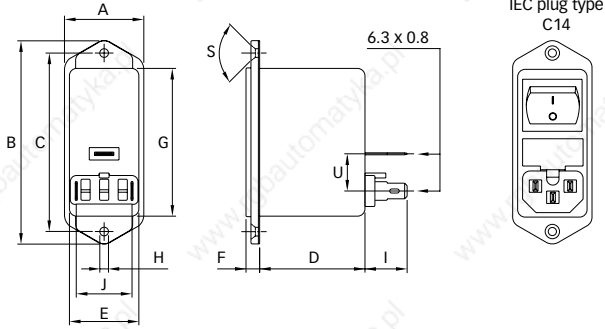

FN 283 / FN 284

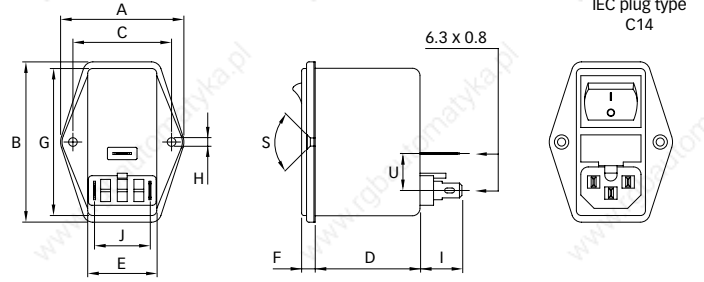

FN 285 / FN 286

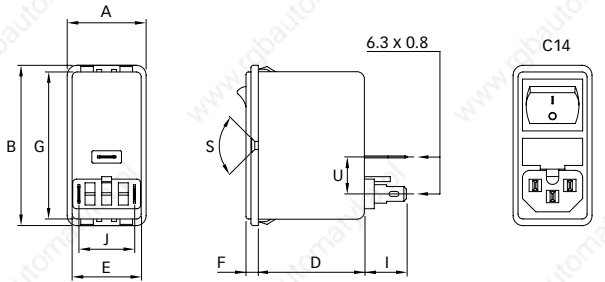

Panel cut out

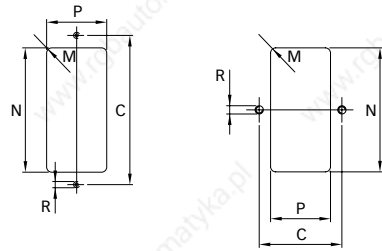

Dimensions

	FN 281	FN 282	FN 283	FN 284	FN 285	FN 286	Tolerances
A	32	32	50	50	32	32	±0.3
B	82	82	65	65	65	65	±0.3
C	72	72	40	40			±0.1
D	43.1	43.1	43.1	43.1	43.6	43.6	±0.3
E	28.5	28.5	28.5	28.5	28.5	28.5	±0.25
F	5.5	5.5	5.5	5.5	5	5	±0.3
G	59.95 max.	59.95 max.	59.95 max.	59.95 max.	59.95 max.	59.95 max.	
H	Ø3.5	Ø3.5	Ø3.3	Ø3.3			
I	13.4	16.2	13.4	16.2	13.9	16.7	±0.3
J	22.5	22.5	22.5	22.5	22.5	22.5	
M	R ≤ 2.5	R ≤ 2.5	R ≤ 2.5	R ≤ 2.5	R ≤ 2.5	R ≤ 2.5	
N	60	60	60	60	61.5 +0.2/-0*	61.5 +0.2/-0*	+0.5/-0
P	29	29	29	29	29	29	+0.5/-0
R	M3	M3	M3	M3			
S	90°	90°	90°	90°			

* For a panel thickness between 0.8 and 3mm
 All dimensions in mm; 1 inch = 25.4mm
 Tolerances according: ISO 2768-m / EN 22768-m

Versatile Filtered Power Entry Module



energy efficiency and reliability

- Rated currents up to 6A
- Single or dual-fuse holder
- Fuses Ø6.3 x 32mm or Ø5 x 20mm
- Voltage selector 100/120/230/240V
- General purpose application
- Optional medical versions (B type)

Approvals



Technical specifications

Maximum continuous operating voltage:	250VAC, 50/60Hz
Operating frequency:	dc to 400Hz
Rated currents:	2 to 6A @ 40°C max.
High potential test voltage:	P → PE 2000VAC for 2 sec (standard types) P → PE 2500VAC for 2 sec (B types)
	P → N 760VAC for 2 sec
Protection category:	IP40 according to IEC 60529
Temperature range (operation and storage):	-25°C to +85°C (25/85/21)
Design corresponding to:	UL 1283, CSA 22.2 No. 8 1986, IEC/EN 60939
Flammability corresponding to:	UL 94V-2 or better
MTBF @ 40°C/230V (Mil-HB-217F):	550,000 hours

Voltage selector description:	VOL-SE 4SP-4
Function:	Series/parallel
Voltage marking*:	
1st:	100
2nd:	120
3rd:	230
4th:	240
Closed internal contact corresponding to:	
1st:	a, c, e
2nd:	b, c, e
3rd:	a, d
4th:	b, d

* Other selected voltage marking on request.

The FN 370 power entry module combines an IEC inlet, a mains filter with a single or dual-fuse holder and a voltage selector. Choosing FN 370 product line brings you the rapid availability of a standard filter associated with the necessary safety acceptances. Standard IEC connector filters are a practical solution helping you to pass EMI system approval in a short time. A wide selection on amperage ratings, fuse options, mounting possibilities and filters for medical applications are designed to offer you the desired solution.

Features and benefits

- Good conducted attenuation performance, based on chokes with high saturation resistance and excellent thermal behavior.
- Rear/front or snap-in mounting.
- Single or dual-fuse holder.
- USA Ø6.3 x 32mm or EU Ø5 x 20mm fuses.
- Two attenuation performance ranges.
- Voltage selector 100/120/230/240V.
- Custom-specific versions are available on request.

Typical electrical schematic

FN 370 / FN 376

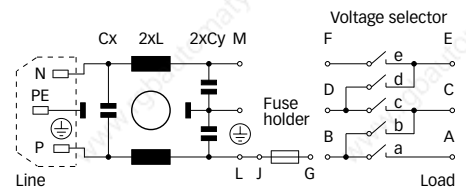

FN 372 / FN 378 / FN 379

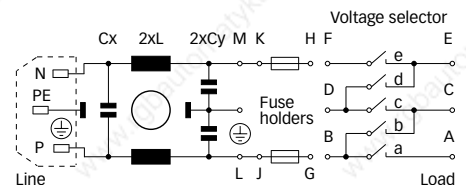

Typical applications

- Portable electrical and electronic equipment
- Consumer goods
- EDP and office equipment
- Single-phase power supplies, switch-mode power supplies
- Test and measurement equipment
- Medical equipment

Filter selection table

Filter*	Rated current @ 40°C (25°C)	Leakage current** @ 230VAC/50Hz	Inductance L [mH]	Capacitance		Resistance R [kΩ]	Output connections 	Fuses*** [Qty]	Weight [g]
	[A]	[μA]		Cx [nF]	Cy [nF]				
FN 370-2-2.1	2 (2.4)	373	0.70	47	2.2		13	1	55
FN 370-4-2.1	4 (4.8)	373	0.30	47	2.2		13	1	55
FN 370-6-2.1	6 (7.2)	373	0.18	47	2.2		13	1	55
FN 372-2-2.2	2 (2.4)	373	0.70	47	2.2		13	2	55
FN 372-4-2.2	4 (4.8)	373	0.30	47	2.2		13	2	55
FN 372-6-2.2	6 (7.2)	373	0.18	47	2.2		13	2	55
FN 376-2-2.1	2 (2.4)	373	0.70	47	2.2		13	1	55
FN 376-4-2.1	4 (4.8)	373	0.30	47	2.2		13	1	55
FN 376-6-2.1	6 (7.2)	373	0.18	47	2.2		13	1	55
FN 378-2-2.2	2 (2.4)	373	0.70	47	2.2		13	2	60
FN 378-4-2.2	4 (4.8)	373	0.30	47	2.2		13	2	60
FN 378-6-2.2	6 (7.2)	373	0.18	47	2.2		13	2	60
FN 379-2-2.2	2 (2.4)	373	2.00	47	2.2		13	2	70
FN 379-4-2.2	4 (4.8)	373	0.80	47	2.2		13	2	70
FN 379-6-2.2	6 (7.2)	373	0.50	47	2.2		13	2	70
FN 379B-2-2.2	2 (2.4)	2	2.00	47		1000	13	2	70
FN 379B-4-2.2	4 (4.8)	2	0.80	47		1000	13	2	70
FN 379B-6-2.2	6 (7.2)	2	0.50	47		1000	13	2	70

* Select the requested fuse holder for fuse EUR-1 or USA-1.

** Maximum leakage under normal operating conditions. Note: if the neutral line is interrupted, worst case leakage could reach twice this level.

*** Filters are delivered without fuse.

Product selector

FN 37xx-y-zz

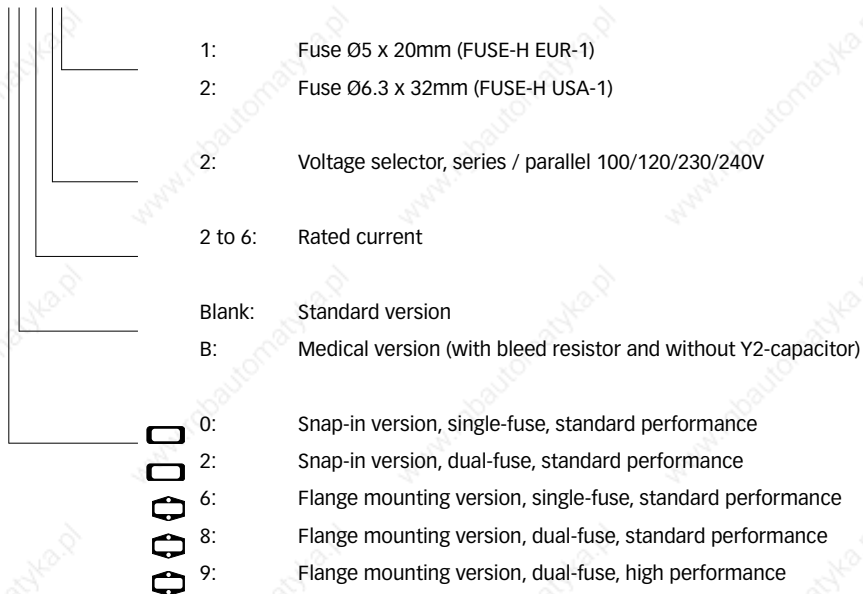

For example: FN 370-6-2.1, FN 378-4-2.2, FN 379B-2-2.2

Typical filter attenuation

Per CISPR 17; A = 50Ω/50Ω sym; B = 50Ω/50Ω asym; C = 0.1Ω/100Ω sym; D = 100Ω/0.1Ω sym

FN 370 / FN 372 / FN 376 / FN 378

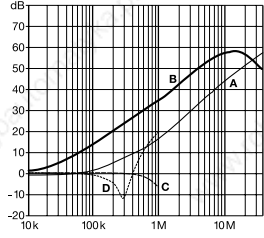

FN 379

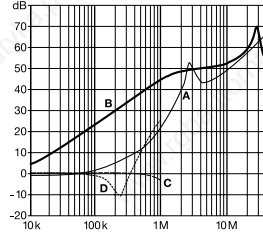

Mechanical data

FN 370 / FN 372

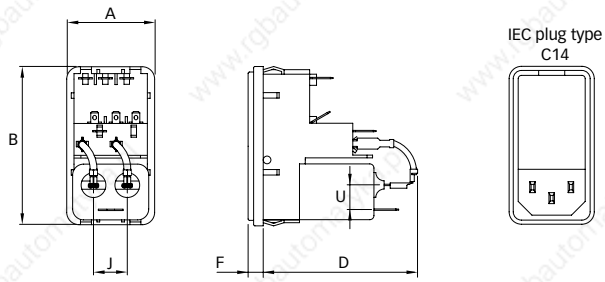

FN 376 / FN 378 / FN 379

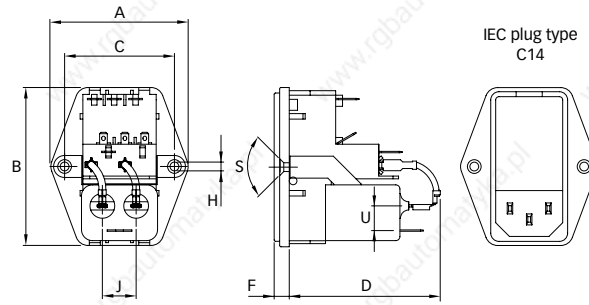

Connection designation

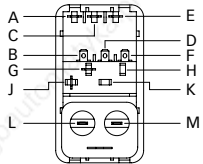

Panel cut out

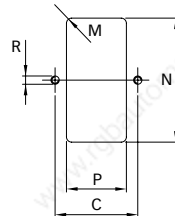

Dimensions

	FN 370	FN 372	FN 376	FN 378	FN 379	Tolerances
A	32	32	50	50	50	±0.3
B	58	58	58	58	58	±0.3
C			40	40	40	±0.1
D	54	54	54	54	64.5	
F	5.5	5.5	5.5	5.5	5.5	
H			Ø3.3	Ø3.3	Ø3.3	
J	12.5	12.5	12.5	12.5	12.5	
M	R ≤ 2	R ≤ 2	R ≤ 2	R ≤ 2	R ≤ 2	±0.1
N	55.9*/56.2**	55.9*/56.2**	55.9*/56.2**	55.9*/56.2**	55.9*/56.2**	+0.2/-0
P	28.5	28.5	28.5	28.5	28.5	+0.2/-0
R			M3	M3	M3	
S			90°	90°	90°	
U	9	9	9	9	9	

* For a back panel thickness between 0.8 and 2.0mm

** For a back panel thickness between 2.1 and 3.2mm

All dimensions in mm; 1 inch = 25.4mm

Tolerances according: ISO 2768-m / EN 22768-m

Versatile Filtered Power Entry Module



energy efficiency and reliability

- Rated currents up to 6A
- Single or dual-fuse holder
- Fuses Ø6.3 x 32mm or Ø5 x 20mm
- 2-pole rocker switch
- General purpose application
- Optional medical versions (B type)

Approvals



Technical specifications

Maximum continuous operating voltage:	250VAC, 50/60Hz
Operating frequency:	50 to 400Hz
Rated currents:	2 to 6A @ 40°C max.
High potential test voltage:	P → PE 2000VAC for 2 sec (standard types) P → PE 2500VAC for 2 sec (B types)
	P → N 760VAC for 2 sec
Protection category:	IP40 according to IEC 60529
Temperature range (operation and storage):	-25°C to +85°C (25/85/21)
Design corresponding to:	UL 1283, CSA 22.2 No. 8 1986, IEC/EN 60939
Flammability corresponding to:	UL 94V-2 or better
MTBF @ 40°C/230V (Mil-HB-217F):	550,000 hours

Rocker switch description:

Function:	2-pole, dark not illuminated
	Marking I - 0

Electrical specifications:	Inrush current 51A
	6,000 on-off operations according to UL 1054, TV 5
	10,000 on-off operations according to ENEC

Mechanical life:	50,000 cycles
------------------	---------------

Switch ratings:	
USA (UL):	6A, 125VAC; 4A, 250VAC; 1/10HP
Canada (CSA):	6A, 125VAC; 4A, 250VAC; 1/10HP
Europe (ENEC):	6A (4A), 250VAC*

* Value in () relates to the inductive current charge: $\cos \varphi = 0.65$

Typical electrical schematic

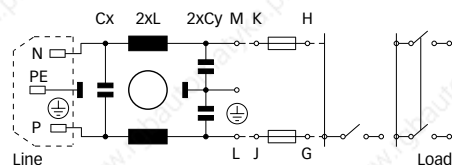

Features and benefits

The FN 380 power entry module combines an IEC inlet, a mains filter with a single or dual-fuse holder and a 2-pole rocker switch.

Choosing FN 380 product line brings you the rapid availability of a standard filter associated with the necessary safety acceptances.

Standard IEC connector filters are a practical solution helping you to pass EMI system approval in a short time. A wide selection on amperage ratings, fuse options, mounting possibilities and filters for medical applications are designed to offer you the desired solution.

- Good conducted attenuation performance, based on chokes with high saturation resistance and excellent thermal behavior.
- Rear/front or snap-in mounting.
- Single or dual-fuse holder.
- USA Ø6.3 x 32mm or EU Ø5 x 20mm fuses.
- 2-pole rocker switch.
- Custom-specific versions are available on request.

Typical applications

- Portable electrical and electronic equipment
- Consumer goods
- EDP and office equipment
- Single-phase power supplies, switch-mode power supplies
- Test and measurement equipment
- Medical equipment

Filter selection table

Filter*	Rated current @ 40°C (25°C)	Leakage current** @ 230VAC/50Hz	Inductance L	Capacitance		Resistance R	Output connections	Fuses*** [Qty]	Weight [g]
	[A]	[μA]		Cx [nF]	Cy [nF]				
FN 380-2-2.	2 (2.4)	373	0.70	47	2.2		13	1	55
FN 380-4-2.	4 (4.8)	373	0.30	47	2.2		13	1	55
FN 380-6-2.	6 (7.2)	373	0.18	47	2.2		13	1	55
FN 382-2-2.	2 (2.4)	373	0.70	47	2.2		13	2	55
FN 382-4-2.	4 (4.8)	373	0.30	47	2.2		13	2	55
FN 382-6-2.	6 (7.2)	373	0.18	47	2.2		13	2	55
FN 385-2-2.	2 (2.4)	373	2.00	47	2.2		13	2	65
FN 385-4-2.	4 (4.8)	373	0.80	47	2.2		13	2	65
FN 385-6-2.	6 (7.2)	373	0.50	47	2.2		13	2	65
FN 388-2-2.	2 (2.4)	373	0.70	47	2.2		13	2	60
FN 388-4-2.	4 (4.8)	373	0.30	47	2.2		13	2	60
FN 388-6-2.	6 (7.2)	373	0.18	47	2.2		13	2	60
FN 389-2-2.	2 (2.4)	373	2.00	47	2.2		13	2	70
FN 389-4-2.	4 (4.8)	373	0.80	47	2.2		13	2	70
FN 389-6-2.	6 (7.2)	373	0.50	47	2.2		13	2	70
FN 382B-2-2.	2 (2.4)	2	0.70	47		1000	13	2	55
FN 382B-4-2.	4 (4.8)	2	0.30	47		1000	13	2	55
FN 382B-6-2.	6 (7.2)	2	0.18	47		1000	13	2	55
FN 389B-2-2.	2 (2.4)	2	2.00	47		1000	13	2	70
FN 389B-4-2.	4 (4.8)	2	0.80	47		1000	13	2	70
FN 389B-6-2.	6 (7.2)	2	0.50	47		1000	13	2	70

* Select the requested fuse holder for fuse EUR-1 or USA-1.

** Maximum leakage under normal operating conditions. Note: if the neutral line is interrupted, worst case leakage could reach twice this level.

*** Filters are delivered without fuse.

Product selector

FN 38xx-y-zz

1:	Fuse Ø5 x 20mm (FUSE-H EUR-1)
2:	Fuse Ø6.3 x 32mm (FUSE-H USA-1)
2:	Rocker switch, 2-pole, dark not illuminated
2 to 6:	Rated current
Blank:	Standard version
B:	Medical version (with bleed resistor and without Y2-capacitor)
0:	Snap-in version, single-fuse, standard performance
2:	Snap-in version, dual-fuse, standard performance
5:	Snap-in version, dual-fuse, high performance
8:	Flange mounting version, dual-fuse, standard performance
9:	Flange mounting version, dual-fuse, high performance

For example: FN 380-6-21, FN 388-4-22, FN 389B-2-21

Typical filter attenuation

Per CISPR 17; A = 50Ω/50Ω sym; B = 50Ω/50Ω asym; C = 0.1Ω/100Ω sym; D = 100Ω/0.1Ω sym

FN 380 / FN 382 / FN 388

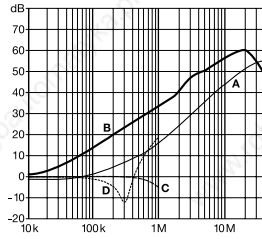

FN 385 / FN 389

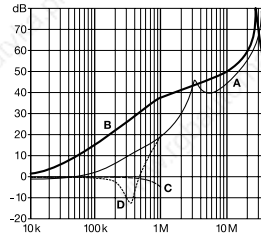

Mechanical data

FN 380 / FN 382 / FN 385

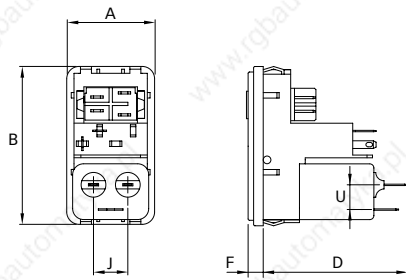

FN 388 / FN 389

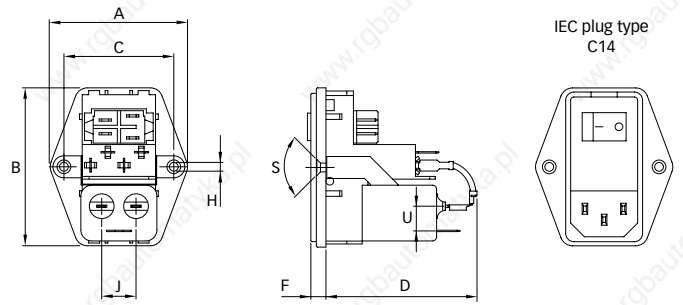

Panel cut out

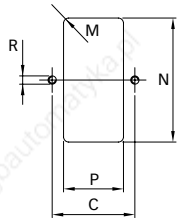

Connection designation

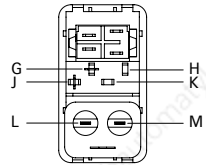

Dimensions

	FN 380	FN 382	FN 385	FN 388	FN 389	Tolerances
A	32	32	32	50	50	±0.3
B	58	58	58	58	58	±0.3
C				40	40	±0.1
D	51	51	61	51	61	
F	5.5	5.5	5.5	5.5	5.5	
H				Ø3.3	Ø3.3	
J	12.5	12.5	12.5	12.5	12.5	
M	R ≤ 2	R ≤ 2	R ≤ 2	R ≤ 2	R ≤ 2	±0.1
N	55.9*/56.2**	55.9*/56.2**	55.9*/56.2**	55.9*/56.2**	55.9*/56.2**	+0.2/-0
P	28.5	28.5	28.5	28.5	28.5	+0.2/-0
R				M3	M3	
S				90°	90°	
U	9	9	9	9	9	

* For a back panel thickness between 0.8 and 2.0mm

** For a back panel thickness between 2.1 and 3.2mm

All dimensions in mm; 1 inch = 25.4mm

Tolerances according: ISO 2768-m / EN 22768-m

Versatile Filtered Power Entry Module



energy efficiency and reliability

- Rated currents up to 10A
- For one or two fuses
- Fuses Ø6.3 x 32mm or Ø5 x 20mm
- 2-pole rocker switch
- Voltage selector
- Optional earth line choke (E type)

Approvals



Technical specifications

Maximum continuous operating voltage:	250VAC, 50/60Hz
Operating frequency:	50 to 400Hz
Rated currents:	1 to 10A @ 40°C max.
High potential test voltage:	P → PE 2000VAC for 2 sec P → N 760VAC for 2 sec
Protection category:	IP40 according to IEC 60529
Temperature range (operation and storage):	-25°C to +85°C (25/85/21)
Design corresponding to:	UL 1283, CSA 22.2 No. 8 1986, IEC/EN 60939
Flammability corresponding to:	UL 94V-2 or better
MTBF @ 40°C/230V (Mil-HB-217F):	2,200,000 hours

Voltage selector description:

Function:	Series/parallel
Voltage marking:	
Series:	110-120V
Parallel:	220-240V

Rocker switch description:

Function:	2-pole, dark not illuminated Marking I - 0
-----------	---

Electrical specifications:

Inrush current	51A
6,000 on-off operations according to UL 1054, TV 5	
10,000 on-off operations according to ENEC	

Mechanical life:

50,000 cycles	
---------------	--

Switch ratings:

USA (UL) and Canada (C-UL):	10A, 125VAC; 10A, 250VAC; 1/3HP
Europe (ENEC):	10A (4A), 250VAC*

* Value in () relates to the inductive current charge: $\cos \varphi = 0.65$

The FN 390 power entry module combines an IEC inlet, mains filter with single or dual-fuse holder, voltage selector and 2-pole rocker switch. Choosing FN 390 product line brings you the rapid availability of a standard filter associated with the necessary safety acceptances. Standard IEC connector filters are a practical solution helping you to pass EMI system approval in a short time. Multiple options designed to offer you the desired solution.

Features and benefits

- High conducted attenuation performance, based on chokes with high saturation resistance and excellent thermal behavior.
- Rear or front mounting.
- Single or dual-fuse holder.
- USA Ø6.3 x 32mm or EU Ø5 x 20mm fuses.
- 2-pole rocker switch.
- Voltage selector 110-120V / 220-240V.
- Custom-specific versions are available on request.

Typical electrical schematic

Standard types

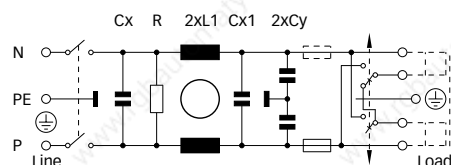

E types

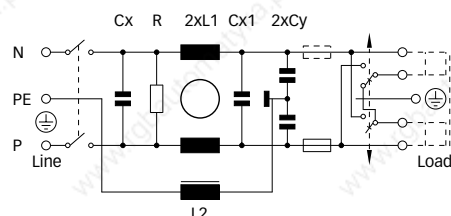

Typical applications

- Portable electrical and electronic equipment
- Consumer goods
- EDP and office equipment
- Single-phase power supplies, switch-mode power supplies
- Test and measurement equipment

Filter selection table

Filter	Rated current @ 40°C (25°C)	Leakage current* @ 230VAC/50Hz	Inductance		Cx	Capacitance		Resistance R	Output connections 	Fuses** [Qty]	Weight [g]
	[A]	[µA]	L1 [mH]	L2 [mH]		Cx1 [nF]	Cy [nF]				
FN 393-1-05-11	1 (1.2)	560	7.5		220	3.3	1000	05-11	1	200	
FN 393-2.5-05-11	2.5 (3)	560	2		220	3.3	1000	05-11	1	200	
FN 393-6-05-11	6 (7.2)	560	0.45		220	3.3	1000	05-11	1	200	
FN 394-1-05-11	1 (1.2)	560	7.5		220	3.3	1000	05-11	2	200	
FN 394-2.5-05-11	2.5 (3)	560	2		220	3.3	1000	05-11	2	200	
FN 394-6-05-11	6 (7.2)	560	0.45		220	3.3	1000	05-11	2	200	
FN 393E-1-05-11	1 (1.2)	560	7.5	0.4	220	3.3	1000	05-11	1	205	
FN 393E-2.5-05-11	2.5 (3)	560	2	0.4	220	3.3	1000	05-11	1	205	
FN 393E-6-05-11	6 (7.2)	560	0.45	0.4	220	3.3	1000	05-11	1	205	
FN 394E-1-05-11	1 (1.2)	560	7.5	0.4	220	3.3	1000	05-11	2	205	
FN 394E-2.5-05-11	2.5 (3)	560	2	0.4	220	3.3	1000	05-11	2	205	
FN 394E-6-05-11	6 (7.2)	560	0.45	0.4	220	3.3	1000	05-11	2	205	
FN 1393-1-05-11	1 (1.2)	797	16		220	100	4.7	05-11	1	210	
FN 1393-2.5-05-11	2.5 (3)	797	8		220	100	4.7	05-11	1	210	
FN 1393-6-05-11	6 (7.2)	797	2.5		220	100	4.7	05-11	1	210	
FN 1393-10-05-11	10 (12)	797	0.6		220	100	4.7	05-11	1	210	
FN 1394-1-05-11	1 (1.2)	797	16		220	100	4.7	05-11	2	210	
FN 1394-2.5-05-11	2.5 (3)	797	8		220	100	4.7	05-11	2	210	
FN 1394-6-05-11	6 (7.2)	797	2.5		220	100	4.7	05-11	2	210	
FN 1394-10-05-11	10 (12)	797	0.6		220	100	4.7	05-11	2	210	

* Maximum leakage under normal operating conditions. Note: if the neutral line is interrupted, worst case leakage could reach twice this level.

** Filters are delivered without fuse.

Note: for medical versions please contact your local partner within Schaffner's global network.

Product selector

FN (1)39xx-y-zz

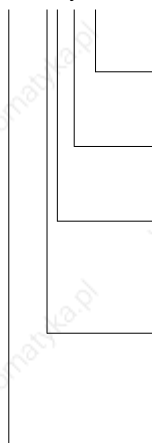

05-11: Faston 6.3 x 0.8mm

1 to 10: Rated current

Blank: Standard version

E: Optional earth line choke

3: 1 fuse (Ø5 x 20mm or Ø6.3 x 32mm)

4: 2 fuses (Ø5 x 20mm or Ø6.3 x 32mm)

Blank: Standard version

1: Additional Cx1 capacitor and higher inductivity

For example: FN 393-1-05-11, FN 394E-2.5-05-11, FN 1394-10-05-11

Typical filter attenuation

Per CISPR 17; A = 50Ω/50Ω sym; B = 50Ω/50Ω asym; C = 0.1Ω/100Ω sym; D = 100Ω/0.1Ω sym

FN 39x: 1A types

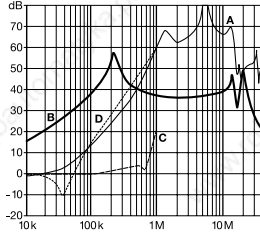

FN 39x: 2.5A types

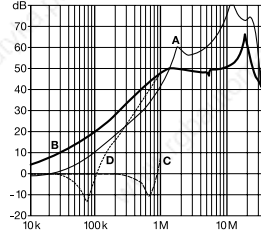

FN 39x: 6A types

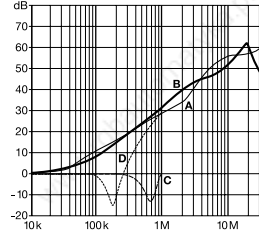

FN 139x: 1A types

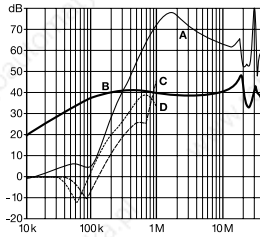

FN 139x: 2.5A types

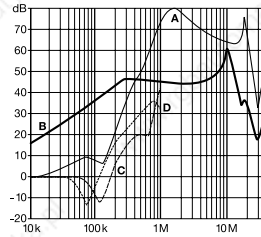

FN 139x: 6 and 10A types

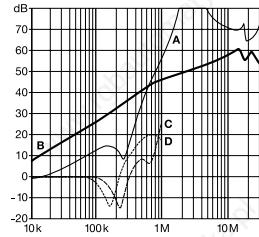

Mechanical data

1 to 10A types

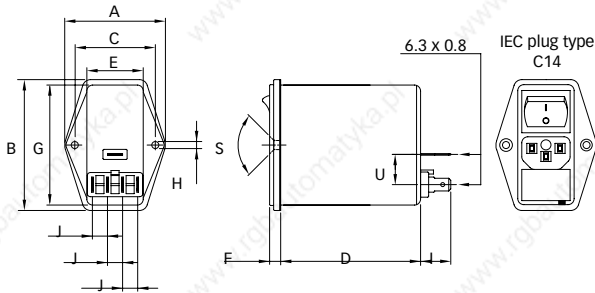

Panel cut out

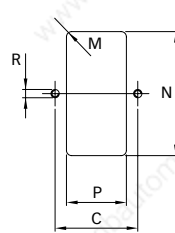

Dimensions

	1 to 10A	Tolerances
A	50	±0.3
B	65	±0.3
C	40	±0.1
D	69.5	±0.3
E	28	
F	5.5	±0.3
G	59.6	
H	Ø3.3	
I	15	
J	7.5	
M	R ≤ 2.5	
N	60.00	±0.5
P	29.00	±0.5
R	M3	
S	90°	
U	15	

All dimensions in mm; 1 inch = 25.4mm
Tolerances according: ISO 2768-m / EN 22768-m









Single-phase Filters

FN 332	90	FN 2060	114
FN 2010	93	FN 2070	118
FN 2020	97	FN 2080	122
FN 2030	101	FN 2090	126
FN 2450	104	FN 2360	129
FN 9675	107	FN 352Z	131
FN 343	109	FN 700Z	134
FN 685	111		

Single-phase Filters. Single-phase filters for chassis or DIN-rail mounting are key for EMC compliance of higher power office equipment and low to medium power industrial applications. A broad selection of electrical and mechanical features allows a specific choice and deployment for countless applications. DC filters are specifically optimized for applications with DC supply like e.g. PV inverters.

Approvals *











Filter family	Max. voltage	Attenuation performance			Features								Typical applications							
		standard	high	very high	1-stage filter circuit	2-stage filter circuit	3-stage filter circuit	For DC applications	With overvoltage protection	Low frequency attenuation	High frequency attenuation	Choice of connection style	DIN-rail mounting	Power supplies, SMPS	Medical equipment	Single-phase motor drives	Control unit in machine tools	PV inverters	Office, test & measure. equip.	General purpose
FN 332 	250VAC	1 - 10			■				■											■
P. 90																				
FN 2010 	250VAC	1		60	■						■			■						■
P. 93																				
FN 2020 	250VAC	1		60	■						■			■						■
P. 97																				■
FN 2030 	250VAC	1	30		■			■	■	■	■			■						■
P. 101																				■
FN 2450 	250VAC	1	20		■				■	■				■	■					■
P. 104																				■
FN 9675/76 	250VAC	3	16		■									■		■				■
P. 107																				■

* Products evaluated by one or more of the above certification agencies. For details please consult the detailed data sheet.

Approvals *



Filter family	Max. voltage	Attenuation performance	Rated current [A]	Features										Typical applications				
				1-stage filter circuit	2-stage filter circuit	3-stage filter circuit	With earth line choke	With overvoltage protection	Low frequency attenuation	High frequency attenuation	Choice of connection style	NEMP, TEMPEST protection	Power supplies, SMPS	Medical equipment	Single-phase motor drives	Control unit in machine tools	Military applications	Office, test & measure. equip.
FN 343 	250VAC	1 - 10			■	■											■	■
P. 109																		
FN 685 	250VAC	10 - 36			■				■		■		■		■			
P. 111																		
FN 2060 	250VAC	1 - 30			■						■		■	■			■	■
P. 114																		
FN 2070 	250VAC	1 - 36			■						■	■	■	■			■	
P. 118																		
FN 2080 	250VAC	1 - 16			■					■		■		■	■			
P. 122																		
FN 2090 	250VAC	1 - 30			■				■	■	■	■		■	■	■		
P. 126																		
FN 2360 	250VAC	3 - 6			■									■	■		■	■
P. 129																		
FN 352Z 	250VAC	6 - 30				■			■		■			■			■	■
P. 131																		
FN 700Z 	250VAC	6 - 20				■			■	■	■		■	■	■		■	■
P. 134																		

* Products evaluated by one or more of the above certification agencies. For details please consult the detailed data sheet.

Performance EMI Filter



energy efficiency and reliability

- Rated currents from 1 to 10A
- Compact housing
- Optional overvoltage protection (Z type)

Approvals



Technical specifications

Maximum continuous operating voltage:	250VAC, 50/60Hz
Operating frequency:	dc to 400Hz
Rated currents:	1 to 10A @ 40°C max.
High potential test voltage:	P → PE 2000VAC for 2 sec P → N 760VAC for 2 sec P → N 250VAC for 2 sec (Z types)
Temperature range (operation and storage):	-25°C to +100°C (25/100/21)
Flammability corresponding to:	UL 94V-2 or better
Design corresponding to:	UL 1283, CSA 22.2 No. 8 1986, IEC/EN 60939
Surge pulse protection (optional):	2kV, IEC 61000-4-5
MTBF @ 40°C/230V (Mil-HB-217F):	710,000 hours

Typical electrical schematic

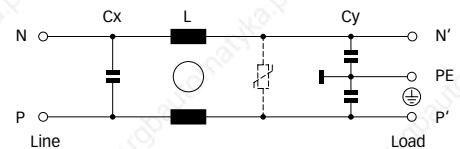

Features and benefits

- FN 332 filters are designed for easy and fast chassis mounting.
- FN 332 filters are also available with integrated surge pulse protection to safeguard sensitive electrical equipment.
- All FN 332 single-phase filters provide a good attenuation performance, based on chokes with high saturation resistance and excellent thermal behavior.
- Chokes with high saturation resistance and high inductivity.
- Surge pulse protection.
- Custom-specific versions on request.

Typical applications

- Electrical and electronic equipment
- Consumer goods
- Household equipment
- Power supplies
- Office automation equipment
- Datacom equipment
- Industrial equipment auxiliary supply

Filter selection table

Filter	Rated current @ 40°C (25°C)	Leakage current* @ 230VAC/50Hz	Inductance L	Capacitance Cx Cy		Surge current	Energy absorption	Input/Output connections	Weight
	[A]	[µA]	[mH]	[nF]	[nF]	[A]	[J]		[g]
FN 332-1-05	1 (1.2)	340	10	15	2.2			-05	65
FN 332-3-05	3 (3.6)	340	2	15	2.2			-05	65
FN 332-6-05	6 (7.3)	340	0.8	15	2.2			-05	65
FN 332-10A-05	10 (12)	340	0.5	15	2.2			-05	70
FN 332Z-1-05	1 (1.2)	340	10	15	2.2	1200	26	-05	65
FN 332Z-3-05	3 (3.6)	340	2	15	2.2	1200	26	-05	65
FN 332Z-6-05	6 (7.3)	340	0.8	15	2.2	1200	26	-05	65
FN 332Z-10-05	10 (12)	340	0.5	15	2.2	1200	26	-05	70

* Maximum leakage under normal operating conditions. Note: if the neutral line is interrupted, worst case leakage could reach twice this level.

Typical filter attenuation

Per CISPR 17; A = 50Ω/50Ω sym; B = 50Ω/50Ω asym; C = 0.1Ω/100Ω sym; D = 100Ω/0.1Ω sym

1A types

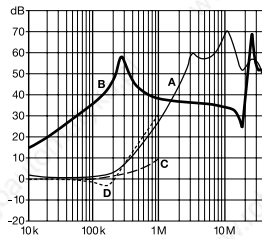

3 and 6A types

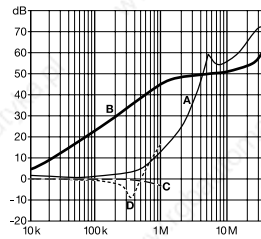

10A types

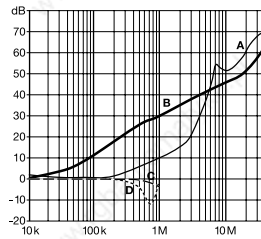

Mechanical data

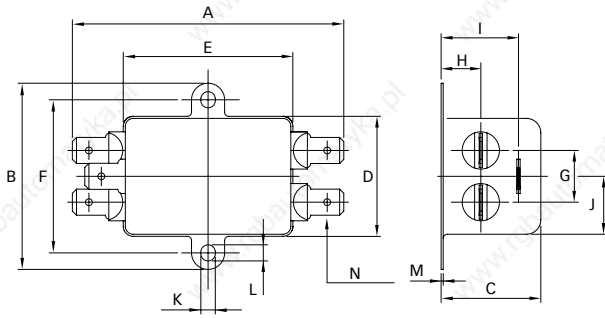

Dimensions

	1 to 10A types	Tolerances
A	65.6	±0.5
B	45	±0.5
C	24.8	±0.5
D	28	±0.5
E	40	±0.5
F	37	±0.4
G	12.5	±0.2
H	9.6	±0.2
I	18.7	±0.5
J	14	±0.5
K	3.5	
L	3.9	
M	0.5	
N	6.3 x 0.8	

All dimensions in mm; 1 inch = 25.4mm

Tolerances according: ISO 2768-m / EN 22768-m

General Purpose EMI Filter

SCHAFFNER
energy efficiency and reliability



- Rated currents from 1 to 60A
- General purpose filtering performance
- Optional medical versions (B type)
- Optional safety versions (A type)

Approvals



ROHS

Technical specifications

Maximum continuous operating voltage:	250VAC, 50/60Hz
Operating frequency:	dc to 400Hz
Rated currents:	1 to 60A @ 40°C max.
High potential test voltage:	P → PE 2000VAC for 2 sec
	P → PE 2500VAC for 2 sec (B types)
	P → N 760VAC for 2 sec (1 to 20A types)
	P → N 1100VDC for 2 sec (30 and 60A types)
Temperature range (operation and storage):	-25°C to +100°C (25/100/21)
Flammability corresponding to:	UL 94V-2 or better
Design corresponding to:	UL 1283, CSA 22.2 No. 8 1986, IEC/EN 60939
MTBF @ 40°C/230V (Mil-HB-217F):	1,250,000 hours
	3,200,000 hours (B types)

Typical electrical schematic

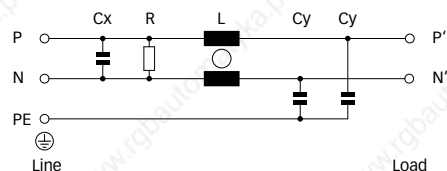

Features and benefits

- FN 2010 filters are designed for easy and fast chassis mounting.
- FN 2010 filters are also available as B versions without Y-capacitors for medical applications as well as A version with low capacitance for safety critical applications with necessity for low leakage currents.
- All filters provide a general purpose conducted attenuation performance, based on chokes with high saturation resistance and excellent thermal behavior.
- FN 2010 filters can be used to cover a broad range of usage and they offer a good size/ampere ratio.
- FN 2010 filters are also available as two-stage filters (FN 2060, FN 2070 series) for more noisy environment.
- Various terminal options allow you to select the desired connection style.

Typical applications

- Electrical and electronic equipment
- Consumer goods
- Household equipment
- Medical equipment
- Office automation equipment
- Datacom equipment

Filter selection table

Filter*	Rated current @ 40°C (25°C)	Leakage current** @ 230VAC/50Hz	Inductance L	Capacitance Cx Cy		Resistance R	Input/Output connections			Weight
	[A]	[mA]	[mH]	[µF]	[nF]	[kΩ]				[g]
FN 2010-1-..	1 (1.15)	0.74	12	0.1	4.7	1000	-06	-07		65
FN 2010-3-..	3 (3.45)	0.74	2.5	0.1	4.7	1000	-06	-07		65
FN 2010-6-..	6 (6.9)	0.74	1	0.1	4.7	1000	-06	-07		65
FN 2010-10-..	10 (11.5)	0.74	0.8	0.1	4.7	1000	-06	-07		85
FN 2010-12-..	12 (13.8)	0.74	0.7	0.1	4.7	1000	-06	-07		85
FN 2010-16-..	16 (18.4)	0.74	0.7	0.1	4.7	1000	-06	-07		140
FN 2010-20-..	20 (23)	0.74	0.6	0.1	4.7	1000	-06	-07	-08	210
FN 2010-30-08	30 (34.5)	0.87	0.7	0.47	10	1000			-08	470
FN 2010-60-24	60 (69)	0.87	1	1.5	10	330			-24	1100
FN 2010A-1-..	1 (1.15)	0.074	12	0.1	0.47	1000	-06	-07		65
FN 2010A-3-..	3 (3.45)	0.074	2.5	0.1	0.47	1000	-06	-07		65
FN 2010A-6-..	6 (6.9)	0.074	1	0.1	0.47	1000	-06	-07		65
FN 2010A-10-..	10 (11.5)	0.074	0.8	0.1	0.47	1000	-06	-07		85
FN 2010A-12-..	12 (13.8)	0.074	0.7	0.1	0.47	1000	-06	-07		85
FN 2010A-16-..	16 (18.4)	0.074	0.7	0.1	0.47	1000	-06	-07		140
FN 2010A-20-..	20 (23)	0.074	0.6	0.1	0.47	1000	-06	-07	-08	210
FN 2010A-30-08	30 (34.5)	0.074	0.7	0.47	0.47	1000			-08	470
FN 2010A-60-24	60 (69)	0.074	1	1.5	0.47	330			-24	1100
FN 2010B-1-..	1 (1.15)	0.002	12	0.1		1000	-06	-07		65
FN 2010B-3-..	3 (3.45)	0.002	2.5	0.1		1000	-06	-07		65
FN 2010B-6-..	6 (6.9)	0.002	1	0.1		1000	-06	-07		65
FN 2010B-10-..	10 (11.5)	0.002	0.8	0.1		1000	-06	-07		85
FN 2010B-12-..	12 (13.8)	0.002	0.7	0.1		1000	-06	-07		85
FN 2010B-16-..	16 (18.4)	0.002	0.7	0.1		1000	-06	-07		140
FN 2010B-20-..	20 (23)	0.002	0.6	0.1		1000	-06	-07	-08	210
FN 2010B-30-08	30 (34.5)	0.002	0.7	0.47		1000			-08	470
FN 2010B-60-24	60 (69)	0.002	1	1.5		330			-24	1100

* To compile a complete part number, please replace the .. with the required I/O connection style (e.g. FN 2010-30-08, FN 2010B-10-06).

** Maximum leakage under normal operating conditions. Note: if the neutral line is interrupted, worst case leakage could reach twice this level.

Typical filter attenuation

Per CISPR 17; A = 50Ω/50Ω sym; B = 50Ω/50Ω asym; C = 0.1Ω/100Ω sym; D = 100Ω/0.1Ω sym

1 and 3A types

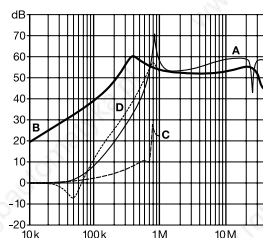

6 to 12A types

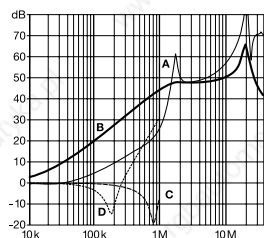

16 and 20A types

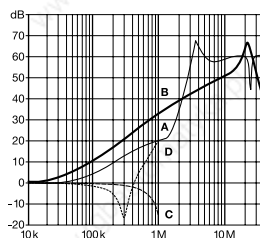

30 and 60A types

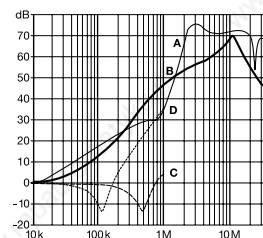

Mechanical data

Connection style -06, 1 to 12A types

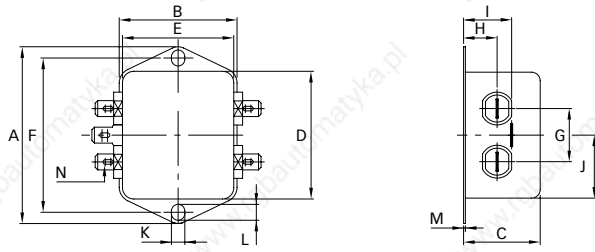

Connection style -06, 16 and 20A types

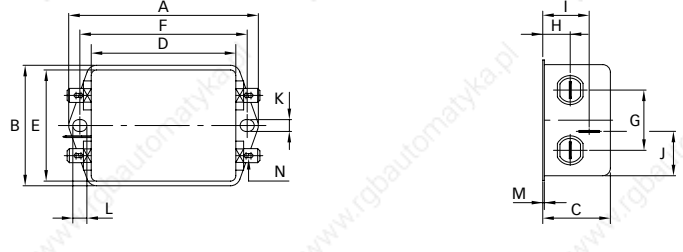

Connection style -07, 1 to 12A types (same dimensions as style -06)

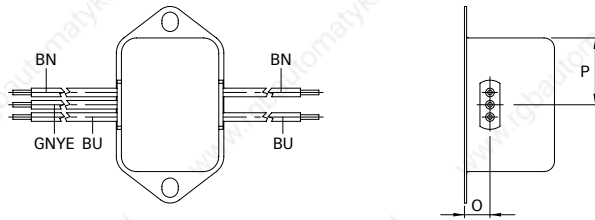

Connection style -07, 16 and 20A types (same dimensions as style -06)

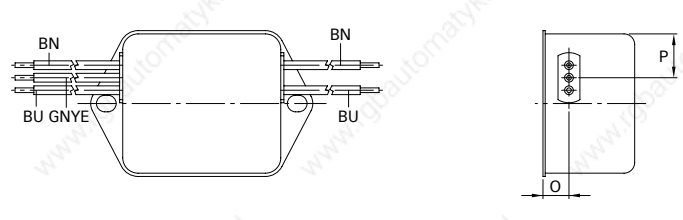

Connection style -08, 20A types

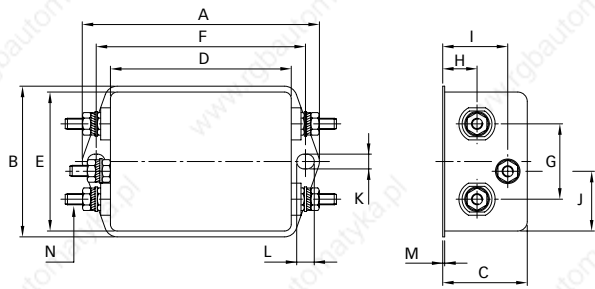

Connection style -08, 30A types

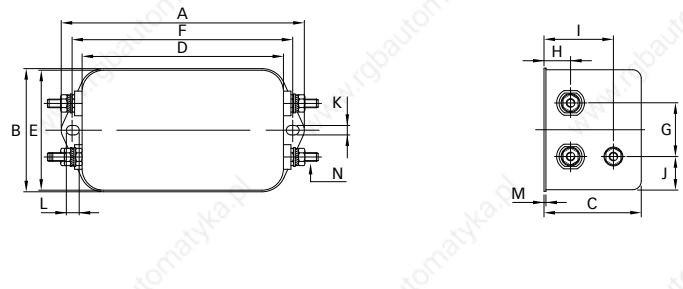

Connection style -24

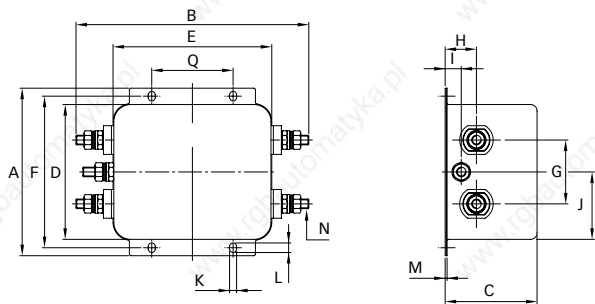

Dimensions

	1A	3A	6A	10A	12A	16A	20A	30A	60A	Tolerances
A	64	64	64	64	64	71	85	113.5 ±1	105 ±1	±0.5
B	35	35	35	35	35	46.6	54	57.5 ±1	145.9 ±1	±0.5
C	24.3	24.3	24.3	29.3	29.3	29.3	30.3	45.4 ±1	57.6 ±1	±0.5
D	43.5	43.5	43.5	43.5	43.5	50.5	64.8	94 ±1	84.5 ±1	±0.5
E	32.5	32.5	32.5	32.5	32.5	44.5	49.8	56	99.5	±0.5
F	54	54	54	54	54	61	75	103	95	±0.3
G	21	21	21	21	21	21	27	25	40	±0.2
H	9.3	9.3	9.3	9.3	9.3	10.8	12.3	12.4	19.6	±0.5
I	15.3	15.3	15.3	15.3	15.3	19.3	20.8	32.4	10.1	±0.5
J	21.8	21.8	21.8	21.8	21.8	20.1	19.9	15.5	42.25	±0.5
K	5.3	5.3	5.3	5.3	5.3	5.3	5.3	4.4	4.4	
L	6.3	6.3	6.3	6.3	6.3	6.3	6.3	6	6	
M	0.7	0.7	0.7	0.7	0.7	0.7	0.7	0.9	1.2	
Connection style -06										
N	6.3 x 0.8	6.3 x 0.8	6.3 x 0.8	6.3 x 0.8	6.3 x 0.8	6.3 x 0.8	6.3 x 0.8	6.3 x 0.8		
Connection style -07										
O	8.3	8.3	8.3	8.3	8.3	8.3	8.3			±0.5
P	21.8	21.8	21.8	21.8	21.8	14	14.9			±0.5
AWG type wire	AWG 20	AWG 20	AWG 18	AWG 18	AWG 16	AWG 16	AWG 14			
Wire length	140	140	140	140	140	140	140			+5
Connection style -08										
N							M4	M4		
Connection style -24										
N									M6	
Q									51	±0.2

All dimensions in mm; 1 inch = 25.4mm
Tolerances according: ISO 2768-m / EN 22768-m

General Purpose EMI Filter

SCHAFFNER
energy efficiency and reliability



- Rated currents from 1 to 60A
- High differential-mode attenuation
- Optional medical versions (B type)
- Optional safety versions (A type)

Approvals



ROHS

Technical specifications

Maximum continuous operating voltage:	250VAC, 50/60Hz
Operating frequency:	dc to 400Hz
Rated currents:	1 to 60A @ 40°C max.
High potential test voltage:	P → PE 2000VAC for 2 sec
	P → PE 2500VAC for 2 sec (B types)
	P → N 760VAC for 2 sec (1 to 20A types)
	P → N 1100VDC for 2 sec (30 and 60A types)
Temperature range (operation and storage):	-25°C to +100°C (25/100/21)
Flammability corresponding to:	UL 94V-2 or better
Design corresponding to:	UL 1283, CSA 22.2 No. 8 1986, IEC/EN 60939
MTBF @ 40°C/230V (Mil-HB-217F):	1,250,000 hours
	1,750,000 hours (B types)

Typical electrical schematic

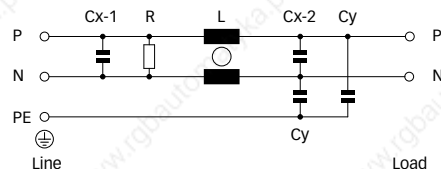

Features and benefits

- FN 2020 filters are designed for easy and fast chassis mounting.
- FN 2020 filters are also available as B versions without Y-capacitors for medical applications as well as A version with low capacitance for safety critical applications with necessity for low leakage currents.
- All filters provide a general purpose conducted attenuation performance, based on chokes with high saturation resistance and excellent thermal behavior.
- FN 2020 filters can be used to cover a broad range of usage and they offer a good size/ampereage ratio.
- FN 2020 filters are also available as two-stage filters (FN 2060, FN 2070 series) for more noisy environment.
- Various terminal options allow you to select the desired connection style.

Typical applications

- Electrical and electronic equipment
- Consumer goods
- Household equipment
- Medical equipment
- Office automation equipment
- Datacom equipment

Filter selection table

Filter*	Rated current @ 40°C (25°C)	Leakage current** @ 230VAC/50Hz	Inductance L	Capacitance Cx Cy		Resistance R	Input/Output connections			Weight
	[A]	[mA]	[mH]	[µF]	[nF]	[kΩ]				[g]
FN 2020-1-..	1 (1.15)	0.74	12	0.15	4.7	1000	-06	-07		80
FN 2020-3-..	3 (3.45)	0.74	2.5	0.15	4.7	1000	-06	-07		80
FN 2020-6-..	6 (6.9)	0.74	1	0.15	4.7	1000	-06	-07		80
FN 2020-10-..	10 (11.5)	0.74	0.8	0.15	4.7	1000	-06	-07		85
FN 2020-12-..	12 (13.8)	0.74	0.7	0.15	4.7	1000	-06	-07		85
FN 2020-16-..	16 (18.4)	0.74	0.65	0.15	4.7	1000	-06	-07		140
FN 2020-20-..	20 (23)	0.74	0.6	0.15	4.7	1000	-06		-08	210
FN 2020-30-08	30 (34.5)	0.87	0.67	0.47	10	470			-08	470
FN 2020-60-24	60 (69)	0.87	1	1.5	10	220			-24	1100
FN 2020A-1-..	1 (1.15)	0.074	12	0.15	0.47	1000	-06	-07		80
FN 2020A-3-..	3 (3.45)	0.074	2.5	0.15	0.47	1000	-06	-07		80
FN 2020A-6-..	6 (6.9)	0.074	1	0.15	0.47	1000	-06	-07		80
FN 2020A-10-..	10 (11.5)	0.074	0.8	0.15	0.47	1000	-06	-07		85
FN 2020A-12-..	12 (13.8)	0.074	0.7	0.15	0.47	1000	-06	-07		85
FN 2020A-16-..	16 (18.4)	0.074	0.65	0.15	0.47	1000	-06	-07		140
FN 2020A-20-..	20 (23)	0.074	0.6	0.15	0.47	1000	-06		-08	210
FN 2020A-30-08	30 (34.5)	0.074	0.67	0.47	0.47	470			-08	470
FN 2020A-60-24	60 (69)	0.074	1	1.5	0.47	220			-24	1100
FN 2020B-1-..	1 (1.15)	0.002	12	0.15		1000	-06	-07		80
FN 2020B-3-..	3 (3.45)	0.002	2.5	0.15		1000	-06	-07		80
FN 2020B-6-..	6 (6.9)	0.002	1	0.15		1000	-06	-07		80
FN 2020B-10-..	10 (11.5)	0.002	0.8	0.15		1000	-06	-07		85
FN 2020B-12-..	12 (13.8)	0.002	0.7	0.15		1000	-06	-07		85
FN 2020B-16-..	16 (18.4)	0.002	0.65	0.15		1000	-06	-07		140
FN 2020B-20-..	20 (23)	0.002	0.6	0.15		1000	-06		-08	210
FN 2020B-30-08	30 (34.5)	0.002	0.67	0.47		470			-08	470
FN 2020B-60-24	60 (69)	0.002	1	1.5		220			-24	1100

* To compile a complete part number, please replace the .. with the required I/O connection style (e.g. FN 2020-30-08, FN 2020B-10-06).

** Maximum leakage under normal operating conditions. Note: if the neutral line is interrupted, worst case leakage could reach twice this level.

Typical filter attenuation

Per CISPR 17; A = 50Ω/50Ω sym; B = 50Ω/50Ω asym; C = 0.1Ω/100Ω sym; D = 100Ω/0.1Ω sym

1 and 3A types

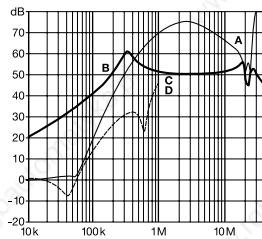

6 to 12A types

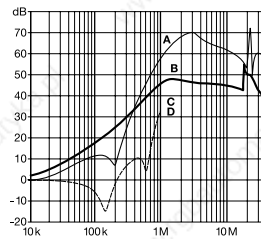

16 and 20A types

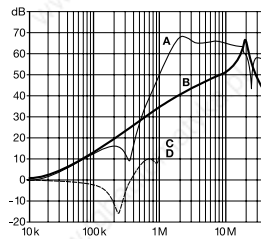

30 and 60A types

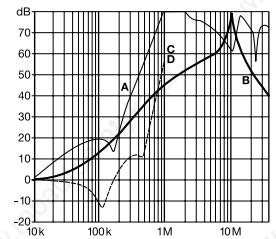

Mechanical data

Connection style -06, 1 to 12A types

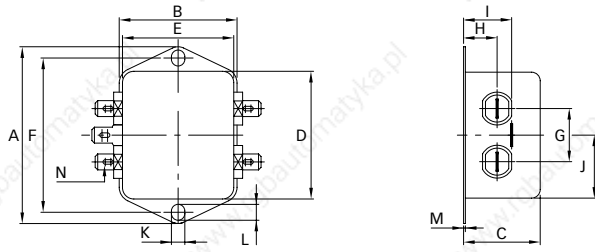

Connection style -06, 16 and 20A types

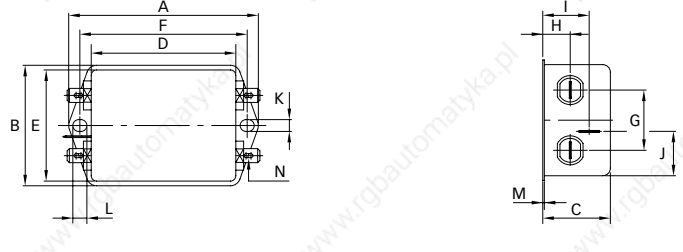

Connection style -07, 1 to 12A types (same dimensions as style -06)

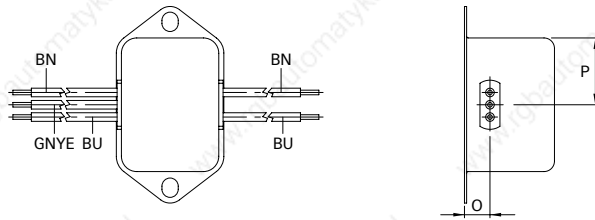

Connection style -07, 16A types (same dimensions as style -06)

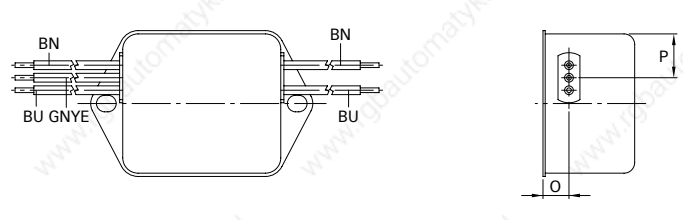

Connection style -08, 20A types

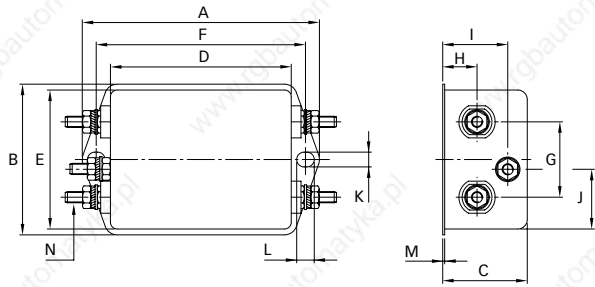

Connection style -08, 30A types

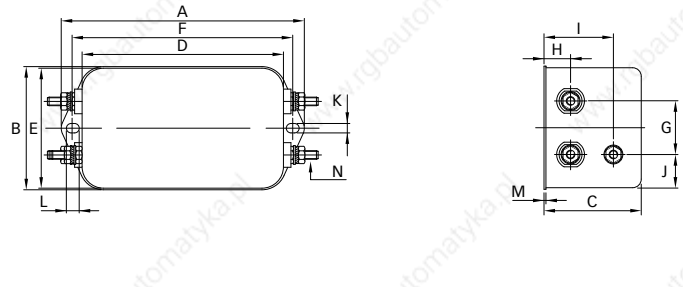

Connection style -24

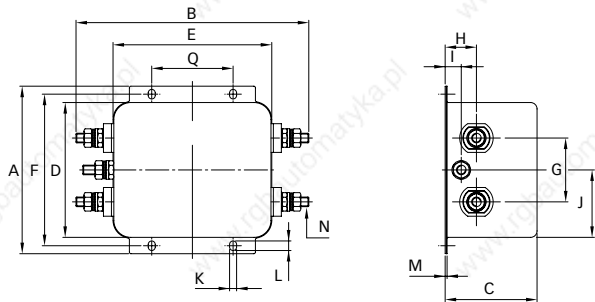

Dimensions

	1A	3A	6A	10A	12A	16A	20A	30A	60A	Tolerances
A	64	64	64	64	64	71	85	113.5 ±1	105 ±1	±0.5
B	35	35	35	35	35	46.6	54	57.5 ±1	145.9 ±1	±0.5
C	29.3	29.3	29.3	29.3	29.3	29.3	30.3	45.4 ±1	57.6 ±1	±0.5
D	43.5	43.5	43.5	43.5	43.5	50.5	64.8	94 ±1	84.5 ±1	±0.5
E	32.5	32.5	32.5	32.5	32.5	44.5	49.8	56	99.5	±0.5
F	54	54	54	54	54	61	75	103	95	±0.3
G	21	21	21	21	21	21	27	25	40	±0.2
H	9.3	9.3	9.3	9.3	9.3	10.8	12.3	12.4	19.6	±0.5
I	15.3	15.3	15.3	15.3	15.3	19.3	20.8	32.4	10.1	±0.5
J	21.8	21.8	21.8	21.8	21.8	20.1	19.9	15.5	42.25	±0.5
K	5.3	5.3	5.3	5.3	5.3	5.3	5.3	4.4	4.4	
L	6.3	6.3	6.3	6.3	6.3	6.3	6.3	6	6	
M	0.7	0.7	0.7	0.7	0.7	0.7	0.7	0.9	1.2	
Connection style -06										
N	6.3 x 0.8	6.3 x 0.8	6.3 x 0.8	6.3 x 0.8	6.3 x 0.8	6.3 x 0.8	6.3 x 0.8	6.3 x 0.8		
Connection style -07										
O	8.3	8.3	8.3	8.3	8.3	8.3				±0.5
P	21.8	21.8	21.8	21.8	21.8	14				±0.5
AWG type wire	AWG 20	AWG 20	AWG 18	AWG 18	AWG 16	AWG 16				
Wire length	140	140	140	140	140	140				+5
Connection style -08										
N							M4	M4		
Connection style -24										
N									M6	
Q									51	±0.2

All dimensions in mm; 1 inch = 25.4mm
Tolerances according: ISO 2768-m / EN 22768-m

General Purpose EMI Filter with High Attenuation Performance

SCHAFFNER
energy efficiency and reliability



- Rated currents from 1 to 30A
- High performance filter attenuation
- High differential-mode attenuation
- Optional medical versions (B type)
- Optional safety versions (A type)
- Optional overvoltage protection (Z type)

Approvals



ROHS

Technical specifications

Maximum continuous operating voltage:	250VAC, 50/60Hz
Operating frequency:	dc to 400Hz
Rated currents:	1 to 30A @ 40°C max.
High potential test voltage:	P → PE 2000VAC for 2 sec (standard types) P → PE 2500VAC for 2 sec (B types) P → N 1100VDC for 2 sec
Temperature range (operation and storage):	-25°C to +100°C (25/100/21)
Design corresponding to:	UL 1283, CSA 22.2 No. 8 1986, IEC/EN 60939
Flammability corresponding to:	UL 94V-2 or better
Surge pulse protection (optional):	2kV, IEC 61000-4-5
MTBF @ 40°C/230V (Mil-HB-217F):	2,200,000 hours (1 to 10A types) 1,200,000 hours (12 to 30A types)

Typical electrical schematic

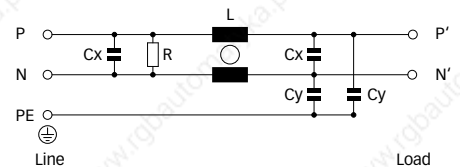

Features and benefits

- FN 2030 filters are designed for easy and fast chassis mounting.
- The FN 2030 filters are also available as B versions with no Y-capacitors for medical applications as well as A versions with low capacitance for safety critical applications with a requirement for low leakage currents.
- All filters provide an exceptional conducted attenuation performance, based on chokes with high permeable core material and excellent thermal behavior.
- The higher inductivity versus amperage offers increased attenuation performance with same form factor compared to FN 2010 and FN 2020 filter series.
- All FN 2030 filters can be delivered with optional surge pulse protection.
- FN 2030 filters are also available as two-stage filters (FN 2090 series) for very noisy environment.
- Various terminal options allow you to select the desired connection style.

Typical applications

- Electrical and electronic equipment
- Consumer goods
- Household equipment
- Medical equipment
- Electronic data processing equipment
- Office automation and datacom equipment
- Various noisy applications requiring high filter performance

Filter selection table

Filter*	Rated current @ 40°C (25°C)	Leakage current** @ 230VAC/50Hz	Inductance L	Capacitance Cx Cy		Resistance R	Input/Output connections			Weight
	[A]	[mA]	[mH]	[µF]	[nF]	[kΩ]				[g]
FN 2030-1-..	1 (1.1)	0.34	20	0.22	2.2	1000	-06	-07		58
FN 2030-3-..	3 (3.4)	0.52	14	0.33	3.3	1000	-06	-07		87
FN 2030-4-..	4 (4.5)	0.52	14	0.33	3.3	1000	-06	-07		92
FN 2030-6-..	6 (6.7)	0.73	8	0.47	4.7	680	-06	-07		100
FN 2030-8-..	8 (8.9)	0.73	8	0.47	4.7	680	-06	-07		170
FN 2030-10-..	10 (11.2)	0.73	8	0.47	4.7	680	-06	-07		196
FN 2030-12-..	12 (13.4)	0.87	4	1.0	10	330	-06	-07		185
FN 2030-16-..	16 (17.9)	0.87	4	1.0	10	330	-06	-07		225
FN 2030-20-..	20 (22.4)	0.87	4	1.0	10	330	-06		-08	285
FN 2030-30-08	30 (33.5)	0.87	2	1.0	10	330			-08	326
FN 2030A-1-..	1 (1.1)	0.074	20	0.22	0.47	1000	-06	-07		58
FN 2030A-3-..	3 (3.4)	0.074	14	0.33	0.47	1000	-06	-07		87
FN 2030A-4-..	4 (4.5)	0.074	14	0.33	0.47	1000	-06	-07		92
FN 2030A-6-..	6 (6.7)	0.074	8	0.47	0.47	680	-06	-07		100
FN 2030A-8-..	8 (8.9)	0.074	8	0.47	0.47	680	-06	-07		170
FN 2030A-10-..	10 (11.2)	0.074	8	0.47	0.47	680	-06	-07		196
FN 2030A-12-..	12 (13.4)	0.074	4	1.0	0.47	330	-06	-07		185
FN 2030A-16-..	16 (17.9)	0.074	4	1.0	0.47	330	-06	-07		225
FN 2030A-20-..	20 (22.4)	0.074	4	1.0	0.47	330	-06		-08	285
FN 2030A-30-08	30 (33.5)	0.074	2	1.0	0.47	330			-08	326
FN 2030B-1-..	1 (1.1)	0.002	20	0.22		1000	-06	-07		58
FN 2030B-3-..	3 (3.4)	0.002	14	0.33		1000	-06	-07		87
FN 2030B-4-..	4 (4.5)	0.002	14	0.33		1000	-06	-07		92
FN 2030B-6-..	6 (6.7)	0.002	8	0.47		680	-06	-07		100
FN 2030B-8-..	8 (8.9)	0.002	8	0.47		680	-06	-07		170
FN 2030B-10-..	10 (11.2)	0.002	8	0.47		680	-06	-07		196
FN 2030B-12-..	12 (13.4)	0.002	4	1.0		330	-06	-07		185
FN 2030B-16-..	16 (17.9)	0.002	4	1.0		330	-06	-07		225
FN 2030B-20-..	20 (22.4)	0.002	4	1.0		330	-06		-08	285
FN 2030B-30-08	30 (33.5)	0.002	2	1.0		330			-08	326

* To compile a complete part number, please replace the -.. with the required I/O connection style. For surge pulse protection, please add Z (e.g. FN 2030Z-10-06, FN 2030BZ-20-08).
 ** Maximum leakage under normal operating conditions. Note: if the neutral line is interrupted, worst case leakage could reach twice this level.

Typical filter attenuation

Per CISPR 17; A = 50Ω/50Ω sym; B = 50Ω/50Ω asym; C = 0.1Ω/100Ω sym; D = 100Ω/0.1Ω sym

1 to 4A types

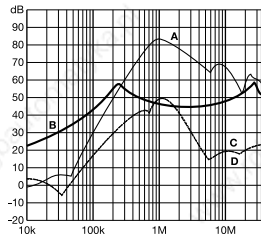

6 to 10A types

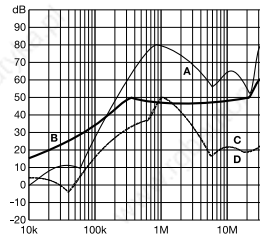

12 to 20A types

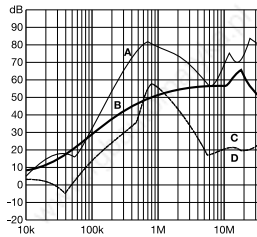

30A types

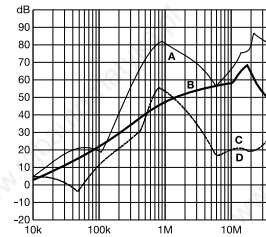

Mechanical data

Connection style -06, 1A types

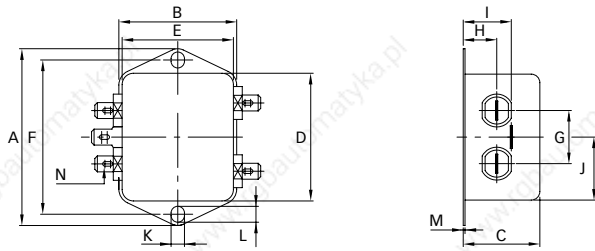

Connection style -06, 8 to 20A types

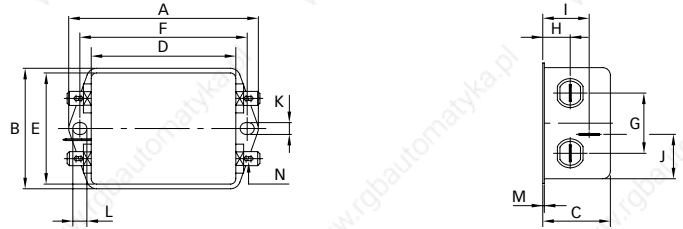

Connection style -06, 3 to 6A types

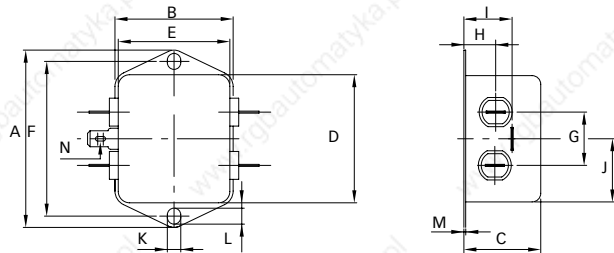

Connection style -07, 8 to 16A types (same dimensions as style -06)

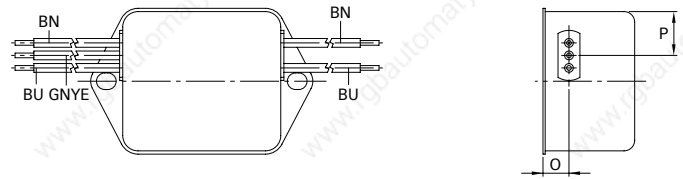

Connection style -07, 1 to 6A types (same dimensions as style -06)

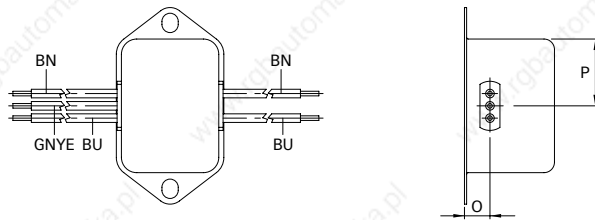

Connection style -08, 20 and 30A types

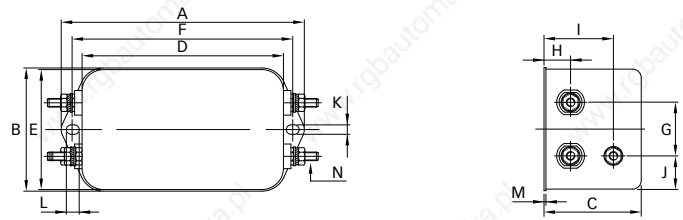

Dimensions

	1A	3A	4A	6A	8A	10A	12A	16A	20A	30A	Tolerances
A	64	71	71	71	85	85	85	85	85	85	±0.5
B	35	46.6	46.6	46.6	54	54	54	54	54	54	±0.5
C	24.3	22.3	22.3	22.3	30.3	30.3	30.3	40.3	40.3	40.3	±0.5
D	43.5	50.5	50.5	50.5	64.8	64.8	64.8	64.8	64.8	64.8	±0.5
E	32.5	44.5	44.5	44.5	49.8	49.8	49.8	49.8	49.8	49.8	±0.5
F	54	61	61	61	75	75	75	75	75	75	±0.3
G	21	21	21	21	27	27	27	27	27	27	±0.2
H	9.3	10.8	10.8	10.8	12.3	12.3	12.3	12.3	12.3	12.3	±0.5
I	15.3	16.8	16.8	16.8	20.8	20.8	20.8	29.8	29.8	29.8	±0.5
J	21.8	25.25	25.25	25.25	19.9	19.9	19.9	11.4	11.4	11.4	±0.5
K	5.3	5.3	5.3	5.3	5.3	5.3	5.3	5.3	5.3	5.3	
L	6.3	6.3	6.3	6.3	6.3	6.3	6.3	6.3	6.3	6.3	
M	0.7	0.7	0.7	0.7	0.7	0.7	0.7	0.7	0.7	0.7	

Connection style -06

N	6.3 x 0.8	6.3 x 0.8	6.3 x 0.8	6.3 x 0.8	6.3 x 0.8	6.3 x 0.8	6.3 x 0.8	6.3 x 0.8	6.3 x 0.8	6.3 x 0.8	
----------	-----------	-----------	-----------	-----------	-----------	-----------	-----------	-----------	-----------	-----------	--

Connection style -07

O	8.3	8.3	8.3	8.3	8.3	8.3	8.3	8.3			±0.5
P	21.8	14	14	14	14.9	14.9	14.9	14.9			±0.5

AWG type wire	AWG 20	AWG 20	AWG 20	AWG 18	AWG 18	AWG 18	AWG 16	AWG 16			
----------------------	--------	--------	--------	--------	--------	--------	--------	--------	--	--	--

Wire length*	140	140	140	140	140	140	140	140			
---------------------	-----	-----	-----	-----	-----	-----	-----	-----	--	--	--

Connection style -08

N									M4	M4	
----------	--	--	--	--	--	--	--	--	----	----	--

All dimensions in mm; 1 inch = 25.4mm

Tolerances according: ISO 2768-m / EN 22768-m

* Other cable length or additional wire connector on request.

Safe and Ergonomic EMC/EMI Filter with very Low Leakage Current

SCHAFFNER
energy efficiency and reliability



- Light weight plastic enclosure design
- Very low filter leakage current
- Hinged safety covers
- Embedded filter terminals
- Different performance levels
- Environmental friendly design without potting compound
- Optional medical versions (B type) according IEC/EN 60601-1

Approvals



ROHS

Technical specifications

Maximum continuous operating voltage:	250VAC, 50/60Hz
Operating frequency:	dc to 400Hz
Rated currents:	6 to 20A @ 55°C
High potential test voltage:	P/N → PE 2500VAC for 60 sec* P → N 1100VDC for 2 sec
Temperature range (operation and storage):	-25°C to +100°C (25/100/21)
Flammability corresponding to:	UL 94V-0 (safety covers UL 94V-1)
Design corresponding to:	UL 1283, CSA 22.2 No. 8 1986, IEC/EN 60939, EN 60601-1
MTBF @ 40°C/230V (Mil-HB-217F):	>180,000 hours

* Type testing only

Typical electrical schematic

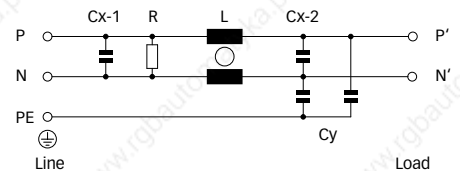

Features and benefits

- A plastic housing and a metal ground plate are cleverly combined to get the lowest possible product weight without compromising EMC behavior.
- The embedded terminals from Schaffner guarantee user-friendly handling and reliable, long-lasting electrical connection.
- Captive hinged protective covers contribute to overall safety by offering protection against unintended contact with live conductors. They are included in the standard scope of delivery without any extra cost.
- Optional medical versions (B type) comply with the requirements of IEC/EN 60601-1 for creepage and clearance, leakage current and high potential testing.
- Very low leakage current values make the filters suitable for grids with very tough requirements or sensitive GFCIs, and for applications which set value on safety and reliability.
- FN 2450 feature an ecologically conscious construction without the use of potting compound or banned substances (RoHS). Used raw materials can be easily separated at the end of the product life time for proper and environmentally safe disposal.

Typical applications

- Electrical and electronic equipment
- Test and measurement devices
- Medical devices
- Industrial automation
- Small machines
- Office automation equipment

Filter selection table

Filter*	Rated current @ 55°C (40°C)	Leakage current** @ 230VAC/50Hz	Inductance L	Capacitance		Resistance R	Input/Output connections	Weight
	[A]			[mA]	Cx [μF]			
FN 2450G-6-61	6 (6.8)	0.73	10.5	0.47	4.7	1	-61	210
FN 2450G-10-61	10 (11.4)	0.73	4.9	0.47	4.7	1	-61	210
FN 2450G-16-61	16 (18.2)	0.73	1.84	0.47	4.7	1	-61	210
FN 2450G-20-61	20 (22.8)	0.73	0.94	0.47	4.7	1	-61	210
FN 2450F-6-61	6 (6.8)	0.52	10.5	0.47	3.3	1	-61	210
FN 2450F-10-61	10 (11.4)	0.52	4.9	0.47	3.3	1	-61	210
FN 2450F-16-61	16 (18.2)	0.52	1.84	0.47	3.3	1	-61	210
FN 2450F-20-61	20 (22.8)	0.52	0.94	0.47	3.3	1	-61	210
FN 2450B-6-61	6 (6.8)	0.002	10.5	0.47		1	-61	210
FN 2450B-10-61	10 (11.4)	0.002	4.9	0.47		1	-61	210
FN 2450B-16-61	16 (18.2)	0.002	1.84	0.47		1	-61	210
FN 2450B-20-61	20 (22.8)	0.002	0.94	0.47		1	-61	210

* The letter following FN 2450_ represents the value of the Y-capacitor and is directly related to the performance and leakage current of the filter. Other Y-capacitor values are available upon request.
 ** Maximum leakage current under normal operating conditions. Note: if the neutral line is interrupted, worst case leakage could reach twice this level.

Typical filter attenuation (FN 2450F)

Per CISPR 17; A = 50Ω/50Ω sym; B = 50Ω/50Ω asym

6A types

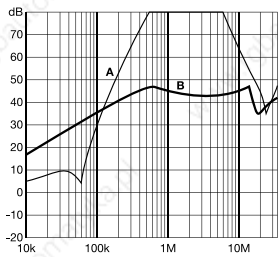

10A types

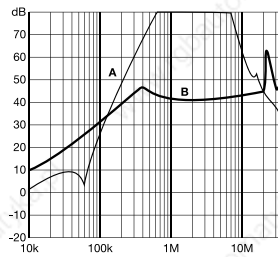

16A types

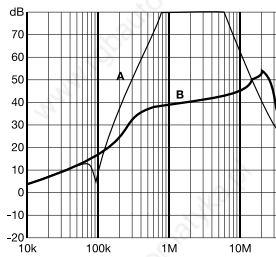

20A types

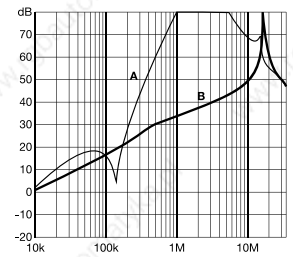

Installation



FN 2450 are delivered with closed plastic covers and fastened terminals. To install the filter please proceed as follows:

- Mount the filter on a metal surface with two appropriate bolts.
- First connect the green/yellow wire to the earth stud of the filter.
- Gently lift the two hinged plastic covers.
- Untighten the terminals with an appropriately sized screw driver.
- Connect phase and neutral wires with cable lugs by pushing down and tightening the bolts.
- Please note the torque recommendation on the next page.
- Push the safety covers back into their locked position to finish the filter installation.

Mechanical data

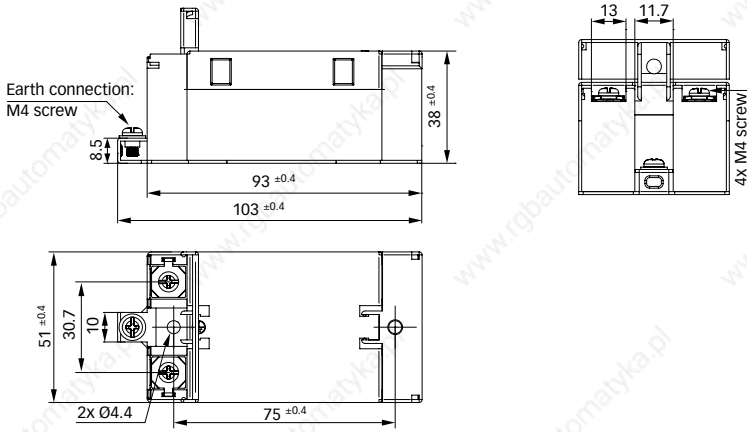

Filter input/output connector cross sections

	-61 (6A)	-61 (10A)	-61 (16A)	-61 (20A)
Flex wire	1.3 - 2.5mm ²	1.3 - 2.5mm ²	4 - 6mm ²	4 - 6mm ²
AWG type wire	AWG 13 - AWG 16	AWG 13 - AWG 16	AWG 12 - AWG 10	AWG 12 - AWG 10
Ring/fork lug (W/d)*	max. 11mm/min. Ø4.3mm	max. 11mm/min. Ø4.3mm	max. 11mm/min. Ø4.3mm	max. 11mm/min. Ø4.3mm
Recommended torque	0.8 - 1Nm	0.8 - 1Nm	0.8 - 1Nm	0.8 - 1Nm

* Schaffner recommends the use of insulated and UL-recognized ring lugs or fork lugs of the appropriate size. Please visit www.schaffner.com to find more details on filter connectors.

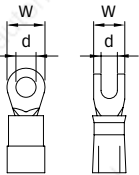

Compact Performance EMI Filter



energy efficiency and reliability

- Rated currents from 3 to 16A
- Economic high performance filter

Approvals





Technical specifications

Maximum continuous operating voltage:	250VAC, 50/60Hz
Operating frequency:	dc to 400Hz
Rated currents:	3 to 16A @ 40°C max.
High potential test voltage:	P → PE 2000VAC for 2 sec P → N 760VAC for 2 sec
Temperature range (operation and storage):	-25°C to +100°C (25/100/21)
Flammability corresponding to:	UL 94V-2 or better
Design corresponding to:	UL 1283, CSA 22.2 No. 8 1986, IEC/EN 60939
MTBF @ 40°C/230V (Mil-HB-217F):	400,000 hours (FN 9675) 280,000 hours (FN 9676)

Typical electrical schematic

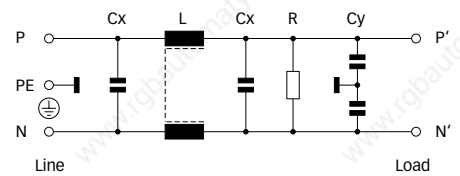
FN 9675



FN 9676

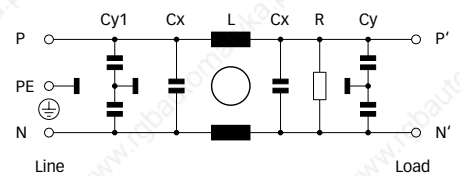

Features and benefits

- FN 9675 filters are designed for easy and fast chassis mounting.
- FN 9675 offers a economic combination of performance/size ratio.
- All filters provide a high symmetrical and asymmetrical attenuation performance, based on chokes with high saturation resistance and excellent thermal behavior.
- Economic high performance filter attenuation suitable to be used in a broad range of applications.
- Fast connection with additional spade solder possibility or screw connection.
- Custom-specific versions on request.

Typical applications

- Electrical and electronic equipment
- Consumer goods
- Household equipment
- Power supplies
- Office automation equipment
- Datacom equipment

Filter selection table

Filter	Rated current @ 40°C (25°C)	Leakage current* @ 230VAC/50Hz	Inductance L	Capacitance			Resistance R	Input/Output connections	Weight [g]
	[A]	[µA]	[mH]	Cx [nF]	Cy [nF]	Cy1 [nF]	[kΩ]		
FN 9675-3-06	3 (3.5)	410	18	680	4.7		470	-06	270
FN 9675-6-06	6 (6.9)	410	3	680	4.7		470	-06	270
FN 9675-16-03	16 (18.4)	410	10.2	1000	4.7		470	-03	850
FN 9676-16-03	16 (18.4)	1900	10.2	1000	15	6.8	470	-03	1050

* Maximum leakage under normal operating conditions. Note: if the neutral line is interrupted, worst case leakage could reach twice this level.

Typical filter attenuation

Per CISPR 17; A = 50Ω/50Ω sym; B = 50Ω/50Ω asym; C = 0.1Ω/100Ω sym; D = 100Ω/0.1Ω sym

3A types

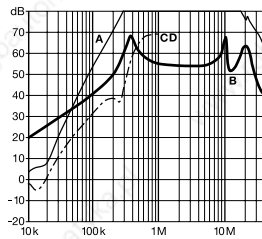

6A types

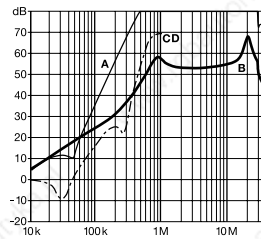

16A types (FN 9675)

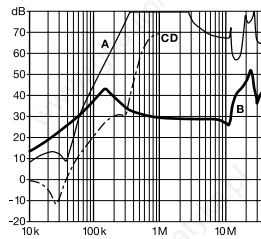

16A types (FN 9676)

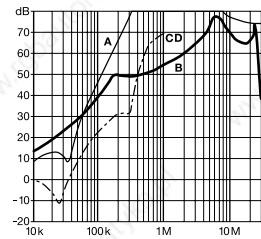

Mechanical data

3 and 6A types

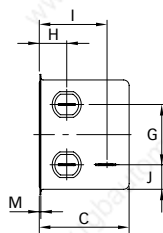
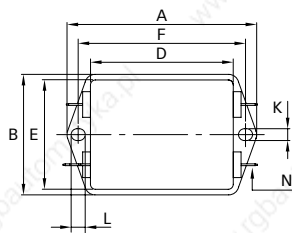

16A types

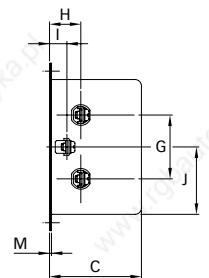
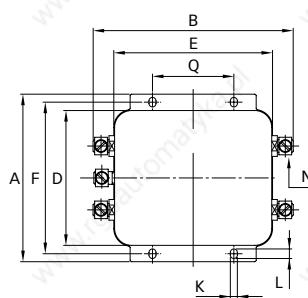

Dimensions

	3A	6A	16A	Tolerances
A	85	85	105	±0.5
B	54	54	126	±0.5
C	40.3	40.3	57	±1
D	64.4	64.4	84.5	±1
E	49.8	49.8	99.5	±0.5
F	75	75	95	±0.2
G	27	27	40	±0.5
H	12.3	12.3	19	±0.5
I	29.8	29.8	11	±0.5
J	11.4	11.4	42.25	±0.5
K	5.3	5.3	4.4	
L	6.3	6.3	6	
M	0.7	0.7	1.2	
N	6.3 x 0.8	6.3 X 0.8	UNC 8-32	
Q			51	±0.1

All dimensions in mm; 1 inch = 25.4mm
Tolerances according: ISO 2768-m / EN 22768-m

Performance EMI Filter

SCHAFNER

energy efficiency and reliability



- Rated currents from 1 to 10A
- Dual-stage filter
- Compact housing
- Integrated earth line choke

Approvals

ROHS

Technical specifications

Maximum continuous operating voltage:	250VAC, 50/60Hz
Operating frequency:	dc to 400Hz
Rated currents:	1 to 10A @ 40°C max.
High potential test voltage:	P → PE 2000VAC for 2 sec P → N 760VAC for 2 sec
Temperature range (operation and storage):	-25°C to +100°C (25/100/21)
Flammability corresponding to:	UL 94V-2 or better
Design corresponding to:	UL 1283, CSA 22.2 No. 8 1986, IEC/EN 60939
MTBF @ 40°C/230V (Mil-HB-217F):	970,000 hours

Typical electrical schematic

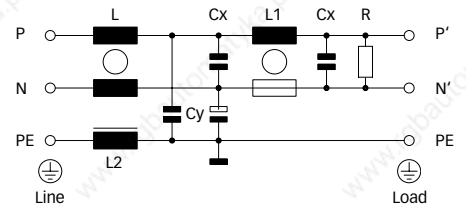

Features and benefits

- FN 343 filters are designed for easy and fast chassis mounting.
- Increased attenuation performance based on dual-stage filter design and earth line choke.
- All FN 343 single-phase filters provide an excellent attenuation performance, based on chokes with high saturation and excellent thermal behavior.
- Faston connection.
- Integrated earth line choke.
- Compact design.
- Custom-specific versions on request.

Typical applications

- Electrical and electronic equipment
- Consumer goods
- Household equipment
- Power supplies
- Office automation equipment
- Datacom equipment
- Industrial equipment auxiliary supply

Filter selection table

Filter	Rated current @ 40°C (25°C)	Leakage current* @ 230VAC/50Hz	Inductance			Capacitance		Resistance R	Input/Output connections	Weight
			L	L1	L2	Cx	Cy			
	[A]	[µA]	[mH]	[mH]	[mH]	[nF]	[nF]	[MΩ]		[g]
FN 343-1-05	1 (1.15)	340	5.6	10	0.4	100	2.2	1	-05	160
FN 343-3-05	3 (3.4)	340	1.1	2	0.4	100	2.2	1	-05	160
FN 343-6-05	6 (6.9)	340	0.43	0.77	0.4	100	2.2	1	-05	160
FN 343-10-05	10 (11.5)	340	0.27	0.66	0.4	100	2.2	1	-05	170

* Maximum leakage under normal operating conditions. Note: if the neutral line is interrupted, worst case leakage could reach twice this level.

Typical filter attenuation

Per CISPR 17; A = 50Ω/50Ω sym; B = 50Ω/50Ω asym; C = 0.1Ω/100Ω sym; D = 100Ω/0.1Ω sym

1A types

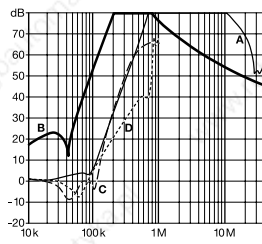

3A types

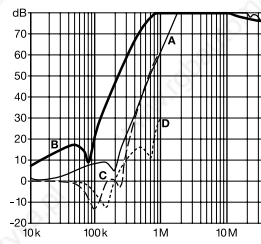

6 and 10A types

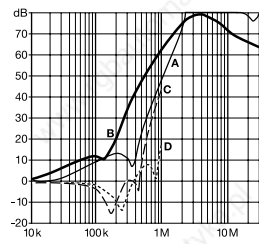

Mechanical data

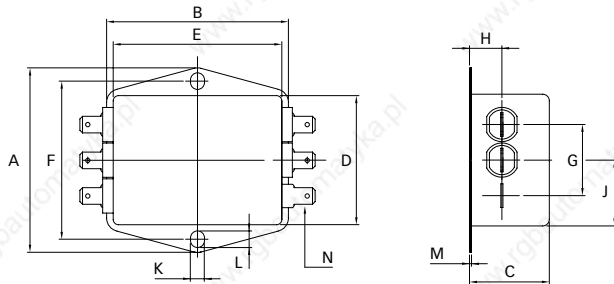

Dimensions

	1 to 10A	Tolerances
A	70	±0.5
B	69	±0.5
C	30.3	±1
D	50	±1
E	64.8	±1
F	60	±0.2
G	27	±0.5
H	12.3	±0.5
J	25	±0.5
K	5.3	
L	6.3	
M	0.7	
N	6.3 x 0.8	

All dimensions in mm; 1 inch = 25.4mm
Tolerances according: ISO 2768-m / EN 22768-m

High-power Performance EMI Filter



energy efficiency and reliability

- Rated currents from 10 to 36A
- Excellent differential and common-mode attenuation

Approvals



Technical specifications

Maximum continuous operating voltage:	250VAC, 50/60Hz
Operating frequency:	dc to 400Hz
Rated currents:	10 to 36A @ 40°C max.
High potential test voltage:	P → PE 2000VAC for 2 sec P → N 760VAC for 2 sec
Temperature range (operation and storage):	-25°C to +100°C (25/100/21)
Flammability corresponding to:	UL 94V-2 or better
Design corresponding to:	UL 1283, CSA 22.2 No. 8 1986, IEC/EN 60939
MTBF @ 40°C/230V (Mil-HB-217F):	400,000 hours

Typical electrical schematic

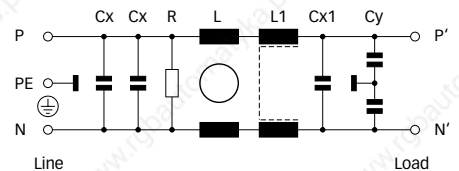

Features and benefits

- FN 685 filters are designed for easy and fast chassis mounting.
- FN 685 two-stage filters provide an excellent high differential and common-mode attenuation performance, based on chokes with high saturation resistance and very good thermal behavior.
- FN 685 two-stage filters are designed for very high noise suppression over a broad frequency range.
- Faston terminal connection with additional spade solder possibility or screw mounting connection.
- Custom-specific versions on request.

Typical applications

- Electrical and electronic equipment
- Consumer goods
- Power supplies
- Building automation
- Elevators and cranes
- Office automation equipment
- Datacom equipment

Filter selection table

Filter*	Rated current @ 40°C (25°C)	Leakage current** @ 230VAC/50Hz	Inductance		Cx	Capacitance		Resistance R	Input/Output connections			Weight
	[A]	[µA]	L	L1		Cx1	Cy		[kΩ]			
FN 685-10-...	10 (12)	410	4.2	0.04	470	220	4.7	330	-03	-06		1.2
FN 685-16-...	16 (19.2)	410	2.3	0.04	470	220	4.7	330	-03	-06		1.35
FN 686-25-23	25 (30)	1900	1.35	0.04	470	220	22	330			-23	2.35
FN 686-36-23	36 (43.2)	1900	0.8	0.03	470	220	22	330			-23	2.85

* To compile a complete part number, please replace the -.. with the required I/O connection style (e.g. FN 685-10-03, FN 685-16-06).

** Maximum leakage under normal operating conditions. Note: if the neutral line is interrupted, worst case leakage could reach twice this level.

Typical filter attenuation

Per CISPR 17; A = 50Ω/50Ω sym; B = 50Ω/50Ω asym; C = 0.1Ω/100Ω sym; D = 100Ω/0.1Ω sym

10A types

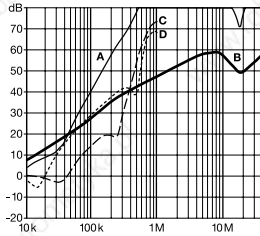

16A types

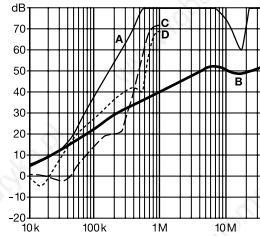

25A types

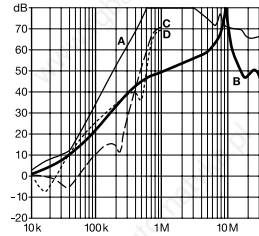

36A types

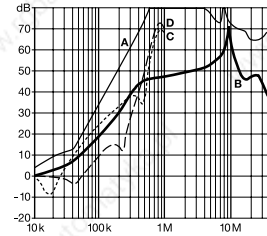

Mechanical data

Connection style -03 and -23

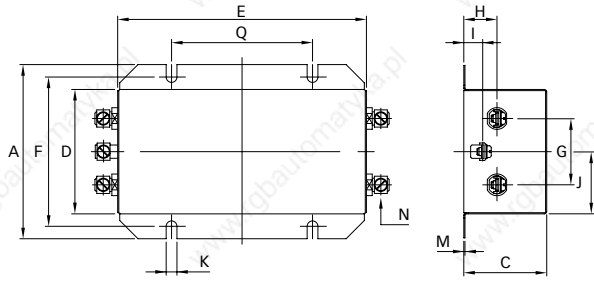

Connection style -06

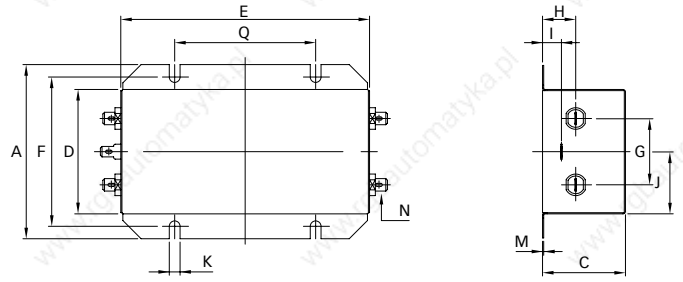

Dimensions

	10A	16A	25A	36A	Tolerances
A	105	105	129 ±1	129 ±1	±0.5
C	50	50	60	60	±0.5
D	75	75	100	100	±0.5
E	150	150	170.6	170.6	±0.5
F	90	90	113 ±0.2	113 ±0.2	±0.5
G	40	40	50	50	±0.2
H	20	20	24	24	±0.5
I	11	11	15	15	±0.5
J	37.5	37.5	50	50	±0.5
K	6.5	6.5	6.5	6.5	
M	0.7	0.7	0.7	0.7	
N	6.3 x 0.8	6.3 x 0.8			
Connection style -03					
N	M4	M4			
Q	85	85			±0.1
Connection style -23					
N			M5	M5	
Q			115	115	±0.2

All dimensions in mm; 1 inch = 25.4mm
Tolerances according: ISO 2768-m / EN 22768-m

Multi-stage General Purpose EMI Filter



energy efficiency and reliability

- Rated currents from 1 to 30A
- High differential and common-mode attenuation
- Optional medical versions (B type)
- Optional safety versions (A type)

Approvals





Technical specifications

Maximum continuous operating voltage:	250VAC, 50/60Hz
Operating frequency:	dc to 400Hz
Rated currents:	1 to 30A @ 40°C max.
High potential test voltage:	P → PE 2000VAC for 2 sec
	P → PE 2500VAC for 2 sec (B types)
	P → N 1100VDC for 2 sec
Temperature range (operation and storage):	-25°C to +100°C (25/100/21)
Flammability corresponding to:	UL 94V-2 or better
Design corresponding to:	UL 1283, CSA 22.2 No. 8 1986, IEC/EN 60939
MTBF @ 40°C/230V (Mil-HB-217F):	950,000 hours
	1,650,000 hours (B types)

Features and benefits

- FN 2060 two-stage filters are designed for easy and fast chassis mounting.
- FN 2060 filters are also available as B versions without Y-capacitors for medical applications as well as A version with low capacitance for safety critical applications with necessity for low leakage currents.
- All filters provide a high conducted attenuation performance, based on chokes with high saturation resistance and excellent thermal behavior.
- FN 2060 two-stage filters are designed for noisy applications requiring good differential and common-mode attenuation.
- FN 2060 filters are also available as single-stage filters (FN 2010 series).
- Various terminal options allow you to select the desired connection style.

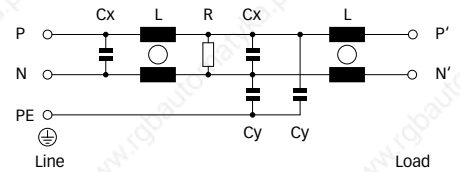
Typical electrical schematic



Typical applications

- Electrical and electronic equipment
- Consumer goods
- Household equipment
- Building automation
- Industrial applications
- Machinery
- Medical equipment
- Electronic data processing equipment
- Office automation and datacom equipment
- Various noisy applications requiring good filter performance

Filter selection table

Filter*	Rated current @ 40°C (25°C)	Leakage current** @ 230VAC/50Hz	Inductance L	Capacitance Cx Cy		Resistance R	Input/Output connections			Weight
	[A]	[mA]	[mH]	[µF]	[nF]	[kΩ]				[g]
FN 2060-1-..	1 (1.2)	0.734	12	0.22	4.7	1000	-06	-07		120
FN 2060-3-..	3 (3.5)	0.734	2.5	0.22	4.7	1000	-06	-07		120
FN 2060-6-..	6 (6.9)	0.734	0.97	0.22	4.7	1000	-06	-07		120
FN 2060-10-..	10 (11.5)	0.734	0.8	0.47	4.7	470	-06	-07		190
FN 2060-12-..	12 (13.8)	0.734	0.58	0.47	4.7	470	-06	-07		190
FN 2060-16-..	16 (18.4)	0.734	0.65	0.33	4.7	1000	-06	-07	-08	260
FN 2060-20-..	20 (23)	0.734	0.6	1	4.7	220	-06		-08	480
FN 2060-30-08	30 (34.5)	0.867	0.6	1	10	220			-08	950
FN 2060A-1-..	1 (1.2)	0.074	12	0.22	0.47	1000	-06	-07		120
FN 2060A-3-..	3 (3.5)	0.074	2.5	0.22	0.47	1000	-06	-07		120
FN 2060A-6-..	6 (6.9)	0.074	0.97	0.22	0.47	1000	-06	-07		120
FN 2060A-10-..	10 (11.5)	0.074	0.8	0.47	0.47	470	-06	-07		190
FN 2060A-12-..	12 (13.8)	0.074	0.58	0.47	0.47	470	-06	-07		190
FN 2060A-16-..	16 (18.4)	0.074	0.65	0.33	0.47	1000	-06	-07	-08	260
FN 2060A-20-..	20 (23)	0.074	0.6	1	0.47	220	-06		-08	480
FN 2060A-30-08	30 (34.5)	0.074	0.6	1	0.47	220			-08	950
FN 2060B-1-..	1 (1.2)	0.002	12	0.22		1000	-06	-07		120
FN 2060B-3-..	3 (3.5)	0.002	2.5	0.22		1000	-06	-07		120
FN 2060B-6-..	6 (6.9)	0.002	0.97	0.22		1000	-06	-07		120
FN 2060B-10-..	10 (11.5)	0.002	0.8	0.47		470	-06	-07		190
FN 2060B-12-..	12 (13.8)	0.002	0.58	0.47		470	-06	-07		190
FN 2060B-16-..	16 (18.4)	0.002	0.65	0.33		1000	-06	-07	-08	260
FN 2060B-20-..	20 (23)	0.002	0.6	1		220	-06		-08	480
FN 2060B-30-08	30 (34.5)	0.002	0.6	1		220			-08	950

* To compile a complete part number, please replace the -.. with the required I/O connection style (e.g. FN 2060-30-08, FN 2060B-10-06).
 ** Maximum leakage under normal operating conditions. Note: if the neutral line is interrupted, worst case leakage could reach twice this level.

Typical filter attenuation

Per CISPR 17; A = 50Ω/50Ω sym; B = 50Ω/50Ω asym; C = 0.1Ω/100Ω sym; D = 100Ω/0.1Ω sym

1A types

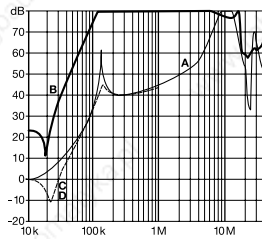

3 to 12A types

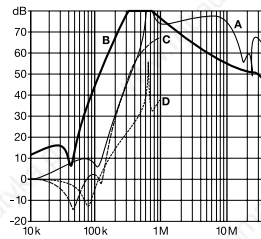

16A types

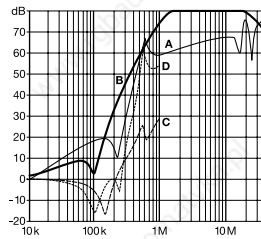

20 and 30A types

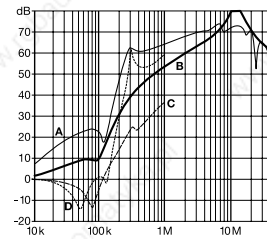

Mechanical data

Connection style -06, 1 to 12A types

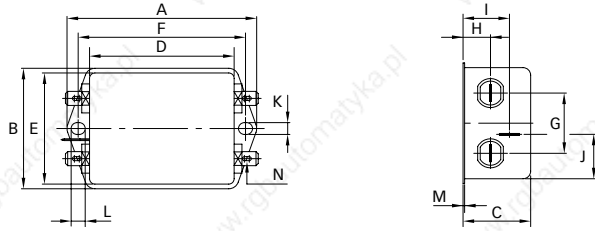

Connection style -06, 16A types

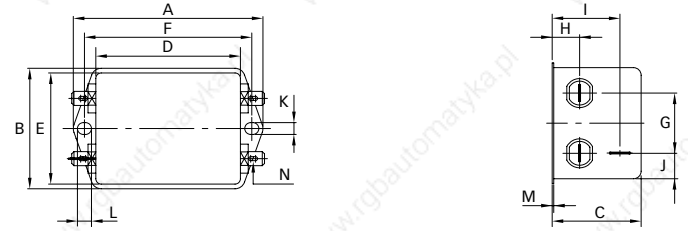

Connection style -06, 20A types

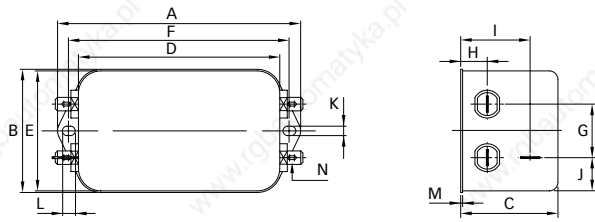

Connection style -07, 1 to 16A types (same dimensions as style -06)

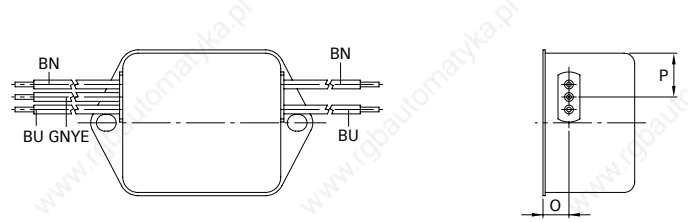

Connection style -08, 16A types

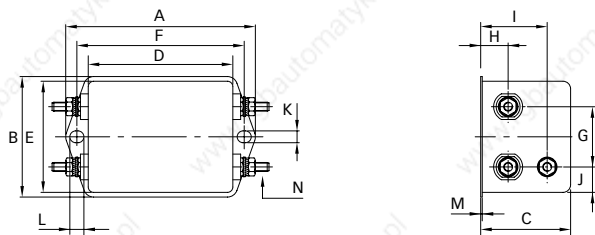

Connection style -08, 20A types

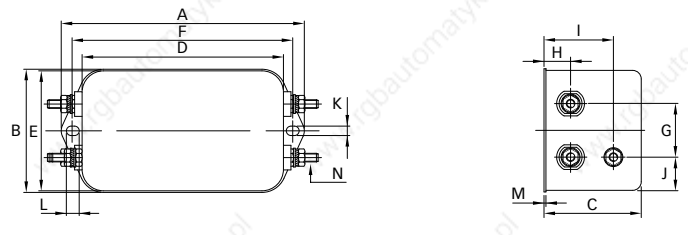

Connection style -08, 30A types

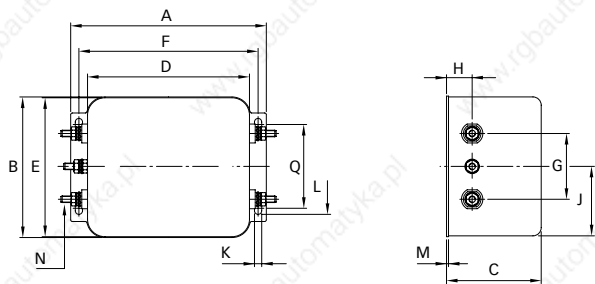

Dimensions

	1A	3A	6A	10A	12A	16A	20A	30A	Tolerances
A	71	71	71	85	85	85	113.5 ±1	119 ±1	±0.5
B	46.6	46.6	46.6	54	54	54	57.5 ±1	85.5 ±1	±0.5
C	29.3	29.3	29.3	30.3	30.3	40.3	45.4 ±1	57.6 ±1	±0.5
D	50.5	50.5	50.5	64.8	64.8	64.8	94 ±1	98.5 ±1	±0.5
E	44.5	44.5	44.5	49.8	49.8	49.8	56	84.5	±0.5
F	61	61	61	75	75	75	103	109	±0.3
G	21	21	21	27	27	27	25	40	±0.2
H	10.8	10.8	10.8	12.3	12.3	12.3	12.4	15.6	±0.5
I	19.3	19.3	19.3	20.8	20.8	29.8	32.4		±0.5
J	20.1	20.1	20.1	19.9	19.9	11.4	15.5	42.25	±0.5
K	5.3	5.3	5.3	5.3	5.3	5.3	4.4	4.4	
L	6.3	6.3	6.3	6.3	6.3	6.3	6	7.4	
M	0.7	0.7	0.7	0.7	0.7	0.7	0.9	1.2	
Connection style -06									
N	6.3 x 0.8	6.3 x 0.8	6.3 x 0.8	6.3 x 0.8	6.3 x 0.8	6.3 x 0.8	6.3 x 0.8		
Connection style -07									
O	8.3	8.3	8.3	8.3	8.3	8.3			±0.5
P	14	14	14	14.9	14.9	14.9			±0.5
AWG type wire	AWG 20	AWG 20	AWG 18	AWG 18	AWG 16	AWG 16			
Wire length	140	140	140	140	140	140			+5
Connection style -08									
N						M4	M4	M4	
Q								51	±0.2

All dimensions in mm; 1 inch = 25.4mm

Tolerances according: ISO 2768-m / EN 22768-m

Multi-stage Performance EMI Filter



energy efficiency and reliability

- Rated currents from 1 to 36A
- High differential and common-mode attenuation
- High frequency attenuation
- Optional medical versions (B type)
- Optional safety versions (A type)

Approvals



Technical specifications

Maximum continuous operating voltage:	250VAC, 50/60Hz
Operating frequency:	dc to 400Hz
Rated currents:	1 to 36A @ 40°C max.
High potential test voltage:	P → PE 2000VAC for 2 sec
	P → PE 2500VAC for 2 sec (B types)
	P → N 1100VDC for 2 sec
Temperature range (operation and storage):	-25°C to +100°C (25/100/21)
Flammability corresponding to:	UL 94V-2 or better
Design corresponding to:	UL 1283, CSA 22.2 No. 8 1986, IEC/EN 60939
MTBF @ 40°C/230V (Mil-HB-217F):	1,550,000 hours
	1,600,000 hours (B types)

Typical electrical schematic

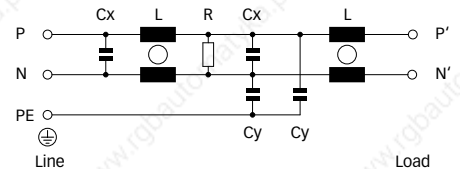

Features and benefits

- FN 2070 two-stage filters are designed for easy and fast chassis mounting.
- FN 2070 filters are also available as B versions without Y-capacitors for medical applications as well as A version with low capacitance for safety critical applications with necessity for low leakage currents.
- All filters provide a high conducted attenuation performance, based on chokes with high saturation resistance and excellent thermal behavior.
- FN 2070 two-stage filters are designed for high frequency attenuation.
- FN 2070 filters are also available as single-stage filters (FN 2020 series).
- Various terminal options allow you to select the desired connection style.

Typical applications

- Electrical and electronic equipment
- Consumer goods
- Household equipment
- Building automation
- Industrial applications
- Machinery
- Medical equipment
- Electronic data processing equipment
- Office automation and datacom equipment
- Various noisy applications requiring good filter performance

Filter selection table

Filter*	Rated current @ 40°C (25°C)	Leakage current** @ 230VAC/50Hz	Inductance L	Capacitance Cx Cy		Resistance R	Input/Output connections			Weight
	[A]	[mA]	[mH]	[μF]	[nF]	[kΩ]				[g]
FN 2070-1-..	1 (1.2)	0.734	22	0.33	4.7	1000	-06	-07		190
FN 2070-3-..	3 (3.5)	0.734	9.8	0.47	4.7	470	-06	-07		250
FN 2070-6-..	6 (6.9)	0.734	7.8	1	4.7	220	-06	-07		450
FN 2070-10-..	10 (11.5)	0.734	4.5	1	4.7	220	-06	-07		670
FN 2070-12-..	12 (13.8)	0.734	3.25	1	4.7	220	-06	-07		670
FN 2070-16-..	16 (18.4)	0.734	2.8	1	4.7	220	-06	-07	-08	1000
FN 2070-25-08	25 (28.8)	0.734	2	2.2	4.7	220			-08	760
FN 2070-36-08	36 (41.4)	0.867	1.23	2.2	4.7	220			-08	790
FN 2070A-1-..	1 (1.2)	0.074	22	0.33	0.47	1000	-06	-07		190
FN 2070A-3-..	3 (3.5)	0.074	9.8	0.47	0.47	470	-06	-07		250
FN 2070A-6-..	6 (6.9)	0.074	7.8	1	0.47	220	-06	-07		450
FN 2070A-10-..	10 (11.5)	0.074	4.5	1	0.47	220	-06	-07		670
FN 2070A-12-..	12 (13.8)	0.074	3.25	1	0.47	220	-06	-07		670
FN 2070A-16-..	16 (18.4)	0.074	2.8	1	0.47	220	-06	-07	-08	1000
FN 2070A-25-08	25 (28.8)	0.074	2	2.2	0.47	220			-08	760
FN 2070A-36-08	36 (41.4)	0.074	1.23	2.2	0.47	220			-08	790
FN 2070B-1-..	1 (1.2)	0.002	22	0.33		1000	-06	-07		190
FN 2070B-3-..	3 (3.5)	0.002	9.8	0.47		470	-06	-07		250
FN 2070B-6-..	6 (6.9)	0.002	7.8	1		220	-06	-07		450
FN 2070B-10-..	10 (11.5)	0.002	4.5	1		220	-06	-07		670
FN 2070B-12-..	12 (13.8)	0.002	3.25	1		220	-06	-07		670
FN 2070B-16-..	16 (18.4)	0.002	2.8	1		220	-06	-07	-08	1000
FN 2070B-25-08	25 (28.8)	0.002	2	2.2		220			-08	760
FN 2070B-36-08	36 (41.4)	0.002	1.23	2.2		220			-08	790

* To compile a complete part number, please replace the .. with the required I/O connection style (e.g. FN 2070-25-08, FN 2070B-10-06).
 ** Maximum leakage under normal operating conditions. Note: if the neutral line is interrupted, worst case leakage could reach twice this level.

Typical filter attenuation

Per CISPR 17; A = 50Ω/50Ω sym; B = 50Ω/50Ω asym; C = 0.1Ω/100Ω sym; D = 100Ω/0.1Ω sym

1A types

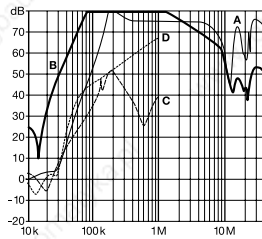

3 to 12A types

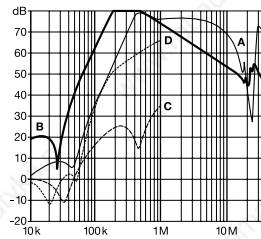

16A types

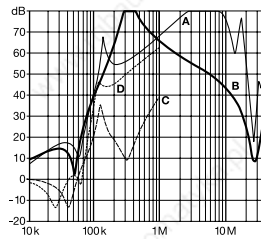

25 and 36A types

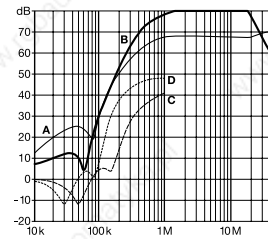

Mechanical data

Connection style -06, 1 and 3A types

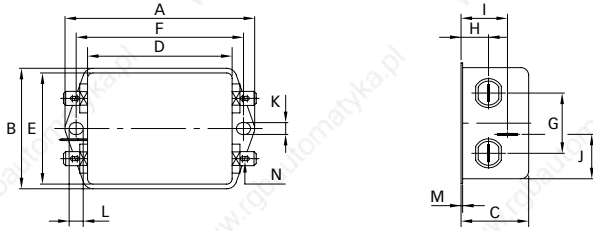

Connection style -06, 6 to 12A types

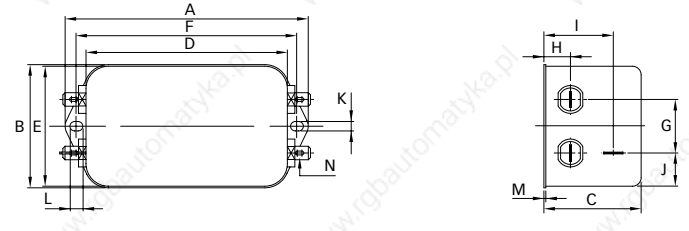

Connection style -06, 16A types

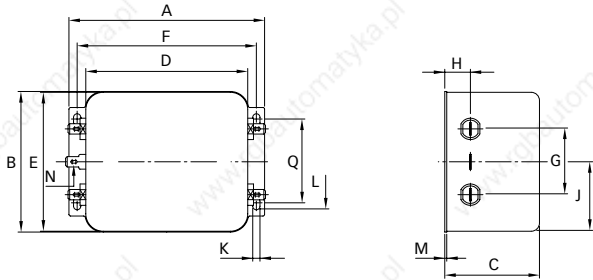

Connection style -07, 1 and 3A types (same dimensions as style -06)

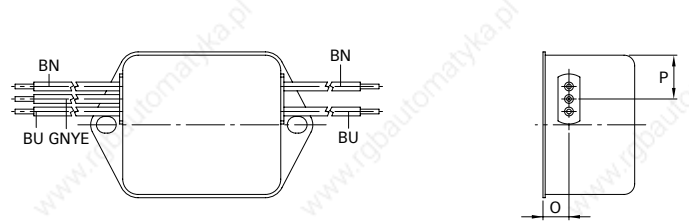

Connection style -07, 6 to 12A types (same dimensions as style -06)

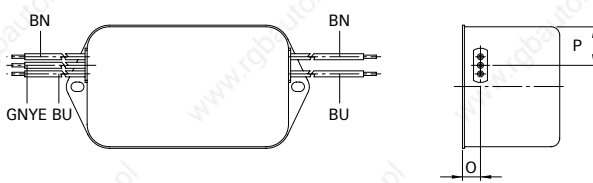

Connection style -07, 16A types (same dimensions as style -06)

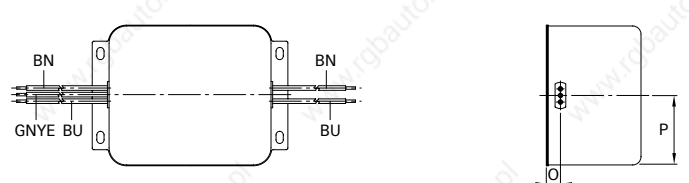

Connection style -08, 16A types

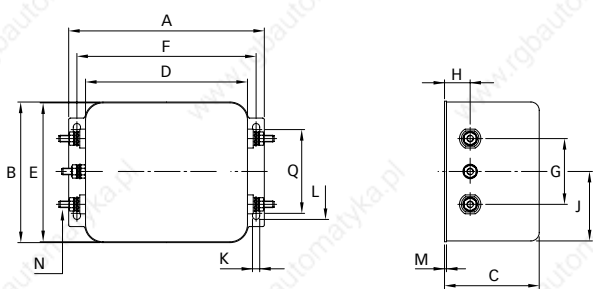

Connection style -08, 25 and 36A types

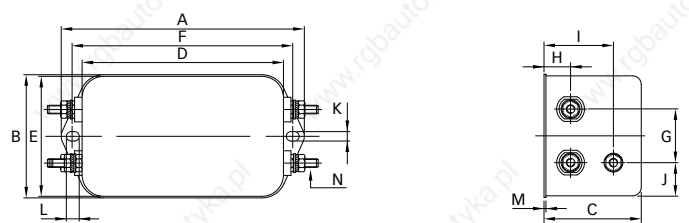

Dimensions

	1A	3A	6A	10A	12A	16A	25A	36A	Tolerances
A	85 ±0.5	85 ±0.5	113.5	156	156	119	156	156	±1
B	54 ±0.5	54 ±0.5	57.5	57.5	57.5	85.5	57.5	57.5	±1
C	30.3 ±0.5	40.3 ±0.5	45.4	45.4	45.4	57.6	45.4	45.4	±1
D	64.8 ±0.5	64.8 ±0.5	94	130.5	130.5	98.5	130.5	130.5	±1
E	49.8	49.8	56	56	56	84.5	56	56	±0.5
F	75	75	103	143	143	109	143	143	±0.3
G	27	27	25	25	25	40	25	25	±0.2
H	12.3	12.3	12.4	12.4	12.4	15.6	12.4	12.4	±0.5
I	20.8	29.8	32.4	32.5	32.5		32.5	32.5	±0.5
J	19.9	11.4	15.5	15.5	15.5	42.25	15.5	15.5	±0.5
K	5.3	5.3	4.4	5.3	5.3	4.4	5.3	5.3	
L	6.3	6.3	6	6	6	7.4	6	6	
M	0.7	0.7	0.9	1	1	1.2	1	1	
Connection style -06									
N	6.3 x 0.8	6.3 x 0.8	6.3 x 0.8	6.3 x 0.8	6.3 x 0.8	6.3 x 0.8			
Connection style -07									
O	8.3	8.3	8.4	8.4	8.4	8.6			±0.5
P	14.9	14.9	18	18	18	42.25			±0.5
AWG type wire	AWG 20	AWG 20	AWG 18	AWG 18	AWG 16	AWG 16			
Wire length	140	140	140	140	140	140			+5
Connection style -08									
N						M4	M4	M4	
Q						51			±0.2

All dimensions in mm; 1 inch = 25.4mm

Tolerances according: ISO 2768-m / EN 22768-m

Multi-stage High Performance EMI Filter



energy efficiency and reliability

- Rated currents from 1 to 16A
- High differential and common-mode attenuation
- Good low frequency attenuation
- Optional medical versions (B type)
- Optional safety versions (A type)

Approvals



Technical specifications

Maximum continuous operating voltage:	250VAC, 50/60Hz
Operating frequency:	dc to 400Hz
Rated currents:	1 to 16A @ 40°C max.
High potential test voltage:	P → PE 2000VAC for 2 sec
	P → PE 2500VAC for 2 sec (B types)
	P → N 1100VDC for 2 sec
Temperature range (operation and storage):	-25°C to +100°C (25/100/21)
Flammability corresponding to:	UL 94V-2 or better
Design corresponding to:	UL 1283, CSA 22.2 No. 8 1986, IEC/EN 60939
MTBF @ 40°C/230V (Mil-HB-217F):	1,650,000 hours
	1,700,000 hours (B types)

Typical electrical schematic

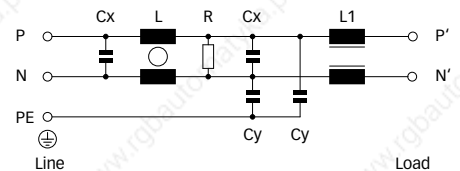



Features and benefits

- FN 2080 two-stage filters are designed for easy and fast chassis mounting.
- FN 2080 filters are also available as B versions without Y-capacitors for medical applications as well as A version with low capacitance for safety critical applications with necessity for low leakage currents.
- All filters provide a high conducted attenuation performance, based on chokes with high saturation resistance and excellent thermal behavior.
- FN 2080 two-stage filters are designed with good low frequency attenuation.
- FN 2080 filters are also available as single-stage filters.
- Various terminal options allow you to select the desired connection style.

Typical applications

- Electrical and electronic equipment
- Consumer goods
- Household equipment
- Building automation
- Industrial applications
- Machinery
- Medical equipment
- Electronic data processing equipment
- Office automation and datacom equipment
- Various noisy applications requiring good filter performance

Filter selection table

Filter*	Rated current @ 40°C (25°C)	Leakage current** @ 230VAC/50Hz	Inductance		Capacitance		Resistance	Input/Output connections			Weight
	[A]	[mA]	L [mH]	L1 [μH]	Cx [μF]	Cy [nF]	R [kΩ]				[g]
FN 2080-1-..	1 (1.2)	0.734	22	490	0.33	4.7	1000	-06	-07		200
FN 2080-3-..	3 (3.5)	0.734	9.8	160	0.47	4.7	470	-06	-07		270
FN 2080-6-..	6 (6.9)	0.734	7.8	110	1	4.7	220	-06	-07		470
FN 2080-10-..	10 (11.5)	0.734	4.5	60	1	4.7	220	-06	-07		750
FN 2080-12-..	12 (13.8)	0.734	3.25	50	1	4.7	220	-06	-07		750
FN 2080-16-..	16 (18.4)	0.734	2.8	43	1	4.7	220	-06	-07	-08	1020
FN 2080A-1-..	1 (1.2)	0.074	22	490	0.33	0.47	1000	-06	-07		200
FN 2080A-3-..	3 (3.5)	0.074	9.8	160	0.47	0.47	470	-06	-07		270
FN 2080A-6-..	6 (6.9)	0.074	7.8	110	1	0.47	220	-06	-07		470
FN 2080A-10-..	10 (11.5)	0.074	4.5	60	1	0.47	220	-06	-07		750
FN 2080A-12-..	12 (13.8)	0.074	3.25	50	1	0.47	220	-06	-07		750
FN 2080A-16-..	16 (18.4)	0.074	2.8	43	1	0.47	220	-06	-07	-08	1020
FN 2080B-1-..	1 (1.2)	0.002	22	490	0.33		1000	-06	-07		200
FN 2080B-3-..	3 (3.5)	0.002	9.8	160	0.47		470	-06	-07		270
FN 2080B-6-..	6 (6.9)	0.002	7.8	110	1		220	-06	-07		470
FN 2080B-10-..	10 (11.5)	0.002	4.5	60	1		220	-06	-07		750
FN 2080B-12-..	12 (13.8)	0.002	3.25	50	1		220	-06	-07		750
FN 2080B-16-..	16 (18.4)	0.002	2.8	43	1		220	-06	-07	-08	1020

* To compile a complete part number, please replace the .. with the required I/O connection style (e.g. FN 2080-16-08, FN 2080B-10-06).

** Maximum leakage under normal operating conditions. Note: if the neutral line is interrupted, worst case leakage could reach twice this level.

Typical filter attenuation

Per CISPR 17; A = 50Ω/50Ω sym; B = 50Ω/50Ω asym; C = 0.1Ω/100Ω sym; D = 100Ω/0.1Ω sym

1 to 6A types

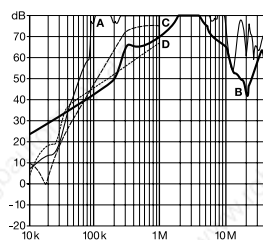

10 and 12A types

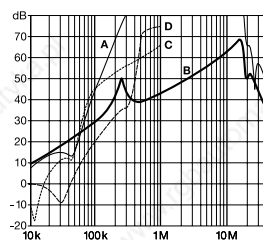

16A types

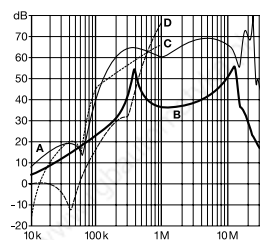

Mechanical data

Connection style -06, 1 and 3A types

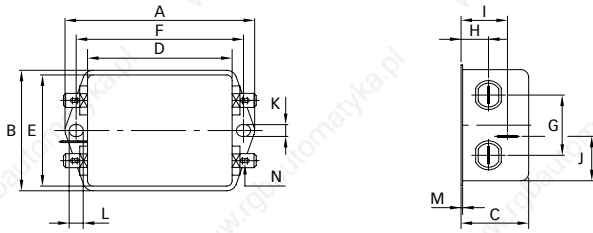

Connection style -06, 6 to 12A types

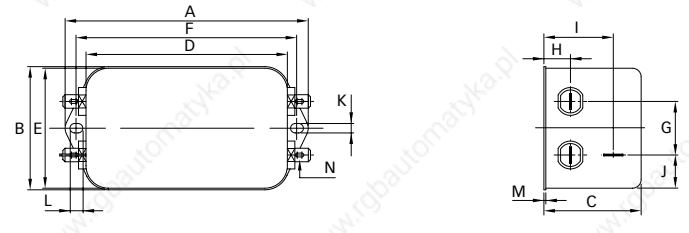

Connection style -06, 16A types

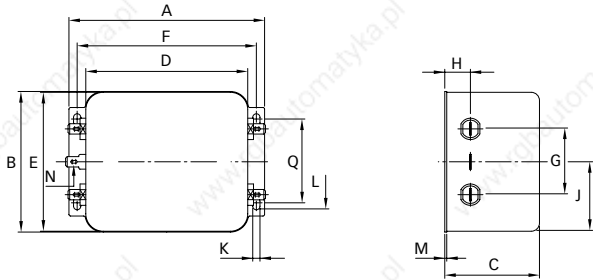

Connection style -07, 1 and 3A types (same dimensions as style -06)

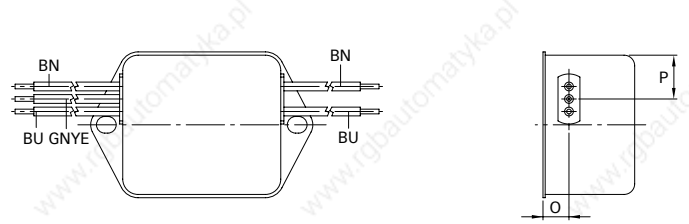

Connection style -07, 6 to 12A types (same dimensions as style -06)

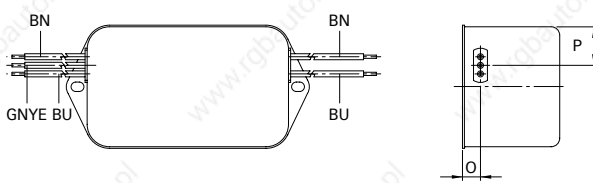

Connection style -07, 16A types (same dimensions as style -06)

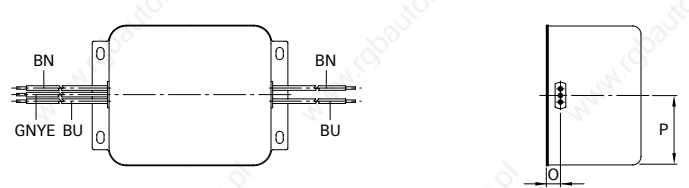

Connection style -08, 16A types (same dimensions as style -06)

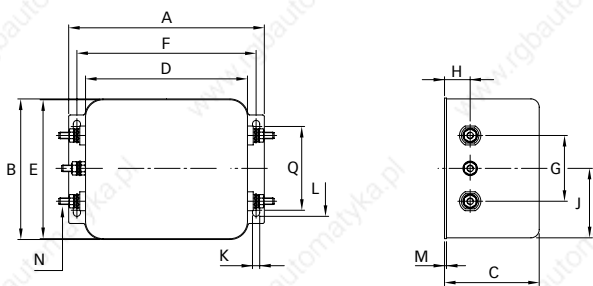

Dimensions

	1A	3A	6A	10A	12A	16A	Tolerances
A	85	85	113.5 ±1	156 ±1	156 ±1	119 ±1	±0.5
B	54	54	57.5 ±1	57.5 ±1	57.5 ±1	85.5 ±1	±0.5
C	30.3	40.3	45.4 ±1	45.4 ±1	45.4 ±1	57.6 ±1	±0.5
D	64.8	64.8	94 ±1	130.5 ±1	130.5 ±1	98.5 ±1	±0.5
E	49.8	49.8	56	56	56	84.5	±0.5
F	75	75	103	143	143	109	±0.3
G	27	27	25	25	25	40	±0.2
H	12.3	12.3	12.4	12.4	12.4	15.6	±0.5
I	20.8	29.8	32.4	32.5	32.5		±0.5
J	19.9	11.4	15.5	15.5	15.5	42.25	±0.5
K	5.3	5.3	4.4	5.3	5.3	4.4	
L	6.3	6.3	6	6	6	7.4	
M	0.7	0.7	0.9	1	1	1.2	
Connection style -06							
N	6.3 x 0.8	6.3 x 0.8	6.3 x 0.8	6.3 x 0.8	6.3 x 0.8	6.3 x 0.8	
Connection style -07							
O	8.3	8.3	8.4	8.4	8.4	8.6	±0.5
P	14.9	14.9	18	18	18	42.25	±0.5
AWG type wire	AWG 20	AWG 20	AWG 18	AWG 18	AWG 16	AWG 16	
Wire length	140	140	140	140	140	140	+5
Connection style -08							
N						M4	
Q						51	±0.2

All dimensions in mm; 1 inch = 25.4mm

Tolerances according: ISO 2768-m / EN 22768-m

Multi-stage EMI Filter with Excellent Attenuation Performance

SCHAFFNER
energy efficiency and reliability



- Rated currents from 1 to 30A
- Two-stage filter
- Very high differential and common-mode attenuation
- Optional medical versions (B type)
- Optional safety versions (A type)
- Optional overvoltage protection (Z type)

Approvals



ROHS

Technical specifications

Maximum continuous operating voltage:	250VAC, 50/60Hz
Operating frequency:	dc to 400Hz
Rated currents:	1 to 30A @ 40°C max.
High potential test voltage:	P → PE 2000VAC for 2 sec (standard types) P → PE 2500VAC for 2 sec (B types) P → N 1100VDC for 2 sec
Temperature range (operation and storage):	-25°C to +100°C (25/100/21)
Design corresponding to:	UL 1283, CSA 22.2 No. 8 1986, IEC/EN 60939
Flammability corresponding to:	UL 94V-2 or better
Surge pulse protection (optional):	2kV, IEC 61000-4-5
MTBF @ 40°C/230V (Mil-HB-217F):	1,300,000 hours (1 to 10A types) 1,100,000 hours (12A types) 517,000 hours (16 and 30A types)

Typical electrical schematic

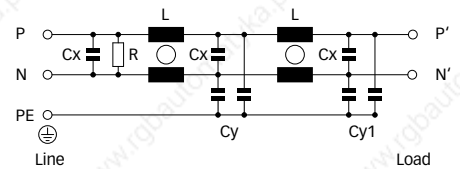

Features and benefits

- FN 2090 two-stage filters are designed for easy and fast chassis mounting.
- The FN 2090 filters are also available as B versions with no Y-capacitors for medical applications as well as A versions with low capacitance for safety critical applications with a requirement for low leakage currents.
- All filters provide an exceptional conducted attenuation performance, based on chokes with high permeable core material and excellent thermal behavior.
- FN 2090 two-stage filters are designed for noisy applications requiring excellent filter performance.
- The higher inductivity versus amperage offers increased attenuation performance with the same form factor compared to FN 2060 and FN 2080 filter series.
- All FN 2090 filters can be delivered with optional surge pulse protection.
- FN 2090 filters are also available as single-stage filters (FN 2050 series).
- Various terminal options allow you to select the desired connection style.

Typical applications

- Electrical and electronic equipment
- Consumer goods
- Household equipment
- Building automation
- Industrial applications
- Machinery
- Medical equipment
- Electronic data processing equipment
- Office automation and datacom equipment
- Various noisy applications requiring high filter performance

Filter selection table

Filter*	Rated current @ 40°C (25°C)	Leakage current** @ 230VAC/50Hz	Inductance L	Cx	Capacitance Cy	Cy1	Resistance R	Input/Output connections			Weight
	[A]	[mA]	[mH]	[µF]	[nF]	[nF]	[kΩ]				[g]
FN 2090-1-..	1 (1.1)	0.5	20	0.22	2.2	1.0	680	-06	-07		73
FN 2090-3-..	3 (3.4)	0.5	14	0.33	2.2	1.0	470	-06	-07		158
FN 2090-4-..	4 (4.5)	0.5	14	0.33	2.2	1.0	470	-06	-07		176
FN 2090-6-..	6 (6.7)	0.67	8	0.47	3.3	1.0	330	-06	-07		191
FN 2090-8-..	8 (8.9)	0.67	8	0.47	3.3	1.0	330	-06	-07		330
FN 2090-10-..	10 (11.2)	0.67	8	0.47	3.3	1.0	330	-06	-07		369
FN 2090-12-..	12 (13.4)	1.02	4	1	10	1.0	220	-06	-07		391
FN 2090-16-..	16 (17.9)	1.02	4	1	10	1.0	220	-06	-07		425
FN 2090-20-..	20 (22.4)	1.02	2.7	1	10	1.0	220	-06		-08	530
FN 2090-30-08	30 (33.5)	1.02	1.5	1	10	1.0	220			-08	548
FN 2090A-1-..	1 (1.1)	0.08	20	0.22	0.47	0.47	680	-06	-07		73
FN 2090A-3-..	3 (3.4)	0.08	14	0.33	0.47	0.47	470	-06	-07		158
FN 2090A-4-..	4 (4.5)	0.08	14	0.33	0.47	0.47	470	-06	-07		176
FN 2090A-6-..	6 (6.7)	0.08	8	0.47	0.47	0.47	330	-06	-07		191
FN 2090A-8-..	8 (8.9)	0.08	8	0.47	0.47	0.47	330	-06	-07		330
FN 2090A-10-..	10 (11.2)	0.08	8	0.47	0.47	0.47	330	-06	-07		369
FN 2090A-12-..	12 (13.4)	0.08	4	1	0.47	0.47	220	-06	-07		391
FN 2090A-16-..	16 (17.9)	0.08	4	1	0.47	0.47	220	-06	-07		425
FN 2090A-20-..	20 (22.4)	0.08	2.7	1	0.47	0.47	220	-06		-08	530
FN 2090B-1-..	1 (1.1)	0.002	20	0.22			680	-06	-07		73
FN 2090B-3-..	3 (3.4)	0.002	14	0.33			470	-06	-07		158
FN 2090B-4-..	4 (4.5)	0.002	14	0.33			470	-06	-07		176
FN 2090B-6-..	6 (6.7)	0.002	8	0.47			330	-06	-07		191
FN 2090B-8-..	8 (8.9)	0.002	8	0.47			330	-06	-07		330
FN 2090B-10-..	10 (11.2)	0.002	8	0.47			330	-06	-07		369
FN 2090B-12-..	12 (13.4)	0.002	4	1			220	-06	-07		391
FN 2090B-16-..	16 (17.9)	0.002	4	1			220	-06	-07		425
FN 2090B-20-..	20 (22.4)	0.002	2.7	1			220	-06		-08	530
FN 2090B-30-08	30 (33.5)	0.002	1.5	1			220			-08	548

* To compile a complete part number, please replace the .. with the required I/O connection style. For surge pulse protection, please add Z (e.g. FN 2090Z-10-06, FN 2090BZ-20-08).

** Maximum leakage under normal operating conditions. Note: if the neutral line is interrupted, worst case leakage could reach twice this level.

Typical filter attenuation

Per CISPR 17; A = 50Ω/50Ω sym; B = 50Ω/50Ω asym; C = 0.1Ω/100Ω sym; D = 100Ω/0.1Ω sym

1 to 4A types

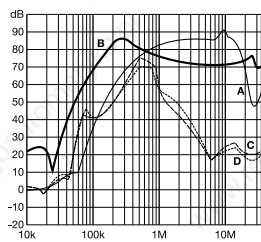

6 to 10A types

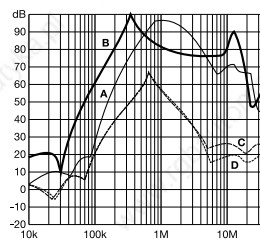

12 to 20A types

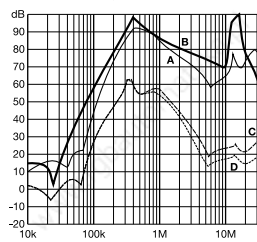

30A types

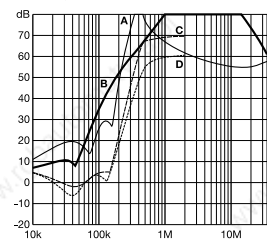

Mechanical data

Connection style -06, 1A types

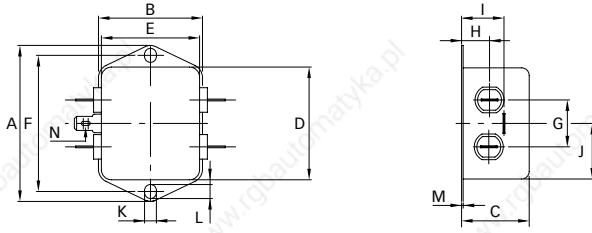

Connection style -06, 3 to 20A types

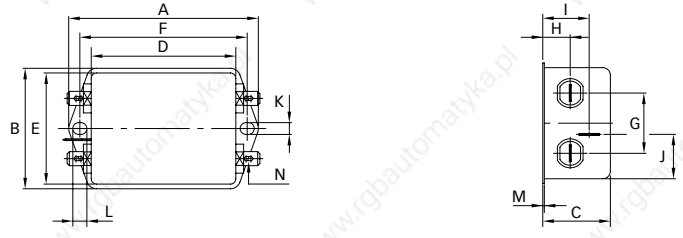

Connection style -07, 1A types (same dimensions as style -06)

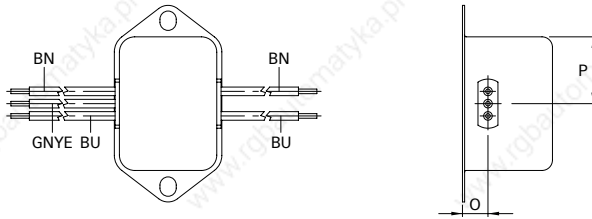

Connection style -07, 3 to 20A types (same dimensions as style -06)

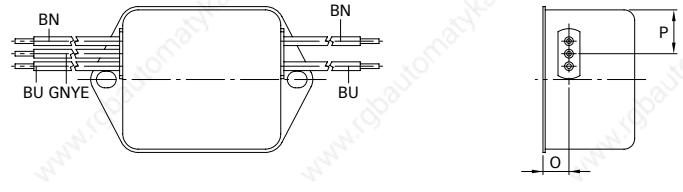

Connection style -08, 20 and 30A types

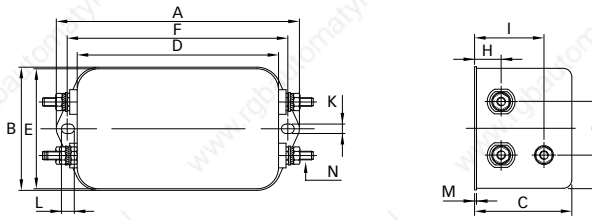

Dimensions

	1A	3A	4A	6A	8A	10A	12A	16A	20A	30A	Tolerances
A	71	85	85	85	113.5 ±1	113.5 ±1	113.5 ±1	113.5 ±1	113.5 ±1	113.5 ±1	±0.5
B	46.6	54	54	54	57.5 ±1	57.5 ±1	57.5 ±1	57.5 ±1	57.5 ±1	57.5 ±1	±0.5
C	22.3	30.3	30.3	30.3	45.4 ±1	45.4 ±1	45.4 ±1	45.4 ±1	45.4 ±1	45.4 ±1	±0.5
D	50.5	64.8	64.8	64.8	94 ±1	94 ±1	94 ±1	94 ±1	94 ±1	94 ±1	±0.5
E	44.5	49.8	49.8	49.8	56	56	56	56	56	56	±0.5
F	61	75	75	75	103	103	103	103	103	103	±0.3
G	21	27	27	27	25	25	25	25	25	25	±0.2
H	10.8	12.3	12.3	12.3	12.4	12.4	12.4	12.4	12.4	12.4	±0.5
I	16.8	20.8	20.8	20.8	32.4	32.4	32.4	32.4	32.4	32.4	±0.5
J	25.25	19.9	19.9	19.9	15.5	15.5	15.5	15.5	15.5	15.5	±0.5
K	5.3	5.3	5.3	5.3	4.4	4.4	4.4	4.4	4.4	4.4	
L	6.3	6.3	6.3	6.3	6	6	6	6	6	6	
M	0.7	0.7	0.7	0.7	0.9	0.9	0.9	0.9	0.9	0.9	
Connection style -06											
N	6.3 x 0.8	6.3 x 0.8	6.3 x 0.8	6.3 x 0.8	6.3 x 0.8	6.3 x 0.8	6.3 x 0.8	6.3 x 0.8	6.3 x 0.8	6.3 x 0.8	
Connection style -07											
O	8.3	8.3	8.3	8.3	8.4	8.4	8.4	8.4			±0.5
P	14	14.9	14.9	14.9	18	18	18	18			±0.5
AWG type wire	AWG 20	AWG 20	AWG 20	AWG 18	AWG 18	AWG 18	AWG 16	AWG 16			
Wire length*	140	140	140	140	140	140	140	140			
Connection style -08											
N									M4	M4	

All dimensions in mm; 1 inch = 25.4mm

Tolerances according: ISO 2768-m / EN 22768-m

* Other cable length or additional wire connector on request.

High Performance EMI Filter



energy efficiency and reliability

- Rated currents from 3 to 6A
- Exceptional differential and common-mode attenuation
- UL-rated materials
- Optional medical versions (B type)

Approvals



Technical specifications

Maximum continuous operating voltage:	250VAC, 50/60Hz
Operating frequency:	dc to 400Hz
Rated currents:	3 to 6A @ 40°C max.
High potential test voltage:	P → PE 2000VAC for 2 sec P → N 1100VDC for 2 sec
Temperature range (operation and storage):	-25°C to +100°C (25/100/21)
Flammability corresponding to:	UL 94V-2 or better
Design corresponding to:	UL 1283, CSA 22.2 No. 8 1986, IEC/EN 60939
MTBF @ 40°C/230V (Mil-HB-217F):	2,400,000 hours

Typical electrical schematic

3A types

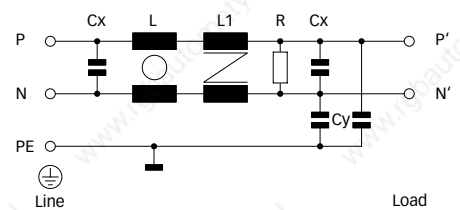

6A types

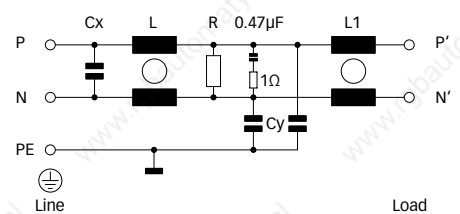

Features and benefits

- FN 2560 filters are designed for easy and fast chassis mounting.
- FN 2010 filters have a perfect performance/size ratio.
- All filters provide a very high differential and common-mode attenuation performance, based on chokes with high saturation resistance and excellent thermal behavior.
- Faston terminal connection with additional spade solder possibility.
- Optional medical versions (B type).
- Custom-specific versions on request.

Typical applications

- Electrical and electronic equipment
- Consumer goods
- Medical equipment
- Power supplies
- Office automation equipment
- Datacom equipment

Filter selection table

Filter	Rated current @ 40°C (25°C)	Leakage current* @ 230VAC/50Hz	Inductance		Capacitance		Resistance	Input/Output connections	Weight
	[A]	[mA]	L [mH]	L1 [mH]	Cx [µF]	Cy [nF]	R [MΩ]		
FN 2360W-3-06	3 (3.35)	0.52	32.3	0.4	0.47	3	1	-06	300
FN 2360X-6-06	6 (6.7)	0.7	48.2	1.7	1.5	4	1	-06	500
FN 2360B-3-06	3 (3.35)	0.004	32.3	0.4	0.47		1	-06	300
FN 2360B-6-06	6 (6.7)	0.004	48.2	1.7	1.5		1	-06	500

* Maximum leakage under normal operating conditions. Note: if the neutral line is interrupted, worst case leakage could reach twice this level.

Typical filter attenuation

Per CISPR 17; A = 50Ω/50Ω sym; B = 50Ω/50Ω asym; C = 0.1Ω/100Ω sym; D = 100Ω/0.1Ω sym

3A types (W types)

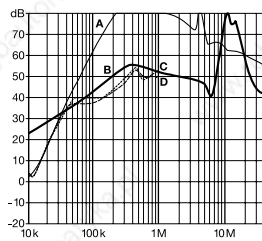

3A types (B types)

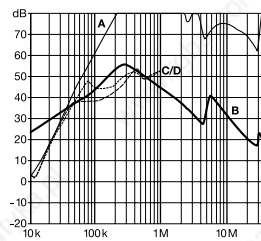

6A types (X types)

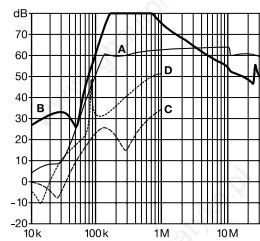

6A types (B types)

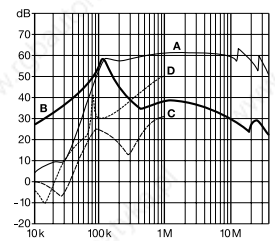

Mechanical data

3A types

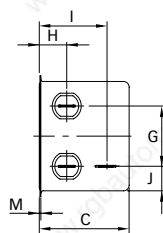
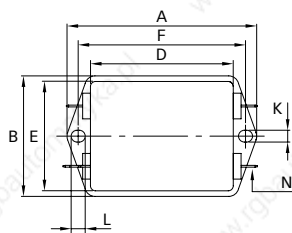

6A types

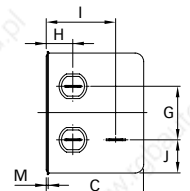
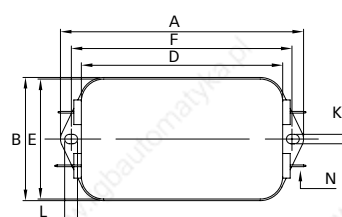

Dimensions

	3A	6A	Tolerances
A	85 ±0.5	113.5 ±1	
B	54 ±0.5	57.5 ±1	
C	40.3 ±0.5	45.5 ±1	
D	64 ±0.5	94 ±1	
E	49.8	56	±0.5
F	75	103.5	±0.3
G	27	25	±0.2
H	12.3	12.4	±0.5
I	29.8	32.4	±0.5
J	11.4	15.5	±0.5
K	5.3	4.4	
L	6.3	6	
M	0.7	1	
N	6.3 x 0.8	6.3 x 0.8	

All dimensions in mm; 1 inch = 25.4mm
Tolerances according to: ISO 2768-m / EN 22768-m

Multi-stage EMI Filter

energy efficiency and reliability



- Rated currents from 6 to 30A
- Surge pulse protection up to 2kA
- Solder or screw connection

Approvals



Technical specifications

Maximum continuous operating voltage:	250VAC, 50/60Hz
Operating frequency:	dc to 400Hz
Rated currents:	6 to 30A @ 40°C max.
High potential test voltage:	P → PE 2000VAC for 2 sec P → N 350VDC for 2 sec
Energy absorption:	40J
Temperature range (operation and storage):	-25°C to +85°C (25/85/21)
Flammability corresponding to:	UL 94V-2 or better
Design corresponding to:	UL 1283, CSA 22.2 No. 8 1986, IEC/EN 60939
MTBF @ 40°C/230V (Mil-HB-217F):	230,000 hours
Surge pulse protection:	2kV IEC 61000-4-5

Typical electrical schematic

6A types

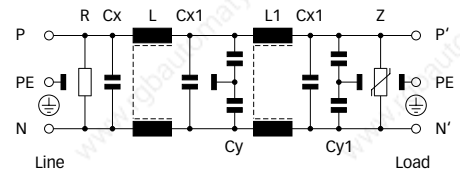

10 to 30A types

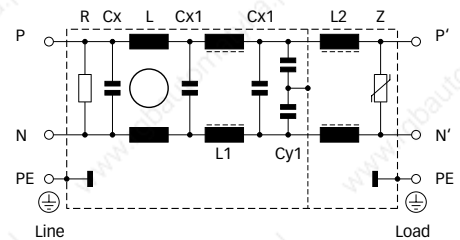

Features and benefits

- FN 352Z series is developed to meet high filter attenuation requirements by using multi-stage filter design.
- Additional high surge pulse voltage protection up to 2kA is integrated to protect sensitive equipment.
- Choosing FN 352Z product line brings you the rapid availability of a standard filter associated with the necessary safety acceptances.
- Standard filters are a practical solution helping you to pass EMI system approval in a short time.
- Exceptional conducted attenuation performance, based on multi-stage design and chokes with high saturation resistance and excellent thermal behavior.
- Various connection options.
- Custom-specific versions on request.

Typical applications

- Facility management
- Industrial
- Telecommunication
- Data processing
- Electrical and electronic equipment

Filter selection table

Filter	Rated current @ 40°C (25°C)	Leakage current* @ 230VAC/50Hz	Inductance			Capacitance				Resistance R	Energy absorption	Input/Output connections	Weight [g]
			L	L1	L2	Cx	Cx1	Cy	Cy1				
FN 352Z-6-06	6 (7.2)	420	3	3		470	220	3.3	1.5	0.47	40	-06	575
FN 352Z-10-29	10 (12)	1300	5	0.06	0.003	220	220	15	15	0.47	40	-29	1320
FN 352Z-20-29	20	1300	3.5	0.06	0.0035	220	220	15	15	0.47	40	-29	2950
FN 353Z-30-33	24 (30)	1300	2.3	0.025	0.035	470	220	15	15	0.23	40	-33	3100

* Maximum leakage under normal operating conditions. Note: if the neutral line is interrupted, worst case leakage could reach twice this level.

Typical filter attenuation

Per CISPR 17; A = 50Ω/50Ω sym; B = 50Ω/50Ω asym; C = 0.1Ω/100Ω sym; D = 100Ω/0.1Ω sym

6A types

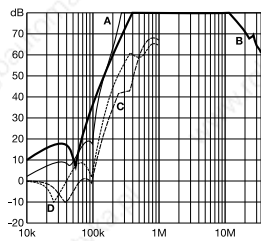

10A types

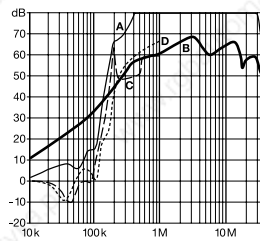

20A types

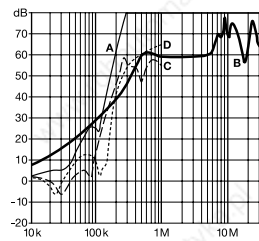

30A types

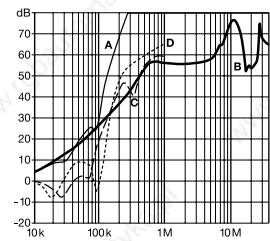

Mechanical data

6A types

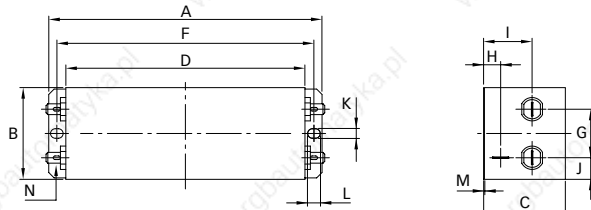

10 and 20A types

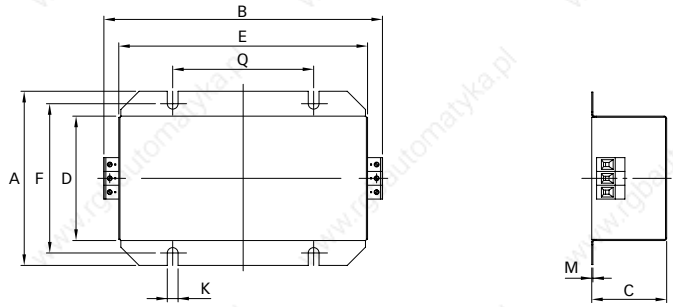

30A types

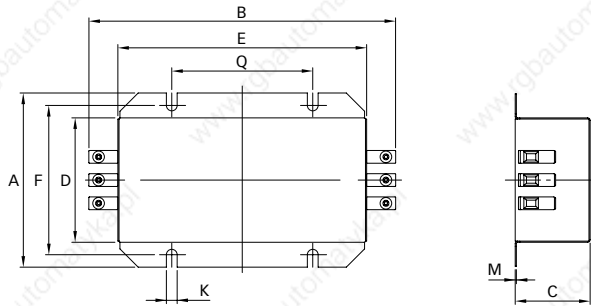

Dimensions

	6A	10A	20A	30A	Tolerances
A	152	126	150	150	±0.5
B	51	172.3	221.8	250	±0.5
C	45	55.25	65	65	±0.5
D	133	100.5	119.5	119.5	±0.5
E		150.5	200	200	±0.5
F	143	112	135	135	±0.5
G	27				±0.5
H	9.5				±0.5
I	27				±0.5
J	12				±0.5
K	5.3	6.4	6.4	6.4	
L	7				
M	0.5				
N	6.3 x 0.8				
Q		85	115	115	±0.1

All dimensions in mm; 1 inch = 25.4mm
 Tolerances according: ISO 2768-m / EN 22768-m

Filter input/output connector cross sections

	-06	-29	-33
Solid wire	n/a	6mm ²	16mm ²
Flex wire	n/a	4mm ²	10mm ²
AWG type wire	n/a	AWG 10	AWG 6
Recommended torque	n/a	0.6 - 0.8Nm	1.5 - 1.8Nm

Please visit www.schaffner.com to find more details on filter connectors.

Three-stage EMI Filter

energy efficiency and reliability



- Rated currents from 6 to 20A
- IEC inlet for 6 and 10A versions
- TEMPEST/NEMP
- Up to 3GHz attenuation
- High surge voltage protection

Approvals

ROHS

Technical specifications

Maximum continuous operating voltage:	250VAC, 50/60Hz
Operating frequency:	dc to 400Hz (6 and 10A types) dc to 60Hz (20A types)
Rated currents:	6 to 20A @ 40°C max.
High potential test voltage:	P → PE 420VAC for 2 sec P → N 420VAC for 2 sec
Temperature range (operation and storage):	-25°C to +85°C (25/85/21)
Flammability corresponding to:	UL 94V-2 or better
Design corresponding to:	UL 1283, CSA 22.2 No. 8 1986, IEC/EN 60939
MTBF @ 40°C/230V (Mil-HB-217F):	450,000 hours

Typical electrical schematic

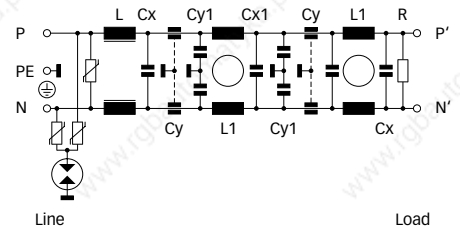

Features and benefits

- FN 700Z series is designed to meet highest filter attenuation requirements over a wide range starting from a few kilohertz up to 3GHz required for TEMPEST protection.
- Additional high surge voltage protection supports NEMP requirement.
- Choosing the FN 700Z product line brings you the rapid availability of a standard filter associated with the necessary safety acceptances.
- Standard filters are a practical solution helping you to pass EMI system approval in a short time.
- Exceptional conducted attenuation performance, based on three-stage design and chokes with high saturation resistance and excellent thermal behavior.
- Integrated gas discharge tubes and suppressors.
- IEC inlet version for 6 and 10A types.
- Custom-specific versions on request.

Typical applications

- Facility management
- Information protection
- Telecommunication
- Data processing
- Medical equipment
- Electrical and electronic equipment

Filter selection table

Filter	Rated current @ 40°C (25°C) [A]	Leakage current* @ 230VAC/50Hz [µA]	Inductance		Capacitance				Resistance R [MΩ]	Input connections	Output connections	Weight [kg]
			L	L1	Cx	Cx1	Cy	Cy1				
FN 700Z-6-06	6 (6.9)	440	50	17.1	1		2.5		0.33	IEC C14	-06	2
FN 700Z-10-06	10 (11.6)	440	50	9.4	1		2.5		0.33	IEC C14	-06	2.3
FN 700Z-20-03	20 (23)	2600	60	5.5	1	2.2	5	10	0.33	-03	-03	3.5

* Maximum leakage under normal operating conditions. Note: if the neutral line is interrupted, worst case leakage could reach twice this level.

Typical filter attenuation

Per CISPR 17; A = 50Ω/50Ω sym; B = 50Ω/50Ω asym; C = 0.1Ω/100Ω sym; D = 100Ω/0.1Ω sym

6A types

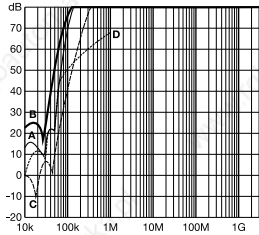

10 and 20A types

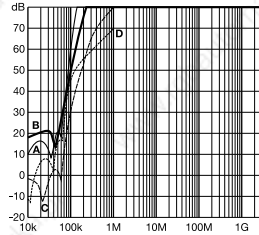

Mechanical data

6 and 10A types

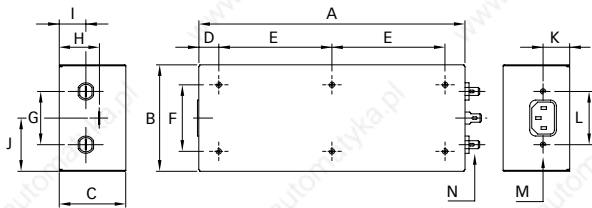

20A types

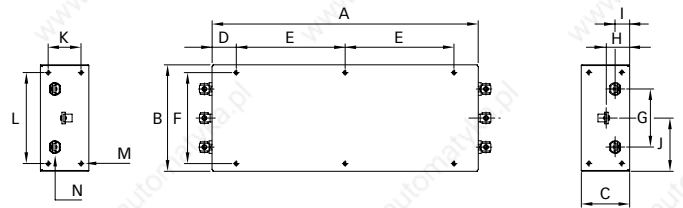

Dimensions

	6A	10A	20A	Tolerances
A	200	250	275	±0.3
B	80	80	110	±0.3
C	50	50	50	±0.2
D	15	25	25	±0.3
E	85	100	112.5	±0.2
F	50	50	94	±0.2
G	40	40	60	±0.3
H	30	30	15	±0.5
I	20	20	25	±0.3
J	40	40	55	±0.3
K	20	20	34	±0.3
L	40	40	94	±0.1
M	M4 x 6	M4 x 6	M4 x 6	
N	6.3 x 0.8	6.3 x 0.8	M4	

All dimensions in mm; 1 inch = 25.4mm
Tolerances according: ISO 2768-m / EN 22768-m





EMC/EMI Chokes

RD Series	139
RN Series	143
EV/EH Series	147
RI Series	150

Current-compensated Chokes

SCHAFFNER
energy efficiency and reliability



- Rated currents from 6 to 64A
- Up to 600VAC or 850VDC
- DC to 400Hz frequencies
- Dual, triple and quad-choke configurations

ROHS

Technical specifications

Maximum continuous operating voltage:	600VAC/850VDC @ 40°C
Operating frequency:	dc to 400Hz
Rated currents:	6 to 64A @ 40°C max.
High potential test voltage winding-to-winding @ 25°C:	2500VAC, 60 sec, guaranteed 2500V, 50Hz, 2 sec, factory test
winding-to-housing @ 25°C:	4000VAC, 60 sec, guaranteed
Surge current @ 10msec:	20 x I _{nominal} @ 25°C
Temperature range (operation and storage):	-25°C to +110°C (25/110/21)
Flammability corresponding to:	UL 94V-0 (insulation tubes UL 94V-2)
MTBF @ 40°C/230V (Mil-HB-217F):	> 5,000,000 hours

Typical electrical schematic

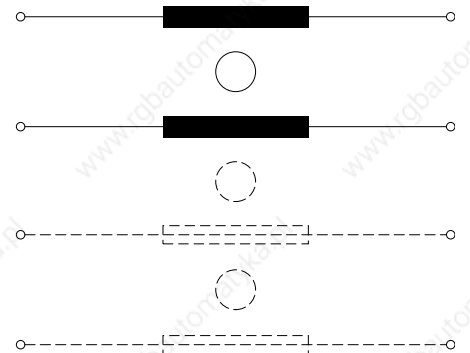

RD chokes are attenuating common-mode or asymmetric (P/N → E) interference signals, by being connected in series with the phase and neutral lines of an AC powerline input. Symmetrical components of the noise are also attenuated by the leakage inductance of the windings. These chokes are typically used in conjunction with suppression capacitors.

Features and benefits

- High saturation resistance and excellent thermal behavior.
- Through hole or wire connections.
- Dual, triple and quad-choke configuration.
- Up to 64A quad configuration.
- Multiple housing options.
- Custom-specific versions are available on request.

Typical applications

- Phase-angle control circuits in combination with saturating chokes
- EMI input filters
- For suppressing equipment with no earth connection
- Suppressing high interference levels

Choke selection table

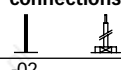
Choke	Nominal current @ 40°C	Inductance L [mH/path]	Resistance R [mΩ/path]	Choke configuration [Qty]	Input/Output connections 	Pin footprint [mm]	Weight [g]
	[A]						
RD 5122-6-9m6	6	9.6	52.55	2	-02	Ø1	160
RD 5122-10-6m0	10	6	24.25	2	-02	Ø1.3	160
RD 5122-16-2m0	16	2	9.5	2	-02	Ø1.6	160
RD 5132-6-5m0	6	5	38	3	-02	Ø1	160
RD 5132-10-3m0	10	3	17.6	3	-02	Ø1.3	160
RD 5132-16-1m0	16	1	6.9	3	-02	Ø1.6	160
RD 6127-6-15m0	6	15	66.65	2	-07	Ø1	235
RD 6127-10-9m0	10	9	25.9	2	-07	Ø1.5	235
RD 6127-16-3m0	16	3	10.9	2	-07	Ø1.8	235
RD 6137-6-7m5	6	7.5	49	3	-07	Ø1	235
RD 6137-10-4m5	10	4.5	18.35	3	-07	Ø1.5	235
RD 6137-16-1m5	16	1.5	8.3	3	-07	Ø1.8	235
RD 7127-6-25m0	6	25	84.2	2	-07	Ø1	320
RD 7127-10-14m0	10	14	33.5	2	-07	Ø1.4	350
RD 7127-16-5m7	16	5.7	14.1	2	-07	Ø1.8	370
RD 7127-25-2m8	25	2.8	6.4	2	-07	Ø2.4	400
RD 7127-36-1m0	36	1	3.3	2	-07	Ø2.7	380
RD 7137-6-12m0	6	12	60.6	3	-07	Ø1	340
RD 7137-10-6m6	10	6.6	21.9	3	-07	Ø1.5	380
RD 7137-16-2m8	16	2.8	10.7	3	-07	Ø1.8	380
RD 7137-25-1m3	25	1.3	4.45	3	-07	Ø2.5	440
RD 7137-36-0m5	36	0.5	2.75	3	-07	Ø2.7	400
RD 7147-6-6m0	6	6	45.1	4	-07	Ø1	320
RD 7147-10-3m5	10	3.5	19.1	4	-07	Ø1.4	370
RD 7147-16-1m5	16	1.5	8.5	4	-07	Ø1.8	390
RD 7147-25-0m7	25	0.7	3.65	4	-07	Ø2.4	430
RD 7147-36-0m2	36	0.2	2.3	4	-07	Ø2.5	400
RD 8127-16-12m0	16	12	20.05	2	-07	Ø2	590
RD 8127-25-5m0	25	5	8.45	2	-07	Ø2.4	630
RD 8127-36-3m0	36	3	4.55	2	-07	1.5 x 4.5	690
RD 8127-50-1m0	50	1	2.5	2	-07	1.7 x 5	640
RD 8127-64-0m8	64	0.8	1.6	2	-07	2.5 x 5	710
RD 8137-16-5m0	16	5	11.6	3	-07	Ø2	630
RD 8137-25-2m5	25	2.5	6.4	3	-07	Ø2.4	650
RD 8137-36-1m5	36	1.5	3.65	3	-07	1.5 x 4.5	720
RD 8137-50-0m6	50	0.6	2.15	3	-07	1.7 x 5	700
RD 8137-64-0m5	64	0.5	1.35	3	-07	2.5 x 5	780
RD 8147-16-3m0	16	3	9.25	4	-07	Ø2	650
RD 8147-25-1m3	25	1.3	5.05	4	-07	Ø2.4	650
RD 8147-36-0m8	36	0.8	3	4	-07	1.5 x 4.5	760
RD 8147-50-0m3	50	0.3	1.75	4	-07	1.7 x 5	740
RD 8147-64-0m2	64	0.2	1.1	4	-07	2.5 x 5	820

Test conditions:

Measuring frequency: 1kHz; 500µA > 0.16mH > 1.6mH; 50µA > 1.6mH < 160mH

Inductance tolerance: +50%, -30%

Resistance tolerance: max. ±15% @ 25°C; 200mΩ, 100mA

Electrical characteristics @ 25°C: ±2°C

Typical choke attenuation/resonance frequency characteristics

Per CISPR 17; 50Ω/50Ω asym

RD 51x2

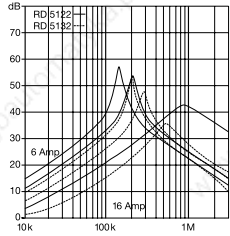

RD 61x7

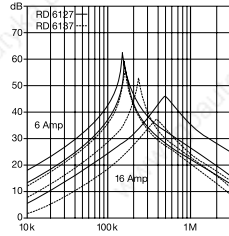

RD 7127

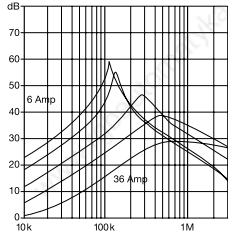

RD 7137

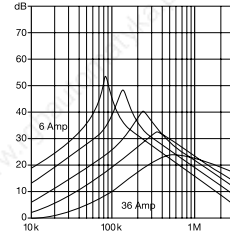

RD 7147

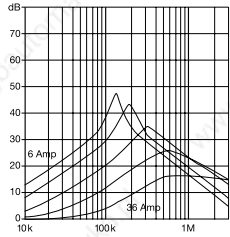

RD 8127

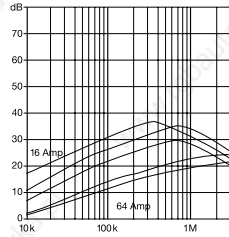

RD 8137

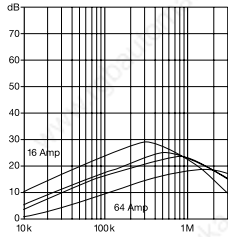

RD 8147

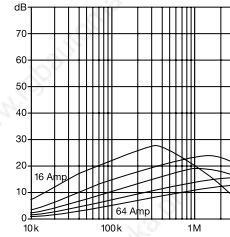

Typical saturation characteristics

Inductance (typical value in %) vs. nominal current (A DC)

RD 51x2

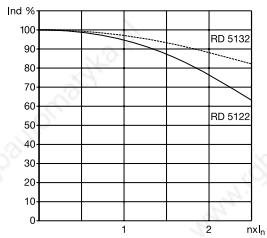

RD 61x7

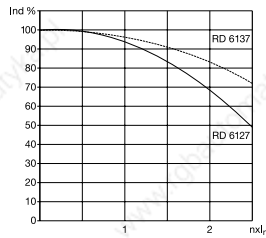

RD 71x7

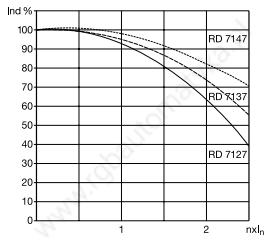

RD 81x7

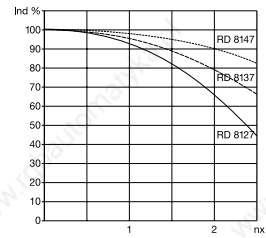

Mechanical data

RD 5122

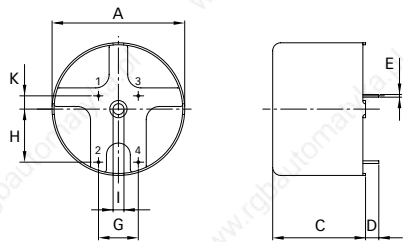

RD 5132

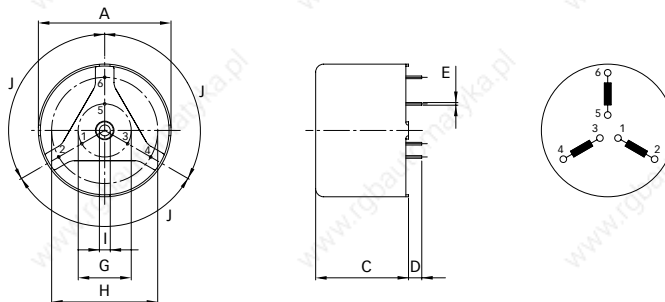

RD 6127, RD 7127, RD 8127

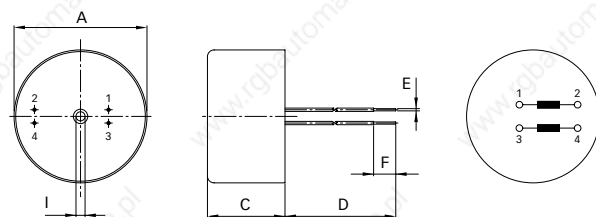

RD 6137, RD 7137, RD 8137

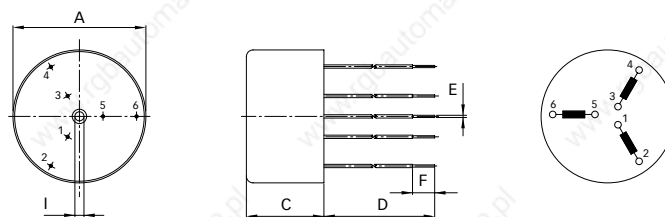

RD 7147, RD 8147

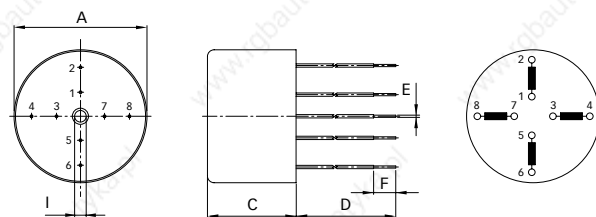

Dimensions

	RD 5122	RD 5132	RD 6127	RD 6137	RD 7127	RD 7137	RD 7147	RD 8127	RD 8137	RD 8147	Tolerances	
A	50	50	60	60	70	70	70	80	80	80	±0.5	
C	35	35	35	35	40	40	40	50	50	50	±0.5	
D	5 ±0.5	5 ±0.5	150	150	150	150	150	200	200	200	+5/-0	
E	see choke selection table											
F	10			10	10	10	10	20	20	20	±1	
G	15	20										±0.3
H	20	40 ±0.4										±0.3
I	4.1 +3/-0	4.1 +3/-0	4.1 +3/-0	4.1 +3/-0	6.1	6.1	6.1	6.1	6.1	6.1	+6/-0	
J	120°											
K	5											

All dimensions in mm; 1 inch = 25.4mm
 Tolerances according: ISO 2768-m / EN 22768-m

Current-compensated Chokes



energy efficiency and reliability

- Rated currents from 0.3 to 10A
- DC to 1kHz frequency
- 100kHz to 3MHz common-mode resonance frequency
- Dual-choke configurations
- Multiple PCB-mounting options

Approvals



Technical specifications

Maximum continuous operating voltage:	250VAC @ 40°C
Operating frequency:	dc to 1kHz
Rated currents:	0.3 to 10A @ 40°C max.
High potential test voltage winding-to-winding @ 25°C:	1500VAC, 60 sec, guaranteed
	1500V, 50Hz, 2 sec, factory test
winding-to-housing @ 25°C:	4000VAC, 60 sec, guaranteed
Surge current @ 10msec:	20 x I _{nominal} @ 25°C
Temperature range (operation and storage):	-40°C to +125°C (40/125/56)
Flammability corresponding to:	UL 94V-0
MTBF @ 40°C/230V (Mil-HB-217F):	> 5,000,000 hours

Typical electrical schematic

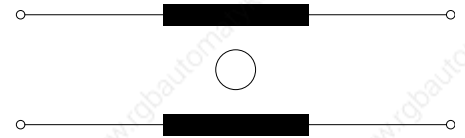

RN chokes are attenuating common-mode or asymmetric (P/N → E) interference signals, by being connected in series with the phase and neutral lines of an AC powerline input. Symmetrical components of the noise are also attenuated by the leakage inductance of the windings. These chokes are typically used in conjunction with suppression capacitors.

Features and benefits

- High saturation resistance and excellent thermal behavior.
- Through hole pin connections.
- Dual-choke configuration.
- Small compact design.
- Multiple housing options.
- Custom-specific versions are available on request.

Typical applications

- Phase-angle control circuits in combination with saturating chokes
- EMI input filters
- For suppressing equipment with no earth connection
- Suppressing high interference levels

Choke selection table

Choke*	Nominal current @ 40°C	Inductance L	Resistance R	Choke configuration	Input/Output connections	Weight	
						Type 1	Type 2
	[A]	[mH/path]	[mΩ/path]	[Qty]		[g]	[g]
RN x02-0.3-02	0.3	12	1275	2	-02	2	3
RN x02-0.6-02	0.6	4.4	385	2	-02	2	3
RN x02-1-02	1	3	205	2	-02	2	3
RN x02-1.5-02	1.5	1.6	100	2	-02	2	3
RN x02-2-02	2	1.1	70	2	-02	2	3
RN x12-0.4-02	0.4	39	1460	2	-02	5	6
RN x12-0.5-02	0.5	27	1250	2	-02	5	6
RN x12-0.6-02	0.6	15	465	2	-02	5	6
RN x12-0.8-02	0.8	10	370	2	-02	5	6
RN x12-1.2-02	1.2	6.8	245	2	-02	5	6
RN x12-1.5-02	1.5	3.3	135	2	-02	5	6
RN x12-2-02	2	1.8	75	2	-02	5	6
RN x12-4-02	4	0.7	27	2	-02	5	6
RN x14-0.3-02	0.3	47	1750	2	-02	9	12
RN x14-0.5-02	0.5	39	810	2	-02	9	12
RN x14-0.8-02	0.8	27	500	2	-02	9	12
RN x14-1-02	1	15	375	2	-02	9	12
RN x14-1.2-02	1.2	10	200	2	-02	9	12
RN x14-1.5-02	1.5	6.8	130	2	-02	9	12
RN x14-2-02	2	4.2	102	2	-02	9	12
RN x14-2.5-02	2.5	3.3	72	2	-02	9	12
RN x14-3-02	3	2	55	2	-02	9	12
RN x14-4-02	4	1.5	35	2	-02	9	12
RN x22-0.6-02	0.6	47	1180	2	-02	17	21
RN x22-0.8-02	0.8	39	1000	2	-02	17	21
RN x22-1-02	1	18	610	2	-02	17	21
RN x22-1.5-02	1.5	10	220	2	-02	17	21
RN x22-2-02	2	6.8	147	2	-02	17	21
RN x22-2.5-02	2.5	5.6	105	2	-02	17	21
RN x22-3-02	3	4.5	80	2	-02	17	21
RN x22-4-02	4	3.3	45	2	-02	17	21
RN x42-0.5-02	0.5	82	2700	2	-02	32	32
RN x42-1-02	1	33	810	2	-02	32	32
RN x42-1.4-02	1.4	27	500	2	-02	32	32
RN x42-2-02	2	6.8	190	2	-02	32	32
RN x42-4-02	4	3.3	66	2	-02	32	32
RN x42-6-02	6	1.8	20	2	-02	32	32
RN 143-0.5-02	0.5	100	2900	2	-02	33	
RN 143-1-02	1	47	880	2	-02	33	
RN 143-2-02	2	10	230	2	-02	33	
RN 143-4-02	4	3.9	58	2	-02	33	
RN 143-6-02	6	1.8	20	2	-02	33	
RN 152-1-02	1	68	1300	2	-02	54	
RN 152-2-02	2	18	350	2	-02	54	
RN 152-4-02	4	6.8	87	2	-02	54	
RN 152-6-02	6	3.9	41	2	-02	54	
RN 152-8-02	8	2.7	22	2	-02	54	
RN 152-10-02	10	1.8	14	2	-02	54	

* Replace the x by the desired housing style type 1 or 2.



1: Choke horizontal



2: Choke vertical

Test conditions:

Measuring frequency: 10kHz; 5mA < 16μH; 500μA > 16μH < 160μH; 50μA > 160μH < 16mH; 50mV > 16mH < 160mH

Inductance tolerance: +50%, -30%

Resistance tolerance: max. ±15% @ 25°C; ≤ 20mΩ, 1A; > 20mΩ ≤ 200mΩ, 100mA; > 200mΩ ≤ 2Ω, 10mA

Electrical characteristics @ 25°C: ±2°C

Typical choke attenuation/resonance frequency characteristics

Per CISPR 17; 50Ω/50Ω asym

RN x02

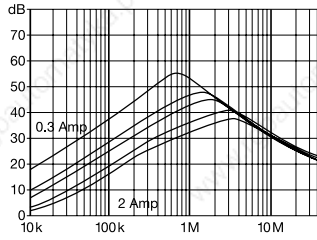

RN x12

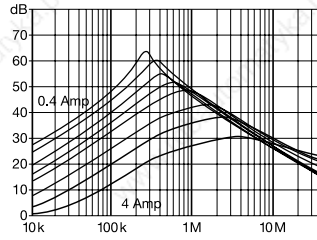

RN x14

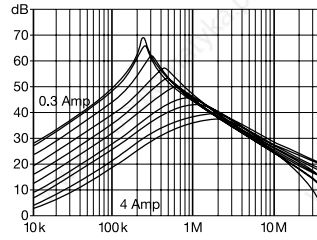

RN x22

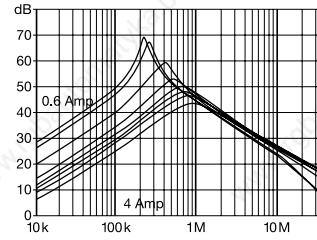

RN x42

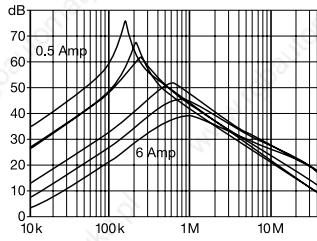

RN 143

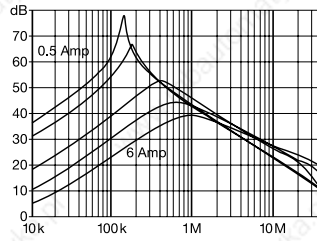

RN 152

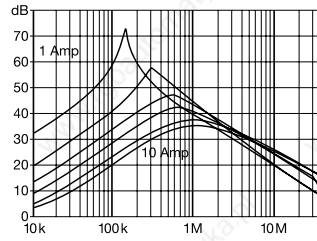

Typical saturation characteristics

Inductance (typical value in %) vs. nominal current (A DC)

RN x02 / RN x12 / RN x14 / RN x22

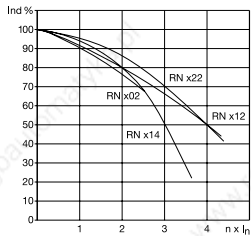

RN x42 / RN 143 / RN 152

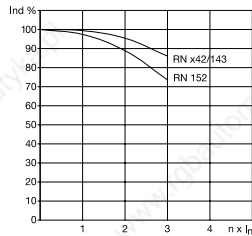

Mechanical data

RN 102

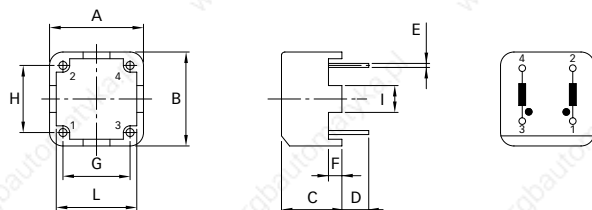

RN 112, RN 114, RN 122, RN 142, RN 143

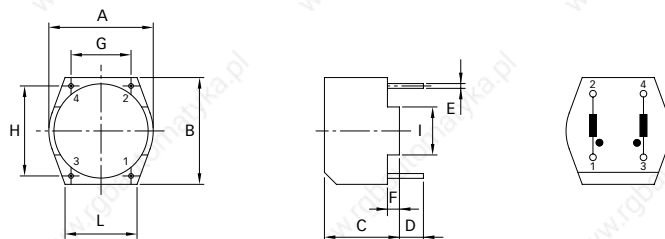

RN 202

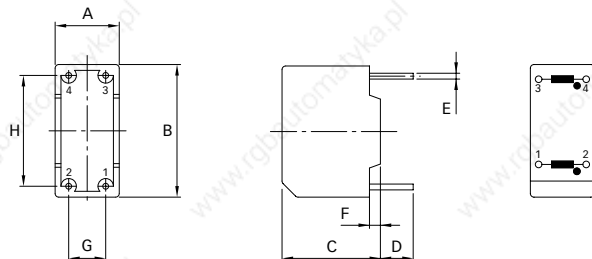

RN 212, RN 214, RN 222, RN 242

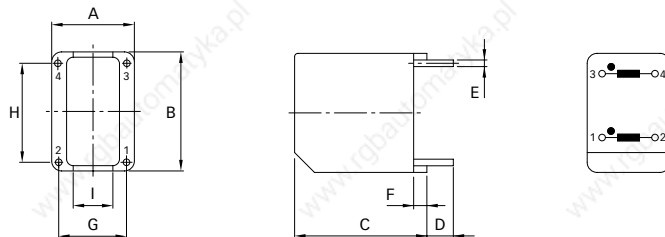

RN 152

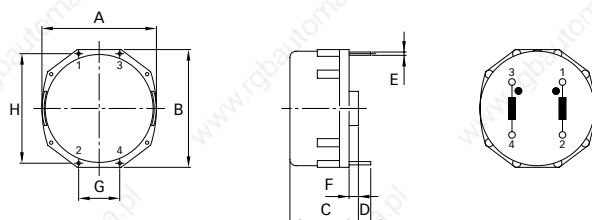

Dimensions

	RN 102	RN 112	RN 114	RN 122	RN 202	RN 212	RN 214	RN 222	RN 142	RN 143	RN 242	RN 152	Tol.
A	14	17.1	21.5	27	8.8	12.5	15.5	18	32.5	32.5	18	41.8	±0.3
B	14	17.7	22.5	28	18.2	18	23	31	33.1	33.1	31	43	±0.3
C	9	12.6	13.2	16.5	13.5	20	25	29.3	19.7	19.7	34.3	25	±0.3
D	4	4	4	4	4.5	4	4	4	4.3	4.3	4.2	4.5	±0.5
E	0.6	0.8	0.8	0.8	0.8	0.8	0.8	0.8	0.8	0.8	0.8	1.2	±0.1
F	2	2			1.5	2						3.4	
G	10	10	12.5	15	5.08	10	12.5	15	20	20	15	15	±0.2
H	10	15	20.1	25	15.21	15	10	12.5	30	30	12.5	40	±0.2
I	4	8				6							
L	12	12											

All dimensions in mm; 1 inch = 25.4mm
Tolerances according: ISO 2768-m / EN 22768-m

Common-mode Suppression Chokes



energy efficiency and reliability



- Rated currents up to 5A
- Broadband attenuation characteristics
- Low magnetic leakage flux
- UL rated materials
- RoHS compliant



Technical specifications

Maximum continuous operating voltage:	250VAC @ 50°C
Operating frequency:	dc to 400Hz @ 50°C
Rated currents:	0.3 to 5A
Overcurrent:	1.5x I _{nominal} for 1 minute, once per hour
High potential test voltage winding-to-winding @ 25°C:	3000VAC, 60 sec, guaranteed 2000V, 50Hz, 2 sec, factory test
Temperature range (operation and storage):	-25°C to +100°C (25/100/21)
Flammability corresponding to:	UL 94V-0
Test conditions	
Measuring frequency:	10kHz; 5mA < 16μH; 500μA > 16μH < 160μH; 50μA > 160μH > 16mH; 50mV > 16mH < 160mH Inductance tolerance ±30%
Resistance:	Tolerance max. ±15% @ 25°C; ≤ 20mΩ, 1A; > 20mΩ ≤ 200mΩ, 100mA; > 200mΩ ≤ 2V, 10mA
Electrical characteristics:	@ 25°C ±2°C

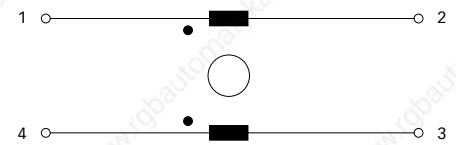
Typical electrical schematic



Common-mode suppression chokes are mainly used to filter noise on AC power lines. Noise on commercial power lines could enter the equipment and disturb the proper function. Noise generated by the equipment for example from switch mode power supplies need to be filtered and the spread of such generated noise need to be suppressed. Common-mode suppression chokes together with line bypass capacitors building an AC EMI suppression filter device.

Features and benefits

- Rated currents up to 5A.
- Compact and light weight.
- Low magnetic leakage flux.
- Sectional winding.
- Standard foot print.
- Broad range of available inductances and current ratings.
- Custom-specific versions.
- Schaffner offers you also EMI measurement service to verify that your design will pass the required safety standards.

Typical applications

- Input filters for switch mode power supplies
- Filters to reduce leaking noise
- TVs, VCRs, multimedia and audio equipment
- Office automation, communications and other electronic devices
- Electric ballast
- AC/AC converters

Choke selection table

EV choke	EH choke	L nominal (±30%) [mH]	DC resistance R [mΩ]	Rated current I (50°C) [A]	Weight [g]
EV 20-0.3-02-33M	EH 20-0.3-02-33M	33	1780	0.3	10
EV 20-0.5-02-18M	EH 20-0.5-02-18M	18	725	0.5	10
EV 20-0.8-02-5M6	EH 20-0.8-02-5M6	5.6	245	0.8	10
EV 20-1.0-02-3M9	EH 20-1.0-02-3M9	3.9	168	1.0	10
EV 20-1.2-02-3M3	EH 20-1.2-02-3M3	3.3	127	1.2	10
EV 20-1.5-02-1M8	EH 20-1.5-02-1M8	1.8	72	1.5	10
EV 20-2.0-02-0M8	EH 20-2.0-02-0M8	0.82	38	2.0	10
EV 24-0.5-02-44M	EH 24-0.5-02-44M	44	1250	0.5	18
EV 24-0.8-02-18M	EH 24-0.8-02-18M	18	438	0.8	18
EV 24-1.0-02-10M	EH 24-1.0-02-10M	10	244	1.0	18
EV 24-1.5-02-4M5	EH 24-1.5-02-4M5	4.5	116	1.5	18
EV 24-2.0-02-2M5	EH 24-2.0-02-2M5	2.5	62	2.0	18
EV 24-3.0-02-1M2	EH 24-3.0-02-1M2	1.2	29	3.0	18
EV 24-4.0-02-0M5	EH 24-4.0-02-0M5	0.5	16	4.0	18
EV 28-1.0-02-36M	EH 28-1.0-02-36M	36	591	1.0	31
EV 28-1.5-02-20M	EH 28-1.5-02-20M	20	282	1.5	31
EV 28-2.0-02-11M	EH 28-2.0-02-11M	11	162	2.0	31
EV 28-3.0-02-5M0	EH 28-3.0-02-5M0	5	79	3.0	31
EV 28-4.0-02-2M3	EH 28-4.0-02-2M3	2.3	40	4.0	31
EV 28-5.0-02-1M1	EH 28-5.0-02-1M1	1.1	27	5.0	31
EV 35-1.0-02-90M	EH 35-1.0-02-90M	90	628	1.0	70
EV 35-2.0-02-20M	EH 35-2.0-02-20M	20	150	2.0	70
EV 35-3.0-02-10M	EH 35-3.0-02-10M	10	72	3.0	70
EV 35-4.0-02-5M0	EH 35-4.0-02-5M0	5	53	4.0	70
EV 35-5.0-02-3M6	EH 35-5.0-02-3M6	3.6	33	5.0	70

All wires rated 130°C or higher.

Typical choke attenuation

Per CISPR 17; 50Ω/50Ω asym

EV/EH 20 types

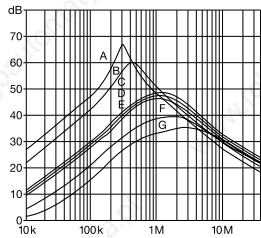

- A = 33mH
- B = 18mH
- C = 5.6mH
- D = 3.9mH
- E = 3.3mH
- F = 1.8mH
- G = 0.8mH

EV/EH 24 types

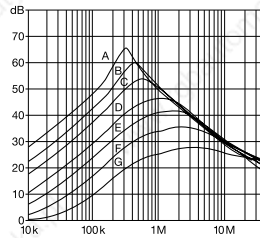

- A = 44mH
- B = 18mH
- C = 10mH
- D = 4.5mH
- E = 2.5mH
- F = 1.2mH
- G = 0.5mH

EV/EH 28 types

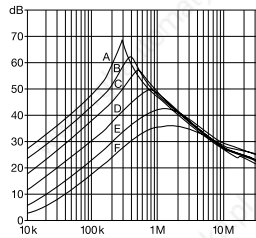

- A = 36mH
- B = 20mH
- C = 11mH
- D = 5mH
- E = 2.3mH
- F = 1.1mH

EV/EH 35 types

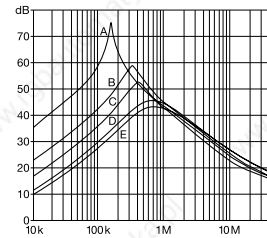

- A = 90mH
- B = 20mH
- C = 10mH
- D = 5mH
- E = 3.6mH

Mechanical data

EV 20

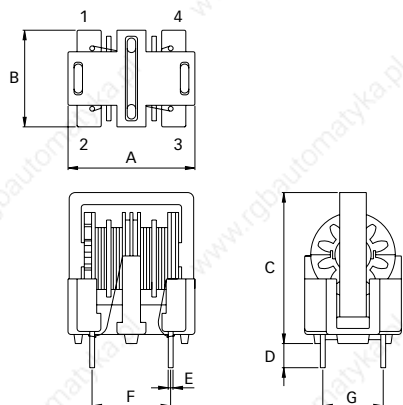

EV 24 and 28

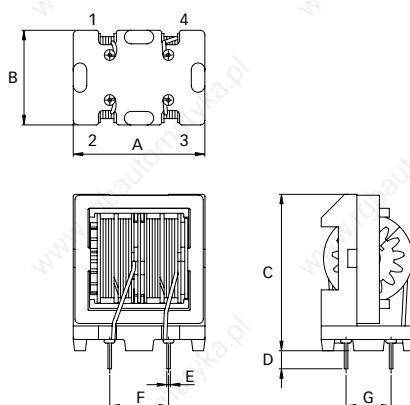

EV 35

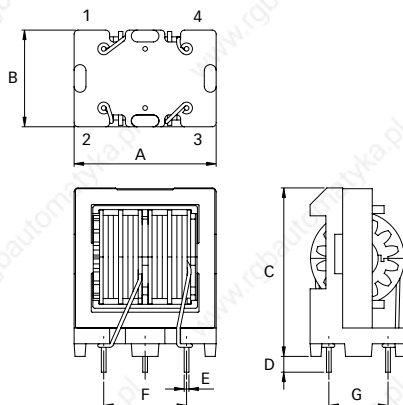

EH 20 to 35

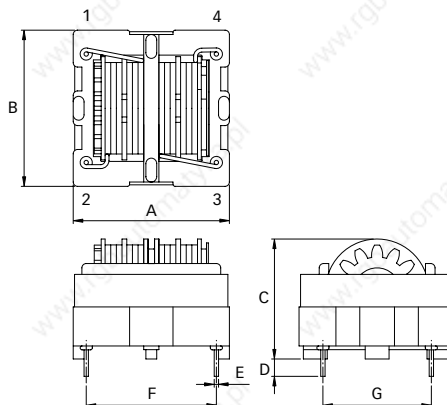

Dimensions

	EV 20	EV 24	EV 28	EV 35	EH 20	EH 24	EH 28	EH35	Tolerances
A	21	24.6	29.2	36	21	24	28	36	±1
B	16	17.4	21	24.5	21	24	28	36	±1
C	25*	29.1	34.7	42.7	17.8	20	22.9	27.7	±1
D	4	4	4	4	4	4	4	4	±1
E	Ø0.8	Ø0.8	Ø0.8	Ø1.2	Ø0.8	Ø0.8	Ø0.8	Ø1.0	±0.1
F	13	13	13	21	13	21	24	30	±0.5
G	10	10	10	15	10	15	20	25	±0.5

All dimensions in mm; 1 inch = 25.4mm

* Tolerance is +1/-2mm

Saturating Chokes

SCHAFFNER
energy efficiency and reliability



- Rated currents from 1.5 to 25A
- Up to 500VAC operating voltage
- DC to 1kHz frequency
- Single or dual-choke configurations

ROHS

Technical specifications

Maximum continuous operating voltage:	500VAC @ 40°C
Operating frequency:	dc to 1kHz
Rated currents:	1.5 to 25A @ 40°C max.
High potential test voltage	
winding-to-winding @ 25°C:	2500VAC, 60 sec, guaranteed
and/or winding-to-inserts:	2500V, 50Hz, 2 sec, factory test
Surge current @ 10msec:	20 X I _{nominal} @ 25°C
Temperature range (operation and storage):	-25°C to +110°C (25/110/21)
Flammability corresponding to:	UL 94V-0
MTBF @ 40°C/230V (Mil-HB-217F):	> 5,000,000 hours

Typical electrical schematic



RI saturating type chokes change impedance at the moment of switching, and can be used to attenuate differential-mode noise or symmetrical interference as generated in fast switching high current applications. These chokes are typically used in conjunction with suppression capacitors. For optimum attenuation chokes must be connected as close as possible to the semiconductor switching device.



Features and benefits

- Excellent thermal behavior.
- Through hole or wire connections.
- Single or dual-choke configurations.
- Up to 25A single configuration.
- Custom-specific versions are available on request.

Typical applications

- Suppressing high interference levels generated by fast switching circuits
- DC voltage smoothing
- EMC/EMI filters
- Phase angle control circuits
- Power supplies
- Chargers

Choke selection table

Choke	Nominal current @ 40°C	Resistance R	Choke configuration	Input/Output connections	Weight [g]
	[A]	[mΩ/path]	[Qty]	 	
RI 111 PC	6	42	2	02	170
RI 401 PC	1.5	620	1	02	15
RI 403 PC	3	105	1	02	30
RI 406 PC	6	53	1	02	55
RI 410 PC	10	28	1	02	95
RI 415	15	8	1	07	205
RI 425	25	4	1	07	325

Test conditions:

Resistance tolerance: max. ±15% @ 25°C; < 200mΩ, 100mA; > 200mΩ ≤ 2Ω, 10mA

Electrical characteristics @ 25°C: ±2°C

Typical saturation characteristics

Inductance (typical value in %) vs. nominal current in %

RI series

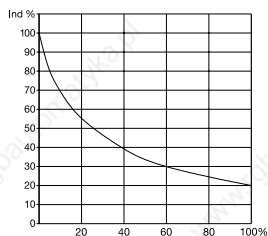

Mechanical data

RI 111

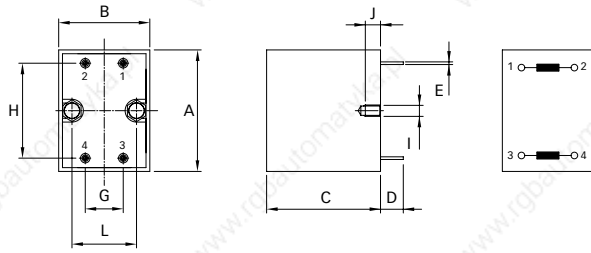

RI 401, RI 403, RI 406

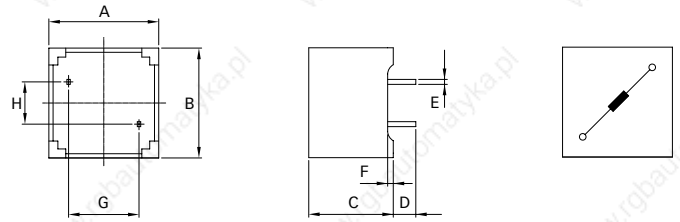

RI 410

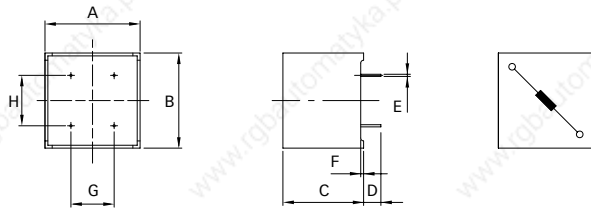

RI 415, RI 425

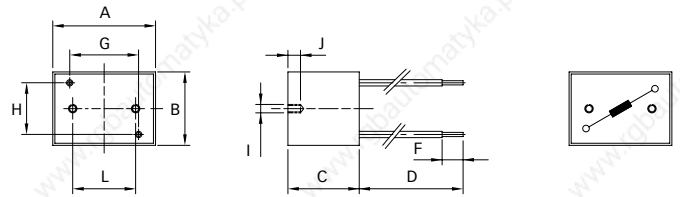

Dimensions

	RI 111	RI 401	RI 403	RI 406	RI 410	RI 415	RI 425	Tolerances
A	49	19.5	23.3	28.5	33	35	48	
B	35	19.5	23.3	28.5	33	49	48	
C	34	15	18	21.5	28	34	43	±0.3
D	15	4	6	4.5	6	200	200	
E	Ø1.15	0.6 x 0.88	Ø0.9	0.6 x 0.88	0.75 x 1.1			±0.1
F		1			1	10	10	
G	20	12.5	15	20	17.5	22	39	
H	40	7.5	10	10	15	36	35	
I	M4					M4	M4	
J	6					6	6	+0/-0.5
L	21					30	30	±0.25

All dimensions in mm; 1 inch = 25.4mm
 Tolerances according: ISO 2768-m / EN 22768-m



Pulse Transformers

IT series with single secondary winding	155
IT series with double secondary winding	158

Pulse Transformer with Single Secondary Winding

SCHAFFNER
energy efficiency and reliability



- Galvanic separation of drive and power circuit
- Voltage resistance up to 8kV
- Ignition current up to 3A
- Turns ratio up to 3:1

Approvals

ROHS

Technical specifications

Nominal operating voltage:	Up to 3000V
Operating frequency:	40kHz max.
	500kHz max. for data transmission
Ignition currents:	0.1 to 3A @ 40°C
Rise time:	0.3 to 2.3µs
Test voltage:	$U_p/50\text{Hz}/2\text{s}$ max. according to VDE 110b
Max. partial discharge voltage:	$1.5 \times U_{\text{nom}}$
Temperature range (operation and storage):	-25°C to +70°C (25/70/21)
Flammability corresponding to:	UL 94V-0 listed materials

Typical electrical schematic

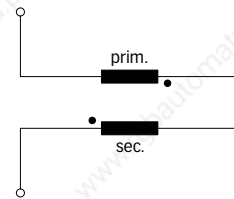

IT pulse transformers are designed to offer you galvanic isolation for transformer coupled gate drives. The IT series provides negligible delays and the possibility of voltage scaling. They are available with single or double secondary winding for multiple gate drives. Choosing the IT product line brings you the rapid availability of a standard gate drive transformer. A wide selection on turns ratio, ignition current and voltages are designed to offer you the desired standard product.

Features and benefits

- Galvanic separation.
- Voltage resistance up to 8kV.
- Allows high potential difference voltage scaling.
- Optional grounded shields.
- Vacuum potting.
- Very low partial discharge effects.
- PCB through hole mounting or faston types.
- Custom-specific versions on request.

Typical applications

- Gate drive circuit
- Power supplies
- Power converters
- Frequency converters
- Switching applications
- DC/DC converters
- Line coupling transformers in high-speed data transmission

Pulse transformer selection table

Pulse transformer	Turns ratio	Ignition current I_{ign} [A]	Voltage		Voltage time area V_{ot} [V μ s]	Rise time t_r [μ s]	Inductance		Resistance		Coupling capacitance C_k [pF]	Input/ Output connections 	Weight [g]
			U_{nom} [V]	U_p [kV]			L_p [mH]	L_{str} [μ H]	R_p [Ω]	R_s [Ω]			
IT 155	1:1	0.1	500	4	480	1	5	85	1.2	1.2	6	02	13
IT 245	1:1	0.1	750	4	500	1.2	8	100	1.48	1.48	10	02	6
IT 237	1:1	0.25	500	2.5	1100	1	25	35	1.9	2.2	50	02	14
IT 239	1:1	0.25	1000	6	300	2.3	3	80	0.9	0.9	5	02	13
IT 255	1:1	0.25	750	4	250	1.1	2.2	40	0.8	0.8	8	02	6
IT 258	1:1	1	750	3.2	250	0.25	2.5	3	0.62	0.75	80	02	6
IT 370	1:1	1	1000	5	4000	0.6	0.3	6	0.16	0.18	40	02	71
IT 364*	1:1	3	3000	8	5000	1.7	1.5	10	0.16	0.14	35	05	220
IT 246	2:1	0.1	750	4	200	0.4	7	35	2.1	1.1	7	02	6
IT 248	2:1	0.25	750	3.2	350	2.2	17	80	3.2	1.6	9	02	6
IT 260	3:1	0.1	500	3.2	200	0.3	12	30	2	0.8	8	02	6

* Not suitable for PCB-mounting.

Explanations:

- t_r rise time at given load resistor R and 70% of the output pulse height.
- L_p primary inductance measured at 1kHz (secondary coil open).
- L_{str} stray inductance measured at the secondary side, short circuit at the primary side. If there are several secondary coils only one at the time is connected (measuring frequency 10kHz).
- The ignition current is a set peak value where the voltage drop over the coil resistance is still insignificant (mostly below 1V).

Mechanical data

IT 245, IT 246, IT 248, IT 255, IT 258, IT 260

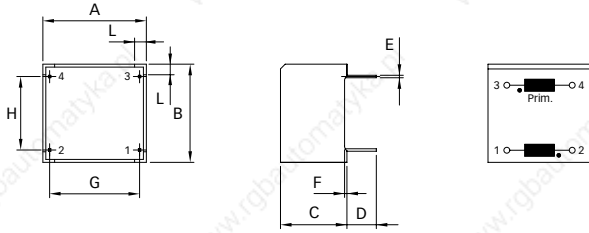

IT 239

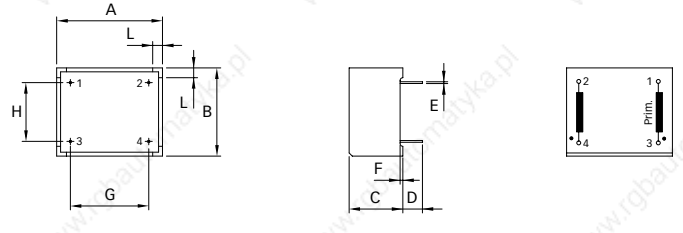

IT 155, IT 237

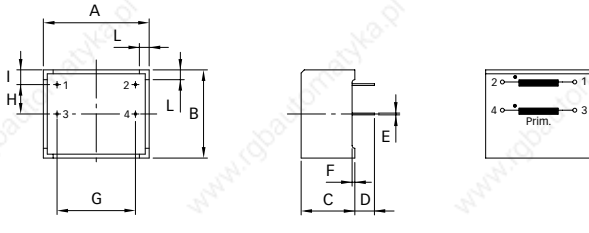

IT 364

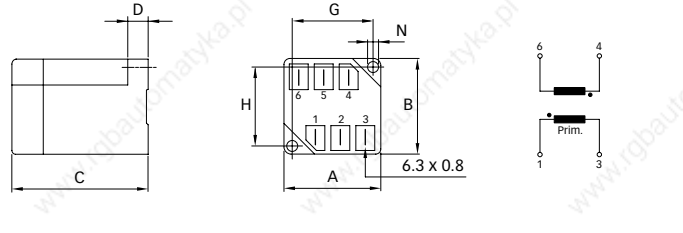

IT 370

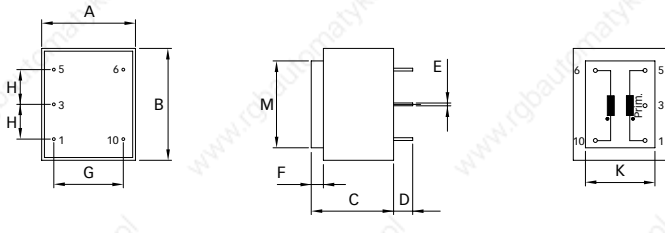

Dimensions

	IT 245	IT 246	IT 248	IT 255	IT 258	IT 260	IT 239	IT 155	IT 237	IT 364	IT 370	Tol.
A	17.6*	17.6*	17.6*	17.6*	17.6*	17.6*	27	27	27	50	27	±0.2
B	16.7*	16.7*	16.7*	16.7*	16.7*	16.7*	22.5	22.5	22.5	50	32.2	±0.2
C	11.3*	11.3*	11.3*	11.3*	11.3*	11.3*	13.7	13.7	13.7	60	23.7	±0.2
D	5	5	5	5	5	5	5	5	5	10*	5.5	+1/-0
E	□0.42	□0.42	□0.42	□0.42	□0.42	□0.42	□0.45	□0.45	□0.45		∅0.8	
F	0.4	0.4	0.4	0.4	0.4	0.4	0.7	0.7	0.7		3.5	
G	15.3	15.3	15.3	15.3	15.3	15.3	20	20	20	42	20	±0.2
H	12.5	12.5	12.5	12.5	12.5	12.5	15	7.5	7.5	42	10	±0.2
I								3.5	3.5			±0.2
L	2	2	2	2	2	2	2.5	2.5	2.5			
M											25	±0.2
N										∅4.2		

* Tolerance is ±0.1
 All dimensions in mm; 1 inch = 25.4mm
 Tolerances according to: ISO 2768-m / EN 22768-m

Pulse Transformer with Double Secondary Winding

SCHAFFNER
energy efficiency and reliability



- Galvanic separation of drive and power circuit
- Voltage resistance up to 4kV
- Ignition current up to 1A
- Turns ratio up to 3:1:1

Approvals

ROHS

Technical specifications

Nominal operating voltage:	Up to 500V
Operating frequency:	40kHz max.
	500kHz max. for data transmission
Ignition currents:	0.025 to 1A @ 40°C
Rise time:	0.4 to 4.0µs
Test voltage:	$U_p/50\text{Hz}/2\text{s}$ max. according to VDE 110b
Max. partial discharge voltage:	$1.5 \times U_{\text{nom}}$
Temperature range (operation and storage):	-25°C to +70°C (25/70/21)
Flammability corresponding to:	UL 94V-0 listed materials

Typical electrical schematic

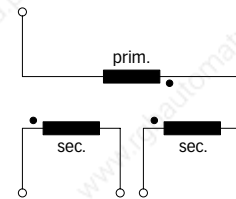

IT pulse transformers are designed to offer you galvanic isolation for transformer coupled gate drives. The IT series provides negligible delays and the possibility of voltage scaling. They are available with single or double secondary winding for multiple gate drives. Choosing the IT product line brings you the rapid availability of a standard gate drive transformer. A wide selection on turns ratio, ignition current and voltages are designed to offer you the desired standard product.

Features and benefits

- Galvanic separation with secondary winding.
- Voltage resistance up to 4kV.
- Allows high potential difference voltage scaling.
- Vacuum potting.
- Very low partial discharge effects.
- PCB through hole mounting.
- Custom-specific versions on request.

Typical applications

- Gate drive circuit
- Power supplies
- Power converters
- Frequency converters
- Switching applications
- DC/DC converters
- Line coupling transformers in high-speed data transmission

Pulse transformer selection table

Pulse transformer	Turns ratio	Ignition current I_{ign} [A]	Voltage		Voltage time area V_{ot} [V μ s]	Rise time t_r [μ s]	Inductance		Resistance		Coupling capacitance C_k [pF]	Input/Output connections	Weight [g]
			U_{nom} [V]	U_p [kV]			L_p [mH]	L_{str} [μ H]	R_p [Ω]	R_s [Ω]			
IT 143	1:1:1	0.025	500	4	800	0.6	15	200	3	3	10	02	14
IT 242	1:1:1	0.1	500	3.2	250	0.9	2.5	75	0.75	0.75	7	02	6
IT 243	1:1:1	0.1	500	3.2	250	1	2.5	85	0.8	0.8	7	02	6
IT 213	1:1:1	0.25	380	2.5	450	0.4	6.5	20	1.4	1.4	40	02	9
IT 233	1:1:1	0.25	500	4	300	1.3	3	45	0.8	0.8	7	02	13
IT 253	1:1:1	0.25	500	3.2	160	1.3	1.1	45	0.55	0.55	6	02	6
IT 312	1:1:1	0.25	380	2.5	1200	1	21	35	2.4	2.7	30	02	24
IT 313	1:1:1	1	380	2.5	450	0.6	3	6	0.33	0.4	27	02	24
IT 249	2:1:1	0.25	500	3.2	330	4	17	140	3.1	1.5	9	02	6
IT 154	3:1:1	0.1	500	4	600	1.3	75	180	7.5	2.2	9	02	14
IT 244	3:1:1	0.1	500	3.2	200	0.7	15	70	2.8	0.9	9	02	6
IT 234	3:1:1	0.25	500	4	280	1	17	40	2	0.7	9	02	13
IT 314	3:1:1	1	380	2.5	500	1	35	20	1.6	0.7	30	02	25

Explanations:

- t_r rise time at given load resistor R and 70% of the output pulse height.
- L_p primary inductance measured at 1kHz (secondary coils open).
- L_{str} stray inductance measured at the secondary side, short circuit at the primary side. If there are several secondary coils only one at the time is connected (measuring frequency 10kHz).
- The ignition current is a set peak value where the voltage drop over the coil resistance is still insignificant (mostly below 1V).

Mechanical data

IT 213

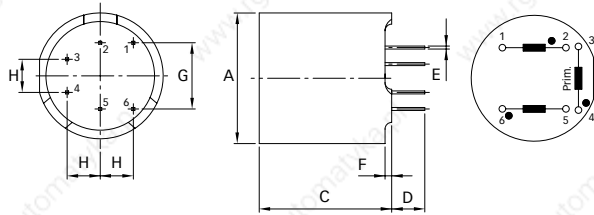

IT 243, IT 244, IT 249, IT 253

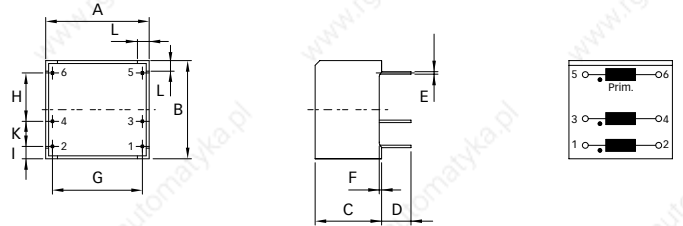

IT 242

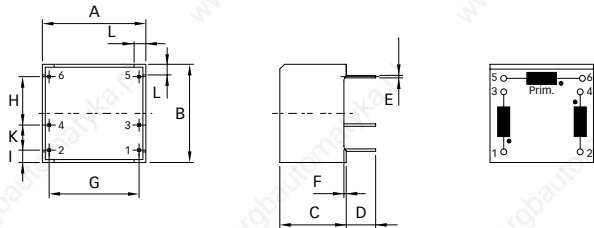

IT 143, IT 154, IT 233, IT 234

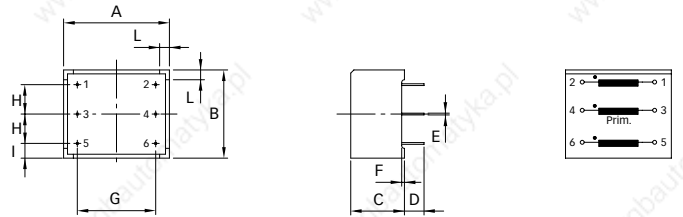

IT 312, IT 313, IT 314

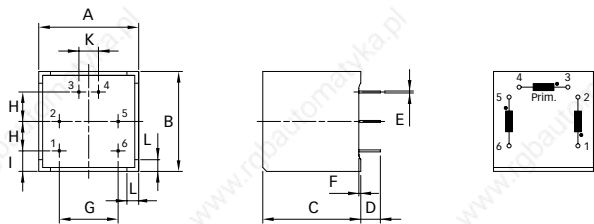

Dimensions

	IT 213	IT 243	IT 244	IT 249	IT 253	IT 242	IT 143	IT 154	IT 233	IT 234	IT 312	IT 313	IT 314	Tol.
A	Ø19	17.6	17.6	17.6	17.6	17.6	27*	27*	27*	27*	25.5*	25.5*	25.5*	±0.1
B		16.7	16.7	16.7	16.7	16.7	22.5*	22.5*	22.5*	22.5*	25.5*	25.5*	25.5*	±0.1
C	20	11.3	11.3	11.3	11.3	11.3	13.7	13.7	13.7	13.7	25*	25*	25*	±0.1
D	5	5	5	5	5	5	5	5	5	5	5	5	5	+1/-0
E	□0.45	□0.42	□0.42	□0.42	□0.42	□0.42	□0.45	□0.45	□0.45	□0.45	□0.5	□0.5	□0.5	
F	1	0.4	0.4	0.4	0.4	0.4	0.7	0.7	0.7	0.7	0.5	0.5	0.5	
G	10	15.3	15.3	15.3	15.3	15.3	20	20	20	20	15	15	15	
H	5	7.5	7.5	7.5	7.5	7.5	7.5	7.5	7.5	7.5	7.5	7.5	7.5	±0.2
I		2.1	2.1	2.1	2.1	2.1	3.75	3.75	3.75	3.75	5.25	5.25	5.25	±0.2
K		5	5	5	5	5					5	5	5	±0.2
L		2	2	2	2	2	2.5	2.5	2.5	2.5	3	3	3	

* Tolerance is ±0.2

All dimensions in mm; 1 inch = 25.4mm

Tolerances according: ISO 2768-m / EN 22768-m



2011/12

Basics in EMC and Power Quality
Introduction, Annotations, Applications

SCHAFFNER
energy efficiency and reliability



Basics in EMC and Power Quality

I	Introduction	165
1	Sources of electromagnetic signals	165
1.1	Natural and technical sources of electromagnetic signals	165
1.2	Definition of noise	165
1.2.1	Frequency ranges	165
1.2.2	Differential-mode noise	166
1.2.3	Common-mode noise	166
1.3	Noise propagation	166
1.3.1	Coupling methods	166
1.3.2	Radiation	166
2	Legal requirements	167
2.1	Global legislation	167
2.1.1	CE marking for the European Union	167
2.1.2	CCC and CQC approvals for China	168
2.1.3	FCC registrations for the USA	168
2.1.4	EMC framework in Australia/New Zealand	169
2.1.5	VCCI registrations for Japan	169
2.1.6	Other international requirements	169
2.2	EMC standards	169
2.2.1	Standard classification	170
2.2.2	Common limit lines	172
2.3	Safety approvals	172
2.3.1	EMC testing as a service	173
2.3.2	The test	173
3	EMC measurements	173
3.1	Emission	173
3.1.1	High-frequency (HF) radiated emission	173
3.1.2	High-frequency conducted emission	174
3.1.3	Discontinuous interference (clicks)	175
3.1.4	Mains harmonics	176
3.1.5	Voltage fluctuations and flicker	177
3.2	Immunity	177
3.2.1	RF immunity	177
3.2.2	Conducted immunity	178
3.2.3	Radiated immunity	179
3.2.4	Transient immunity	179
3.2.5	Electrostatic discharges (ESD)	179
3.2.6	Electrical fast transients (bursts)	180
3.2.7	Surge	181
3.2.8	Power magnetic fields	182
3.2.9	Supply network	182

4	Noise suppression	183
4.1	Conceptual EMC	183
4.2	Shielding	183
4.2.1	Shielded housings	183
4.2.2	Shielded cables	183
4.3	Grounding	184
4.3.1	Grounding concepts	184
4.3.2	Earthing	185
4.4	Suppression components	185
4.4.1	Chokes	185
4.4.2	Capacitors	186
4.4.3	Filters	187
4.4.4	Filter attenuation	188
5	Power quality	189
5.1	Definition	189
5.1.1	Frequency ranges	189
5.2	Reactors in drive systems	190
5.2.1	Need for protection	190
5.2.2	Overview of uses	190
5.2.3	Line input	190
5.3	Output solutions for motor drives	192
5.3.1	dv/dt – voltage potential jumps in relation to the time	192
5.3.2	Voltage overshoots and voltage peaks	192
5.3.3	Additional losses in the motor	193
5.3.4	Cable shields and parasitic earth currents	193
5.3.5	Bearing damage	193
5.3.6	Acoustic noise levels	194
5.3.7	Solutions for output problems	194
II	Annotations to filter specifications	196
1	Filter ratings	196
1.1	Electrical specifications	196
1.1.1	Current	196
1.1.2	Voltage	196
1.1.3	Frequency	197
1.1.4	DC resistance	197
1.1.5	Discharge resistors	197
1.1.6	MTBF	197
1.2	Mechanical specifications	197
1.2.1	Mechanical tolerances	197
1.2.2	Filter terminals and cable cross-sections	198
1.2.3	Torque specifications	199

1.3	Environmental requirements	199
1.3.1	RoHS	199
1.3.2	Vibration and bump testing	200
1.3.3	Climatic classification	200
2	Safety requirements	200
2.1	Type testing	200
2.2	Hipot testing	200
2.3	Leakage currents	201
2.4	Flammability classification	202
2.5	Fuses	202
3	Power distribution networks	203
3.1	Designation of networks	203
3.2	TN network	203
3.2.1	TN-S system	203
3.2.2	TN-C and TN-C-S systems	203
3.3	TT network	203
3.4	IT network	203
3.5	Network with one grounded phase	204
4	Installation instructions	204
4.1	Installation of filters	204
4.2	Cable connection and routing	205
4.2.1	Shield connections	205
4.2.2	Cable routing	205
4.3	EMC planning	205
III	Typical applications	206
1	Choke applications	206
2	Power supply applications.	206
3	Medical applications	207
4	Test and measurement equipment	208
5	Motor drive applications	208
6	Energy regeneration	208
7	Renewable energies	209
8	NEMP applications	211
9	TEMPEST applications	212
10	Communication equipment	212
11	Shielded rooms	212
IV	Abbreviations	214
V	Index	215

I Introduction

1 Sources of electromagnetic signals

Electromagnetic signals are the result of electrical currents and voltages. Whenever electricity is used to drive equipment, an electromagnetic signal ensues as well. These signals can be used to transmit information from one point to the next, or they can simply be a byproduct of the operation of equipment. Where the signals are unintended, we speak of electromagnetic noise. It is this noise that can cause equipment to malfunction, and manufacturers must therefore take steps to reduce the effects of noise.

In this chapter we will mainly look at the unwanted noise, but for the purpose of explanation we will sometimes also refer to intended signals. Most people are more aware of the intended signal transmission than of unintended signals.

1.1 Natural and technical sources of electromagnetic signals

To a certain extent, electromagnetic signals are natural phenomena. One of the best known phenomena is a lightning strike, which is nothing more than a huge current flowing from a cloud towards Earth. This current causes high electromagnetic fields. Other than that, we also have atmospheric radiation. These types of signals are comparably small and are generally not considered for EMC on an equipment level. More important for our purposes are the technical sources of electromagnetic signals. Electrically powered equipment, as already mentioned, is one such source. In this category we can identify two main sources of electromagnetic noise: power supplies and motor drive systems. On the other hand, we also purposely generate signals in order to transmit them over a distance, as in a TV station. With the increase of communication and especially wireless services, this element is becoming more and more important.

1.2 Definition of noise

The intended generation of signals for information transmission is not considered noise, but it does have an impact on the overall EMC of equipment. This will come up again in a later chapter. In this chapter, our focus is on unwanted noise signals and their characteristics.

1.2.1 Frequency ranges

A key characteristic of electromagnetic noise is its frequency. The EMC standards generally cover the range from 0Hz to

400GHz. Currently, however, not all frequency ranges are completely regulated.

The first important frequency range is the range around the power network frequency, which in Europe is 50Hz. Most loads connected to the power network are non-linear loads, i.e., they draw a current that does not follow the sinusoidal voltage. Non-linear loads have the characteristic of generating additional currents at multiples of the network frequency. These currents are called harmonics and are generally considered up to the 40th or 50th order. In other words, our first frequency range starts at 50Hz and ends at 2kHz or 2.5kHz. For 60Hz networks, the range goes from 60Hz to 2.4kHz or 3kHz.

From the end of the harmonics range to 9kHz, we have a frequency range that is not currently regulated. We will come back to this in the “Power quality” chapter. Above 9kHz, the high-frequency range starts. This range is also called the radio-frequency or RF range.

Radio frequency is the collective term for all frequencies from a few kilohertz to several gigahertz. EMC standards limit the frequency range to 400GHz on the upper end, although test methods for such frequencies have not been defined yet. Current standards define testing methods from 9kHz to 1GHz, and some newer versions go up to 2GHz or higher. The technical progress today is faster than the development of standards. Computers and communication equipment use fundamental frequencies that are already above 2GHz. Looking at harmonic frequencies, even a 2GHz upper limit is no longer sufficient to cover RF problems.

The RF range is generally split into a conducted and a radiated range. For the lower part of the RF range, noise is expected to travel along lines rather than radiate from the equipment. The main reason for this is that the required antenna structures are bigger for lower frequencies. In other words, the physical size of most equipment is simply not sufficient to radiate low frequency noise. While an exact frequency cannot be defined, the standards generally set the conducted RF range from 150kHz to 30MHz. Some standards also start at the lower frequency of 9kHz. The radiated range then starts at 30MHz. The upper limit of this range depends on the standard, but it will generally be about 1GHz, for some products 2 or 3GHz. To summarize, we have the following ranges:

Harmonics	LF range	Conducted RF range	Conducted RF range	Radiated RF range	Radiated RF range
50Hz - 2/2.5kHz 60Hz - 2.4/3kHz	2/2.5Hz - 9kHz 2.4/3kHz - 9kHz	9kHz - 150kHz	150kHz - 30MHz	30MHz - 1/2/3GHz *	Above 3GHz

█ Regulated range █ Regulated range for some products
█ Unregulated range * Upper limit depends on product

Definition of frequency ranges

The defined testing methods for these frequency ranges are explained in a later chapter.

1.2.2 Differential-mode noise

Looking at conducted signals, noise can occur between any two lines of the system. In a single-phase system this could be between phase (P) and neutral (N) lines. In a three-phase system it could be phase 1 (R) and phase 2 (S). In DC systems, the noise can travel from plus to minus. Such noise is called differential-mode noise or symmetrical noise. The picture below shows differential-mode noise in a single-phase system.

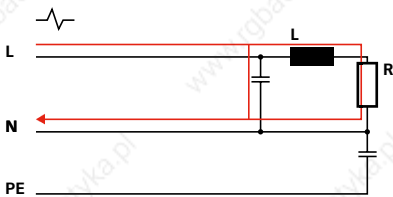

Differential-mode noise in single-phase systems

Differential-mode noise is a result of parasitic components in a circuit, such as equivalent series inductance (ESL) or equivalent series resistance (ESR) or components. In an electronic system, differential-mode noise usually occurs at lower frequencies and is commonly associated with the switching frequency of a switch-mode power supply or a motor drive.

1.2.3 Common-mode noise

Noise can also be conducted from any line in the system towards earth. In a single-phase system, signals could go from L and P towards earth. This type of noise is then called common-mode noise. The main difference is that common-mode noise travels in all lines in the same direction and then towards earth. The picture below shows common-mode signals in a single-phase system.

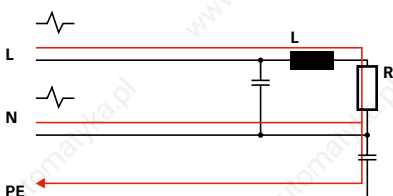

Common-mode noise in single-phase systems

Common-mode noise results from stray capacitances in a system, often occurring between semiconductors and heat sinks. It is more often found in the higher frequency range.

When we look at the measurements later, we will see that the result of the measurement does not make the differentiation between the two types of noise. For noise suppression, however, it is crucial to understand what kind of noise signal we are dealing with.

1.3 Noise propagation

Electromagnetic signals are generated in electrical and electronic systems and can then propagate inside the system or even outside. This propagation can work along lines or through radiation. These coupling paths are explained in the following paragraphs.

1.3.1 Coupling methods

Looking at the connections in an electrical or electronic system, we can identify three different coupling paths. One is galvanic coupling, which requires a direct connection between the single parts of the system. Second is capacitive coupling, which can happen when two cables of the system are routed close to each other, thus forming a parasitic capacitor. Where cable loops of different cables are laid out too close to each other, inductive coupling can occur.

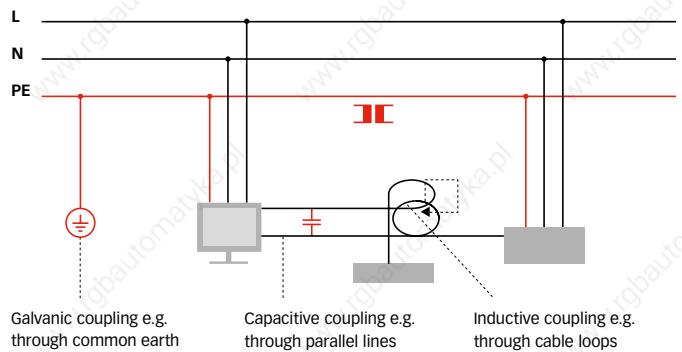

Coupling paths between systems

Galvanic coupling effects often ensue due to common ground connections. Capacitive coupling is typical for industrial applications, where power and signal lines are laid parallel over long distances.

1.3.2 Radiation

Noise can not only propagate along direct connections but also through the air via radiation. Once HF signals are generated inside a system, they are simply propagating along the path of least resistance. If the structure or layout of the system provides good antenna characteristics, the signals will use

those parasitic antennas and radiate from the system into the air. There, the noise travels as electromagnetic waves and can be picked up by other equipment along its path.

2 Legal requirements

2.1 Global legislation

Electromagnetic phenomena and their effect on electric and electronic equipment have compelled many countries to implement measures that ensure the proper operation of equipment. Originally, most requirements came from military sectors and civil aviation, where the need for flawless operation of equipment is strongly related to the safety of people. Only later, when the use of electronic components expanded into almost every aspect of our lives and wireless transmission and communication systems became increasingly important, did requirements for electromagnetic compatibility expand into other civil sectors.

Legislation in various countries produced regulations and standards with which equipment has to comply. Since legislative systems vary from country to country, the compliance schemes used in each country are also very different. Where some schemes entail strong legislation and mandatory approval rules, others rely on voluntary registration and manufacturers' responsibility.

2.1.1 CE marking for the European Union

The concept of CE marking tries to reduce the huge number of national approvals by introducing harmonized rules. These rules are written in the EU directives. The directives as such are not legally binding to manufacturers, but all member countries are obliged to convert any approved directive into national law within a given period of time. Any failure to do so is a direct violation of European law, and the member state doing so will be punished.

The CE marking in this context is the mark of the manufacturer, indicating that the product is in compliance with all applicable directives. In addition to the CE marking, the manufacturer has to prepare a declaration of conformity stating that the described product is in compliance with the directives.



CE mark

This was meant to make trading easier for manufacturers, since they do not have to go through the ordeal of national approvals for each country. This requires, however, that manufacturers know which directives exist, are approved and apply to each of their products. The EU does not offer comprehensive information on this topic. For this reason, the European system is very often regarded as difficult and prohibitive.

As mentioned before, the rules are defined in the European directives, which are then converted into national laws. As one example, the EMC directive with the title 89/336/EU was converted into law in each member state, such as the German EMC Act from November 1992. Each directive also defines the conformity procedures that can be used to show compliance with the directive. The directives contain the technical contents to be harmonized. They do not contain any guidelines about implementation and fining systems. As a result, non-compliant equipment can lead to a fine in one country but imprisonment in another.

The EU has produced a number of basic directives, such as the CE marking directive, with the purpose of defining procedures applicable to many other directives. One directive defines all existing conformity procedures. However, not all of these procedures can be used for all directives.

Typical conformity routes are modules A (self-declaration), B (competent body) and H (notified body). Other conformity routes would be type approvals in connection with a certified quality system (medical directive).

The scope of the EMC directive is very general. All products likely to emit or be susceptible to electromagnetic energy are covered. To show compliance with the directive, products must not emit EM energy in an amount sufficient to affect other equipment. At the same time, each piece of equipment must be sufficiently immune against EM energy from other sources.

This leaves a lot of room for interpretation and speculation, and the EU soon released an unofficial document providing guidance on the EMC directive. A new version of the EMC directive is also forthcoming to further clarify the gray areas of the initial directive.

However complicated the EMC directive may seem, it still covers its main purpose. It removes the necessity to test to various national standards and guarantees acceptance in all EU member states.

The conformity routes permitted by the EMC directive are self-declaration, competent body route and EC-type approval by a notified body. This is due to change in the new directive, however, where the institution of a competent body is completely removed and only notified bodies remain. The

self-declaration route is a way for manufacturers to take care of their approvals without involving any third parties. For the EMC directive, conformity can be assumed if the product is in compliance with existing harmonized EMC standards. We will explain the system of harmonizing standards in a later chapter. The manufacturer can therefore test its product against these standards and then declare the conformity.

Where harmonized standards do not exist or testing is uneconomical, the manufacturer has the option of involving a competent body. The manufacturer prepares a technical construction file (TCF), which should contain all EMC-relevant information, including testing data. The TCF is then checked by the competent body, and if the EMC concept is clear and acceptable, the competent body will issue a certificate.

For radio transmitting devices (for example, radio telephones), the involvement of a notified body is mandatory. The manufacturer has to submit documents and one sample to the notified body for testing and approval.

As mentioned before, the situation with competent and notified bodies will change in the future. The new directive no longer contains the competent body approval route. The notified body will assume the tasks of the competent body. However, the involvement of notified bodies is no longer mandatory, even if harmonized standards are not used. Approvals of radio transmitting devices are no longer in the scope of the EMC directive, having been handled for some time now by the telecom directive. The changes from this new EMC directive will come into effect on July 20, 2007, with an additional two-year transition period.

2.1.2 CCC and CQC approvals for China

CQC develops voluntary product certification services called CQC Mark Certification for products that fall outside the compulsory certification catalog. The aim is to protect consumers and property, safeguard consumer rights and interests, improve the product quality of domestic enterprises, increase product competitiveness in the international market and facilitate the access of foreign products to the domestic market. CQC, as the body that earlier conducted quality certification activities and a high authoritative body in China, is a brand well known in the world. This, in turn, can greatly enhance the brand image of the enterprises it certifies.

In December 2001, the State General Administration of Quality Supervision, Inspection and Quarantine of the People's Republic of China issued the regulations for compulsory product certification. The Compulsory Product Certification System began to replace the original Quality License System for Commodity Inspection and Safety Certification System for Electrical Equipment. The abbrevi-

ation of the China Compulsory Product Certification is CCC or 3C. It is the statutory compulsory safety certification system and the basic approach to safeguarding consumer rights and interests and protecting personal and property safety adopted widely by international organizations.

China Compulsory Certification System came into force on May 1, 2002. In accordance with the joint announcement no. 38 [2003] by the State General Administration for Quality Supervision and Inspection and Quarantine of the People's Republic of China and the Certification and Accreditation Administration of the People's Republic of China, the date for implementing the supervision and management of the market for compulsory product certification was set as August 1, 2005.

The compulsory product certification requirements cover 135 products divided into 20 categories, including household appliances, motor vehicles, motorcycles, safety goggles, medical devices, lighting apparatuses, cables and wires. CQC has been appointed to undertake the work of compulsory product certification for 17 categories within the CCC catalog.

2.1.3 FCC registrations for the USA

Approvals for the American market are usually related to the Federal Communications Commission (FCC). The FCC is an independent United States government agency, directly responsible to Congress. The FCC was established by the Communications Act of 1934 and is charged with regulating interstate and international communications by radio, television, wire, satellite and cable. The FCC's jurisdiction covers the 50 states, the District of Columbia, and U.S. possessions. The most commonly referred to regulation is part 15, which covers all commercial products. Like the European standards, the FCC rules define environments for residential and industrial areas.

Equipment used in residential areas requires verification and certification. The equipment has to be tested in a test site and by testing personnel listed by FCC.

In recent amendments to the rules, FCC now enables manufacturers to use the same testing methods as laid out in CISPR 22, with only minor additional rules. Other commonly used rules of the FCC are the parts 18 for industrial equipment and 68 for telecommunication equipment.

Approvals according to FCC regulations are straightforward for manufacturers. However, the approval can only be used for the American market. Manufacturers who wish to sell the same product in Canada, Mexico or even the European market must go through completely different approval procedures.

2.1.4 EMC framework in Australia/New Zealand

One of the newer EMC schemes is the EMC Framework covering Australia and New Zealand. The Framework takes a very similar approach to Europe, giving manufacturers more responsibility in the marketing of their products. The EMC Framework came into effect on January 1, 1997. It covers all electric and electronic products to be sold on the Australian and New Zealand markets.

The authority for all related matters is the Australian Communication Authority (ACA). As in the U.S. model, the main goal of the EMC Framework is the protection of essential radio and broadcast services and the minimization of electromagnetic interference. For this reason, immunity testing is required only for radio and broadcast equipment. For all other equipment, only emission requirements apply. In addition, the Framework only applies to commercial, residential and light industrial environments.

As in Europe, the EMC Framework defines different compliance routes. The manufacturer can choose the self-declaration route or the involvement of a competent body. Accredited testing is required only when the competent body is involved. In all other cases, it is recommended but not mandatory. All standards for Australia are produced by Standards Australia, but as mentioned previously, they are based on international or European standards.

The ACA introduced the C-tick mark as its conformity mark. Like the CE marking, the C-tick mark shows compliance with regulations – in this case, the relevant EMC standards. However, there are two preconditions for a manufacturer to use this mark. First, the manufacturer must be represented in Australia. This can be through a branch office or an authorized representative. Second, the manufacturer has to register with the ACA, but only for the initial use of the C-tick mark.



C-tick mark

Like in Europe, market access can be very easy for well-informed manufacturers. Third-party approvals are not generally required and manufacturers can market their products on their own responsibility.

2.1.5 VCCI registrations for Japan

The Japanese scheme is quite different. In 1985 four organizations – the Japan Electronic Industry Development Association, the Japan Business Machine Makers Association, the Electronic Industries Association of Japan, and the Communications Industry Association of Japan – jointly established the Voluntary Control Council for Interference by Information Technology Equipment and Electronic Office Machines (VCCI) to cope with radio interference problems arising from personal computers, word processors, facsimile terminals and other similar electronic equipment. The system is completely voluntary, but strongly supported in Japan. Selling equipment without VCCI registration and the VCCI mark is legally possible, but the product will fail from a marketing point of view.



VCCI mark

As the name of the VCCI already says, the scheme currently applies only to ITE (information technology equipment). The implemented standard requires the same limits as CISPR 22. The classes A and B from the CISPR publication are transferred to classes 1 and 2, respectively.

One drawback of the scheme is that only members can register products and display the VCCI label. In other words, manufacturers who wish to register their products with VCCI must first become members.

2.1.6 Other international requirements

A worldwide movement is in progress to implement compliance schemes for product safety and EMC. Argentina and Taiwan are among the most recent countries to join this trend, and many others are following. In both fields, there is a clear tendency towards international standards. However, most countries still require approvals and certifications that can only be issued by governmental organization or accredited institutions.

2.2 EMC standards

In the past, most countries had their own regulations and standards governing electromagnetic interference (EMI) or radio frequency interference (RFI). Then, on January 1, 1992, the European Directive 89/336/EEC on electromagnetic compatibility (EMC) came into force. This directive brings a common approach to EMC to every member state

of the European Union. Common standards will be used throughout Europe to ensure that technical trade barriers are removed. As well as controlling EMI emissions from equipment, the directive also calls for equipment to be immune to external electromagnetic disturbances.

The task of elaborating the standards to be used has been assigned the European organization called CENELEC. Most of the European standards will be based upon international standards from CISPR and IEC. The numbering system used in the European standards is:

EN xxyyy. EN = European Norm. xx = 50 denotes that the standard is a standard of CENELEC origin. yyy is just a continuous number. The EMC product standard for machine tools, EN 50370, is one such example. If xx = 55, the standard is based on a CISPR standard yyy. CISPR 13 therefore becomes EN 55013. Standards based on an IEC standard yyy are indicated with xx = 60. The numbering for these standards is harmonized between IEC and CENELEC, and as a result, these standards are often described like IEC/EN 61800-3, which would be the EMC product family standard for power drive systems.

Once the European standard is complete, the individual members of the European Union will create national harmonized standards, usually assigning their harmonized standard a national number. For example, the British harmonized standard of EN 55011 is BS EN 55011.

2.2.1 Standard classification

The standards in the international system are divided into three different categories.

Basic standards describe the general and fundamental rules for meeting the requirements. Terminology, phenomena, compatibility levels, measurement, test techniques and classification of EM environments are so described within. The EN 61000-4-x series of standards are the best known examples for basic standards.

Generic standards refer to specific environments. They set minimal EMI levels that equipment in these environments must meet. Where no product-specific standards exist, the generic standards are to be used. Generic standards describe household and industrial EMI environments. Examples of generic standards are EN 61000-6-1/2/3/4.

Products standards are for specific products or product groups. These standards are coordinated with the generic standards.

Product standards always take precedence over generic standards. If a product or product family standard exists for a certain product, the manufacturer must use this standard. Only in the absence of a product standard can the manufacturer use generic standards.

Overview of common product-related standards (excerpt)

Product type	Emission	Immunity
Household appliances and portable tools	EN 55014-1	EN 55014-2
Vacuum cleaners	EN 61000-3-2	
Laundry machines	EN 61000-3-3	
Heating		
Cooking equipment		
Luminaries	EN 55015	EN 61547
Discharge lamps	EN 61000-3-2	
Fluorescent lamps	EN 61000-3-3	
Home electronics	EN 55013	EN 55020
Amplifiers	EN 61000-3-2	
Audio players	EN 61000-3-3	
Radio, TV receivers and decoders		
IT equipment	EN 55022	EN 55024
Computers	EN 61000-3-2	
PC periphery equipment	EN 61000-3-3	
Copy machines		
Equipment for data & voice transmission on low voltage networks (3 to 148.5kHz)	EN 50065-1	EN 61000-6-1/-2
Power line communication		
Power supplies with DC output	EN 61204-3	EN 61204-3
Switch mode power supplies	EN 61000-3-2	
DC/DC power converters	EN 61000-3-3	
Uninterruptible power supplies	EN 50091-2	EN 50091-2
	EN 61000-3-2	
	EN 61000-3-3	
Motor speed control equipment	EN 61800-3	EN 61800-3
Frequency inverters		
Current converters		
Servo drives		
Electrical medical devices	EN 60601-1-2	EN 60601-1-2
X-ray equipment		
CAT-scanners		
Machine tools	EN 61000-6-4	EN 50370-2
Lathing machines	(to be replaced by EN 50370-1)	
Grinding machines		
CNC centers		
Scientific equipment	EN 55011	EN 61000-6-1
Measurement equipment		EN 61000-6-2
Laboratory equipment		
Generic standards (if no product standards applicable)	Emission	Immunity
Residential, office and light industrial environment	EN 61000-6-3	EN 61000-6-1
Industrial environment	EN 61000-6-4	EN 61000-6-2

2.2.2 Common limit lines

The various standards set down limits for conducted and radiated EMI emission. These limits are defined in dB μ V for the conducted voltage and dB μ V/m for the radiated field strength. The reference values are 1 μ V for 0dB μ V and 1 μ V/m for 0dB μ V/m.

Typically, limit lines are defined separately for residential areas and industrial areas. These two areas are represented by two classes of limits: class A represents the industrial environment; class B defines the limits for residential areas. While a number of different limit lines exist for the various standards, the class A and B limits of EN 55011 and EN 55022 have become the reference limits for most standards.

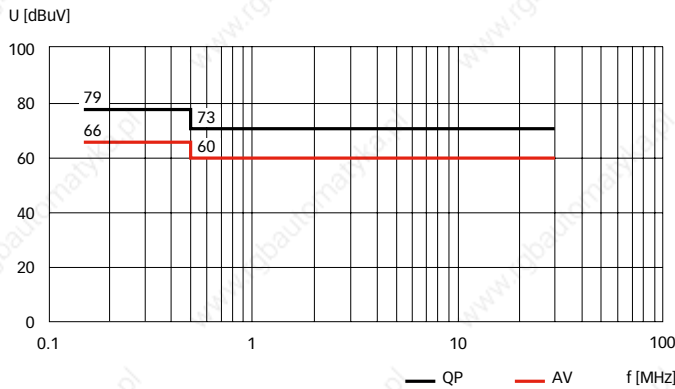

Limits for line conducted voltage class A (EN 55011/22)

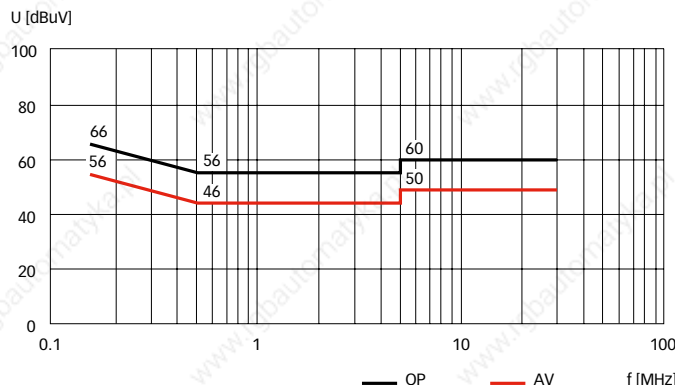

Limits for line conducted voltage class B (EN 55011/22)

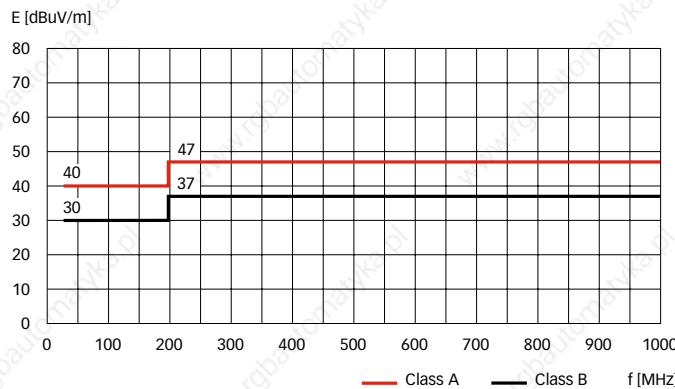

Limits for radiated field strength classes A and B (EN 55011/22)

The respective measurement methods for conducted and radiated emission measurements are described in a later chapter.

2.3 Safety approvals

The UL mark stands for “listed” and identifies units whose use for the generally accepted applications in the relevant field is not restricted. Here at Schaffner, we feature the UL mark on medical and safety facility filters and power quality products.



The mirror image “RU” stands for “recognized” and identifies tested products or components that are subsequently used in UL-certified end products, machines or systems. A good share of our standard and customized components such as chokes and filters bear this label.



Recognized component mark for Canada and the United States.

This UL Recognized Component mark, which became effective in April 1998, may be used on components certified by UL to both Canadian and U.S. requirements. Although UL had not originally planned to introduce a combined Recognized Component mark, the popularity of the Canada/ U.S. Listing and Classification marks among clients with UL certifications for both Canada and the United States led to this mark.



The ENEC mark for lighting components, IT equipment, transformers, equipment switches, control units, clamping devices and connector plugs, capacitors and RFI suppression components documents the uniform Europe-wide certification in the ENEC procedure according to EN standards.



A CSA mark on its own, without indicators, means that the product is certified primarily for the Canadian market for the applicable Canadian standards. If a product has features from more than one area (such as electrical equipment with

fuel-burning features), the mark indicates compliance with all applicable standards.



China Quality Certification Center (CQC). CQC develops voluntary product certification services called CQC Mark Certification for products not subject to compulsory certification. The objective is to protect consumers, ensure the safety of persons and property, safeguard the rights and interests of users, improve the product quality and international competitiveness of Chinese enterprises, and facilitate the import of foreign products to China.



2.3.1 EMC testing as a service

The fully equipped Schaffner EMC testing laboratory with its trained personnel is dedicated primarily to testing and measuring our own products. However, we also provide EMC testing as a service. Schaffner is ISO 9001:2000-certified and the test center is ISO/IEC 17025-accredited. The scope of services even encompasses mobile testing vehicles.

These mobile EMC labs make it possible to conduct testing and interpret the results right at the customer's site.

2.3.2 The test

Prototypes are subject to the most stringent standards. In the EMC laboratory, for example, prototypes are checked for electromagnetic compatibility. In the test center, their surge and short-circuit protection is checked, while continuous load testing is used to gauge their reliability. Environmental compatibility begins with the selection and testing of materials, the use of environmentally friendly manufacturing processing and compliance with the latest standards worldwide.

3 EMC measurements

3.1 Emission

Emission is every electromagnetic disturbance that is produced by the equipment under test (EUT) and given off to the environment. If we look at a portable telephone with a base station, for example, the telephone emits the communication signal and the base station receives it. This kind of emission is intended and necessary for the correct operation

of the equipment. Every government has the task of controlling these intended emissions by controlling the frequencies of operation and requiring special approvals.

However, most electric and electronic equipment also produces a lot of unintended emission that is not necessary for the operation – that is, emission as a kind of waste product. To guarantee the proper operation of other equipment in the vicinity, this unintended emission must be limited. This unintended emission can be spread over a vast frequency range, starting from the power network frequency (50Hz for Europe) up to several GHz (gigahertz = 1 billion cycles per second).

Signals can generally be transmitted through air or along cables, resulting in radiated and conducted emission.

3.1.1 High-frequency (HF) radiated emission

While there is no fixed definition as to where high frequency starts, EMC authorities typically consider everything from a few kHz (kilohertz = 1000 cycles per second) upwards to be HF. In the EMC field, the term radio frequency (RF) is often used instead of HF.

Air-transmitted interference, called radiated emission, can be measured with a receiving antenna on a proper test site. The following picture shows a sample setup.

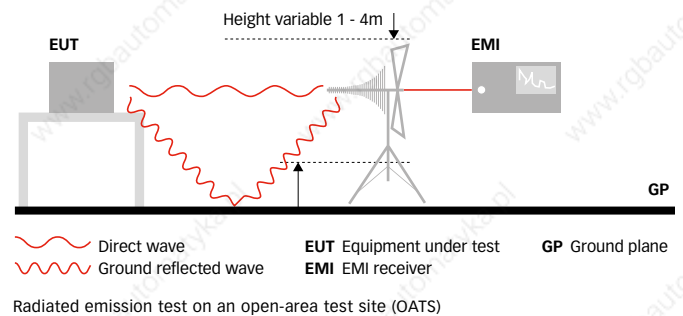

The classic radiated measurement according to common standards is performed on an open area test site (OATS). The minimum ground plane area as given in CISPR 22 should be regarded as indicative only; the true measure of an OATS is its calibrated normalized site attenuation (NSA), and meeting this will normally require a larger ground plane area. Maintaining a large area free of obstructions (including wooden buildings) is also important.

The ground plane is necessary to regularize reflections from the ground surface, and the antenna height scan deals with the nulls that inevitably result from the presence of the ground plane. The height scan is not intended to measure emission from the EUT in the vertical direction. Only the

horizontal plane of emission as given by the azimuth rotation of the EUT is tested.

Any open area test site is likely to suffer from ambient signals, that is, signals that are generated in the neighborhood and received on the site but not emitted from the EUT. These signals can easily exceed both the emission of the EUT and the limit values at many frequencies. An emission plot which contains ambients is hard to interpret, and more importantly, ambients that mask EUT emission make it impossible to measure the EUT at these frequencies. There is no foolproof method whereby ambient signals can be subtracted from an emission measurement.

Other problems of OATS can be unwanted reflections from objects that are not within the defined borders but that nonetheless can reflect the EUT signal back to the antenna. It should also be noted that objects that do not appear to be reflecting normally can begin doing so under certain circumstances. A tree would surely not be suspected of reflecting electromagnetic waves, but if it is wet after a rain shower, it definitely would.

In order to avoid problems with the OATS, alternative testing methods are under investigation. The first one that was also approved by EMC standards was the anechoic chamber. The outer hull is an RF-tight shielded chamber that keeps out the ambient signals. Measurement in such a chamber would be impossible, however, since the reflections inside cannot be controlled and the measurement result could not be compared to OATS measurements.

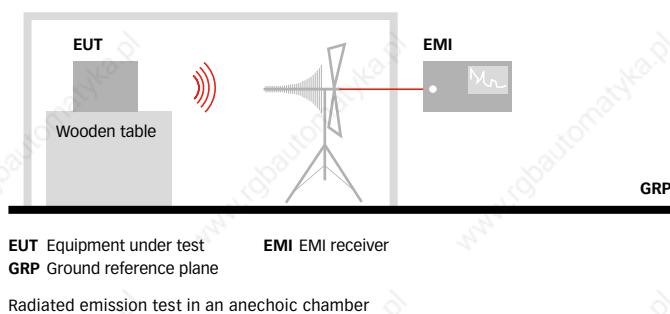

In order to prevent reflections, the walls of the chamber are lined with absorbing material. Modern chambers achieve this through a combination of ferrite material, usually in the form of tiles glued directly to the wall, and cone-shaped foam absorbers on top of the tiles. The tiles work excellently in the lower frequency range, but their performance deteriorates with increasing frequencies. Foam cones work well in any frequency range, but their size is directly related to the wavelength, so at low frequencies, cones must be very long

to be effective, meaning that the shielded chamber must also be much bigger. The combination of cones and tiles has proven practical and economical.

3.1.2 High-frequency conducted emission

Conducted emission is any emission transported from equipment to the environment along cables. The main emphasis in measuring line-conducted emission is placed on the AC mains input of the EUT, though other interface ports are becoming more and more important, like telecom and network ports on information technology equipment.

In order to measure conducted emission, a line impedance stabilization network (LISN) is inserted into the mains power supply of the EUT. Newer standards call this network artificial mains network (AMN). The LISN leads the RF signals from the EUT to the output for the measurement receiver, while at the same time blocking the AC input voltage from the receiver. According to the standard, the highest emission on each of the phases has to be recorded, but in common practice a peak measurement is performed on one phase, and only if the measured emission is within a defined margin from the limit will the testing be performed with average (AV) and quasi-peak (QP) detectors on all phases.

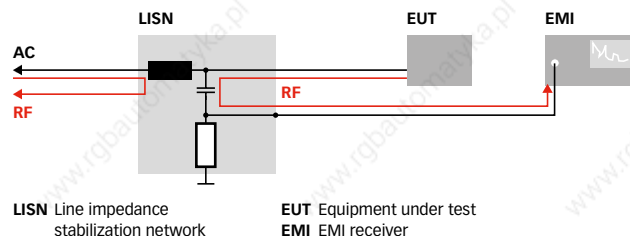

Measurement principle for line-conducted voltage measurements

The CISPR quasi-peak and average detectors weigh the indicated value according to its pulse repetition frequency (PRF). Continuous interference is unaffected; the indicated level of pulsed interference is reduced by a defined degree based on the time constants and bandwidths defined in CISPR 16. A receiver is calibrated using pulses of a defined impulse area, spectral density and repetition rate.

It is normal practice to perform initial emissions testing with the peak detector. Provided that the receiver dwells on each frequency for long enough to capture the maximum emission – this depends on the EUT's emission cycle time – the peak detector will always give the maximum output level. A list of frequencies at which high emissions are detected is created, and these frequencies are revisited individually with the quasi-peak (and average, for conducted emissions) detectors, which will give the reading to be compared against the limit.

The ground reference plane (GRP) is an essential part of the conducted emission test. A proper measurement is impossible without a GRP. Even a Class II EUT without safety earth connection must be tested over a GRP, since it provides a return path for stray capacitance from the EUT. The GRP should be:

- at least 2m x 2m, and at least 0.5m larger than the boundary of the EUT;
- made of copper, aluminum or steel, though the thickness is not too important;
- bonded to the local supply safety earth (this is for safety only and not necessary for the measurement);
- bonded by a very short, low-inductive strap to the reference terminal of the AMN/LISN. A length of wire is not adequate for repeatability at the higher frequencies. The AMN/LISN should preferably be bolted directly to the GRP.

For table-top apparatuses, different standards allow the GRP to be either vertical or horizontal, but all require the closest face of the EUT to be maintained at a distance of 40cm from the GRP and at least 80cm from all other conductive surfaces. This is typically achieved with a wooden table either 40cm high off a conducting floor used as the GRP or 80cm high and 40cm away from a conducting wall used as the GRP. Floor-standing EUTs should be placed on a conducting floor used as the GRP but not in electrical contact with it. The distance between the boundary of the EUT and the closest surface of the AMN/LISN must be 80cm. The mains lead from the EUT to the AMN/LISN should preferably be 1m long and raised at least 10cm from the GRP for the whole of its length. Longer mains leads may be bundled non-inductively, but this introduces considerable variations into the results, and it is preferable to shorten them to the standard length. Alternatively, provide a standard wooden jig such that the bundling can be done in a repeatable manner. The following picture shows the setup as defined in the measurement standard.

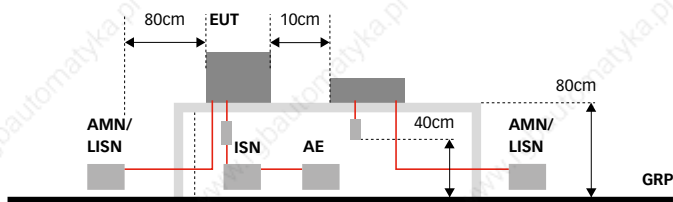

AMN/LISN 40cm from GRP edge on all sides	Wooden table	EUT	Equipment under test
		AMN/LISN	Artificial mains network/Line impedance stabilisation network
		ISN	Impedance stabilization network
		AE	Auxiliary equipment
		GRP	Ground reference plane

Standard compliant setup for conducted emission measurements

Mains-powered peripherals that are necessary for the operations of the EUT but not themselves under test should be powered from a separate artificial mains network (AMN) or LISN. Other connected leads should be terminated in their normal loads but not extend closer than 40cm from the GRP. The measurement should be well decoupled from any external disturbances. These can be coupled into the setup either via the mains supply or by direct coupling to the leads. Although the AMN/LISN will reduce both the noise on the mains supply and variations in the supply impedance, it does not do this perfectly, and a permanently installed RF filter at the mains supply to the test environment is advisable. Ambient radiated signals should also be attenuated, and it is usual to perform the measurements inside a screened room, with the walls and floor of the room forming the ground reference plane. However, a fully screened room is not essential if ambient signals are at a low enough level to be tolerated.

3.1.3 Discontinuous interference (clicks)

Domestic appliances, power tools and certain other products need to be measured for discontinuous interference in the frequency range of 150kHz to 50MHz. Because the interference generated by such products is not periodic, the limits are relaxed compared to continuous limits.

The relevant standard was designed to allow products' interference levels to be suppressed according to annoyance levels. Hence, emissions must be measured for their amplitude, duration and repetition rate, to determine whether the interference is discontinuous – a “click” – or continuous, as defined in the standard.

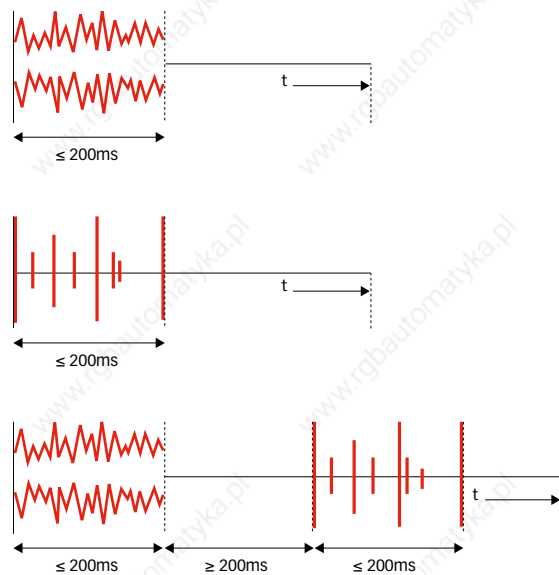

Definition of clicks

Once the discontinuous interference has been quantified, corrected limits can be applied. Such a process is complex, difficult and prone to errors if measurements are made manually. For accurate and repeatable results, automated analysis is necessary.

3.1.4 Mains harmonics

In general the public mains power supply voltage waveform is sinusoidal, which means that it includes only the fundamental frequency (50 or 60Hz) without any harmonic multiples of this frequency. Purely resistive circuits such as filament lamps or heaters, when powered from the mains, draw a current that is directly proportional to the applied voltage, and do not create any extra harmonic components. By contrast, non-linear circuits do draw a non-sinusoidal current, despite the applied voltage being sinusoidal. All non-linear currents, however, will cause harmonics currents, i.e., currents with frequencies that are integer multiples of the supply frequency.

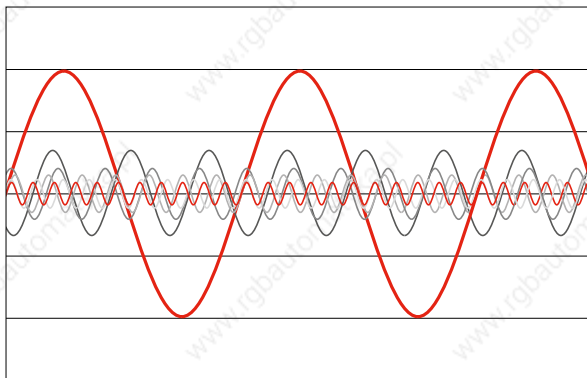

Mains current with harmonics

Traditionally, harmonic pollution was only a concern for larger installations, particularly for power generation and distribution and heavy industry. But the modern proliferation of small electronic devices, each drawing perhaps only a few tens or hundreds of watts of mains power, and usually single-phase (such as personal computers), has brought the problem of mains harmonics to the fore even in domestic and commercial applications. Of all the above examples, it is the electronic DC power supplies that are causing the most concern due to the increasing numbers of electronic devices such as TV sets in domestic premises, information technology equipment in commercial buildings and adjustable-speed drives in industry.

The difficulties caused by harmonic pollution can be divided into two categories: those caused by the harmonic currents themselves and those caused by voltage waveform distortion resulting from the harmonic currents flowing in a finite sup-

ply source impedance.

The principal problem with the harmonic currents is that they can cause overheating in the local supply distribution transformer if it is inadequately rated, or if it is rated on the assumption of low harmonic levels. Power factor correction capacitors can overheat as well, due to the much higher harmonic currents they experience because of their lower impedance at higher frequencies, leading to failure. Harmonic currents in the neutral conductors of three-phase supplies present reliability and safety risks, where neutral conductors have not been suitably dimensioned. Many modern installations use neutral conductors of the same cross-sectional area as their associated phase conductors, and some (usually older) buildings are known to use half-size or smaller neutral conductors. Unfortunately, emission of “triplen” harmonics (multiples of 3: 3, 6, 9, 12, etc.) add constructively in neutral conductors and can reach 1.7 times the phase current in some installations. Overheating of conductors is aggravated by the skin effect, which tends to concentrate higher frequency currents towards the outside of the conductor, so that they experience greater resistance and create more heating effect. A further result of harmonic currents, especially when they leak into the earth network, is increased magnetic interference with sensitive systems operating in the audio band, such as induction loop installations.

The non-sinusoidal current drawn from the supply causes distortion of the supply voltage, since the inductance of the supply increases the source impedance as the harmonic order rises. This waveform distortion can cause serious effects in direct-on-line induction motors, ranging from a minor increase in internal temperature through excessive noise and vibration to actual damage. Electronic power supplies may fail to regulate adequately; increased earth leakage current through EMI filter capacitors due to their lower reactance at the harmonic frequencies can also be expected. System resonance effects at the harmonic frequencies can create areas of the power distribution network where the voltage is more heavily distorted than elsewhere and/or has significant over- or under-voltage. Also, some areas of the network can suffer from much higher levels of current than elsewhere, at a few harmonic frequencies.

Common standards for harmonics are the IEC/EN 61000-3-2 and the U.S. standard IEEE 519. IEC/EN 61000-3-2 bases its requirements on an equipment level, i.e., the standard defines limit values for harmonic currents that must be fulfilled by each individual piece of equipment. The IEEE 519 looks at harmonics from an installation point of view. Rather than looking at equipment, this standard measures harmon-

ics at the point of common coupling, i.e., where equipment of one installation starts to interact with equipment from a second installation.

3.1.5 Voltage fluctuations and flicker

When loads are being switched on and off constantly, the voltage supply will experience fluctuations and changes that cannot be compensated fast enough. Although not directly influencing other equipment, such fluctuations can become an annoyance if electric light connected to the same supply unit changes varies to the fluctuations. The subjective impression of such light changes are called flicker and represent varying brightness or intensity. Above a certain level, flicker can be disturbing or even harmful to one's health. To avoid such problems, the voltage changes resulting from any equipment need to be restricted, or equipment needs to be installed such that voltage changes from the equipment cannot lead to flicker.

Flicker is a result of voltage fluctuations. It is therefore natural that all equipment with timers and thermostats, which cause frequent changes of the load, will also cause voltage changes and fluctuations. Examples of such equipment are copy machines, laser printers, heaters, air conditioners and similar appliances.

3.2 Immunity

A product manufacturer is unlikely to know or have control over the actual location of use of its products, and products should be expected to work correctly in any environment that they are reasonably likely to encounter. While it is a requirement of the EMC and R&TTE Directives that any product placed on the market or taken into service should have adequate immunity, any manufacturer who is concerned about the quality of its products will take steps to ensure this, irrespective of the legislation, since the issue is a straightforward one of fitness for purpose.

3.2.1 RF immunity

In order to test equipment for its immunity against RF signals, a defined signal needs to be generated and coupled into the EUT. Due to the nature of the signals and their means of transmission, various transducers are defined by the relevant standards for various testing methods.

The base signal for all RF immunity tests is a sine wave signal, which is then modulated in different ways and applied to the EUT. The range for testing spans from 0.15 to 1000MHz, with a rising trend for the upper limit. A signal generator must therefore be able to generate signals over

that frequency range. Since the power output of generators is usually limited and the outgoing signal is not high enough to cover the requirements of the testing standards, additional amplifiers are used. The amplifiers must also cover the whole frequency range, but since the power requirements change with the frequency, most testing systems utilize two amplifiers, a higher power version for the lower frequency range and a lower power version for the upper one.

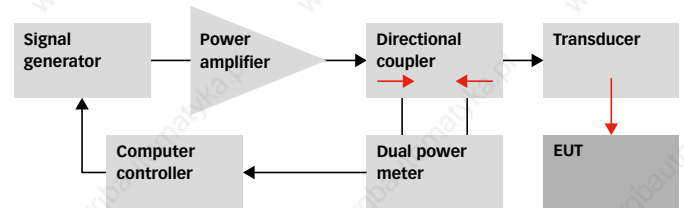

Testing principle for RF immunity

The EUT may be susceptible to modulated but not unmodulated RF. Signal circuits will detect the RF signal and respond to its amplitude; an unmodulated carrier may cause a non-critical DC shift in AC coupled circuits, whereas detected modulation can be within the signal bandwidth. The EUT can also be immune to a high level of RF but unexpectedly susceptible at a lower level. Most standards mandate the use of amplitude modulated (AM) signals. Using frequency modulated (FM) signals does not generally produce any additional susceptibilities except in special cases. For AM, a 1kHz sine wave is normally used, with some product-specific exceptions. These standards refer the specified level of the unmodulated signal, which is then modulated at 80% depth. This increases the peak applied signal by over 5dB. By contrast, some automotive RF immunity standards refer the test level to the peak value after modulation. An alternative modulation technique is pulse modulation, in which the signal is effectively switched on and off. This has been used for emulating GSM signals at 900MHz, where a 200Hz pulse modulation is specified. No increase in the overall peak level is caused by this technique.

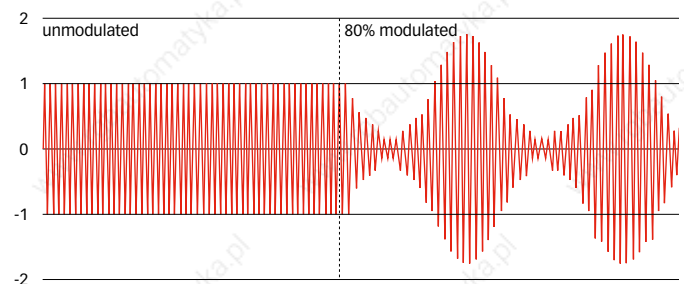

80% modulation gives 1.8 times peak level of unmodulated signal

AM modulation of RF signals

The application of an interference signal to the EUT is an important part, but it covers only the first half of the test. As important as the signal generation is the evaluation of the behavior of the EUT. Only if the EUT functions within normal operation parameters during the whole test can it be considered as having fulfilled the requirements.

There are a number of ways to observe the behavior of the EUT during testing, and some product standards are actually very detailed about the monitoring method. For equipment involving audio functions, measurement methods are often used to monitor correct performance. Systems involving data transmission and digital signal processing can often be evaluated with network analyzers or similar analysis tools.

Equipment with defined, tangible output is often evaluated after the test by investigating the output material. The most common method, though, is simple observation of the EUT and its functions with a video camera. This camera needs to be immune to the interference in the chamber and needs to be constructed in a way, that the field is not distorted. Usually, such cameras are built into boxes covered with ferrite tiles.

Where product standards do not clearly define the intended operation of the EUT during testing, the manufacturer can refer to the general performance criterion as laid out in many basic standards as well as the generic EN EMC standards, which states that:

“The equipment shall continue to operate as intended without operator intervention. No degradation of performance or loss of function is allowed below a performance level specified by the manufacturer when the equipment is used as intended.

The performance level may be replaced by a permissible loss of performance. If the minimum performance level or the permissible performance loss is not specified by the manufacturer, then either of these may be derived from the product description and documentation, and by what the user may reasonably expect from the equipment if used as intended.” Care should be taken that performance criteria are clearly defined before the testing is started. Once the testing starts and the equipment fails, performance criteria should not be softened to make the EUT pass, because this would only mean that the criteria were not well defined in the first place.

3.2.2 Conducted immunity

At frequencies up to the point at which the EUT dimensions approach a quarter wavelength, the major coupling route into the EUT is via interference injected in common mode on the connected cables. Cable testing is therefore an important method for checking RF susceptibil-

ity, and IEC/EN 61000-4-6 specifies the test methods. Any method of cable RF injection testing should require that the common-mode impedance at the end of the cable remote from the EUT be defined. Each type of cable should have a common-mode decoupling network at its far end to ensure this impedance with respect to the ground reference plane (GRP) and to isolate any ancillary equipment from the effects of the RF current on the cable. For equipment to be used and tested in a system where the cable lengths and terminations at either end are controlled, these terminations provide the appropriate common-mode impedance. Otherwise, where the far end termination is unspecified, a nominal impedance of 150 ohms will represent the average of most installation conditions, which can vary between a few ohms and a few hundred ohms over the test frequency range of 150kHz up to 80MHz. If ancillary equipment (AE) is not isolated from the signal by a decoupling network or filter, then it must be able to withstand the applied RF without affecting the system performance.

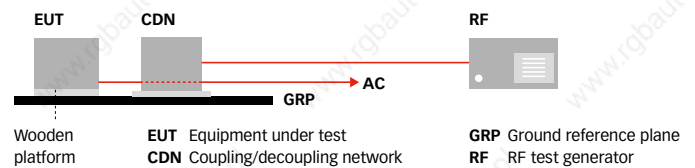

Testing principle for conducted immunity

The most straightforward method of coupling is by a capacitive connection to the cable under test. The disturbance signal is split via a coupling network to each of the conductors in the cable, so that the disturbance appears in common mode on all conductors together.

In addition to a coupling network, a decoupling network is required to prevent the signals applied to the EUT from affecting other devices or being fed into the mains power supply. The combination of a series resistance of 100 ohms and the amplifier output impedance of 50 ohms establishes a common-mode RF impedance at the EUT port of 150 ohms. The coupling and decoupling networks are normally combined into one box to form a so-called coupling/decoupling network (CDN).

A useful alternative to the CDN for RF injection is the EM clamp. This device consists of a tube of split ferrite rings of two different grades that can be clamped over the cable to be tested and is therefore non-invasive and applicable to any cable type.

The signal is fed in via a single-turn loop extending the entire length of the clamp and terminating at each end in an impedance. This creates both a voltage that gives capaci-

tive coupling and a current that gives inductive coupling to the cable. The combination of graded ferrite and capacitive/inductive coupling gives the clamp significant directivity, particularly above 10MHz, so that substantially less signal is applied to the AE end of the cable, and the common-mode impedance seen by the EUT is quite close to 150 ohms across a large part of the spectrum of the test signal.

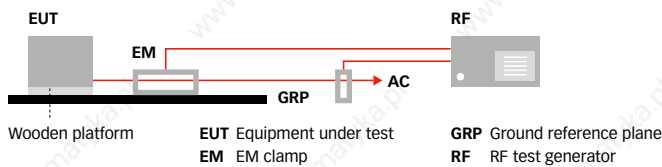

Conducted immunity testing with capacitive coupling clamp

As with the CDN, the EM clamp should be properly bonded to the ground plane to give a repeatable impedance. But also as with the CDN, variations due to cable layout on the AE side of the test setup and due to the AE itself should be minimized.

3.2.3 Radiated immunity

The standard test for radiated immunity is IEC/EN 61000-4-3. This requires a radiated RF field generated by an antenna in a shielded anechoic enclosure using a pre-calibrated field, swept from 80MHz to 1000MHz with a step size not exceeding 1% of fundamental and a dwell time sufficient to allow the EUT to respond. The antenna faces each of the four sides of the EUT in each polarization (and top and bottom, if these might be affected), hence there are 8 (or 12) tests in all. Amendment 1:1998 adds tests from 800 to 960MHz and 1.4 to 2GHz for protection against digital mobile phones.

The EUT is placed on the usual 0.8m high wooden table (for table-top devices) with its front face in the same plane as the uniform field area that was previously calibrated. Both the antenna position and the uniform area are fixed with respect to the chamber. The standard requires that at least 1m of connected cable length be exposed to the field, and recommends the use of ferrite chokes to decouple longer cables. The cable layout cannot be generally specified, but at least some of the length should be in the same plane as one of the polarizations of the antenna.

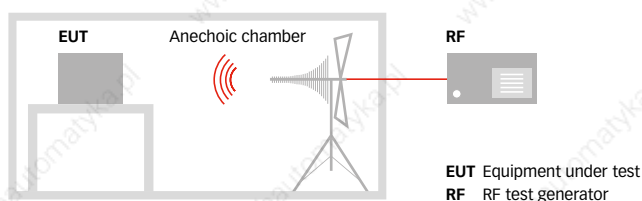

Testing principle for radiated immunity

The EUT is rotated on the table so that each of its four sides – and the top and bottom, if it may be used in any orientation – face the antenna in turn and are coplanar with the uniform area. For each orientation, two sweeps are performed across the frequency range, one in each antenna polarization. If the frequency is swept from 80 to 1000MHz in 1% steps with the conventional minimum dwell time of 3 seconds per step, each sweep should take about 15 minutes, and the whole test should take over two hours. This ignores the need for the software to control the frequency step, however, including settling and leveling at each new frequency. Depending on the software algorithm, this can increase the duration per step (and therefore the total test duration) 1.5- to 2-fold.

3.2.4 Transient immunity

In addition to covering continuous radio frequency phenomena, EMC means ensuring product immunity from several sources of transient phenomena that are present in the electromagnetic environment. These phenomena can be natural, such as electrostatic discharge (ESD) and lightning surge, or man-made, such as switching transients and fault surges. They involve short-duration (nanosecond or microsecond) events that have high enough amplitudes to disrupt the operation of electronic circuits and, in some cases, have enough energy to destroy or damage components. Except for ESD, the source of a transient is not normally near to the victim equipment, and its energy is almost entirely coupled into the circuits via cable connections. Therefore, immunity testing involves applying a repeatable pulse of a defined waveform and level into each relevant cable port in a specified and reproducible manner. Apart from the rarely used pulsed magnetic field and damped oscillatory wave tests of IEC 61000-4-9 and -10, there are no commercial tests that apply radiated transients. ESD is the special case that is the exception to this rule: it is applied from a simulator that attempts to mimic the real-world event and includes both radiated and conducted components. Application of a series of transients is accompanied by monitoring of the function of the EUT to determine whether it has been disrupted and, if so, whether the disruption is acceptable.

3.2.5 Electrostatic discharges (ESD)

All conductive objects have self-capacitance with respect to ground and mutual capacitance with respect to other bodies. This capacitance can maintain a DC charge with respect to ground. With perfectly insulating materials, this charge would remain on the object indefinitely, but in reality, there

is some surface and volume conductivity, and the free electrons drift, so that the charge differential is gradually neutralized. This is called electrostatic discharge.

In a moving person, all these factors come together to give a continuously varying voltage on that person. In the worst case – highly insulating materials, low relative humidity and vigorous movement – the voltage may reach as high as 25kV. Charge potentials higher than this tend to be limited by corona effects. In more typical situations, voltages vary between 2 to 8kV.

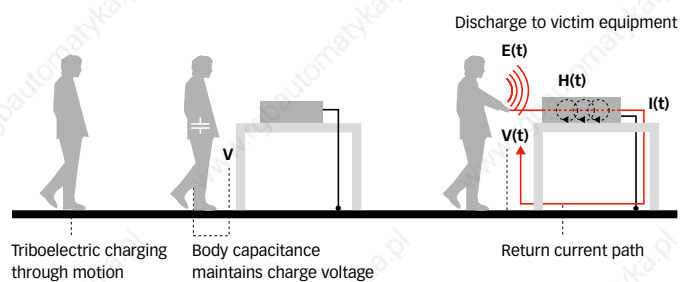

Typical human discharge scenario

When a charged object contacts another object at a different potential, the charge is equalized between the two objects, and there is both a voltage $v(t)$ and current $i(t)$ transient as this occurs. Digital circuits in particular may respond to these induced pulses as if they were intentional signals, and their operation is consequently corrupted.

IEC 61000-4-2 and its EN equivalent is the principal basic standard for testing electrostatic discharge immunity. It applies a defined current waveform at a specified voltage level from a handheld generator, which is essentially a capacitor supplied from a high-voltage supply whose charge voltage is discharged via a series impedance through the point of contact to ground. Two methods are given: contact discharge and air discharge.

In the **contact discharge** method, the stress may be applied directly to the EUT or to a coupling plane adjacent to the EUT. Before each test pulse, the capacitor is charged to the desired level, but its voltage is held off the generator's probe by a vacuum relay. The probe is applied to a suitably chosen point on the EUT or the coupling plane. The generator is then triggered. This action is repeated the desired number of times, at each location, with the appropriate polarities and levels.

The same generator is used for the **air discharge** method, but with a rounded rather than a pointed probe tip. The capacitor is charged to the desired level as before, but the voltage is now continuously applied to the probe, which is held away

from the EUT. For each test pulse, the tip is brought up to the chosen point on the EUT, gradually, until it touches. Just before this, the air gap between the tip and the EUT will break down and a discharge current will flow, limited as before by the combined series impedance of the generator, the air gap, the EUT and the return path. Again, the action is repeated the desired number of times, at each location, with the appropriate polarities and levels.

The ESD pulse has a sub-nanosecond rise time, so radio frequency layout precautions are vital. The test must re-create the fast rise time found in reality, since this is an important parameter in deciding both the path the discharge takes through the EUT and the response of the EUT itself. The ground reference plane (GRP) is an integral part of the setup and the generator's return lead must be well bonded to it, since this connection forms part of the current return path.

The indirect discharge part of the test uses two other planes, different from the GRP, known as the horizontal coupling plane (HCP) and the vertical coupling plane (VCP). Discharges to these planes simulate the stress caused by the radiated field from real-life discharges to nearby objects. Each coupling plane is connected to the GRP by a resistor lead to ensure that any charge bleeds off within a few microseconds.

3.2.6 Electrical fast transients (bursts)

When a circuit is switched off, the current flowing through the switch is interrupted instantaneously. Put another way, at the moment of switching there is an infinite di/dt . As a result, a high instantaneous voltage, added to the circuit-operating voltage, appears across the opening switch contacts. This causes the tiny but increasing air gap across the contacts to break down, and a current flows again, which collapses the voltage spike, so that the briefly formed arc extinguishes. But this re-interrupts the current, so another voltage spike appears, creating a further arc. This process repeats itself until the air gap is large enough to sustain the applied voltage without breakdown, at which point the circuit can be said to be properly switched off. The visible effect is a brief spark between the contacts, which actually consists of a whole series of micro sparks – the so-called “showering arc” – whose repetition rate and amplitude depend on the circuit and switch parameters.

Poor filtering or inadequate screen termination on each interface then lets these transients pass into the electronic circuits, where they appear as interfering signals at sensitive nodes. As with other types of transient, digital circuits tend to be more susceptible, since each short pulse can

appear as a valid digital signal. Occurring in bursts, there is a higher probability that one or more pulses will coincide with a critical timing edge. However, analog circuits can also be affected, typically by saturation of sensitive amplifiers. Pulse-counting circuits are also susceptible if the burst masquerades as real input.

IEC 61000-4-4 and its EN equivalent are the principal basic standards for testing fast transient immunity. Testing involves applying a specified burst waveform via a defined coupling network to the mains connection and via a defined clamp device to any signal connection. Only conducted coupling is used; there is no specification for radiated transient immunity. The choice of ports for the application of the burst depends on the instructions in the product standard being used, but it is generally applied to AC and DC power ports and to signal and control ports that may be connected to cables longer than 3m.

The effects of burst transients relate mostly to high-frequency components of the pulses. Common EMI filters will thus have some positive effects on burst problems. On the other hand, it should be pointed out that EMI filters are not specifically designed for burst suppression. The HF components of the pulses reach such high frequencies that oscillation of the filter circuit is also possible.

3.2.7 Surge

High-energy transients appearing at the ports of electronic equipment are generally the result either of nearby lightning strikes or due to major power system disturbances such as fault clearance or capacitor bank switching. Lightning can produce surges with energies of several joules by the following mechanisms:

- Direct strike to primary or secondary circuits: the latter can be expected to destroy protective devices and connected equipment; the former will pass through the service transformers either by capacitive or transformer coupling.
- Indirect cloud-to-ground or cloud-to-cloud strikes create fields which induce voltages in all conductors.
- Ground current flow from nearby cloud-to-ground discharges couples into the grounding network via common impedance paths and causes substantial potential differences between different ground points.
- Primary surge arrester operation or flashover in the internal building wiring causes voltage transients.

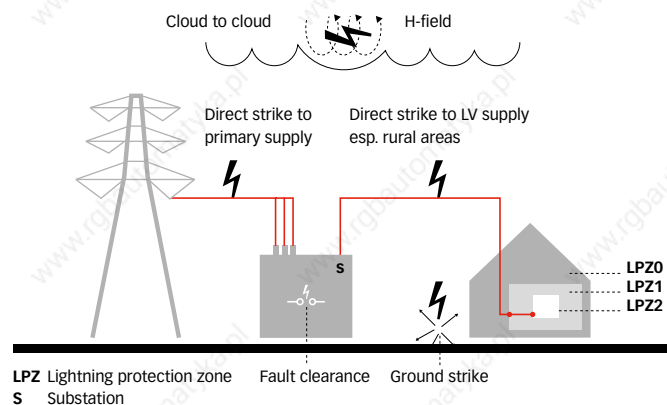

Surge generation

Surges impinging on electronic equipment may cause hardware damage and complete failure or, in lesser cases, operational upset. Below a certain level dependent on equipment design, no effect is observed. Above this level, a surge may cause the operation of the equipment to change state, without any long-term effect on the circuit components. But at a higher level, there may be enough energy to cause breakdown in critical components. The maximum voltage that is likely to occur is limited by flashover considerations. In a typical domestic mains supply, for instance, no more than about 6kV can be withstood by the wiring components. Typically, protection involves adding parallel surge suppression devices such as clamping diodes, varistors or spark gaps. The purpose of these devices is to break down in a controlled manner at a voltage lower than can be sustained by the circuit and dissipate the surge energy within themselves. They must therefore be sized to withstand the maximum surge energy to be expected in a particular application. The rate of change of applied voltage and current also has a bearing on both the susceptibility of a particular interface to upset and on the ability of protection devices to cope with the surge.

Schaffner filters will show little suppression effects for surge pulses unless they are equipped with additional surge suppressors (Z versions). Nonetheless, Schaffner filters are tested against destruction from overvoltages and can therefore be used without risk of damage by surge pulses.

3.2.8 Power magnetic fields

Power magnetic fields are magnetic fields caused by the AC mains power supply in conductors. The fields are continuous and related to the current flowing in the conductor. The frequency of the field corresponds to the net supply frequency, i.e., 50Hz in European systems.

Magnetic fields are always present around conductors carrying any amount of current. If the conductor forms a loop, the circular magnetic field waves add up and form a directional field. In both cases, the fields generated are directly proportional to the current that is flowing. In other words, the higher the current, the stronger the magnetic field.

Power magnetic fields can reach field strengths of more than 100A/m, depending on the environmental conditions. Logic dictates that the higher the current, the more severe the effect of the magnetic fields. Industrial applications and high-voltage distribution systems thus present more stringent conditions than household appliances. High magnetic fields exist in the vicinity of motors, generators and all equipment with high power requirements.

Magnetic fields affect only a very limited range of electrical equipment, i.e., equipment that relies on magnetic fields for its function. The most commonly used equipment is a standard CRT (cathode-ray tube), but the ongoing replacement of this technology with LCD and plasma displays is steadily reducing this problem. Also, the effect of magnetic fields on displays is easy to recognize, and misinformation of the user is very unlikely. However, the display can become illegible, and in areas where the information on the screen is essential for the proper use of the equipment, such disturbances cannot be accepted. One example would be the use in medical environments, where screens often display the physical status of a patient.

More critical is the effect of magnetic fields on sensors and readers that use magnetic effects to produce measurement results. If the meter starts flickering or behaving strangely in any other way, the user will easily recognize an equipment malfunction. However, the influence of a magnetic field might lead merely to an inaccurate reading that is not recognizable to the user. Immunity of such equipment against magnetic fields is therefore essential.

3.2.9 Supply network

When equipment is connected to the power network, its operation usually affects the supply voltage characteristics. We have already explained the occurrence of harmonics as a result of non-linear currents. Equipment is also affected by interference that already exists in the supply network. The following picture gives an overview of existing interference.

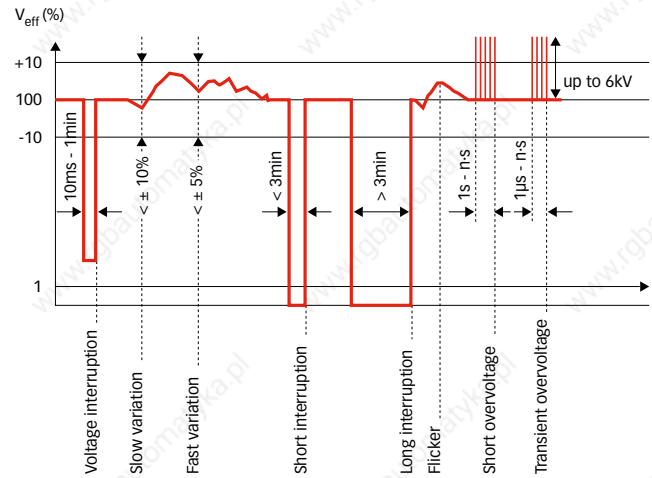

Supply changes in a typical supply network

The currently existing standards deal mainly with voltage dips and short interruptions. Voltage dips are interference in the mains power supply, ranging from constant repeating variations to sudden dips or a complete shut-off. Such power distortions can seriously affect other equipment. Whereas a short dip can influence processors in other equipment, a complete temporary shut-off can reset equipment and have it start up again in an unsafe condition. Voltage dips are short changes of the supply voltage to a certain level – for example, the voltage can drop to 50% of its original value. The duration of such a dip can be expected to be between half a period of the net frequency to a few seconds, but usually the duration is on the lower end of that scale.

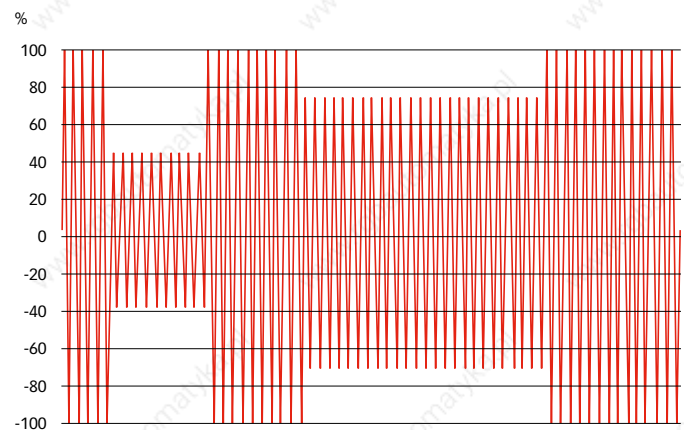

Example of voltage dips

Short interruptions are voltage dips to 0%. The duration of such interruptions can be several seconds but does not usually exceed one minute.

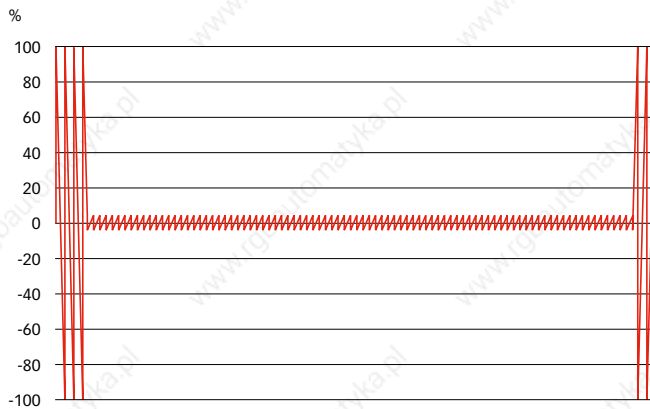

Example for short interruptions

Voltage dips and variations not only affect industrial networks but are also very common in residential areas. Voltage dips occur very frequently but are not always a problem. In many cases, the internal circuitry of equipment or the power supply installation can compensate for such occurrences. Interruptions will usually lead to degradation of the performance of the equipment, but it has to be ensured that afterwards, the equipment is either safely shut down or does not restart in unsafe conditions.

In order to perform testing against voltage dips and interruptions, the EUT must be connected to a well-defined power supply, thus enabling exact switching parameters and synchronization of the dips with the phase angle of the power supply.

The key point for testing is the generator, and the standards set very high requirements for such generators. They must be capable of handling constant currents at voltage levels of 100%, 70% and 40% of the supply voltage.

More difficult than that are the requirements for rise time and inrush currents. At a supply voltage of 230V, the generator must be able to switch (dip) within 1 to 5 μ s while at the same time being able to handle up to 500A of inrush current. These two requirements make the development of appropriate generators difficult, and a lot of existing testing equipment still does not comply.

4 Noise suppression

With the explosive increase of the popularity of electronic devices, the demand for regulation has created innumerable standards and conformity procedures. Accompanying this is the need not only for testing but for improvements to equipment design as well. In this chapter, we wish to examine some common design features affecting EMC and noise suppression components.

4.1 Conceptual EMC

Before looking at the different methods of noise suppression, it is important to point out that proper handling of EMC always requires a concept. It starts with the first design idea and ends with the product launch.

Very often, EMC is the last step in a design. When all the product features have implemented and the functionality is established, any EMC problems are solved. At this point, EMC becomes expensive, time-consuming and difficult to handle. Manufacturers should therefore always start thinking about EMC in the early stages of product design.

4.2 Shielding

From the point of view of legislation and standards, EMC takes place only outside of the equipment. Internal EMC is considered a functional issue and therefore not part of the regulations. Shielding is therefore a good measure to reduce electromagnetic noise outside of the equipment by keeping the noise inside. Shielding can be applied to enclosures and cables.

4.2.1 Shielded housings

For many kinds of equipment, shielded housings have become a default measure for noise reduction. Shielded enclosures should be made of metal or other conductive materials. The enclosure has to be grounded plainly, because ungrounded enclosures will provide only minimum shielding attenuation. The paint of enclosures often neutralizes the shielding effect of the enclosure. If the paint is non-conductive, the enclosure has long openings at doors and other openings. The same applies to gaskets, which in most cases are made of rubber to guarantee a certain IP class. Conductive paints and gaskets are available, but more expensive.

Every opening in an enclosure acts like an antenna. A horizontal opening acts like a vertical antenna and vice versa. Openings can be apertures for ventilation purposes but also contact points between non-conductive parts of the enclosure (paint). If EMC characteristics are critical, the relation between size of apertures and wavelength of the disturbance to be attenuated should be considered. If necessary, special EMC openings, conductive paints and gaskets can help.

4.2.2 Shielded cables

Cable shielding is a very effective measure to improve susceptibility and reduce emission. However, incorrect installation can reduce the effectiveness or even completely destroy the effect of shielding. External voltages and currents do not

directly affect the signal line, only the shield around the cable. The disturbances that reach the inside conductor are thus attenuated. The shielding effectiveness can therefore be described as the relation between the current on the shield and the induced voltage on the inner conductor.

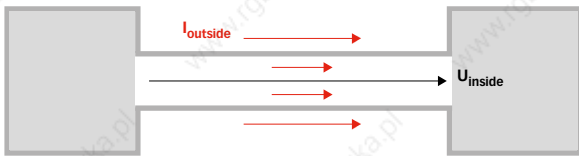

Principle of shield effectiveness

The attenuation of a shield depends on the material and installation. The best values are achieved with conduits, but this is necessary in only a few cases. Metal films or braided wires serve well enough for common applications. For more critical installations, double-braided wires or two separate shields can be used.

If shielded cables are used, the ends of the shield have to be connected to ground. If none of the ends is connected, the shield becomes ineffective. Induced fields cannot be diverted; ground currents cannot be reduced. If shields are connected on only one side, they become effective against electric fields. However, once the resonance frequency of the shield is reached, the shield becomes ineffective and even amplification can occur. If both ends of the shield are connected to ground, the shield has the best effect. Electrical and magnetic fields can be reduced. Differences of potential do not affect the signal line. However, since potential differences result in currents on the shields, other lines can be affected.

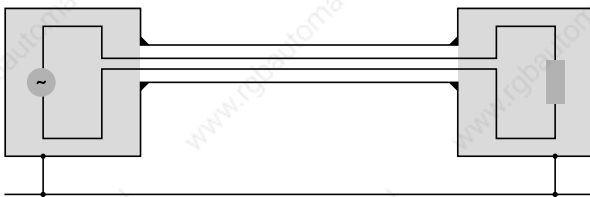

Proper connection of shielded cable ends

For the sake of completeness, it should be pointed out that shield connections as shown above can occasionally generate additional ground loops. If additional problems occur, compensation conductors between the two units or additional earthing along the shield should be applied.

Proper connection of the ground is also important for the performance of the shield.

The most common problem with the connection of shields is the use of “pigtailed”, as shown on the left side of the pic-

ture. The shield is twisted to one tail and then connected to ground on only one point. This increases the coupling resistance of the shield and reduces its performance. The best connection of a shield is a 360° connection at both ends as shown on the right side.

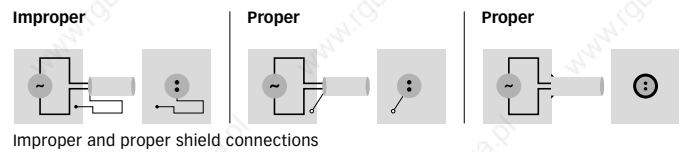

Improper and proper shield connections

4.3 Grounding

Ground connections are essential for EMC concepts in many ways. Connection types and concepts have influence on the function and performance of a grounding system. Basically, grounding should fulfill the following requirements:

- Coupling between susceptible paths and paths with high emission should be reduced.
- Coupling from external radiated fields should be reduced, along with emission from the equipment itself.
- Differences in potential between several units are to be avoided.

4.3.1 Grounding concepts

As mentioned before, grounding is not the only effective measure. The optimum result can be achieved together with other design tools such as shielding and filtering. For all EMC countermeasures, the whole set of tools should be used and the most economical solution chosen. For grounding, a number of general rules apply:

- Each electrical circuit should have an independent ground connection in order to avoid different potentials.
- The method of grounding depends on the frequency of the signal.
 - For lower frequencies, the dimensions of the circuit are small compared to the wavelength and resonances are not likely to occur. Grounding on one side is sufficient and should be done on the transmitter side, with the receiver side floating. This method is called single-point grounding
 - For higher frequencies, the wavelength is small against the dimensions and resonances are hard to avoid. In order to have defined conditions, cables with well-known characteristic impedances are used and grounded on both ends. In some cases, cables are additionally grounded at several points along the signal path. This grounding concept is called multi-point grounding.

- For circuits with low- and high-frequency signals, triaxial cables would be the best solution. However, high price and weight rules them out in many cases. Mixed concepts are therefore used, combining grounding with twisted cables and other methods.
- Grounding is not only necessary for one piece of equipment but for the whole system. All single units should be connected to the same ground point to avoid potential differences. If more than one system grounding point is used, a low-resistance connection between those points is imperative.

4.3.2 Earthing

Grounding and earthing have separate functions in equipment and different rules apply to them. Earthing is solely for safety reasons, so the resistance of the earth connection is important. Most safety standards required the earth connection to be tested. Grounding, however, is mostly used for EMC reasons. More important than the resistance is the impedance of the ground connection, especially at higher frequencies. Plain connections are therefore more effective than point connections. Flat, braided cables should also be preferred over round solid wires. Grounding should never be confused with earthing. Earthing is the connection of the whole system to common ground for safety reasons. Grounding can be applied for functional reasons or to improve EMC characteristics.

4.4 Suppression components

Interference can be reflected towards its source by incorporating an LC network in the noise path. This prevents interference energy from leaving a suppressed device and entering the power supplyline. An efficient inductor-capacitor combination to protect against line-conducted interference consists of the following:

- Series inductances in the interference paths
- Cx capacitors between phase and neutral
- Cy capacitors between phases and earth

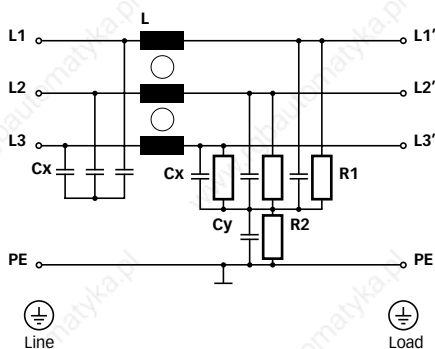

Typical circuit diagram of an EMI filter

4.4.1 Chokes

Chokes consist of an electrical conductor wound around a material with magnetic characteristics, the core. Various shapes exist for the core material: ring cores, D-cores, E-cores, I-cores, etc. Regardless of the shape, the choke always makes use of its magnetic characteristics to suppress RF noise.



Ring, D-, E- and I-cores

The core material pushes the performance of a choke to its maximum. It enhances the magnetic effects in the choke, improves the suppression characteristics and leads to more compact components. Core materials are also dependent on outside factors such as temperature or current, however. When used outside of its specifications, a choke can saturate, leaving it unable to supply its original impedance.

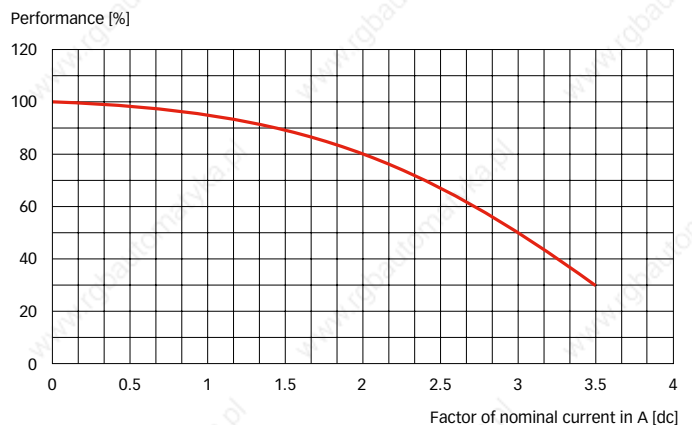

Saturation of chokes due to current

While the rated current is one of the main factors causing saturation, high asymmetric noise currents can be another reason for this effect. Saturation can be avoided by keeping the choke within its specifications or by a special winding technique called current compensation. This is explained later.

The impedance characteristic of a choke in relation to the frequency makes it an interesting component for noise suppression. The impedance increases at higher frequencies. Theoretically, the impedance would continue to increase with the frequency. A real choke, however, includes a certain winding capacitance. When the resonance point is reached, the impedance of the choke will reverse and decrease. This is shown in the following picture.

Z [Ohms]

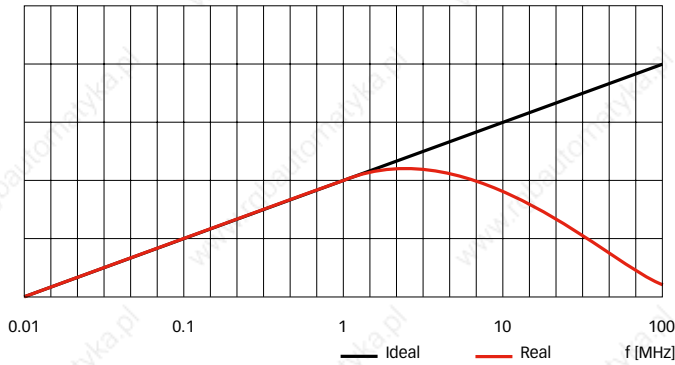

Typical impedance characteristic of chokes

Three main types of chokes may be used for the purpose of noise suppression:

- Common-mode chokes – with multiple windings to avoid saturation (loss of effective inductance) of the core material
- Saturating chokes – ideal for reducing fast current changes
- Rod-cored chokes – which present a constant inductance even at high currents

Common-mode chokes (RN, RD and EV/EH series) are used to attenuate common-mode or asymmetric (P/N → E) interference signals by being connected in series with the phase and neutral lines of an AC power line input. The magnetic fields produced by this winding technique cancel each other out. Full inductance is only presented to interference signals that flow asymmetrically from phase/neutral to earth.

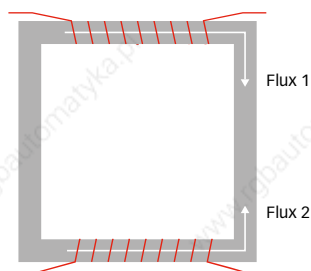

Principle of current compensation

Symmetrical components of the noise are also attenuated by the leakage inductance of the windings. The impedance of the choke at power line frequencies is therefore negligible, resulting in practically zero voltage drop. These chokes are typically used in conjunction with suppression capacitors as follows:

- In phase-angle control circuits where the desired degree of suppression cannot be achieved by saturating chokes alone
- For suppressing high interference levels from ultrasonic generators, fast rectifiers, switched mains equipment etc.

- For suppressing equipment with no earth connection
- For input filters to protect digital circuitry from mains-borne interference

Saturating-type chokes (RI types) change impedance at the moment of switching and can be used to attenuate differential mode or symmetrical (P → N) interference as generated by phase angle control devices such as thyristors and triacs. Interference levels can be brought within the limits of national and international regulations by using these chokes in conjunction with appropriate suppression capacitors. For optimum attenuation, chokes must be connected as close as possible to the semiconductor switching device. A simple single-stage suppression circuit is shown in the following illustration; this can be made into a dual-stage filter by the load itself and one additional capacitor.

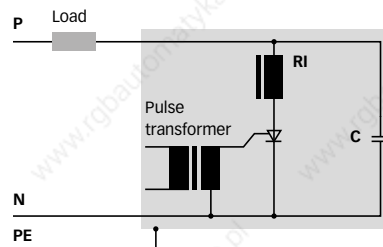

Saturating chokes in series with thyristors

4.4.2 Capacitors

Capacitors are basically two metal plates separated by a distance filled with a non-conductive medium like air, but more often other sturdy materials are used to improve the capacity. Most solutions in this catalog employ a self-healing plastic film dielectric, which offers significant quality and reliability advantages. All capacitor dielectric materials contain pinholes and other imperfections; during manufacture, a high voltage is applied to the dielectric to burn away the metallization around the pinhole, creating a high-quality capacitor in which any weak areas are totally isolated. Similarly, if a voltage surge punctures the dielectric during normal operation, an arc occurs at the point of failure, melting the surrounding metal and isolating the area of the breakdown. This maintains the quality of the capacitor instead of causing a failure due to voltage breakdown. The impedance of a capacitor decreases at higher frequencies. Due to the inductive behavior of the connection leads, however, capacitors reach a point of resonance after which their impedance increases again.

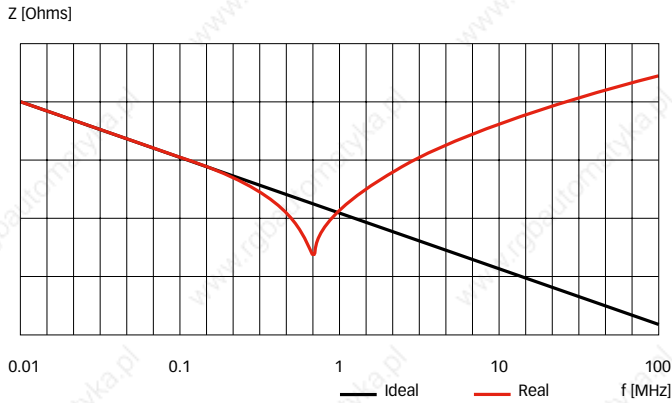

Typical impedance characteristic of RFI capacitors

Resonances can be almost completely avoided with feedthrough constructions. Instead of connection leads attached to the capacitor coil, the line is directed through the center of the coil. One side of the capacitor is then connected directly to the line; the other end is connected to the housing. The result is a common-mode capacitor without significant connection leads, thus avoiding resonance points.

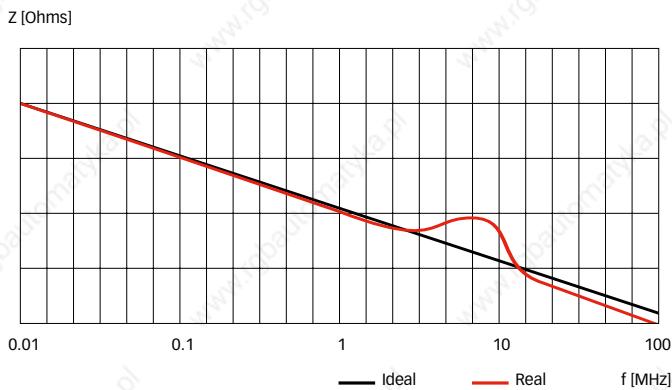

Typical impedance characteristic of a feedthrough capacitor

Capacitors are connected between phases or between phase and earth and are therefore subject to safety considerations. All the capacitors used in Schaffner's feedthrough components are of a series construction, which reduces the voltage stress on each capacitor element. This provides an excellent safety margin for high-voltage transients, and – in the case of AC feedthrough components – minimizes ionization effects to ensure long and reliable component life.

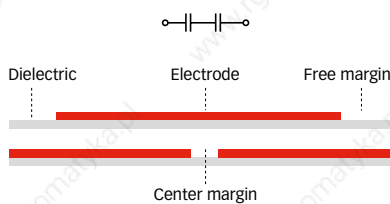

Series construction of capacitors

4.4.3 Filters

The mains, or power line, filter is the key element in eliminating mains-borne interference. This filter has to meet not only the requirements of electromagnetic compatibility (EMC) but safety aspects as well. For some applications, the filter also has to prevent the radiation of classified information from the mains line (TEMPEST applications). Other applications require a filter to protect equipment from destructive voltages on the power line, like those caused by lightning or nuclear explosion (NEMP).

Filters are available with a variety of electrical and mechanical specifications. PCB filters are designed for compactness and ease of assembly, and avoid the need for extra mounting components and installation operations necessary with chassis styles, but at the expense of finite available space for filtering circuitry. Consequently, they typically offer just a single stage of attenuation, with limitations on the maximum power handling capability. This typically makes these filters ideal for companies that have planned for EMC protection throughout the equipment design process and are completing equipment protection with these low-cost components. When integrating these components, care must be taken to provide a low-impedance connection to earth and minimize the potential for any noise radiation from the mains inlet connection.



Schaffner PCB filter FN 409

IEC inlet filters are widely used for interference suppression purposes in computers and their monitors, business equipment such as printers or copiers, and in medical devices. The filters combine the commonly used IEC inlet with excellent filter performance at a very small size and are therefore an excellent choice for equipment with switch-mode power supplies (SMPS). In addition to the classic filter function, IEC inlet filters are also available in combination with switches, fuse holders and/or voltage selectors.



Schaffner IEC inlet filter FN 9222

Chassis mount filters provide a higher performance solution in metal cases for optimum connection to earth and good high-frequency performance. With the space available for up to three circuit stages for noise attenuation, users can usually find an option with the performance to provide an off-the-shelf solution for even the most difficult EMC problem (retro-fitting an EMC solution to an existing design, for instance).



Schaffner chassis mount filter FN 2410

Power electronic devices such as industrial frequency converters, as well as machine tools, are typical application areas for three-phase power line filters. In addition to this industrial market sector, these types of filter are also suitable for mainframe computer systems, large uninterruptible power supplies, and medical equipment such as X-ray machines. All the filters are supplied in chassis mounting metal cases, facilitating good connection to earth and optimum high-frequency performance. Versions are also available with a neutral line or different operating voltages up to 690VAC, enabling designers to quickly locate the most economical and technically suitable EMC solutions for their projects.



Schaffner three-phase filter FN 3270

Feedthrough capacitors and filters offer a particularly cost-effective means of combating conducted interference. Offering a high insertion loss across a broad band of frequencies – from a few tens of kHz right through to the GHz region – these single-line components are exceptionally easy to fit and can provide a more economical RFI suppression solution than dedicated filters, especially for systems that have multiple input or multiple output power lines.



Schaffner feedthrough filter FN 7611

4.4.4 Filter attenuation

Filters are generally described by their attenuation, also called insertion loss. In order to determine the attenuation, a defined source and load are connected and the signal from the source is measured. The filter is then inserted and the measurement repeated. The attenuation is then calculated from the two results with

$$A[\text{dB}] = 20 \cdot \log \frac{V_2}{V_1}$$

where V_2 and V_1 are the results with and without the filter, respectively. The measurement is described in CISPR 17. The load and source impedance must be 50Ω each. Both asymmetrical (common-mode) and symmetrical (differential-mode) attenuations need to be measured. The results are then usually shown in an attenuation diagram.

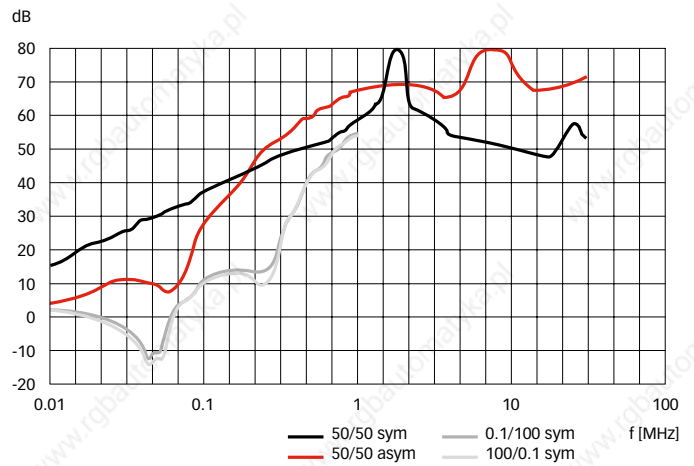

Typical attenuation diagram

The attenuation diagram of Schaffner products always shows two additional lines: the symmetrical attenuations for $0.1/100\Omega$ and $100/0.1\Omega$ load and source impedances. The attenuation diagram of a filter never reflects the subsequent reality, just the laboratory measurement conditions. Measurements at different impedance values easily show that the attenuation shifts with changing impedances. The attenuation characteristic also does not tell the end user how well the filter is going to perform under load conditions. Schaffner filters are therefore always tested additionally at various load conditions in order to guarantee good attenuation performance without saturation in the final application.

5 Power quality

Power quality is an issue of increasing importance, and many electricity supply utilities are now mandated to provide a mains supply with controlled quality parameters such as harmonic distortion and voltage limits. To achieve this, they must in turn place restrictions on the pollution caused by various types of connected load, especially those which draw distorted current waveforms.

5.1 Definition

In previous chapters about EMC measurements, we have already seen the effects of harmonics and voltage fluctuations on equipment connected to the power grid. These effects can be supplemented by frequency variations and similar interference related to the power grid voltage and frequency.

The efficiency of a power network is generally described by the power factor PF. This power factor is calculated by the formula.

$$PF = \frac{I_{1,rms}}{I_{rms}} \cdot \cos\varphi$$

where $I_{1,rms}$ = rms value of the fundamental current
 I_{rms} = rms value of the total current, including harmonics and distortions

The closer the power factor is to 1, the more efficient the power grid is being used.

When we move down to the equipment level and consider the quality of the power, we often come across frequency inverters. Frequency inverters are among the most widely used pieces of equipment for AC motor control. Nowadays, they are found in virtually every area of industry, in applications as diverse as pumps, air conditioning systems, elevators and cranes, conveyors, machine tools, alternative energy production and in a vast array of other industrial and domestic automation.

In the quest for ultra-compact, efficient power conversion, inverter manufacturers employ high-speed semiconductor (IGBT) switches and pulse width modulation (PWM) techniques to generate fast rise time voltage pulses of the appropriate duration and polarity. Unfortunately, this creates a considerable number of problems for OEMs and system integrators, from purely functional difficulties to very severe motor damage. There follows a brief summary of the most significant problems and phenomena:

Inverter input

- EMC problems
- Harmonics
- Commutation notches
- Inrush & peak currents
- Low-frequency interference

Inverter output

- Excessive dv/dt
- Peak & overvoltages
- Parasitic earth currents
- Eddy current losses in the motor
- Displacement currents in the coils
- Bearing currents
- Additional inverter pulse loads
- Acoustic motor noise
- EMC problems

Inverter DC link

- DC link capacitor stress
- Harmonics
- Various other problems

Whole system

- Low efficiency/low power factor
- Uncertain system immunity
- Unacceptable interference emissions
- Uncertain service security & reliability

5.1.1 Frequency ranges

According to the definitions in the standards, EMC deals with a frequency range from DC to 400GHz. However, limits are currently only defined for a very limited area of that whole frequency range. The following ranges are currently defined:

- 50/60Hz to 2.5/3kHz for mains harmonics (depending on power frequency)
- 150kHz to 30MHz for line-conducted emission
- 30MHz to 1GHz for radiated emission
- 9 to 150kHz for certain equipment for conducted emission
- 1GHz to 18GHz for some industrial equipment for radiated emission
- 1GHz to 40GHz for some telecom equipment for radiated emission

This leaves an undefined area from 2.5/3kHz to 150kHz. However, this area is not noise-free; it is simply not regulated. While excessive noise in this frequency range will not lead to non-compliant equipment, it will most certainly lead to functional problems.

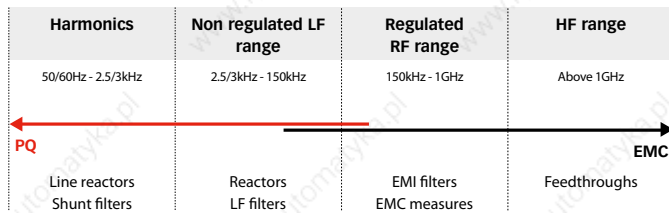

Regulated and non-regulated frequency ranges

The lower frequency range is typically seen as the power quality (PQ) range. However, the picture above illustrates that the PQ and EMC ranges overlap. As a matter of fact, EMC is only one part of the overall power quality. The same is true for the solutions. A filter for the conducted emission range from 150kHz to 30MHz will not simply cover this defined range; it will also attenuate at lower and at higher frequencies. Manufacturers can therefore profit from a single provider of PQ and EMC solutions like Schaffner.

5.2 Reactors in drive systems

5.2.1 Need for protection

Manufacturers of variable speed drives (VSD) nowadays are operating in an extremely competitive marketplace, and the tendency is to offer drive products without input reactors unless the end user specifically requests it. Users, though, often are not familiar with the reasons why a reactor is beneficial both for the reliability of the drive's electronics and for the quality of the power supply. The introduction of an input reactor has the following effects:

- Buffers the electronics from input transients due to utility and load switching elsewhere in the supply
- Prevents high inrush currents and reduces the transient load on the input components
- Improves VSD crest factor, reducing power input line losses
- Controls emissions of line current harmonics due to the rectifier input circuit
- Controls the impact of commutation notches on the power supply
- Protects and increases the service life of DC link capacitors of VSDs
- Reduces differential-mode low-frequency phenomena up to a few hundred kHz

5.2.2 Overview of uses

Reactors and filters can be used in various locations in a power drive system: in line with the power input (line reactor), in the DC link between the rectifier and capacitor (DC link choke) and at the drive output to the motor (motor reactor). A reactor at each of these positions has specific effects

that are by no means mutually exclusive. Generally, it would be unnecessary to have a reactor in both the power input and the DC link, but the functions of the input line reactor are quite different from a filter at the drive output, and it is entirely reasonable to include both of these.

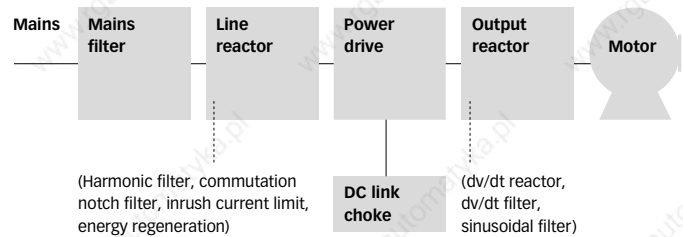

Possible locations of reactors in drives

5.2.3 Line input

A reactor in the power supply input will do two things: protect the drive electronics from power disturbances and protect the power supply from disturbances created by the drive.

Harmonic attenuation. A three-phase input rectifier with a reservoir capacitor draws current discontinuously. When the input voltage across any pair of diodes is greater than the DC link voltage maintained across the capacitor, then current flows and charges the capacitor. When the input voltage is less, the diodes block the input current and the reservoir capacitor supplies the DC link current. This gives rise to a characteristic “double pulse” input current drawn from any of the three phases; these accumulate in the DC link to give a series of unipolar pulses of current at six times the frequency of the input (300Hz in EU applications).

The discontinuous phase current is rich in harmonics of 50Hz. The total harmonic distortion (THD) is typically 90% to 150% with a harmonic content predominantly made up of 5th, 7th, 11th and 17th harmonics.

The effects of these harmonics on the power supply and ultimately on other users are manifold:

- Transformer and neutral conductor overload due to excessive zero-phase currents
- Overheating of power factor correction capacitors due to high frequency currents
- Conductor losses due to skin effect at higher frequencies
- Voltage distortion, amplified at remote points in the network due to resonances
- Failure of direct-off-line induction motors trying to run at harmonic frequencies
- Acoustic and electrical interference at audio frequencies

- Increased earth leakage currents due to stray and EMI filter capacitances

The electricity supply industry is naturally keen to reduce these effects. Electricity suppliers are required in many countries today to offer a supply of guaranteed quality, and they can do this only if the users' pollution is controlled. Limits are placed on harmonics emissions either by the terms of connection offered by the utility or by a requirement to meet international standards, of which IEC 61000-3-2 for equipment <16A per phase and IEC 61000-3-12 (draft) for equipment current between 16 and 75A per phase are the most significant. In the USA, harmonics are in the scope of the IEEE 519 standard.

To meet these requirements for a standard three-phase rectifier-reservoir input circuit, some inductance in line is needed. This is the function of the line reactor. The reactor's inductance slows the rate of rise of each individually rectified pulse and continues supplying current for a millisecond or two after the input voltage has dropped below the DC link

voltage. The six-pulse waveform is thus "stretched" and can become continuous rather than discontinuous if the inductance is high enough.

At the same time, the peak amplitude of the current is reduced. This means that the crest factor of the waveform is reduced so that the peak-to-rms ratio is lower. This has many benefits, including lower stress on the reservoir capacitors and hence greater reliability. The harmonic attenuation is directly related to the value of inductance in circuit. Since Schaffner reactors are specified as a percentage voltage drop, we can relate this percentage to the harmonic attenuation as shown in the table below. As can be seen, the 4% inductor gives considerably better harmonic attenuation than the 2% inductor but at the cost of greater voltage drop and a much larger component.

In addition to standard line reactors and harmonic filters, Schaffner can also offer a variety of customized solutions for harmonics reduction.

Relation between uk and harmonics reduction

Harmonic Number	Input impedance uk in % vs. remaining harmonics										
	0.5	1	2	3	4	5	6	7	8	9	10
5	80	60	46	40	34	32	30	28	26	24	23
7	60	37	22	16	13	12	11	10	9	8.3	7.5
11	18	12	9	7.4	6.3	5.8	5.2	5	4.3	4.2	4
13	10	7.5	5.8	4.9	4.2	3.9	3.6	3.3	3.15	3	2.8
17	7.3	5.2	3.6	3	2.4	2.2	2.1	0.9	0.7	0.5	0.4
19	6	4.2	2.8	2.2	2	0.8	0.7	0.4	0.3	0.25	0.2
THID	102.5	72.2	52.3	44.13	37.31	34.96	32.65	30.35	28.04	25.92	24.68

5.3 Output solutions for motor drives

At present, there are trends observable in the motor drive market that could have tremendous effects on the reliability of entire drive systems and the measures taken to guarantee it:

- Miniaturization, both of motor drives and motors, often accompanied by cost savings in the insulation strength of motor windings
- Retrofitting of motor drives in existing systems with old motors and unshielded cables
- Trends towards high-rotational speed machines with low mass (such as HF spindles)
- Innovative low-speed motor technologies with a high number of poles (such as tool beds with torque motors in machine-tool engineering applications)

Motor drives are known sources of interference and are therefore usually equipped with an input filter. However, fewer people are aware of the problems on the output side where the converter supplies the motor with the modulated signal. Some of the typical output challenges are described below.

5.3.1 dv/dt – voltage potential jumps in relation to the time

To keep the losses in the frequency converter or servo low, the aim is to keep the switching times of the power semiconductors as short as possible. The result of this is that with the newest generation of IGBTs, rise times of sometimes more than 12kV/μs can be measured, whereas – depending on the motor – a dv/dt of <1000V/μs is considered permissible (VDE 0530: 500 to 1000V/μs).

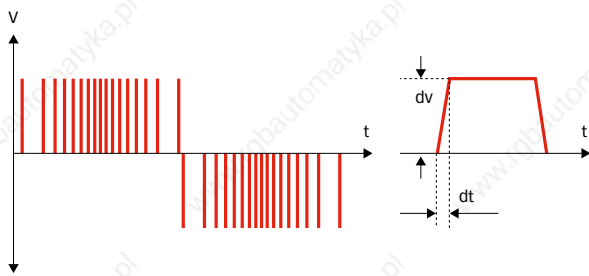

Definition of dv/dt

In the case of short motor cables up to about 20m, these rise times – owing to the small line impedance – act fully on the insulation of the motor windings. Depending on the structure of the motor coils, wires that carry the full voltage are situated immediately in parallel and next to each other. Since even very short parallel-laid wires have a capacitive action, the permanent potential jumps result in pole reversal losses across the winding insulation. Now, if the enamel insulation is impure even to a very minor extent, this results

in the so-called hot-spots, and hence, sooner or later, to a destruction of the winding insulation. In any case, this dv/dt stress load leads to premature aging and thus to a reduction in the life of the motor.

5.3.2 Voltage overshoots and voltage peaks

Voltage overshoots and voltage peaks can come with high dv/dt values but are also a problem on their own. Due to the structure of the windings, a motor acts like a capacitor in the equivalent circuit diagram – owing to the fast voltage pulses of the switching frequency – and not as an inductance, as is the case in normal 50Hz applications. With every additional meter of motor cable, more wire inductance is added to this structure. This inductance acts like a choke according to the energy storage principle. If chokes are subject to voltage pulses, voltage peaks occur every time switching on or off takes place. The higher the energy content (inductance) of the choke, the higher these voltage peaks become. In other words, the longer the motor cable, the higher the maximum voltage amplitudes. These amplitudes can, in turn, reach values that cause a stress situation in the winding insulation of the connected motor. Owing to the cable impedance, the dv/dt stress – in the case of longer motor cables – is reduced to less problematical values. On the basis of the line theory, however, peak values of 1600V or more (depending on the DC link voltage) can occur due to cable reflections, which can have very steep dv/dt values. According to VDE 0530, peak values of <1000V are recommended. Despite the reduced dv/dt owing to the cable impedance, there is no significant stress relief for the motor, since now the increased voltage amplitudes represent the dominant stress factor.

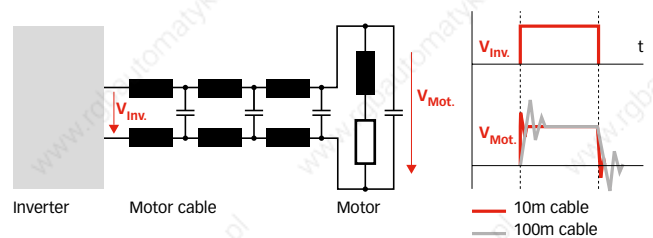

Simplified equivalent circuit of shielded cables

Note that the picture above shows only the equivalent circuit of one phase.

5.3.3 Additional losses in the motor

Apart from the problem with the winding insulation, the steep switching edges create another phenomenon: harmonics of the output signal. By applying Fourier analysis, it can be mathematically proven that the harmonic spectrum of the motor currents becomes wider with the steepness of the pulses – that is, the harmonic content increases. The current ripple (PWM and harmonics) results in additional magnetic losses in the motor. The life of the motor is sensitively shortened owing to the permanently increased operating temperature.

5.3.4 Cable shields and parasitic earth currents

From the standpoint of EMI suppression, shielded motor cables are required to avoid back-coupling of radiated interference to the mains cable in the frequency range from about 1 to 30MHz. This measure of the EMC can, however, only be considered to be efficient if the ends of the cable shield of the motor cable are put in contact with the ground of the motor and the frequency converter – if possible, at HF low impedance and over as large an area as possible. This ensures that the interference currents can mostly flow back to the source by the shortest route.

Frequency converters normally work in grounded networks and do not have any potential separation. The geometric expansion of both the frequency converter motor and this shielded motor cable therefore form parasitic capacitances of the electrically conducting components with respect to the ground potential. If the available DC voltage is chopped in the frequency converter, then during the potential jumps of the voltage, considerable pulse currents flow across the parasitic capacitances to the earth. The level of the interference currents on the cable shield depends on the dv/dt as well as the value of the parasitic capacitances ($I = C \cdot dv/dt$). With a motor cable length of about 100m, peak values of the pulse currents of 20 amperes and more are not unusual, regardless of the power rating class of the drive.

The harmonic spectrum of these currents can reach a range of several MHz. The shield of the motor cable, owing to the existing braiding, offers a very large surface area and a sufficient cross-section to carry these currents. As a result, the impedance of the shield across a broad frequency range is of a very low-impedance nature. Losses due to the skin effect are limited to a minimum because of the large surface area. Inadequate ground connections of the cable shield (the so-called “pigtailed”), on the other hand, are highly resistive for the frequency range under consideration and often nullify the desired shielding effect.

If there are parallel-laid control cables or electronic components in the vicinity of the motor cables, pulsed HF currents flow across their geometric expansion and the resultant parasitic capacitances, which in turn could have an impermissible influence on neighboring equipment through capacitive coupling.

If neighboring components are located in the immediate vicinity of the motor cable, the conductor loops and the high di/dt values of the shield currents also result in a magnetic coupling that can also lead to impermissible influencing.

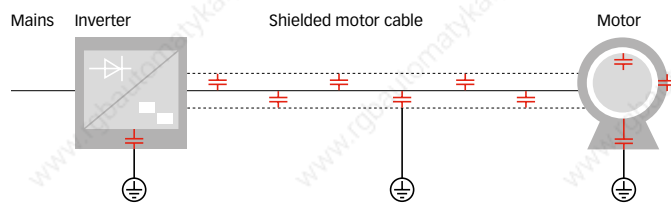

Parasitic capacitances in a drive system

The currents flowing across the shield must be supplied by the frequency converter as well. They are not dependent on the rating of the drive but only on the geometric expansion of the structure. With small power ratings, the result of this, especially in case of long motor cables, can be that a frequency converter of the next higher rating has to be used that is able to supply both the currents required by the load and the parasitic currents via the earthing.

The operation of several motors connected in parallel on one frequency converter is problematic. The parallel connection of several shielded cables results in a relatively high total capacitance and thus correspondingly high shield currents. The parallel connection of several drives, however, is accompanied by even more problems. Parasitic currents across the motor and the entire system can considerably affect the reliability of the whole system.

5.3.5 Bearing damage

A general distinction has to be made between two different physical occurrences:

- The shaft voltage (or rotor voltage) is an inductive voltage that is induced in the motor shaft owing to the differences in the flux densities of the stator and rotor. Above all, it is influenced by the length of the motor. As long as the lubricant film in the bearing is intact, the voltage builds up until, finally, a compensating current flows towards the earth. In this case, the path of least resistance is through the motor bearings. This bearing current (I_1), over a long period of time, usually results in drying of the bearings and thus failure of the motor. It is possible to counter this phenomenon to a certain degree through the use of ceramic bearings.

- The bearing voltage is an asymmetric (common-mode) voltage that occurs because of capacitive coupling between the motor housing, the stator and the rotor (C_1 , C_2 , C_3) and results in dv/dt and electrostatic discharge currents ($I_{dv/dt}$ and I_{EDM}) across the bearing (C_{Bearing} , U_{Bearing}). To be more accurate, this bearing voltage results in two different currents: in the first minutes of operation, as long as the lubricant in the bearing is cold, currents in the range of 5 to 200mA ($I_{dv/dt}$) flow through C_{Bearing} because of the dv/dt . These rather negligible currents generally do not result in any bearing damage. After a little while, when the lubricant film has heated up, peak currents of 5 to 10A and more can be measured (I_{EDM}). These flashovers leave behind small pits on the surface of the bearing. The running of the bearing becomes increasingly rough because of the damaged surface and the life is thus considerably shortened. Typically, the bearing voltage is between 10 and 30V. But since it is directly dependent on the mains supply voltage, bearing damage increases overproportionally at higher supply voltages.

In the case of unshielded motor cables, the cable capacitance (C_{Cable}) and hence the current (I_{Cable}) is relatively small. The parasitic capacitances on the inside of the motor dominate. Ideally, the parasitic currents flow through the motor housing to the ground (I_{C1}). However, if the grounding of the motor is inadequate, an additional impedance results (Imp.), which limits the current (I_{C1}). As a result of the additional impedance, the potentials at C_2 , C_3 and C_{Bearing} increase sharply. The values of the bearing currents also increase massively and flow fully through the bearings to the earth (I_{Bearing}); in that case, the life expectancy of the ball bearings, and hence of the entire motor, is reduced to a few hours.

5.3.6 Acoustic noise levels

Compared to the previously described problem cases, the whistling noises of the motor – caused by the switching frequency – would appear to be negligible. However, in applications related to heating, ventilation and air-conditioning technology (HVAC), in which the noise is distributed more intensely in the entire building through air ducts or heating pipes, this point has to be taken into account.

5.3.7 Solutions for output problems

For reasons of cost, time and space, an attempt is generally first made to manage without additional components. However, the subsequent costs that can result from motor or system failures are often entirely out of proportion to the

far lower initial costs of preventive interference suppression measures.

If the decision is made in favor of components to increase the reliability and operational safety, the following types have established themselves in the market:

- dv/dt chokes and filters (low inductance, hardly any reduction in the control dynamic)
- Motor chokes (increased inductance, better signal smoothing, but not universally applicable to controlled drives)
- Sinusoidal output filters (high L and C for optimizing the output signal, but also not universally applicable)

Traditional symmetric sinusoidal output filters – FN 5020, FN 5040, FN 5045. Traditional symmetric sinusoidal output filters are LC-low passes filters that convert the PWM signal of the frequency converter between the phases into a smooth sinusoidal curve. The residual ripple of the signal can be adjusted by using the values of the L and C. An optimum cost-benefit ratio is often reached at a ripple voltage of 3% to 5%.

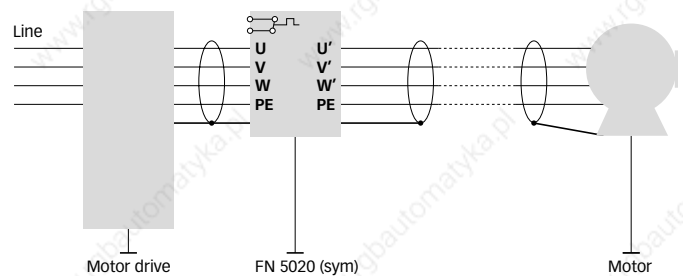

Drive with symmetrical sinusoidal filter

Symmetric sinusoidal output filters connected directly to the converter output have, above all, the following advantages:

- Complete protection of the motor from dv/dt and over-voltages
- Reduction of the additional magnetic losses and eddy current losses in the motor
- Reduction of the additional losses of the frequency converter owing to lower pulse currents to earth
- Reduction of the acoustic noise of the motor
- Reduction of the interference potential coming from shielded motor cables
- Increase in the reliability and operational safety of the overall system

For a large number of applications, this can be considered the ideal solution. Most problems are solved efficiently and in a cost-effective manner with the symmetric sinusoidal signal.

In some cases, additional measures are necessary. Symmetric sinusoidal filters, despite all their advantages, are not able to improve certain problem cases, since despite the filter, there is still a pulsed signal to earth. These problems are:

- Bearing damage
- Parasitic earth currents
- Necessity of shielded motor cables
- Limited maximum possible motor cable length

Sinus Plus symmetrical and asymmetrical sinusoidal output filter – FN 530, FN 5020 with additional module FN 5030.

Sinus Plus is a highly developed modular sinusoidal filter concept from Schaffner that is unique in the market today. Consisting of a traditional symmetric and an additional asymmetric sinusoidal filter module, it can be customized exactly to any requirement. Through innovative circuits and an additional connection to the DC link, the additional module is capable of sending the asymmetric interferences directly to the very place they originated.

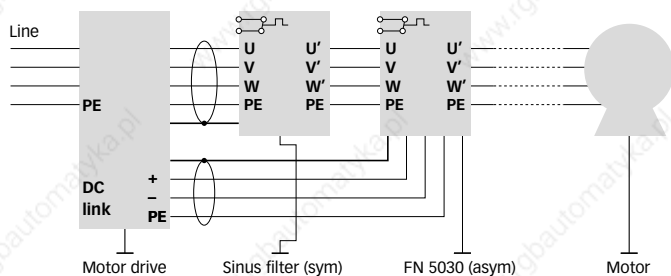

Drive with symmetrical and asymmetrical filter modules

This procedure is in keeping with the basic principle of interference suppression techniques: take the necessary measures at the source of the noise, not at the drain. Sinus Plus should always be considered to be a modular system in which the symmetrical filter part (FN 5020) can be connected autonomously but the asymmetric (FN 5030) may only be connected together with the symmetric module. FN 530 combines both solutions in one box. Operated in combination, this solution results in the following additional advantages:

- Complete elimination of bearing damage
- The possibility of using unshielded motor cables without any reductions in immunity
- Practically no more limitations with regard to the maximum cable length
- Almost complete elimination of the pulse currents to earth
- No interference influence of neighboring cables and equipment

- Elimination of the additional losses in the frequency converter
- Reduction in the suppression efforts on the input side. Since frequency converters are operated in ground-referred networks, every measure taken on the output side also influences the behavior on the input side (and vice versa). Since hardly any pulsed interference currents flow to the earth when Sinus Plus is used, the asymmetric part of the EMC mains input filter can be reduced, resulting in total cost savings.

II Annotations to filter specifications

1 Filter ratings

1.1 Electrical specifications

Where indicated, the component values in the datasheets are nominal values. The actual values can vary from the indicated ones based on the electrical tolerances given by the manufacturers. The test conditions for the components are listed below.

Tolerances and test conditions for passive components

Parameter	- Tolerance	+ Tolerance	Test
Inductance	30%	50%	1kHz
Capacitance	20%	20%	1kHz
Resistance	10%	10%	DC

1.1.1 Current

Current ratings of EMI filters are determined by the individual filter components. Since current flow leads to a temperature rise in passive components, the ambient temperature of the environment where the filter is to be used has a direct impact on the rated current.

The nominal currents stated for our components refer to an ambient temperature of $\theta_N = 40^\circ\text{C}$ or $\theta_N = 50^\circ\text{C}$ as indicated on the component and in this catalog. The maximum operating current at any other ambient temperature θ can be calculated by means of the following formula:

$$I = I_N \cdot \sqrt{\frac{\theta_{\max} - \theta_{\text{act}}}{\theta_{\max} - \theta_N}}$$

where I_N rated current at θ_N
 θ_{act} actual ambient temperature
 θ_N temperature at which the rated current is defined
 θ_{\max} rated maximum temperature of the component

If a filter with $I_N = 7\text{A}$ at $\theta_N = 50^\circ\text{C}$ and a rated maximum temperature of $\theta_{\max} = 100^\circ\text{C}$ is to be used at an ambient temperature of $\theta_{\text{act}} = 65^\circ\text{C}$, the rated current of this filter must be reduced to $I_{N,65^\circ\text{C}} = 5.9\text{A}$.

The actual current may also exceed the nominal current for a certain period of time. The exact specifications are given in the datasheet for each product.

1.1.2 Voltage

When looking at voltage ratings, care needs to be taken not to confuse the voltage rating of the filter with the nominal voltage of the power grid.

The most common nominal voltages are defined in IEC 60038. A European power grid, for example, has a defined nominal voltage of $230\text{V} \pm 10\%$. The maximum voltage at the terminals can therefore be $230\text{V} + 10\% = 253\text{V}$.

The rated voltage of the filter defines the maximum continuous operating voltage, i.e., the maximum voltage at which the filter should be used continuously. Short overvoltages are permitted in accordance with IEC 60939, but to avoid damage to the filter capacitors, the continuous voltage should not exceed the rated voltage for an extended period of time.

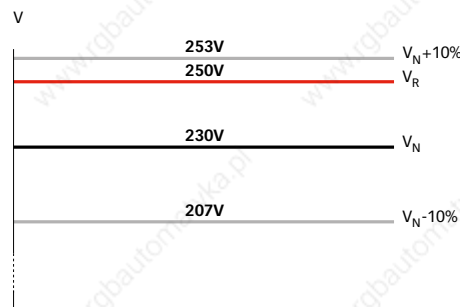

V_N Nominal grid voltage V_R Rated filter voltage
 Relation between nominal and rated voltage

The nominal voltage +10% can exceed the rated voltage of the filter, as shown in the graph above. It is important to note that the nominal voltage of power grids is supposed to be at the defined value and within the boundaries of $\pm 10\%$ but not continuously at one of the limiting values. It is therefore safe to say that a power network in Europe will not run continuously at 253V.

The voltage rating is usually given for a supply frequency of 50/60Hz. If the filter is operated at higher frequencies (e.g., 400Hz), the voltage must be derated. This is also described in the following chapter.

The rated voltage of three-phase filters indicated on labels, in datasheets or catalogues sometimes lead to confusion when only one voltage value is stated, i.e. 480VAC. This value always has to be understood as phase-to-phase voltage. The respective phase-to-neutral voltage is $1/\sqrt{3}$ times

this value, i.e. $480\text{VAC}/\sqrt{3} = 277\text{VAC}$.

The rated voltage of newer products indicated for both, phase-to-phase voltage and phase-to-neutral voltage respectively, stating i.e. 480/277VAC.

1.1.3 Frequency

Depending on the type of filter, three different frequencies can be defined.

Supply frequency. The frequency of the AC mains supply network, typically 50 or 60Hz. The operating frequency of the filter is determined by the behavior of the capacitors. Depending on the voltage-frequency characteristic of the capacitor, it might be possible to operate a filter at a higher frequency but with a reduced input voltage.

Switching frequency. The frequency used to switch the IGBTs in the output stage of a frequency converter or SMPS. This frequency has a direct relation to the power loss in the converter and in the output components. Generally speaking, lower frequencies result in lower losses. For an output filter, it is also necessary to consider the relation between the switching frequency and the resonance frequency of the filter. Our filters are always designed in such a way that the resonance frequency is at least 2.5 times lower than the lowest switching frequency.

Motor frequency. The simulated supply frequency of the frequency converter. This frequency determines the rotational speed of the motor. Most applications operate at 50/60Hz motor fields, but applications with higher rotational speeds also exist (high-speed spindle drives up to 2000Hz).

1.1.4 DC resistance

The DC resistance of the filter is the resistance measured at the relevant power network frequency, i.e., 50Hz for European applications and at a defined temperature, such as 25°C.

1.1.5 Discharge resistors

Discharge resistors are connected across the filter capacitors to avoid electrical charges at the terminals of the filter after the filter has been disconnected. Failure to do so can

be lethal, and discharge resistors are therefore a safety standards requirement. Generally, high-value resistors are used to slowly discharge the capacitor after disconnection.

If a filter is to be used in IT power networks (see “Power distribution networks” chapter), discharge resistors are not recommended. In IT networks the insulation of the power system is usually monitored in order to detect initial fault conditions. Discharge resistors can interfere with the monitoring equipment and indicate fault conditions where none exist.

1.1.6 MTBF

The MTBF (mean time between failures) is the reciprocal value of the failure rate. The failure rate indicates the statistical percentage of units failing over a certain amount of time. The MTBF will thus change over time, because the reliability of a product decreases as components age. The MTBF in our catalogs is calculated according to MIL-HB-217F.

The MTBF should not be confused with the lifetime of a product. It is instead an indication for the reliability – that is, for the probability of failure in the field. As an illustrative example, we could look at the airbag in a car. The MTBF has to be very high, because the airbag should deploy when needed, even if the car is more than 20 years old. The lifetime of the airbag, however, is short: the deployment takes seconds and then the lifetime is over.

1.2 Mechanical specifications

1.2.1 Mechanical tolerances

The mechanical tolerances in our drawings are given in accordance with EN 22768-2 (ISO 2768-2). All measures in a mechanical drawing should have defined tolerances. Instead of defining each individual tolerance, it is sufficient to give a reference to the tolerance classes of the above-mentioned standard. The general tolerances are defined in categories “fine,” “medium,” “coarse” and “very coarse.” The table below shows the actual tolerance measures according to these categories.

Mechanical tolerances



Category	Rated measure in mm							
	≥ 0.5	> 3	> 6	> 30	> 120	> 400	> 1000	> 2000
	... 3	... 6	... 30	... 120	... 400	... 1000	... 2000	... 4000
Category	Tolerance measure in mm							
f (fine)	±0.05	±0.05	±0.1	±0.15	±0.2	±0.3	±0.5	–
m (medium)	±0.1	±0.1	±0.2	±0.3	±0.5	±0.8	±1.2	±2
c (coarse)	±0.2	±0.3	±0.5	±0.8	±1.2	±2	±3	±4
v (very coarse)	–	±0.5	±1	±1.5	±2.5	±4	±6	±8

1.2.2 Filter terminals and cable cross-sections

Schaffner filters can be equipped with a number of different standard connectors. Below is an overview of all standard

connection types available. Upon request, filters can also be built with other popular connection types. Please contact your nearest Schaffner office for more details.

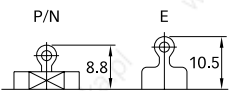
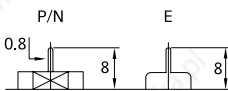
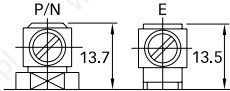
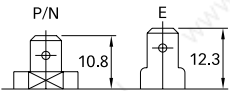
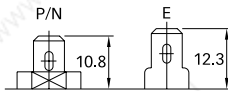
Terminals and connection types

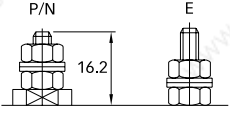
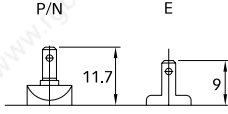
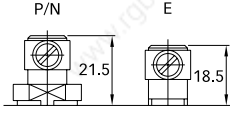
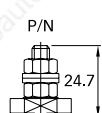
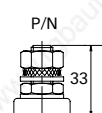
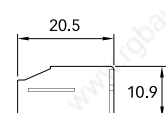
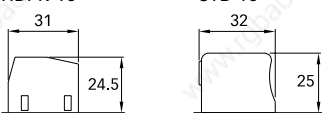
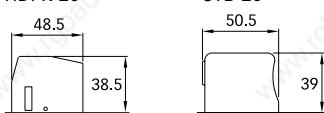
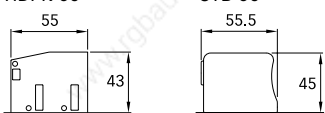
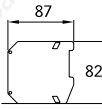
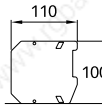
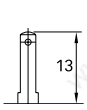
Type -01	Type -02	Type -03
Solder lug with a hole capable of accommodating several small wires	Pin suitable for direct assembly onto through-hole printed circuit boards	Clamp terminal with M4 screw Recommended torque: 1 - 1.3Nm
		
Type -05	Type -06	Type -07
Industry-standard size faston terminal 6.3 x 0.8mm	Industry-standard size faston, which may also be used as a solder lug 6.3 x 0.8mm	Insulated wire, stripped ready for soldering. Wire gauge varies according to filter
		
Type -08, -09, -10	Type -13	Type -23
08: M4 screw (1.3Nm) 09: M5 screw (2.2Nm) 10: UNC 8-32 screw (1.3Nm)	Faston, 2.8 x 0.5mm	Clamp terminal with M5 screw Recommended torque: 1.8 - 2.2Nm
		
Type -24	Type -28	Type -29
M6 screw lead-through Recommended torque: 3.5 - 4Nm	M10 screw lead-through Recommended torque: 15 - 17Nm	Safety terminal block for solid wire 6mm ² , flex wire 4mm ² or AWG 10 Recommended torque: 0.7 - 0.8Nm
		
Type -33	Type -34	Type -35
Safety terminal block for solid wire 16mm ² , flex wire 10mm ² or AWG 6 Recommended torque: 1.5 - 1.8Nm	Safety terminal block for solid wire 35mm ² , flex wire 25mm ² or AWG 2 Recommended torque: 4 - 4.5Nm	Safety terminal block for solid and flex wire 50mm ² or AWG 1/0 Recommended torque: 7 - 8Nm
<p>HDFK 10 STB 10</p> 	<p>HDFK 25 STB 25</p> 	<p>HDFK 50 STB 50</p> 
Type -36	Type -37	Type -16, -38
Safety terminal block for 95mm ² or AWG 4/0 cables Recommended torque: 20Nm	Safety terminal block for 150mm ² or AWG 6/0 cables Recommended torque: 30Nm	16: Solder/faston, 2.8 x 0.5mm 38: Faston, 2.8 x 0.8mm
		

Type -40

Safety terminal block for solid and flex wire
95mm² or AWG 4/0
Recommended torque: 17 - 20Nm

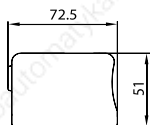

Type -44

Safety terminal block for solid wire 10mm²,
flex wire 6mm² or AWG 8
Recommended torque: 1.5 - 1.8Nm

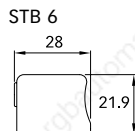

Type -47

Strip terminal block for solid wire 16mm²,
flex wire 10mm² or AWG 8
Recommended torque: 1.9 - 2.2Nm

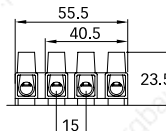

Type -53

Safety terminal block for solid and flex wire
16mm² or AWG 4
Recommended torque: 2 - 2.3Nm

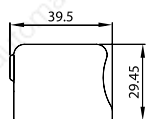

Type -71

M4 screw terminal for ring/fork lug
self-lifting
Recommended torque: 1 - 1.2Nm

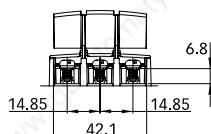

Type -72

M5 screw terminal for ring/fork lug
self-lifting
Recommended torque: 1.9 - 2.2Nm

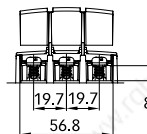

Type -99*

High current terminal for flex wire 150mm²
or AWG 6/0
Recommended torque: 27 - 30Nm

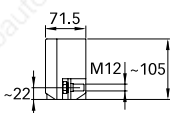

* Specification for FN 3100-300-99 only. Other -99 specifications (FN 2200, FN 3270, FN 3359, FN 3410, FN 3412) can be found on the individual product data sheets.

Below is a reference list showing the relation between the AWG number of connectors and the corresponding copper cross section of the wire.

AWG and metric cable specifications

AWG number	Cu mm ²
22	0.33
20	0.54
18	0.83
16	1.34
14	2.15
12	3.44
11	4.17
10	5.26
9	6.63
8	8.37
7	10.5
6	13.3

1.2.3 Torque specifications

The torque specifications in the table above are given to guarantee proper connections and avoid destruction of the terminals. They should be complied with at all times.

1.3 Environmental requirements

1.3.1 RoHS

With the adoption of EU Directive 2002/95/EC, the use of certain hazardous chemical substances is prohibited. Effective July 1, 2006, no new electric or electronic equipment may contain any of the following banned substances:

- a) Lead (Pb)
- b) Hexavalent chromium (Cr(VI))
- c) Mercury (Hg)
- d) PBB (polybrominated biphenyls) and PBDE (polybrominated diphenyl ethers)
- e) Cadmium (Cd)

As complete elimination of the banned substances is impossible, an EU Commission Decision of August 18, 2005 (2005/618/EC) tolerates certain maximum concentrations. These tolerances, defined by weight in homogenous materials, are:

- ≤0.1 weight % for a, b, c, d
- ≤0.01 weight % for e

The following exceptions are applicable as listed in the Annex of Directive 2002/95/EC:

- Lead as an alloying element
 - in steel containing up to 0.35% lead by weight
 - in aluminum containing up to 0.4% lead by weight
 - in copper alloy containing up to 4% lead by weight
- Lead in glass of electronic components

As a global enterprise, the Schaffner Group designs and manufactures products in accordance with this legislation. We see the need for implementation and compliance as a key element of our business activity and, whenever possible, we strive to achieve concentration levels below the maximum tolerances.

Schaffner uses the following labels to identify RoHS-compliant or lead-free products in documents and on its website:



Labels for RoHS and lead-free compliance

1.3.2 Vibration and bump testing

Our filters are typically specified to maintain their characteristics when properly mounted after being subjected to a vibration test consisting of a sinusoidal sweep from 10Hz to 55Hz and back to 10Hz for a duration of 120 minutes. The test is applied in the main axes and a deviation of $\pm 0.75\text{mm}$ or 10g is used. Vibration testing is performed in accordance with the standard IEC 60068-2-6.

The filters will also maintain their characteristics after being subjected to the following bump test: 1000 bumps of 10g, applied for 16ms in three axes appropriate to the mounting instructions. The relevant testing standard is the IEC 60068-2-29.

1.3.3 Climatic classification

All components have to work in defined climatic conditions. IEC 60068-1 defines climatic categories and the relevant testing methods. Typically, the climatic category is indicated by three numbers separated by slashes as shown below.

25/100/21

25	Test A: cold (lower category temperature) -25°C (in accordance with IEC 60068-2-1)
100	Test B: dry heat (upper category temperature) 100°C (in accordance with 60068-2-2)
21	Test C: damp heat (duration of test) 21 days (in accordance with IEC 60068-2-78)

For environments where the standard specifications are not sufficient (e.g., military) Schaffner can also offer custom-made solutions with extended environmental specifications.

2 Safety requirements

Most filters are connected in the mains supply line to the power supply system, making them the object of safety-related concerns. A number of items have to be considered during the design of a filter.

2.1 Type testing

Type testing is performed with an initial sample in order to verify the safety-relevant specifications for the design. All type testing is performed in accordance with the relevant safety standards. For some tests, the discharge resistors have been removed for type testing. This is in accordance with the relevant testing specification.

When the filter is built into equipment and type testing is performed for the final equipment, the following points should be considered:

- Some tests might overstress the discharge resistors and lead to their destruction.
- In some cases, the equipment requires the measurement of the insulation resistance (e.g., EN 60204). This measurement cannot be performed with discharge resistors.

In special cases, samples without discharge resistors can be provided. Please contact your nearest Schaffner representative for details.

2.2 Hipot testing

In filters we use components that are connected between the phases of the supply network or between one phase and earth. It is therefore important to determine how well filters resist high voltages. A high-voltage test, often called hipot test, is performed for this reason by applying a voltage between enclosure and phase or between two connectors for a defined time. The current flowing between the same points is measured. Current flow means that the insulation is broken; the equipment fails the test.

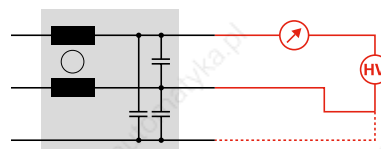

Testing principle of high-voltage testing

During approval procedures, the test is usually performed over a longer period (typically one minute) with a defined voltage. Many safety standards require the testing to be performed on 100% of all units, but to save time, a test with higher voltage but reduced time is accepted. It should be noted that repeated high-voltage testing can lead to a damage of the insulation.

The testing voltages used for 100% testing are indicated in the individual datasheets. Please note that hipot tests are high-stress tests for the capacitors inside the filter. Each additional test stresses the capacitors again and leads to a reduction of lifetime. Schaffner recommends keeping the number of hipot tests to a minimum and never testing the filters at higher than the indicated voltages.

2.3 Leakage currents

During normal operation of electrical equipment, some current flows along the protective earth conductor towards earth. Such currents, called leakage currents, pose a potential safety risk to the user and are therefore limited by most current product safety standards. Examples for these standards are EN 60950-1 for information technology equipment or UL 1283 for passive EMI filters. The standards include limits for the maximum allowed leakage current.

In most installations today we find residual current breakers or leakage-current breakers to protect against high leakage currents. Typical tripping values for these breakers are 30mA where personal protection is the main goal and 500mA for protection against fire.

For equipment that can by definition not meet these limits, additional provisions are required-for example, attaching special warning labels.

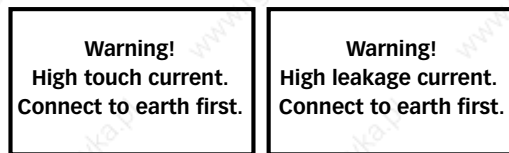

Warning labels for increased leakage currents

For passive EMI filters it is common to calculate the leakage currents based on the capacitor values against earth and other parasitic components. The following figure shows a typical capacitor configuration. In the case of a balanced capacitor network, the leakage currents will be negligible. On the other hand, the leakage currents will reach the maximum value at the highest imbalance between the phases. Causes

for the imbalance are the tolerances of the capacitor values as well as the voltage imbalance in the supply network.

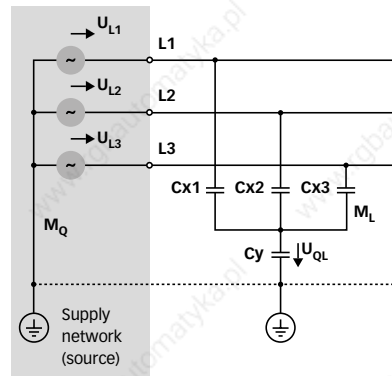

Typical capacitor configuration in three-phase filters

Most capacitors in passive filters are rated by the manufacturers with a tolerance of $\pm 20\%$. The highest voltage drop at Cy occurs when two of the X-capacitors show the lowest tolerance values and one shows the highest. In addition, Cy is assumed at its highest tolerance value. To put a good picture to the theory, a sample calculation can be performed with a 480V three-phase filter. The capacitor values are given at $C_x = 4.4\mu\text{F}$ and $C_y = 1.8\mu\text{F}$; the tolerances for all capacitors are $\pm 20\%$ according to the manufacturer. Not considering the supply voltage imbalance, the leakage current is calculated as approximately 25mA.

Practical experience shows that the tolerances of capacitors are never spread that widely. An assumed tolerance range from -20% to 0% seems more realistic. Using this assumption in the calculation above results in a leakage current of only about 10mA. It should be pointed out, though, that there is no agreement between filter manufacturers regarding the calculation method for leakage currents in filters. It is therefore perfectly possible to have differing leakage currents in two filters, even though the circuit diagrams and component values are identical.

Up to this point, the voltage imbalance of the supply network was not figured into the calculation. In practical application, supply networks do have a certain imbalance. To include this in the calculation, we use the supply network standard EN 50160, which defines the conditions in public power supply networks. According to this standard, the voltage imbalance for regional networks can be up to 3%. Using this in the previous calculation, the leakage current now adds up to 26mA for a capacitor tolerance of $\pm 20\%$ and 15mA for +0/-20%.

Compared to three-phase networks, the calculation of leakage currents in single-phase networks is significantly easier. With

a given supply voltage and frequency, the leakage current depends solely on the total capacitance. The following figure shows the typical capacitor circuit for single-phase filters.

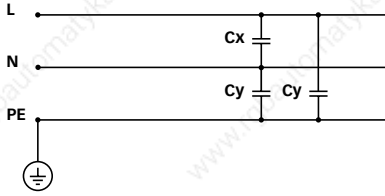

Typical capacitor configuration for single-phase filters

For a filter with $C_x = 100\text{nF}$ and $C_y = 2.2\text{nF}$ and a given tolerance of $\pm 20\%$, the leakage currents come to $190\mu\text{A}$. The worst-case scenario is given if the neutral conductor is interrupted. The total capacitance then consists of two parallel capacitors: C_{yL} on the one hand and the series connection of C_x and C_{yN} on the other. The following figure shows the equivalent circuit.

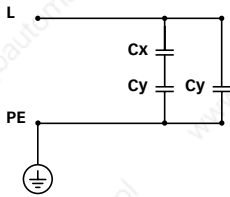

Total capacitance with interruption of neutral

For fault conditions, the maximum leakage current can be as high as $377\mu\text{A}$.

It was already mentioned that the leakage current is lowest when the supply network and the capacitor network are balanced. Every imbalance increases the leakage current. With this in mind, it is also obvious that the supply network topology must have a significant influence on the amount of leakage current from equipment. The network topologies are explained in the “Power distribution networks” chapter. Another potential source of imbalance problems is the moment when equipment is switched on.

Test criteria for UL flammability classes

Criteria conditions	V-0	V-1	V-2
Afterflame time for each individual specimen t_1 or t_2	10s	30s	30s
Total afterflame time for any condition set (t_1 plus t_2 for the five specimens)	50s	250s	250s
Afterflame plus afterglow time for each individual specimen after the second flame application ($t_2 + t_3$)	30s	60s	60s
Afterflame or afterglow of any specimen up to the holding clamp	No	No	No
Cotton indicator ignited by flaming particles or drops	No	No	Yes

2.4 Flammability classification

The American approval agency UL requires flammability tests for all plastic materials used in devices and appliances to ensure that the material cannot burn in case of malfunction of the equipment. The exact requirements are defined in the standard UL 94.

During the tests, a specimen of the plastic material is exposed twice to an open flame. The exact specifications are given in the above-mentioned standard. During the test the following items are observed:

- Afterflame time after first flame application, t_1
- Afterflame time after second flame application, t_2
- Afterglow time after second flame application, t_3
- Whether or not specimens burn up to the holding clamp
- Whether or not specimens drip flaming particles that ignite the cotton indicator

Based on the results, the material is then classified as shown in the table below.

2.5 Fuses

All filters with fuse holders are delivered without fuses due to the variety of fuses in different local markets. Below you’ll find a brief recommendation regarding fuses.

The maximum rated current in the specification is not always the fuse value required by our customers. Users should also consider the current rating in relation to the ambient temperature. A fuse needs to be selected by the user depending on ambient temperature, tripping rating, acting behavior (fast, medium, slow) and other electrical specifications. Fuse holders are designed to hold cartridge fuses with $5 \times 20\text{mm}$ for Europe and $6.3 \times 32\text{mm}$ for the USA. Please refer to the product datasheet to see the kind of fuse supported by a particular model.

Custom filters can be equipped and delivered with fuses. If you wish to buy IEC filter modules with pre-mounted fuses, please contact your local Schaffner sales office.

3 Power distribution networks

3.1 Designation of networks

Throughout the world we find a variety of different power distribution networks. The most common ones are defined in IEC 60364-1. The constellation of the power network often has an impact on the filter performance, and some filters are even designed for specific networks to ensure maximum performance at the highest reliability level. The distribution networks are designated using the following codes:

AB (-C -D)

A	Grounding condition of the supply I: insulated T: grounded
B	Connection of the installation N: connected to PE T: grounded directly
C	Connection of N and PE C: connected S: separated
D	Indication that part of the system has separate N and PE lines

Example: TN-C-S: Grounded supply network where the installation is connected to PE. PE and N are combined to a PEN conductor, but in parts of the network there are also separate PE and N lines.

3.2 TN network

In TN networks one point of the distribution system is directly connected to ground. Each installation in the systems is connected to this common grounding point via the PE conductor. There are three different variations of TN networks

3.2.1 TN-S system

The S indicates that there must be a separate PE conductor throughout the whole system. The figures below show the possible configurations.

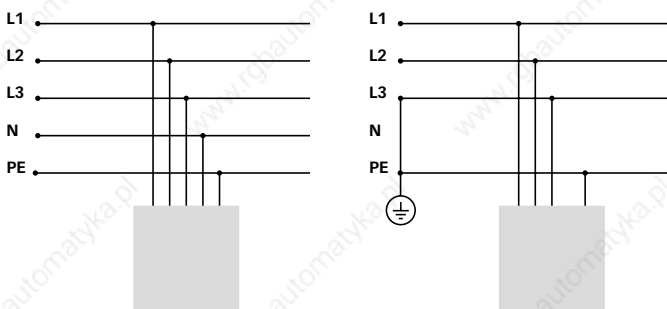

TN-S distribution networks

3.2.2 TN-C and TN-C-S systems

In TN-C systems the protective earth connector and neutral line are combined into one conductor. For a pure TN-C system this is done throughout the system. A system where PE and N are separated in some parts only is called TN-C-S.

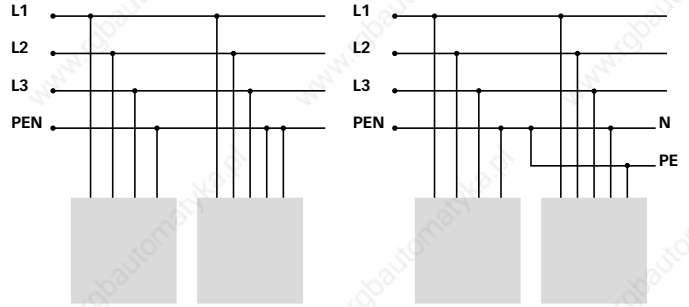

TN-C (left) and TN-C-S (right) distribution networks

3.3 TT network

In a TT system the ground points for the system and the installations are electrically separated. Both parts are grounded directly and independently.

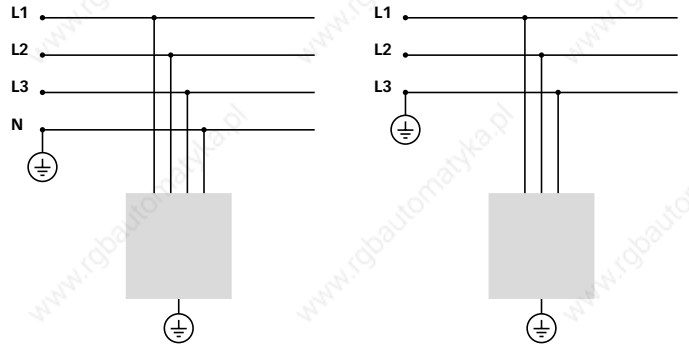

TT distribution networks

3.4 IT network

In an IT system there are two possibilities: either all active parts are separated from ground, or one point of the system is grounded via a defined high impedance (R_{GND}).

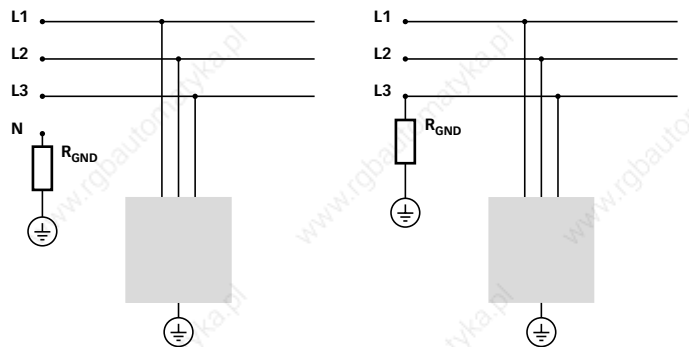

IT distribution networks

The setup comes with a number of special issues to be considered when using filters. For power networks one always considers the first-fault condition, where one phase is short-circuited to ground. The advantage of an IT system lies in the fact that in such a fault condition the risk of high touch currents is negligible. Inside of the filter, however, the voltage across the capacitors will increase significantly. If the filter is not specifically designed for IT networks, there is a good risk of destruction of the capacitors in the case of a network first fault.

An IT network with a single fault turns into a TN system, but with increased phase voltages. It continues to function, but for safety reasons the first fault should be repaired as quickly as possible. In IT networks, therefore, the insulation of the phases against earth is constantly monitored. If additional resistors are connected between line and earth inside connected equipment, the monitoring system is influenced and might detect non-existing faults. As a result, discharge resistors are not permitted in filters in systems for IT distribution networks.

Schaffner offers a variety of filters especially designed for IT networks, such as FN 258HVIT and FN 3359HV. For more details, please consult the datasheets for the products.

3.5 Network with one grounded phase

Some regions, such as Japan, utilize a power distribution network where one phase is directly earthed.

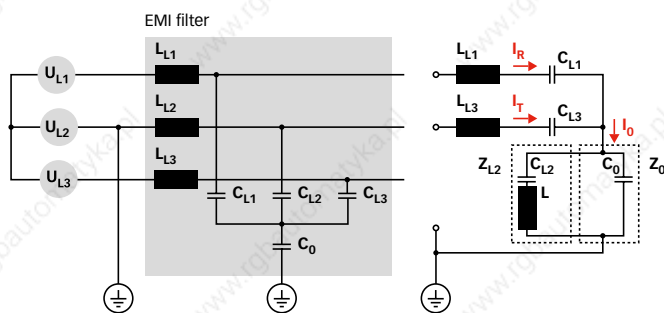

Power network with grounded phase and filter (left) and equivalent circuit (right)

With this arrangement the impedance towards earth is completely changed, resulting in different voltage drops and leakage currents. The outcome of this is that the standard rating for leakage currents cannot automatically be applied for networks with a grounded phase.

For such applications, Schaffner also offers a dedicated range of products in this catalog. Please consult the datasheets for more information. Further products for the Japanese market are available. Please contact your local Schaffner vendor for more details.

4 Installation instructions

While EMI filters are a proven measure to ensure compliance of products with EMC requirements, they can only be effective if properly installed. Not only is the filter installation itself of utmost importance, however. The planning and implementation of other EMC measures and design rules also contributes to good performance in terms of noise emission.

Where available, manufacturers should always refer to the installation instructions when installing filters. Further information about installation is also available at www.schaffner.com.

4.1 Installation of filters

The intention of using filters is to prevent unwanted signals from entering a certain electrical area. In order to do so, the filter should be installed as close as possible to that area. The connection between the filter and source circuit should be kept as short as possible.

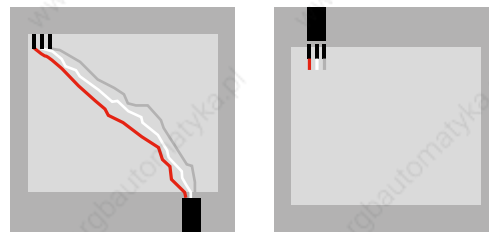

Improper (left) and correct (right) placement of filters

Installations as shown in the left figure above should be avoided whenever possible. Even though the connection between the filter and protected circuit is the shortest possible due to the filter design, the cables from the filter to the printed board take the longest possible way inside the enclosure. They can therefore pick up all signals along the board and radiate them like an antenna, thus working as an unwanted interference source. If the connection is kept short, the interference from the board is eliminated at the source while at the same time keeping the distance between AC supply and filter short. The filter will show its maximum effect under these circumstances.

Even more important than the filter position is its connection to ground. Proper grounding is essential for the operation of a filter. Without ground connection, the filter is floating and loses its common-mode attenuation provided by the Y-capacitors. One of the most common problems with grounding is the installation of filters by directly attaching

them to enclosures with painted or otherwise treated surfaces, in that way interrupting the ground connection and leaving the filter almost useless. To avoid this problem, the part of the surface where the filter will be installed should be abraded.

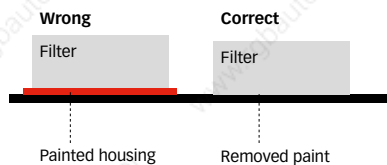

Proper ground connection of filters

Abrasion of enclosures, however, is not always an option.

Depending on the ambient conditions, surface treatment might be a requirement to avoid corrosion, and conductive coatings might not be available.

When the ground connection is done, care should be taken to have as big a connection area as possible. It is a common misconception that the conventional PE wire will be sufficient for RF grounding purposes. Instead, flat wires should be preferred over round ones and braided wires over solid ones. The flat wire should be connected plainly on both the filter and the ground connection side in order to ensure proper filtering.

4.2 Cable connection and routing

It is said that in an EMC concept the filter contributes about 50% of the total performance. The remaining 50% is achieved through proper EMC design. Two issues are of special importance in this context: the connection of shielded cables and the cable routing inside of equipment.

4.2.1 Shield connections

Shield connections have already been discussed in a previous chapter. Once again, it is important to connect the shield ends of shielded cables on both sides of the cable with the best possible means. The ideal case would be 360° connections on both sides.

4.2.2 Cable routing

Whenever cables are left longer than necessary or routed close to each other, additional antennas and coupling areas are created. The result is often a short-circuit of the noise suppression components, and the attempt to reduce noise fails not because of the suppression component but because of the cabling.

To improve the situation, cables should be shortened to the necessary length and routed in defined ways. Where cable

crossings cannot be avoided, a 90° crossing should be used for maximum decoupling. To avoid an EMI short circuit of the filter, special care should be taken never to cross input and output cables of a filter.

4.3 EMC planning

EMC should always go hand in hand with the general design of the product. From the very beginning, designers should consider which noise sources and susceptible circuits they have in their equipment. This makes it possible to physically separate them and avoid problems right from the start rather than having to fight them later.

Next, the cabling should be considered, keeping in mind the recommendation from the previous chapter. It is much easier to plan the cable layout first rather than having to modify it at a later stage. Finally, the filtering components should be planned in as well. Filters are not added at the end to get rid of a problem, they are an integral part of the overall EMC design of a product.

A filter should be located as close to the noise source as possible. When using drive filters, the filter should be placed close to the drive, or in some mechanical designs even under the drive. Mains filters are placed as close to the power inlet as is feasible.

When using filters or reactors, one should always consider the heat dissipation from the filtering component. To avoid overheating, leave sufficient space around the component and ensure air circulation.

Schaffner can support manufacturers with their EMC layout from the early stages of new product ideas or designs. Contact your nearest Schaffner representative for more information.

III Typical applications

1 Choke applications

1.1 Current-compensated chokes (RN, RD and EV/EH series)

These chokes are used to attenuate common-mode or asymmetric (P/N → E) interference signals by being connected in series with the phase and neutral lines of an AC power line input. The magnetic fields produced by this winding technique cancel each other out. Full inductance is only presented to interference signals that flow asymmetrically from phase/neutral to earth.

Symmetrical components of the noise are also attenuated by the leakage inductance of the windings. The impedance of the choke at power line frequencies is therefore negligible, resulting in practically zero voltage drop. Current-compensated chokes are used with multiple windings to avoid saturation (loss of effective inductance). An efficient inductor-capacitor combination to protect against line-conducted interference consists of:

- Series inductances in the interference paths
- Cx capacitors between phase and neutral
- Cy capacitors between phases and earth

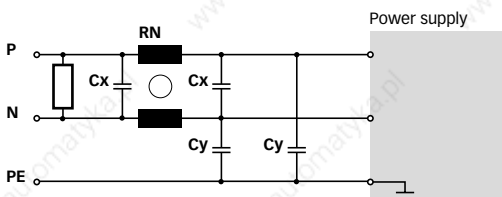

Basic power line filter to remove common and differential-mode noise, based on a current-compensated choke

- In phase-angle control circuits where the desired degree of suppression cannot be achieved by saturating chokes alone
- For suppressing high interference levels from ultrasonic generators, fast rectifiers, switched mains equipment etc.
- For suppressing equipment with no earth connection
- For input filters to protect digital circuitry from mains-borne interference

1.2 Saturating chokes (RI types)

These chokes change impedance at the moment of switching and can be used to attenuate differential-mode or symmetrical (P → N) interference as generated by phase angle control devices such as thyristors and triacs. Interference

levels can be brought within the limits of national and international regulations by using these chokes in conjunction with appropriate suppression capacitors. For optimum attenuation, chokes must be connected as close as possible to the semiconductor switching device. A simple single-stage suppression circuit is shown in the following illustration; this can be made into a dual-stage filter by the load itself and one additional capacitor.

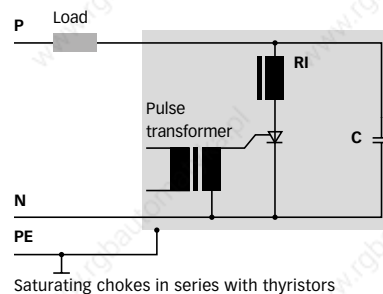

2 Power supply applications.

The number of switch-mode power supplies (SMPSs) in electrical and electronic equipment is steadily increasing. They are used not only in traditional applications, such as computers, but also in a growing number of consumer products. At the same time the switching speed of the power supplies is becoming faster, in order to minimize the volume of magnetic devices for the PFC and transformer and to reduce the overall size of the power supply.

While the operational advantages of SMPSs are unquestionable, the negative impacts are becoming increasingly obvious. On the one hand there is an increase in the harmonic distortion of the power networks, which has already resulted in new versions of the relevant standard IEC 61000-3-2. Single-phase harmonic distortion can be eliminated by using front-end power factor correction technologies or harmonic chokes. On the other hand the noise emission due to the high switching frequency is becoming harder to control. Schaffner EMC single-phase filters or IEC inlet filters are designed to minimize EMC emissions from switch-mode power supplies.

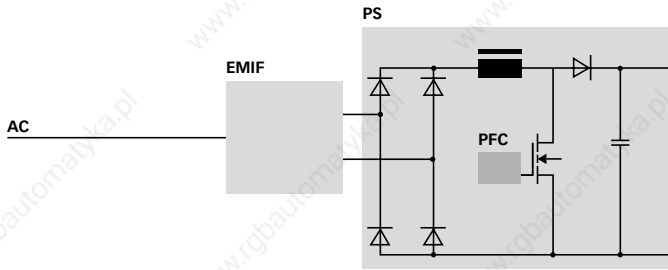

EMIF EMI filter
PS Switch-mode power supply

PFC PFC control

Single-phase power line filter with SMPS to remove common and differential-mode noise

Linear power supplies do not generate EMC noise in the same way as switch-mode power supplies. The majority of EMC noise in a system with a linear power supply is a result of the load behavior and, nowadays, the driving digital logic. Single-phase EMC filters or IEC inlet filters help to reduce the EMC emissions to an acceptable level. Additionally the system immunity will be increased to protect against EMC noise from the grid.

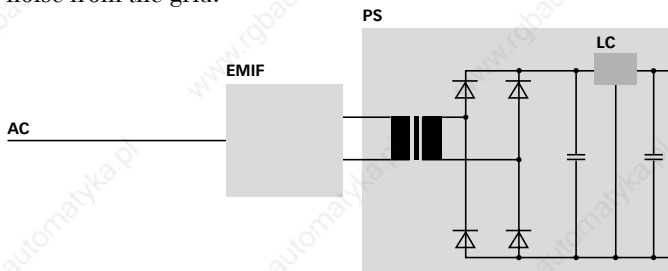

EMIF EMI filter
PS Linear power supply

LC Linear control

Typical linear power supply application with EMC line filter

2.1 Single-phase filters

These are the key element in eliminating system-generated and mains-borne interference. One of the biggest advantages of using a single-phase filter is the rapid availability of the associated safety approvals.

Single-phase filters are used in a wide range of applications, such as control panels, systems, equipment and apparatus, together with power supplies or other electrical functions.



FC Fixed power cord
EMIF EMI filter
EQ Equipment, e.g. switch-mode power supply



Schaffner single-phase filter FN 2030

2.2 IEC inlet filters

IEC inlet filters with a standard IEC connector are a practical solution when you need to meet the requirements of different country-specific mains plugs. The EMC filter function protects your system and suppresses EMI noise while the IEC connector allows you to equip your system with a standard connector to fit country-specific mains cords. The compact dimensions and supplementary options, such as a mains switch, fuse holder or voltage selector, offer numerous advantages to the user. IEC inlet filters are used in a broad variety of applications, typically in conjunction with a power supply. IEC inlet filters with an integrated voltage selector allow country-specific voltages to be selected in linear power supply designs.

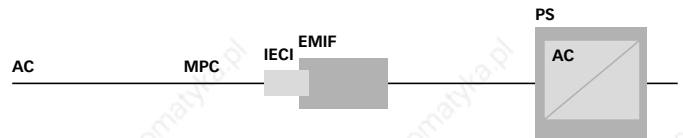

MPC Mains power cord with regional plug
IECI IEC inlet plug/connector
EMIF EMI filter
PS Power supply

IEC inlets can be used in test and measurement equipment, medical equipment, consumer goods, power supplies and in various other electrical and electronic applications.



Schaffner IEC inlet filter FN 280 with fuses and switch

3 Medical applications

Medical applications sometimes require special EMI filters. Depending on the environment and the use to which the medical equipment is put, the EMC filter may vary significantly from a standard product. Medical electrical equipment or in-vitro diagnostic medical devices have different requirements for leakage current, air and creepage clearances and test voltage, amongst other things. For medical

devices with higher safety levels, in accordance with IEC/EN 60601-1, Schaffner offers medical grade versions (B type) of many of its filters, with a lower leakage current, increased air and creepage clearance, discharge resistor and higher test voltage. These filters are available as single-phase or IEC inlet filters, as well as for special three-phase applications.

4 Test and measurement equipment

Test and measurement equipment involves a wide variety of applications. These range from the filter requirements for a power supply through to systems which include power supplies, motors, drives, valves etc. Depending on the requirements, you can select the most appropriate filter from a broad range of single-phase and three-phase filter products.

5 Motor drive applications

A power drive system acts as a converter of electrical energy into mechanical energy. The inverter within the system is commonly used because of its simplicity. However, inverters are well known EMI sources in many industrial applications as well as an increasing number of consumer products. The power frequency of the supply network is normally 50Hz or 60Hz. The inverter can actually vary the speed of the output frequency from 0Hz to several 100Hz or >1kHz, depending on the application.

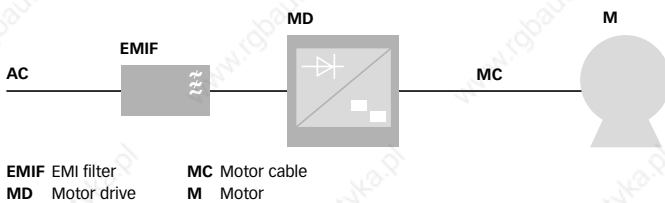

Example of a power drive system

The supply voltage is rectified in the converter section. This section consists of a set of diodes, usually six for a three-phase bridge and four for a single-phase bridge. The DC link consists of a DC capacitor, which stores the rectified energy and releases this energy into the power switching stage. This stage is usually a bank of six transistors. In the example below, the power transistors consist of Insulated Gate Bipolar Transistors (IGBT). The fast-power semiconductors chop the DC voltage into a square wave voltage at the carrier frequency. Control circuits regulate the square wave pause/pulse ratio and generate a three-phase voltage with adjustable power frequency to vary the motor speed. This control mechanism is called Pulse Width Modulation (PWM).

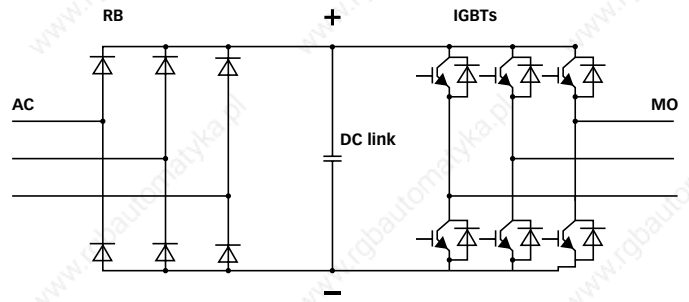

RB Rectifier bridge
IGBTs Insulated gate bipolar transistors
MO Motor output
Rectifier bridge in a frequency converter

This high frequency switching will cause EMI. Noise from the output motor cable as well as from control and supply cables couples into adjacent cables and systems. Parasitic capacitance to the ground plane enables the noise to exit the installation and get onto the mains distribution network as common-mode noise. The longer the cable, the greater the capacitance to ground and the bigger the common-mode noise currents that will flow.

Schaffner’s vast experience in the area of motor drives enables us to provide you with EMC and power quality solutions for both the input and output sides of inverters.

6 Energy regeneration

Today, modern frequency inverters for motor speed control are an integral part of both industrial and residential applications. In regular operation, the motor acts as the consumer of the provided electrical energy. Sometimes, the same motor is also working as a generator; this phenomenon occurs during the braking process of the motor and is known as the regeneration of electrical power. Traditional inverters are not able to use this regenerated energy. Therefore, more and more drive manufacturers equip their inverters with regeneration units in order to utilize this “free” energy for further use.

Energy regeneration inverter systems offer numerous advantages over traditional drives, such as:

- Delivery of generated energy back to the mains power lines for further use
- No problems with unwanted heat dissipation from brake resistors
- No waste of precious energy
- No bulky external brake resistor required
- Higher dynamic characteristics of the system

Unfortunately, this innovative technology also gives rise to a considerable number of problems. First of all, in a motor

drive system with an energy regeneration unit, all the problems known from traditional motor drive applications also occur (EMI, harmonics, dv/dt, overvoltages, magnetic losses in the motor, motor bearing damage, etc.).

As there is a second converter deployed, electromagnetic compatibility (EMC) also becomes even more critical; today, dedicated draft standards for ER systems already apply.

Furthermore, the energy is being returned to the mains by means of a second converter, which operates in the direction of the mains power lines. The ER converter is conducting the regenerated power via a pulse width-modulated signal toward the net. This mode of operation is extremely critical, as the 50Hz sine wave of the mains power lines and a pulsed regenerative voltage at approximately 1 to 4kHz cannot tolerate each other very well. The commutation from the regenerative converter even causes short circuits between the phases towards the public power grid.

In other words, without a proper solution like those suggested by Schaffner, the operation of ER systems is not guaranteed at all. In order to ensure the function and avoid significant interference effects towards the public network, the returning signal needs to be smoothed and adjusted to the power line requirements by means of additional line-conditioning measures. Compliance, reliability and proper function are prime objectives.

Traditional and ER drive philosophies are very different. The installation and solution of the aforementioned problems have to be just as different. The following block schematic diagram shows the most common interference suppression measure deployed in traditional drive units today.

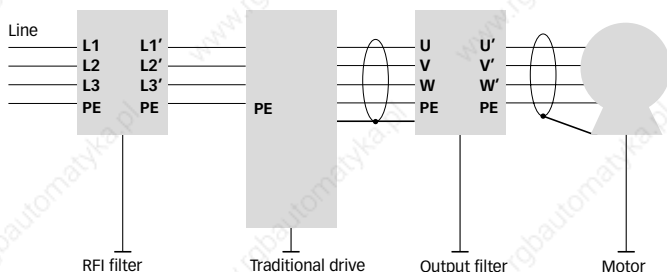

RFI filter solution for traditional drives

A regenerative drive system requires additional measures: First of all, a traditional RFI filter may not be sufficient to meet the dedicated standards and legislation. It's also necessary to consider that the filter must provide full interference attenuation performance in both directions, no matter which operation

is active. This creates much tougher requirements for the filter. Furthermore, ER drives require a special line impedance that cannot quite be compared to a traditional line reactor. Without this line impedance, the ER converter will start producing short circuits between the phases as soon as the system changes into regeneration mode. These short circuits are caused by the IGBT switches (commutation) of the regenerative drive unit.

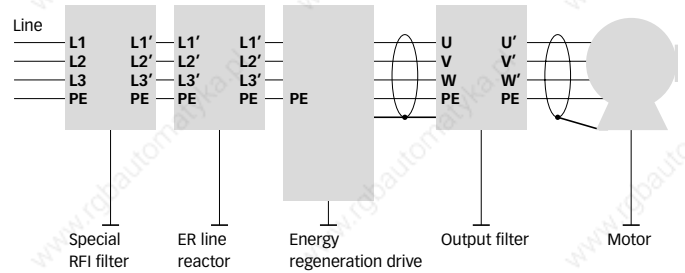

Installation of additional measures for ER drives

The configuration shown in the figure above deploys large smoothing capacitors directly on the mains power lines. If one of the following phenomena occurs, the operation of an additional line reactor is suggested for the line side of the RFI filter.

- Amplification of harmonics
- Self-excitation of machines or equipment
- Overvoltages caused by switching
- Unsatisfactory function of audio frequency ripple control relays

The following parameters have a key influence on the design of the ER solution:

- Kind of modulation and the modulation factor of the drive
- Regeneration switching frequency
- Impedances of the drive
- Cable length
- Special drive peculiarities (circuits to increase the DC link voltage, etc.)

With so many uncertain influences, it does not make much sense to provide a standardized range of filter solutions. The recommendation instead is to find the best solution for a particular ER application by looking directly at the relevant drive and the equipment that incorporates it. With many years of experience in the motor drive sector, Schaffner is the ideal partner for the development and production of fit-and-forget, ER-capable filter and line impedance solutions.

7 Renewable energies

Renewable energy sources like solar power stations or wind parks are becoming increasingly popular. While the means of power generation differs significantly among the natural sources, the conversion process is very similar. We will

therefore explain the relation between the application and the solutions by using solar power generation as an example.

Functional model for photovoltaic applications. Through photovoltaic technology, the sun's radiation can be directly converted into electrical energy. The solar cells of a photovoltaic plant generally consist of two layers – a positively conducting and a negatively conducting layer. As soon as light falls on the cell, a voltage is generated. A connected inverter converts the DC voltage that has been so generated into AC voltage and feeds it to the public network.

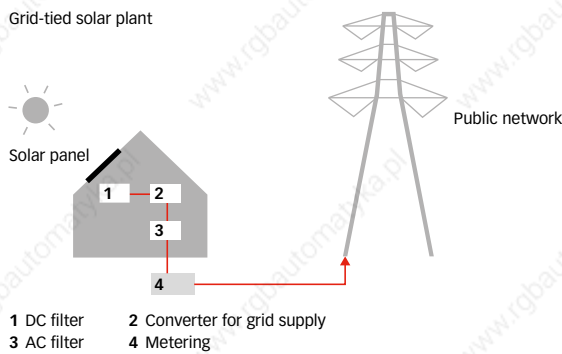

General principle of photovoltaic energy generation

Functional principle of solar inverters. As described above, a solar inverter is used for converting the DC voltage into AC voltage. This involves the present-day modules with complete digital control and high efficiency. For better understanding, the solar inverter can be compared, in the broadest sense, with a regenerating frequency converter for motor control (ER motor drive).

Basically, a distinction is made between two kinds of solar inverters: inverters without transformers and solar inverters with integrated isolation transformers. Although the latter design has clear advantages with regard to the functioning and reliability of the solar module, it is not considered at present because of the additional losses, the greater weight and the size.

In the case of the solar inverter without a transformer, the DC voltage is supported by capacitors and then converted into a 50Hz three-phase voltage by means of a self-commutated converter bridge (such as IGBTs), which is then supplied to the mains power network. What is involved here is not a pure sinusoidal form but a pulsed signal (such as PWM) with a high harmonic content and interference potential.

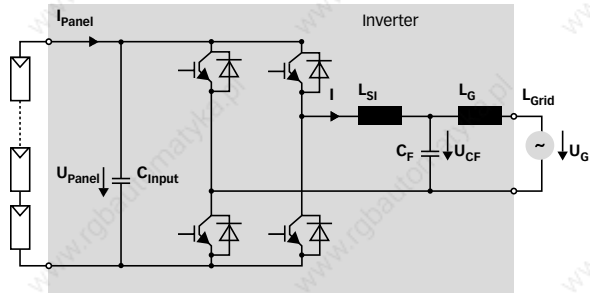

Principle circuit diagram: single-phase solar inverter (without transformer) with grid connection

Occurrence of interferences when using solar inverters. As is already known from motor drive technology, every kind of inverter gives enough cause for the use of interference suppression components. This is no different in the case of the solar inverter.

The fast switching processes that occur when the DC voltage is chopped generate a broadband interference spectrum. The unfiltered connection of the solar inverter to the public supply network would thus be a contravention of the EMC Directive.

However, conducted and radiated interferences occur not only in the direction of the network but also in the direction of the solar module and can adversely affect it in function and efficiency. Whereas the conducted interferences are mostly decoupled in the case of the solar inverter with a transformer, there is a clear need for additional interference suppression components on the DC side in the solar inverter without a transformer.

Because of the steep switching edges, the non-sinusoidal, pulsed AC voltage signal at the inverter output also has a considerable harmonic content that is generally well above the permissible limiting values of international standardization (EN 61000-3-2; IEEE 519).

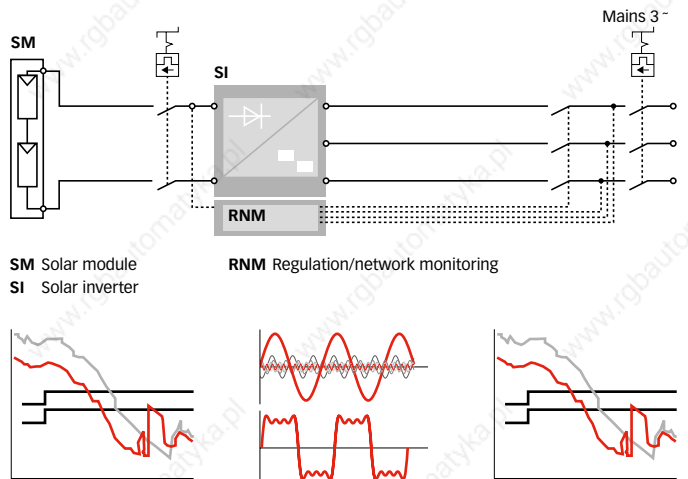

Typical block circuit diagram of a grid-tied solar plant with interferences occurring

Apart from the standardization, the operation of a large number of such plants would pollute and distort the public power network in such a way that reliable operation of grid-tied loads would become impossible.

There is, therefore, a clear need for action. The responsibility for suppressing all the impermissible interferences lies with manufacturers, who must declare their plants safe, reliable and compliant to their customers and government.

To solve the problems shown in the previous chapters, different products are required that fit the application exactly and need to work together synergistically. The block schematic diagram below will provide a first overview.

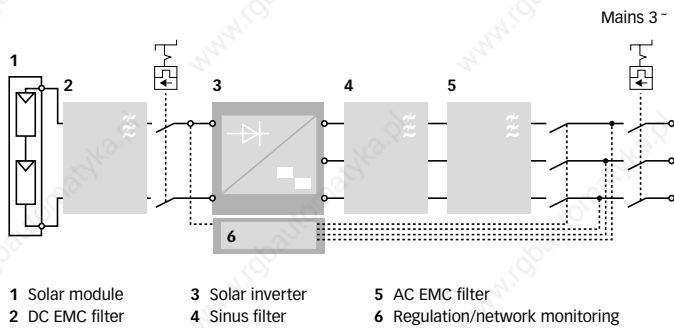

Typical block circuit diagram of a grid-tied solar plant with interference suppression components

DC EMC filter. The DC EMC filter decouples the solar module and mainly takes care of the suppression of high-frequency, conducted interferences from the inverter. These can have a negative effect on the function, reliability and efficiency of the solar cells and must therefore be kept away from the module. In some applications, an overvoltage protection is installed in addition to the EMC filter; it can, in principle, also be integrated into the filter. The DC filter distinguishes itself primarily by a high admissible nominal operating voltage up to 1000VDC.

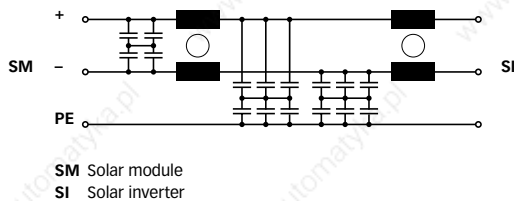

Schematic of a typical DC EMC filter for solar applications

Sinusoidal filter (or LCL filter). A three-phase pulsed AC voltage can be measured at the output of the inverter bridge. As already mentioned in the previous chapters, a pulsed signal cannot just be connected to any public low-voltage network as it is. The LC sinusoidal filter or the LCL filter comes into use here. Its main task is to smoothen the pulsed output signal in order to supply power to the network that is as low

in harmonics as possible. The LC or LCL filter can be understood as a network decoupling in the broadest meaning of the term, with the help of which the inverter and hence the entire solar plant becomes network-compatible.

Depending on the customer's wishes, Schaffner can supply the complete LC/LCL filter or just the output reactor.

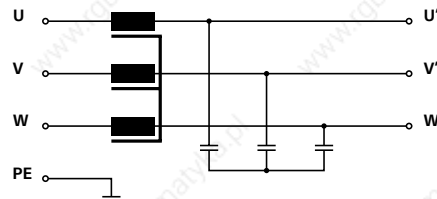

Schematic of a typical sinusoidal filter for solar applications

AC EMC filter. The high-frequency, conducted interferences can also be measured at the mains input and, to fulfill the EMC Directive, must be reduced below the limiting values. Here, for example, an FN 3359 standard filter can be used, which has proven itself in recent years in numerous applications.



FN 3359-1000-99 with protective covers

8 NEMP applications

A nuclear electromagnetic pulse (NEMP) is a high intensity, short duration, electromagnetic field produced as a result of a nuclear explosion outside the atmosphere (exo-atmospheric). The most critical threat for technically highly developed nations is an exo-atmospheric burst (at an altitude of more than 40km) producing a NEMP which causes such high voltages and currents in antennas, power transmission networks etc. that it may leave an entire continent without power, telephone or radio communications. Electronic equipment can be protected against a NEMP if it is placed in a special room or housing which screens it from the electromagnetic fields and if all the feed lines to these areas are protected with voltage limiting devices, such as varistors, gas discharge tubes and suppressor diodes. The Schaffner FN 700Z filter series is designed for NEMP protection. Other suitable filters are available on request.

9 TEMPEST applications

Telecommunication or data processing equipment can transmit signals or distribute them along power lines, providing a mechanism for unauthorized people to access classified information. The study and blocking of such sensitive signals is known as TEMPEST. Mains filters with high attenuation over a large frequency range are necessary. The best possible filter solution can only be identified by specifying the requirements precisely. The FN 700Z filter series has been used in many TEMPEST applications. Other suitable filters are available on request.

10 Communication equipment

Communication equipment requires clean battery power. Special telecommunication base stations transmitting high frequency signals must be protected using feedthrough capacitors or filters. High frequency noise can be absorbed by the battery cable and may harm the system. Feedthrough capacitors or filters shield the system and short high frequency noise to ground.

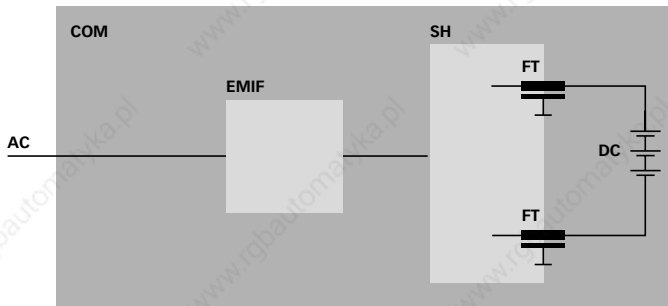

COM Communication equipment SH Shielded housing/cabinet
EMIF EMI filter FT Feedthrough capacitor or filter

11 Shielded rooms

These rooms are often interference-suppressed using feedthrough capacitors or filters. Typical applications are rooms with sensitive equipment or with upgraded EMI requirements for medical equipment, such as computer tomography or magnetic resonance tomography.

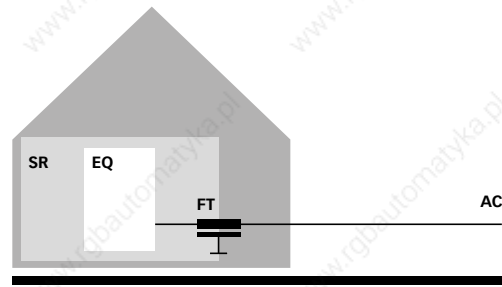

SR Shielded room FT Feedthrough capacitor or filter
EQ Equipment

Feedthrough capacitors and filters also improve the security of communications and prevent information in higher frequency signals from leaving the room via the mains or power line.

Schaffner offers a wide selection of different feedthrough capacitors and feedthrough filters for AC and DC applications.



IV Abbreviations

AE	Auxiliary equipment
AMN	Artificial mains network
AV	Average
CDN	Coupling/decoupling network
CE	Communauté Européenne
CISPR	Comité International Spécial des Perturbations Radioélectriques
EMC	Electromagnetic compatibility
ER	Energy regeneration
ESD	Electrostatic discharges
EUT	Equipment under test
FCC	Federal Communications Commission
GHZ	Gigahertz = 1 billion cycles per second
GRP	Ground reference plane
HCP	Horizontal coupling plane
HF	High frequency
HVAC	Heating, ventilation, air conditioning
Hz	Hertz = cycles per second
ISN	Impedance stabilization network
kHz	Kilohertz = 1000 cycles per second
LF	Low frequency
LISN	Line impedance stabilization network
MHz	Megahertz = 1 million cycles per second
MTBF	Mean time between failures
NEMP	Nuclear electromagnetic pulse
NSA	Normalized site attenuation
PQ	Power quality
PRF	Pulse repetition frequency
PWM	Pulse width modulation
QP	Quasi-peak
R&TTE	Radio and telecommunication terminal equipment
RF	Radio frequency
SMPS	Switch-mode power supply
TEMPEST	Transient electromagnetic pulse emanation standard
THID	Total harmonic current distortion
THVD	Total harmonic voltage distortion
TDD	Total demand distortion
VCCI	Voluntary Control Council for Interference by Information Technology Equipment and Electronic Office Machines
VCP	Vertical coupling plane
VSD	Variable speed drive

V Index

A	Applications	206
B	Bump	200
	Bursts	180
C	Cable cross-sections	198
	Capacitors	186
	CCC	168
	CE marking	167
	Chassis mount filters	188
	Chokes	185
	Climatic classification	200
	Common-mode	166
	Common-mode chokes	186
	Conducted emission	174
	Conducted immunity	178
	Coupling	166
	CQC	168
	Current	196
D	DC resistance	197
	Differential-mode	166
	Discharge resistors	197
	dv/dt	192
E	Earthing	185
	EMC framework	169
	EMC measurements	173
	EMC standards	169
	EMC testing	173
	ESD	179
F	FCC	168
	Feedthrough capacitors and filters	188
	Filter attenuation	188
	Filter ratings	196
	Filters	187
	Flammability	202
	Flicker	177
	Frequency	197
	Frequency ranges	165, 189
	Fuses	202
G	Generic standards	170
	Grounding	184
H	Harmonic	176, 190
	Hipot testing	200
I	Immunity	177
	Installation	204
	IT network	203
L	Leakage currents	201
	Limit lines	172
M	Magnetic fields	182
	Mechanical tolerances	197
	Motor frequency	197
	MTBF	197

N	NEMP	211
	Noise suppression	183
O	Output filters	192
P	Power quality	189
	Product standards	170
R	Radiated emission	173
	Radiated immunity	179
	Radiation	166
	Reactors	190
	Renewable energies	209
	RoHS	199
S	Safety approvals	172
	Shielded rooms	212
	Shielding	183
	Supply frequency	197
	Supply network	182
	Suppression components	185
	Surge	181
	Switching frequency	197
T	TEMPEST	212
	Terminals	198
	TN-C and TN-C-S systems	203
	TN network	203
	TN-S system	203
	Transient immunity	179
	TT network	203
	Type testing	200
V	VCCI	169
	Vibration	200
	Voltage	196
	Voltage fluctuations	177
	Voltage overshoots	192
	Voltage peaks	192

Product index

EH Series	147	FN 2070	118
EV Series	147	FN 2080	122
FN 280	73	FN 2090	126
FN 281	73	FN 2360	129
FN 282	73	FN 2450	104
FN 283	73	FN 7510	7
FN 284	73	FN 7511	7
FN 285	73	FN 7512	7
FN 286	73	FN 7513	7
FN 332	90	FN 7514	7
FN 343	109	FN 7560	10
FN 352Z	131	FN 7561	10
FN 353Z	131	FN 7562	10
FN 370	77	FN 7563	10
FN 372	77	FN 7610	13
FN 376	77	FN 7611	13
FN 378	77	FN 7612	13
FN 379	77	FN 7660	16
FN 380	81	FN 7661	16
FN 382	81	FN 9222	35
FN 385	81	FN 9222E	40
FN 388	81	FN 9226	44
FN 390	84	FN 9233	47
FN 393	84	FN 9233E	52
FN 394	84	FN 9244	56
FN 402	21	FN 9244E	60
FN 405	23	FN 9246	64
FN 406	25	FN 9260	67
FN 409	27	FN 9263	70
FN 410	30	FN 9675	107
FN 685	111	IT Series with single secondary winding	155
FN 686	111	IT Series with double secondary winding	158
FN 700Z	134	RD Series	139
FN 1393	84	RI Series	150
FN 1394	84	RN Series	143
FN 2010	93		
FN 2020	97		
FN 2030	101		
FN 2060	114		

Ordering information

FN 2030x-yy-zz

Connection style

- 01 = solder lug
- 02 = pin suitable for direct assembly onto through-hole printed circuit board
- 03 = clamp terminal with M4 screw
- 05 = AMP faston 6.3 x 0.8mm
- 06 = AMP faston/solder lug combination 6.3 x 0.8mm
- 07 = wire connections (various sizes)
- 08 = screw terminal M4
- 10 = screw terminal UNC 8-32
- 23 = clamp terminal with M5 screw
- 24 = screw terminal M6
- 29 = safety terminal block 4mm²
- 33 = safety terminal block 10mm²
- 100 = cage clamp

Rated current [A]

- A** = optional safety version
- B** = optional medical version
- Z** = optional overvoltage protection

Filter family

Examples	Part Number	Description
	FN 2010A-10-07	FN 2010 (safety version); rated current 10A; with wire connections
	FN 2090B-20-06	FN 2090 (medical version); rated current 20A; with AMP faston/solder lug combination connections
	FN 9675-16-03	FN 9675; rated current 16A; with clamp terminal with M4 screw

**Headquarters and
global innovation and
development center**

Schaffner Group
Nordstrasse 11
4542 Luterbach
Switzerland
T +41 32 681 66 26
F +41 32 681 66 30
info@schaffner.ch
www.schaffner.com

Sales and application centers

China
Schaffner EMC Ltd. Shanghai
Building 11, Lane 1365
East Kangqiao Road
Shanghai 201319
T +86 21 6813 9855
F +86 21 6813 9811
cschina@schaffner.com
www.schaffner.com

Germany
Schaffner Deutschland GmbH
Schoemperlenstrasse 12B
76185 Karlsruhe
T +49 721 56910
F +49 721 569110
germanysales@schaffner.com

Finland
Schaffner Oy
Tynninkuja 7
08700 Lohja
T +358 19 35 72 71
F +358 19 32 66 10
finlandsales@schaffner.com

France
Schaffner EMC S.A.S.
112, Quai de Bezons
95103 Argenteuil
T +33 1 34 34 30 60
F +33 1 39 47 02 28
francesales@schaffner.com

Italy
Schaffner EMC S.r.l.
Via Galileo Galilei, 47
20092 Cinisello Balsamo (MI)
T +39 02 66 04 30 45/47
F +39 02 61 23 943
italysales@schaffner.com

Japan
Schaffner EMC K.K.
Mitsui-Seimei Sangenjaya Bldg. 7F
1-32-12, Kamiyama, Setagaya-ku
Tokyo 154-0011
T +81 3 5712 3650
F +81 3 5712 3651
japansales@schaffner.com
www.schaffner.jp

Sweden
Schaffner EMC AB
Turebergstorg 1, 6
19147 Sollentuna
T +46 8 5792 1121/22
F +46 8 92 96 90
swedensales@schaffner.com

Switzerland
Schaffner EMV AG
Nordstrasse 11
4542 Luterbach
T +41 32 681 66 26
F +41 32 681 66 41
sales@schaffner.ch

Singapore
Schaffner EMC Pte Ltd.
Blk 3015A Ubi Road 1
05-09 Kampong Ubi Industrial
Estate
T +65 6377 3283
F +65 6377 3281
singapore@schaffner.com

Spain
Schaffner EMC España
Calle Caléndula 93,
Miniparc III, Edificio E
El Soto de la Moraleja,
Alcobendas
28109 Madrid
T +34 618 176 133
spainsales@schaffner.com

Taiwan
Schaffner EMV Ltd.
6th Floor, No 413
Rui Guang Road
Neihu District
Taipei City 114
T +886 2 87525050
F +886 2 87518086
taiwansales@schaffner.com

Thailand
Schaffner EMC Co. Ltd.
Northern Region Industrial Estate
67 Moo 4 Tambon Ban Klang
Amphur Muang P.O. Box 14
Lamphun 51000
T +66 53 58 11 04
F +66 53 58 10 19
thailandsales@schaffner.com

UK
Schaffner Ltd.
5 Ashville Way
Molly Millars Lane
Wokingham
Berkshire RG41 2PL
T +44 118 9770070
F +44 118 9792969
uksales@schaffner.com
www.schaffner.uk.com

USA
Schaffner EMC Inc.
52 Mayfield Avenue
Edison, New Jersey 08837
T +1 732 225 9533
F +1 732 225 4789
usasales@schaffner.com
www.schaffner.com/us

To find your local partner within
Schaffner's global network, please go to

www.schaffner.com

611624
July 2011

© 2011 Schaffner Group
Specifications are subject to change
without notice. The latest version of the
data sheets can be obtained from the
website. All trademarks recognized.

Schaffner is an ISO-registered company.
Its products are designed and manufac-
tured under the strict quality and environ-
mental requirements of the ISO 9001 and
ISO 14001 standards.

This document has been carefully checked.
However, Schaffner does not assume any
liability for errors or inaccuracies.