

MANUAL

Transistor Servo-Drive

TV6.2

for DC Motors

TV 6.2

UNITEK

Industrie Elektronik
G m b H

Hans-Paul-Kayser-Strasse 1
D-71397 Leutenbach 3 - Nellmersbach

Tel.: 07195/9283-0
Fax 07195/928329
email info@unitek-online.de
Http// www.unitek-online.de

Ausgabe
0506-1

Transistor Servo-Drive TV 6.2

Contents	Titel	Page
1. Basic Information	Safety advice	3
	Standards and Guidelines	3
	General information	4
	Technical Data	5
	Features	6
	Applications	6
2. Electrical installation	Adjustments	7
	LED displays	8
	Signal test points	8
	Terminal connections and connectors	9
	Test point jack	9
	Option switches	10
3. Mech. installation	Front panel 6HE	11
	Components	12
	Rear panel 6HE	14
	Build	15
	Dimension	16
	4. Adjustments	Connection - compact device
Connection - multiple-axes combination		17
Power connection		18
Ballast circuit		19
Output stage		19
Power section watchdog		20
Enable		21
Command value		22
Command value current		23
Current limiting		24
Actual value		25
Signals- BTB, outputs, tacho fault, overload, over-temperature, stationary		26
Adjustments		27
P-component		28
I-component		28
Tacho control		29
Armature voltage control		29
Diagram - control settings		30
Diagram - actual value differentiation		31
Peak current		31
Commutation limit		32
5. Commissioning		
6. Protocol		35, 36
7. Guarantee		37
8. Circuit diagrams		39-42

1 Basic Information

Electronic Equipment is not fault proof. This fact should be borne in mind for all possible operating conditions.

Attention HIGH VOLTAGE!

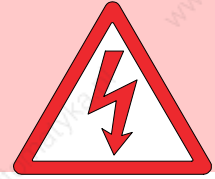

Before installation or commissioning begins, this manual must be thoroughly read and understood by the technical staff involved.

If any uncertainty arises, the Manufacturer or Dealer should be contacted.

Servo-Drive TV6.2 devices are Power Electric parts used for regulating energy flow. Protection rating IP00.

Standards and Guidelines:

The device and it's associated components can only be installed and switched on where the local laws and technical standards have been strictly adhered to:

EU-Guidelines 89/392/EWG, 84/528/EWG, 86/663/EWG, 72/23/EWG

EN60204, EN50178, EN60439-1, EN60146, EN61800-3

- IEC/UL IEC364, IEC 664, UL508C, UL840

- VDE-regulations VDE100, VDE110, VDE160

- TÜV-regulations

- Regulations of Professional and Occupational bodies: VGB4

The user must ensure that in the event of :

- device failure
- incorrect operation
- loss of regulation or control

the axis will be safely de-activated.

It must also be ensured that the machine or equipment be fitted with device independent monitoring and safety features.

Setting Adjustments

- should only be carried out by suitably trained personnel
- should only be carried out in accordance with Health and Safety guidelines

Installation

- should only be carried out when all Voltages have been removed.

QS

Test results are archived with the device serial number by the manufacturer.

CE

The device adheres to the following: Guideline EU 89/336/EWG. EMV standards EN61000-2 and EN61000-4.

General information

The transistor servo-drives are built according to the VDE regulations as switch cabinet mountings or 6HE plug-in devices.

The plug-in devices fit into a standard rack according to the standard DIN 41494 and can be connected by means of a rear panel or a 32-pin terminal strip.

The control electronics and the power section are galvanically connected. The power semi-conductors are comfortably over-dimensioned.

Only components customary in trade and industrially standardised are used. The most important operating modes are indicated by LEDs.

The PI-adjustment and the rough tacho adjustment of the speed controller are achieved by 16-position binary switches. Further adjustments are possible by means of potentiometers and plug-in jumpers.

The TV6.2 devices are completely mounted on one pc board.

1 Basic Information

Technical data

TV6.2

Power connection only via an isolating transformer

No galvanic isolation between the power section and the control electronics.

Power connection TV6.2 30 to 120V~, 40 to 160V=
Output voltage TV6.2 24 to 120V= clock-pulse controlled

Cooling self

Device TV6.2			12
Output current	continuous	A=	12
	peak	A=	24
Max. el. power		W	1440
Integrated quick fuses		A	16
Armature choke		type	DR42 (0.5 mH)
Dimensions - plug-in device		wxh	16TE 6HE
Dimensions - switch cabinet plug-in device		wxhxd	170x240x80 mm

Common specification		
Protection rating		IP 00
Format		VDE 0100 group C VDE 0160
Humidity rating		class F acc. to DIN 40040
Site of installation		< 1000m above sea level
Operating temperature range		0 to 45°C
Extended operating temperature range		up to 60°C reduced by 2%/°C
Storage temperature range		-30°C to +80°C
Speed controller: control precision without actual value error		± 0.1%
Control range		1: 1000

Application:

Transistor servo-drive for dc motors with 4Q operation.

To be used for tacho control, armature voltage control with I_xR , torque control, or combined speed/torque control.

Connection by using an isolating transformer

- * Max. clock frequency across the motor circuit 18 kHz
- * Protection against short-circuits and circuits to earth
- * Output stages
- * Error-tolerant switching off in case of over-currents
- * Ballast circuit
- * Braking in case of a mains failure
- * Wide-band chopper power supply unit
- * Differential amplifier (2 command value inputs, 1 adjustable)
- * Slope limiting (adjustable integrator)
- * Speed controller (RVU) with PI-switching
- * Current command value output
- * Static and dynamic current limiting
- * Speed-dependent current limit (commutation limit)
- * Command value - zero switching
- * Enable logic
- * Solderless adjustment
- * Standard components

1 Basic Information

Electrical installation

Function	Component	
	Front panel	internal
Tacho actual value adjustment	Pot. P4 (nmax)	binary switch S9
Tachometer smoothing		switch S3:K3
Tachometer watchdog		switch S2:K2 and S6:K1
Actual value adjustment - armature	Pot. P4 (nmax)	switch S6:K4
IxR compensation	Pot. P2 (IxR)	switch S1:K4
Integrator		Switch S3:K1 Pot. P1 (INT)
2 command value adjustment		Pot. P9
Amplification P-component	Pot. P3 (Xp)	binary switch S4
Amplification I-component		binary switch S5
Actual value differentiation		switch S3:4
Commutation limiting		resistor R111, R112, R190, DZ2
Zero adjustment	Pot. P8 (Offset)	
Continuous current	Pot. P7 (ID)	
Internal current limiting		Pot. P5 (Imax1) Pot. P6 (Imax2)
External current limiting		switch S6:K2 Pot. P6 (Imax1) switch S6:K3 Pot. P5 (Imax2)

LED displays

Function	LED no.
Control electronics	
H drive ready BTB	LED H
G command value enable	LED G
F speed controller output +	LED F
E speed controller output -	LED E
D stationary	LED D
C blocked	LED C
B tacho fault	LED B
A over-temperature	LED A
Power section	
C +15V	LED C
D -15V (only for TV6)	LED D
E ballast circuit	LED E
F error	LED F
G over-voltage	LED G

Signal test points

Function	Terminal no.	Connector no.
Drive ready BTB	X2:21, 22	X1:22a - X1:24a
Tacho fault	X2:19	X1:28a
Overload	X2:18	X1:30a
Stationary	X2:25	X1:16a
Current (I actual value)	X2:20	X1:26a
Over-temperature	X2:26	X1:14a
Ground GND	X2:23, 24	X1:18a

2 Electrical Installation

Connection terminals X1, X2, and connectors X1

Function	Terminal no.	Connector no.
+ 15V (for enable)	X1: 1	X1: 32c
Enable input (+10V to +30V)	X1: 2	X1: 30c
+ 10V (for command value)	X1: 3	X1: 28c
Command value input (signal)	X1: 4	X1: 26c
- 10V (for command value)	X1: 5	X1: 24c
Tacho input(GND)device ground	X1: 6	X1: 22c
Tacho input (signal)	X1: 7	X1: 20c
Command value input (GND)	X1: 8	X1: 18c
External current limit I1	X1: 9	X1: 16c
External current limit I2	X1: 10	X1: 14c
Power voltage	X1: 12	X1: 10ac
Power voltage	X1: 14	X1: 6ac
Motor connection	X1: 15	X1: 4ac
Motor connection	X1: 16	X1: 2ac
Command value-additional input	X2: 17	X1: 32a
Overload signal	X2: 18	X1: 30a
Tacho fault signal	X2: 19	X1: 28a
Current (I-actual)	X2: 20	X1: 26a
Drive ready (BTB)	X2: 21	X1: 24a
Drive ready (BTB)	X2: 22	X1: 22a
Device ground (GND)	X2: 23	X1: 20a
Device ground (GND)	X2: 24	X1: 18a
Signal - stationary condition	X2: 25	X1: 16a
Over-temperature	X2: 26	X1: 14a

Test point jack X4

Function	Connector no.
n - command value (at the output of the diff. amplifier)	X4: 1
n - command value (at the input of the speed controller)	X4: 2
I - command value	X4: 3
+ 10V reference	X4: 4
- 10V reference	X4: 5
I - actual value	X4: 6
n - actual value (at the output of the divider)	X4: 7
enable	X4: 8
free	X4: 9
device ground GND	X4:10

Option switches - Adjustments

Switches: S1, S2, S3, S6
 Contacts: :K1, :K2, :K3, :K4

Switch functions

Position OFF (open)	Switch S6:Kx	Position ON (closed)
Tacho watchdog active		Tacho watchdog off
External current limiting 1		Internal current limiting 1
External current limiting 2		Internal current limiting 2
Tacho actual value		Actual armature voltage

Switch S3:Kx	
Only contact 1 or 2 in position ON or both contacts in position OFF	
No tacho smoothing	
No D-component	
Command value with ramp (Integrator)	
Command value without ramp	
Tacho smoothing	
Actual value D-component	

Switch S2:Kx	
-input isolated	
Command value differential input	
Speed controller - PI-amplification	
Corrective value - different. input	
-input, command value = correct. value	
Command value referend to GND	
Speed controller - amplification-1	
Corrective value referring to GND	

Switch S1:Kx	
Current control loopPI-amplification	
Tacho watchdog off	
immediatly blocked control loop	
IxR compensation off (tacho)	
Current control loopP-amplification	
Tacho watchdog active	
delayed control loop blocking	
IxR compensation active	

Fig. Factory setting

3 Mechanical Installation

Power section signals

- +15V
- 15V
- brake
- short-circuit
- over-voltage



Control electronics signals

- drive ready BTB
- enable
- current command value +
- current command value -
- stationary
- motor blocked
- tacho fault
- temperature

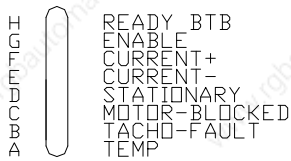
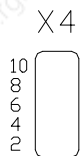

Adjustment potentiometer

- I_b = continuous current
- X_p = amplification
- I_{xR} = compensation for armature voltage control
- n_{max} = speed adjustment
- Offset = zero point adjustment

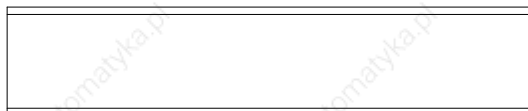
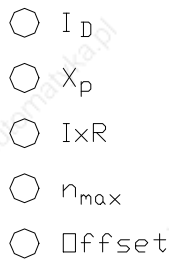

Transistor Servo-Drive TV 6.2

Components

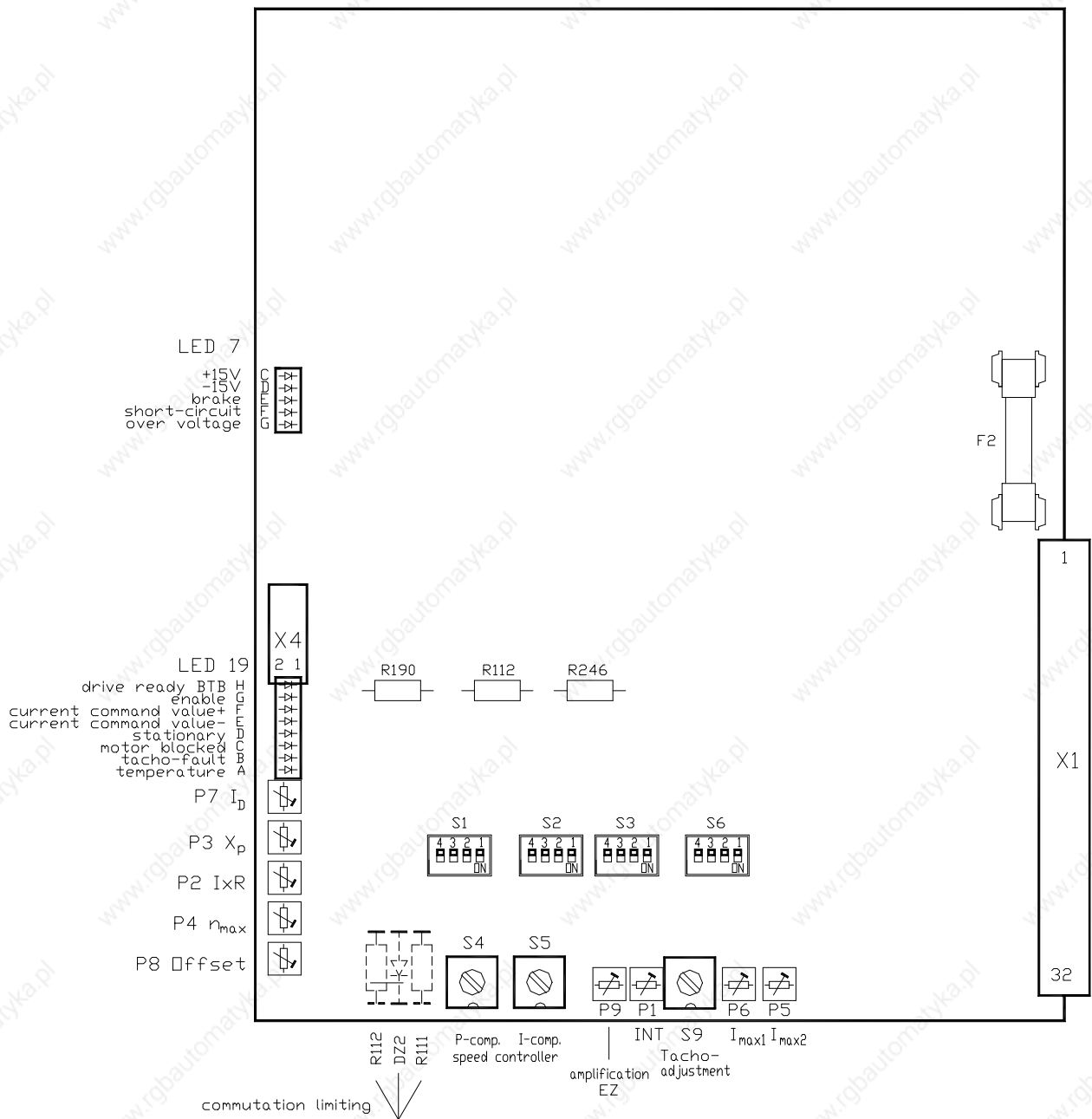

3 Mechanical Installation



Transistor Servo-Drive TV 6.2

Rear panel 6HE

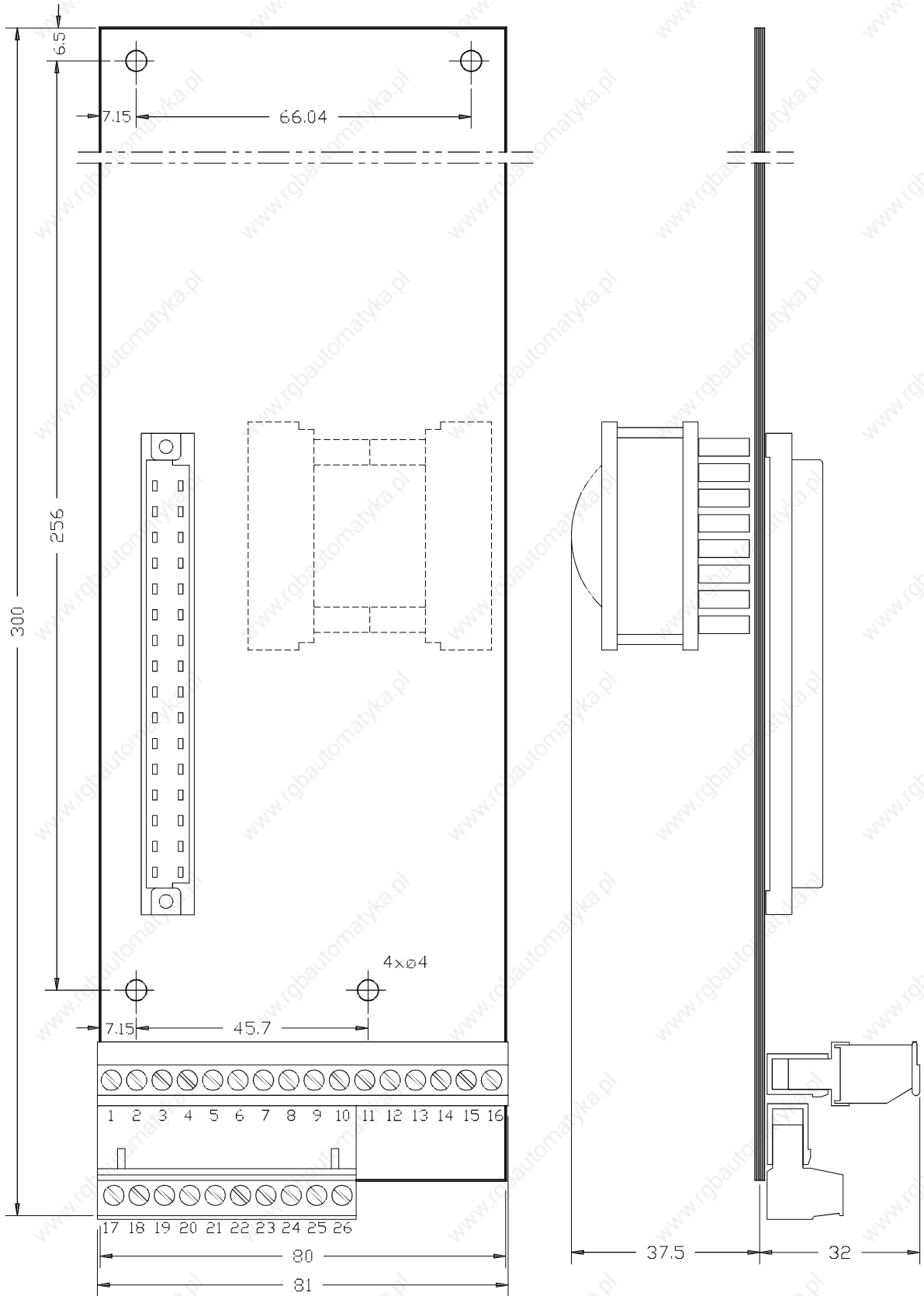

3 Mechanical Installation

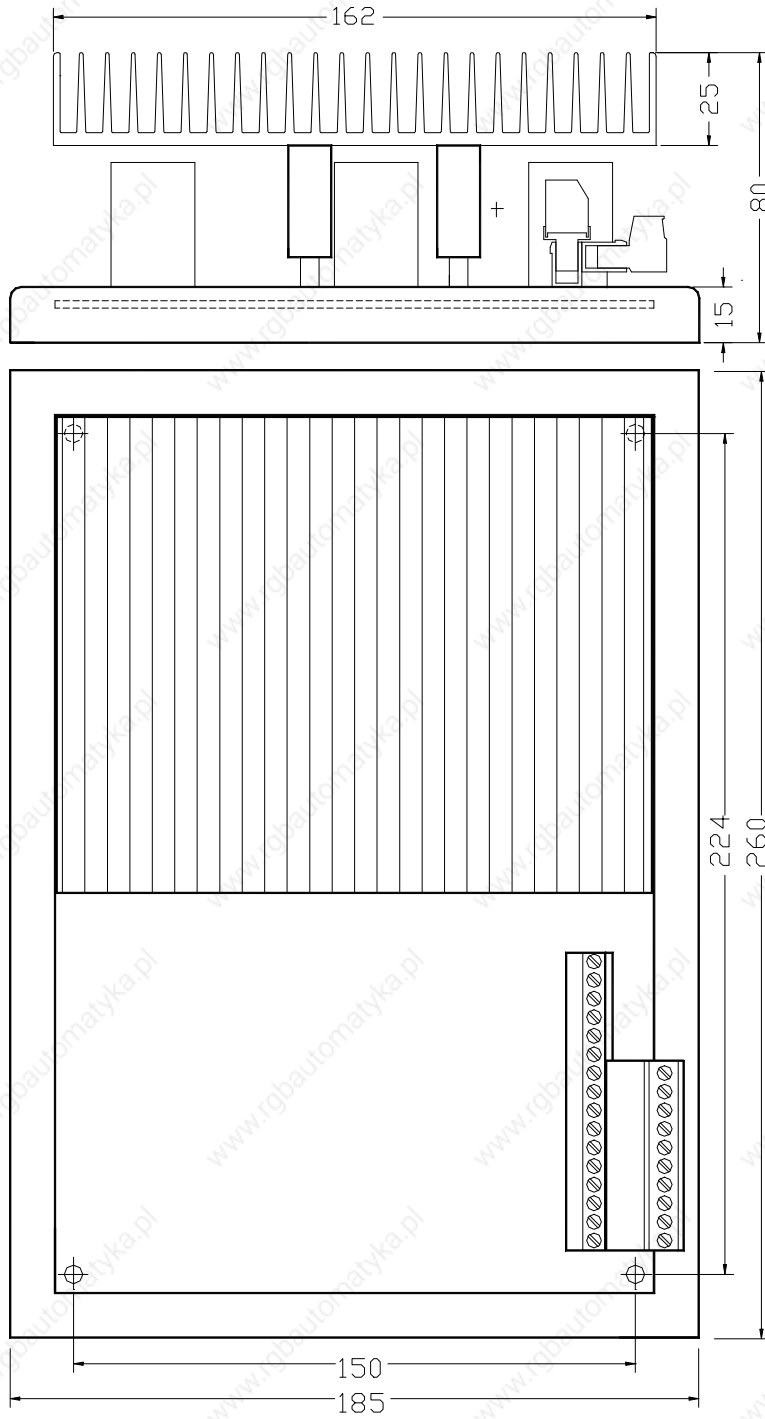

Build

Transistor Servo-Drive TV 6.2

Dimensions

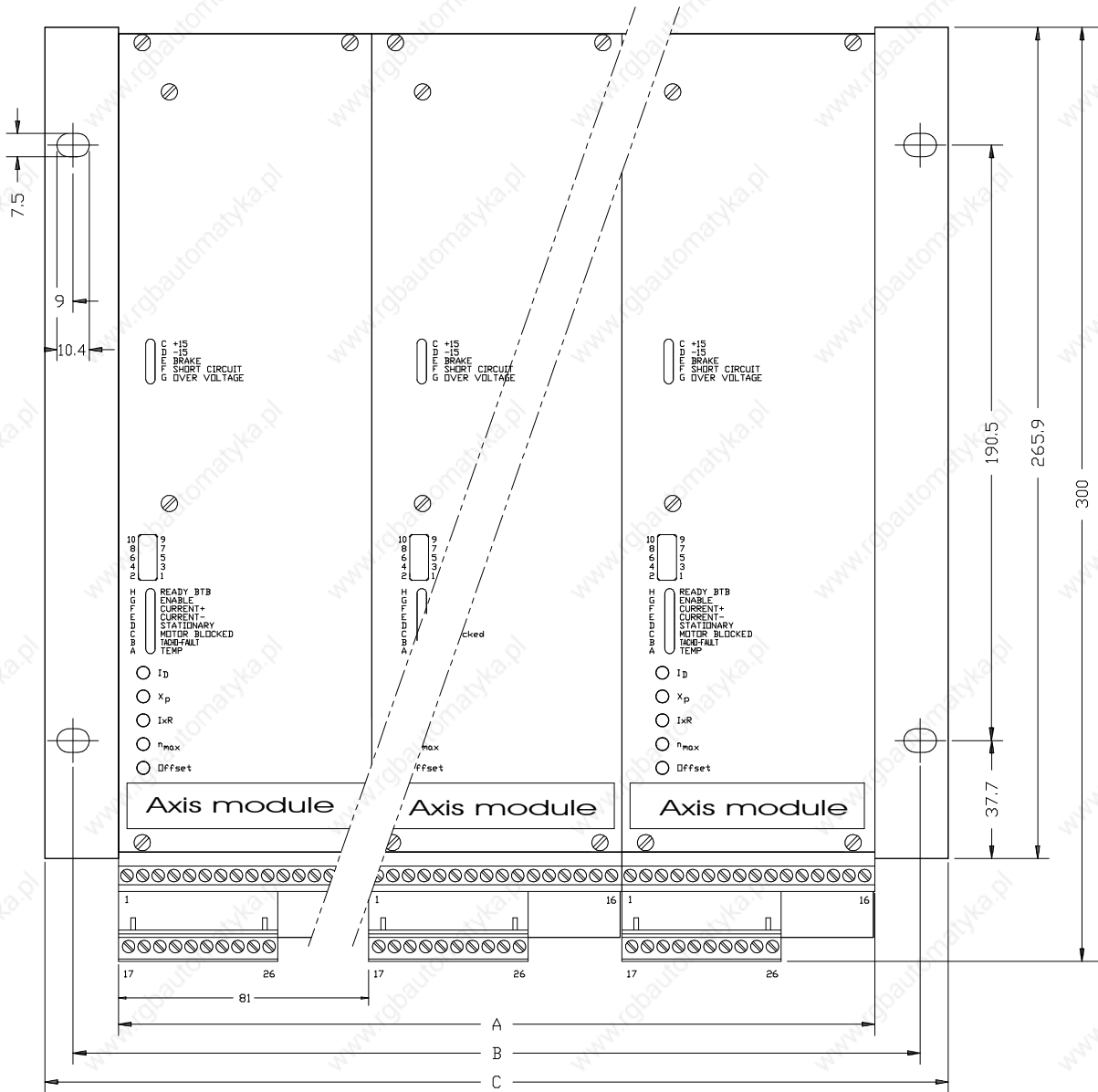

Dimensions 6HE [mm]

Plug-in device	1	2	3	4	5
A	82	163	244	326	427 (19")
B	122	203	284	366	467
C	137	218	299	381	482
Mounting depth 270 mm					
For front mounting the lateral angle is at the front, for wall mounting it is at the back.					

4 Adjustments

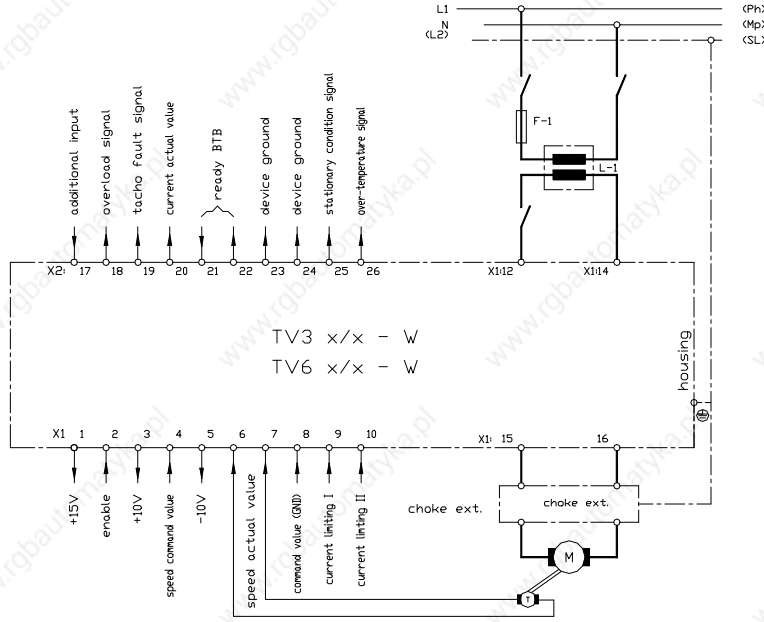

Anschluss Kompaktgerät

Anschluss Mehrachskombination

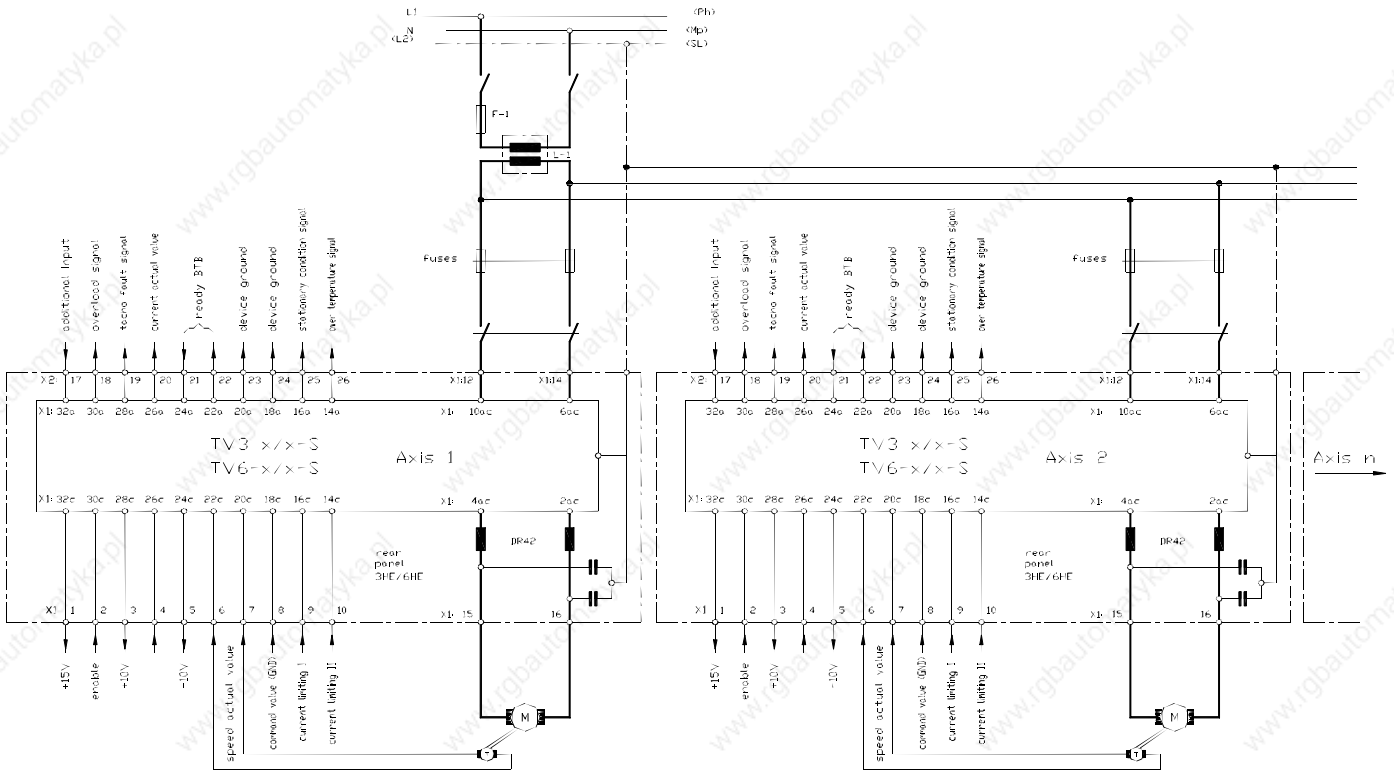

Adjustments - Power connection

Note:

The order of the connections to the connector numbers or screw terminals is obligatory.

All further advices are non-obligatory.

The input and output conductors may be altered or supplemented in accordance with the electrical standards.

An isolating transformer is used as **power transformer**. Several TV6.2 devices can be connected in parallel to one transformer if the device input has a 2-pole protection and circuitry.

The power connection must not be grounded. The 'device ground' of each device must be connected with at least 2.5 mm².

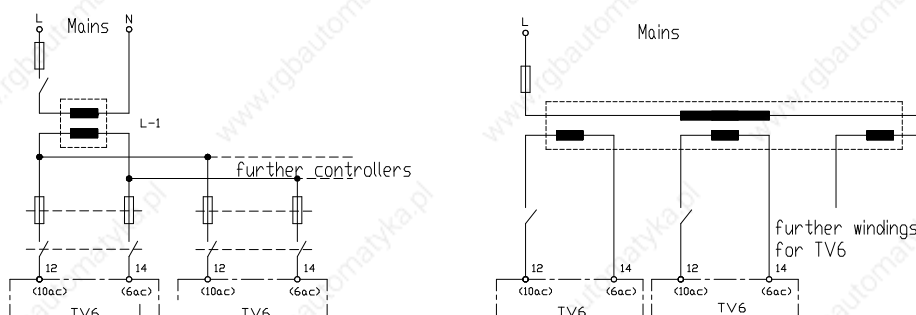

In case of very wide control ranges or different motor voltages separated windings are advisable.

The power ratios of the transformer corresponds to the sum of all simultaneously applied continuous motor currents. Please note that the relay contacts preceding the transformer must be rated to its switch-on current.

The transformer is to be protected with slow fuses.

The motor can be connected by means of an armature choke to the terminals X1:15 and X1:16.

The choke inductance should be approx. 0.5 mH. It is only used to reduce spurious emissions as well as the collector voltage across the motor. It is not required to protect the TV6.2 device.

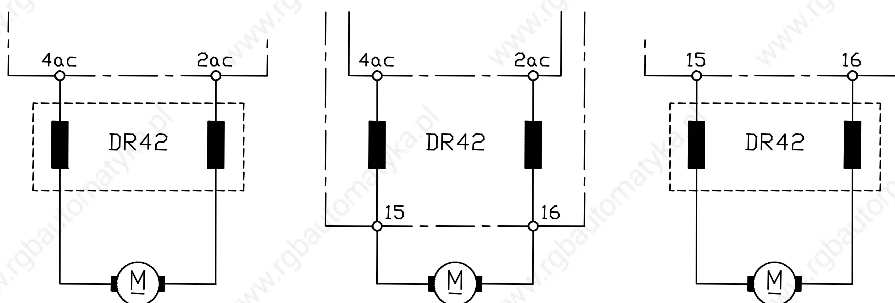

The motor lines are only allowed to be switched when the mains current is disabled. Any switching-off when connected to current will cause arcing.

Any switching-on when the controller is enabled may damage the motor.

4 Adjustments

Adjustments

Ballast circuit

A ballast resistor (continuous power = 15W) is installed. It is activated at 200V dc. The ballast circuitry has an over-voltage watchdog. In case of over-voltage, the device is internally blocked, a short-circuit is signalled, and the 'ready' contact (BTB) is opened.

In case of high ballast energy more powerful resistors can be installed in the factory (special version, pls. indicate on order).

It is not possible to connect external ballast resistors.

Ballast circuit

Output stage

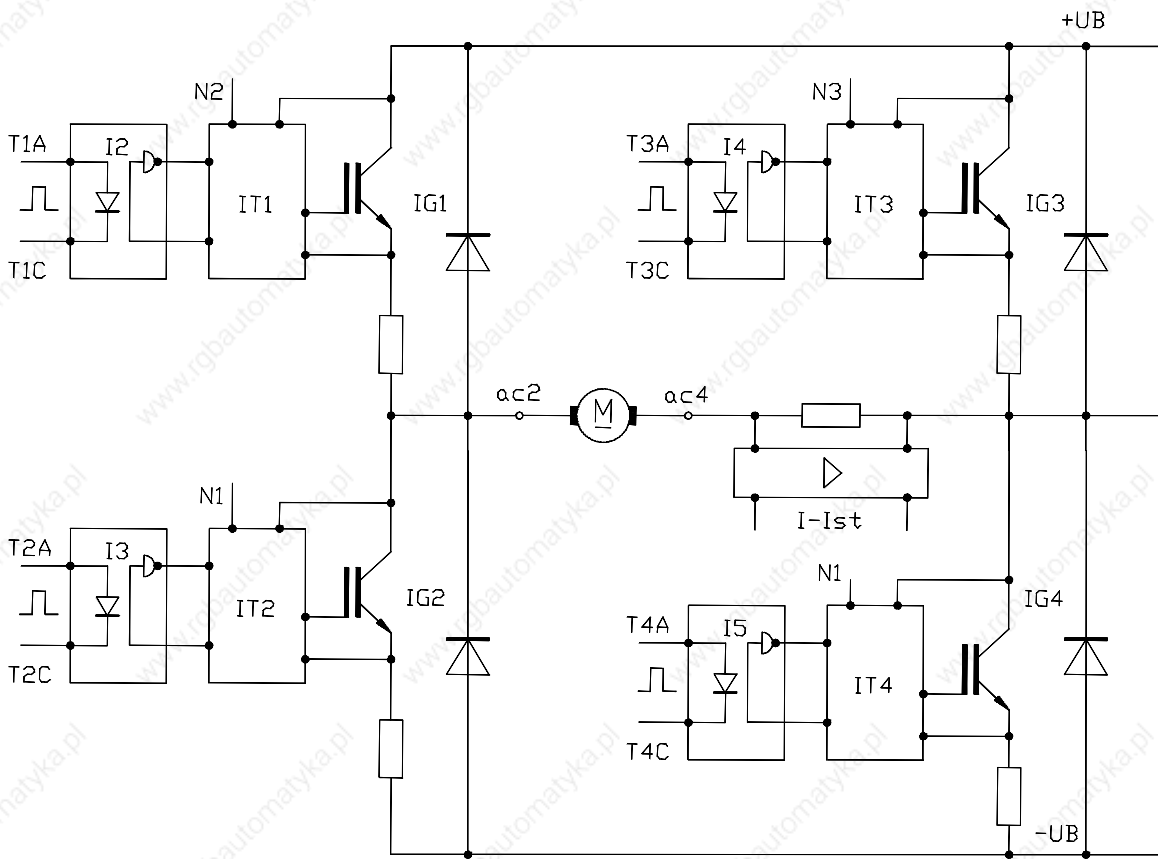

The transistor power sections have an internal watchdog and protect themselves.

Under fault-free conditions the BTB-relay will be controlled.

The BTB-relay will switch off in case of the following faults:

auxiliary voltage supply: +15V, -15V

power section: fuse failure,
buffer circuitry voltage too high
permanent short-circuit or circuit to earth
over-temperature (optional, rf. to current limiting in case of over-temperature)

In case of BTB-faults or tacho faults the power section is immediately internally de-activated.

The TV6.2 devices have a ballast circuitry and an integrated brake resistor.

The ballast circuit is activated at approx. 200V.

4 Adjustments

Adjustments - Enable

The control advise is provided as general information and it is not obligatory. The local regulations and the connection and operating instructions must be adhered to.

Connectors X1: 2ac to X1: 32c
Terminals X1: 1 to X1:16 X2 : 17 to X2 : 26

When connecting X1:32c (X1:1) to X1:30c (X1:2) or applying a voltage superior to +10V, the command value and the speed controller (RVU) will be enabled immediately.

When opening the contact or switching off the enable voltage the command value is immediately set to 0 and the speed controller drive is disabled after 2s (emergency stop).

Output X1:32c (X1: 1) 15V/6mA
Input X1:30c (X1:2)
Input resistance 4kΩ

Note:

Contact current 6mA
Relays with gold contacts or Reed relays

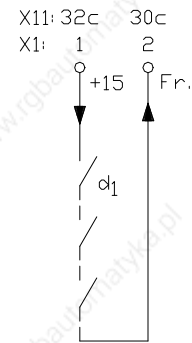

Input X1:18c (X1: 8) device ground GND
Input X1:30c (X1:2) enable input
Input resistance 4kΩ

Drive enable voltage from a PLC or CNC
+10V to +30V (nominal +24V/6mA)
If relay contacts are employed in the enable line, appropriate contacts must be provided.

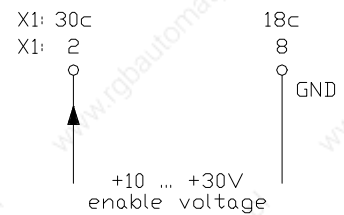

Adjustments - Command value

The command value input X1:26c (X1:4) is dimensioned for a voltage command value of $\pm 10V$.

The command value is generated by using the internal voltage supplies of +10V across X1:28c (X1:3) and -10V across X1:24c (X1:5) or by applying a command value voltage from a PLC or CNC.

The input resistance is 50k Ω .

The relay contacts of the command value circuitry must be gold or reed contacts.

When using the internal command value supply the switch S2:K2 must be closed (ON) (rf. to device ground).

Note:

If the supplementary command value input at terminal no. 17 is not used, it must be bridged to GND (terminal no. 23, 24). (Rf. to page 23)



Output X1:28c (X1:3) +10V/5mA

Output X1:24c (X1:5) -10V/5mA

Output X1:18c (X1:8) device ground GND

Input X1:26c (X1:4) command value 0 to $\pm 10V$

The rotation direction is changed by means of the relay contacts d1 and d2.

Stationary condition when d1 and d2 are open.

Speed adjustments by means of the poti Pcom.val.

Potentiometer resistance 5 to 10k Ω .

Command value voltage 0 to $\pm 10V$.

Switch S2:K2 closed.

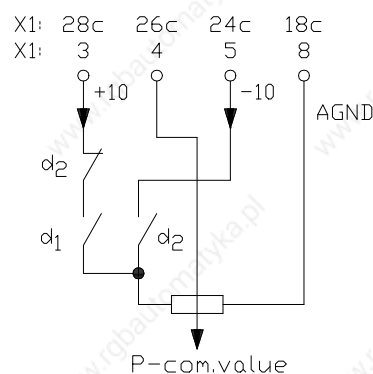

Input X1:26c (X1:4) command value

Input X1:18c (X1:8) command value

Voltage X1:26c - X1:18c 0 to $\pm 10V$

Input resistance 50 k Ω

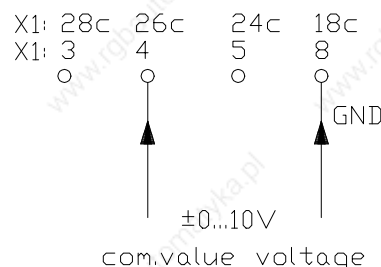

Differential input when switch S2:K2 is open.

When using the command value input as differential input, the device ground (X2:23) must be earthed.

4 Adjustments

2nd Command value

A correction value of max. $\pm 10V$ can be applied across the connector X1:32a (X1:17).

The input resistance is $100\text{ k}\Omega$.

If the polarity is the same as that of X1:4 (command value), the correction voltage will be added.

This input is bridged with a resistance of $1\text{ k}\Omega$ at R246.

If the 2nd command value input is used, the resistor R246 must be removed.

Output X1:28c (X1:3) +10V/5mA

Output X1:24c (X1:5) -10V/5mA

Output X1:18c (X1:8) device ground GND

Input X1:32a (X1:17) correction value 0 to $\pm 10V$

The rotation direction is changed by means of the relay contacts d1 and d2.

No correction if d1 and d2 are open.

Correction value adjustment by means of poti P_{corr}.

Potentiometer resistance 5 to $10\text{ k}\Omega$.

Command value voltage 0 to $\pm 10V$.

Switch S2:K4 closed.

Input X1:32a (X1:17) command value

Input X1:18c (X1:8) command value

Voltage X1:26c - X1:18c 0 to $\pm 10V$

Input resistance $100\text{ k}\Omega$.

Differential input if the switch S2:K4 is open.

If the correction input is used as differential input, the device ground (X2:23) must be earthed.

Command value with command value current (0 to 20mA)

1st command value

For converting a command value current of 0 to 20mA a resistor of 500Ω must be soldered-in at R134.

2nd command value

For converting a command value current of 0 to 20mA a resistor of 500Ω must be soldered-in at R134.

The current limiting can be adjusted internally by means of the potentiometers P6 (I_{max1}) and P5 (I_{max2}) from 0 and 200% type current (rated current). In this case the switches S6:K2 and S6:K3 must be closed (ON).

For external current limiting adjustments or control the switches S6:K2 and S6:K3 must be open (OFF).

The current limiting can be switched from 0 to 200% by using a voltage of 0 to +10V across the input X1:16c (X1:9) for the current limit 1 and across X1:14c (X1:10) for current limit 2. For adjusting by means of external potentiometers or voltage dividers a voltage of +10V is available across terminal X1:28c (X1:3) against the GND X1:20c (X1:7).

Output X1:28c (X1:3) +10 Volt

Input X1:16c (X1:9) current limiting I1, 0 to +10V

Input X1:14c (X1:10) current limiting I2, 0 to +10V

Output X1:20c (X1:7) device ground GND

Switches S6:K2 and S6:K3 closed (ON).

The current limit I1 is adjusted by means of the potentiometer P-I_{con.val.1}, the current limit I2 by means of the potentiometer P-I_{con.val.2}.

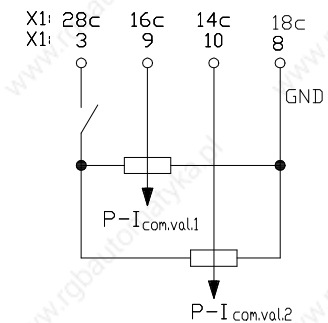

Input X1:16c (X1:9) current limiting I1, 0 to +10V

Input X1:14c (X1:10) current limiting I2, 0 to +10V

Output X1:20c (X1:7) device ground GND

Input resistance 50 kΩ

The current limiting is controlled by the voltages across X1:16c and X1:14c.

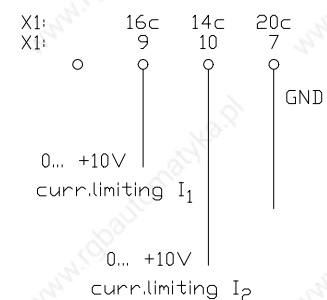

For an external control current of 0 to 20mA for the current limiting, the external load resistors of 500Ω must be connected.

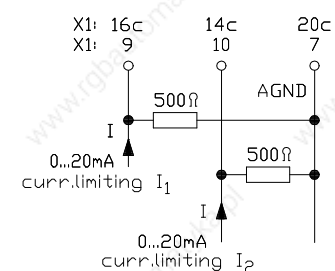

4 Adjustments

The actual value is connected as tacho signal or as armature voltage signal with an internal bridge (switch S6:K4 ON).

The quality of the actual value signal determines the control range and the control precision. The best results can be achieved through the use of dc tacho generators.

Three-phase tacho generators with rotor position evaluation or digital actual value generator with a rotation direction dependent signal can also be used.

Alternating or three-phase current tachos with rectification are not suitable for 4Q operation.

The tacho conductors are to be well shielded and laid separately from the power conductors. The shield must be connected to the device.

Tacho adjustment rf. to page 29.

For a 4Q-control with a small control range (up to 1:50) and a reduced demand on the precision and dynamics the armature voltage can be used as actual value signal.

Input X1:20c (X1:7) Tacho (signal)

Input X1:22c (X1:6) Tacho (GND)

The tacho input X1:22c and the command value input X1:26c must have opposite polarities. The tacho voltage is adjusted by means of the binary switch S9 (rf. to chapter 'adjustments'). A smoothing capacitor can be connected by means of the switch S3:K3

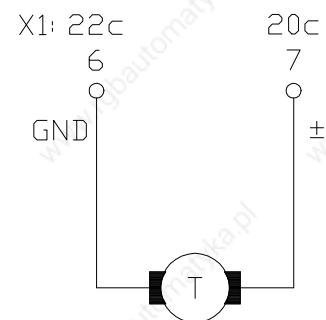

For armature voltage control with IxR compensation the armature voltage U_A is internally connected by means of the switch S6:K4.

The switch S9 (tacho divider) **must be** switched to zero position.

The tacho watchdog is switched off.

Switch S1:K2 open (OFF)

Switch S6:K1 closed (ON)

Note:

For a positive command value (X1:4) the tacho signal (X1:7) must be positive. The motor connection (X1:16) is positive referred to X1:15.

In case there is no fault signal from the internal power section watchdogs, the signal contact BTB (drive ready) is closed.

The contact signals to the PLC or CNC that the motor controller is ready for operation.

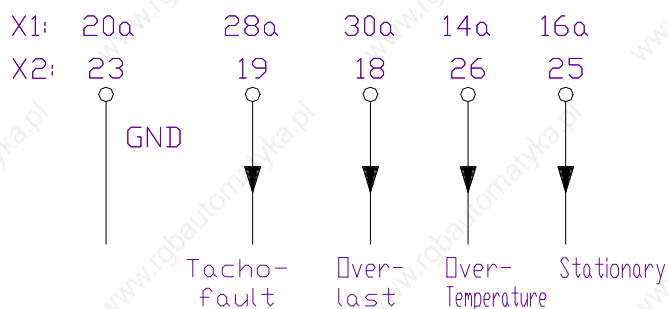
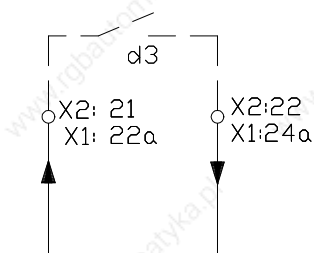

The outputs have regenerating fuses.

If the tacho is not connected or broken, the voltage across the signal output X1:28a (X2:19) is 0V.

Polarity or voltage faults cannot be detected.

The tacho fault is signalled by means of the LED 19-B.

Note:

Tachos with either a high voltage or a high inductance may cause the tacho watchdog to malfunction. In order to overcome this problem insert a capacitance of 0.1 μ F/400V at the tacho terminals + and -.



In case of overload or blocked drive the signal output X1:30a (X2:18) switches from +15V to 0V after approx. 2s.

The overload is signalled by means of the LED 19-C.

In case of a temperature increase to 90°C, the device is internally de-activated and the fault 'LED' is signalled.

The BTB contact is opened. LED 19H extinguishes.

The signal output X1:16a (X2:25) switches from 0V to +15V if the speed is inferior to 1%.

The stationary condition is signalled by means of the LED 19-D.

4 Adjustments

An ammeter for the armature current can be connected to the terminals X1:26a (X2:20) and X1:18a (X2:24). The output voltage is $\pm 5V$ for $\pm 200\%$ type current. The output resistance is $1k\Omega$.

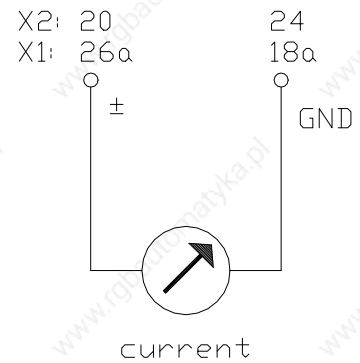

The command value input can be switched as a differential input or as an input amplifier with reference to point zero, depending on how the switch S2:K2 is switched.

S2:K2 closed (ON) = input with reference to point zero
(X1: 8a connected to X1: 8 GND)

S2:K2 open (OFF) = differential input

Amplification of the input amplifier = 1

The command value at the output of the differential amplifier can be measured across X4:1.

A correction value can be added to the speed controller using the additional input (2nd command value). The switch S2:K2 can be used to adjust whether the additional input has reference to zero or is on the same potential as the differential amplifier.

S2:K2 closed (ON) = input with reference to point zero

S2:K2 open (OFF) = differential input

The amplification of the additional input can be varied from 0 to 100% by means of the internal potentiometer P9.

The integration time of the slope limiting device is adjusted by means of the potentiometer P1 (INT). The time until the max. actual value applies across the output can be extended by turning the potentiometer clockwise.

Time with the potentiometer at left full scale = 0.1s

Time with the potentiometer at right full scale = 4.5s

The integrator function can be measured at PIN X4:2 with the enable switch closed.

The command value with or without integrator function is switched to the speed controller by using the switches S3:K1 and S3:K2.

S3:K1 ON, S3:K2 OFF = with integrator

S3:K1 OFF, S3:K2 ON = without integrator

The proportional and integration components of the speed controller are adjusted by means of two 16-position binary switches and the amplification potentiometer P3 (Xp) .

When replacing the control electronics the adjusted values can be taken over.

Adjustment P-component by means of the binary switch S4

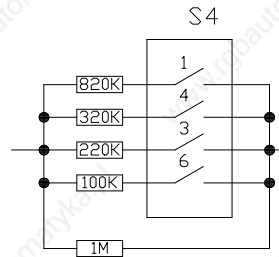
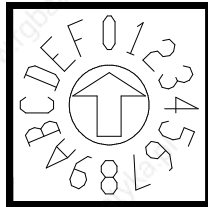

Switch S4																
Position	0	1	2	3	4	5	6	7	8	9	A	B	C	D	E	F
R-value	1000	450	280	209	180	148	123	107	90	82	73	67	64	59	55	52kΩ

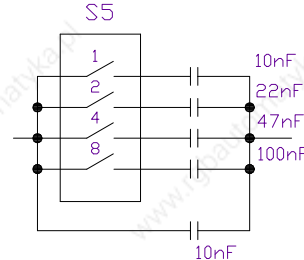
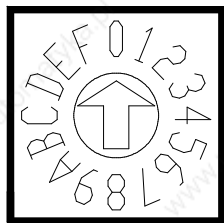

Switch S5																
Stellung	0	1	2	3	4	5	6	7	8	9	A	B	C	D	E	F
C-value μF	0,01	0,02	0,03	0,04	0,06	0,07	0,08	0,09	0,11	0,12	0,13	0,14	0,15	0,16	0,18	0,19 μF

If the potentiometer P3 (Xp) is at right full scale and with the switches S4/S5 are in position 0, the amplification $V_P = 10$.

The amplification can be increased up to the factor 30 by turning the potentiometer P3 (Xp) clockwise. Please note that the function of the potentiometer P3 is a 1/x function.

The integration time of the speed controller RVU depends on the position of the potentiometer P3 (Xp) and of the switches S4 and S5.

4 Adjustments

Tacho control

In order to control the speed by means of the tacho actual value, the switch S6:K4 must be open. The polarity of the tacho signal at X1: 22c (X1:6) and the command value input (X1: 6) **must be opposite**.

The rough adjustment of the actual value is achieved by means of the binary switch S9 .

The fine adjustment of the maximum speed with maximum command value is achieved by means of the potentiometer P4 (n_{max}) .

When replacing the control electronics, the position of the switches and potentiometers can be taken over.

When closing the switch S3:K3 the tacho signal can be smoothed by means of a capacitor of 0.1 μF.

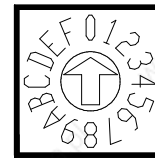
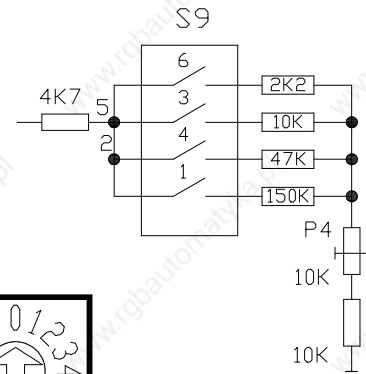

Switch S9											
Rough tacho adjustment											
Position	0	1	2	3	4	5	6	7	8	9 to F	Poti position n _{max}
Tach voltage		155	52	41	14,7	14	12,9	12,5	6,9	6,8	kΩ

Armature voltage control

In order to control the speed by means of the armature voltage as actual value, the switch S6:K4 must be closed (ON).

Switch S9 in position 0.

The fine adjustment of the maximum speed at maximum command value is achieved by means of the potentiometer P4 (n_{max}).

For IxR compensation the switch S1:K4 is closed (ON).

The speed drop IxR is compensated for by the potentiometer P2 (IxR), so that in case of a low speed and 50% load jump the speed does not drop into idle running. (Less possible speed drop between load and idle running.)

In case of a PI-setting with a low amplification and a long integration time, a D-capacitor of 0.47μF can be activated by means of the switch S3:K4 in order to reduce overshooting of the speed.

Adjustments - Control values

The adjusted control values can be measured at the connector X4:3 by means of an oscilloscope. The reference command value at the connector X4:1 is transferred to channel 1 and the control output at X4:3 to channel 2 of the oscilloscope.

The reference voltage is activated and switched off between 1V and 0V .

Examples for adjusted control values:

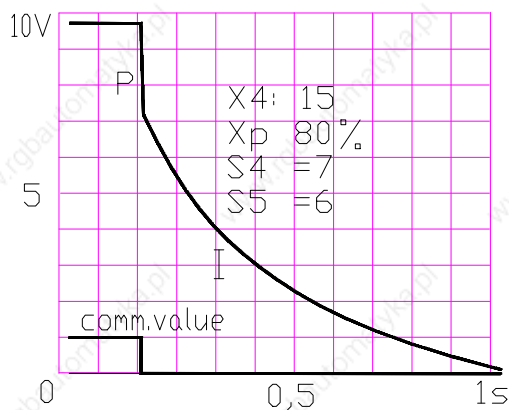
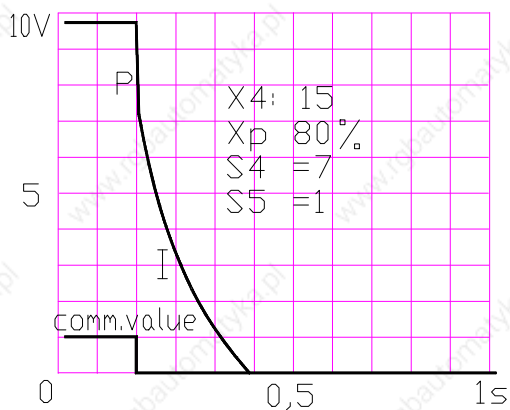
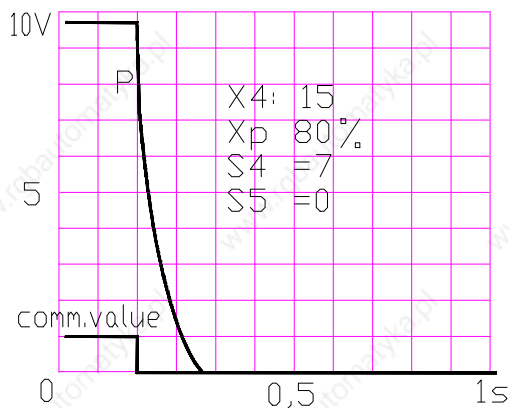
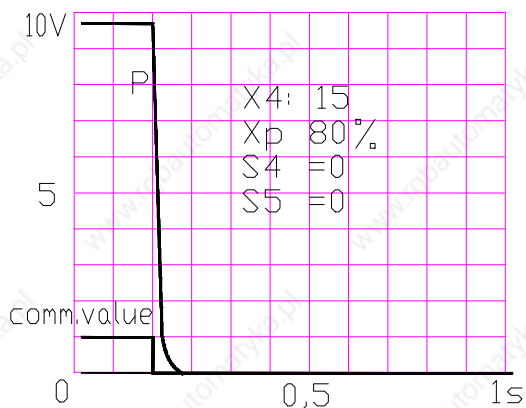

4 Adjustments

The effect of the actual value differentiation can be measured at the connector no. X4:7 by means of an oscilloscope. When the motor is connected and enabled a command value jump of 50% is set and the actual value response is examined.

Example: high amplification

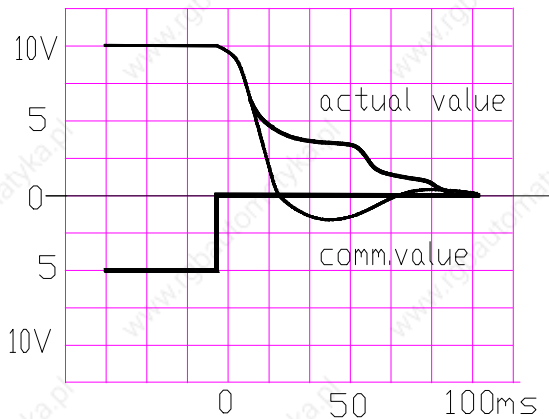

low amplification

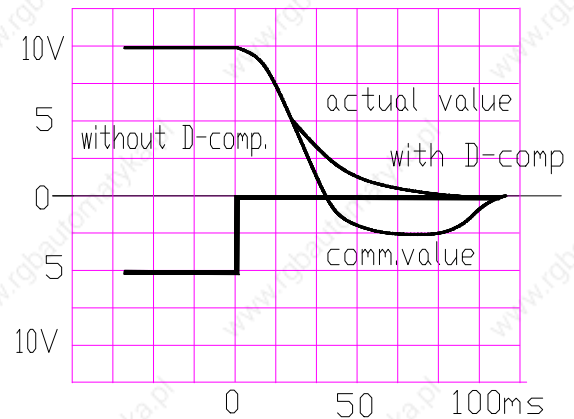

The switches S6:K2 and S2:K3 must be closed.

The peak current can be adjusted separately for both current directions between 0 and 200% type current by means of the potentiometers P5 (I_{max1}) and P6 (I_{max2}).
right full scale = max. current

The switches S6:K2 and S2:K3 must be open.

The current limiting can be adjusted by means of an external voltage across X1:16c (X1:9) I_{max1} and across X1:14c (X1:10) I_{max2} . The external signal can be attenuated by means of the internal potentiometers P5 (I_{max1}) and P6 (I_{max2}). For the combination of speed-torque control the torque is adjusted at the inputs X1:16c and X1:14c.

By means of the potentiometer P7 (I_D) it is possible to adjust the continuous current for both torque directions between 2 and 100% of the type current. The reset time of the current limit from peak to continuous current depends on the previous continuous current demand. This means, that a long peak current time (approx. 2 s) is available with a low current and that in case of a high continuous current (80% type current) the peak current time is reduced to approx. 0.5 s. For the combination of speed-torque control the torque is adjusted at the inputs X1:16c and X1:14c.

The commutation limit must be checked when using a dc motor with a permanent excitation (no field) and iron core. The motor data sheets show the limiting curve of the permissible motor current dependent on the speed. The maximum torque of the motors, which corresponds to the maximum current, is 3 to 6 times the value of the continuous torque. For servo-amplifiers it is twice the value.

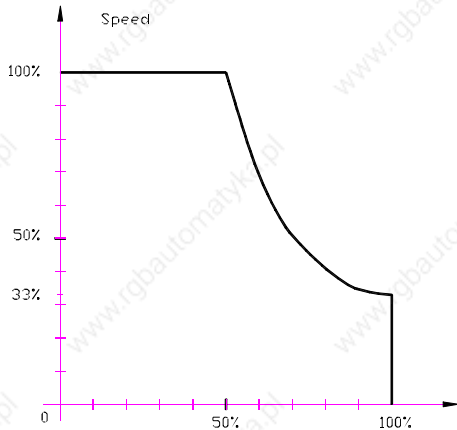

Take this motor curve as an example. The linear limit characteristic of the servo-amplifier must be within the motor characteristic.

The limiting line for the amplifier is drawn at 2 x I-rated (which corresponds to 10V current command value). Then the straight reduction line is drawn tangentially to the motor characteristic.

1. Determine the max. permissible current for maximum speed (triggering point IN2 [%])

2. Determine the slope s of the current straight reduction line up to maximum speed.

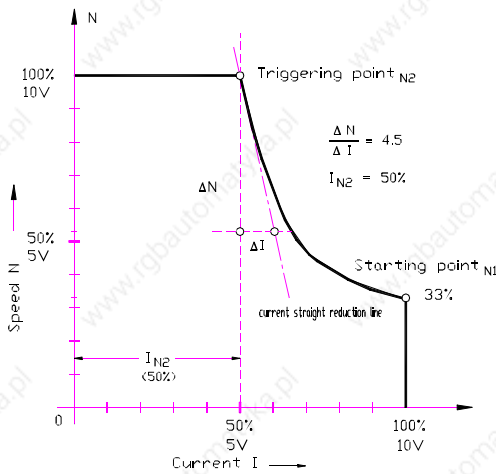

$$s = \frac{\Delta \text{Speed} [\%]}{\Delta \text{Current} [\%]}$$

3.

$$[R190] = \frac{100}{s} \text{ [k}\Omega\text{]}$$

4.

$$[R111] = \frac{47 \cdot \left(2 - \frac{1}{s}\right) I_{N2}}{200 - \left(2 - \frac{1}{s}\right) I_{N2}} \text{ [k}\Omega\text{]}$$

5.

Determine the first break point with Zener voltage Uz [V]

6. Determine the starting point of the current reduction with IN1 [%]

7.

$$[R112] = \frac{1}{\frac{1}{4.7 \cdot \left(10 - U_z - \frac{I_{N1}}{10}\right)} \Big|_{10 - U_z} - 10^{-3}} \text{ [k}\Omega\text{]}$$

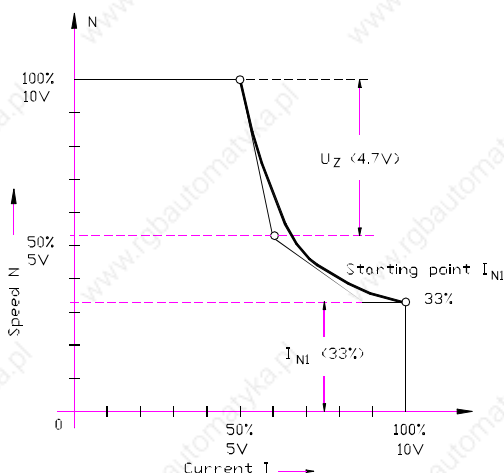

On delivery the devices are equipped with the following components: R190, R111, R112, and DZ2. The values are indicated in the following example:

5 Commissioning

Example: Peak current of the controller = 20A

<ol style="list-style-type: none"> 1. I_{N2} sei 10A $\hat{=} 50\%$ 2. S ist $\frac{\Delta N [\%]}{\Delta I [\%]} = 4.5$ 3. $R190 = \frac{100}{4.5} = 22.22 k\Omega$ 4. $R111 = \frac{47 \cdot (2 - \frac{1}{4.5}) \cdot 50\%}{200 - (2 - \frac{1}{4.5}) \cdot 50\%} = 37.6 k\Omega$ 5. U_Z sei 4.7 [V] 6. I_{N1} sei 6.7A $\hat{=} 33\%$ 7. $R112 = \frac{1}{\frac{1}{4.7 \cdot (10 - 4.7 - \frac{3}{10})} - 10^{-3}} = 10.3 k\Omega$ 	$\left. \begin{array}{l} \text{1.} \\ \text{2.} \end{array} \right\} \text{acc. motor data sheed}$ $\left. \begin{array}{l} \text{5.} \\ \text{6.} \end{array} \right\} \text{acc. motor data sheed}$	<p style="text-align: center; border-bottom: 1px solid black;">Standards</p> <p>22kΩ</p> <p>39kΩ</p> <p>ZPD 4V7</p> <p>10kΩ</p>
---	--	--

1. Connection Instructions

Connect the device according to this manual (TV6.2)

Note:

Supply voltage for TV6.2 **max. 110V~, 160 V=**

2. Commissioning

Basic connections: mains, tacho or armature voltage feedback, enable, command value

2.1 Enable switch: open/enable voltage 0V

Command value voltage 0V, command value additional input: bridged to GND.

Adjust switch S9 to tacho voltage, for armature voltage control adjust to 0.

Switch S4 in position 2, switch S5 in position 2

Adjust potentiometer I_{max} to approx. 10%.

- Potentiometer Xp = to 50%
 - Potentiometer ID = 100%
 - Potentiometer IxR = left full scale
 - Potentiometer n_{max} = left full scale
 - Potentiometer INT = left full scale
- Jumpers S6, S13, S14, and SW1(2-3), SW2 (2-3) are plugged.

2.2 Switching on the power

TV6: The LEDs 19-A (BTB), 19-D (stationary), 7-C (+15V), and 7-D (-15) must light. All other LEDs do not light.

2.3 Close the enable switch or apply an enable voltage $>10V$

TV6: The LED 19-G (enable) must also light.

The drive must be stationary or turn very slowly (offset).

If the drive accelerates in the correct direction, the polarity of the tacho voltage resp. the armature voltage feedback must be swapped.

If the drive accelerates in the wrong direction, the armature polarity must be swapped.

2.4 Increase the command value voltage to approx. 10%.

The drive must accelerate to approx. 10% of its maximum speed.

If the direction of rotation is wrong the polarities of the tacho and the armature must be swapped.

2.5 Amplification of the current controller

The proportional amplification of the current controller can be halved by inserting jumper S12.

The response of the current controller can be measured at the measuring point X4.6 by means of an oscilloscope.

2.6. Amplification of the speed controller

Adjust the P-component to a low position 1... 5 (switch S4).

Adjust the I-component according to the centrifugal mass of the drive (switch S5):

big centrifugal mass - high adjusted value

small centrifugal mass - low adjusted value

At 10% of the speed, increase the amplification by turning the potentiometer XP clockwise until the drive oscillates. Then turn the potentiometer approx. 10% anti-clockwise starting from the oscillation point.

An exact adjustment can be achieved by measuring the controller response at the measuring point X4:3 by means of an oscilloscope.

(rf. to page 30)

2.7 Further adjustments such as speed, peak current, continuous current, etc.

rf. to the chapter 'Adjustments'

2.8 Switching off the device

If the enable contact is opened or the enable voltage is switched off, the drive will brake until being stationary. After 2 s the drive is disabled.

2.9 Document the set-up in the protocol and fix the adjustment potentiometers.

6 Protocol

Customer

Machine No.

Device

Serial No

Supply voltage

[V=,V~].....

Inputs

Enable contact ? voltage [V=]

Command value type voltage [V=]

Command value additional type voltage [V=]

Current command value I_{max1} external voltage [V=]

Current command value I_{max2} external voltage [V=]

Speed controller settings

Switches

Tacho adjustment	S9	Position
P-component	S4	Position
I-component	S5	Position

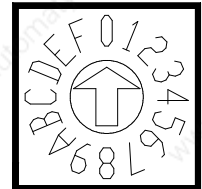

Potentiometers

Speed	n_{max}	P4	Position
Peak current	I_{max1}	P5	Position
Peak current	I_{max2}	P6	Position
Continuous current	I_D	P7	Position
Integrator	INT	P1	Position
Amplification	X_p	P3	Position
IxR Kompensation		P2	Position

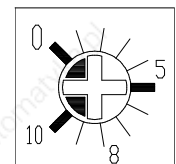
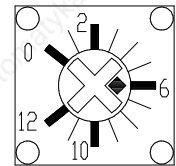

Optional switch

closed ON No.

open OFF No.

Power section settings

Measured data

Armature voltage max. [V=]

Armature current peak [A=]

Armature current continuous [A=]

Tacho voltage max. [V=]

Acceleration [V/ms]

Integrator [V/ms]

Motor data

Type plate specifications

Manufacturer

Type Serial No

Motor voltage [V=] Motor current [A=]

Tacho voltage [V/min-1]..... Tacho type

Brake [V] Fan [V]

7 Guarantee

UNITEK guarantees that the device is free from material and production defects. Test results are recorded and archived with the serial number.

The guarantee time begins from the time the device is shipped, and lasts one year. Unitek undertakes no guarantee for devices which have been modified for special applications.

During the warranty period, UNITEK will, at its option, either repair or replace products that prove to be defective, this includes guaranteed functional attributes. UNITEK specifically disclaims the implied warranties or merchantability and fitness for a particular purpose. For warranty service or repair, this product must be returned to a service facility designated by UNITEK.

For products returned to UNITEK for warranty service, the Buyer shall prepay shipping charges to UNITEK and UNITEK shall pay shipping charges to return the product to the Buyer.

However, the Buyer shall pay all shipping charges, duties, and taxes for products returned to UNITEK from another country.

The foregoing warranty shall not apply to defects resulting from:

- * improper or inadequate repairs effected by the Buyer or a third party,
- * non-observance of the manual which is included in all consignments,
- * non-observance of the electrical standards and regulations
- * improper maintenance
- * acts of nature

All further claims on transformation, diminution, and replacement of any kind of damage, especially damage, which does not affect the UNITEK device, cannot be considered. Follow-on damage within the machine or system, which may arise due to malfunction or defect in the device cannot be claimed.

This limitation does not affect the product liability laws as applied in the place of manufacture (i. e. Germany).

UNITEK reserves the right to change any information included in this MANUAL.

All connection circuitry described is meant for general information purposes and is not mandatory.

The local legal regulations, and those of the Standards Authorities have to be adhered to. UNITEK does not assume any liability, expressively or inherently, for the information contained in this MANUAL, for the functioning of the device or its suitability for any specific application.

All rights are reserved.

Copying, modifying and translations lie outside UNITEK's liability and thus are not prohibited. UNITEK's products are not authorised for use as critical components in the life support devices or systems without express written approval.

The onus is on the reader to verify that the information here is current.

Transistor Servo-Drive TV6.2



8 Circuit Diagrams

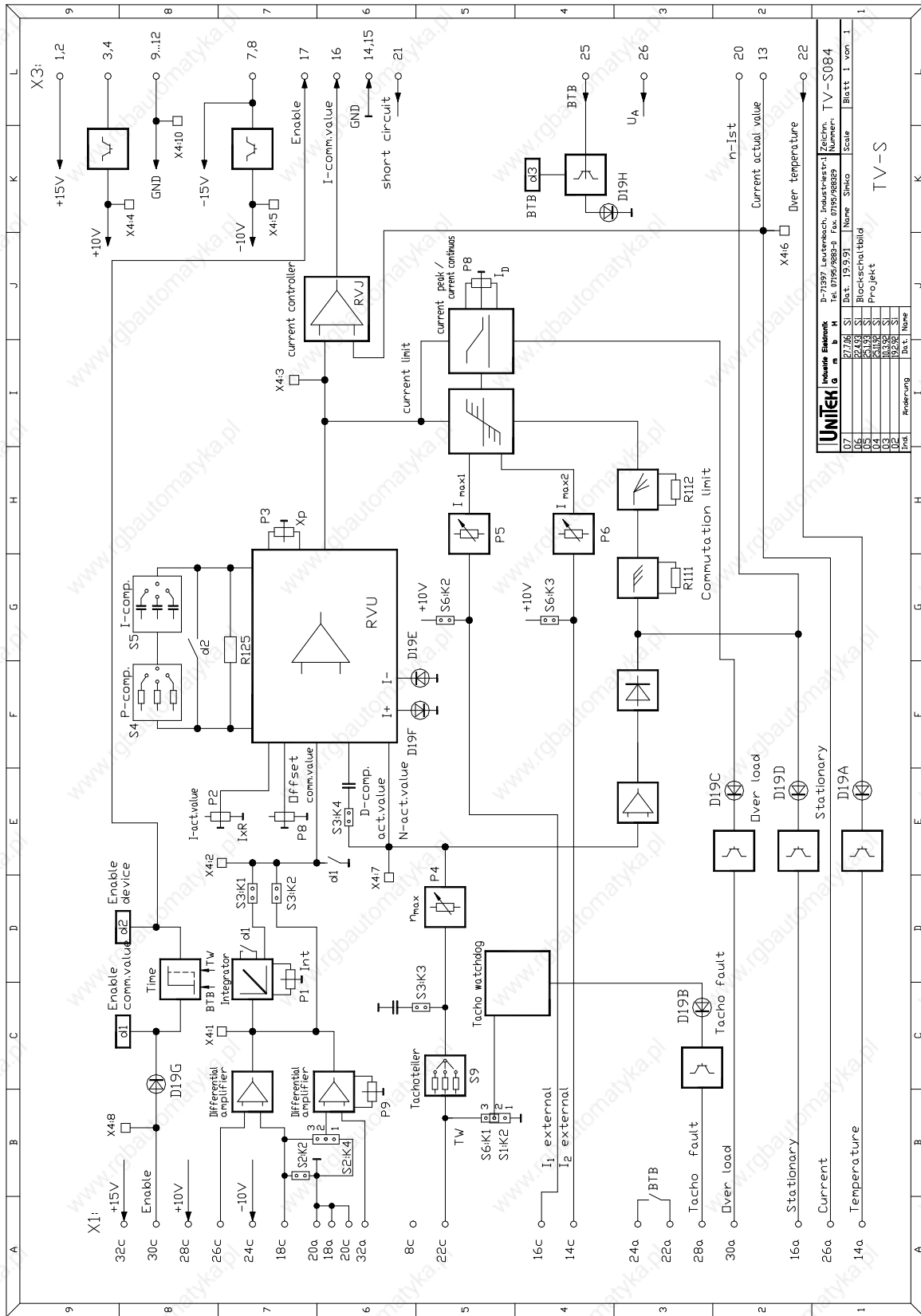

UNITEK		Industrie Elektronik		D-7197 Leutenbach, Industriestraße 4		Zeichn. Nummer, TV-S084	
Ind.	Änderung	Doc. t.	Name	Scale	Blatt	I von 1	
07		27.06	S1	1:1	1	Blatt 1 von 1	
06		24.10	S2	1:1	1	Blatt 1 von 1	
04		04.09	S3	1:1	1	Blatt 1 von 1	
03		09.09	S4	1:1	1	Blatt 1 von 1	
02		09.09	S5	1:1	1	Blatt 1 von 1	
01		09.09	S6	1:1	1	Blatt 1 von 1	

TV-S

Transistor Servo-Drive TV6.2

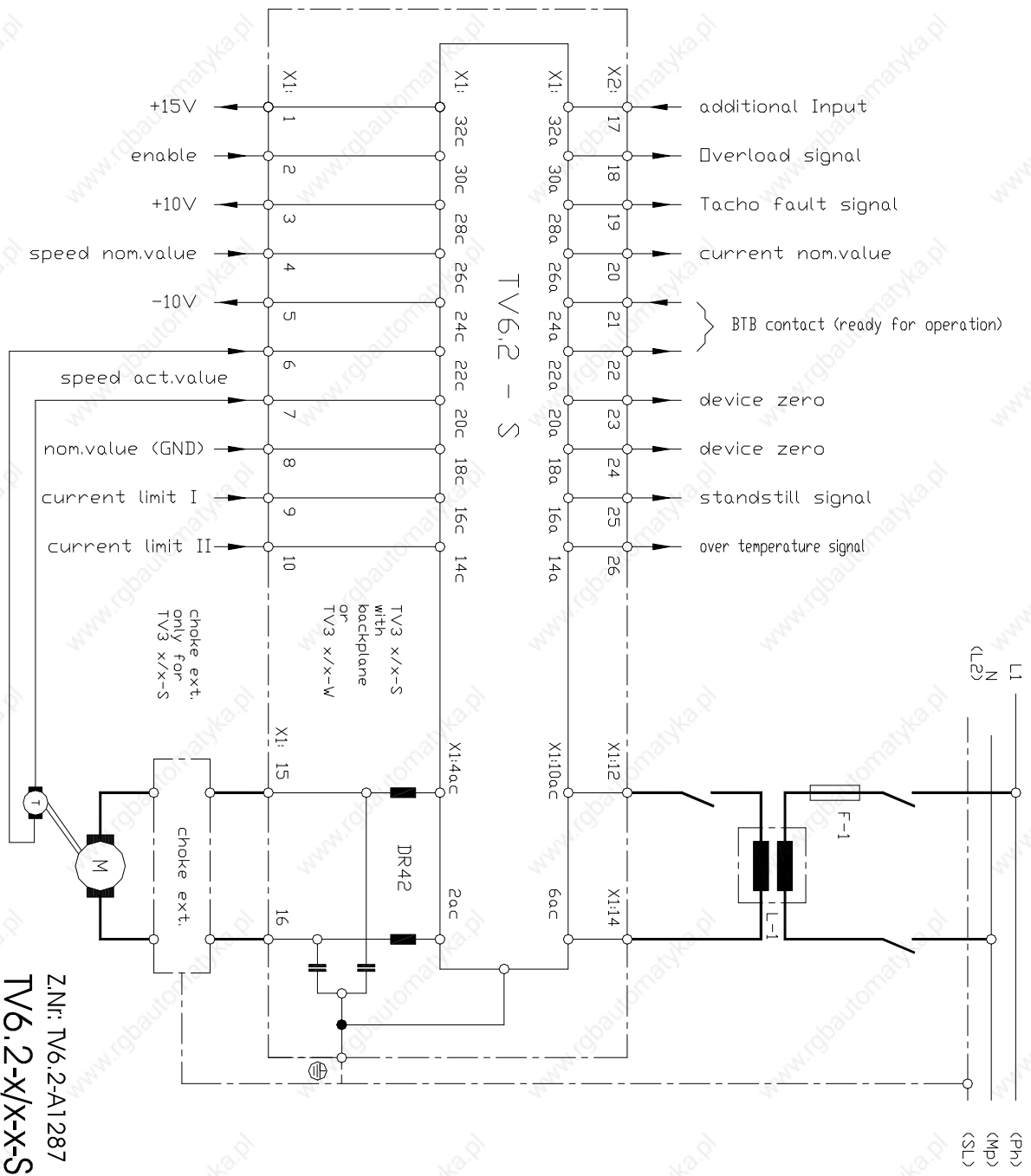

8 Circuit Diagrams

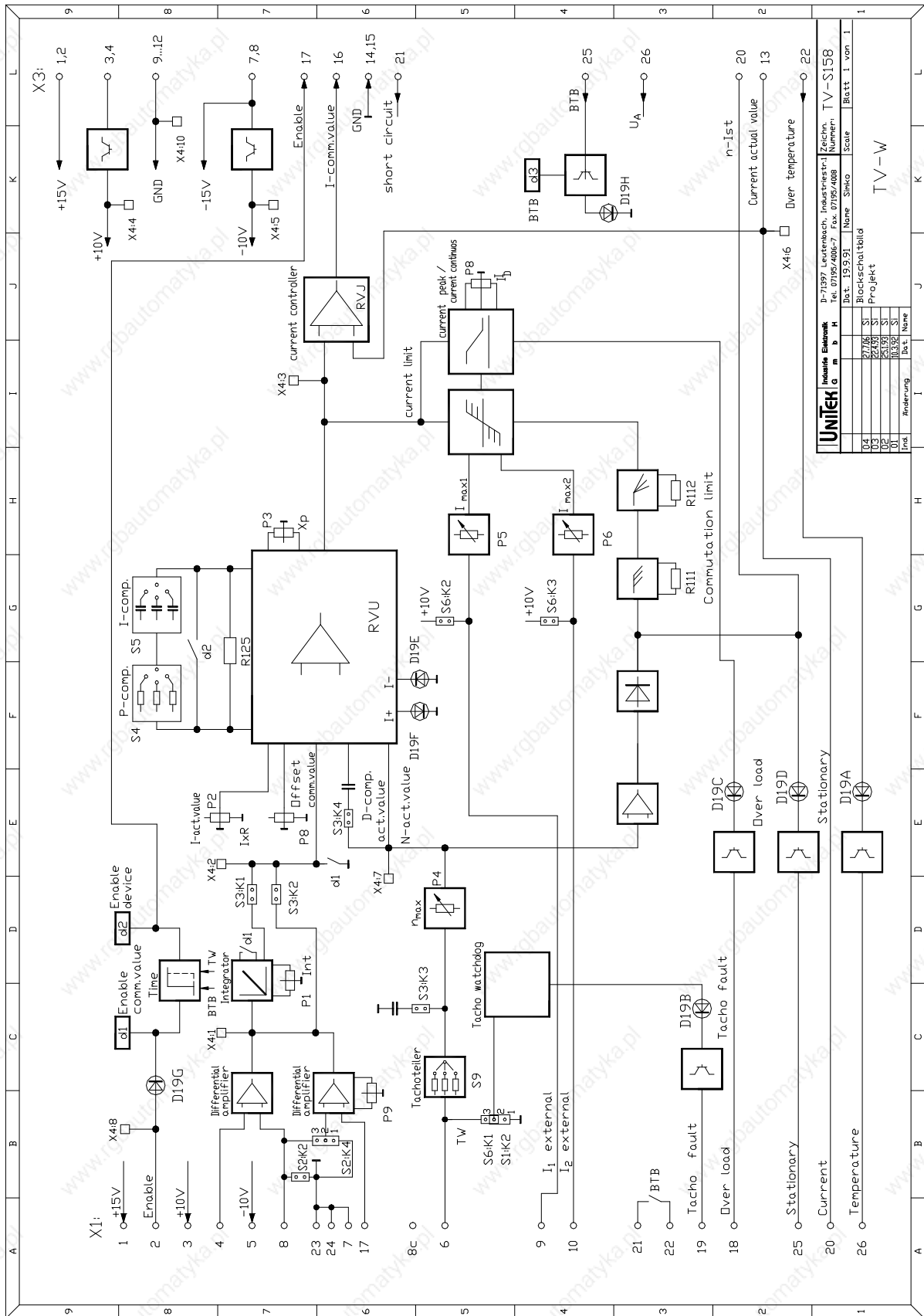

Transistor Servo-Drive TV6.2

