

INVERTER FOR FAN AND PUMP APPLICATIONS

Instruction Manual

The new generation
high-performance inverter

TOSVERT™ VF-P7

200V class 18.5 ~ 110kW

400V class 18.5 ~ 315kW

Toshiba Schneider Inverter Corporation

NOTICE

1. Make sure that this instruction manual is delivered to the end user of the inverter unit.
2. Read this manual before installing or operating the inverter unit, and store it in a safe place for reference.



© Toshiba Schneider Inverter Corporation 2001
All Rights Reserved.

Safety precautions	<i>I</i>
Preface	<i>II</i>
Contents	
Read this section first	<i>1</i>
Connection	<i>2</i>
Operating the inverter	<i>3</i>
Basic Operation	<i>4</i>
Basic parameters	<i>5</i>
Extended parameters	<i>6</i>
Operation with external signal	<i>7</i>
Monitoring operation status	<i>8</i>
Peripheral units	<i>9</i>
Table of parameters	<i>10</i>
Specification	<i>11</i>
Prior to service call	<i>12</i>
Regular inspection and maintenance	<i>13</i>
Warranty	<i>14</i>
Precautions of disposal	<i>15</i>

. Safety precautions





The labels on the inverter and this instruction manual contain important instructions for the prevention of possible injury to the user and other persons and damage to property, as well as for the safe use of the inverter. Please gain a good understanding of the following pictorial symbols before reading this manual and strictly observe the instructions that follow each symbols.

Marking

Symbols	Meaning
 Danger	Means that improper use or handling could cause the risk of death or serious injury
 Warning	Means that improper use or handling could cause injury to persons(*1) or damage to property(*2).

(*1)"injury to persons" refer to injuries, burns, electric shocks, and so on, that do not oblige the injured person to be hospitalized or go to a hospital for a long period of time for medical treatment.

(*2)"damage to property" includes all kinds of losses resulting from it.

Symbols	Meaning
	Represents prohibition(what you must not do) What you must not do is described in or near this symbol by a picture or words
	Represents mandatory items(what you must do) What you must do is described in or near this symbol by a picture or word
	Represents danger What is dangerous is described in or near this symbol by a picture or word
	Represents warning What the warning should be applied is described in or near this symbol by a picture or word

Limited applications

This inverter is designed to control the speed of three-phase induction motors for general industry.







Precautions



When using our inverters for equipment such as nuclear power control equipment, aviation and space flight control equipment, traffic equipment, and safety equipment, and there is a risk that any failure or malfunction of the inverter could directly endanger human life or cause injury, please contact our headquarters, branch, or office printed on the front and back covers of this catalogue. Such applications must be studied carefully.

When using inverters for critical equipment, even though the inverters are manufactured under strict quality control always fit your equipment with safety devices to prevent serious accident or loss should the inverter fail(such as failure to issue an inverter trouble signal)



Do not use our inverters for any load other than three phase induction motors.



Handling in general

 Danger		Reference
 Never Disassemble	Never disassemble, modify or repair the inverter. Its disassembly could cause an electric shock, a fire or an injury. Request your TOSHIBA dealer for repair.	2.
 Prohibited	<p>-Never open the front cover of the inverter (or the door of the cabinet in which the inverter is installed) when the inverter is energized, or you could get a shock since a high voltage is applied to certain portions of it.</p> <p>-Do not put your fingers into the panel through a wiring opening or an opening in the cooling fan cover, or you could get a shock or an injury.</p> <p>-Do not put or insert anything (e.g., electric cable, bar or steel wire) into the inverter, or the inverter could cause a shock or fire.</p> <p>-Do not splash water over the inverter, or the inverter could cause a shock or a fire.</p>	2. 2. 2. 2.
 Mandatory	<p>-Do not turn on the power before attaching the front cover (or closing the door of the cabinet in which the inverter is installed), or you could get a shock.</p> <p>-Turn off the power immediately in case the inverter smokes, smells of smoke, or produce abnormal noise. Failure to do so could lead to a fire. In such a case, request your TOSHIBA dealer for repair.</p> <p>-Due to the possibility of contaminants entering the drive, disconnect the input power if the drive will be unused for extended periods. The leakage current caused by the contamination may result in fire.</p>	2. 3. 3. 3.



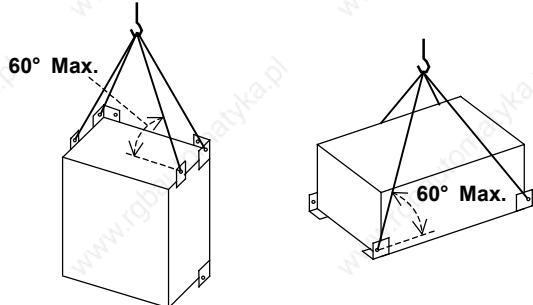

 Warning		Reference																								
 Never touch	Do not touch any heat sink or braking resistor, or you could get a burn since they become very hot.	3.																								
 Prohibited	<p>-Do not install the inverter where any of the unallowable chemicals solvents listed below can be sprayed, or its plastic front cover could come off or a plastic unit could fall off although damage sustained by plastic parts depends on their shapes. If you intend to install the inverter where a chemical or solvent other than those listed below is used, consult your TOSHIBA dealer in advance.</p> <table style="width: 100%; border-collapse: collapse;"> <tr> <td style="width: 50%; vertical-align: top;"> <p>(Table 1)</p> <p>Allowable chemicals and solvents</p> <table border="1" style="width: 100%; border-collapse: collapse;"> <thead> <tr> <th style="width: 50%;">Chemical</th> <th style="width: 50%;">Solvent</th> </tr> </thead> <tbody> <tr> <td>Hydrochloric acid (concentration of less than 10%)</td> <td>Methanol</td> </tr> <tr> <td>Sulfuric acid (concentration of less than 10%)</td> <td>Ethanol</td> </tr> <tr> <td>Nitric acid (concentration of less than 10%)</td> <td>Triol</td> </tr> <tr> <td>Caustic soda</td> <td>Mesopropanol</td> </tr> <tr> <td>Ammonia</td> <td>Glycerin</td> </tr> <tr> <td>Sodium chloride</td> <td></td> </tr> </tbody> </table> </td> <td style="width: 50%; vertical-align: top;"> <p>(Table 2)</p> <p>Unallowable chemicals and solvents</p> <table border="1" style="width: 100%; border-collapse: collapse;"> <thead> <tr> <th style="width: 50%;">Chemical</th> <th style="width: 50%;">Solvent</th> </tr> </thead> <tbody> <tr> <td>Phenol</td> <td>Gasoline, Kerosene, light oil</td> </tr> <tr> <td rowspan="3">Benzene sulfonic acid</td> <td>Turpentine oil</td> </tr> <tr> <td>Benzol</td> </tr> <tr> <td>Thinner</td> </tr> </tbody> </table> </td> </tr> </table> <p>Note) The above instances are for tolerance of changing shape of plastic cover, not of ignition or explosiveness.</p>	<p>(Table 1)</p> <p>Allowable chemicals and solvents</p> <table border="1" style="width: 100%; border-collapse: collapse;"> <thead> <tr> <th style="width: 50%;">Chemical</th> <th style="width: 50%;">Solvent</th> </tr> </thead> <tbody> <tr> <td>Hydrochloric acid (concentration of less than 10%)</td> <td>Methanol</td> </tr> <tr> <td>Sulfuric acid (concentration of less than 10%)</td> <td>Ethanol</td> </tr> <tr> <td>Nitric acid (concentration of less than 10%)</td> <td>Triol</td> </tr> <tr> <td>Caustic soda</td> <td>Mesopropanol</td> </tr> <tr> <td>Ammonia</td> <td>Glycerin</td> </tr> <tr> <td>Sodium chloride</td> <td></td> </tr> </tbody> </table>	Chemical	Solvent	Hydrochloric acid (concentration of less than 10%)	Methanol	Sulfuric acid (concentration of less than 10%)	Ethanol	Nitric acid (concentration of less than 10%)	Triol	Caustic soda	Mesopropanol	Ammonia	Glycerin	Sodium chloride		<p>(Table 2)</p> <p>Unallowable chemicals and solvents</p> <table border="1" style="width: 100%; border-collapse: collapse;"> <thead> <tr> <th style="width: 50%;">Chemical</th> <th style="width: 50%;">Solvent</th> </tr> </thead> <tbody> <tr> <td>Phenol</td> <td>Gasoline, Kerosene, light oil</td> </tr> <tr> <td rowspan="3">Benzene sulfonic acid</td> <td>Turpentine oil</td> </tr> <tr> <td>Benzol</td> </tr> <tr> <td>Thinner</td> </tr> </tbody> </table>	Chemical	Solvent	Phenol	Gasoline, Kerosene, light oil	Benzene sulfonic acid	Turpentine oil	Benzol	Thinner	1.4.4
<p>(Table 1)</p> <p>Allowable chemicals and solvents</p> <table border="1" style="width: 100%; border-collapse: collapse;"> <thead> <tr> <th style="width: 50%;">Chemical</th> <th style="width: 50%;">Solvent</th> </tr> </thead> <tbody> <tr> <td>Hydrochloric acid (concentration of less than 10%)</td> <td>Methanol</td> </tr> <tr> <td>Sulfuric acid (concentration of less than 10%)</td> <td>Ethanol</td> </tr> <tr> <td>Nitric acid (concentration of less than 10%)</td> <td>Triol</td> </tr> <tr> <td>Caustic soda</td> <td>Mesopropanol</td> </tr> <tr> <td>Ammonia</td> <td>Glycerin</td> </tr> <tr> <td>Sodium chloride</td> <td></td> </tr> </tbody> </table>	Chemical	Solvent	Hydrochloric acid (concentration of less than 10%)	Methanol	Sulfuric acid (concentration of less than 10%)	Ethanol	Nitric acid (concentration of less than 10%)	Triol	Caustic soda	Mesopropanol	Ammonia	Glycerin	Sodium chloride		<p>(Table 2)</p> <p>Unallowable chemicals and solvents</p> <table border="1" style="width: 100%; border-collapse: collapse;"> <thead> <tr> <th style="width: 50%;">Chemical</th> <th style="width: 50%;">Solvent</th> </tr> </thead> <tbody> <tr> <td>Phenol</td> <td>Gasoline, Kerosene, light oil</td> </tr> <tr> <td rowspan="3">Benzene sulfonic acid</td> <td>Turpentine oil</td> </tr> <tr> <td>Benzol</td> </tr> <tr> <td>Thinner</td> </tr> </tbody> </table>	Chemical	Solvent	Phenol	Gasoline, Kerosene, light oil	Benzene sulfonic acid	Turpentine oil		Benzol	Thinner		
Chemical	Solvent																									
Hydrochloric acid (concentration of less than 10%)	Methanol																									
Sulfuric acid (concentration of less than 10%)	Ethanol																									
Nitric acid (concentration of less than 10%)	Triol																									
Caustic soda	Mesopropanol																									
Ammonia	Glycerin																									
Sodium chloride																										
Chemical	Solvent																									
Phenol	Gasoline, Kerosene, light oil																									
Benzene sulfonic acid	Turpentine oil																									
	Benzol																									
	Thinner																									

Transportation • Installation

 Danger		Reference
 Prohibited	<ul style="list-style-type: none"> -Do not install or operate the inverter if it is damaged or any part is missing from it. Operating the inverter in a defective condition could lead to a shock or a fire. Request your Toshiba dealer for repair. -Do not put any inflammable material near the inverter, or it could catch a fire if the inverter sparks because of a breakdown, etc. -Do not install the inverter where it can be splashed with water, etc., or it could cause a shock or a fire. 	<p style="text-align: center;">2.</p> <p style="text-align: center;">1.4.4</p> <p style="text-align: center;">2.</p>
 Mandatory	<ul style="list-style-type: none"> -Use the inverter under environmental conditions specified by this instruction manual, or it could break down. -Install the inverter on a non-combustible board, for example, a steel plate. Installing it on a inflammable board or wall could lead to a fire because its back is heated up during operation. -Do not use the inverter with the front cover detached, or it could cause a shock. -Install an emergency shutdown device which matches the system (for example, a switch interlocked with the brake of the machine). Failure to do so could lead to injury to persons since it has no emergency stop function. -Do not use any optional devices other than those designated by our company. The use of improper devices could lead to accidents. 	<p style="text-align: center;">1.4.4</p> <p style="text-align: center;">1.4.4</p> <p style="text-align: center;">1.4.4</p> <p style="text-align: center;">1.4.4</p> <p style="text-align: center;">1.4.4</p>

 Warning		Reference
 Prohibited	<ul style="list-style-type: none"> -Do not hold the front cover to carry the inverter, or the cover could come off and cause the main unit to fall, thus causing you to get an injury. -Do not install the inverter in any place subject to vibration, or it could fall, causing injury to persons. 	<p style="text-align: center;">2.</p> <p style="text-align: center;">1.4.4</p>
 Mandatory	<ul style="list-style-type: none"> -For a model (20 kg or more in weight) designed for 30kW motors or larger, carry it at least in a twosome, or it could fall and cause you to get an injury. -Handle large capacity model using a crane. Lifting heavy inverter causes injury to persons. Taking care of safety for users, carefully handle in order not to damage to the inverter. Carefully lift up the inverter, hanging wires on the hanging bolts or halls on the top or bottom of the inverter. -Four points and perpendicular lifting is recommended. Even if perpendicular lifting is impossible, respect the condition described in the following figure. A crack may be attached to the product body when not performing perpendicular lifting. Please be careful. <div style="text-align: center;">  </div> <ul style="list-style-type: none"> -Install the main unit on a wall, or the like, which is strong enough to withstand its weight, or it could fall and cause injury to persons. -Install a mechanical brake whenever the motor requires a brake (device which retains the motor shaft). Failure to do so could lead to injury to persons because the inverter itself has no function of mechanically retaining the brake shaft. 	<p style="text-align: center;">2.</p> <p style="text-align: center;">-</p> <p style="text-align: center;">1.4.4</p> <p style="text-align: center;">1.4.4</p>

Wiring



 Danger		Reference
 Prohibited	<ul style="list-style-type: none"> -Do not connect the power cable to any output terminal (U/T1, V/T2 or W/T3 on the motor side), or the inverter could break down and cause a fire. -Do not connect a resistor to any D.C. terminal (between PA and PC or PO and PC), or the inverter could cause a fire. To install external braking resistor, refer to 6.13.4. -Don't touch the connector terminals and cables of the devices(MCCB) on the input side of the inverter within 10 minutes after shutting down the power source 	<p>2.2</p> <p>2.2 6.13.4</p> <p>2.2</p>
 Mandatory	<ul style="list-style-type: none"> -Entrust all electrical work to an experienced specialist. Wiring by an inexperienced person could result in a fire or an electric shock. -Connect the output terminals (on the motor side) correctly. Incorrect connection of the terminals causes the motor to rotate in a wrong direction, and thus could result in injury to persons. -Perform wiring always after installing the inverter, or you could get a shock or an injury. -Be sure to perform the following preparatory work before proceeding to wiring. <ol style="list-style-type: none"> (1) Turn off the power. (2) 10 minutes or more after turning off the power, make sure that charge lamp is extinct. (3) Using a circuit tester with a D.C. voltage measuring capacity of more than 800V, check to be sure that the voltage remaining in the D.C. main circuit (between PA and PC) is below 45V. Failure to do so could lead to an electric shock. -Tighten the terminal board fixing screws at the specified torque. Failure to do so could lead to a fire. -Make sure that the supply voltage is within +10%/-15% (during continuous operation or within $\pm 10\%$ under full load) of the inverter's rated voltage specified on its rating label. Supplying a voltage exceeding the above range could lead to a breakdown, an electric shock or a fire. 	<p>2.</p> <p>2.</p> <p>2.</p> <p>2.</p> <p>2.</p> <p>1.4.4</p>
 Be Grounded	<ul style="list-style-type: none"> -Connect grounding wires correctly and securely. Otherwise, a breakdown or electric leakage could lead to an electric shock or a fire. 	<p>2.</p> <p>2.2</p> <p>9.</p>

Warning

Charged capacitors can present a shock hazard even after source power is removed



Drives with EMI filters will retain a charge on the input terminals for up to 10 min. after the power has been removed. To avoid electrical shock, don't touch the connector terminals and uninsulated source cables at either the main circuit disconnect or the drive until the capacitive charge has dissipated.

About operation



 Danger		Reference
 Prohibited	<ul style="list-style-type: none"> -Do not touch any inverter's terminal when it is energized even if the motor is standstill, or you could get a shock. -Do not operate switches with a wet hand or not put a wet cloth on the inverter, or you could get a shock. -Do not get near the alarm-stopped motor when the system is in retry mode, or you could get an injury. Take safety measures, for example, attaching a cover to the motor, to protect persons against accidents when the motor unexpectedly restarts. -Don't set the motor constant 3 (exciting inductance: F404) as 1/2 or less value of default setting value. If the motor constant 3 (exciting inductance :F404) is set as extremely small value, the stole prevention function will incorrect-operate and will raise output frequency. -Don't set the stole prevention level(F501) as extremely small value. When the stole prevention level(F501) is set as motor no-load current or value lower than it, the stole prevention function always operates. And if it is judged as regeneration mode, frequency will be raised. Please do not set the stole prevention level(F501) to 30% or less in the usual usage. 	<p>3.</p> <p>3.</p> <p>3.</p> <p>6.21</p> <p>6.25.2</p>
 Mandatory	<ul style="list-style-type: none"> -Do not turn on the power before attaching the front cover. When the inverter is installed in a cabinet with the inverter's front panel detached, always close the door of the cabinet before turning on the power. Turning on the power with the cover or the door left opened could lead to an electric shock. -Turn off the operation signal before resetting the inverter after trouble, or the motor unexpectedly restarts, causing injury to persons. 	<p>3.</p> <p>9.</p> <p>3.</p>

 Warning		Reference
 Mandatory	<ul style="list-style-type: none"> -Operate the motor always within the allowable operation range. (Refer to the motor's instruction manual for the allowable operation range.) Failure to do so could cause injury to persons. 	<p>3.</p>



When selecting the sequence that automatically restarts the motor after recovery from a momentary power failure (Applicable to inverters)

 Warning		Reference
 Mandatory	<ul style="list-style-type: none"> -Do not get near the motor or the machine. The motor and the machine unexpectedly restart after recovery from a momentary power failure. -Stick caution labels to the inverter, the motor and the machine, to prevent accidents due to an unexpected restart of them after recovery from a momentary power failure. 	<p>6.13.1</p>



When selecting the retry mode (Applicable to inverters)

 Warning		Reference
 Mandatory	<p>-Do not get near the motor. When the retry mode is selected, the motor and machine that stopped after an alarm restart unexpectedly after the selected time has passed, thus causing injury to persons.</p> <p>-Stick caution labels to the inverter, the motor and the machine, to prevent accidents due to an unexpected restart of them in retry mode.</p>	6.13.3

About inspection and maintenance

 Danger		Reference
 Prohibited	-Do not replace any part yourself, or you could get a shock or an injury, or cause a fire. Request your Toshiba dealer for replacement of parts.	13.2
 Mandatory	<p>-Carry out inspection and maintenance on a daily basis. Failure to do so to find defects in the inverter could lead to accidents.</p> <p>-Be sure to perform the following preparatory work before proceeding to inspection.</p> <p>(1) Turn off the power.</p> <p>(2) 10 minutes or more after turning off the power, make sure that charge lamp is extinct.</p> <p>(3) Using a circuit tester with a D.C. voltage measuring capacity of more than 800V, check to be sure that the voltage remaining in the D.C. main circuit (between PA and PC) is below 45V.</p> <p>Failure to do so could lead to an electric shock.</p>	13. 13. 13.2

About disposal of inverters

 Warning		Reference
 Mandatory	<p>-When you throw away the inverter, have it done by a specialist in industrial waste disposal*.</p> <p>If the collection, transport and disposal of industrial waste is done by someone who is not licensed, it is punishable as a violation of the law. (Laws in regard to disposal and cleaning of waste.)</p> <p>(*)People who specialize in the processing of waste and are known as "industrial waste collectors and transporters" or "industrial waste disposal specialists".</p>	15.

Sticking warning labels

Here are examples of caution labels designed to prevent accidents caused by an inverter, a motor or a machine. When selecting the automatic restart function or the retry function, stick the applicable label to a conspicuous position.

Please stick this label to a conspicuous position when selecting the sequence that automatically restarts the machine after recovery from a mini power failure. (An example of the restart caution label)

 Warning (automatic restart function enabled)
Do not get near the motor or the machine. The motor and the machine which stopped. Because of a mini power failure, unexpectedly restart after the preset time has passed.

Please stick this label to a conspicuous position when selecting the retry function.

(An example of the retry caution label)

 Warning (Retry function enabled)
Do not get near the motor or the machine. The motor and the machine which stopped after an alarm, unexpectedly restart after the preset time has passed.

. Preface

Thank you for purchasing the fan and pump uses inverter "TOSVERT VF-P7".

This inverter has a "Ver. 312"CPU.

Please refer to "10. Table of parameters" for the functions available for the inverter with a CPU in this version.

The CPU version will be frequently upgraded.

Features

1. " VF-P7" complies with global standard
 - 1)" VF-P7" complies with the European CE marking requirements.
 - 2)" VF-P7" complies with the UL/cUL standard.
2. Excellent torque control performance
 - 1) High torque even at a frequency of 0.5 Hz(with vector control)
The speed control ratio is 1 :150.
 - 2) Torque limit function
3. A wide range of applications from simple speed control to system control
 - 1) Auto-tuning function
All you have to do make the " VF-P7" ready for start is to connect it to the motor and the power supply unit; the " VF-P7" does not require cumbersome parameter setting to start it.
 - 2) High flexibility and system expendability
" VF-P7" has a number of functions, including torque control, sensor (or sensorless) vector control, drooping function, commercial power/inverter switching function and various communication functions, which allow the inverter to be used as part of a system.
 - 3) Torque control
In addition to speed control by the frequency command, " VF-P7" is capable of speed control by the torque command, which is best suited to winding control.
4. Options that widen the range of application
 - Extended terminal board
 - Communication devices
(RS485, RS232C, TOSLINE-F10M/S20, DEVICE NET(*1), PROFI BUS(*1))
 - Add-on cassettes compatible with sensor vector control
(Speed feedback, torque control and positioning control, etc...)
 - Sensor vector control-compatible board
(Speed feedback, torque control)
 - Extension panel· Parameter writer
 - Other optional devices common to all models
 - Control power supply unit
 - Heat-sink attachment(*1): Planned

Contents sheet

. Safety precautions	1
. Preface	7
Contents sheet	8
1 . Read this section first	A-1
1.1 Checking the purchase	A-1
1.2 Contents of the product code	A-1
1.3 Names and functions	A-2
1.3.1 Panel description	A-2
1.3.2 Main circuit, control power supply and control circuit terminal boards	A-4
1.3.3 Detaching the terminal board front cover	A-7
1.4 Notes on the application of inverters	A-8
1.4.1 Notes on motors combined with inverters	A-8
1.4.2 Notes on inverters	A-10
1.4.3 Influences of leakage currents and measures against it	A-11
1.4.4 Notes on installation	A-13

Basic explanation

2 . Connection	B-1
2.1 Cautions as to wiring	B-1
2.2 Standard connection	B-3
2.3 Explanation of terminals	B-6
2.3.1 Main circuit terminals	B-6
2.3.2 Control circuit terminals (sink logic(minus common))	B-8
2.3.3 Serial RS485 communication connector	B-11

3 . Operating the inverter	C-1
3.1 Control modes of the VF-P7 inverter	C-2
3.2 Simple operation of the VF-P7 [1] [Speed control mode]	C-3
3.2.1 Operation from the terminal (external signals)	C-3
3.2.2 Operation from the control panel [Control panel operation]	C-6
3.3 Operation of the VF-P7 [2]	C-8
3.3.1 The outline of PID control	C-8
3.3.2 Settings of PID control	C-9
3.3.3 Adjustment of PID control	C-11

4 . Basic operation of the VF-P7	D-1
4.1 Setting parameters	D-1
4.1.1 How to set basic parameters	D-2
4.1.2 How to set extended parameters	D-4
4.1.3 Searching for changed parameters and changing their settings again	D-5
4.1.4 Parameters that cannot be changed during operation	D-7
4.1.5 Resetting all parameters to the factory default settings at a time	D-7

5 . Explanation of the basic parameters	E-1
5.1 Setting the acceleration and deceleration times	E-1
5.1.1 Automatic acceleration/deceleration	E-1
5.1.2 Manually setting the acceleration and deceleration times	E-2
5.2 Increasing starting torque/ energy-saving operation mode	E-3
5.3 Selecting an operation mode	E-6
5.4 Setting and calibrating meters	E-10
5.5 Factory default setting	E-13
5.6 Forward/reverse run selection (for the panel control only)	E-15
5.7 Maximum frequency	E-15
5.8 Upper and lower limit frequencies	E-16
5.9 Base frequency	E-16
5.10 Control mode selection	E-17
5.11 Switching between speed control and torque control	E-22
5.12 Manual torque boost - Increasing the torque produced at low speeds	E-24
5.13 Setting the electronic thermal protective function	E-24
5.14 Preset-speed operation (15 speeds)	E-28

Application explanation

6 . Extended parameters	F-1
6.1. Frequency signals	F-1
6.1.1. Low-speed signal	F-1
6.1.2. Putting out signals of arbitrary frequencies	F-2
6.2. Selection of input signals	F-3
6.2.1. Changing standby signal function	F-3
6.2.2. Priority selection (both F-CC, R-CC are ON)	F-3
6.2.3. Assigning priority to the terminal board in panel operation mode	F-4
6.2.4. Binary/BCD signal selection(Expansion TB option unit)	F-6
6.3. Selection of terminal functions	F-7
6.3.1. Keeping an input terminal function always active (ON)	F-7
6.3.2. Changing input terminal functions	F-7
6.3.3. Signal on completion of acceleration/deceleration (OUT 2)	F-7
6.3.4. Changing output terminal functions	F-8
6.3.5. Response times of input/output terminals	F-8
6.4. Basic parameters #2	F-9
6.4.1. Switching among V/f characteristics #1, #2, #3 and #4 from input terminal	F-9
6.5. V/f 5-point setting	F-10
6.6. Speed/torque command gain and bias	F-11
6.6.1. Using two types of frequency (speed) commands	F-11
6.6.2. Setting frequency command characteristics	F-13
6.6.3. Setting torque reference characteristics	F-13
6.7. Operation frequency	F-14
6.7.1. Start-up frequency and End frequency	F-14
6.7.2. Operating by means of reference signals	F-14
6.7.3. 0Hz dead band frequency	F-14
6.8. DC injection braking	F-15
6.8.1. DC injection braking	F-15
6.8.2. Motor shaft fixing control	F-16
6.8.3. Zero-speed stop mode selection	F-17

6.9. Jog run	F-18
6.10. Jump frequency - Jumping resonant frequencies	F-19
6.11. Preset-speed #8 ~ 15	F-19
6.12. PWM carrier frequency	F-20
6.13. Trip-less enhancement	F-20
6.13.1. Auto-restart (restart during free-run (coast))	F-20
6.13.2. Regenerative power ride-through control / Deceleration stop	F-23
6.13.3. Retry function	F-24
6.13.4. Dynamic (regenerative) braking - To urgently stop the motor	F-25
6.13.5. Avoiding over-voltage trip	F-28
6.13.6. Adjusting the output voltage and voltage compensation	F-28
6.13.7. Prohibiting the reverse operation	F-29
6.14. Drooping control	F-30
6.15. Function for crane/hoist	F-31
6.16. Commercial power/inverter switching	F-31
6.17. PID control	F-33
6.18. Speed feedback/positioning control	F-33
6.19. Preset speed operation mode	F-33
6.20. Setting motor constants	F-34
6.21. Torque control	F-39
6.21.1. Torque reference	F-39
6.21.2. Torque reference filter	F-40
6.21.3. Speed limits in torque control mode	F-41
6.21.4. Torque bias and load sharing gain	F-42
6.22. Torque limit	F-44
6.23. Secondary acceleration/deceleration	F-49
6.23.1. Acceleration and deceleration patterns	F-49
6.23.2. Switching of acceleration/deceleration #1, 2, 3 and 4	F-50
6.23.3. Minimum acceleration/deceleration times	F-52
6.24. Pattern run	F-53
6.25. Protection functions	F-56
6.25.1. Motor over road protection - level adjust / motor types	F-56
6.25.2. Setting of current stall	F-56
6.25.3. Inverter trip holding	F-56
6.25.4. Emergency stop	F-57
6.25.5. Overload reduction start-up frequency	F-57
6.25.6. Motor's 150%-overload time limit	F-57
6.25.7. Action at low currents	F-58
6.25.8. Detection of output phase failure	F-58
6.25.9. Over-torque trip	F-58
6.25.10. Cooling fan control mode selection	F-59
6.25.11. Cumulative operation time alarm	F-59
6.25.12. Over-voltage stall protection level	F-60
6.25.13. Under-voltage trip	F-60
6.25.14. UV stall level	F-60
6.25.15. System-supporting sequence (B-timer)	F-60
6.26. Special analog input	F-61
6.27. Over-ride	F-62

6.2.8. Meter output	•	F-64
6.2.8.1. Setting of meter outputs	•	F-64
6.2.8.2. Setting of optional meter outputs	•	F-64
6.2.8.3. Pulse output to meters	•	F-64
6.2.9. Control panel parameters	•	F-65
6.2.9.1. Prohibiting the change of parameter settings	•	F-65
6.2.9.2. Changing the units of display	•	F-65
6.2.9.3. Display the motor speed and the load speed	•	F-66
6.2.9.4. Column number below decimal point of Frequency, Acc/dec time	•	F-66
6.2.9.5. Changing items displayed in status monitor mode	•	F-67
6.2.9.6. Switching basic parameters	•	F-67
6.2.9.7. Selecting a control panel stop pattern	•	F-68
6.2.9.8. Resetting the inverter from the control panel	•	F-68
6.2.9.9. Selecting a torque limit in control panel operation mode	•	F-68
6.2.9.10. Canceling PID control in panel operation mode	•	F-69
6.2.9.11. Setting a torque command in panel operation mode	•	F-69
6.2.9.12. Drooping control in panel operation mode	•	F-69
6.2.9.13. Override in panel operation mode	•	F-69
6.2.9.14. Restricting or prohibiting key operation	•	F-70
6.3.0. Communication function (RS485/common serial)	•	F-71
6.3.0.1. Common serial optional	•	F-71
6.3.0.2. Using the RS485 port fitted as standard	•	F-73

For designing a system

7 . OPERATION WITH EXTERNAL SIGNAL	••• ••••	G-1
7.1 External Operation	••• ••••	G-1
7.2 Applied operation with input and output signals (operation by the terminal board)	••• ••••	G-2
7.2.1 Functions of input terminals (in case of sink logic)	••• ••••	G-2
7.2.2 Functions of output terminals (in case of sink logic)	••• ••••	G-5
7.2.3 Setup of input/output terminal operation time	••• ••••	G-9
7.3 Setup of external speed command (analog signal)	••• ••••	G-10
7.3.1 Setup by analog input signals (RR terminal)	••• ••••	G-11
7.3.2 Setup by analog input signals (VI/II terminal)	••• ••••	G-12
7.3.3 Setup by analog input signals (RX terminal)	••• ••••	G-13
8 . Monitoring operation status	••• ••••	H-1
8.1 Status monitor mode	••• ••••	H-1
8.2 Changing status monitor function	••• ••••	H-4
8.3 Indication in trip status	••• ••••	H-6
8.4 Indication of alarm, pre-alarm, etc...	••• ••••	H-8
9 . Selection of peripheral devices	••• ••••	I-1
9.1 Selection of wiring equipment	••• ••••	I-1
9.2 Installation of electromagnetic contactor	••• ••••	I-3
9.3 Installation of overload relay	••• ••••	I-4
9.4 Application and functions of options	••• ••••	I-5
9.5 Optional add-on cassettes	••• ••••	I-10
9.6 Board options	••• ••••	I-12
9.7 Before installing optional add-on cassette or board option	••• ••••	I-13
9.7.1 Case 1	••• ••••	I-13
9.7.2 Case 2	••• ••••	I-14
9.7.3 Case 3	••• ••••	I-14

TOSHIBA

1 0 . Table of parameters	J-1
1 1 . Specifications by types	K-1
1 1.1 Standard specifications by types	K-1
1 1.2 External dimensions and mass	K-5
1 2 . Prior to service call - Trip information and counter measures	L-1
1 2.1 Cause of trip, warning indication (in detail and countermeasures)	L-1
1 2.2 Method of resetting causes of trip	L-5
1 2.3 In the case motor does not run in spite of no trip message appearing	L-6
1 2.4 How to check other troubles	L-7
1 3 . Regular inspection and maintenance	M-1
1 3.1 Regular inspection	M-1
1 3.2 Periodical inspection	M-2
1 3.3 When making a service call	M-4
1 3.4 When retaining the inverter out of operation	M-4
1 4 . Warranty	N-1
1 5 . When disposing the inverter	O-1

1 . Read this section first

1.1 Checking the purchase

Make sure that the inverter delivered is exactly what you ordered.



Warning



Mandatory

Use an inverter which matches the input power rating of your three-phase induction motor. The use of an inverter unsuitable for your motor can cause it to rotate in a wrong direction, and thus lead to grave accidents, including its burning due to overheating.

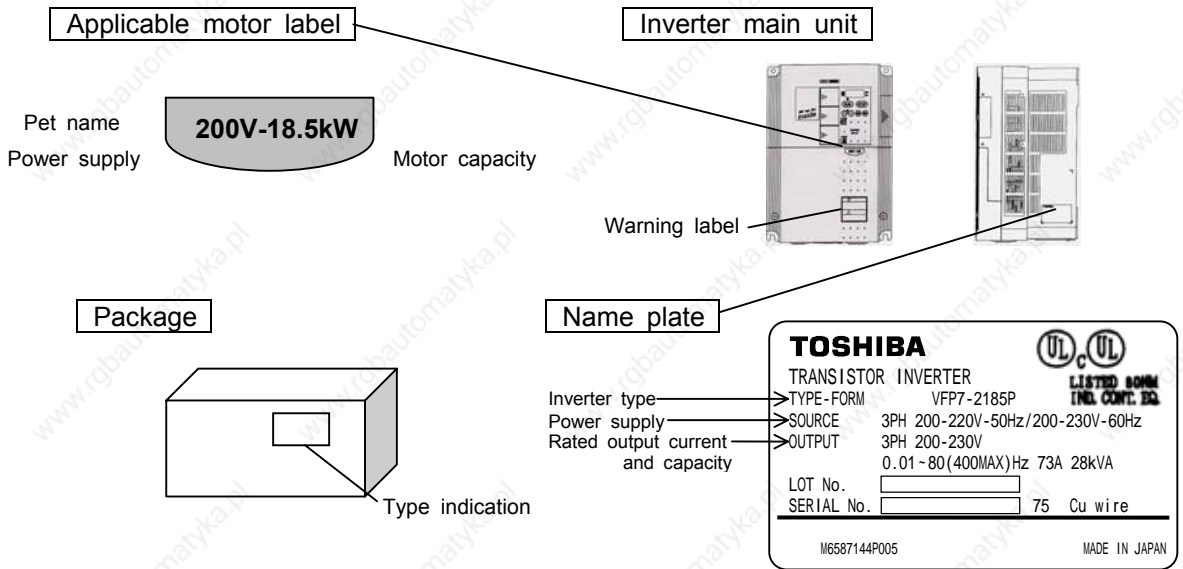

1.2 Contents of the product code

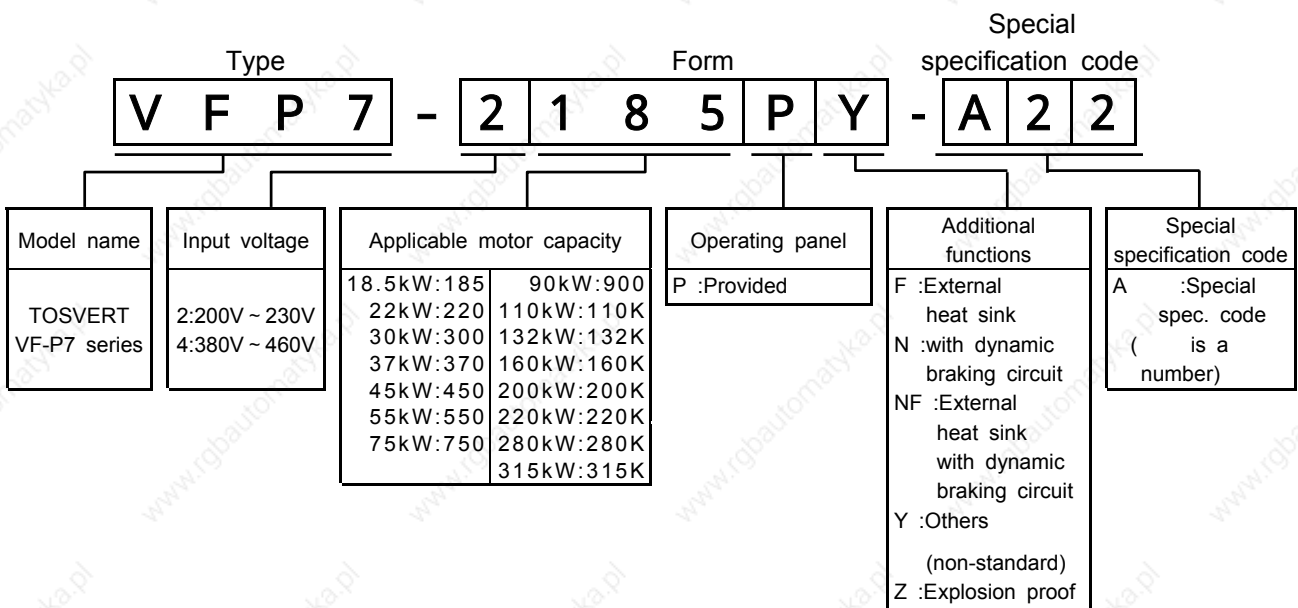

Note) Turn off the power in advance when checking the rating of the inverter installed in a cabinet.

1.3 Names and functions

1.3.1 Panel description

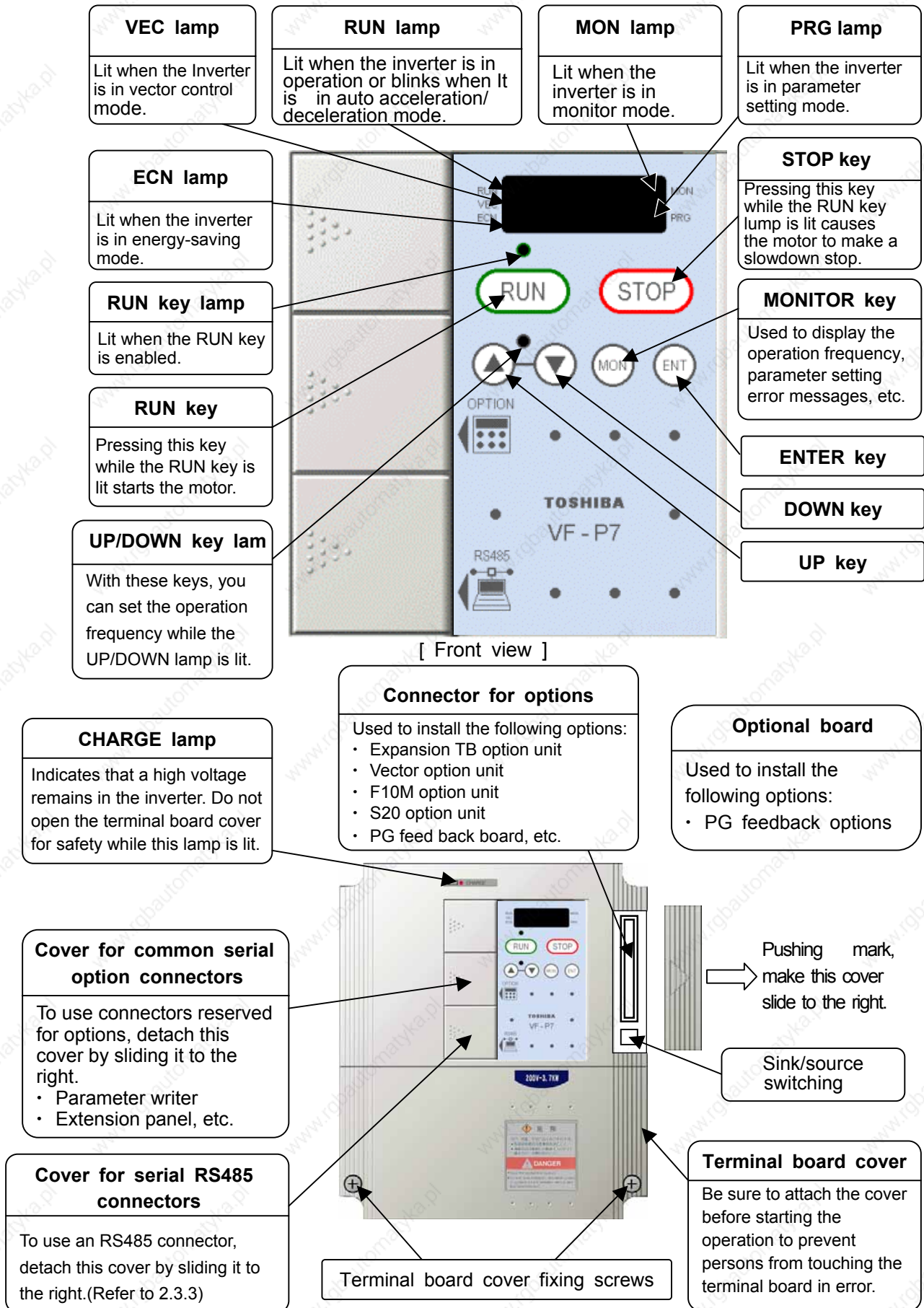

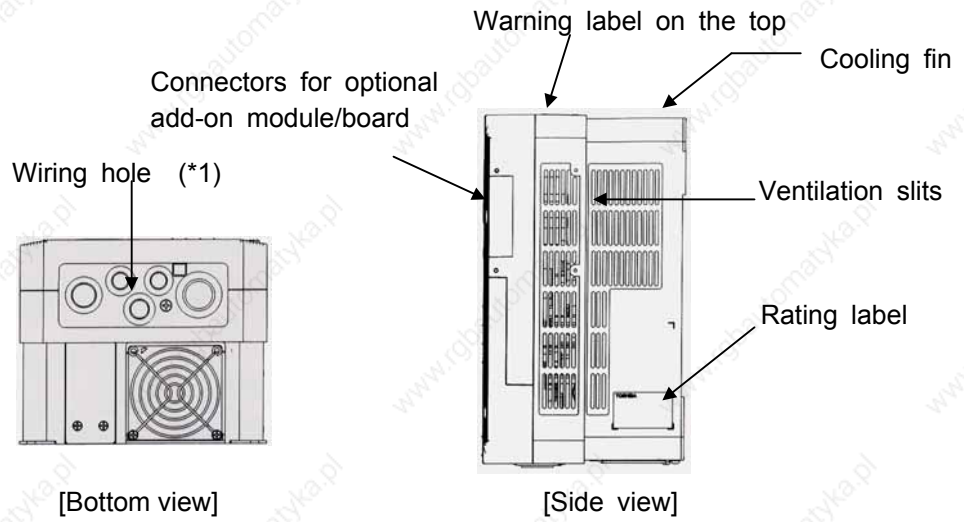

(*1) Using scissors or a cutter, cut the rubber bush in the wiring hole as shown below. (Models for 22kW motor or smaller)

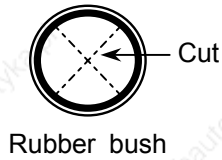

1.3.2 Main circuit, control power supply and control circuit terminal boards

1) Main circuit terminal board

VFP7-2185P, 2220P
VFP7-4185P, 4220P

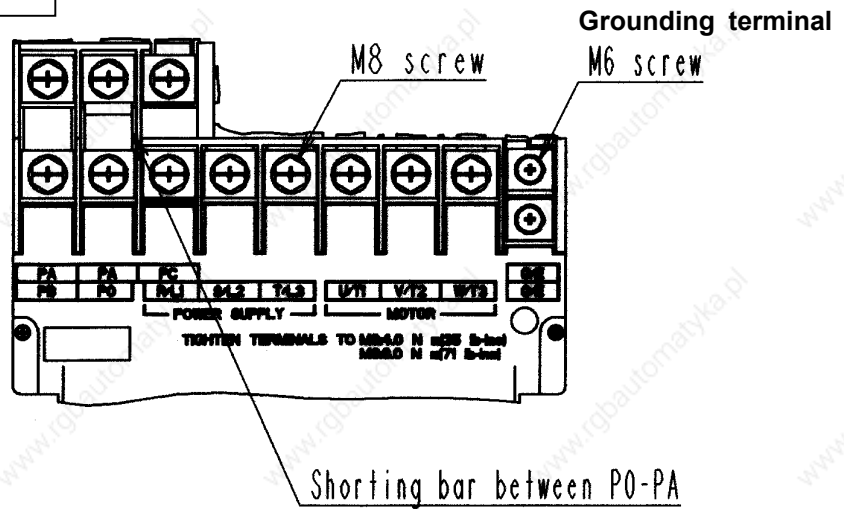

VFP7-2300P,
VFP7-4300P, 4370P

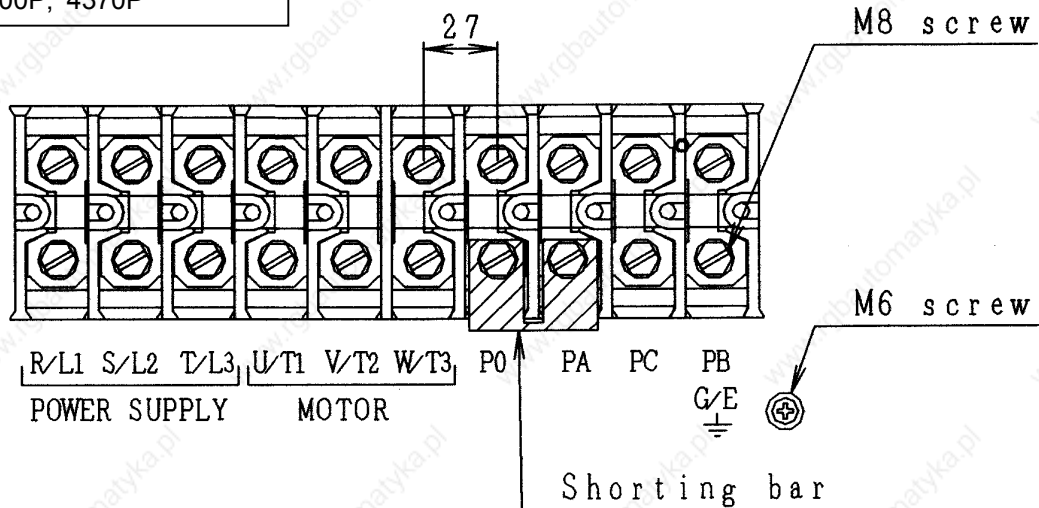

VFP7-4450P, 4550P

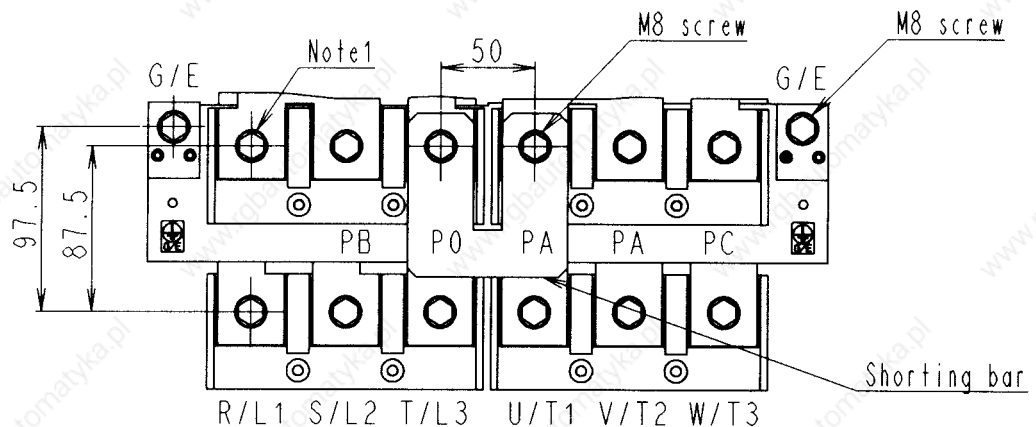

Note1. Don't use this terminal.

TOSHIBA

VFP7-2370P ~ 2550P
VFP7-4750P, 4900P

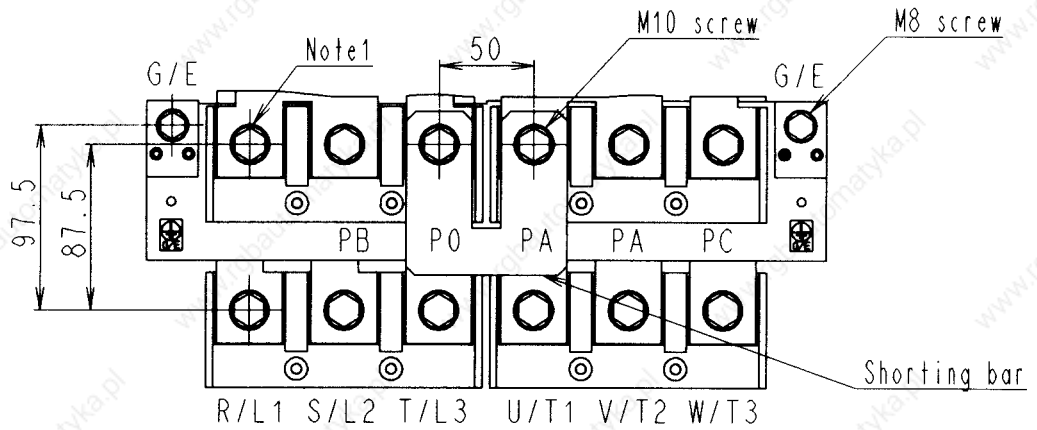

Note1. Don't use this terminal.

VFP7-2750P
VFP7-4110KP ~ 4160KP

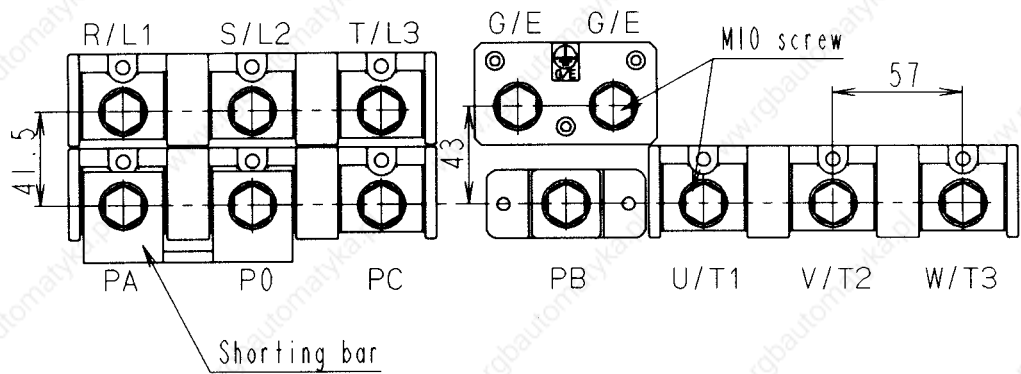

VFP7-2900P, 2110KP
VFP7-4200KP ~ 4315KP

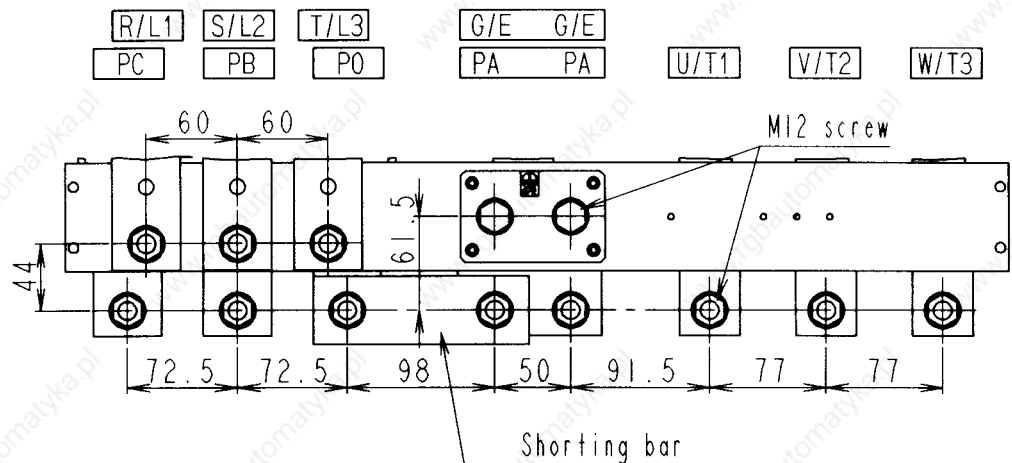

2) Control power supply terminal board

Note) To use R0,S0 terminal on 22kW model or smaller, you need a Control power supply unit option.(Refer to 9.4)

VFP7-2185P ~ 2220P
VFP7-4185P ~ 4220P

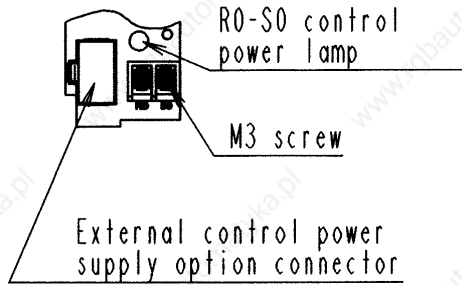

VFP7-2300P
VFP7-4300P, 4370P

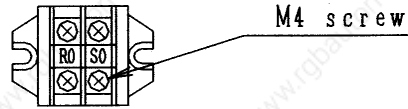

VFP7-2370P ~ 2110KP

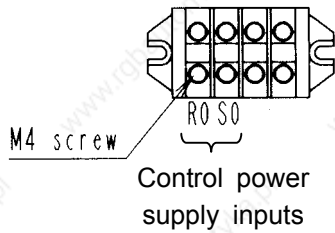

VFP7-4450P ~ 4315KP

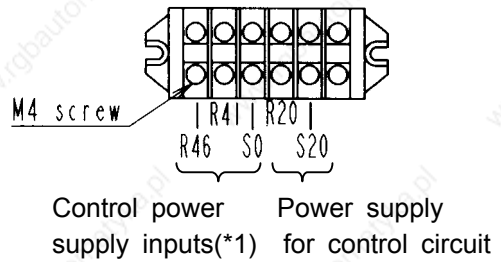

(*1) Refer to 2.2 for the connection of control power cables by voltage(R46,R41 and S0 terminals).

3) Control circuit terminal

The control circuit terminal board is common to all models.

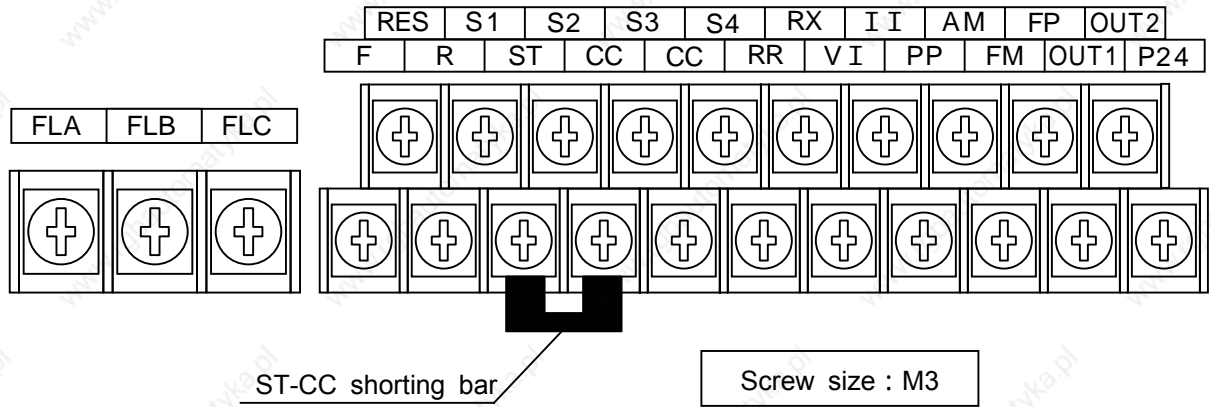

Refer to section 2.3.2 for the functions of terminals.

1.3.3 Detaching the terminal board front cover

Detach the front lower cover for wiring, following the steps below.

Less than 22kW

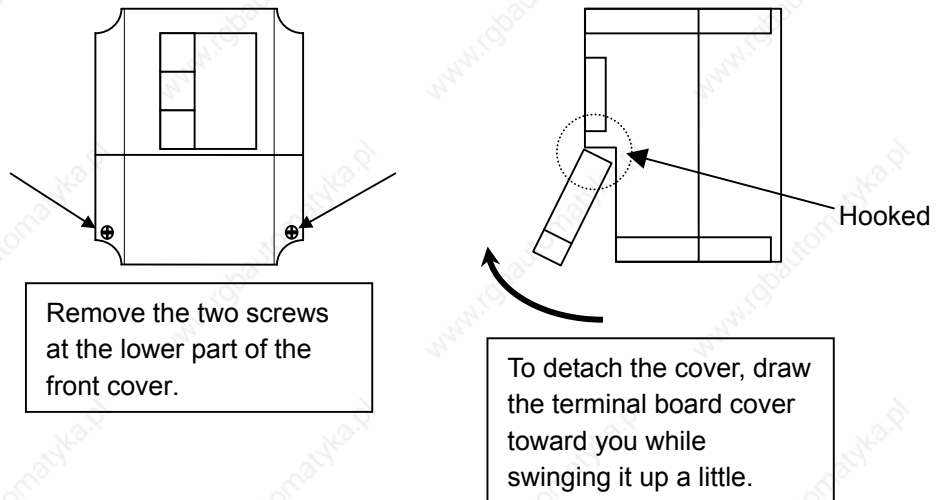



* For a 30kW model or larger, detach the whole front cover for wiring.

1.4 Notes on the application of inverters

1.4.1 Notes on motors combined with inverters

Keep in mind the following notes when using the VF-P7 in combination with a motor.

 Warning	
 Mandatory	Use an inverter which matches the input power rating of your three-phase induction motor. The use of an inverter unsuitable for your motor can cause it to rotate in a wrong direction, and thus lead to serious accidents, including its burning due to overheating.

Comparison with commercial power operation

The VF-P7 inverter uses a sinusoidal PWM control system. However, the waveforms of electric currents passing through the main and control circuits are not perfectly sinusoidal but slightly distorted though they are very close to perfect sine waves. For this reason, a motor produces more heat, larger noise and larger vibration when operated by means of the inverter than when operated directly by commercial power.

Operation in low speed ranges

Operating a general-purpose motor by means of the inverter causes a decrease in the cooling efficiency of the motor. So, reduce the motor's output below the rated load when operating it in a low speed range.

If you wish to operate a motor continuously at the rated torque, then use a Toshiba VF motor designed specially for use in conjunction with an inverter. When the inverter is combined with a VF motor, its overload protection level needs to be changed to "VF motor" (\overline{OL} setting).

Adjustment of overload protection level

The VF-P7 inverter has an overload detection circuit (electronic thermal detection) to protect the motor from overload. The reference current for the electronic thermal detection is set to the rated current of the inverter at the factory, and it needs to be adjusted to the rated current of the general-purpose motor combined with it.

High-speed operation at a frequency of 60 Hz or over

When a motor is operated at a frequency of 60 Hz or over, it produces larger noise and larger vibration, which can exceed a limit that the motor or its bearings can withstand. Contact the motor maker if you wish to operate the motor at such a high frequency.

Load of an oil lubrication type

When a speed reducer or a gear motor of an oil lubrication type is operated by the inverter, its oil lubrication efficiency decreases in low speed ranges. Inquire of the speed reducer maker about the allowable speed reduction range.

Extremely light load or load producing a very small moment of inertia

When a motor is operated under an extremely light load (e.g., at a load factor of less than 50%) or it drives a load which produces a very small moment of inertia, it sometimes becomes unstable, for example, it produces abnormal vibration or trips because of an over-current. In such a case, lower the carrier frequency to cope with this problem.

Unstable operation

When the inverter is used in combination with one of the following motors or loads, it sometimes makes the operation of the motor or load unstable.

- A motor with a rated capacity that exceeds the motor capacity recommended for the inverter
- A special type of motor, for example, an explosion-proof motor
When using the inverter for such motors, lower the inverter's carrier frequency to stabilize the operation. (In vector control mode, do not lower it below 2.2 kHz.)
- A motor with a large backlash, which is coupled with a load
In this case, use the S-pattern acceleration/deceleration function, or in vector control mode, adjust the response time (setting of moment of inertia) or switch to V/f control mode to stabilize the operation.

- A load, e.g., a reciprocating load, which requires a frequent change in the rotating speed
 In this case, if the inverter is in vector control mode, adjust the response time (setting of moment of inertia) or switch to V/f control mode to stabilize the operation.

Braking of a motor after power shutoff

If the power is shut off while the motor is still rotating, the motor keeps rotating (or coasting) for a while before it comes to a complete stop. If you wish to stop it soon after turning off the power, equip the motor with an auxiliary braking system. There are several types of braking systems available, for example, mechanical and electrical types. Select a braking system which matches your system.

Load producing negative torque

When the inverter is combined with a load producing negative torque, the over-voltage or over-current protective function of the inverter sometimes works and causes the motor to trip. In this case, it is necessary to install a dynamic braking resistor, etc., suitable for the load.

Motor with a braking system

When a brake-equipped motor is connected directly with the inverter, the brake cannot be released at start-up because of an insufficient voltage. To avoid this, connect the brake cables separately from the motor main cables.

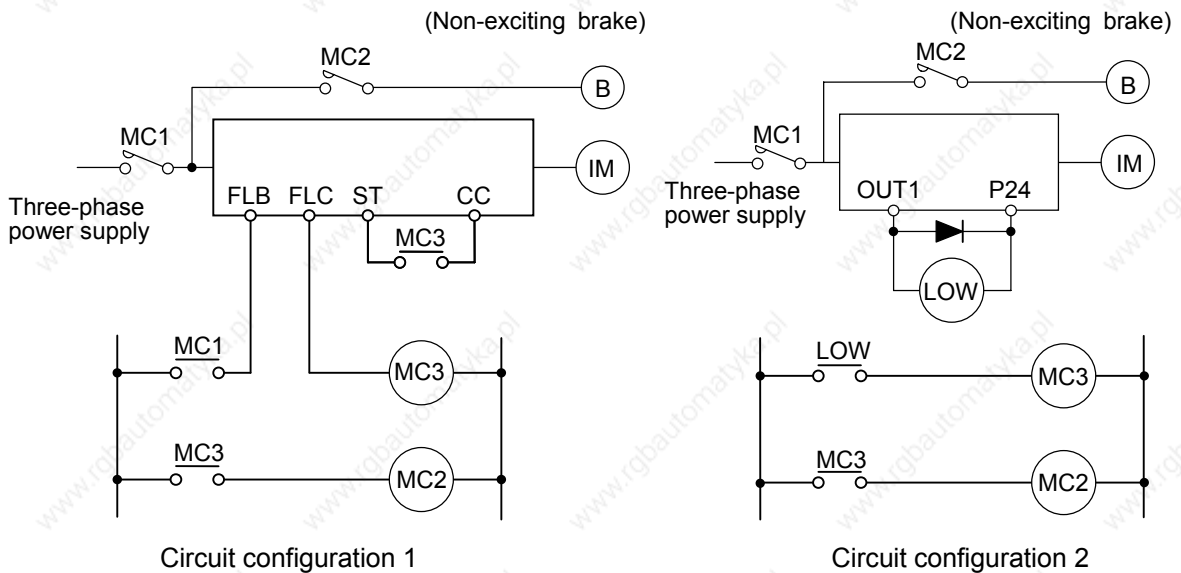

In circuit configuration 1, the brake is turned on and off by means of MC2 and MC3. If the circuit is configured differently, the motor can trip because of a locked rotor current produced during braking.

In circuit configuration 2, the brake is turned on and off by means of a low-speed signal OUT1. However, for certain applications, it is recommended to use a low-speed detection signal (function of terminal OUT1) to turn on and off the motor. Contact your Toshiba dealer before designing a system.

1.4.2 Notes on inverters

Over-current protective function

The inverter has an over-current protective function. The current for this protection is adjusted to the maximum current rating of the applicable motors by default. Therefore, when the inverter is used to control a motor with a relatively small capacity, it is necessary to readjust the over-current protection level and the electronic thermal protective function. In such a case, follow the procedure specified in 5.13 to readjust them.

Inverter capacity

An inverter with a small capacity (kVA) must not be used for a motor with a relatively large capacity even if the motor is operated under a small load. If an inverter is used this way, the output peak current rises high because of a current ripple, thus causing the motor to trip easily.

Power factor improving capacitor

No power factor improving capacitor should be connected on the output side of the inverter. When the inverter is used for a motor equipped with a capacitor for power factor improvement, remove the capacitor from the motor. Connecting such a capacitor causes the inverter to break down and the motor to trip, or breaks the capacitor itself.

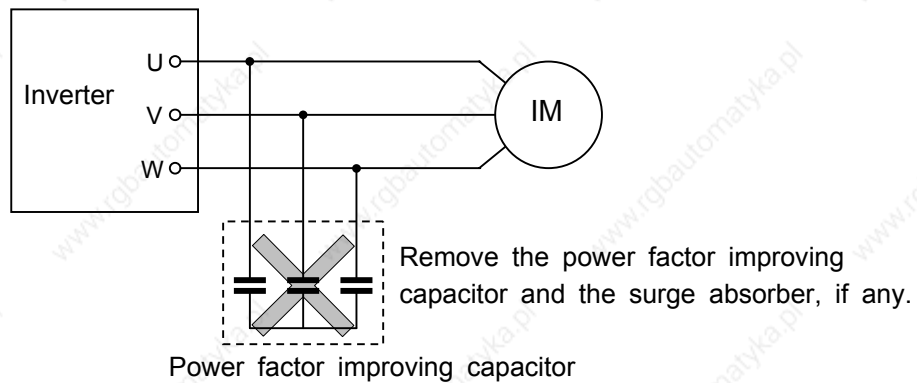

Use of an inverter at a voltage other than the rated one

There is a need to connect it to a power unit supplying a voltage different from the rated voltage, increase or reduce the supply voltage to the inverter's rated voltage, using a transformer, etc.

Use of a set of inverters, which requires circuit-breaking devices

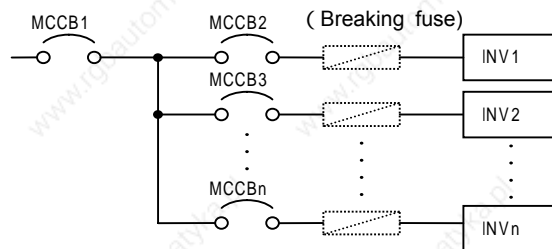

Circuit-breaking of defective inverter

This series of inverters has no fuse in its main circuit. When two or more inverters are connected to the same power line as shown above, it is necessary to select a circuit-breaking characteristic ensuring that, for example, if a short circuit occurs in INV 1, only MCCB2 trips but not MCCB1. If it is difficult to select a proper characteristic, then insert a breaking fuse between MCCB2 and INV 1 in this case.

Note on the disposal of inverters

Be sure to dispose of inverters as industrial wastes, when they become unnecessary.

1.4.3 Influences of leakage currents and measures against it

Warning

An electric current can leak through an input or output cable of the inverter because of its insufficient capacitance and, sometimes, affects the peripheral systems. The amount of a leakage current depends on the carrier frequency, the length of the input/output cable, etc. It is advisable to take the following measures to prevent leakage currents.

(1) Influences of a current leaking into other systems via the ground

An electric current can leak not only into other circuits of an inverter but also into other inverters through grounding wires. Such a leakage current can exert influences on various electronic devices, for example, malfunction of ground leakage breakers or relays, ground relays, fire alarms, sensors, etc., noise on CRTs and display of incorrect current values on a CRT screen.

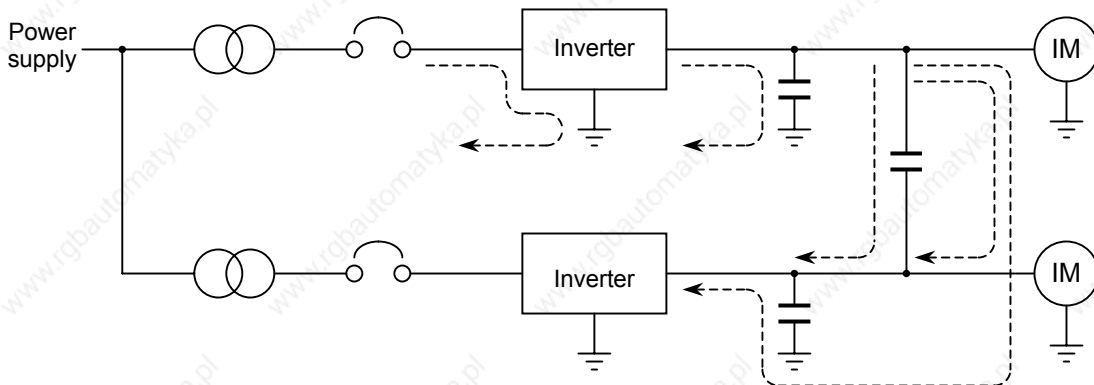

Measures to be taken:

1. Lower the PWM carrier frequency.
Use parameter $F300$ to lower the PWM carrier frequency.
2. Use high frequency-ready ground leakage breakers (e.g., Esper Mighty series (manufactured by Toshiba Schneider Electric Ltd.)). When these ground leakage breakers are installed, there is no need to lower the PWM carrier frequency.
3. If sensors and CRTs are affected, they can be restored by lowering the PWM carrier frequency as described in 1 above. However, if lowering the PWM carrier frequency results in an increase in magnetic noise, contact your Toshiba dealer.

(2) Influences of a current leaking from a cable into other cables

Thermal relay

If a current leaks from an output cable of an inverter to other cables because of its insufficient capacitance, the high-frequency elements of the leakage current sometimes increase the effective current value, and thus cause external relays to malfunction. For a model with relatively long cables (longer than 50 m), the external thermal relays can malfunction more easily because a leakage current can be too large as compared with the current rating of the motor.

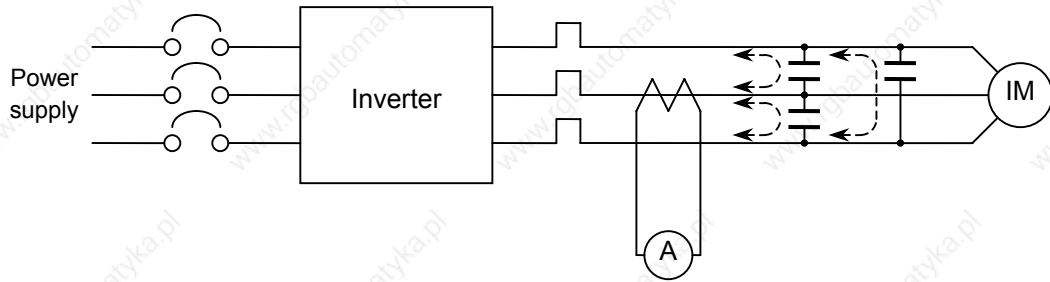

Measures to be taken:

1. Use the electronic thermal function provided for the inverter.
Use parameter *OLN.F600* to set the electronic thermal function.
2. Lower the PWM carrier frequency, though this results in an increase in motor magnetic noise.
Use parameter *F300* to lower the PWM carrier frequency.
3. For improvement, connect film capacitors with capacitance of 0.1 to 0.5 μ F-1000V to the input and output terminals in each phase of the each thermal relay.

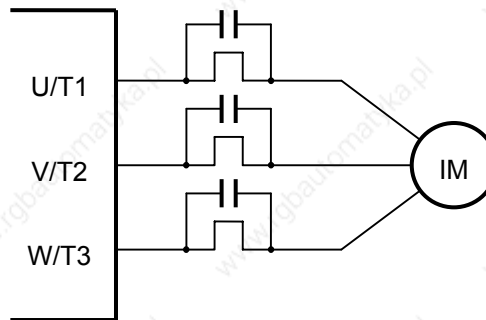

CT and ammeter

When a CT and an ammeter are installed externally to monitor the output current of the inverter, the ammeter could be burned by the high-frequency elements of a leakage current. For a model with relatively long cables (longer than 50 m), the ammeter can be burned more easily by the high-frequency elements of a leakage current which flows into it through the external CT because a leakage current can be too large as compared with the current rating of the motor.



Measures to be taken:



1. For external meters, use the meter output terminals in the inverter's control circuit.
Output currents can also be output to the meter output terminals (AM). Use a 1 mAdc full-scale ammeter or a 7.5 Vdc-1 mA full-scale voltmeter.
2. Use the monitor function provided for the inverter.
Use the monitor function provided for the inverter to check the output current.



1.4.4 Notes on installation

Installation environment

The VF-P7 inverter is an electronic control device. Therefore, due consideration should be given to its installation environment.

 Danger	
 Prohibited	-Do not put any inflammable material near the inverter, or it could catch a fire if the inverter sparks because of trouble.
 Mandatory	-Use the inverter under environmental conditions specified by this instruction manual, or it could break down.

 Warning	
 Prohibited	-Do not install the inverter in any place subject to vibration, or it could fall and cause injury to persons.
 Mandatory	Make sure that the supply voltage is within +10%/-15% (within $\pm 10\%$ during continuous operation under full load) of the inverter's rated voltage specified on its rating label. Supplying a voltage exceeding the above range could lead to a breakdown, an electric shock or a fire.

 Warning																											
 Prohibited	<p>-Do not install the inverter where any of the unallowable chemicals or solvents listed below can be sprayed, or its plastic front cover could come off or a plastic unit could fall off, though damage sustained by plastic parts depends on their shapes. If you intend to install the inverter where a chemical or solvent other than those listed below is used, consult your Toshiba dealer in advance.</p> <table style="width: 100%; border-collapse: collapse;"> <tr> <td style="width: 50%; vertical-align: top;"> <p>(Table 1) Allowable chemicals and solvents</p> <table border="1" style="width: 100%; border-collapse: collapse;"> <thead> <tr> <th style="width: 50%;">Chemical</th> <th style="width: 50%;">Solvent</th> </tr> </thead> <tbody> <tr> <td>Hydrochloric acid (concentration of less than 10%)</td> <td>Methanol</td> </tr> <tr> <td>Sulfuric acid (concentration of less than 10%)</td> <td>Ethanol</td> </tr> <tr> <td>Nitric acid (concentration of less than 10%)</td> <td>Triol</td> </tr> <tr> <td>Caustic soda</td> <td>Mesopropano I</td> </tr> <tr> <td>Ammonia</td> <td>Glycerin</td> </tr> <tr> <td>Sodium chloride</td> <td></td> </tr> </tbody> </table> </td> <td style="width: 50%; vertical-align: top;"> <p>(Table 2) Unallowable chemicals and solvents</p> <table border="1" style="width: 100%; border-collapse: collapse;"> <thead> <tr> <th style="width: 50%;">Chemical</th> <th style="width: 50%;">Solvent</th> </tr> </thead> <tbody> <tr> <td>Phenol</td> <td>Gasoline, Kerosene, light oil</td> </tr> <tr> <td>Benzene sulfonic acid</td> <td>Turpentine oil</td> </tr> <tr> <td></td> <td>Benzol</td> </tr> <tr> <td></td> <td>Thinner</td> </tr> </tbody> </table> </td> </tr> </table>	<p>(Table 1) Allowable chemicals and solvents</p> <table border="1" style="width: 100%; border-collapse: collapse;"> <thead> <tr> <th style="width: 50%;">Chemical</th> <th style="width: 50%;">Solvent</th> </tr> </thead> <tbody> <tr> <td>Hydrochloric acid (concentration of less than 10%)</td> <td>Methanol</td> </tr> <tr> <td>Sulfuric acid (concentration of less than 10%)</td> <td>Ethanol</td> </tr> <tr> <td>Nitric acid (concentration of less than 10%)</td> <td>Triol</td> </tr> <tr> <td>Caustic soda</td> <td>Mesopropano I</td> </tr> <tr> <td>Ammonia</td> <td>Glycerin</td> </tr> <tr> <td>Sodium chloride</td> <td></td> </tr> </tbody> </table>	Chemical	Solvent	Hydrochloric acid (concentration of less than 10%)	Methanol	Sulfuric acid (concentration of less than 10%)	Ethanol	Nitric acid (concentration of less than 10%)	Triol	Caustic soda	Mesopropano I	Ammonia	Glycerin	Sodium chloride		<p>(Table 2) Unallowable chemicals and solvents</p> <table border="1" style="width: 100%; border-collapse: collapse;"> <thead> <tr> <th style="width: 50%;">Chemical</th> <th style="width: 50%;">Solvent</th> </tr> </thead> <tbody> <tr> <td>Phenol</td> <td>Gasoline, Kerosene, light oil</td> </tr> <tr> <td>Benzene sulfonic acid</td> <td>Turpentine oil</td> </tr> <tr> <td></td> <td>Benzol</td> </tr> <tr> <td></td> <td>Thinner</td> </tr> </tbody> </table>	Chemical	Solvent	Phenol	Gasoline, Kerosene, light oil	Benzene sulfonic acid	Turpentine oil		Benzol		Thinner
<p>(Table 1) Allowable chemicals and solvents</p> <table border="1" style="width: 100%; border-collapse: collapse;"> <thead> <tr> <th style="width: 50%;">Chemical</th> <th style="width: 50%;">Solvent</th> </tr> </thead> <tbody> <tr> <td>Hydrochloric acid (concentration of less than 10%)</td> <td>Methanol</td> </tr> <tr> <td>Sulfuric acid (concentration of less than 10%)</td> <td>Ethanol</td> </tr> <tr> <td>Nitric acid (concentration of less than 10%)</td> <td>Triol</td> </tr> <tr> <td>Caustic soda</td> <td>Mesopropano I</td> </tr> <tr> <td>Ammonia</td> <td>Glycerin</td> </tr> <tr> <td>Sodium chloride</td> <td></td> </tr> </tbody> </table>	Chemical	Solvent	Hydrochloric acid (concentration of less than 10%)	Methanol	Sulfuric acid (concentration of less than 10%)	Ethanol	Nitric acid (concentration of less than 10%)	Triol	Caustic soda	Mesopropano I	Ammonia	Glycerin	Sodium chloride		<p>(Table 2) Unallowable chemicals and solvents</p> <table border="1" style="width: 100%; border-collapse: collapse;"> <thead> <tr> <th style="width: 50%;">Chemical</th> <th style="width: 50%;">Solvent</th> </tr> </thead> <tbody> <tr> <td>Phenol</td> <td>Gasoline, Kerosene, light oil</td> </tr> <tr> <td>Benzene sulfonic acid</td> <td>Turpentine oil</td> </tr> <tr> <td></td> <td>Benzol</td> </tr> <tr> <td></td> <td>Thinner</td> </tr> </tbody> </table>	Chemical	Solvent	Phenol	Gasoline, Kerosene, light oil	Benzene sulfonic acid	Turpentine oil		Benzol		Thinner		
Chemical	Solvent																										
Hydrochloric acid (concentration of less than 10%)	Methanol																										
Sulfuric acid (concentration of less than 10%)	Ethanol																										
Nitric acid (concentration of less than 10%)	Triol																										
Caustic soda	Mesopropano I																										
Ammonia	Glycerin																										
Sodium chloride																											
Chemical	Solvent																										
Phenol	Gasoline, Kerosene, light oil																										
Benzene sulfonic acid	Turpentine oil																										
	Benzol																										
	Thinner																										



- Avoid installing the inverter in a hot, damp, or dusty place, a place subject to freezing or water splash, or a place full of metal chips.
- Do not install the inverter in a place exposed to corrosive gas or coolant for grinding.

- Use the inverter at ambient temperatures of -10 to 50 .

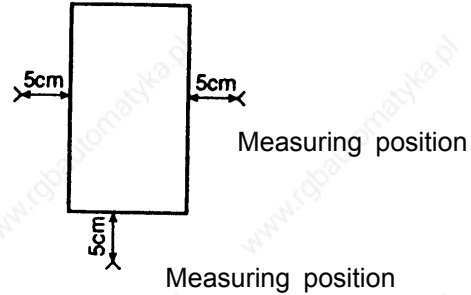
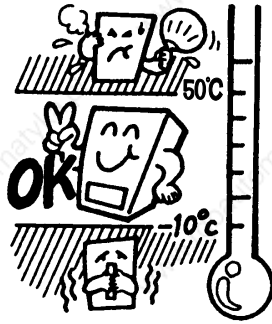

Note) The inverter produces heat. When installing it in a cabinet, consider its ventilating condition and internal space. The VF-P7 can be used at ambient temperatures of up to 50 .

- Do not install the inverter in any place subject to vibration.





Note) If you intend to install it in a place subject to vibration, you should take measures to protect it from vibration. In such a case, contact your Toshiba dealer in advance.

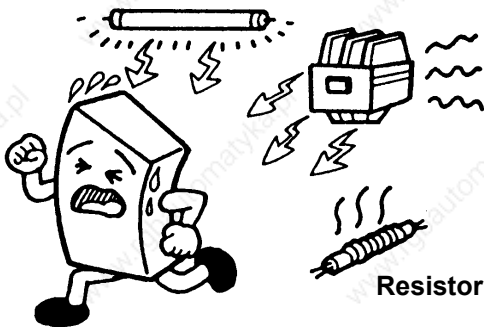

- If installing the inverter close to any of the following appliances or devices, take necessary measures to prevent them from malfunctioning.



- Solenoid ... Connect a surge suppressor to the coil.
- Brake ... Connect a surge suppressor to the coil.
- Magnetic contactor ... Connect a surge suppressor to the coil.
- Fluorescent lamp ... Connect a surge suppressor to the coil.
- Resistor ... Move it away from the inverter.

Installation

 Danger	
 Prohibited	<ul style="list-style-type: none"> - Do not install or operate the inverter if it is damaged or any part is missing from it. Operating the inverter in a defective condition could lead to a shock or a fire. Request your Toshiba dealer for repair.
 Mandatory	<ul style="list-style-type: none"> - Install the inverter on a non-combustible board, such as a steel plate. Installing it on an inflammable wall or board could lead to a fire because its back is heated up during operation. - Do not use the inverter with the front cover detached, or it could cause a shock. - Install an emergency shutdown device which matches the system (for example, a switch interlocked with the brake of the machine). Failure to do so could lead to injury to persons since it has no emergency stop function. - Do not use any optional devices other than those designated by Toshiba. The use of improper devices could lead to accidents.

 Warning	
 Prohibited	<ul style="list-style-type: none"> - Install the main unit on a wall, or the like, which is strong enough to withstand its weight, or it could fall and cause injury to persons. - Install a mechanical brake whenever the motor requires a brake (device which retains the motor shaft). Failure to do so could lead to injury to persons because the inverter itself has no function of mechanically retaining the brake shaft.

Installation place

Install the inverter vertically on a flat steel wall in a well-ventilated place. When installing two or more inverters, leave a clearance of at least 10 cm between inverters placed side by side.

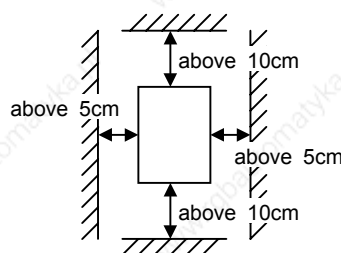

The clearances indicated above are minimum clearances to be secured. Every air-cooling type model is equipped with a cooling fan. For this type of inverter, therefore, leave as large clearances as possible above and under the inverter.

For a model designed for 37kW motors or larger, leave a clearance of at least 20 cm above and under it for easy installation of wires and possible replacement of the fan.

Note) Do not install the inverter in a hot, damp, or dusty place, or a place full of metal chips.

When you intend to install in a critical environment, consult your Toshiba dealer in advance.

Calorific values of inverters and amount of air to be ventilated

The VF-P7 series of inverter loses about 5% of energy when switching electric currents from AC, DC, then to AC. To limit a temperature rise due to this energy loss, it is necessary to forcefully ventilate and cool down the cabinet in which the inverter is installed.

The table below lists the amounts of air to be ventilated forcefully and the heat radiation areas required for closed-type cabinets containing an inverter.

Voltage class	Applicable motor (kW)	Calorific value of inverter (W)	Amount of air to be ventilated forcefully (m ³ /min.)	Heat radiation area required for closed-type cabinet (m ²)
200V	18.5	940	5.4	18.8
	22	1110	6.3	22.2
	30	1490	8.5	29.8
	37	1530	8.7	30.6
	45	1850	10.5	37.0
	55	2250	12.8	45.0
	75	3050	17.4	61.0
	90	3650	20.8	73.0
400V	110	4450	25.4	89.0
	18.5	800	4.6	16.0
	22	940	5.4	18.8
	30	1270	7.2	25.4
	37	1570	8.9	31.4
	45	1570	8.9	31.4
	55	1810	10.3	36.2
	75	2300	13.1	46.0
	90	2750	15.7	55.0
	110	3350	19.1	67.0
	132	4010	22.9	80.2
	160	4850	27.6	97.0
	220	6050	34.5	121.0
	220	6650	37.9	133.0
280	8450	48.2	169.0	
315	9500	54.2	190.0	

Note) The calorific values in the above table do not include those of optional external devices (such as input reactors, DC reactors and radio noise filters).

Control panel designed in consideration of possible influences of noise

Inverters produce high-frequency noise. To avoid influences of noise, measures must be taken in designing a control panel. Here are some examples of measures against noise.

- Separately install the wires of the main circuit and those of the control circuit. Do not install their wires in the same duct or in parallel with each other, and do not bind them together.
- Use shielded wires or twisted wires for the control circuit.
- Separate the input wires (on power supply side) of the main circuit from the output wires (on motor side). Do not install them in the same duct or in parallel with each other, and do not bind them together.
- Be sure to ground the grounding terminal (G/E) of the inverter.
- Be sure to connect a surge suppressor to every electromagnetic contactor and every relay installed near the inverter.
- Install noise filters, as required.

Notes on the installation of two or more inverters in a single cabinet

When installing two or more inverters in a single cabinet, take the following precautions:

- Leave a clearance of at least 10 cm between inverters placed side by side.
- Leave a clearance of at least 20 cm between inverters placed one above another.
- Install a deflector, etc., to prevent the upper inverter from being affected by heat produced and being exhausted by the lower one.

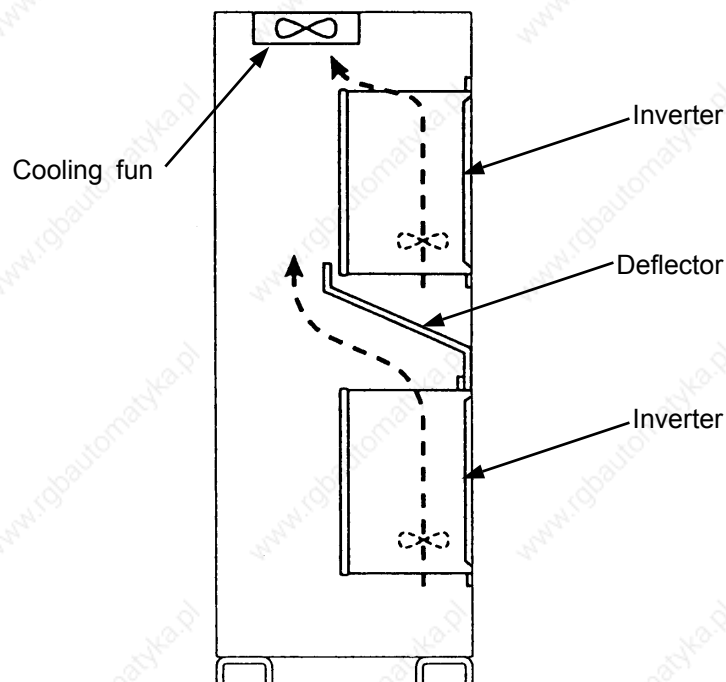

Installation of Cooling fan

Heat-sink going out attachment(simple type)

To install a standard VF-P7 designed for 200V-37kW motor or larger or 400V-45kW motor or larger, you can choose a one from next two forms.



- (1) Normal attachment (Whole the inverter is in the cabinet)
- (2) Heat-sink going out (the cabinet) attachment(simple type)

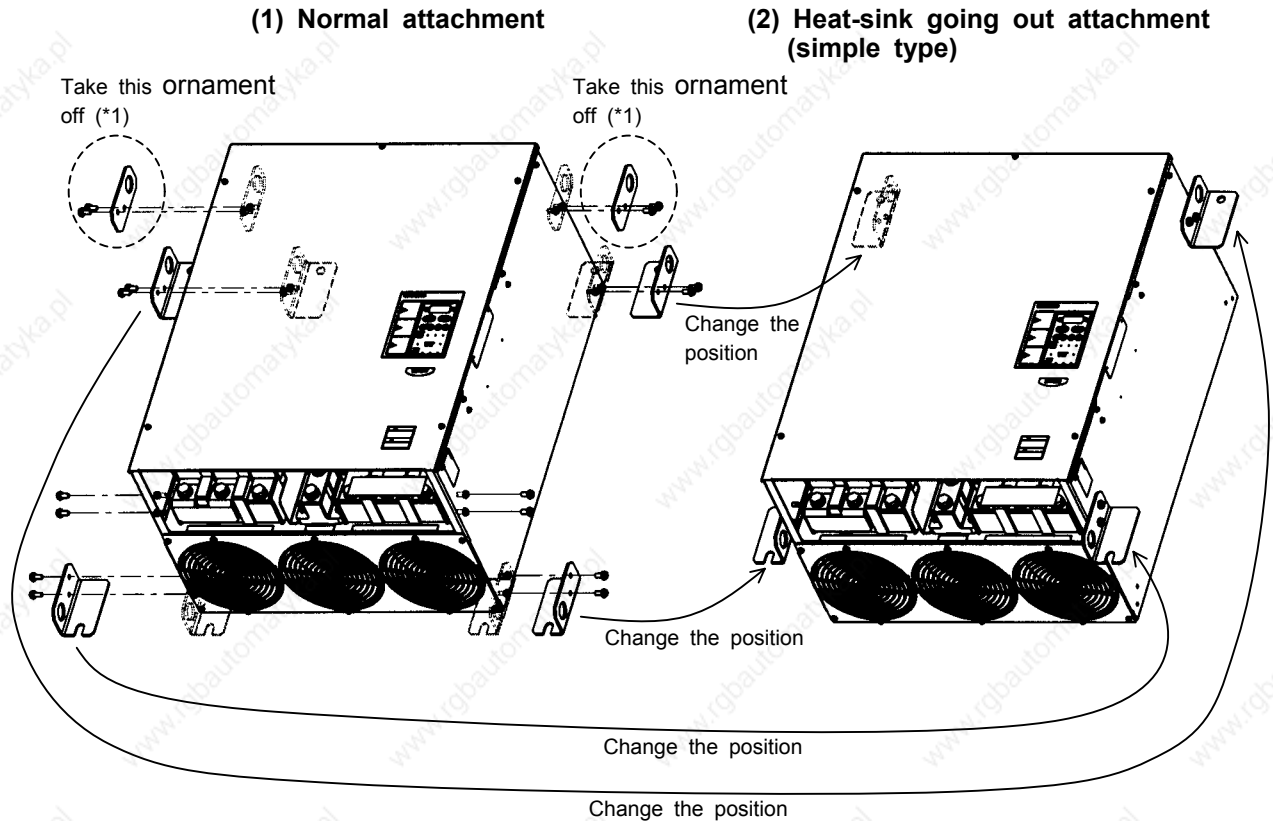

Heat-sink going out attachment reduces the generation of heat inside the cabinet. When you carry out heat-sink going out attachment, please change the position of the attachment ornaments (hanging hole) of the inverter according to the following figure.







- (*1) Metallic ornaments with the hanging hole are attached only in the following models.
200V class: Applicable motor capacity is 75kW or larger
400V class: Applicable motor capacity is 110kW or larger

2. Connection

 Danger	
 Disassemble	<ul style="list-style-type: none"> • Never disassemble, modify or repair the inverter. Its disassembly could cause an electric shock, a fire or an injury. Request your Toshiba dealer for repair.
 Prohibited	<ul style="list-style-type: none"> • Do not put or insert anything (e.g., an electric cable, a bar or a steel wire) into the inverter, or the inverter could cause a shock or a fire. • Do not splash water over the inverter, or the inverter could cause a shock or a fire.

 Warning	
 Prohibited	<ul style="list-style-type: none"> • Do not hold the front cover to carry the inverter, or the cover could come off and cause the main unit to fall, thus causing you to get an injury.
 Mandatory	<ul style="list-style-type: none"> • For models designed for 30kW motor or larger, carry it at least in a twosome, or it could fall and cause you to get an injury.

2.1 Cautions as to wiring

 Danger	
 Prohibited	<ul style="list-style-type: none"> • Never open the front cover of the inverter (or the door of the cabinet in which the inverter is installed) when the inverter is energized, or you could get a shock since a high voltage is applied to certain portions of it.
 Mandatory	<ul style="list-style-type: none"> • Do not turn on the power before attaching the front cover (or closing the door of the cabinet if the inverter is installed in it). Turning on the power with the cover or the door left opened could lead to an electric shock. • Entrust all electrical work to an experienced specialist. Wiring by an inexperienced person could result in a fire or an electric shock. • Connect the output terminals (on the motor side) correctly. connection of the terminals causes the motor to rotate in a wrong direction, and thus could result in injury to persons. • Perform wiring always after installing the inverter, or you could get a shock or an injury. • Be sure to perform the following preparatory work before proceeding to wiring. <ol style="list-style-type: none"> (1) Turn off the power. (2) Wait more than 10 minutes, and make sure that the charge lamp is extinct. (3) Using a circuit tester with a D.C. voltage measuring capacity of more than 800 V, check to be sure that the voltage remaining in the D.C. main circuit (between PA and PC) is below 45 V to do so could lead to an electric shock. • Tighten the terminal board fixing screws at the specified torque. Failure to do so could lead to a fire.
 Be Grounded	<ul style="list-style-type: none"> • Connect grounding wires correctly and securely. Failure to do so could cause an electric shock or a fire if current leakage occurs or the inverter breaks down.

Warning



Prohibited

- Do not connect any device or unit with a built-in capacitor (noise filter, surge suppressor, etc.) to output terminals (on the motor side), or it could cause the risk of a fire.

Prevention of radio noise

Prevent interference, such as radio noise, separately install and bind cables connected to the power supply-side terminals (R/L1, S/L2 and T/L3) of the main circuit and those connected to the motor-side terminals (U/T1, V/T2 and W/T3).

Power supply to the control and main circuits (for the 22kW and smaller models)

You want to keep the control circuit alive when the main circuit shuts off because of trouble or tripping, you can use an optional power supply unit to supply power to the control circuit separately from the main circuit.

Notes on wiring



- When connecting wires to the main circuit terminals, use crimp contacts because there is no large space between terminals, and attach them in order so that they do not come into contact with each other.
- Be sure to ground the inverter by connecting wires of the following size or larger to the grounding terminal G/E.

Voltage class	Applicable motor	Grounding wire size AWG(cross-section[mm ²])
200V	18.5 ~ 22kW	4(22)
	30 ~ 37kW	2(38)
	45kW	2/0(60)
	55 ~ 110kW	4/0(100)
400V	18.5kW	8(8)
	22 ~ 30kW	6(14)
	37 ~ 55kW	4(22)
	75 ~ 132kW	2/0(60)
	160 ~ 220kW	4/0(100)
	280 ~ 315kW	300(150)

- Refer to the table in 9.1 for wire sizes.
- Wire sizes listed in 9.1 is for the case the wire length is below 30m. To use wires longer than 30m, you need larger cables than listed in 9.1.
- Tighten a terminal stand screw with specified bolting torque.

Recommended bolting torque for terminal stand		
	N · m	lb · ins
M3	0.5	4.4
M4	1.2	11
M5	2.4	21
M6	4.0	35
M8	8.0	71
M10	16	142
M12	32	283

2.2 Standard connection

 Danger	
 Prohibited	<p>-Do not connect the power cables to any output terminal (U/T1, V/T2 or W/T3 on the motor side), or the inverter could break down and cause a fire.</p> <p>-Do not connect a resistor to any D.C. terminal (between PA and PC or PO and PC), or the inverter could cause a fire.</p> <p>To install external braking resistor, refer to 6.13.4.</p>
 Be Grounded	<p>-Connect grounding wires correctly and securely. Failure to do so could cause an electric shock or a fire if current leakage occurs or the inverter breaks down.</p>

[Standard connection diagram for sink logic(minus common)]

200V class: 18.5 ~ 22kW

400V class: 18.5 ~ 22kW

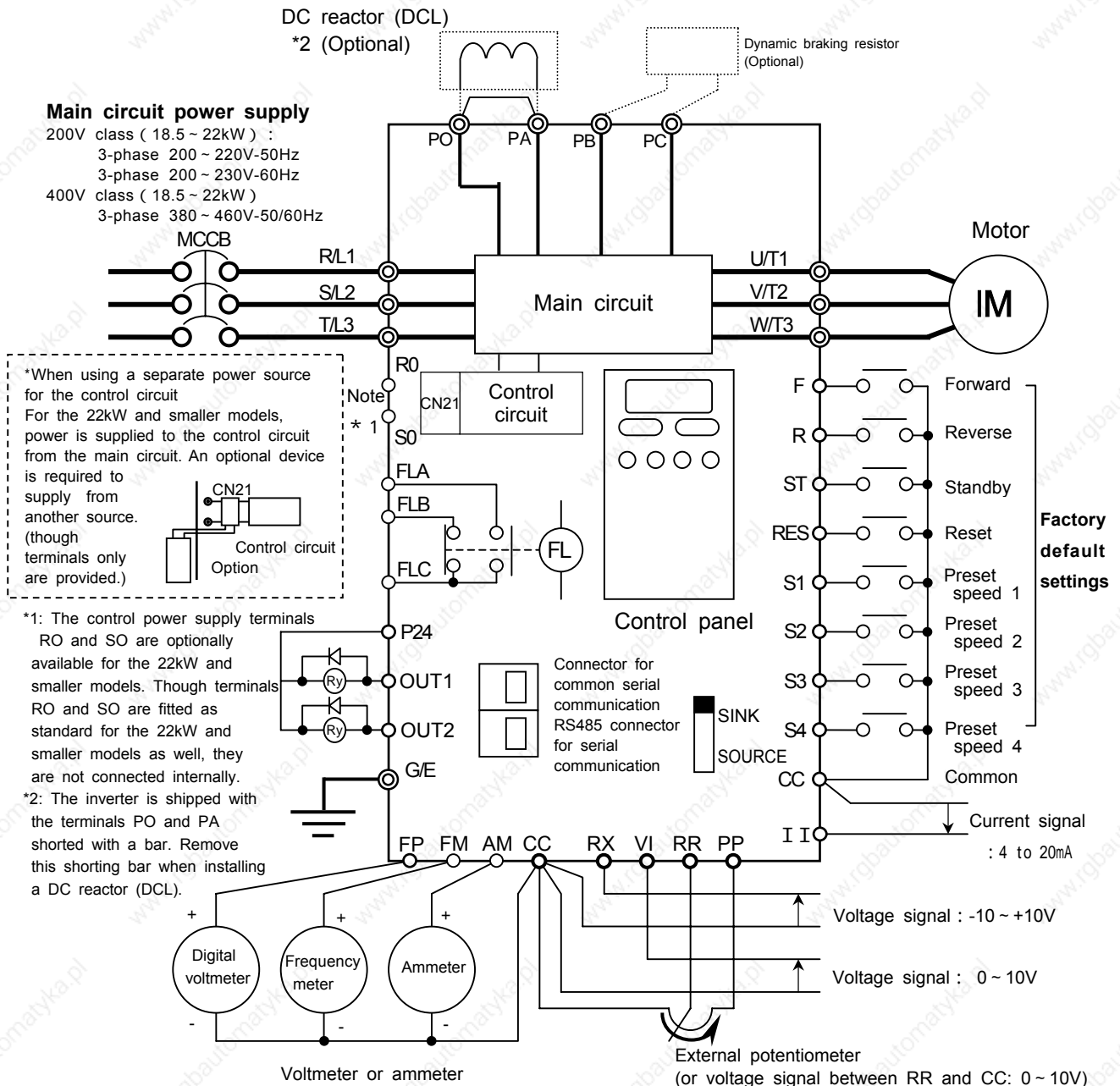

[Standard connection diagram for sink logic(minus common)]

200V class: 30 ~ 55kW
400V class: 30 ~ 90kW

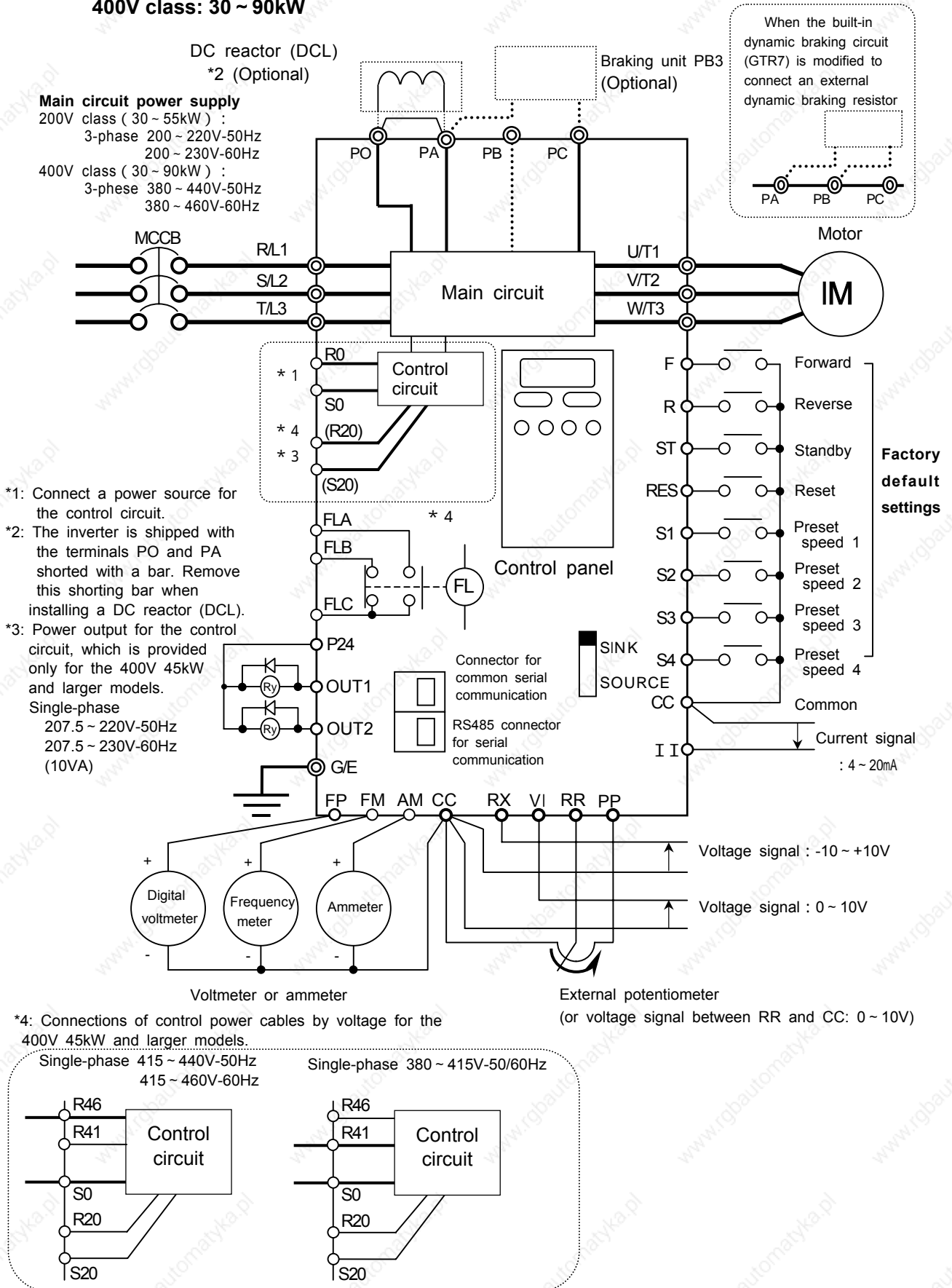

[Standard connection diagram for sink logic(minus common)]

200V class: 75 ~ 110kW

400V class: 110 ~ 315kW

Be sure to attach DC reactor.

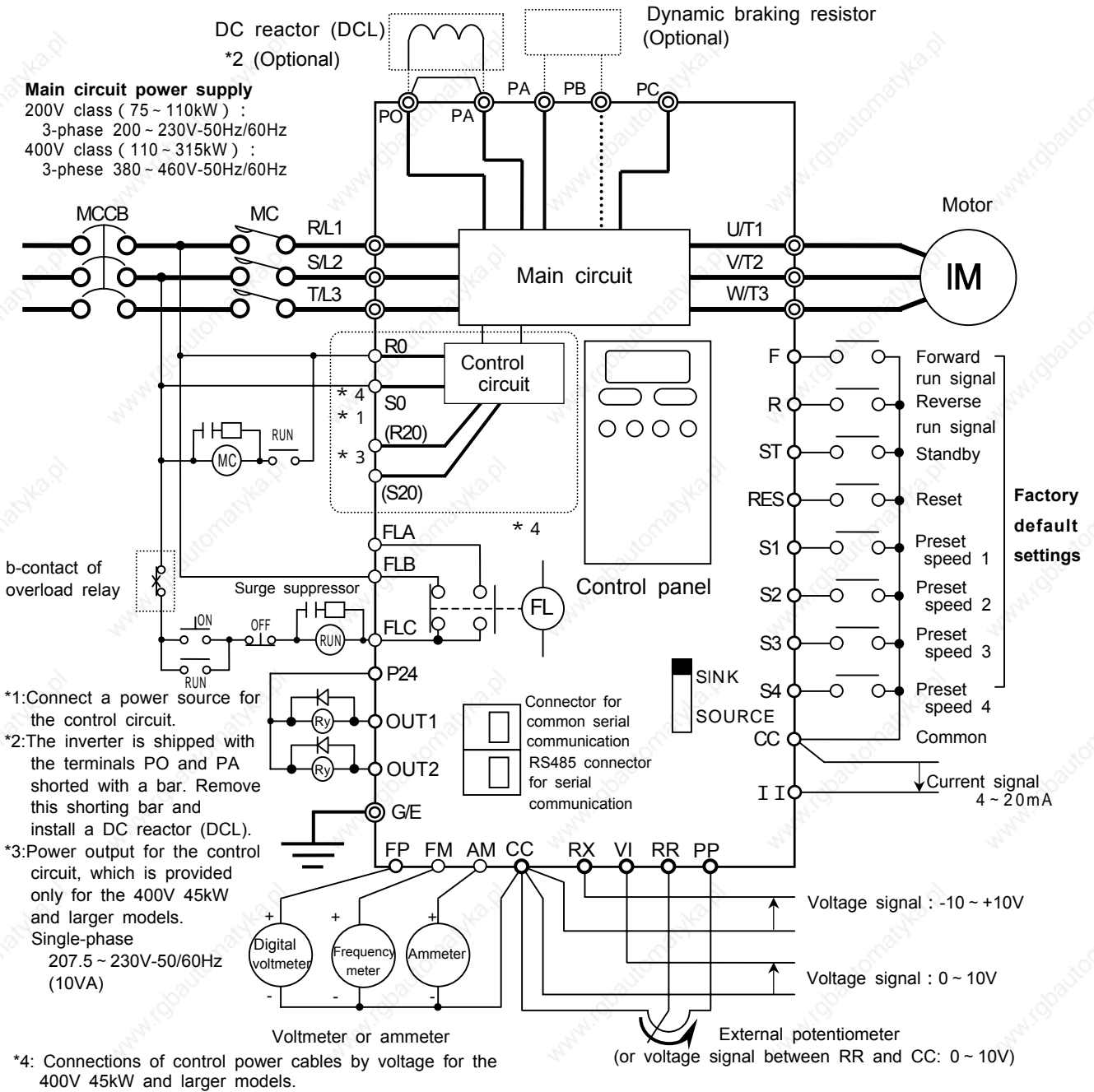

*1: Connect a power source for the control circuit.

*2: The inverter is shipped with the terminals PO and PA shorted with a bar. Remove this shorting bar and install a DC reactor (DCL).

*3: Power output for the control circuit, which is provided only for the 400V 45kW and larger models.
 Single-phase
 207.5 ~ 230V-50/60Hz
 (10VA)

*4: Connections of control power cables by voltage for the 400V 45kW and larger models.

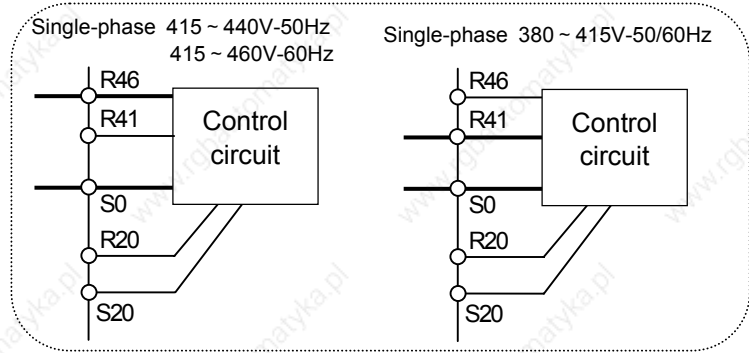

* Connection of a RUN relay for the 400V models

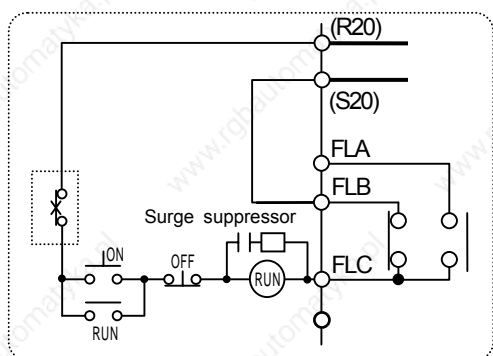

*5: For easy maintenance and inspection, connect the control power terminals RO and SO to the primary side of the MC in the main circuit so that the control panel can be checked if only the control circuit is energized.

2.3 Explanation of terminals

2.3.1 Main circuit terminals

Figure below shows an example of the wiring of the main circuit. Use optional devices, as required.

Connecting a power source and a motor

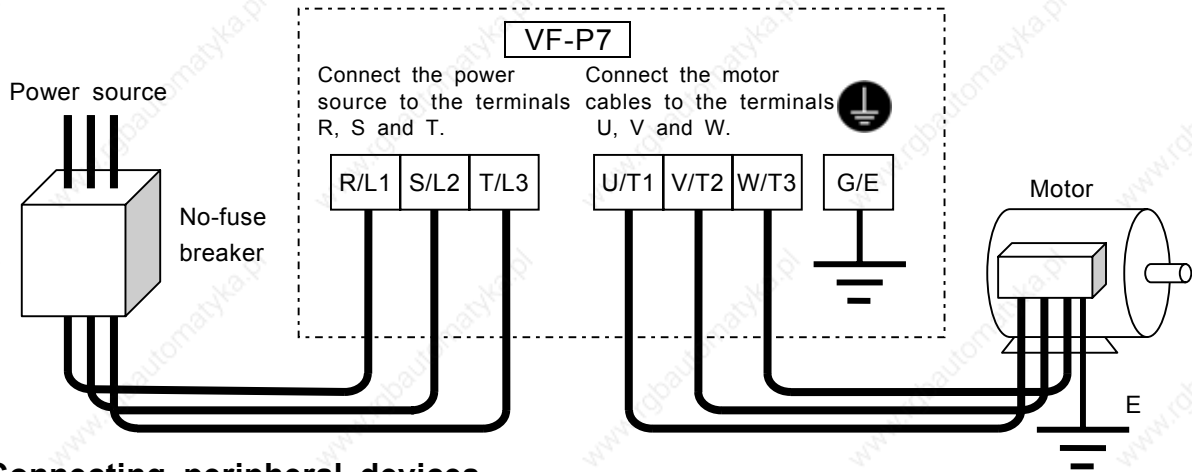

Connecting peripheral devices

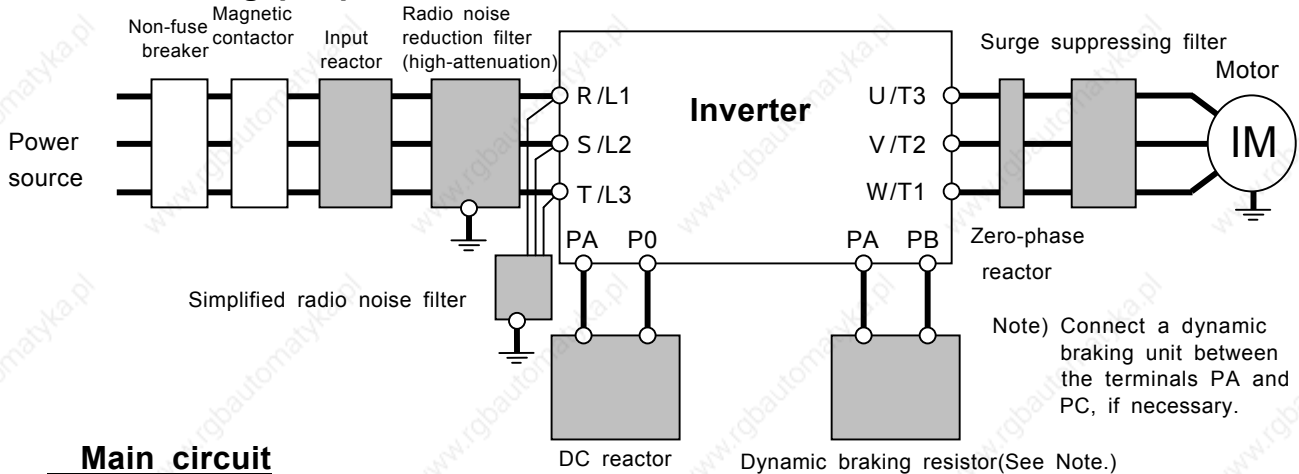

Main circuit

Terminal symbol	Function
G/E	Grounding terminal for the inverter's enclosure.
R/L1 , S/L2 , T/L3	200V class: 18.5 ~ 55kW: 3-phase 200 ~ 220V-50Hz, 200 ~ 230V-60Hz 75 ~ 110kW: 3-phase 200 ~ 230V-50/60Hz 400V class: 18.5 ~ 22, 110 ~ 315kW: 3-phase 380 ~ 460V-50/60Hz 30 ~ 90kW: 3-phase 380 ~ 440V-50Hz, 380 ~ 460V-60Hz
U/T1 , V/T2 , W/T3	Used to connect a motor (3-phase inductive motor)
R0 , S0 (R46, R41)	Used to connect a power source for the control circuit (Optional for the 22kW and smaller models, though these terminals are provided for them) 200V class: 18.5 ~ 55kW: Single-phase 200 ~ 230V-50/60Hz 75 ~ 110kW: Single-phase 200 ~ 220V-50Hz, 200 ~ 230V-60Hz 400V class: 18.5 ~ 22, 110 ~ 315kW: 3-phase 380 ~ 460V-50/60Hz 30 ~ 90kW: 3-phase 380 ~ 440V-50Hz, 380 ~ 460V-60Hz [Between R46-S0: Single-phase 415 ~ 440V-50Hz, 415 ~ 460V-60Hz] [Between R41-S0: Single-phase 380 ~ 415V-50Hz, 380 ~ 415V-60Hz] *Maximum allowable output of control power source: 200V class: 18.5 ~ 30kW...50VA, 37 ~ 110kW...60VA 400V class: 18.5 ~ 37kW...50VA, 45 ~ 90kW...150VA, 110 ~ 160kW...200VA, 200 ~ 315kW...350VA
PA, PB	Used to connect a dynamic braking resistor (For the optional dynamic braking unit, connect it between PA and PC.)the settings of the parameters <i>F304</i> , <i>F308</i> and/or <i>F309</i> , as required, when connecting an external resistor.

Terminal symbol	Function
PC	A negative potential terminal of the internal dc main circuit. This terminal can be used to connect a dc common power source in conjunction with the terminal PA (positive potential).
PO, PA	Used to connect a DC reactor (DCL: external option). The inverter is shipped with these terminals shorted. So, remove the shorting bar when connecting a DCL.
R20, S20	Used to connect the control output cables. Provided only for the 400V class 45kW and larger models. (10VA) 400V 45 ~ 90kW: Single-phase 207.5 ~ 220V 50Hz, 207.5 ~ 230V-60Hz 110 ~ 315kW: Single-phase 207.5 ~ 230V-50/60Hz

Terminal symbol	Inverter internal circuit
R/L1, S/L2, T/L3 U/T1, V/T2, W/T3 G/E	
R0, S0 (R46, R41, R20, S20)	<p>Fig.1: 200V class 18.5 ~ 22kW 400V class 18.5 ~ 22kW Fig.2: 200V class 30 ~ 110kW 400V class 30,37kW Fig.3: 400V class 45 ~ 315kW</p>
P0, PA, PB, PC,	<p>(*1) 18.5 and 22kW models contain rush-current prevention circuit in the rectifier-circuit part. (*2) The dynamic-braking circuit of 30kW model or larger are served as option correspondence.</p>

2.3.2 Control circuit terminals (sink logic(minus common))

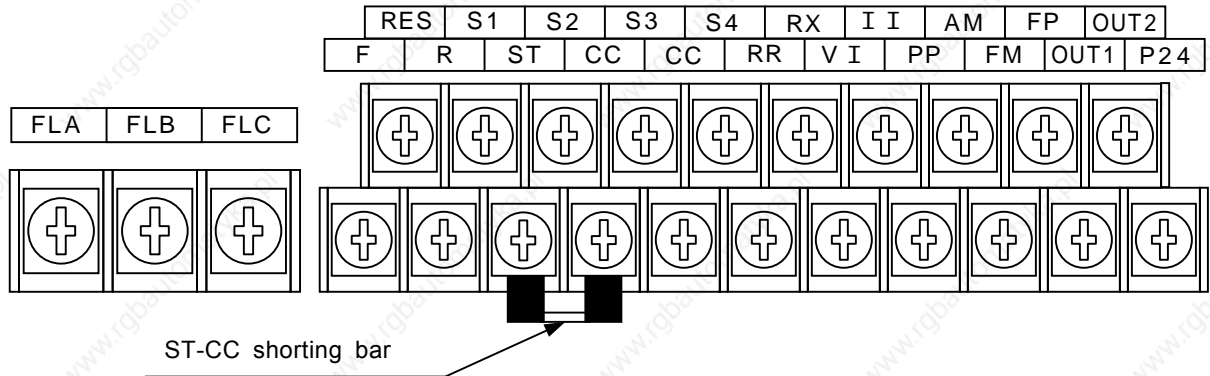

Terminal symbol	Input / output	Function	Electrical specification	Inverter internal circuit
F	Input	The motor rotates in forward direction if F and CC are connected, while it slows down to a stop if this Connection is broken. (ST and CC are connected).	No-voltage contact input 24Vdc 5mA and less	
R	Input	The motor rotates in reverse direction if R and CC are connected, while it slows down to a stop if this connection is broken. (ST and CC are connected).	<p>When using contacts, choose weak current contacts to avoid poor contact.</p>	
ST	Input	The motor is on standby if ST and CC are connected. It coasts to a stop (free-run stop) if this connection is broken. This terminal can be used for interlocking.		
RES	Input	* This inverter protective function is disabled if RES are CC is connected. Shorting RES and CC has no effect when the inverter is in a normal condition.	<p><u>Sink logic/ source logic switchable</u></p>	
S1	Input	The motor rotates at a preset speed if S1 and CC are connected.	<p>Sink input ON :5Vdc or less OFF:11Vdc or more Source input ON:11Vdc or more OFF:5Vdc or less</p>	
S2	Input	The motor rotates at a preset speed if S2 and CC are connected.		
S3	Input	The motor rotates at a preset speed if S3 and CC are connected.		
S4	Input	The motor rotates at a preset speed if S4 and CC are connected.		
PP	Output	Analog input setting power output.	<p>10Vdc (Allowable load current: 10mAdc)</p>	
RR	Input	Multifunction programmable analog input. Factory default setting: 0 to 10Vdc input sets 0 to 80Hz frequency range.	<p>10Vdc (Internal impedance: 33k)</p>	
VI	Input	Multifunction programmable analog input. Factory default setting: 2 to 10Vdc input sets 0 to 80Hz frequency range.	<p>10Vdc (Internal impedance :33k)</p>	
I I		Multifunction programmable analog input. Factory default setting: 4 to 20mAdc input sets 0 to 80Hz frequency range.	<p>4-20mA (Internal impedance :500)</p>	
RX	Output	Multifunction programmable analog input. Factory default setting: 0 to +/-10Vdc input sets 0 to +/-80Hz frequency range.	<p>10Vdc (Internal impedance :69k)</p>	

*Multifunction programmable contact input

Terminal symbol	Input / output	Function	Electrical specification	Inverter internal circuit
FM	Output	Multifunction programmable analog output. Factory default setting: Operation frequency command. Connect a 1mA dc full-scale ammeter or a 7.5Vdc(10Vdc)-1mA full-scale voltmeter.	1mA full-scale dc ammeter or 7.5Vdc-1mA full-scale dc voltmeter	
AM	Output	Multifunction programmable analog output. Factory default setting: Output current. Connect a 1mA dc full-scale ammeter or a 7.5Vdc(10Vdc)-1mA full-scale voltmeter.	1mA full-scale dc ammeter or 7.5Vdc-1mA full-scale dc voltmeter	
FP	Output	Multifunction open collector output. This terminal outputs pulses at 1.00 kHz to 43.20 kHz. Factory default setting: 3.84kHz.	Max. 50 mA	
CC	Common to I/O	Common terminal of the control circuit.		
P24	Output	24Vdc power output (power for control of the inverter).	24Vdc-100mA	
OUT1	Output	Multifunction programmable open collector output. The terminal has been set by default so as to detect and output low-speed signal output frequencies.	Open collector output: 24Vdc-50mA <u>*Sink logic/</u> <u>source logic</u> <u>switchable</u>	
OUT2		Multifunction programmable open collector output. The terminal has been set by default so as to detect and outputs signals indicating the completion of acceleration/ deceleration.		
FLA FLB FLC	Output	Relay contact output. Contact rating: 250 Vac = -2 A (cos = 1), 30 Vdc-1 A and 250 Vac-1A (cos = 0.4). Used to detect the activation of the inverter's protective function. If the protective function is activated, FLA-FLC circuit is closed, while FLB-FLC circuit is opened .	250Vac-2A 30Vdc-1A :resistor load 250Vac-1A :cos =0.4	

Sink logic (minus common)/source logic (plus common) ... Switching I/O terminal

The input terminals of most control circuits are designed so that they turn on when a current flows out. This type of logic is referred to as the "sink logic" (default setting). In Europe, however, the "source logic" is widely adopted, in which the input terminals of control circuits turn on when a current passes into them.

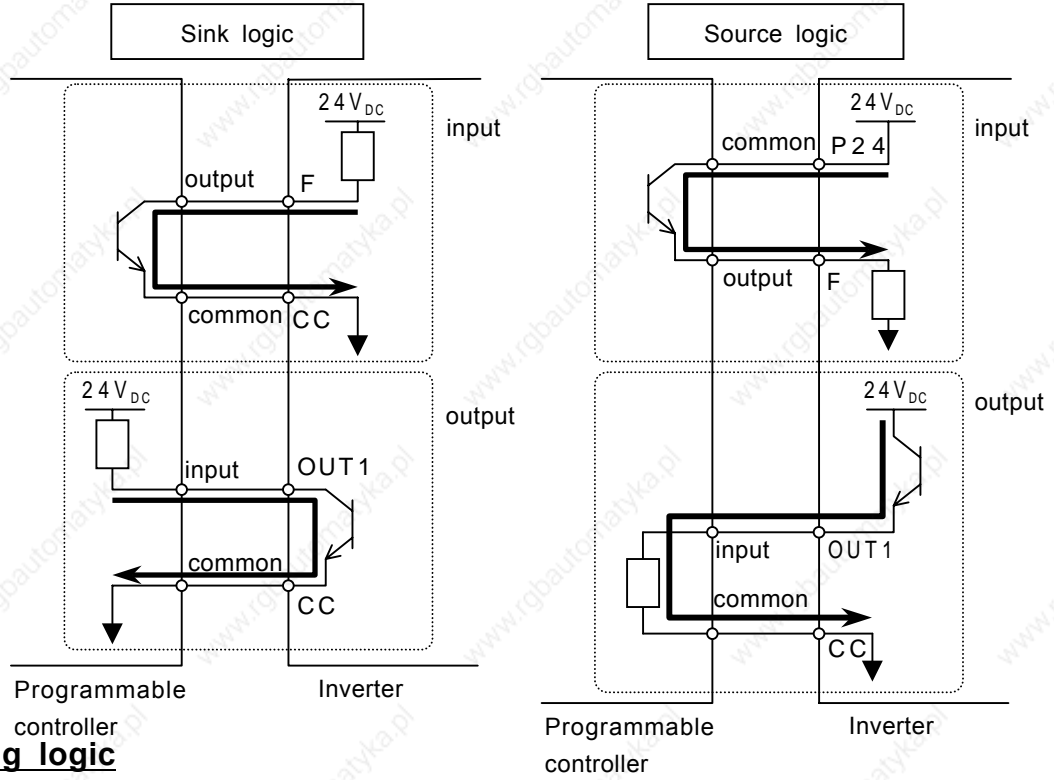

Switching logic

Before proceeding to wiring, switch logic without supplying power to the inverter. Switching between the sink logic and the source logic at start-up or when the inverter is energized causes the inverter to trip. In such a case, before resetting the inverter, make sure that the logic have been switched correctly.

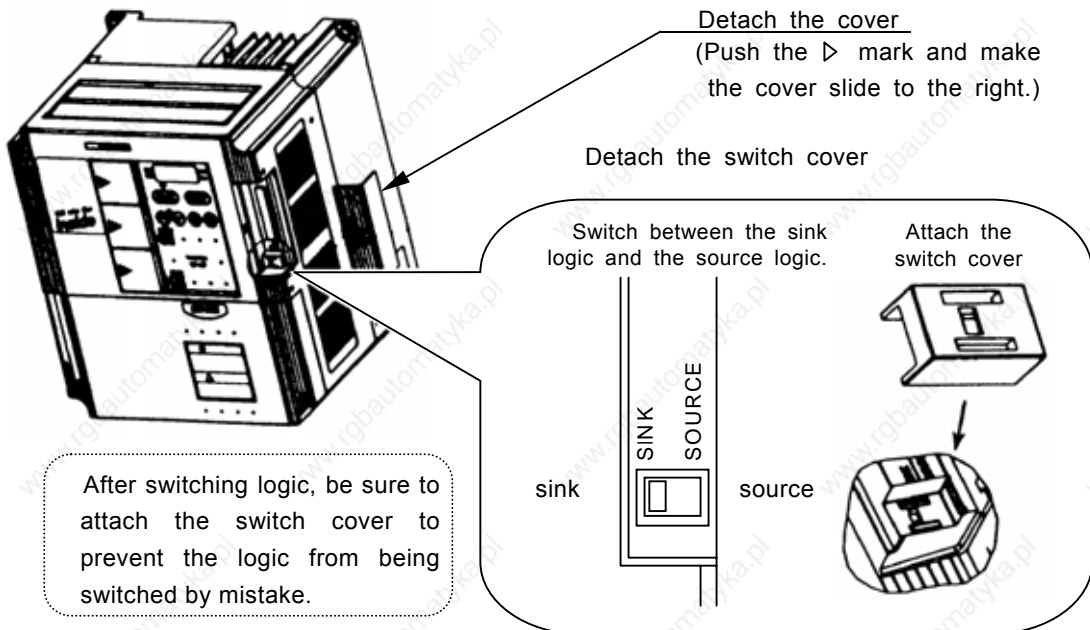

If the error message $E - 10$ (sink/source switching error) is displayed, check to be sure that the sequence is normal, then reset the inverter.

2.3.3 Serial RS485 communication connector

Figure of serial RS485 communication connector
 To use the serial RS485 connector, detach the cover for serial RS485 connector.

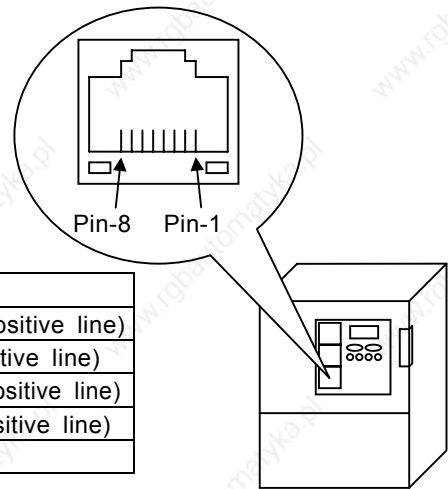

Signal name	Pin number	content
RXA	4	Same phase reception data(positive line)
RXB	5	Anti-phase reception data(positive line)
TXA	3	Same phase transmitting data(positive line)
TXB	6	Anti-phase transmitting data(positive line)
SG	2,8	Ground line of signal data

This table shows signal line of inverter side.

(Example: RXA signal is received by inverter.)

Never use pin-1(24Vdc) and pin-7(5Vdc).

Connecting diagrams for RS485 communication

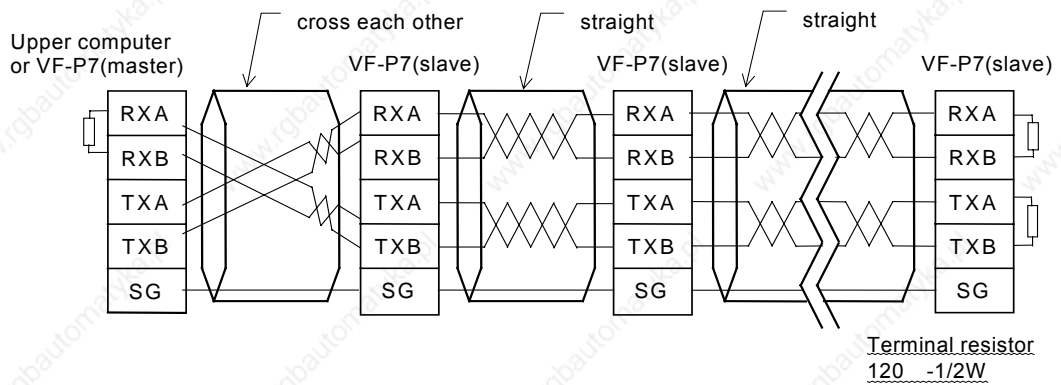

Note

Please detach a communication line and the main circuit wiring 20cm or more.

Please do not connect pin-1(24Vdc) and pin-7(5Vdc).

Please twist the lines between RXA and RXB, between TXA and TXB by the twist pair cable.



Please connect terminus resistance at the terminal (both ends) of a transmission way.

When you use it by 2 line type, please short-circuit between RXB and TXB, between RXA and TXA.



Master side reception(pin-4,pin-5) / slave side transmitting(pin-3,pin-6) lines may not connect at the time of communication between inverters.

3. Operating the inverter

Danger

 Prohibited	<ul style="list-style-type: none"> • Do not touch any inverter's terminal when the inverter is energized even if the motor is at a standstill, or you could get a shock. • Do not operate switches with a wet hand or not wipe it with a wet cloth, or you could get a shock. • Do not get near the alarm-stopped motor when the inverter is in retry mode, or you could get an injury. Safety measures, for example, attach a cover to the motor, to protect persons from accidents when the motor unexpectedly restarts.
 Mandatory	<ul style="list-style-type: none"> • Do not turn on the power before attaching the front cover (or closing the door of the cabinet in which the inverter is installed), or you could get a shock. • Turn off the power immediately in case the inverter smokes, smells strangely, or produce abnormal noise. Failure to do so could lead to a fire. If any defect is found, request your Toshiba dealer for repair. • Turn off the power before leaving the inverter out of operation for a long period of time. • Do not turn on the power before attaching the front cover. When the inverter is installed in a cabinet with the inverter's front panel detached, always close the door of the cabinet before turning on the power. Turning on the power with the cover or the door left opened could lead to an electric shock. • Turn off the operation signal before resetting the inverter after trouble, or the motor unexpectedly restarts, causing injury to persons.

Warning

 Never touch	<ul style="list-style-type: none"> • Do not touch any heat radiating fin or heat radiating resistor, or you could get a burn since they become very hot during operation.
 Mandatory	<ul style="list-style-type: none"> • Operate the motor always within the allowable operation range. (Refer to the motor's instruction manual for its allowable operation range.) Failure to do so could cause injury to persons.

3.1 Control modes of the VF-P7 inverter

[Speed control mode] : The motor runs at the speed specified by a frequency command.

- (1) V/f control - V/f constant (constant torque characteristic) ... [default setting]
For loads, such as belt conveyors and cranes, that require, even in low speed ranges, the same torque as that produced at their respective rated speeds.
- (2) V/f control - Square reduction torque
For loads, such as fans, pumps and blowers, the torque of which are proportional to the squares of their respective rotating speeds.
- (3) Automatic torque boost mode.
In this mode, the inverter automatically adjusts the supply voltage to ensure that the motor produces constant torque in any speed range.
- (4) Sensor-less vector control mode,
In this mode, the inverter controls the motor so that it produces sufficiently large torque even in an extremely low speed range and it keeps its rotating speed constant even if the load torque fluctuates. This mode of operation is best suited to transportation, lifting and winding equipment.
- (5) Automatic energy-saving mode.
In this mode, the inverter monitors the output voltage and passes an output current commensurate with the load. This mode of operation is used in conjunction with the above mode (3) or (4).

[Torque control mode] : The motor torque is controlled by torque command signals. The motor's rotating speed is determined by the relationship between the load torque and the torque produced by the motor.

Sensor vector control (Optional)

When combined with a sensor-equipped motor, the inverter controls the motor with a higher accuracy.

[Speed control mode] : The motor's rotating speed is controlled with a higher accuracy, even in low speed ranges, by feedback signals.

[Torque control mode] : The motor torque can be controlled in this mode. The motor speed is determined by the relationship between the load torque and the motor torque. The accuracy in controlling regenerative torque and power-running torque at extremely low speeds is improved by feedback signals.

[Position command mode] : Positioning control is carried out by means of pulses.

Pre-operation check the following check again before starting operation

Pre-operation check the following check again before starting operation.

- 1) Are all wires and cables connected correctly?
- 2) Does the supply voltage agree with the rated input voltage?

3.2 Simple operation of the VF-P7 [1] [Speed control mode]

A speed control mode can be selected from among three: control panel operation, terminal board operation and combination of both. (Refer to 5.3 for other modes of operation.)

- [Terminal operation] : Operation by means of external signals
- [Panel operation] : Operation by means of keys on the control panel
- [Panel + terminal operation] : Frequency, start and stop signals can be sent individually from the control panel and the terminal board.

3.2.1 Operation from the terminal(external signals) Terminal operation

Start/Stop Operation command mode selection $CC = 0$ [Default setting]

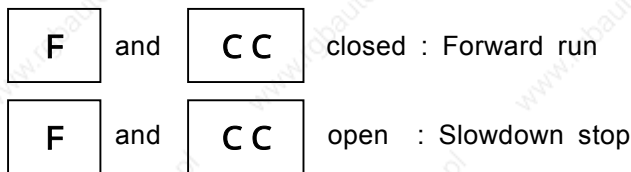

(When terminals ST and CC are electrically connected.)

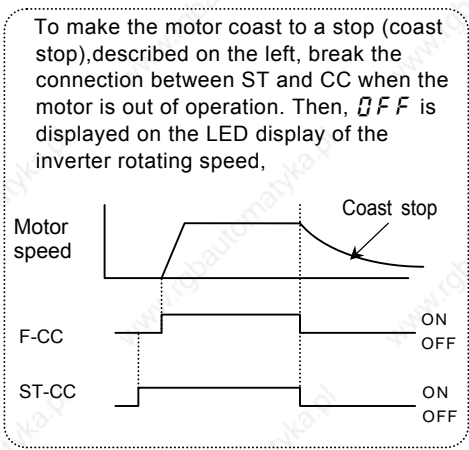
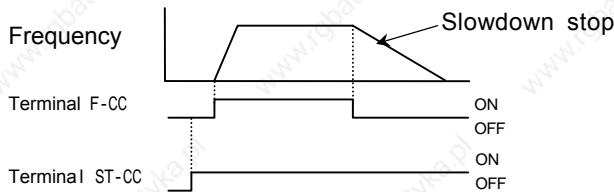

Example of typical connection

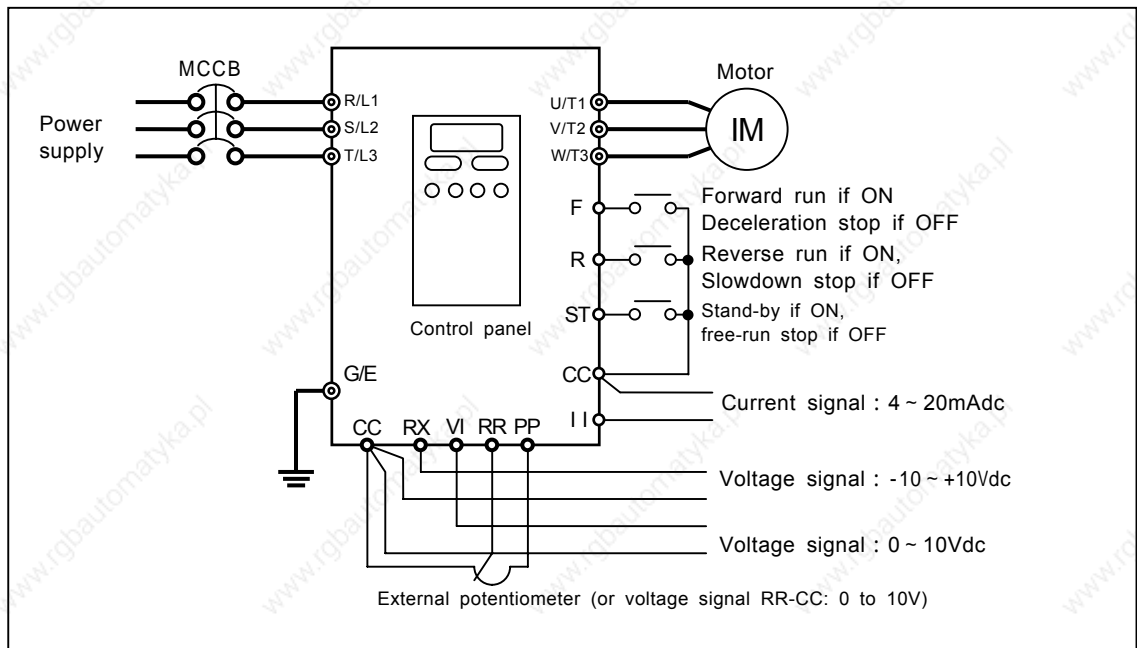

Frequency setting

1) Setting the operation frequency with an external volume control

By default, the VF-P7 inverter has been set to a mode in which an external volume control can be used for setting the operation frequency.

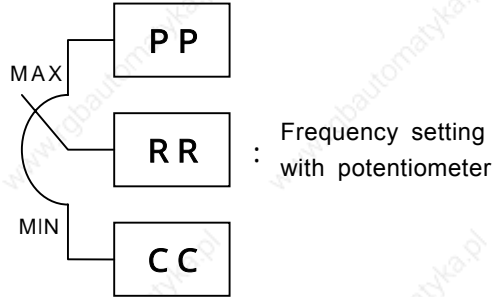

Volume control
The operation frequency by potentiometer (1 to 10k 1/4 W) for setting
Refer to 7.3 for details of adjustment.

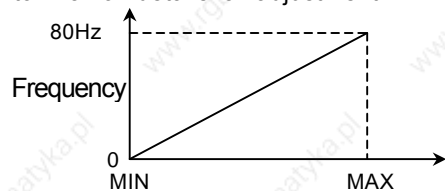

[Parameter setting]
Speed setting mode selection parameter *FNOd* at 2.
(There is no need to set this parameter before the first use after purchase.)

2) Setting the frequency by voltage signals (0 to 10 V)

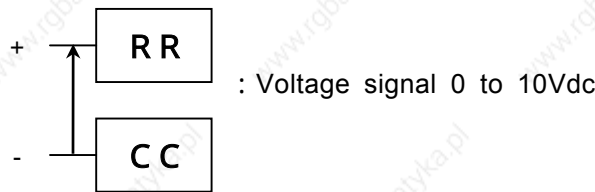

Voltage signal
Voltage signals (0 to 10 V) for setting the operation frequency
Refer to 7.3 for details of adjustment.

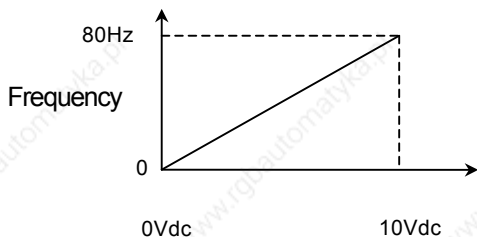

[Parameter setting]
Speed setting mode selection parameter *FNOd* at 2.
(There is no need to set this parameter before the first use after purchase.)

3) Setting the frequency by a current signal (4 to 20 mA)

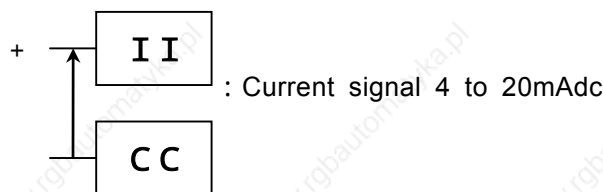

Current signal
Current signals (4 to 20 mA) for setting the operation frequency.
Refer to 7.3 for details of adjustment.

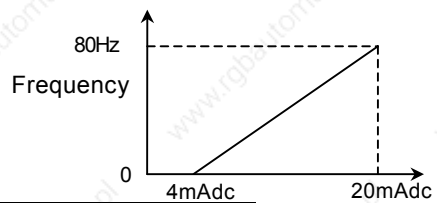

[Parameter setting]
Speed setting mode selection parameter *FNOd* at 1.

This setting cannot be made when the terminal VI is used.

4) Setting the frequency by voltage signals (0 to 10 Vdc)

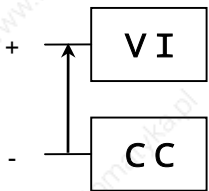

: Voltage signals 0-10Vdc

Voltage signal
Voltage signals (0 to 10 V) for setting the operation frequency Refer to 7.3 for details of adjustment.

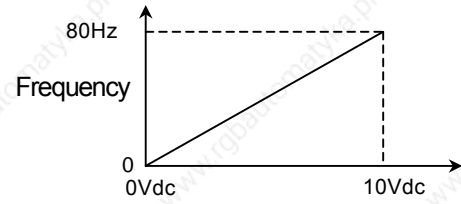

[Parameter setting] * Necessary to change the VI/II input point 1 setting $F201$.

Speed setting mode selection parameter $F00d$ at 1.

This setting cannot be made when the terminal II is used.

5) Setting the frequency by voltage signals (0 to +/-10Vdc)

The direction can be changed by switching between positive and negative signals.

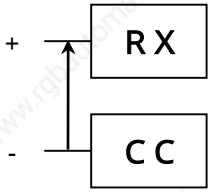

: Voltage signal 0- ± 10Vdc

Voltage signal
Voltage signals (0 to +/- 10 V) for setting the operation frequency Refer to 7.3 for details of adjustment.

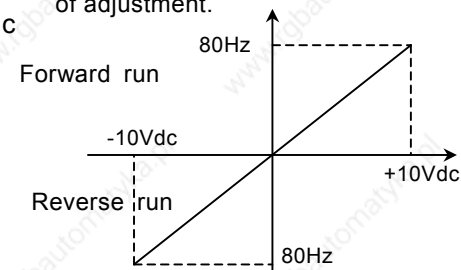

[Parameter setting]

Speed setting mode selection parameter $F00d$ at 3.



Note) Set reference priority selection $F200$ at 0 ($F00d$, Default setting). Changing the settings of two speed command parameters at a time, refer to 6.6.

[Ex.: To set the frequency by current signal (4 to 20 mA dc) through the terminal]

Key operated	LED display	Operation
	0.0	The running frequency is displayed. (Make this setting when the motor is out of operation.) (If the monitor display mode setting parameter $F710$ is set at 0 [Running frequency])
(MON)	$RU1$	Press the [MON] key to call up the first basic parameter $RU1$ (automatic acceleration/deceleration).
○ ○	$F00d$	Select $F00d$ by pressing the or key.
(ENT)	2	Press the Enter key to display the parameter setting (set value). (Default setting: 2)
○ ○	1	Change the parameter setting to 1 by pressing the key.
(ENT)	1 $F00d$	Press the Enter key to save the change. Then, $F00d$ and the set value are displayed alternately.

3.2.2 Operation from the control panel [Control panel operation]

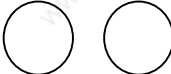
This section describes how to start/stop the motor, and set the operation frequency with the operating panel.

-  : Set the operation freq.
-  : Start the motor
-  : Stop the motor.
(Deceleration stop)

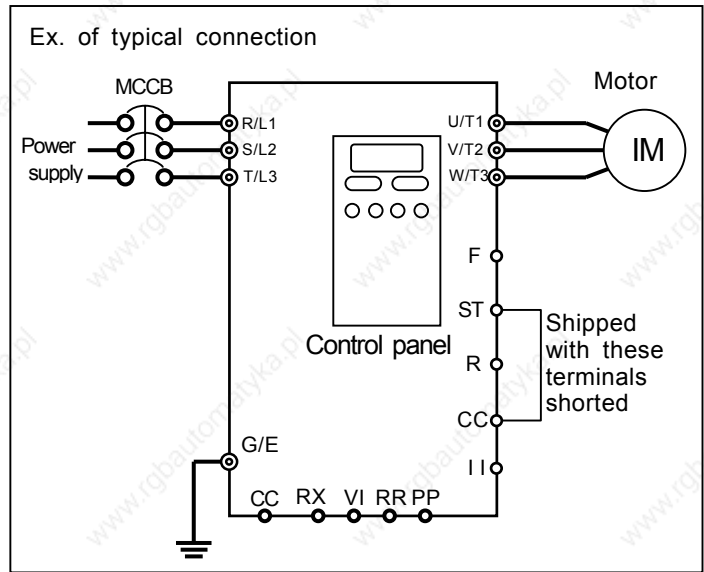
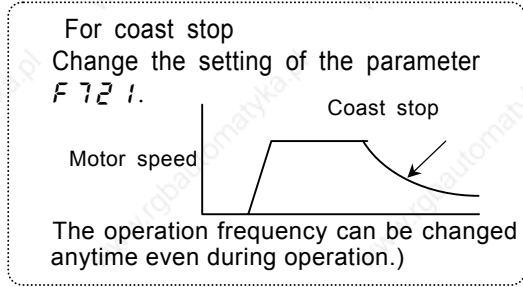















Change the settings of the following two parameters first from the operating panel.

$CNOd$: 1 (Control panel: Parameter determining the operation mode)









$FNOd$: 5 (Control panel: Parameter determining the input mode of speed reference)

[Setting procedure]

Key operated	LED display	Operation
	0.0	The running frequency is displayed. (Make this setting when the motor is out of operation.) (If the monitor display mode setting parameter $F710$ is set at 0 [Running frequency].)
	$RU1$	Press the [MON] key to call up the first basic parameter $RU1$ (automatic acceleration/deceleration).
	$CNOd$	Select " $CNOd$ " by pressing the  or  key.
	0	Press the Enter key to display the parameter setting. (Default setting: 0)
	1	Change the parameter setting to 1 (Operating panel enabled) by pressing the  key.
	1 $CNOd$	Save the change by pressing Enter key. Then, $CNOd$ and the set value are displayed alternately.
	$FNOd$	Select " $FNOd$ " by pressing  key or  key.
	2	Press the Enter key to display the parameter setting. (Default setting: 2).
	5	Change the parameter setting to 5 (Operating panel input). by pressing the  key.
	5 $FNOd$	Press the Enter key to save the change. Then, $FNOd$ and the set value are displayed alternately.

* To return to the standard monitor mode (operation frequency), press MON key.

Example of control panel operation

Key operated	LED display	Operation
	0.0	Display the running frequency. (If the monitor display selection parameter $F710$ is set at 0 [Running frequency])
 	50.0	Set the operation frequency.
	50.0 FL	Save the operation frequency by pressing Enter key. Then, FL and the set frequency is displayed alternately.
	0.0 50.0	Pressing the Run key causes the motor to accelerate to the set frequency in the specified acceleration time.
 	60.0	You can change the operation frequency anytime, even during operation, by pressing  or  key.
	60.0 0.0	Pressing the Stop button reduces the frequency and causes the motor to slow down to a stop.

Selecting a stop mode with the control panel

In addition to deceleration stop by pressing  key (in the specified deceleration time), the operating panel has the following two stop modes.

Stop mode	Description	Operation, setting, etc.
Coast stop	In this mode, power supply from the inverter to the motor is shut off instantaneously, which causes the motor to coast to a stop.	This stop mode is enabled only in modes where the control panel can be used for operation. To enable the free-run stop mode, set the panel stop pattern selection parameter $F721$ at 1. Refer to 6.30.7 for details of this setting. * Factory default setting: $F721 = 0$ (Coast stop)
Emergency stop (from the control panel in modes other than the panel operation mode)	A stop mode can be selected from among: <ul style="list-style-type: none"> • Coast stop • Slowdown stop • DC injection braking Note) default setting: $F603 = 0$ (Coast stop)	In modes other than the control panel operation mode, you can urgently stop the motor (emergency stop) by entering a command from the control panel. (To quickly stop the motor in the control panel operation mode, set the parameter $F721$ to this mode.) quickly stop the motor in case of an emergency, press twice the Stop key on the control panel. (1) Press the Stop key. "E0FF" starts blinking. (2) Press the Stop key again. $F603$ (Emergency stop) = 0 to 5, the motor makes an emergency stop (or trips) according to the setting. IF E is displayed and $F603$ is set at 0 to 2, an error detection signal (FL) is issued (FL is activated). (FL does not operate if $F603$ is set at 3 ~ 5.) To clear E0FF, press any key other than the Stop key while E0FF is being displayed. Refer to 6.26.4 for details. * Factory default setting: $F603 = 0$ (Coast stop) <div style="border: 1px dashed black; padding: 5px; margin-top: 10px;"> <p>Note) The emergency stop function is designed to forcefully stop the motor by pressing the Stop key on the control panel in modes other than the control panel operation mode. The emergency stop function cannot be disabled by any setting. Every emergency stop is memorized as a trip in the trip history record.</p> </div>

3.3 Operation of the VF-P7 [2]

PID control function of VF-P7 enables process control such as wind regulation or flux regulation, pressure regulation. Operation permission / prohibition

3.3.1 The outline of PID control

The outline block diagram of PID control becomes like the following figure.

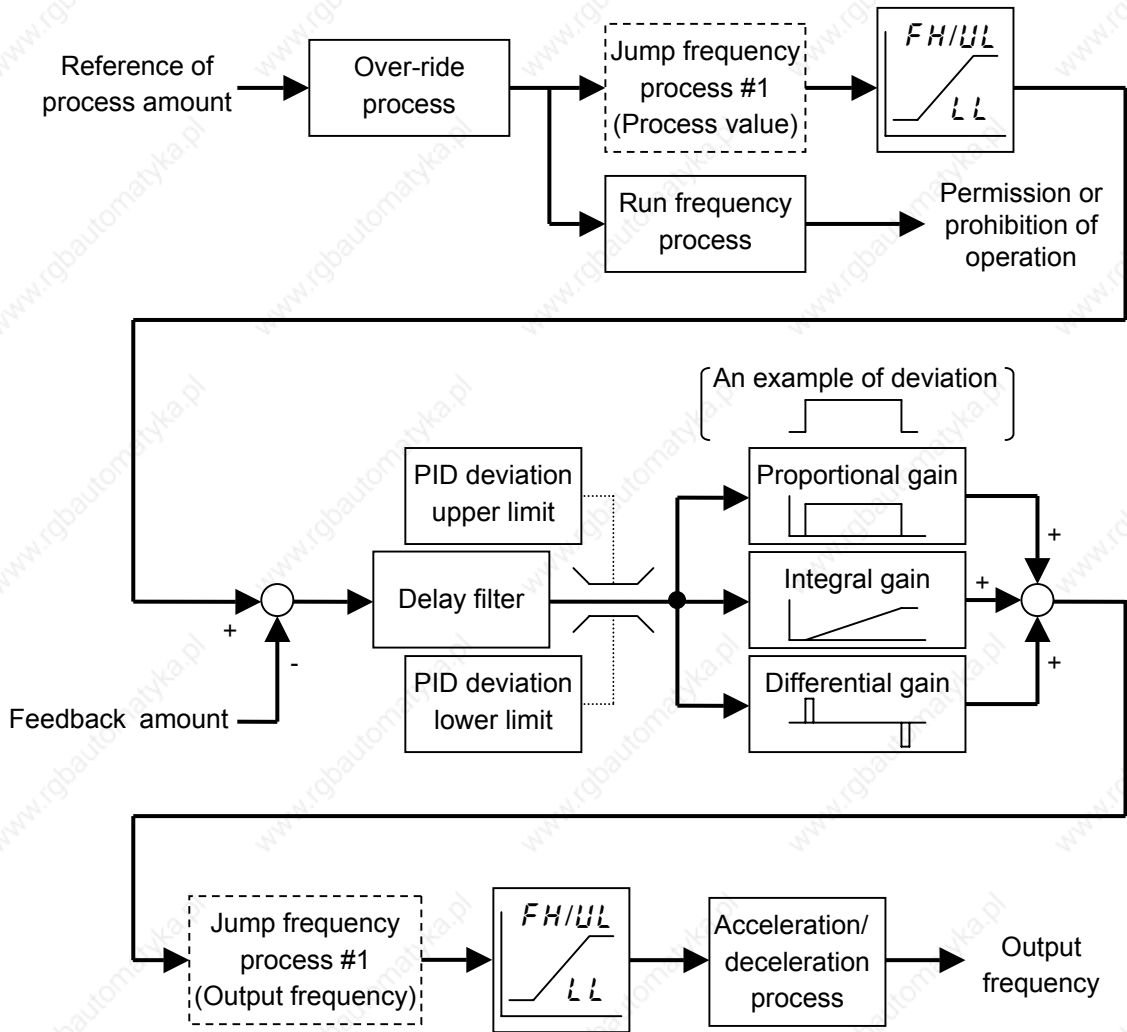

Note) Jump frequency function is performed to either of the following.

Process amount

Output frequency (Motor speed)

Set up with parameter $F27E$ for your application.

Block diagram of PID control system becomes like the following.

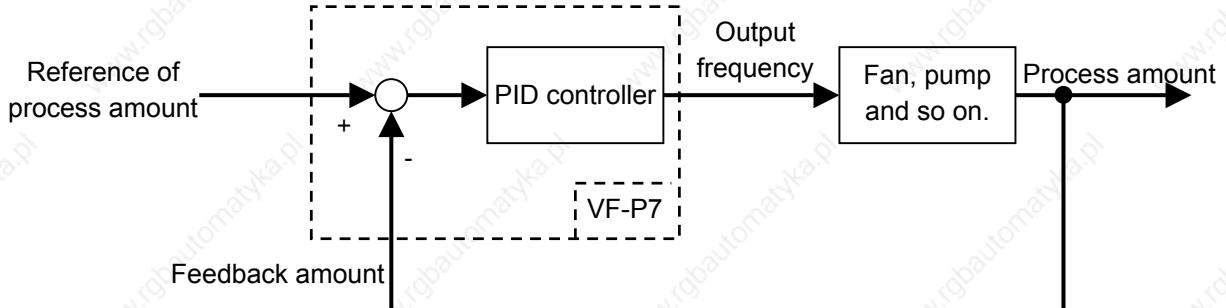

3.3.2 Settings of PID control

Parameters for PID control are following. Refer to Chapter 4 for how to set the parameters.

Item of setting	Parameter	Adjustment range	Default setting	Reference section
Maximum frequency	<i>FH</i>	30.0 ~ 400.0 [Hz]	80.0	5.7
Upper limit frequency	<i>UL</i>	0.0 ~ <i>FH</i> [Hz]	80.0	5.8
Lower limit frequency	<i>LL</i>	0.0 ~ <i>UL</i> [Hz]	0.0	5.8
Input terminal of feedback amount	<i>F360</i>	0: PID control disabled, 1: VI/II, 2: RR, 3: RX1, 4: RX2	0	Only this section
Process amount reference setting mode selection	<i>F00d</i>	1 ~ 11 (Refer to (4) for details)	2	5.3
Acceleration time	<i>ACC</i>	0.1 ~ 6000 [s]	Model dependent	5.1.2
Deceleration time	<i>DEC</i>	0.1 ~ 6000 [s]	Model dependent	5.1.2
Jump frequency	<i>F270</i>	0.0 ~ <i>FH</i> [Hz]	0.0	6.10
	<i>F272</i>			
	<i>F274</i>			
Jump frequency band	<i>F271</i>	0.0 ~ 30 [Hz]	0.0	6.10
	<i>F273</i>			
	<i>F275</i>			
Object of jump frequency process	<i>F276</i>	0: Process amount 1: Output frequency	0	Only this section
Over ride	<i>F660</i>	0 ~ 11	0	6.27
	<i>F661</i>	0 ~ 5	0	6.27
Run frequency	<i>F241</i>	0.0 ~ <i>FH</i> [Hz]	0.0	6.7.2
	<i>F242</i>	0.0 ~ 30.0 [Hz]	0.0	6.7.2

(1) Maximum frequency

Set the maximum value of frequency range that the inverter outputs, with maximum frequency (*FH*).

(2) Upper limit frequency / Lower limit frequency

Set the permissible maximum value of output frequency with upper limit frequency (*UL*) and permissible minimum value of output frequency with lower limit frequency (*LL*).

Upper limit frequency and lower limit frequency are also effective to process amount. Upper limit frequency and lower limit frequency limit process amount

(3) Input terminal for feedback amount

Set the input terminal for feedback amount with *F360*.

Refer to 7.3 for the scaling adjustment of analog input. This adjustment is effective for the case that input value of feedback amount is very small. Set the zero point of the feedback amount at the 0Hz and the maximum value of the feedback amount at the maximum frequency (*FH*).

Example of setting 1) In case of 4 to 20mA feedback amount (use the II terminal)

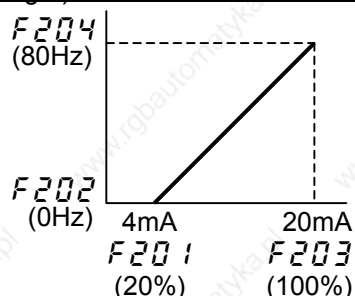

Maximum frequency (*FH*) is assumed to be 80Hz.

Note) Since feedback amount is treated as frequency value inside the inverter, the setting shown in the above figure is needed. Maximum frequency (*FH*) limits the feedback amount after the frequency conversion.

The reverse characteristic is also possible by changing the setting.

Example of setting 2) In case of 4 to 20mA feedback amount (use the II terminal)

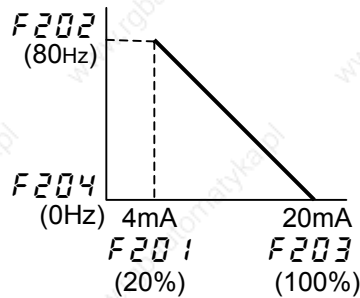

Maximum frequency (FH) is assumed to be 80Hz.

(4) Process amount reference setting mode selection

Setting mode of reference of the process amount is set with FND .

Title	Adjustment range
FND	1 : VI (voltage input)/II (current input), 2 : RR (volume/voltage input), 3 : RX (voltage input), 4 : RX2 (voltage input) (optional), 5 : Operating panel input, 6 : Binary/BCD input(optional), 7 : Common serial communication option(FA01) 8 : Serial communication RS485(FA05), 9 : Communication add-on cassette option(FA07) 10 : Up-down frequency, 11 : Pulse input #1 (optional)

Refer to 7.3 for the scaling adjustment of analog input.

Example of setting) In case of 0 to 10V feedback amount (use the RR terminal)

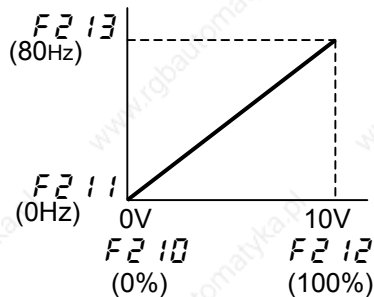

Note) Since reference of the process amount is treated as frequency value inside the inverter, the setting shown in the above figure is needed. Maximum frequency (FH) limits the reference of process amount after the frequency conversion. Upper limit frequency (UL) and lower limit frequency (LL) also limit the reference of process amount after the frequency conversion. (Refer to the block diagram in 3.3.1)

Two types of reference commands (refer to 6.6) or 15 preset speeds operation (refer to 5.14) are also be available for reference of the amount of processes.

(5) Acceleration/deceleration time

Set the acceleration time (ACC) and the deceleration time (DEC) at a smallest value (0.1). The response of PID control becomes fast. However, when a trip occurs, make setting values of these parameters larger.

(6) Jump frequency

Jump processing can be performed to the reference of the process amount. At this time, setting of jump processing is effective to the value after frequency conversion.(Refer to Example of setting in (4) above.) If you want to avoid resonance by the eigenoscillation frequency of the mechanical system, set $F275$ at 1. Jump processing becomes effective to output frequency. However in this case, since the jump frequency band turns into non-sensitive band and hunching between upper and lower side of jump frequency band may occur, resonance is completely unavoidable. Please be careful enough in use.

Note) Jump processing cannot be performed to both reference of process amount and output frequency.

(7) Over-ride

Over-ride function ($F 660$. $F 661$) is effective to the reference of process amount. Use this function to tune the reference finely.

(8) Run frequency

Run frequency function ($F 241$. $F 242$) is effective to the process amount.

It is a function that the inverter will operate if the setup of the process amount becomes higher than ($F 241 + F 242$), and the inverter will stop operation if becomes lower than ($F 241 - F 242$).

(9) Change to the open loop control operation

When you change from PID operation (automatic operation) to open loop operation (manual operation), assign PID control OFF selection function (36/37) to an input terminal (refer to 7.2.1 for details), or set the signal selection of PID control ($F 360$) at 0. At this time, since acceleration/deceleration times are set short as described in (5), cautions are required. Acceleration/deceleration times can be changed as occasion. (Refer to 6.23.2 for details)

3.3.3 Adjustment of PID control

Adjust the PID control gain to process amount, feedback signal and control object.

[Parameter settings]

Title	function	Adjustment range	Default setting
$F 361$	Delay filter	0 ~ 255	0
$F 362$	Proportional (P) gain	0.01 ~ 100.0	0.10
$F 363$	Integral (I) gain	0.01 ~ 100.0	0.10
$F 364$	PID deviation upper limit	0 ~ 50 [%]	50
$F 365$	PID deviation lower limit	0 ~ 50 [%]	50
$F 366$	Differential (D) gain	0.00 ~ 2.55	0.00

(1) Proportional gain

Proportional (P) gain ($F 362$) is proportional gain for PID control.

This gain is multiplied to deviation (difference between process amount and feedback amount) and gives the amount of compensation that is proportional to deviation. Setting this parameter at a large value gives a fast response, but too large value may result in an unstable phenomenon like hunting.

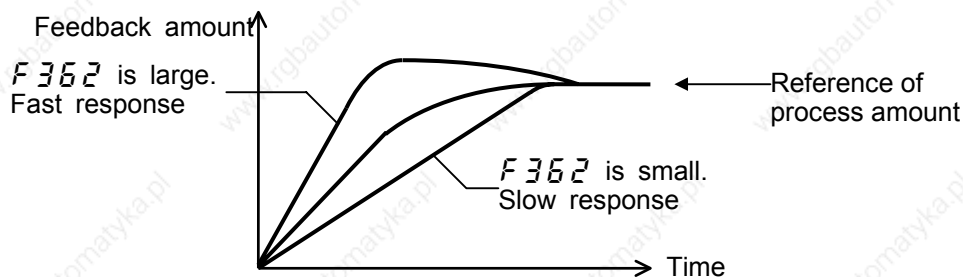

(2) Integral gain

Integral (I) gain ($F 3 5 3$) is integral gain for PID control.

This gain acts to make the deviation which remains in proportional operation (remained deviation offset) to zero. Setting this parameter at a large value gives smaller remained deviation offset, but setting at a too large value may result in an unstable phenomenon like hunting.

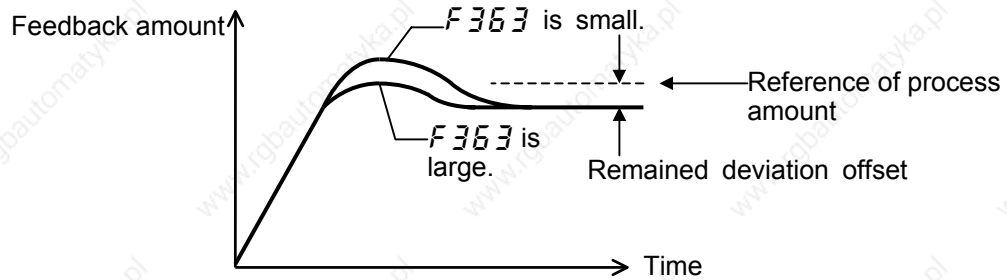

(3) Differential gain

Differential (D) gain ($F 3 5 5$) is differential gain for PID control.

This gain acts to improve the response to sudden change of the deviation. Setting this parameter at a too large value may result in an unstable phenomenon in which output frequency is greatly unsteady.

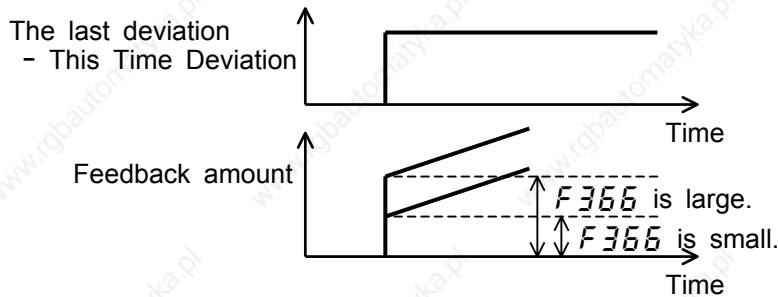

(4) Delay filter

Delay filter ($F 3 5 1$) acts to soften a rapid change of the deviation (linear delay function).

Usually, it is not necessary to change the setting. A small setting value makes processing fast, a large setting value makes it slow.

(5) PID deviation upper limit

PID deviation upper limit ($F 3 5 4$) is upper limit over positive deviation.

It limits the instantaneous value of deviation. Usually, it is not necessary to change the setting.

(6) PID deviation lower limit

PID deviation lower limit ($F 3 5 5$) is upper limit over negative deviation.

It limits the instantaneous value of deviation. Usually, it is not necessary to change the setting.

4. Basic operation of the VF-P7

[Speed control mode]
[Torque control mode]

The VF-P7 inverter has the following three display modes:

[Normal monitor mode] : Normal display mode. The inverter automatically enters this display mode when it is turned on.

This mode enables you to monitor the output frequency and set frequency command values. This mode is also used to display operation status alarm codes and error messages if the inverter trips.

- Frequency command setting => Refer to 3.2.1.
- Status alarms

If something unusual occurs in the inverter, an alarm code and the output frequency are displayed alternately on the LED display.

L : Indicates that a current exceeding the over-current stall limit is passed.

P : Indicates that an voltage exceeding the over-voltage stall limit is applied.

L : Indicates that the load exceeds 50% or more of the overload trip limit.

H : Indicates that the temperature in the inverter reaches the overheat protection alarm level (about 85)

[Setting monitor mode] :In this mode, you can set inverter's operation parameters.

How to set parameters => Refer to 4.1.

[Status monitor mode] : In this mode, you can monitor inverter's various statuses, for example, the set frequency, the output voltage, the output current and terminal information.

How to use the monitor => Refer to 8.1.

Press the **MON** key to switch to another display mode.

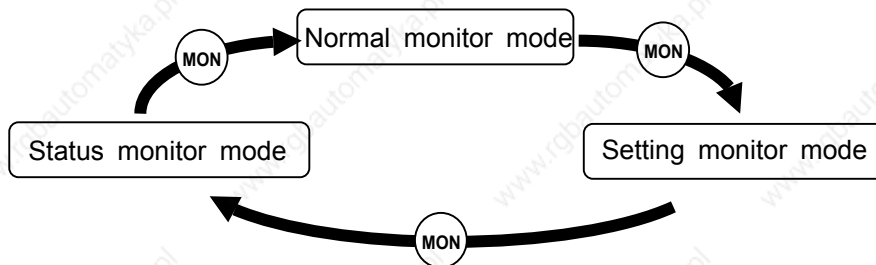

4.1 Setting parameters

[Setting monitor mode]

The VF-P7 inverter is shipped with certain parameters factory-set by default. The parameters are broadly classified under the following three groups. First, you need to select the parameter you want to change or check.

[Basic parameter] : Parameters that you need to set before the first use after purchase.

[Extended parameters] : Parameters used for detailed or particular settings

[User parameter] : Used to search for parameters the settings which have been changed and are different from the factory default settlings. Use this parameter to check parameter settings again after confirmation or when changing parameter settings.(Parameter code: *Cr.U*)

(For searching for parameters the settings of which have been changed).

About the parameter's adjustment range

H I: A value larger than the upper-limit value is entered or the value set for the currently-selected parameter becomes larger than the upper-limit value because another parameter was changed.

L 0: A value smaller than the lower-limit value is entered or the value set for the currently-selected parameter becomes smaller than the lower-limit value because another parameter was changed.

If the above alarm code **H I** or **L 0** blinks, change the parameter setting below the **H I** value or above the **L 0** value, respectively. When any of these alarm codes is blinking, no change can be made to any parameter.

4.1.1 How to set basic parameters [Basic parameter]

Every basic parameters can be set in the same way.
[Procedure for setting a basic parameter]

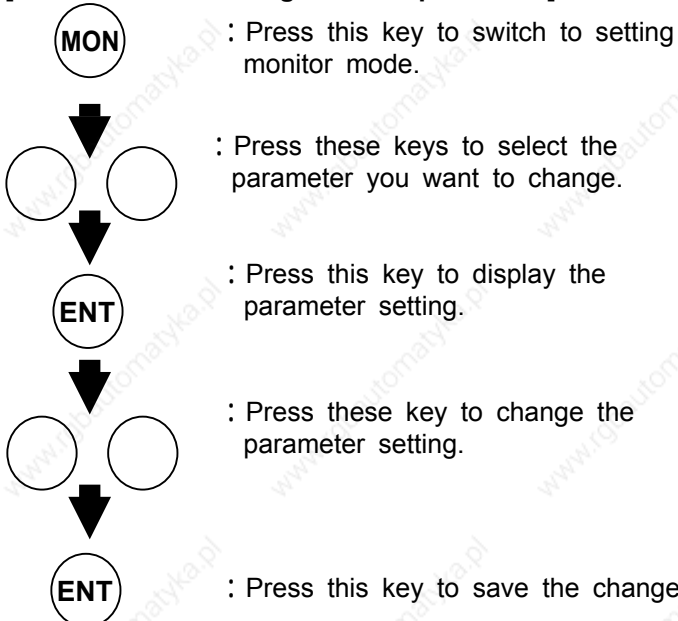

The inverter is shipped with certain parameters factory-set by default.

Use "Parameter list" to select the parameters you want to change.

If you feel puzzled about what to do next during this operation, press the Monitor key to return to the first step (0.0 is displayed).

Follow the procedure below to set a basic parameter.

(Example of setting: Changing the maximum frequency from 80 to 60 Hz)

Key operated	LED display	Operation
	0.0	The operation frequency is displayed. (Out of operation.) (If the monitor display mode setting parameter F 7 10 is set at 0 [Operation frequency])
MON	<i>RU 1</i>	Press the [MON] key to call up the first basic parameter <i>RU 1</i> (automatic acceleration/deceleration).
	<i>FH</i>	Select "FH" by pressing the or key.
ENT	80.0	Press the Enter key to display the changed maximum frequency.
	60.0	Change the maximum frequency to 60 Hz by pressing key.
ENT	60.0 <i>FH</i>	Press the Enter key to save the change. Then, <i>FH</i> and the set maximum frequency are displayed alternately.
After this, ENT	Press this key to display the same parameter setting.	MON Press this key to switch to status monitor mode. Press these keys to call up other parameters.

TOSHIBA

[Basic parameter list]

No.	Title	Function	Adjustment range	Default setting	Reference section																															
1	<i>RV1</i>	Automatic acceleration/deceleration	0: Manual acceleration/deceleration 1: Automatic acceleration/deceleration	0	5.1.1																															
2	<i>RV2</i>	Automatic V/f mode setting	0: - (0 is always displayed.) 1: Automatic torque boost + auto-tuning 2: Sensorless vector control (speed) + auto-tuning 3: Automatic energy-saving + auto-tuning	0	5.2																															
3	<i>EN0d</i>	Operation command mode selection	0: Terminal block enabled 1: Operating panel enabled 2: Common serial communication option enabled 3: Serial communication RS485 enabled 4: Communication add-on cassette option enabled	0	5.3																															
4	<i>FN0d</i>	Speed setting mode Selection	1: VI (voltage input)/II (current input) 2: RR (volume/voltage input) 3: RX (voltage input) 4: RX2 (voltage input) (optional) 5: Operating panel input 6: Binary/BCD input(optional) 7: Common serial communication option(FA01) 8: Serial communication RS485(FA05) 9: Communication add-on cassette option(FA07) 10: Up-down frequency 11: Pulse input #1 (optional)	2	5.3																															
5	<i>FN5L</i>	FM terminal meter selection	0 ~ 3 1	0	5.4																															
6	<i>FN</i>	FM terminal meter adjustment	-	-	5.4																															
7	<i>LYP</i>	Standard setting mode selection	0: - 1: 50Hz standard setting 2: 60Hz standard setting 3: Factory default setting 4: Trip clear 5: Clearing accumulating operation time 6: Initialization of type form information 7: Memorization of user-defined parameters 8: Reset of user-defined parameters	0	5.5																															
8	<i>Fr</i>	Forward/reverse selection (At panel control only)	0: Forward, 1: Reverse	0	5.6																															
9	<i>ACC</i>	Acceleration time #1	0.1(F508) ~ 6000 [s]	See J-28	5.1.2																															
10	<i>DEC</i>	Deceleration time #1	0.1(F508) ~ 6000 [s]	See J-28	5.1.2																															
11	<i>FH</i>	Maximum frequency	30.0 ~ 400 [Hz]	80	5.7																															
12	<i>UL</i>	Upper limit frequency	0.0 ~ FH [Hz]	80	5.8																															
13	<i>LL</i>	Lower limit frequency	0.0 ~ UL [Hz]	0.0	5.8																															
14	<i>uL</i>	Base frequency #1	25.0 ~ 400.0 [Hz]	50	5.9																															
15	<i>Pt</i>	Motor control mode selection	0: Constant torque 1: Variable torque mode 2: Automatic torque boost 3: Sensorless vector control (speed) 4: Automatic torque boost + automatic energy-saving 5: Sensorless vector control (speed) + automatic energy-saving 6: V/f 5-points setting 7: Sensorless vector control (speed/torque switching) 8: PG feedback vector control (speed/torque switching) 9: PG feedback vector control (speed/position switching)	0	5.10																															
16	<i>ub</i>	Manual torque boost	0 ~ 30 [%]	See J-28	5.1.2																															
17	<i>OLn</i>	Selection of electronic thermal protection characteristics	<table border="1"> <thead> <tr> <th>Setting</th> <th>Type</th> <th>Overload protection</th> <th>Overload stall</th> </tr> </thead> <tbody> <tr> <td>0</td> <td rowspan="3">Standard motor</td> <td>protect</td> <td>not stall</td> </tr> <tr> <td>1</td> <td>protect</td> <td>stall</td> </tr> <tr> <td>2</td> <td>not protect</td> <td>not stall</td> </tr> <tr> <td>3</td> <td rowspan="4">VF motor (special motor)</td> <td>not protect</td> <td>stall</td> </tr> <tr> <td>4</td> <td>protect</td> <td>not stall</td> </tr> <tr> <td>5</td> <td>protect</td> <td>stall</td> </tr> <tr> <td>6</td> <td>not protect</td> <td>not stall</td> </tr> <tr> <td>7</td> <td></td> <td>not protect</td> <td>stall</td> </tr> </tbody> </table>	Setting	Type	Overload protection	Overload stall	0	Standard motor	protect	not stall	1	protect	stall	2	not protect	not stall	3	VF motor (special motor)	not protect	stall	4	protect	not stall	5	protect	stall	6	not protect	not stall	7		not protect	stall	0	5.1.3
Setting	Type	Overload protection	Overload stall																																	
0	Standard motor	protect	not stall																																	
1		protect	stall																																	
2		not protect	not stall																																	
3	VF motor (special motor)	not protect	stall																																	
4		protect	not stall																																	
5		protect	stall																																	
6		not protect	not stall																																	
7		not protect	stall																																	
18	<i>sr1</i>	Preset-speed # 1	LL ~ UL [Hz]	0.0	5.1.4																															
19	<i>sr2</i>	Preset-speed # 2	LL ~ UL [Hz]	0.0																																
20	<i>sr3</i>	Preset-speed # 3	LL ~ UL [Hz]	0.0																																
21	<i>sr4</i>	Preset-speed # 4	LL ~ UL [Hz]	0.0																																
22	<i>sr5</i>	Preset-speed # 5	LL ~ UL [Hz]	0.0																																
23	<i>sr6</i>	Preset-speed # 6	LL ~ UL [Hz]	0.0																																
24	<i>sr7</i>	Preset-speed # 7	LL ~ UL [Hz]	0.0																																
25	<i>F1-- ~F9--</i>	Extended parameter	Setting of extended	-	4.1.2																															
26	<i>Ur.U</i>	Automatic edit function	To search parameters different from default value.	-	4.1.2																															

4.1.2 How to set extended parameters

The VF-P7 inverter has extended parameters to allow you to make full use of its functions. The code of every extended parameter is composed up of an **F** and a 3-digit number.

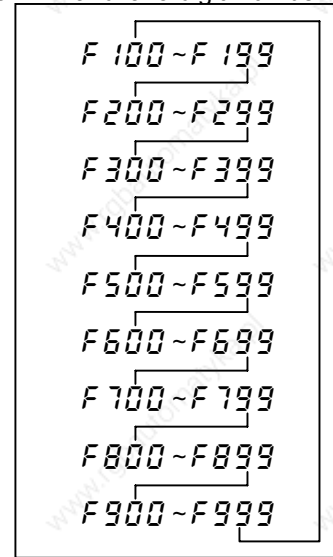
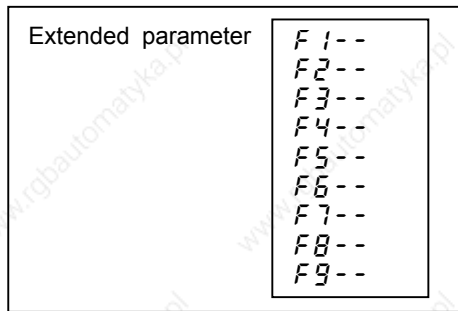

Press the Monitor key once, then press the **ENT** or **MON** key to select a parameter (F 1-- ~ F 9--) from among the basic parameters.

Select the parameter you want to change by pressing **ENT** and **MON** key, then press the Enter key to display the parameter setting.

[Procedure for setting an extended parameter]

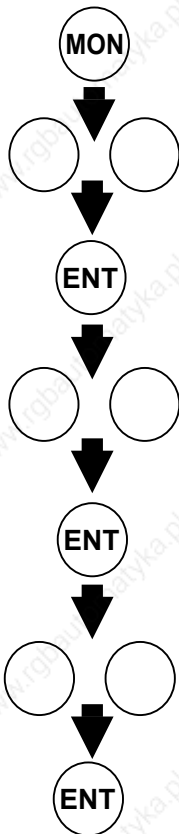

: Press the Monitor key to switch to parameter setting mode. (ALU 1 is displayed.)

: Select the parameter (F 1-- ~ F 9--) the code of which is the closest to that of the parameter you want to change.

: Press the Enter key to activate the selected parameter.

: Select the parameter you want to change .

: Press the Enter key to display the extended parameter setting (value) you want to change.

: Change the extended parameter setting (set value).

: Press the Enter key to save the change.

You can return to the previous step by pressing the **MON** key instead of the **ENT** key.

Example of parameter setting

Follow the procedure below to set a parameter.

(Example of setting: Changing the positive torque limit parameter *F441* from 150 to 100)

Key operated	LED display	Operation
	00	The operation frequency is displayed. (Make this setting when the motor is out of operation.) (If the monitor display mode setting parameter <i>F710</i> is set at 0 [Running frequency])
(MON)	RU1	Press the [MON] key to call up the first basic parameter <i>RU1</i> (Automatic acceleration/deceleration).
○ ○	F4--	Switch to the parameter group <i>F4--</i> by pressing the or key.
(ENT)	F400	Press the Enter key to activate the selected parameter group starting at <i>F400</i> .
○ ○	F441	Press the key to switch to the power running torque limit #1 <i>F441</i> .
(ENT)	150	Press the Enter key to display the parameter setting (set value).
○ ○	100	Change the positive torque limit parameter from 150 to 100 by pressing the key.
(ENT)	100 F441	Press the Enter key to save the change. Then, the parameter code and the set value are displayed alternately.

If you feel puzzled about what to do next during this operation, press the Monitor key several times to return to the step *RU1* and follow the above steps all over again.

4.1.3 Searching for changed parameters and changing their settings again











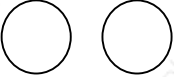



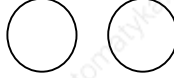

You can search for and display all parameters the settings of which have been changed are different from their respective default settings, using the user parameter group *Gr.U*. With this parameter, you can also change their settings.

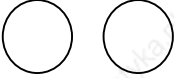
Notes on operation

- The user parameter group *Gr.U* does not display changed parameters anymore if their settings have been returned to their respective default settings.
 - It may take several seconds to display changed parameters because all data stored in the user parameter group is checked against the factory default settings.
- To cancel the parameter search in process, press the (MON) key.

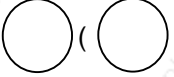
Searching for a parameter and changing its setting

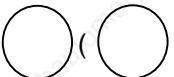
Follow the procedure below to search for parameters and change their settings.

Key operated	LED display	Operation
	0.0	The operation frequency is displayed. (Make this setting when the motor is out of operation.) (If the monitor display mode setting parameter $F710$ is set at 0 [Running frequency])
	$RU1$	Press the MON key to call up the first basic parameter $RU1$ (Automatic acceleration/deceleration).
	$Gr.U$	Select the user group parameter $Gr.U$ by pressing the  or  key.
	$U---$	Press the Enter key to enter the user parameter search and change mode.
 OR 	ACC	The inverter searches for and displays parameters the settings of which are different from their respective default settings. Press the Enter key or  key to switch parameters displayed. (Press the  key to search for parameters in reverse direction.)
	8.0	Press the [MON] key to display the parameter setting (set value).
	5.0	Change the parameter setting by pressing  or  key.
	$50 ACC$	Press the enter key to save the change. Then, the parameter code and the set value are displayed alternately.
	$U--F$ $(U--r)$	Following the same steps as above, search for and display other parameters you want to change, one by one, by pressing the  or  key, to check or change their settings.
	$U---$	$U---$ is displayed again after completion of a search for all changed parameters.
 	Parameter display $F r - F$ 0.0	To cancel the parameter search in process, press the Monitor key. Press the Monitor key once during search to return to parameter setting mode. Then, press the Monitor key to return to status monitor mode or normal monitor mode (operation frequency display mode).

If you feel puzzled about what to do next during this operation, press the Monitor key several times to return to the step $RU1$ and follow the above steps all over again.

4.1.4 Parameters that cannot be changed during operation

For safety, the following parameters are designed so that they cannot be changed when the inverter is in operation. So, you need to stop the motor in advance to change these parameters.

[Basic parameters]

<i>AU1</i>	(Automatic acceleration/deceleration)
<i>AU2</i>	(Automatic V/f mode setting)
<i>CNOd</i>	(Operation command mode selection)
<i>FNOd</i>	(Speed setting mode selection)
<i>FH</i>	(Maximum frequency)
<i>tYP</i>	(Standard setting mode selection)
<i>Pt</i>	(Motor control mode selection)
<i>OLn</i>	(Selection of electronic thermal protection characteristics)

For the parameter used to write-protect of extended parameters during operation, refer to Parameter list in 10.

4.1.5 Resetting all parameters to the factory default settings at a time





All changed parameters can be reset to their respective factory default settings at a time by setting the standard setting mode selection parameter *tYP* at *3*.

Note) Refer to 5.5 for details of the standard setting mode selection parameter *tYP*.

Note on operation

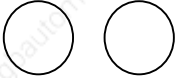
Setting the parameter *tYP* at *3* causes all parameters to return to the factory default settings. Therefore, it is advisable to note all changed settings before returning them to the default settings.

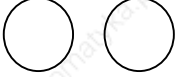
Procedure for resetting all parameters to the factory default settings at a time

Key operated	LED display	Operation
	<i>0.0</i>	The operation frequency is displayed. (Make this setting when the motor is out of operation.)
	<i>AU1</i>	Press the [MON] key to call up the first basic parameter <i>AU1</i> (automatic acceleration/deceleration).
	<i>tYP</i>	Switch to <i>tYP</i> by pressing or key.
	<i>0</i>	Press the Enter key to display the parameter setting (set value). (" <i>0</i> " is always displayed when the parameter <i>tYP</i> is called up.)
	<i>3</i>	Change the parameter setting by pressing or key. To return all parameters to the factory default settings, change the parameter setting to <i>3</i> .
	<i>in It</i>	<i>in It</i> is displayed while all parameters are being reset to their respective default settings.
	<i>0.0</i>	The LED returns to the original display mode.

If you feel puzzled about what to do next during this operation, press the Monitor key several times to return to the step *AU1* and follow the above steps all over again.

TOSHIBA

Following parameters are designed considering maintenance that they cannot be reset to the factory default setting even if you set the parameter $\epsilon 4P$ at 3 (see 5.5). Moreover, x-marked parameters are not displayed on the user parameter group $\epsilon r.u$ (see 4.1.3) even if their settings are different from their default settings. So please be careful.

Title	Function	$\epsilon r.u$ display
$F 75L$	FM terminal meter selection	
$F 7$	FM terminal meter adjustment	X
$F 670$	AM terminal meter selection	
$F 671$	AM terminal meter adjustment	X
$F 672$	Optional analog terminal #1 meter selection	
$F 673$	Optional analog terminal #1 meter adjustment	X
$F 674$	Optional analog terminal #2 meter selection	
$F 675$	Optional analog terminal #2 meter adjustment	X

Title	Function	$\epsilon r.u$ display
$F 470$	VI/II reference bias	X
$F 471$	VI/II reference gain	X
$F 472$	RR reference bias	X
$F 473$	RR reference gain	X
$F 474$	RX reference bias	X
$F 475$	RX reference gain	X
$F 476$	RX2 reference bias	X
$F 477$	RX2 reference gain	X

5. Explanation of the basic parameters

Basic parameters refer to parameters you need to set before the first use after purchase.

5.1 Setting the acceleration and deceleration times

$RU1$: Automatic acceleration/deceleration

ACC : Acceleration time #1

DEC : Deceleration time #1

• **Function**

- 1) The acceleration time parameter ACC is to set the time in which the inverter's output frequency goes up from 0 Hz to the maximum frequency FH .
- 2) The deceleration time parameter DEC is to set the time in which the inverter's output frequency goes down from the maximum frequency FH to 0 Hz.

5.1.1 Automatic acceleration/deceleration

In this mode, the acceleration and deceleration times are changed automatically according to the load applied. $RU1 = 1$

* The acceleration and deceleration times are adjusted automatically within a range of 1/8 to 8 times longer than the times set with the ACC and the DEC , respectively.

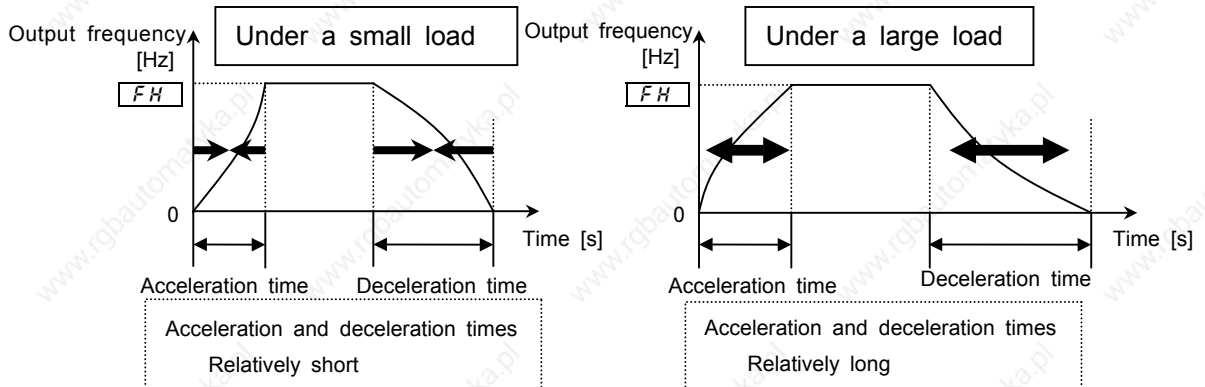

Set the parameter $RU1$ (automatic acceleration/deceleration) at 1 (enabled).

[Parameter setting]

Title	Function	Adjustment range	Default setting
$RU1$	Automatic acceleration/ deceleration	0: Manual acceleration/deceleration 1: Enabled (automatic setting)	0

When the automatic acceleration/deceleration is selected (enabled), the acceleration/deceleration times constantly change according to the load condition. So, use the manual setting (ACC , DEC) for machines that need to be accelerated and decelerated always at constant rates.

Set manually the acceleration and deceleration times ($RU1 = 0$) in the case that braking resistor or braking unit is applied ($F304 = 1$).

Before setting this parameter, connect the inverter to the motor.

For a load that requires the inverter to be operated almost at its rated current, the motor may fail to reach the specified speed within the specified time. In such a case, set manually the acceleration and deceleration times ($RU1 = 0$).

If you set in advance the acceleration and deceleration times (ACC , DEC) so that they match the average load condition, you can make the optimum setting to control the motor with a higher accuracy according to changes in the load applied.

[Procedure for setting the automatic acceleration and deceleration times]

Key operated	LED display	Operation
	0.0	The running frequency is displayed. (If the monitor display mode setting parameter $F710$ is set at 0 [Running frequency])
(MON)	$AU1$	Press the [MON] key to call up the first basic parameter $AU1$ (Automatic acceleration/deceleration).
(ENT)	0	Press the Enter key to display the parameter setting.
()	1	Change the parameter setting to 1 (automatic acceleration/deceleration enabled) by pressing key.
(ENT)	1 $AU1$	Press the Enter key to save the change. Then, $AU1$ and the set value are displayed alternately.

5.1.2 Manually setting the acceleration and deceleration times

This section describes how to set the acceleration time (the operation frequency goes up from 0Hz to the maximum frequency FH and the deceleration time (the operation frequency goes down from the maximum frequency FH to 0Hz).

Output frequency [Hz]

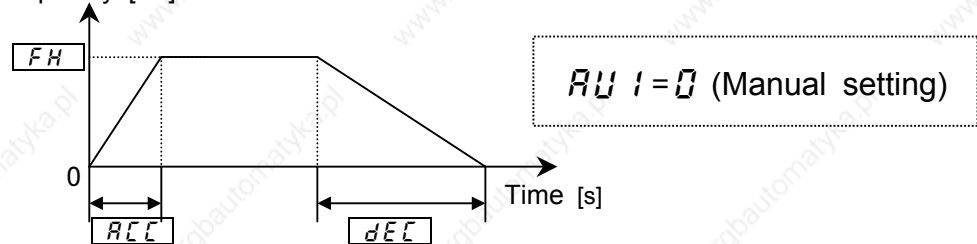

[Parameter setting]

Title	Function	Adjustment range	Default setting
ACC	Acceleration time #1	0.1 (See note.) ~ 6000 [s]	Model dependent
DEC	Deceleration time #1	0.1 (See note.) ~ 6000 [s]	Model dependent

Note) The minimum setting of acceleration and deceleration times have been set respectively at 0.1sec. by default, but they can be changed within a range of 0.01 to 10 sec. by changing the setting of the parameter $F508$ (Acceleration/deceleration time lower limit).

Refer to 6.23.3 for details.

If the acceleration or deceleration time is set shorter than the optimum time, which varies according to the loading condition, it may become longer than the set time because of the over-current stall function or the over-voltage stall function. In addition, if the acceleration or deceleration time is set much shorter, the inverter trips more easily to protect itself from an over-current or an over-voltage.

(Refer to 12.1 for details.)

5.2 Increasing starting torque/ energy-saving operation mode

AU2 : Automatic V/f mode setting

• **Function**

This parameter enables the inverter to automatically switch V/f control modes and set the motor constant (online automatic control) at the same time to make the motor produce larger torque. With this parameter, two control modes can be set at a time, for example, special V/f control modes, including the automatic torque boost mode and the vector control mode.

- Constant torque characteristic (Default setting)
- **Automatic torque boost + auto-tuning**
- **Vector control (speed control) + auto-tuning**
- Automatic energy-saving + auto-tuning

Note) With the motor control selection parameter $P\bar{L}$, you can set the square reduction torque, the sensor vector control (optional), etc.
=> Refer to 5.10 for details.

Title	Function	Adjustment range	Default setting
$AU2$	Automatic V/f mode setting	0 : (0 is always displayed.) 1 : Automatic torque boost + auto-tuning 2 : Sensorless vector control (speed) + auto-tuning 3 : Automatic energy-saving + auto-tuning	0

Note) The parameter always returns to 0 after completion of the setting. To check the setting (set value), check the $AU2$ previous monitor in monitor mode. (Refer to 8.1 for details.)

1) To automatically increase the torque according to the load condition

Set the automatic V/f mode setting $AU2$ at 1 (automatic torque boost + auto-tuning).

When the automatic V/f mode setting $AU2$ is set at 1 (automatic torque boost + auto-tuning), the load current is observed in all speed ranges and the inverter's output voltage is adjusted automatically so that the motor can always produce torque large enough for stable operation.

Note1) The same characteristic can be obtained by setting the motor control mode selection Parameter $P\bar{L}$ at 2 (automatic torque boost) and the automatic tuning $F400$ (auto-tuning) at 2 . => Refer to 5.10 for details.

[Setting procedure]

Key operated	LED display	Operation
	0.0	The running frequency is displayed. (Make this setting When the motor is out of operation.)(If the monitor display selection parameter $F710$ is set at 0 [Running frequency])
(MON)	$AU1$	Press the [MON]key to read the first basic parameter $AU1$ (Automatic acceleration/deceleration).
()	$AU2$	Switch to the parameter $AU2$ (automatic control) by pressing the key.
(ENT)	0	Press the Enter key to display the parameter setting (set value).
()	1	Change the parameter setting to 1 (automatic torque boost + auto-tuning) by pressing the key.
(ENT)	$1 AU2$	Press the Enter key to save the change. Then, $AU2$ and the set value are displayed alternately.

Note 2) Setting $AU2$ at 1 causes $P\bar{L}$ to be set at 2 automatically.

2) The vector control (Increasing the starting torque and operating with a higher accuracy)

Set the automatic V/f mode setting $AU2$ at 2 (vector control (speed) and auto-tuning).

By setting the automatic V/f mode setting $AU2$ at 2 (vector control (speed control) and auto-tuning), the motor reach its full potential and produce large torque even at low speeds. Also, you can minimize motor speed fluctuations caused by load fluctuations for more accurate operation. This mode of control is best suited to conveyor and crane/hoist application as operated in speed control mode.

[Setting procedure]

Key operated	LED display	Operation
	0.0	The running frequency is displayed. (Make this setting when the motor is out of operation.) (If the monitor display selection parameter $F710$ is set at 0 [Running frequency])
(MON)	$AU1$	Press the [MON] key to call up the first basic parameter $AU1$ (automatic acceleration/deceleration).
()	$AU2$	Switch to the parameter $AU2$ (Automatic V/f mode setting) by pressing the key.
(ENT)	0	Press the Enter key to display the parameter setting (set value).
()	2	Change the parameter setting to 2 (sensor-less vector control and auto-tuning) by pressing the key.
(ENT)	2 $AU2$	Press the Enter key to save the change. Then, $AU2$ and the set value are displayed alternately.

Note 1) The same characteristic can be obtained by setting the motor control mode selection parameter $P4$ at 3 (vector control) and the auto-tuning parameter $F400$ at 2 . Refer to 5.10 for details.

2) Setting $AU2$ at 2 causes $P4$ to be set at 3 automatically.

3) To operate the inverter in energy-saving mode

Set the automatic V/f mode setting $AU2$ at 3 (automatic energy-saving + auto tuning).

When the automatic V/f mode setting $AU2$ is set at 3 , the inverter passes a current commensurate with the load to save energy.

[Setting procedure]

Key operated	LED display	Operation
	0.0	The running frequency is displayed. (Make this setting when the motor is out of operation.) (If the monitor display mode setting parameter $F710$ is set at 0 [Running frequency])
(MON)	$AU1$	Press the [MON] key to call up the first basic parameter $AU1$ (Automatic acceleration/deceleration).
()	$AU2$	Switch to the parameter $AU2$ (Automatic V/f mode setting) by pressing the key.
(ENT)	0	Press the Enter key to display the parameter setting (set value). (The value is always 0 .)
()	3	Change the parameter setting to 3 (automatic energy-saving and auto-tuning) by pressing the key.
(ENT)	3 $AU2$	Press the Enter key to save the change. Then, $AU2$ and the parameter set value 3 are displayed alternately.

If you fail to make the setting for vector control ...

First, read the notes on vector control in 9) of section 5.10)

- 1) If the expected torque cannot be obtained => Selection 3 in 6.20
- 2) If the auto-tuning error message EEn is displayed => Selection 3 in 6.20

$RU2$ (Automatic V/f mode setting) and Pt (Motor control mode selection)

The automatic control parameter is designed to set motor control mode selection parameter (Pt) and the auto-tuning parameter ($F400$) by one operation. Therefore, changing the $RU2$ setting causes the settings of all related parameters to be changed automatically.

$RU2$		Parameters set automatically	
		Pt	$F400$
0	0 is always displayed.	-	Check the Pt setting (set value). (0 (constant torque) if no change is made to $RU1$)
1	Automatic torque boost + auto-tuning	2	Automatic torque boost
2	Vector control (speed) + auto-tuning	3	Sensor-less vector control (speed control)
3	Automatic energy-saving + auto-tuning	5	Automatic energy-saving + sensorless vector control
			Executed (Returns to 0 after execution)
			Executed (Returns to 0 after execution)
			Executed (Returns to 0 after execution)

4) To increase torque manually (V/f constant control)

The VF-P7 inverter has been set to this control mode by default.

This control mode in which the torque is kept constant is suitable for belt conveyers, and so on. It is recommended to select this mode if you want to manually increase the starting torque.

To return to the V/f constant control mode after changing the setting of the parameter $RU2$,

Set the motor control mode selection parameter Pt at 0 (constant torque)

=> Refer to 5.10

Note 1) If there is a need to further increase the torque, increase the torque boost rate, using the manual torque boost parameter ub . For the procedure for setting the manual torque boost parameter ub

=> Refer to 5.12)

2) The square reduction torque characteristic (set the motor control mode selection parameter Pt at 1) is effective in controlling such loads as fans and pumps.

=> Refer to 5.10

5.3 Selecting an operation mode

CNOd : Operation command mode selection

FNOd : Speed setting mode selection

• Function

These parameters are to select the operation command from among the operating panel, the terminal board, a communication device and other optional control devices, to which priority should be given when start, stop or frequency reference are issued by them.

[Parameter setting]

Title	Function	Adjustment range	Default setting
<i>CNOd</i>	Operation command mode selection	<ul style="list-style-type: none"> 0: Terminal block enabled 1: Operating panel enabled 2: Common serial communication option enabled 3: Serial communication RS485 enabled 4: Communication add-on cassette option enabled 	0

[Set value]

0: Terminal operation

Start and stop control is exercised by means of external signals.

1: Operation panel

Start and stop control is exercised by pressing the **(RUN)** or **(STOP)** key on the control panel.

(Including start and stop control from an extended panel (optional))

2: Communication common serial optional

Start and stop control is exercised from an RS232C device (optional) and a RS485 (optional).

3: RS485 communication(standard)

Start and stop control is exercised from RS485 communication device fitted as standard.

4: Communication option

Start and stop control is exercised from add-on module communication option.

[Parameter setting]

Title	Function	Adjustment range	Default setting
<i>FNOd</i>	Speed setting mode selection	<ul style="list-style-type: none"> 1: VI (voltage input)/II (current input) 2: RR (voltage/voltage input) 3: RX (voltage input) 4: RX2 (voltage input) (optional) 5: Operating panel input 6: Binary/BCD input(optional) 7: Common serial communication option(FA01) 8: Serial communication RS485(FA05) 9: Communication add-on cassette option(FA07) 10: Up-down frequency 11: Pulse input #1 (optional) 	2

[Set value]

1: VI/II input

Speed commands are entered by means of external signals (terminal VI: 0 to 10 Vdc or terminal II: 4 to 20 mAdc).

2: RR input

Speeds commands are entered by means of external signals (terminal RR: 0 to 10Vdc).

3: RX input

Speed commands are entered by means of external signals (terminal RX: 0 to +/-10 Vdc (+/-5 Vdc).

4: RX2 control

Speed commands are entered by means of external signals (terminal RX2 (optional): 0 to +/-10 Vdc (+/-5 Vdc)).

5: Operating panel input enabled

Frequencies are set by pressing the  key on the control panel or an extended control panel (optional).

6: Binary/BCD input

Speed commands are entered from 12/16-bit binary input(optional) or a BCD (optional).

7: Communication common serial option

Speed commands are entered from an RS232C device (optional) or terminal board-equipped RS485 device (optional). Communication number: FA01

8: Communication RS485

Speed commands are entered from the RS485 communication device fitted as standard. Communication number: FA00

9: Communication add-on module option

Speed commands are entered from the network communication device TOSLINE-F10M or S20 (optional).

10: Up-down frequency

Speed commands are entered by means of up-down frequency signals from the terminal board (refer to 7.2).

11: Pulse input

Speed commands are entered by means of pulses (optional).

The following communication devices are optionally available.

- RS232C (Type: RS2001Z)
- RS485 (Type: RS4001Z. Up to 64 units can be connected.)
- TOSLINE-F10M/TOSLINE-S20
- Device Net (On the drawing board)
- Profi Bus (On the drawing board)

The functions assigned to the following control terminals (contact input: Refer to 7.2.) are always activated regardless of the settings of the control device selection parameter $CnCd$ and the speed command selection parameter $FnCd$.

- Reset terminal (assigned to RES by default, enabled only when the inverter trips)
- Standby terminal (assigned to ST by default)
- Emergency stop terminal

Be sure to put the inverter out of operation before changing the control device selection parameter $CnCd$ or the speed command selection parameter $FnCd$, though no change can be made to them if the inverter is in operation.

Preset speed operation

$CnCd$: Set this parameter at \square (terminal board).

$FnCd$: Any setting is valid.

1) Setting the start, stop and operation frequencies with the operating panel

Title	Function	Set value
<i>ENOd</i>	Operation command Mode selection	1 (operating panel)
<i>FN0d</i>	Speed setting mode selection	5 (operating panel)

[Start/stop]: Press the **RUN** **STOP** key on the control panel.

To switch between forward run and reverse run, use the forward/reverse run selection parameter *FR*.

[Frequency ref.]: Set the frequency, using the

 key on the operating panel.

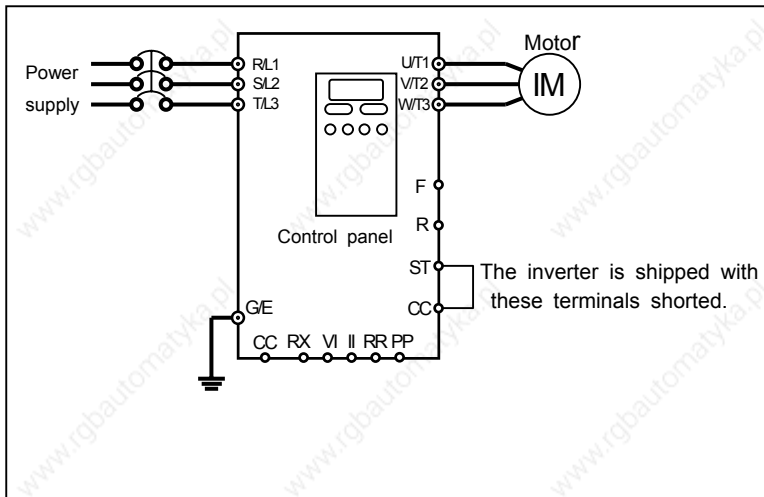

To save the frequency, press the Enter key. Then, *F* and the set frequency are displayed alternately for a while.

2) To set the start and stop frequencies (forward run, reverse run and free-run stop) by means of external signals and to set the operation frequency with the control panel

Title	Function	Set value
<i>ENOd</i>	Operation command Mode selection	0 (Terminal input)
<i>FN0d</i>	Speed setting mode selection	5 (operating panel)

[Start/stop]: Connection and disconnection of terminals F-CC/R-CC (Standby: connection of terminals ST and CC)

[Speed command]: Set the frequency, using the

 key on the control panel.

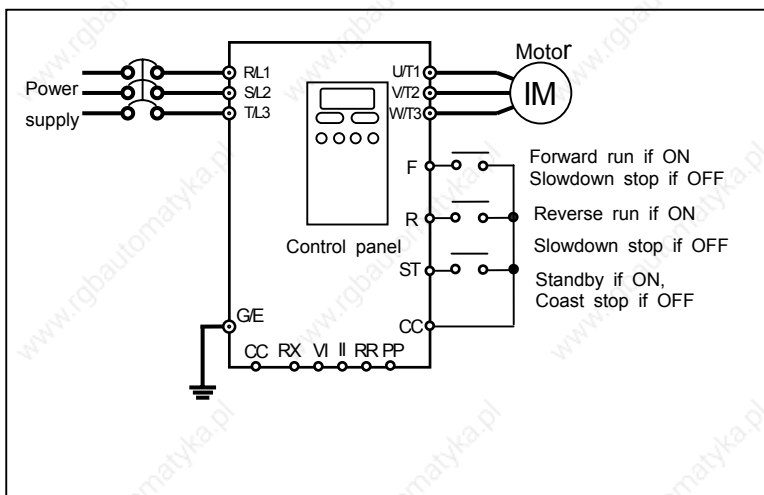

As for the action the motor takes when both the terminals F and R are connected at the same time, you can make selection between reverse run and a stop. => Refer to 6.2.2.

To save the frequency, press the Enter key. Then, *F* and the set frequency are displayed alternately for a while.

3) Start and stop (forward run, reverse run, free-run stop) with the operating panel and to set the operation frequency by external signals

Title	Function	Set value
<i>CNOd</i>	Operation command mode selection	1(operating panel)
<i>FNOd</i>	Speed setting mode selection	1(VI/II) 2(RR) 3(RX)
<i>F721</i>	Panel stop pattern	1(Coast stop)

[Start/stop]: Press the **RUN** **STOP** key on the operating panel.

To switch between forward run and reverse run, use the forward/reverse run selection *F_r*.

[Speed command]: By means of external signals

- (1) VI: 0 to +10 Vdc (0 to +5 Vdc) II: 4 to 20 mAdc
- (2) RR: Volume / 0 to +10 Vdc (0 to +5 Vdc)
- (3) RX: 0 to +/-10 Vdc (0 to +/-5 Vdc)

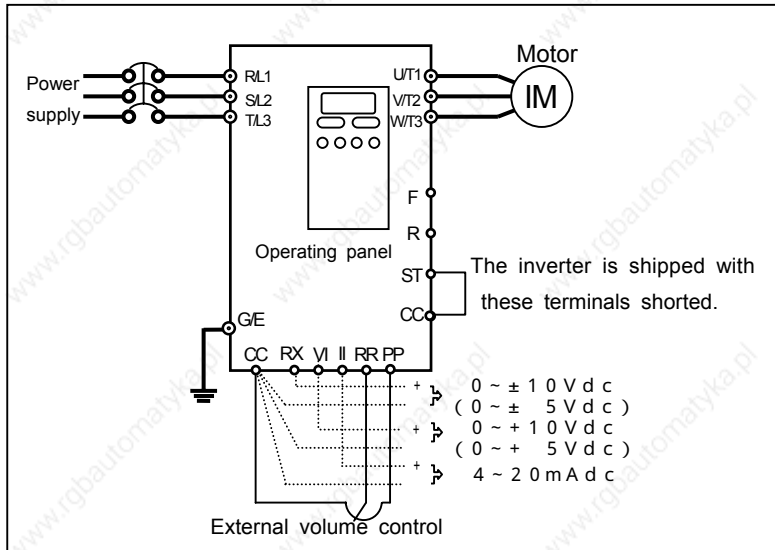

- Other speed setting
 - 4: RX2 (voltage input) (optional)*
 - 5: 12/16-bit binary input (optional)*
 - 7: Serial communication (optional)*
 - 8: Serial communication RS485
 - 9: Communication add-on(optional)*
 - 10: Up-down frequency
 - 11: Pulse input (optional)*
- * For the setting to be made when using an asterisked optional device as an input device, refer to the instruction manual for the input device used.

4) Start and stop (forward run, reverse run, free-run stop) and to set the operation frequency by means of external signals

Title	Function	Set value
<i>CNOd</i>	Operation command mode selection	1(Terminal input)
<i>FNOd</i>	Speed setting mode selection	1(VI/II) 2(RR) 3(RX)

[Start/stop]: Connection and disconnection of terminals F and CC/terminals R and CC.

[Speed command]: By means of external signals

- (1) VI: 0 to +10Vdc (0 to +5Vdc)/II: 4 to 20mAdc
- (2) RR: Volume/0 to +10 Vdc (0 to +5Vdc)
- (3) RX: 0 to +/-10 Vdc (0 to +/-5Vdc)

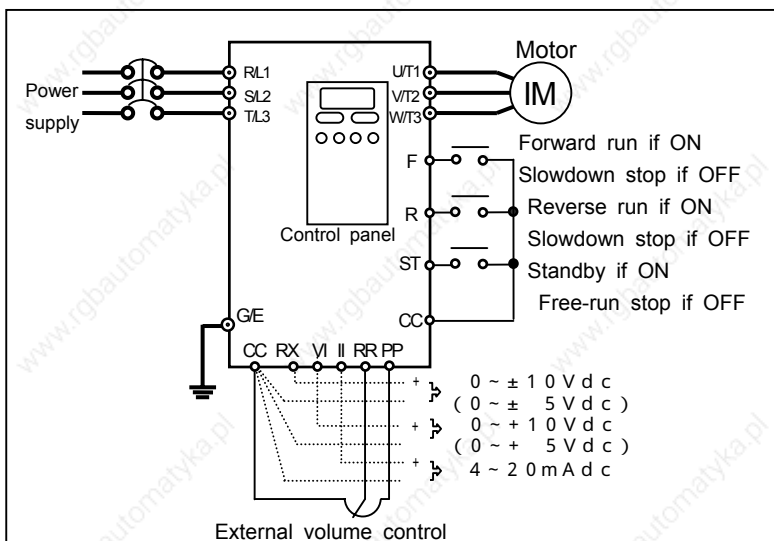

As for the action the motor takes when both the terminals F and R are connected at the same time, you can make a selection between reverse run and a stop. => Refer to 6.2.2

- Other speed setting
 - 4: RX2 (voltage input) (optional)*
 - 5: 12/16-bit binary input (optional)*
 - 7: Serial communication (optional)*
 - 8: Serial communication RS485
 - 9: Communication add-on(optional)*
 - 10: Up-down frequency
 - 11: Pulse input (optional)*
- * For the setting to be made when using an asterisked optional device as an input device, refer to the instruction manual for the input device used.

5.4 Setting and calibrating meters

F \overline{N} 5L : FM Terminal meter selection

F \overline{N} : FM Terminal meter adjustment

F $\overline{6}$ 70 : AM Terminal meter selection

F $\overline{6}$ 71 : AM Terminal meter adjustment

• Function

The terminals AM and FM send out analog voltage signals. (Absolute value output)
Use a full-scale 0~1 mAdc ammeter or a full-scale 0~7.5 Vdc (10 Vdc) voltmeter.

To calibrate the meter connected to the terminal FM or AM, use the FM Terminal meter adjustment **F \overline{N}** or the AM Terminal meter adjustment **F $\overline{6}$ 71** respectively.

Connect meters as shown below.

< Connection to terminal FM >

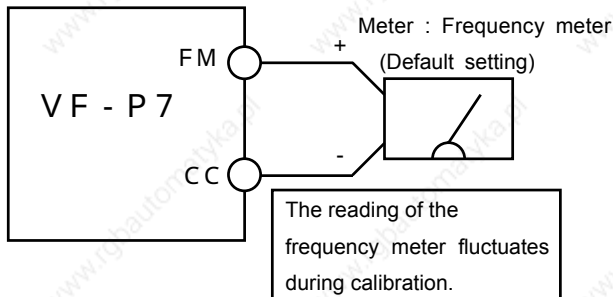

< Connection to terminal AM >

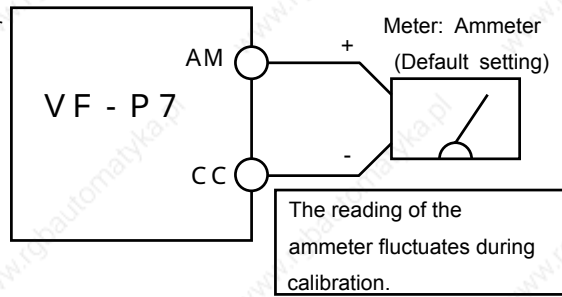

An frequency meter QS60T is optionally available.

Use an ammeter capable of measuring up to a current 1.5 times larger than the rated current of the inverter.

[Terminal FM-related parameters]

Title	Function	Adjustment range	Adjustment level	Default setting
F\overline{N}5L	FM Terminal meter selection	0: Running frequency	(a)	0
		1: Frequency command	(a)	
		2: Current	(b)	
		3: DC voltage	(b)	
		4: Output voltage	(b)	
		5: After-compensation frequency	(a)	
		6: Speed feedback (real-time value)	(a)	
		7: Speed feedback (1 second filter)	(a)	
		8: Torque	(b)	
		9: Torque reference	(b)	
		10: Internal torque reference	(b)	
		11: Torque current	(b)	
		12: Exciting current	(b)	
		13: PID feedback value	(a)	
		14: Motor overload factor (OL2 data)	(c)	
		15: Inverter overload factor (OL1 data)	(c)	
		16: PBr overload factor (PBrOL data)	(c)	
		17: PBr load factor (pulse duty)	(c)	
		18: Input power	(e)	
		19: Output power	(e)	
		20: Peak output current	(b)	
		21: Peak DC voltage	(b)	
		22: Motor counter dummy PG	(d)	
		23: Position pulse	(d)	
		24: RR input	(c)	
		25: VI/II input	(c)	
		26: RX input	(c)	
		27: RX2 input	(c)	
28: FM output	(c)			
29: AM output	(c)			
30: Fixed output for meters	-			
31: Analog output for communication	(c)			
32: Acc/dec torque removal	(b)			
F\overline{N}	FM Terminal meter adjustment	-	-	-

[Terminal AM-related parameters]

Title	Function	Adjustment range	Default setting
<i>F570</i>	AM Terminal meter selection	Same as <i>F75L</i> (29: disabled)	2
<i>F571</i>	AM Terminal meter adjustment	-	-

Resolution

Both the terminals FM and AM have a maximum resolution of 1/1024.

With the default settings, FM terminal outputs about 16 V (external impedance is infinity) or about 3mA (external impedance is 0 ohm), when running frequency is 80Hz. AM terminal outputs about 16 V or about 3mA, when the output current reading on the control panel is 150%

Calibrating a meter when the inverter is out of operation

If it is difficult to calibrate a meter because of large fluctuations of its reading, you may put the inverter out of operation to make its calibration easier.







It is possible to adjust the meter for the data item selected with the parameter *F75L* or *F570*. Refer to the table on the next page for the calibration procedure.

Adjustment level:

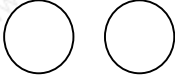
- (a): The output voltage FM/AM-CC reaches 100% at the maximum frequency (*FH*).
- (b): The output voltage at FM/AM-CC reaches 100% when the reading on the control panel is 150%.
- (c): The output voltage at FM/AM-CC reaches 100% when the reading on the control panel is 100%.
- (d): Special output (Refer to the instruction manual for the applicable device.)
- (e): The output voltage at FM/AM-CC reaches 100% when the electric power is $3 * 200V(400V) * (\text{inverter rated current})$.

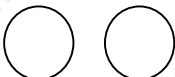



























[Example of the calibration of the frequency meter connected to the terminal FM-CC]

*Before proceeding to calibration, make the zero-adjustment of the meter itself.

Key operated,	LED display	Operation
-	50.0	The running frequency is displayed. (If the monitor display mode setting <i>F710</i> is set at 0 [Running frequency])
	<i>AV1</i>	Press the MON key to call up the first basic parameter <i>AV1</i> (automatic acceleration/deceleration).
	<i>F7</i>	Select <i>F7</i> by pressing the or key.
	50.0	Press the Enter key to display the running frequency.
	50.0	Adjust the meter by pressing the or key. Note that the meter reading varies during adjustment, though the reading in the digital LED (monitor) on the control panel does not change.  By setup, before the needle of meter begins to sway, it will take time.
	50.0 <i>F7</i>	Press the Enter key to terminate the meter calibration. Then, <i>F7</i> and the running frequency are displayed alternately.
	50.0	Press the Monitor key to return to the running frequency display mode. (If the monitor display mode setting parameter <i>F710</i> is set at 0 [Running frequency])

For meter connection, the VF-P7 inverter has two output terminals; FM and AM, which can be used simultaneously.

[Example: Procedure of calibrating the meter connected to the terminal AM to which "output current" is assigned.]

Key operated,	LED display	Operation
-	0.0	The running frequency is displayed. (If the monitor display mode setting parameter $F710$ is set at 0. [Running frequency])
	AU1	Press the MON key to call up the first basic parameter AU1 (automatic acceleration/deceleration).
 	F6--	Select F6-- by pressing the  or  key.
	F600	Press the Enter key to display the parameter F600.
 	F670	Select the terminal AM terminal meter selection parameter F670 by pressing  key.
	2	Press the Enter key to display the parameter setting (set value).
	30	Set the parameter at 30 (fixed output for meter calibration) by pressing the  key.
	30 F670	Press the Enter key to save the change. Then, F670 and the set value are displayed alternately.
	F671	Select the AM terminal meter adjustment F671 by pressing  key.
	100	Press the Enter key to switch to the data display mode.
 	100	<p>Calibrate the meter by pressing the  or  key. Adjust the pointer to the graduation to which you want it to point when the inverter passes a current 150% larger than its rated output current.</p> <p>(Note that the meter reading varies during adjustment, though the reading in the digital LED (monitor) on the control panel does not change.)</p> <div style="display: flex; align-items: center;">  <div style="border: 1px solid black; padding: 5px; font-size: small;"> <p>[Point] Holding down the key for several seconds facilitates this adjustment.</p> </div> </div> <p>By setup, before the needle of meter begins to sway, it will take time.</p>
	100 F671	Press the Enter key to save the setting. Then, F671 and the set value are displayed alternately.
	F670	Select the terminal AM terminal meter selection parameter F670 by pressing  key.
	30	Press the Enter key to display the parameter setting.
	2	Return the parameter setting to 2 (output current display).
	F670 2	Press the Enter key to save the change. Then, F670 and the newly-set value are displayed alternately.
	0.0	Press the Monitor key three times to return to the running frequency display mode. (If the monitor display mode setting parameter $F710$ is set at 0 [Running frequency])

5.5 Factory default setting

Ⓔ 4P : Standard setting mode selection

• **Function**

This parameter is to set two or more parameters at a time for different commands. Using this parameter, all parameters can be also return to their respective default settings by one operation, and save or set specific parameters individually.

Title	Function	Adjustment range	Default setting
Ⓔ 4P	Standard setting mode selection	0 : - 1 : 50Hz standard setting 2 : 60Hz standard setting 3 : Factory default setting 4 : Trip clear 5 : Clearing accumulating operation time 6 : Initialization of type form information 7 : Memorization of user-defined parameters 8 : Reset of user-defined parameters	0

This parameter is used to change the settings of other parameters. Therefore, 0 is always displayed.

This parameter cannot be used when the inverter is in operation. So, put the inverter out of operation before using this parameter.

You can check the previous settings by selecting **Ⓔ 4P** last set data in status monitor mode. (Refer to 8.1 for details.)

[Set value]

[50 Hz standard setting (Ⓔ 4P = 1)]

Setting **Ⓔ 4P** at **1** causes all the following parameters to be set for operation using a base frequency of 50Hz.(This does not change the settings of any other parameters.)

- Maximum frequency **FH**: 50Hz
- Base frequency #1 **uL**: 50Hz
- Base frequency #2 **F170**: 50Hz
- Base frequency #3 **F174**: 50Hz
- Base frequency #4 **F178**: 50Hz
- Upper limit frequency **UL**: 50Hz
- Forward speed limit input level **F426**: 50Hz
- Reverse speed limit input level **F428**: 50Hz
- Automatic light-load high-speed operation frequency **F341**: 50Hz
- Commercial power/inverter switching frequency **F355**: 50Hz
- VI/II reference point #2 frequency **F204**: 50Hz
- RR reference point #2 frequency **F213**: 50Hz
- RX reference point #2 frequency **F219**: 50Hz
- RX2 reference point #2 frequency **F225**: 50Hz
- BIN reference point #2 frequency **F231**: 50Hz
- Pulse reference point #2 frequency **F237**: 50Hz
- Point #2 frequency **F814**: 50Hz

[60 Hz standard setting (Ⓔ 4P = 2)]

Setting **Ⓔ 4P** at **2** causes all the following parameters to be set for operation using a base frequency of 60Hz.(This does not change the settings of any other parameters.)

- Maximum frequency **FH**: 60Hz
- Base frequency #1 **uL**: 60Hz
- Base frequency #2 **F170**: 60Hz
- Base frequency #3 **F174**: 60Hz
- Base frequency #4 **F178**: 60Hz
- Upper limit frequency **UL**: 60Hz
- Forward speed limit input level **F426**: 60Hz
- Reverse speed limit input level **F428**: 60Hz
- Automatic light-load high-speed operation frequency **F341**: 60Hz
- Commercial power/inverter switching frequency **F355**: 60Hz
- VI/II reference point #2 frequency **F204**: 60Hz
- RR reference point #2 frequency **F213**: 60Hz
- RX reference point #2 frequency **F219**: 60Hz
- RX2 reference point #2 frequency **F225**: 60Hz
- BIN reference point #2 frequency **F231**: 60Hz
- Pulse reference point #2 frequency **F237**: 60Hz
- Point #2 frequency **F814**: 60Hz

[Factory default setting ($tYP = 3$)]

Setting tYP at 3 returns all parameters to their respective default settings.

When this parameter is set at 3, In It is displayed for a while, then switches back to the original display (OFF or 0.0). Note that this setting also clears all trouble history records.

[Trip clear ($tYP = 4$)]

Setting tYP at 4 clears the oldest 4 trip history records.

(This setting does not change any parameter settings.)

[Clearing accumulating operation time ($tYP = 5$)]

Setting tYP at 5 clears the cumulative operation time (resets it to zero).

[Initialization of type form information ($tYP = 6$)]

When a trip occurs because of a type error ($E tYP$ is displayed), you can clear the trip by setting tYP at 6. This function is used to reformat a control circuit board to adapt it to an inverter, for example, when a circuit board is removed from an inverter to use for another inverter for maintenance or for other reasons. This setting clears all type data stored in the inverter.

[Memorization of user-defined parameters ($tYP = 7$)]

Setting tYP at 7 causes all the current parameter settings to be stored individually.

[Reset of user-defined parameters ($tYP = 8$)]

Setting tYP at 8 returns all parameters to the settings saved by setting this parameter at 7.

The above settings 7 and 8 allows you to have your own default parameter settings.

5.6 Forward/reverse run selection (for the panel control only)

F_r : Forward/reverse selection

• Function

This parameter is used to set the direction of a motor when it is started or stopped by pressing the Run key or Stop key on the control panel. This parameter is valid only when the operation command mode selection parameter CND is set at 1 (control panel input enabled).

Parameter setting

Title	Function	Adjustment range	Default setting
F_r	Forward/reverse selection	0: Forward run 1: Reverse run	0

The direction of rotation can be checked in status monitor mode.

$F_r - 0$: Forward run, $F_r - 1$: Reverse run => Refer to 8.1

When the terminal board is used for operation, the direction of rotation is switched with the terminal F,R. Consequently, the forward/reverse run selection parameter becomes invalid.

F-CC connected: Forward run

R-CC connected: Reverse run

If F and CC, as well as R and CC are connected at the same time: Reverse run (Default setting)

Use the parameter $F105$ to change the direction of rotation in this case.

=> Refer to 6.2.2 for details.

This parameter is valid only when CND is set at 1 (Operating panel enabled.)

5.7 Maximum frequency

FH : Maximum frequency

• Function

- 1) This parameter is used to set the range of frequencies (the maximum frequency) that the inverter can output.)
- 2) The frequency is used as the reference for setting the acceleration and deceleration times.

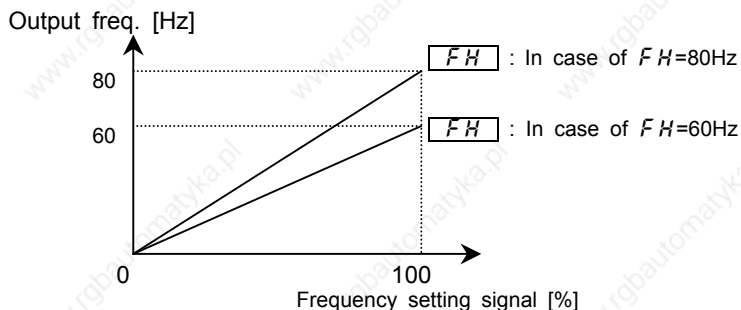

- Set the maximum frequency according to the rating of the motor.
- The maximum frequency cannot be adjusted during operation. So, put the inverter out of operation when making this setting.

When increasing the FH , adjust the upper limit frequency parameter UL as well, if necessary.

[Parameter setting]

Title	Function	Adjustment range	Default setting
FH	Maximum frequency	30.0 ~ 400 [Hz]	80.0

5.8 Upper and lower limit frequencies

UL : Upper limit frequency

LL : Lower limit frequency

• **Function**

These parameters are used to set the upper and lower limit frequencies which are the largest and smallest frequencies, respectively, that the inverter can output.

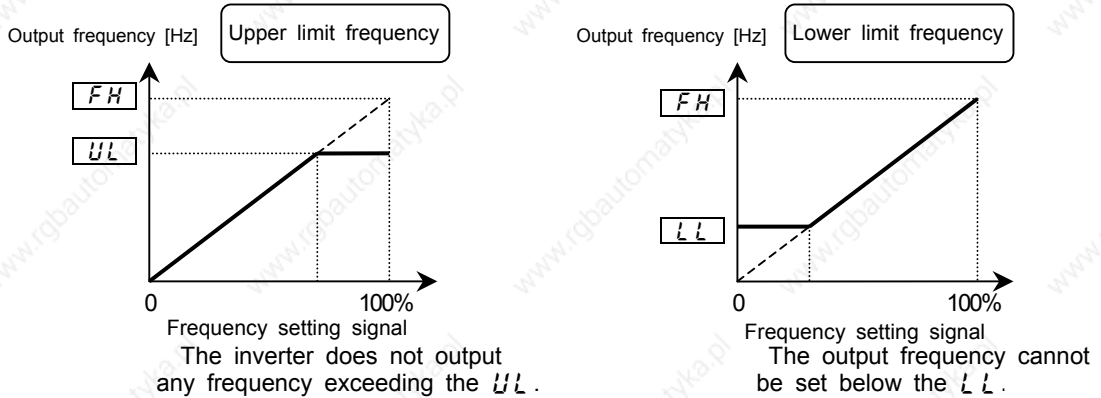

Parameter setting

Title	Function	Adjustment range	Default setting
UL	Upper limit frequency	LL ~ FH	80.0
LL	Lower limit frequency	0.0 ~ UL	0.0

5.9 Base frequency

ωL : Base frequency #1

• **Function**

This parameter is used to set the base frequency according to the rated frequency of the motor or the specification of the load.

Note) This is an important parameter required for setting the constant torque control area.

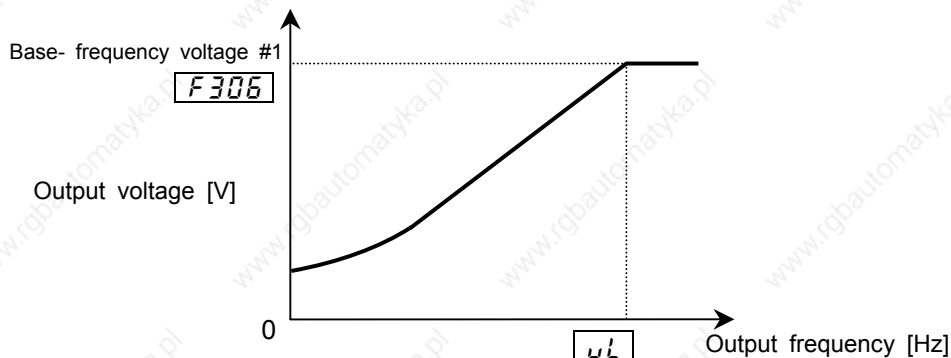

Title	Function	Adjustment range	Default setting
ωL	Base frequency #1	25 ~ 400 [Hz]	60

5.10 Control mode selection

P₇ : Motor control mode selection

• Function

The VF-P7 has the following V/f control modes:

- Constant torque characteristic
- Variable torque mode
- Automatic torque boost *1
- Sensorless vector control (speed) *1
- Automatic torque boost + automatic energy-saving
- Sensorless vector control + automatic energy-saving *1
- V/f 5-point setting
- Sensorless vector control (torque/speed switching)
- PG feedback vector control (torque/speed switching)
- PG feedback vector control (torque/position switching)

(*1) The automatic control parameter automatically sets this parameter and the auto-tuning parameter at a time.

Parameter setting

Title	Function	Adjustment range	Default setting
P ₇	Motor control mode selection	0: Constant torque characteristic 1: Square reduction torque characteristic 2: Automatic torque boost 3: Sensorless vector control (speed) 4: Automatic torque boost + automatic energy-saving 5: Sensorless vector control (speed) + automatic energy-saving 6: V-f 5-points setting 7: Sensorless vector control (torque/speed switching) 8: PG feedback vector control (speed/torque switching) 9: PG feedback vector control (speed/position switching)	0

1) Constant torque characteristic (Normal way of use)

[Set the motor control mode selection P₇ at 0 (Constant torque characteristic)]

Usually, this control mode is used for loads, such as belt conveyers and cranes, that require the same torque as that produced at the rated speed, even at low speeds.

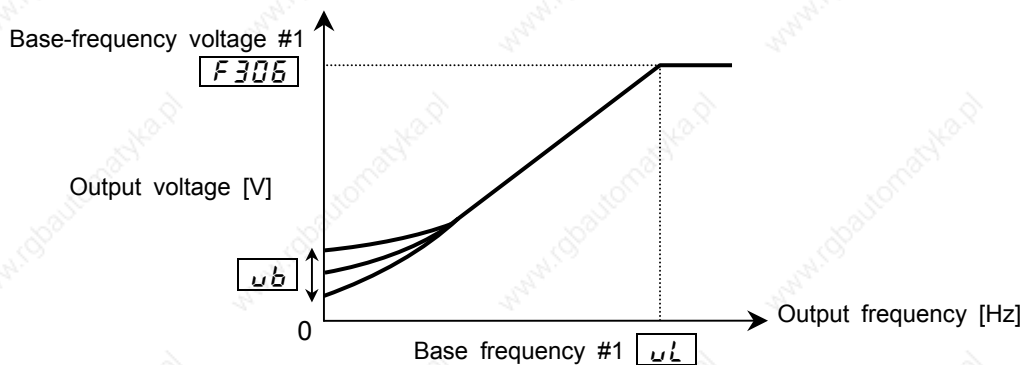

To further increase the torque, use the manual torque boost parameter ω_b.
 => Refer to 5.1.2 for details.

2) Setting suitable for fans and pumps

[Set the motor control mode selection $P\bar{L}$ at 1 (Variable torque mode).]

This control mode is used for such loads as fans, pumps and blowers, with the characteristic that the torque is proportional to the square of the rotating speed of the load.

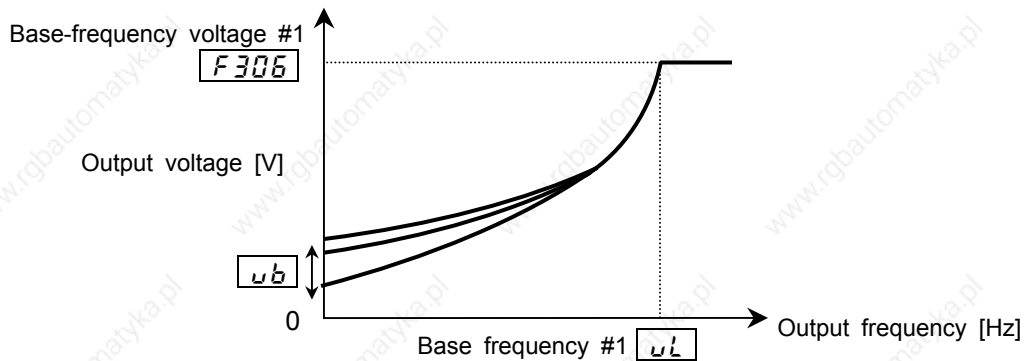

3) To increase the starting torque

[Set the V/F control selection parameter $P\bar{L}$ at 2 (Automatic torque boost).]

In this mode, the load current is monitored in all speed ranges and the inverter's output voltage is adjusted automatically so that the motor can always produce torque large enough for stable operation.

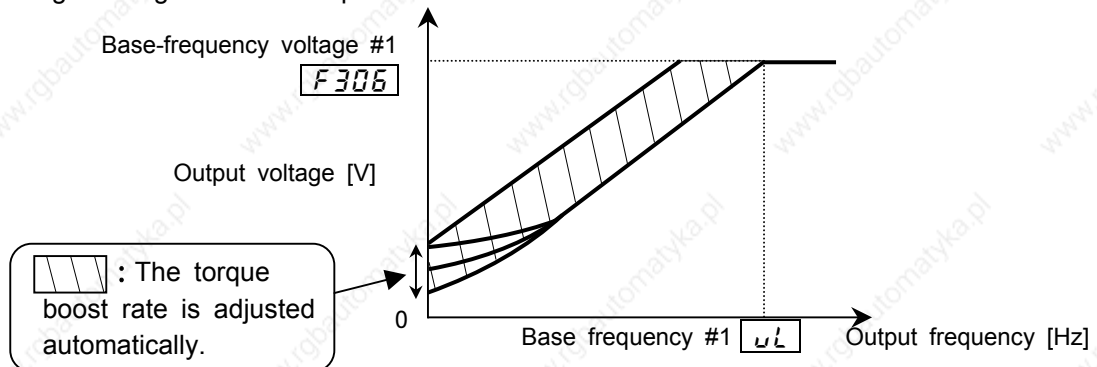

Note) Some loads produce vibration if operated in this control mode. For such a load, set the motor control mode selection parameter $P\bar{L}$ at 0 (V/f constant control) and manually set the torque boost rate.

This control mode involves the setting of the motor constant.

Basically, however, there is no need to set the motor constant if the inverter is used for a Toshiba 4P motor with the same capacity as the inverter.

The motor constant can be set in any of the following three ways:

- 1) Set the basic parameter $R\bar{U}\bar{2}$ at 1 . With this parameter, you can make the setting of both the automatic torque boost and the motor constant (auto-tuning) at a time. => Refer to 5.2.1) for details.
- 2) Set the extended parameter $F\bar{4}\bar{0}\bar{0}$ at 2 . In this mode, the motor constant is set automatically. (Auto-tuning) => Refer to selection 2 in 6.20 for details.)
- 3) The constants of motors can also be set individually. => Refer to selection 3 in 6.20 for details.

4) To increase starting torque and the accuracy of operation - Vector control

[Set the V/f control selection parameter P_7 at 3 (Sensorless vector control).]

In vector control mode, the VF-P7 inverter enables the Toshiba standard motor combined with it to produce large torque even at extremely low speeds. The vector control mode is effective in:

- (1) Obtaining large torque
- (2) Achieving smooth and stable operation even in low speed ranges
- (3) Eliminating load fluctuations due to slippage of the motor
- (4) Making the motor produce large starting torque.

This control mode involves the setting of the motor constant.

Basically, however, there is no need to set the motor constant if the inverter is used for a Toshiba 4P motor with the same capacity as the inverter. The motor constant can be set in any of the following three ways:

- 1) Set the basic parameter RU_2 at 2. With this parameter, you can make the setting of both the sensorless vector control and the motor constant (auto-tuning) at a time.
=> Refer to 5.2.2) for details.
- 2) Set the extended parameter $F400$ at 2. In this mode, the motor constant is set automatically. (Auto-tuning) => Refer to selection 2 in 6.20 for details.
- 3) The constants of motors can also be set individually. => Refer to selection 3 in 6.20 for details.

[Procedure for setting the V/f control selection parameter P_7 at 3 (Sensorless vector control)]

key operated,	LED display	Operation
	0.0	The running frequency is displayed. (Make this setting when the motor is out of operation.) (If the monitor display selection parameter $F710$ is set at 0 [Running frequency])
(MON)	RU_1	Press the MON key to call up the first basic parameter RU_1 (Automatic acceleration/deceleration).
()	P_7	Switch to the parameter P_7 (Motor control mode selection) by pressing key.
(ENT)	0	Press the Enter key to display the parameter setting (set value). (Default setting: 0 (Constant torque))
()	3	Change the parameter setting to 3 (Sensorless vector control) by pressing the key.
(ENT)	3 P_7	Press the Enter key to save the change. Then, P_7 and the set value 3 are displayed alternately.

5) To increase the starting torque while saving energy

[Set the motor control mode selection parameter P_7 at 4 (Automatic torque boost + automatic energy-saving).]

In this mode, the load current is monitored in all speed ranges and the inverter's output voltage (torque boost) is adjusted automatically so that the motor can always produce torque large enough for stable operation. In addition, the output current is optimally adjusted for energy saving according to the load applied.

This control mode involves the setting of the motor constant.

Basically, however, there is no need to set the motor constant if the inverter is used for a Toshiba 4P motor with the same capacity as the inverter.

The motor constant can be set in any of the following two ways:

- 1) Set the extended parameter $F400$ at 2. In this mode, the motor constant is set automatically. (Auto-tuning) => Refer to selection 2 in 6.20 for details.
- 2) The constants of motors can also be set individually.
=> Refer to selection 3 in 6.20 for details.

6) To increase starting torque and the accuracy while saving energy

[Set the motor control mode selection parameter $P\bar{L}$ at 5 (Sensor-less vector control + automatic energy-saving).]

In vector control mode, the VF-P7 inverter enables the Toshiba standard motor combined with it to produce large torque even at extremely low speeds. In addition, the output current is optimally adjusted for energy saving according to the load applied.

This function is effective in:

- (1) Obtaining large torque,
- (2) Achieving smooth and stable operation even in low speed ranges
- (3) Eliminating load fluctuations due to slippage of the motor, and
- (4) Making the motor produce large starting torque.

This control mode involves the setting of the motor constant.

Basically, however, there is no need to set the motor constant if the inverter is used for a Toshiba 4P motor with the same capacity as the inverter.

The motor constant can be set in any of the following three ways:

- 1) Set the basic parameter $R\bar{U}\bar{2}$ at 3 . In this mode, you can make the setting of both the automatic energy-saving and the motor constant (auto-tuning) at a time.
=> Refer to 5.2.3) for details.
- 2) Set the extended parameter $F\bar{4}\bar{0}\bar{0}$ at 2 . In this mode, the motor constant is set automatically. (Auto-tuning) => Refer to selection 2 in 6.20 for details.)
- 3) The constants of motors can also be set individually.
=> Refer to selection 3 in 6.20 for details.

7) To set the V/f characteristic arbitrarily

[Set the V/f control selection parameter $P\bar{L}$ at 5 (V/f 5-points setting).]

In this mode, the base frequency and the base-frequency voltage for the V/f control need to be set to operate the motor while switching a maximum of 5 different V/f characteristics.

[Parameter setting]

Title	Function	Adjustment range	Default setting
$F\bar{1}\bar{9}\bar{0}$	V/f 5-point setting V/F1 frequency	$0.0 \sim U\bar{L}$ [Hz]	0
$F\bar{1}\bar{9}\bar{1}$	V/f 5-point setting V/F1 voltage	$0 \sim 100$ [%]	0.0
$F\bar{1}\bar{9}\bar{2}$	V/f 5-point setting V/F2 frequency	$0.0 \sim U\bar{L}$ [Hz]	0
$F\bar{1}\bar{9}\bar{3}$	V/f 5-point setting V/F2 voltage	$0 \sim 100$ [%]	0.0
$F\bar{1}\bar{9}\bar{4}$	V/f 5-point setting V/F3 frequency	$0.0 \sim U\bar{L}$ [Hz]	0
$F\bar{1}\bar{9}\bar{5}$	V/f 5-point setting V/F3 voltage	$0 \sim 100$ [%]	0.0
$F\bar{1}\bar{9}\bar{6}$	V/f 5-point setting V/F4 frequency	$0.0 \sim U\bar{L}$ [Hz]	0
$F\bar{1}\bar{9}\bar{7}$	V/f 5-point setting V/F4 voltage	$0 \sim 100$ [%]	0.0
$F\bar{1}\bar{9}\bar{8}$	V/f 5-point setting V/F5 frequency	$0.0 \sim U\bar{L}$ [Hz]	0
$F\bar{1}\bar{9}\bar{9}$	V/f 5-point setting V/F5 voltage	$0 \sim 100$ [%]	0.0

100% adjustment value (200V class: 200V, 400V class: 400V)

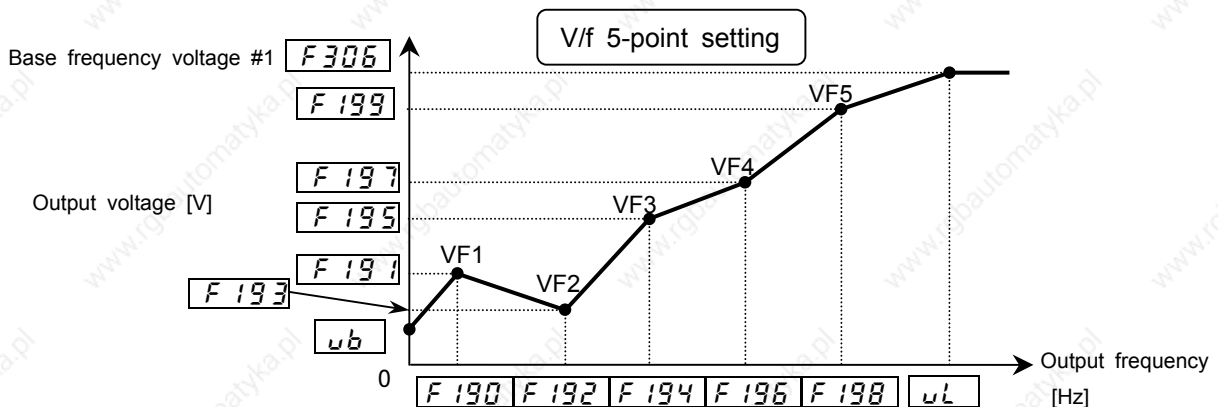

Note) Do not set the manual torque boost ($u\bar{b}$) above 5%. Boosting the torque too much may impair the linearity between points.

8) To control the torque

**[Set the V/f control selection parameter P_{τ} at 7
(sensorless vector control (speed/torque switchable).]**

In this mode, the torque produced by the motor is controlled by means of torque command signals. The rotating speed of the motor is determined by the relationship between the load torque and the torque produced by the motor.

This control mode involves the setting of the motor constant.

Basically, however, there is no need to set the motor constant if the inverter is used for a Toshiba 4P motor with the same capacity as the inverter.

The motor constant can be set in any of the following two ways:

- 1) Set the extended parameter $F400$ at 2. In this mode, the motor constant is set automatically. (Auto-tuning) => Refer to selection 2 in 6.21 for details.
- 2) The constants of motors can also be set individually.
=> Refer to selection 3 in 6.21 for details.

9) Notes on the vector control

- 1) The vector control fully exerts its effect in frequency ranges below the base frequency (f_b) and its effect is reduced in frequency ranges above the base frequency.
- 2) Set the base frequency between 40 and 120 Hz when selecting a sensorless vector control mode ($P_{\tau} = 2 \sim 5, 7$), or between 25 and 120 Hz when selecting a sensor vector control mode ($P_{\tau} = 8, 9$).
- 3) Use a general-purpose or squirrel-cage motor with the same rating as the inverter, or smaller by one rank.
- 4) Use a motor with 2 to 16 poles.
- 5) Use the inverter for a single motor at a time. This inverter is incapable of vector-controlling more than one motor simultaneously.
- 6) Do not use wires longer than 30 m for the connection between the inverter and the motor. When using wires longer than 30 m, select a normal auto-tuning mode to improve the low-speed torque characteristics in vector control mode. In this case, the torque produced by the motor decreases more or less around the rated frequency because of a voltage drop.
- 7) If a reactor or surge suppressing filter is connected between the inverter and the motor, the torque produced by the motor may decrease or the inverter may trip ($E_{\tau} r$) in auto-tuning mode, and therefore the vector control can not be used.
- 8) Connect speed sensor for vector control with sensor to the motor. Connecting via gear, etc. causes motor's oscillating or inverter's trip by lack of rigidity.

5.11 Switching between speed control and torque control

Pt : Motor control mode selection

$F111 \sim F118$: Input terminal selection #1 to #8
(One of these functions(terminals) is used.)

• Function

These parameters are used to switch between speed control and torque control by external operation (signal input to a terminal) or by communication.

Speed/torque switching

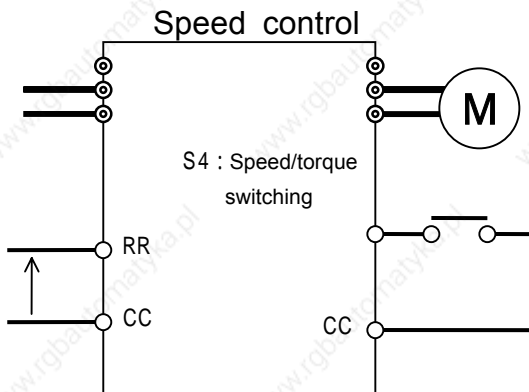

Control mode	Speed control ($Pt = 3, 5, 7, 8, 9$)
Speed/torque switching	S4-CC disconnected
Speed command	RR-CC (default setting)

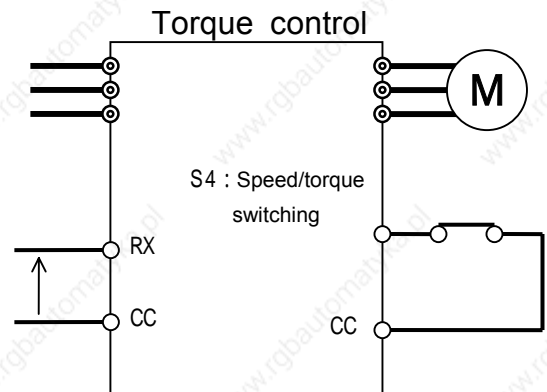

Control mode	Torque control ($Pt = 7, 8$)
Speed/torque switching	S4-CC connected
Torque Command	RX-CC (default setting)

1) Terminal function setting

The terminal S4 has been assigned to preset-speed 4 by default. Therefore, to use this terminal for switching of control modes, it is necessary to change this assignment.

Title	Function	Adjustment range	Setup value
$F118$	Input terminal selection #8 (S4)	0 ~ 135	112

Note 1) If the terminal S4 is already assigned to another function, use another terminal for this switching.

2) The ON/OFF logic can be reversed by setting this parameter at 113.

2) Selection of command value

[Speed setting]

The command set with the parameter Fnd is valid. (Default setting: RR input)

Title	Function	Adjustment range	Default setting
Fnd	Speed setting mode selection	1: VI (voltage input)/II (current input) 2: RR (voltage/voltage input) 3: RX (voltage input) 4: RX2 (voltage input) (optional) 5: Operating panel input 6: Binary/BCD input(optional) 7: Common serial communication option 8: Serial communication RS485 9: Communication add-on cassette option 10: Up-down frequency 11: Pulse input (optional)	2

[Torque reference]

The command set with the parameter $F420$ is valid. (Default setting: RX input)

Title	Function	Adjustment range	Default setting
$F420$	Torque reference selection	1: VI (voltage input)/II (current input) 2: RR (volume/voltage input) 3: RX (voltage input) 4: RX2 (voltage input) (optional) 5: Operating panel input 6: Binary/BCD input(optional) 7: Common serial communication option 8: Serial communication RS485 9: Communication add-on cassette optio n	3

5.12 Manual torque boost - Increasing the torque produced at low speeds

`ub` : Manual torque boost

• Function

When the torque produced in low speed ranges is not large enough, it can be boosted up by increasing the torque boost rate with this parameter.

Base-frequency voltage `F306`

Output voltage [V]

`ub`

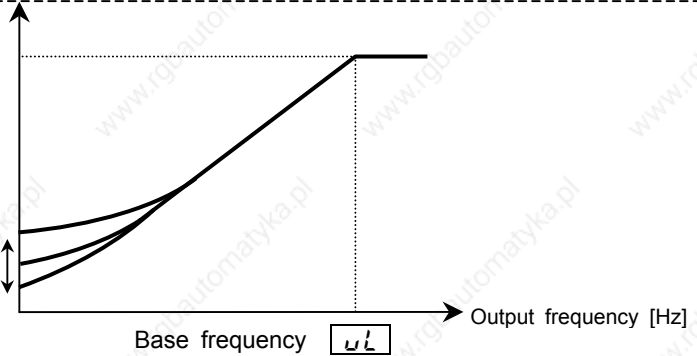

[Parameter]

Title	Function	Adjustment range	Default setting
<code>ub</code>	Manual boost	0 ~ 30 [%]	Model dependent

This parameter is valid when $Pf = 0$ (V/f constant), I (square reduction torque) or E (V/f 5-points setting).

Note 1) Torque boost rate has been set optimally according to the inverter capacity. Do not set the torque boost rate too high, or the inverter may trip during start-up because of an over-current. When needs to be changed, be careful not to increase more than +/-2% of the default value.

5.13 Setting the electronic thermal protective function

`OLn` : Selection of electronic thermal protection characteristics

`F600` : Motor overload protection level #1

`F606` : Overload reduction start-up frequency

`F607` : Motor 150%-overload time limit

• Function

These parameters are used to set the electronic thermal protective function according to the rating and characteristic of the motor to be controlled.

Parameter setting

Title	Function	Adjustment range				Default setting
		Setting	Kind of motor	Overload protection	Overload stall	
<code>OLn</code>	Selection of electronic thermal protection characteristics	0	Standard motor	protect	not stall	0
		1		protect	stall	
		2		not protect	not stall	
		3		not protect	stall	
		4	VF motor (special motor)	protect	not stall	
		5		protect	stall	
		6		not protect	not stall	
7	not protect	stall				
<code>F600</code>	Motor overload protection level #1	10 ~ 100 [%]				100

- 1) Setting the electronic thermal protection characteristics parameter \boxed{OLN} and the motor overload protection level #1 $\boxed{F600}$

The electronic thermal protection characteristics selection parameter OLN is used to enable or disable the motor overload trip function ($OL2$) and the soft stall function. The motor overload trip function ($OL2$) needs to be selected with the parameter OLN , while the inverter overload trip function (OLI) is always activated.

Explanation of terms

Overload stall(Soft stall):

The function of automatically lowering the output frequency before the motor overload trip function $OL2$ is activated when the inverter detects that an excessive load is applied to the motor. (Lowers maximum about 48Hz when base frequency is 60Hz.) This function enables the inverter to output a frequency commensurate with the load current so that the motor can keep running without tripping. This function is useful for such loads as fans, pump and blowers, which have the square reduction torque characteristic that the current passed decreases as the rotating speed falls.

Note) Do not use this overload stall function for loads with a constant torque characteristic (e.g., a belt conveyer to which a constant load current is always passed regardless of their speed).

[A general-purpose motor (other than motors intended for use with inverters)]

When a motor is operated in a frequency range below its rated frequency, its cooling efficiency drops. To prevent the motor to overheat because of this, the overload detecting point is advanced when the inverter is used for a general-purpose motor.

Setting the electronic thermal protective function OLN

Set value	Overload protection	Overload stall
0	protect	not stall
1	protect	stall
2	not protect	not stall
3	not protect	stall

Setting the motor overload protection level #1 $\boxed{F600}$

When the inverter is used for a motor with a capacity or a current rating smaller than that of the inverter, it is necessary to adjust the motor overload protection level #1 parameter $F600$ to the rated current of the motor.

Output current reduction rate [%]

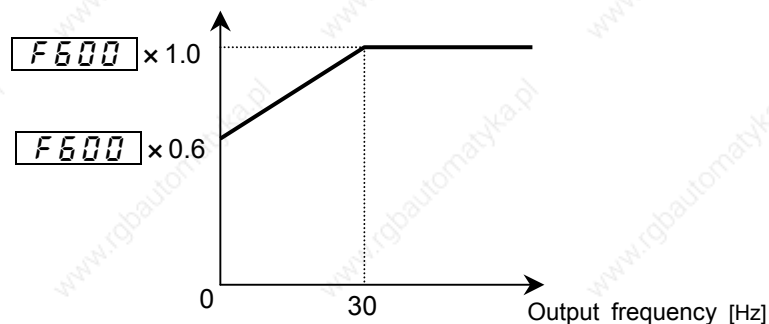

Note) The motor overload starting level is fixed at 30 Hz.
If necessary, set OLN at 4~7.
(See the next page for the setting procedure.)

[Example of setting: VF-P7 2220P with a 18.5 kW motor (rated current: 66A)]

Key operated	LED display	Operation
	0.0	The running frequency is displayed. (Make this setting when the motor is out of operation.) (If the monitor display mode setting parameter $F710$ is set at 0 [Running frequency])
(MON)	RU1	Press the MON key to call up the first basic parameter $RU1$ (automatic acceleration/deceleration).
○ ○	F6--	Switch to $F6--$ (extended parameters of from 600 to 699) by pressing the \leftarrow or \rightarrow key.
(ENT)	F600	Press the Enter key to call up the parameter $F600$ (electronic thermal motor protection level 1).
(ENT)	100	Press the Enter key to display the parameter setting (set value). (Default setting: 100 %)
○ ○	75	Change the parameter setting to 75 = (motor's rated current/inverter's rated output current) x 100 = $66.0/88.0 \times 100$
(ENT)	75 F600	Press the Enter key to save the change. Then, $F600$ and the set value are displayed alternately.

[VF motor (motor intended for use with an inverter)]

Setting the electronic thermal protective function OLN

Set value	Overload protection	Overload stall
4	protect	not stall
5	protect	stall
6	not protect	not stall
7	not protect	stall

VF motors (intended for use with an inverter) can be operated in lower frequency ranges than general-purpose motors. If a VF motor is operated in an extremely low frequency range, however, its cooling efficiency drops. In such a case, set the OL reduction start frequency parameter $F606$ according to the characteristics of the motor. (See the figure below.)

As a guide, it is advisable to set this parameter around the default value (VF motor 6Hz).

Title	Function	Adjustment range	Default setting
$F606$	Overload reduction start-up frequency	0.0 ~ 30.0 [Hz]	6.0

Note) $F606$ is enabled when OLN is set at 4, 5, 6, or 7.

Setting the motor overload protection level #1 $F600$

When the inverter is used for a motor with a capacity or a current rating smaller than that of the inverter, it is necessary to adjust the motor overload protection level #1 parameter $F600$ according to the rated current of the motor.

When the output current is displayed in %, 100% corresponds to the rated output current of the inverter.

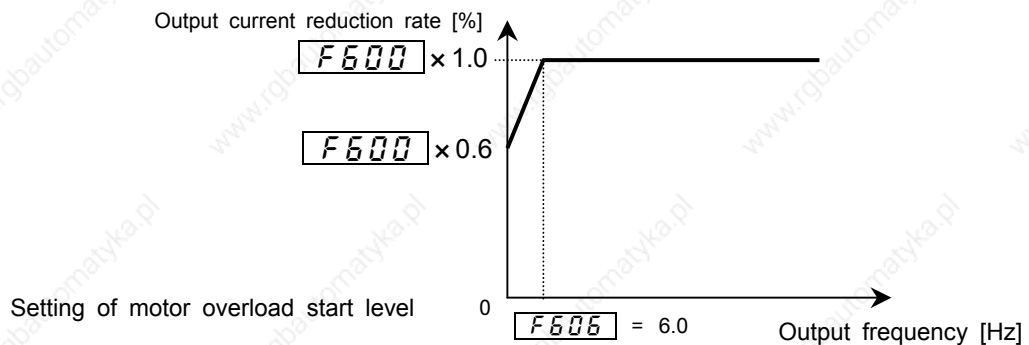

2) Motor 150%-overload time limit **F607**

The motor 150%-overload time limit parameter **F607** is used to set the time elapsed before the motor trips under a load of 150% (overload trip **OL2**) within a range of 10 to 2400 seconds.

[Example: setting of **F607**]

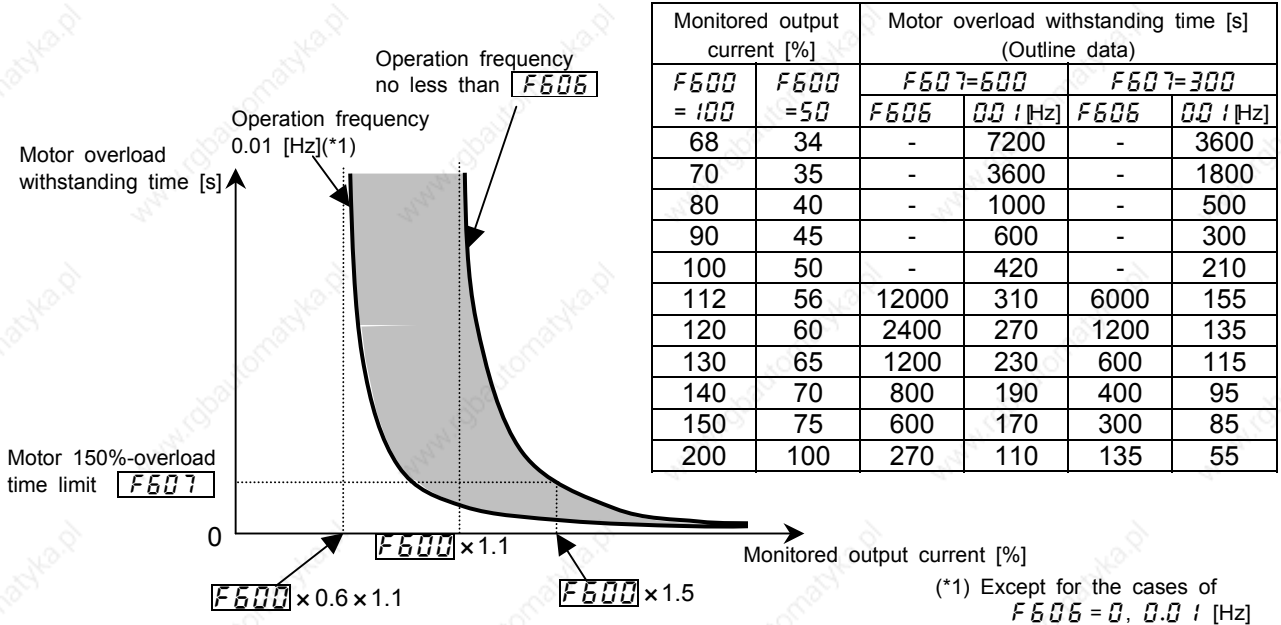

Title	Function	Adjustment range	Default setting
F607	Motor 150%-overload time limit	10 to 2400 [s]	600

3) Inverter overload characteristic

This function is provided to protect the inverter itself and it cannot be changed or disabled by changing any parameter setting.

If the inverter overload trip function (**OL1**) is activated frequently, this condition can be improved by changing the setting of the stall prevention level parameter **F601** to a lower level or increasing the acceleration time **ACC** or the deceleration time **DEC**.

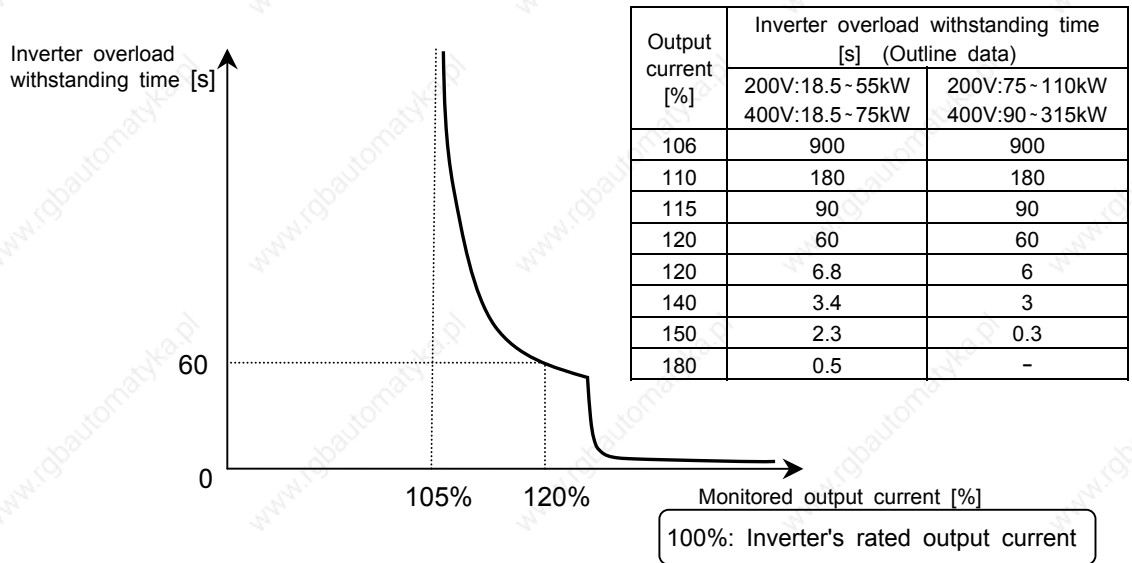

* If the load applied to the inverter exceeds 120% of its rated load or the operation frequency is less than 0.1Hz, the inverter may trip in a shorter time.

Inverter's overload protective characteristic

5.14 Preset-speed operation (15 speeds)

Sr 1 ~ **Sr 7** : Preset-speed #1 to #7

F287 ~ **F294** : Preset-speed #8 to #15

F381 ~ **F395** : Preset-speed #1 to #15 control mode

Function

These parameters allow you to set up to 15 operating speeds just by switching contact signals externally. Preset-speed frequencies can be set arbitrarily between the lower limit frequency *LL* and the upper limit frequency *UL*.

[Setting method]

1) Start/stop

Start and stop control is experienced by the control panel. (Default setting)

Title	Function	Adjustment range	Default setting
<i>CND</i>	Operation command mode selection	<i>0</i> : Terminal block enabled <i>1</i> : Operating panel enabled <i>2</i> : Common serial communication option <i>3</i> : Serial communication RS485 <i>4</i> : Communication add-on cassette option	<i>0</i>

Note) When speeds commands (analog signal or digital signal input) need to be switched in a preset-speed mode, then make a selection with the speed setting mode selection parameter *FND*. => Refer to 5.3 for details.

2) Setting preset-speed frequencies

A required number of speeds (frequencies) can be set.

Setting speeds 1 to 7

Title	Function	Adjustment range	Default setting
<i>Sr 1 ~ Sr 7</i>	Preset-speed #1 to #7	<i>LL ~ UL</i>	<i>0.0</i>

Setting speeds 8 to 15

Title	Function	Adjustment range	Default setting
<i>F287 ~ F294</i>	Preset-speed #8 to #10	<i>LL ~ UL</i>	<i>0.0</i>

Example of preset-speed contact input signal

0: ON, -: OFF (If all terminals are off, a speed command other than the preset speed commands is valid.)

Terminal	Preset-speed														
	1	2	3	4	5	6	7	8	9	10	11	12	13	14	15
S1-CC	-	-	-	-	-	-	-	-	-	-	-	-	-	-	-
S2-CC	-	-	-	-	-	-	-	-	-	-	-	-	-	-	-
S3-CC	-	-	-	-	-	-	-	-	-	-	-	-	-	-	-
S4-CC	-	-	-	-	-	-	-	-	-	-	-	-	-	-	-

Functions assigned to terminals (Default setting)

Terminal S1 ... Input terminal selection #5 (S1) *F 115 = 10* (S1)

Terminal S2 ... Input terminal selection #6 (S2) *F 116 = 12* (S2)

Terminal S3 ... Input terminal selection #7 (S3) *F 117 = 14* (S3)

Terminal S4 ... Input terminal selection #8 (S4) *F 118 = 16* (S4)

[An example of the connection of terminals]

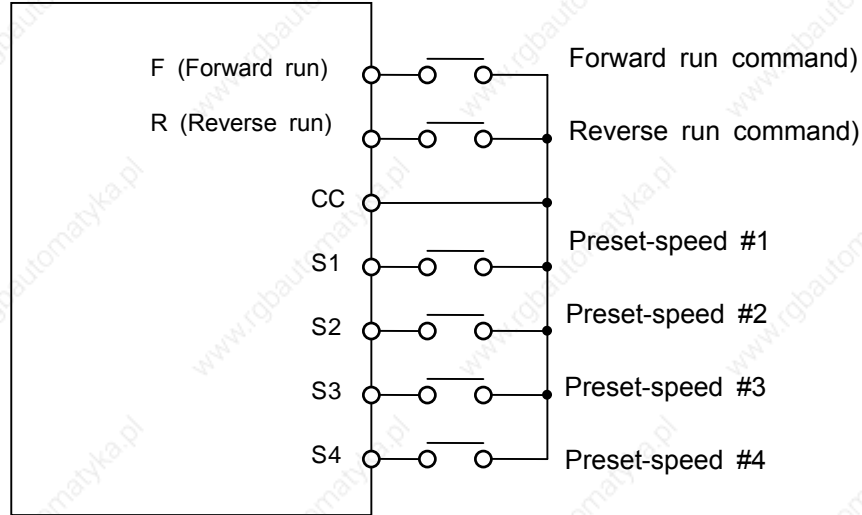

3) Use of a preset-speed command in combination with another speed command

When no preset-speed command is issued, the inverter accepts an input command from the control panel or another analog input device.

Preset-speed command	Other speed commands			
	Frequency setting signals from the control panel		Analog signal input command (VI, II, RR, RX1 and RX2)	
	Entered	Not entered	Entered	Not entered
Entered	Preset-speed command valid	Preset-speed command valid	Preset-speed command valid	Preset-speed command valid
Not entered	Control panel command valid	-	Analog signal valid	-

If a preset-command and another speed command are entered at the same time, priority is always given to the preset-speed command.

The following figure shows an example of the operation in preset-speed 7 modes with default setting.

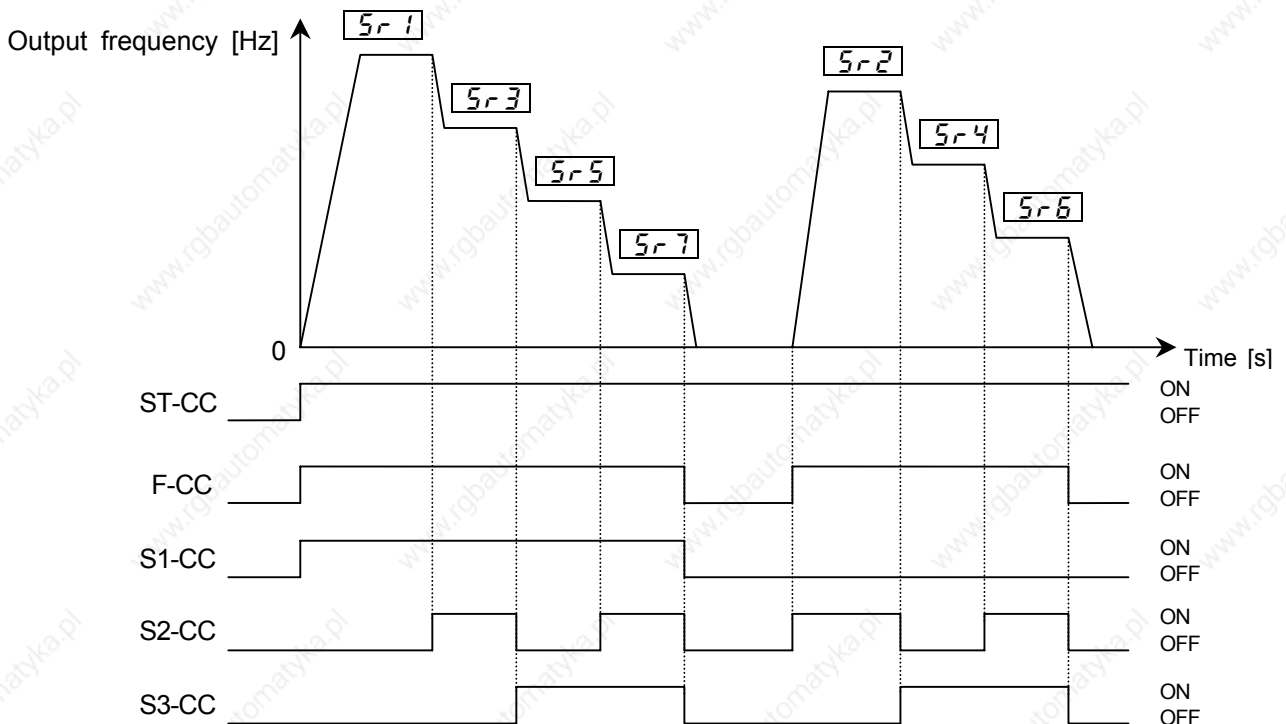

Example of the operation in preset-speed 7 modes

4) Setting the operation mode

An operation mode can be selected for each preset-speed.

Operation mode setting

Title	Function	Adjustment range	Default setting
F380	Present-speed operation mode	0: Disabled 1: Enabled	0

0: Disabled ... Only frequency commands are governed by the preset-speed command (#1 to #15) entered.

1: Enabled ... The direction of rotation, the V/f control mode, the acceleration and deceleration times and the torque limit can be set individually for each preset-command.

If you selected "enabled", the motor runs operation mode setting directions as below without following terminal F,R.

Operation mode setting

Title	Function	Adjustment range	Default setting
F381~F395	Present-speed #1 to #15 control mode	+0: Forward run +1: Reverse run +2: Selection of acc/dec switching #1 +4: Selection of acc/dec switching #2 +8: Selection of V/f switching #1 +16: Selection of V/f switching #2 +32: Selection of torque limit switching #1 +64: Selection of torque limit switching #2	0

For the settings marked with +, more than one function can be selected at the same time by entering the sum of the numbers of the desired functions.

Ex.1) (+1) + (+2) = 3

By entering 3, you can activate the reverse run function and the acceleration/deceleration time #2 function at the same time.

Ex.2) (+0) + (+2) + (+4) = 6

By entering 6, you can activate the forward run function and the acceleration/deceleration time #4 function at the same time.

(Selecting both of acc/dec switching #1 and acc/dec switching #2 means selection of acceleration/deceleration time #4. This manner is common to V/f pattern and torque limit.)

6. Extended parameters

Speed control mode

Torque control mode

Extended parameters are used for sophisticated operation, fine adjustment and special purposes. Change parameter settings, as required. Extended parameter list => Refer to Chapter 10.

6.1 Frequency signals

6.1.1 Low-speed signal

F 100 : Low-speed signal output frequency

• Function

When the output frequency exceeds the frequency set with the parameter F100, an ON signal is put out. The function of this parameter is to send a signal for exciting or releasing an electromagnetic brake.

through the open collector terminal OUT1 or OUT2 (24 Vdc - max. 50 mA). (Default setting: OUT 1)

[Parameter setting]

Title	Function	Adjustment range	Default setting
F 100	Low-speed signal output frequency	0.0 ~ UL	0.0

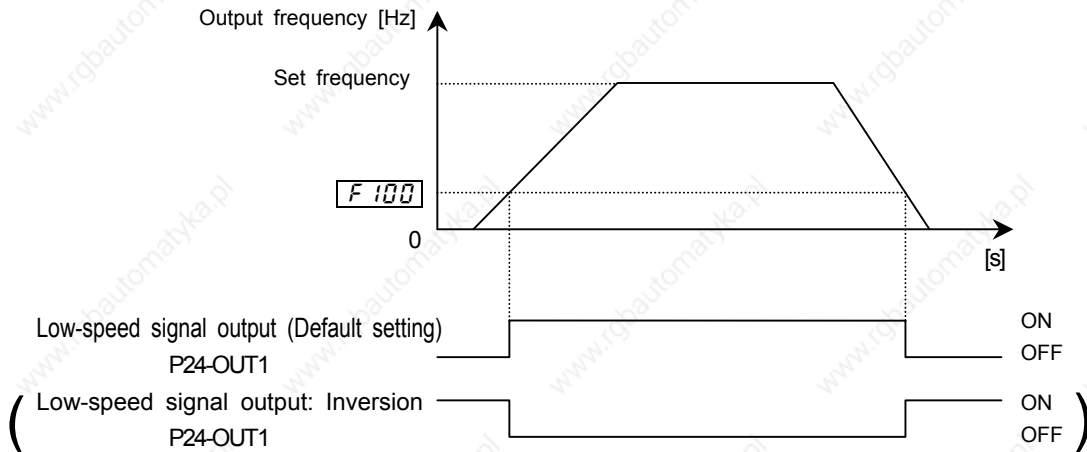

[Connection diagram (Sink logic)]

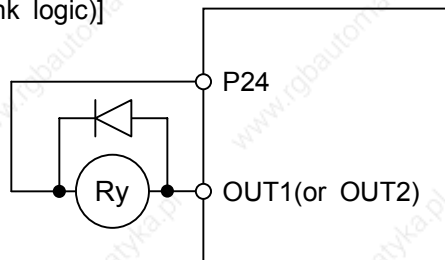

• Output terminal setting

The low-speed signal (ON signal) output function has been assigned to the terminal OUT1 by default. To invert output signals, it is necessary to change the setting of the output terminal selection parameter.

[Parameter setting]

Title	Function	Adjustment range	Set value
F 130	Output terminal selection #1 (OUT1)	0 ~ 119	4: Low speed signal(a-contact) or 5: Low speed signal(b-contact)

Note) To use OUT2 terminal, set the parameter **F 131**.

6.1.2 Putting out signals of arbitrary frequencies

F 101 : Speed reach setting frequency

F 102 : Speed reach detection band

• Function

When the output frequency enters the frequency range delimited by the frequencies set arbitrarily with the parameters **F 101** and **F 102** ((**F 101**-set frequency) +/- (**F 102**-set frequency)), an ON or OFF signal is put out.

Setting of reach frequency and detection frequency band

Title	Function	Adjustment range	Default setting
F 101	Speed reach setting frequency	0.0 ~ UL	0.0
F 102	Speed reach detection band	0.0 ~ UL	2.5

Setting of output terminal parameter

Title	Function	Adjustment range	Set value
F 131	Output terminal selection #2 (OUT2)	0 ~ 119	8: Specified speed arrival(a-contact) or 9: Specified speed arrival(b-contact)

Note) To put out signals to OUT 1, select the parameter **F 130**.

1) If detection frequency band + Speed reach setting frequency < Reference frequency

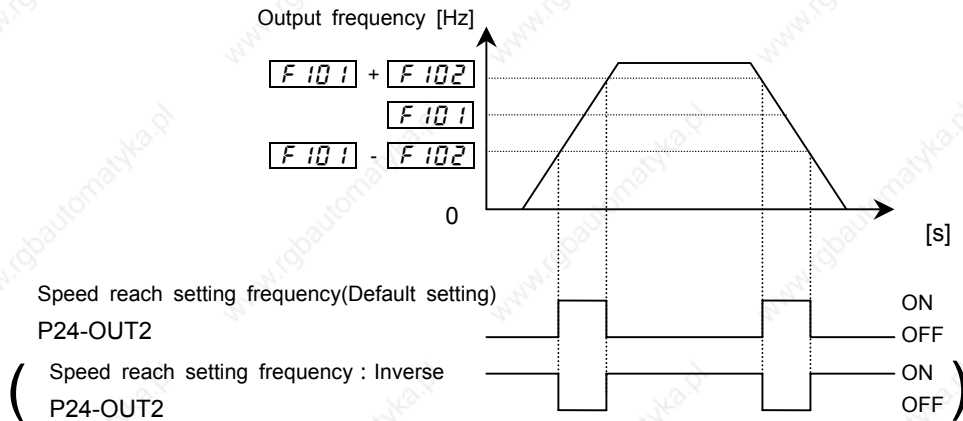

2) If detection frequency band + speed reach frequency > reference frequency

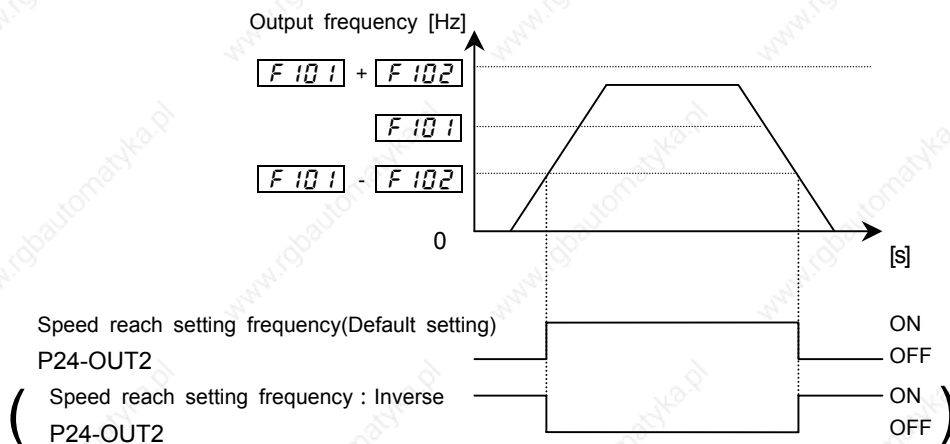

6.2 Selection of input signals

6.2.1 Changing standby signal function

F 103 : ST (standby) signal selection

• Function

This parameter is used to set the function of the standby signal (ST).

- 1) Normal setting (Standby if ST and CC are connected (ON), gate OFF if they are disconnected (OFF) (coast stop))
- 2) Always ON
- 3) Interlocked with F/R (Forward/reverse run if F/R and CC are connected, coast stop if they are disconnected)

Parameter setting

Title	Function	Adjustment range	Default setting
F 103	ST (standby) signal selection	0: Standard, 1: Always ON, 2: Interlocked with F/R terminal	0

1) Standard

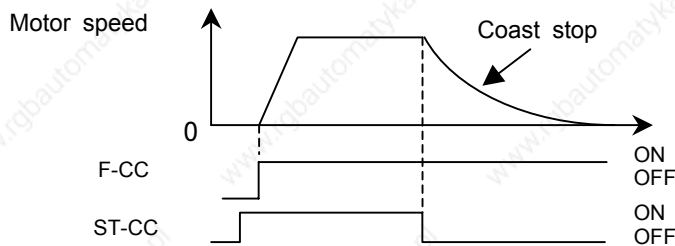

Use this setting if a standby terminal is needed

* The inverter is shipped with terminals ST and CC shorted with a bar. Remove the shorting bar when using these terminals.

2) Always-ON

The inverter is always on standby regardless of the status of the terminal ST. The terminal ST can be assigned to another function. In this mode, the motor slows down from the set frequency speed to a stop in the predetermined deceleration time.

3) Interlocked with terminal F (forward)/R (reverse)

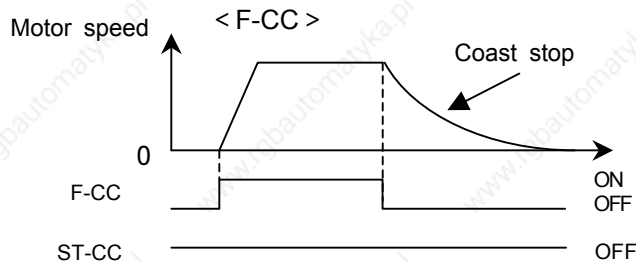

Breaking the connection of the operation frequency terminal (F/R) causes the motor to coast to a stop. (Free-run stop)

* The inverter is shipped with terminals ST and CC shorted with a bar. Remove the shorting bar when using these terminals.

6.2.2 Priority selection (both F-CC, R-CC are ON)

F 105 : Priority selection (both F-CC, R-CC is ON)

• Function

This parameter is used to select the operation to which priority is given when F-CC and R-CC are closed simultaneously.

- 1) Reverse run
- 2) Slowdown stop

Parameter setting

Title	Function	Adjustment range	Default setting
F 105	Priority selection (both F-CC, R-CC are ON)	0:Reverse, 1:Stop	0

[F 105=0(reverse)]

The motor runs in reverse direction if F-CC and R-CC are closed simultaneously.

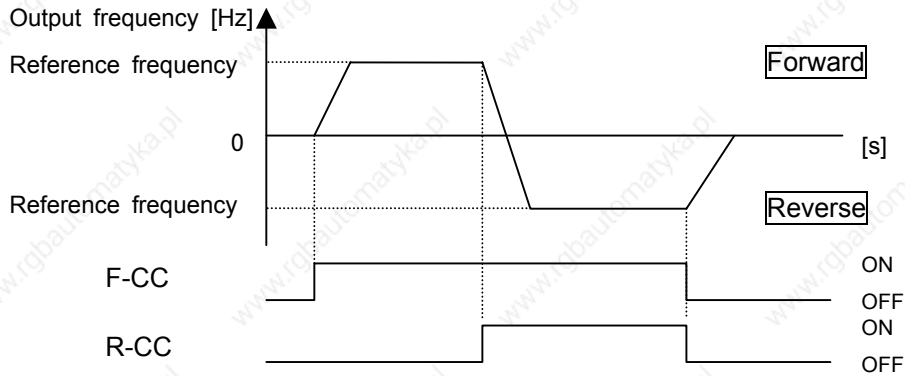

[F 105=1(Stop)]

The motor slows down to a stop if F-CC and R-CC are closed simultaneously.

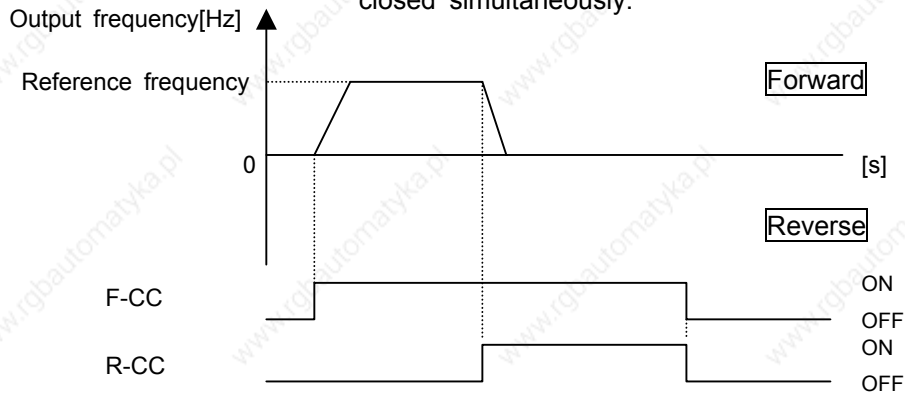

6.2.3 Assigning priority to the terminal board in panel operation mode

F 106 : Priority setting of input terminal

• Function

This parameter is used to give priority to certain external commands entered from the terminal board in control panel operation mode, for example, when jogging the motor by giving signals externally.

Parameter setting

Title	Function	Adjustment range	Default setting
F 106	Priority setting of input terminal	0: Disabled, 1: Enabled	0

[0: Disabled (Terminal board has no priority)]

Priority is given always to commands (operation commands) entered from the control panel. To give priority to commands from the terminal board, it is necessary to switch from control panel operation to terminal board operation by sending signals through the terminal board.

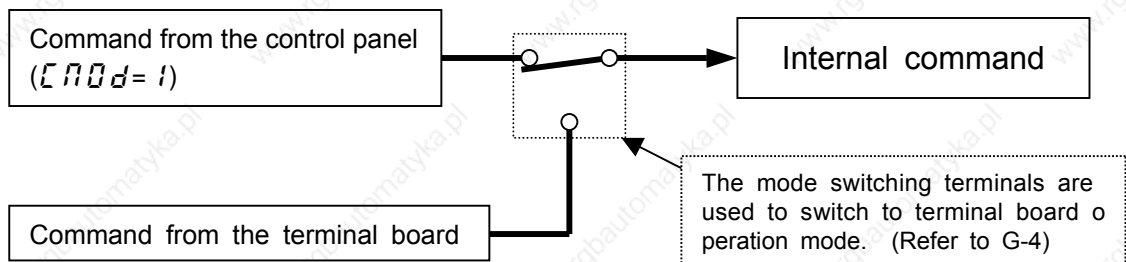

[/: terminal board has priority (Enabled)]

Priority is given to commands entered from the terminal board even in control panel operation mode.

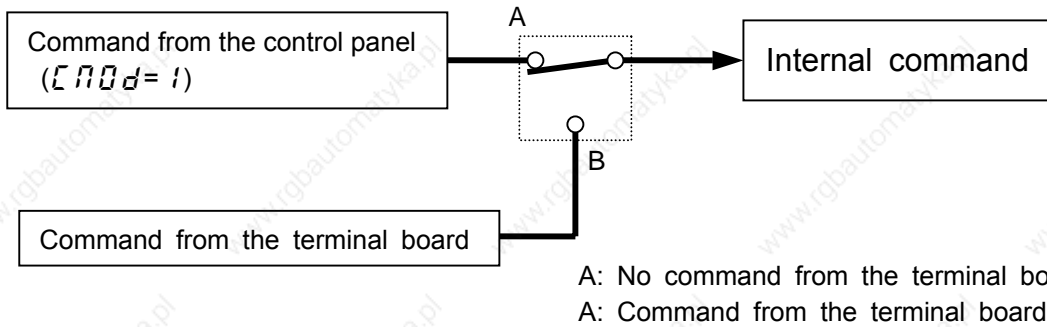

Priority command from terminal board (Operation command)

- Jog run : input terminal function 18/19
- Injection braking : input terminal function 22/23 (*1)
- Forced jog run(forward) : input terminal function 50/51 (*1)
- Forced jog run(reverse) : input terminal function 52/53 (*1)

(*1)These settings are invalid when the control panel stop pattern parameter *F 721* is set at *1*.

An example of switching to jog run in control panel operation mode

[Incase that terminals S4 and CC are assigned to jog run]

Assign the control terminal S4 (default: 16 (preset-speed #4)) to jog run.

Title	Function	Adjustment range	Setting value
<i>F 118</i>	Input terminal selection #8 (S4)	<i>0 ~ 135</i>	<i>18</i> (Jog run)

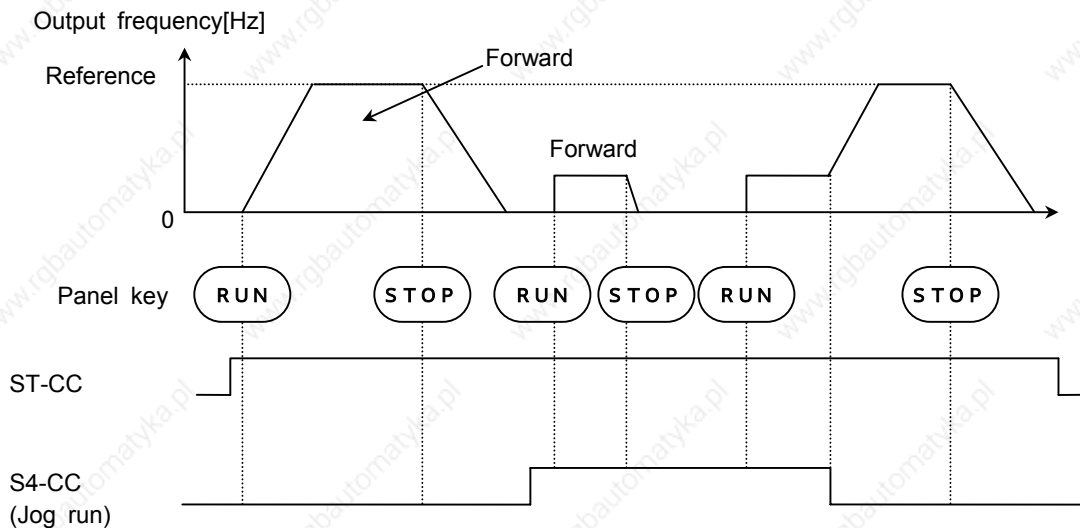

[When terminals S3, S4 and CC are assigned to forced jog forward/reverse]
 Assign the control terminal S4 (default: 16 (preset-speed # 4)) to jog run.

Title	Function	Adjustment range	Setting value
F 117	Input terminal selection #7(S3)	0 ~ 135	50 (Forced JOG forward rotation)
F 118	Input terminal selection #8(S4)	0 ~ 135	52 (Forced JOG reverse rotation)

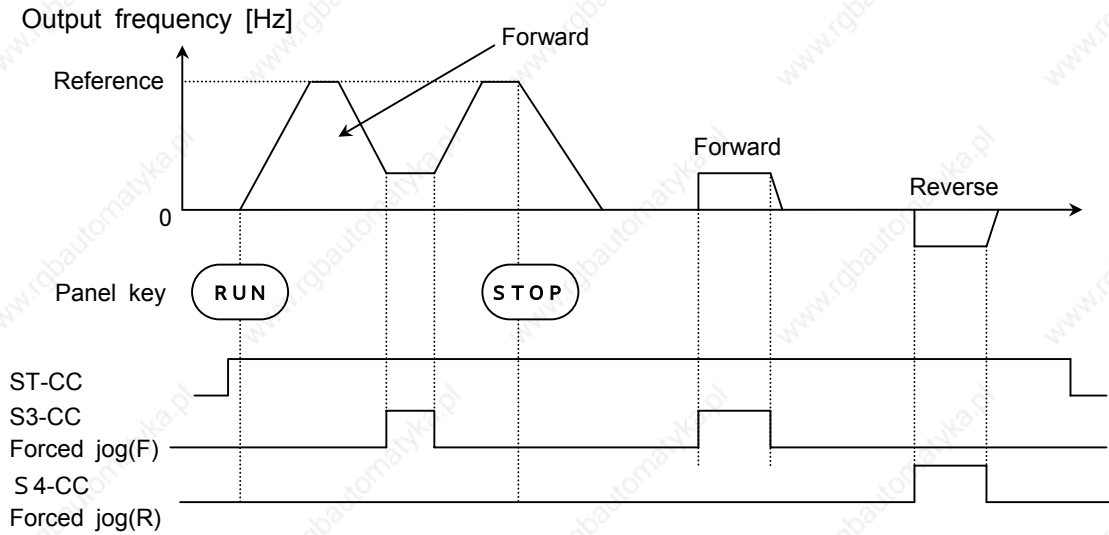

6.2.4 Binary/BCD signal selection(Expansion TB option unit)

F 107 : Binary/BCD signal selection(Expansion TB option unit)

For details, refer to the instruction manual for the optional device.

6.3 Selection of terminal functions

6.3.1 Keeping an input terminal function always active (ON)

F 110 : Always active function selection

• Function

This parameter is used to select a function to be kept always active (ON) from among the input terminal functions. (One function can be selected)

Parameter setting

Title	Function	Adjustment range	Default setting
F 110	Always active function selection	0 ~ 135	0

The selected function is kept always active regardless of the type of logic (positive or negative) in the table of function settings in 7.2.1.

6.3.2 Changing input terminal functions

F 111 : Input terminal selection #1 (F)

F 116 : Input terminal selection #6 (S2)

F 112 : Input terminal selection #2 (R)

F 117 : Input terminal selection #7 (S3)

F 113 : Input terminal selection #3 (ST)

F 118 : Input terminal selection #8 (S4)

F 114 : Input terminal selection #4 (RES)

F 119 ~ **F 126** : Input terminal selection #9 ~ #16

F 115 : Input terminal selection #5 (S1)

Refer to 7.2.1 for details.

6.3.3 Signal on completion of acceleration/deceleration (OUT 2)

F 131 : Output terminal selection #2 (OUT2)

• Function

If this parameter is so set, a signal is put out on completion of acceleration/deceleration. Open collector output terminal OUT1 or OUT2 (24 Vdc - max. 50 mA)

Setting of output terminal

Title	Function	Adjustment range	Setting value
F 131	Output terminal selection #2 (OUT2)	0 ~ 119	5: Acceleration/deceleration completion(a-contact) or 7: Acceleration/deceleration completion(b-contact)

Note) OUT1 for putting out a signal, select the parameter **F 130**.

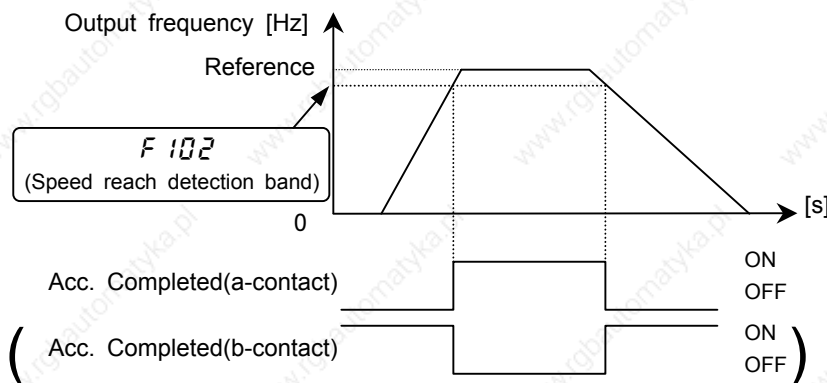

6.3.4 Changing output terminal functions

F 130 : Output terminal selection #1 (OUT1)

F 131 : Output terminal selection #2 (OUT2)

F 132 : Output terminal selection #3 (FL)

F 133 ~ **F 136** : Output terminal selection #4 ~ #7

Refer to 7.2.2 for details.

6.3.5 Response times of input/output terminals

F 140 : Input terminal #1 response time (F)

F 141 : Input terminal #2 response time (R)

F 142 : Input terminal #3 response time (ST)

F 143 : Input terminal #4 response time (RES)

F 144 : Input terminal #5 ~ #8 response time (S1 ~ S4)

F 145 : Input terminal #9 ~ #16 response time

F 150 ~ **F 156** : Output terminal #1 ~ #7 delay time

F 160 ~ **F 166** : Output terminal #1 ~ #7 holding time

Refer to 7.2.3 for details.

6.4 Basic parameters #2

6.4.1 Switching among V/f characteristics #1, #2, #3 and #4 from input terminal

F 170 : Base frequency #2	F 176 : Manual torque boost #3
F 171 : Base frequency voltage #2	F 177 : Motor overload protection level #3
F 172 : Manual torque boost #2	F 178 : Base frequency #4
F 173 : Motor overload protection level #2	F 179 : Base frequency voltage #4
F 174 : Base frequency #3	F 180 : Manual torque boost #4
F 175 : Base frequency voltage #3	F 181 : Motor overload protection level #4

• Function

These parameters is useful for - for example - when 4 motors are connected to a single inverter and thus they need to be switched from time to time to operate or there is a need to change V/f characteristics (#1 to #4).

- 1) Switching with input terminal
- 2) Switching by parameter settings => Refer to 6.29.6.

Note) The setting of the parameter $P \underline{t}$ (V/f control mode selection) is valid only when V/f #1 is selected. If V/f #2, V/f #3 or V/f #4 is selected, V/f control is performed in constant torque mode. Do not switch motors when the parameter $P \underline{t}$ (Motor control mode selection) is set at 7, 8 or 9. For parameters selected when changing V/f characteristics (1 to 4), refer to table on the next page.

Setting of switching terminals

The V/f #1, V/f #2, V/f #3 and V/f #4 switching function is not yet assigned to any terminal. Therefore, it is necessary to assign them to unused terminals.

Ex.) Assigning the V/f switching #1 function to S1 and the V/f switching #2 function to S2.

Title	Function	Adjustment range	Setting value
F 115	Input terminal selection #5(S1)	0 ~ 135	28: (V/f switching #1)
F 116	Input terminal selection #6(S2)	0 ~ 135	30: (V/f switching #2)

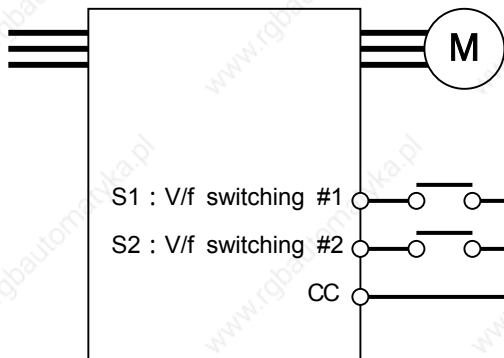

S1(V/f switching #1) -CC	S2(V/f switching #2) -CC	V/f	Parameters selected
OFF	OFF	#1	Base frequency #1 : <i>uL</i> Base frequency voltage #1 : <i>F 306</i> Manual torque boost : <i>ub</i> Motor overload protection level #1 : <i>F 600</i> Acceleration time #1 : <i>ACC</i> Deceleration time #1 : <i>dEC</i> Acceleration/deceleration pattern #1 : <i>F 502</i> Power running torque limit #1 : <i>F 441</i> Regenerative torque limit #1 : <i>F 443</i>
ON	OFF	#2	Base frequency #2 : <i>F 170</i> Base frequency voltage #2 : <i>F 171</i> Manual torque boost #2 : <i>F 172</i> Motor overload protection level #2 : <i>F 173</i> Acceleration time #2 : <i>F 500</i> Deceleration time #2 : <i>F 501</i> Acceleration/deceleration pattern #2 : <i>F 503</i> Power running torque limit #2 : <i>F 444</i> Regenerative torque limit #2 : <i>F 445</i>
OFF	ON	#3	Base frequency #3 : <i>F 174</i> Base frequency voltage #3 : <i>F 175</i> Manual torque boost #3 : <i>F 176</i> Motor overload protection level #3 : <i>F 177</i> Acceleration time #3 : <i>F 510</i> Deceleration time #3 : <i>F 511</i> Acceleration/deceleration pattern #3 : <i>F 512</i> Power running torque limit #3 : <i>F 446</i> Regenerative torque limit #3 : <i>F 447</i>
ON	ON	#4	Base frequency #4 : <i>F 178</i> Base frequency voltage #4 : <i>F 179</i> Manual torque boost #4 : <i>F 180</i> Motor overload protection level #4 : <i>F 181</i> Acceleration time #4 : <i>F 514</i> Deceleration time #4 : <i>F 515</i> Acceleration/deceleration pattern #4 : <i>F 516</i> Power running torque limit #4 : <i>F 448</i> Regenerative torque limit #4 : <i>F 449</i>

Select V/f #1 when using the sensor-less vector control and the V/f 5-point setting. Selecting V/f #2, #3 or #4 disables the vector control but enables the V/f constant control. In addition, if the torque limit switching function and the acceleration/deceleration switching function are assigned to input terminals, their settings are valid.

Note) With the control panel or communication, the following parameters can be set individually:

- V/f switching (*F 720*)
- Acceleration/deceleration switching (*F 504*)
- Torque limit switching (*F 723*)

* These functions are active only in control panel operation mode.

6.5 V/f 5-point setting

<i>F 190</i> : V/f 5-point setting VF1 frequency	<i>F 196</i> : V/f 5-point setting VF4 frequency
<i>F 191</i> : V/f 5-point setting VF1 voltage	<i>F 197</i> : V/f 5-point setting VF4 voltage
<i>F 192</i> : V/f 5-point setting VF2 frequency	<i>F 198</i> : V/f 5-point setting VF5 frequency
<i>F 193</i> : V/f 5-point setting VF2 voltage	<i>F 199</i> : V/f 5-point setting VF5 voltage
<i>F 194</i> : V/f 5-point setting VF3 frequency	
<i>F 195</i> : V/f 5-point setting VF3 voltage	

Refer to 5.10.7 for details.

6.6 Speed/torque command gain and bias

6.6.1 Using two types of frequency (speed) commands

- F α 0d** : Speed setting mode selection
- F200** : Reference priority selection
- F207** : Speed setting mode selection #2
- F208** : F α 0d / F207 switching frequency

- **Function**
These parameters switch two types of frequency
- Switching by parameter setting
- Automatic switching by means of switching frequencies
- Switching with input terminal

1) One frequency (speed) reference

Reference priority selection **F200=0** (Default setting)



Priority is given to the reference set with **F α 0d**.

2) Switching with input terminal (F204=4)

Reference can be switched if the frequency priority switching function is assigned to a terminal.

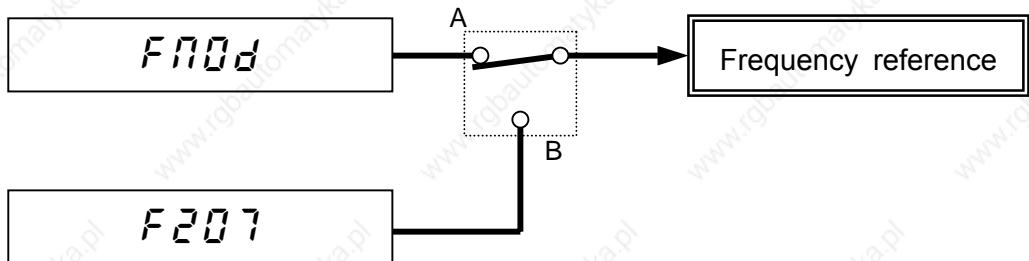

A : **F α 0d** has priority Frequency priority switching terminal OFF

B : **F207** has priority Frequency priority switching terminal ON

Ex.) When the frequency priority switching function is assigned to terminal S4.

Title	Function	Adjustment range	Setting value
F118	Input terminal selection #8(S4)	0 ~ 135	104 (Frequency reference priority switching)

		Reference priority
	OFF	Fα0d has priority
	ON	F207 has priority

3) Automatic switching by means of switching frequencies ($F200 = 2$)

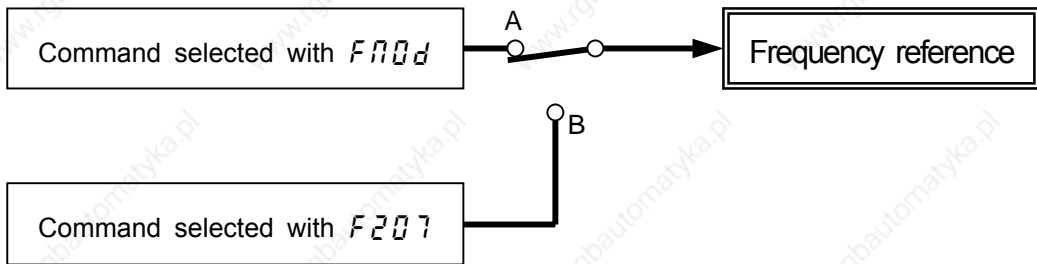

A: If the frequency set with Fnd is higher than that set with $F208$

· · · Priority is given to the command set with Fnd .

B: If the frequency set with Fnd is equal to or lower than that set with $F208$

· · · Priority is given to the command set with $F207$.

Frequency reference

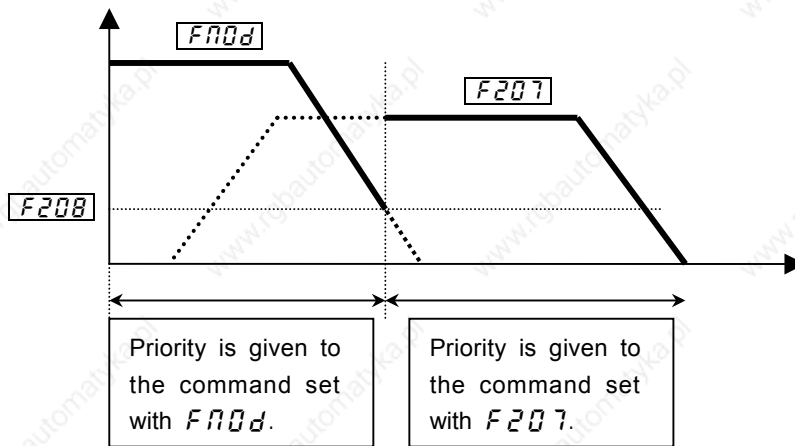

4) Automatic switching by means of switching frequencies ($F200 = 3$).

A: If the frequency set with $F207$ is higher than that set with $F208$

· · · Priority is given to the reference set with $F207$.

B: If the frequency set with $F207$ is equal to or lower than that set with $F208$

· · · Priority is given to the reference set with Fnd .

Frequency reference

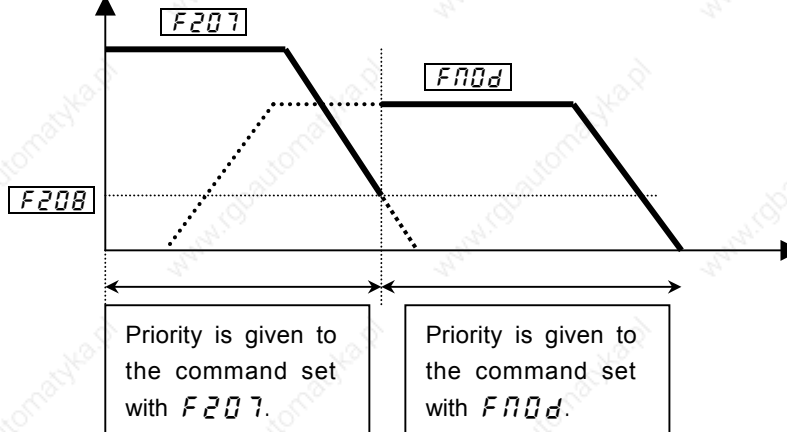

Parameter setting

Title	Function	Adjustment range	Default setting
<i>F_{00d}</i>	Speed setting mode selection	<i>1</i> :VI(voltage input)/II(current input) <i>2</i> :RR(volume/voltage input) <i>3</i> :RX(voltage input) <i>4</i> :RX2(voltage input)(optional) <i>5</i> :Operating panel input <i>6</i> :Binary/BCD input (optional) <i>7</i> :Common serial communication option <i>8</i> :Serial communication RS485 <i>9</i> :Communication add-on cassette option <i>10</i> :Up/down frequency <i>11</i> :Pulse input #1 (optional)	<i>2</i>
<i>F₂₀₀</i>	Reference priority selection	<i>0</i> : <i>F_{00d}</i> <i>1</i> : <i>F₂₀₇</i> <i>2</i> : <i>F_{00d}</i> has priority <i>3</i> : <i>F₂₀₇</i> has priority <i>4</i> : <i>F_{00d}</i> / <i>F₂₀₇</i> switching (input terminal function 104)	<i>0</i>
<i>F₂₀₇</i>	Speed setting mode selection #2	Same as <i>F_{00d}</i>	<i>1</i>
<i>F₂₀₈</i>	<i>F_{00d}</i> / <i>F₂₀₇</i> switching frequency	<i>0.1</i> ~ <i>FH</i>	<i>1.0</i>

6.6.2 Setting frequency command characteristics

<i>F₂₀₁</i> : VI/II reference point #1	<i>F₂₂₂</i> : RX2 reference point #1
<i>F₂₀₂</i> : VI/II reference point #1 frequency	<i>F₂₂₃</i> : RX2 reference point #1 frequency
<i>F₂₀₃</i> : VI/II reference point #2	<i>F₂₂₄</i> : RX2 reference point #2
<i>F₂₀₄</i> : VI/II reference point #2 frequency	<i>F₂₂₅</i> : RX2 reference point #2 frequency
<i>F₂₁₀</i> : RR reference point #1	<i>F₂₂₈</i> : BIN reference point #1
<i>F₂₁₁</i> : RR reference point #1 frequency	<i>F₂₂₉</i> : BIN reference point #1 frequency
<i>F₂₁₂</i> : RR reference point #2	<i>F₂₃₀</i> : BIN reference point #2
<i>F₂₁₃</i> : RR reference point #2 frequency	<i>F₂₃₁</i> : BIN reference point #2 frequency
<i>F₂₁₆</i> : RX reference point #1	<i>F₂₃₄</i> : Pulse reference point #1
<i>F₂₁₇</i> : RX reference point #1 frequency	<i>F₂₃₅</i> : Pulse reference point #1 frequency
<i>F₂₁₈</i> : RX reference point #2	<i>F₂₃₆</i> : Pulse reference point #2
<i>F₂₁₉</i> : RX reference point #2 frequency	<i>F₂₃₇</i> : Pulse reference point #2 frequency

Refer to 7.3 for details.

6.6.3 Setting torque reference characteristics

<i>F₂₀₁</i> : VI/II reference point #1	<i>F₂₂₂</i> : RX2 reference point #1
<i>F₂₀₃</i> : VI/II reference point #2	<i>F₂₂₄</i> : RX2 reference point #2
<i>F₂₀₅</i> : VI/II reference point #1 rate	<i>F₂₂₆</i> : RX2 reference point #1 rate
<i>F₂₀₆</i> : VI/II reference point #2 rate	<i>F₂₂₇</i> : RX2 reference point #2 rate
<i>F₂₁₀</i> : RR reference point #1	<i>F₂₂₈</i> : BIN reference point #1
<i>F₂₁₂</i> : RR reference point #2	<i>F₂₃₀</i> : BIN reference point #2
<i>F₂₁₄</i> : RR reference point #1 rate	<i>F₂₃₂</i> : BIN reference point #1 rate
<i>F₂₁₅</i> : RR reference point #2 rate	<i>F₂₃₃</i> : BIN reference point #2 rate
<i>F₂₁₆</i> : RX reference point #1	
<i>F₂₁₈</i> : RX reference point #2	
<i>F₂₂₀</i> : RX reference point #1 rate	
<i>F₂₂₁</i> : RX reference point #2 rate	

Refer to 6.21 for details.

6.7 Operation frequency

6.7.1 Start-up frequency and End frequency

F240 : Start-up frequency

F243 : Stop frequency

• Function

The frequency set with the parameter **F240** is put out immediately. These parameters are used if the acceleration/deceleration time causes a delay in the response of the starting torque. It is advisable to set these frequencies between 0.5 and 2 Hz (at a maximum of 5 Hz). This setting reduces the slippage of motor below the rated value to prevent over-current. If 0 speed torque is needed (pt = 8,9), set **F240, F243** at 0.0.

- At startup: frequency set with **F240** is put out immediately.
- At stop: The output frequency drops to 0 Hz immediately by the frequency set with **F243**.

[Parameter setting]

Title	Function	Adjustment range	Default setting
F240	Start-up frequency	0.0 ~ 10.0 [Hz]	0.1
F243	Stop frequency	0.0 ~ 30.0 [Hz]	0.0

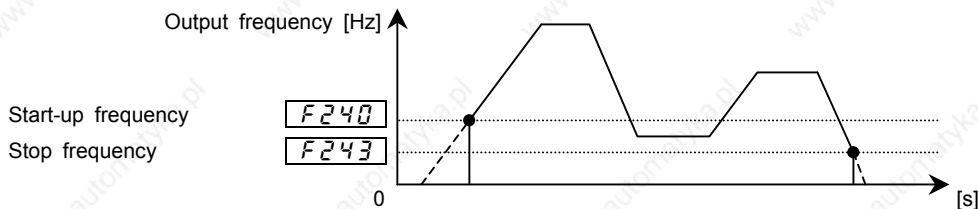

Note) Set these parameters so that the start-up frequency **F240** is higher than the stop frequency **F243**. If the **F240**-set frequency is lower than the **F243**-set frequency, the reference frequency must be higher than the **F243**-set frequency to start the motor.

6.7.2 Operating by means of reference signals

F241 : Run frequency

F242 : Run frequency hysteresis

• Function

The start and stop of the motor can be controlled simply by giving frequency setting signals.

[Parameter setting]

Title	Function	Adjustment range	Default setting
F241	Run frequency	0.0 ~ FH	0.0
F242	Run frequency hysteresis	0.0 ~ 30.0 [Hz]	0.0

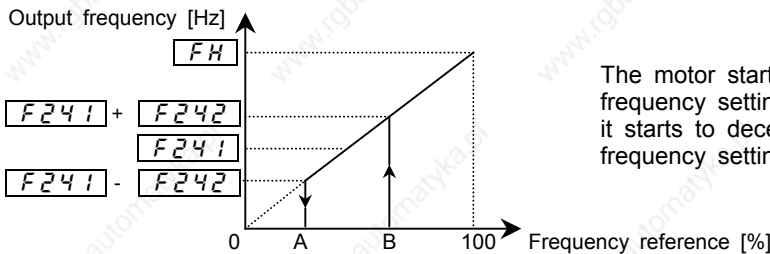

The motor starts to accelerate when the frequency setting signal reaches point B, while it starts to decelerate and stop when the frequency setting signal falls below point A.

6.7.3 0Hz dead band frequency

F244 : 0Hz dead band frequency

• Function

In order to fix the motor axis by the control with a sensor, you may set frequency reference as 0[Hz] by the analog input etc.. But it may be set to 0[Hz] neither by the drift nor offset. In such a case, this function sets frequency instructions to 0[Hz] certainly. When frequency reference is smaller than **F244**-set value, frequency reference is set to 0[Hz].

[Parameter setting]

Title	Function	Adjustment range	Default setting
F244	0Hz dead band frequency	0.0 ~ 5.0 [Hz]	0.0

Frequency after 0Hz dead band operation carried out.

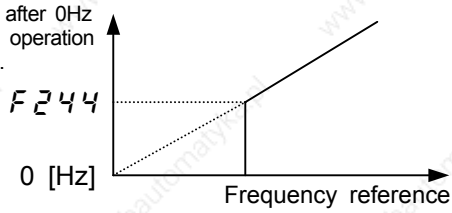

notes 1) This function is invalid to preset-speed operation.
 notes 2) It is effective as frequency instructions to the frequency reference chosen by the priority processing by *F70d*, *F207*, communication, etc.
 notes 3) The addition and multiplication of the override function is carried out to the frequency in which this function operated.

6.8 DC injection braking

6.8.1 DC injection braking

F250 : DC injection braking start frequency

F251 : DC injection braking current

F252 : DC injection braking time

F253 : Forward/reverse DC braking priority control

• Function

These parameters apply a direct current to the motor to obtain large braking torque. These parameters are used to set the direct current to be applied to the motor, the braking time and the braking start frequency.

[Parameter setting]

Title	Function	Adjustment range	Default setting
F250	DC injection braking start frequency	0.0 ~ 120.0 [Hz]	0.0
F251	DC injection braking current	0.0 ~ 100.0 [%]	50.0
F252	DC injection braking time	0.0 ~ 10.0 [s]	1.0
F253	Forward/reverse DC braking priority control	0: OFF, 1: ON	0

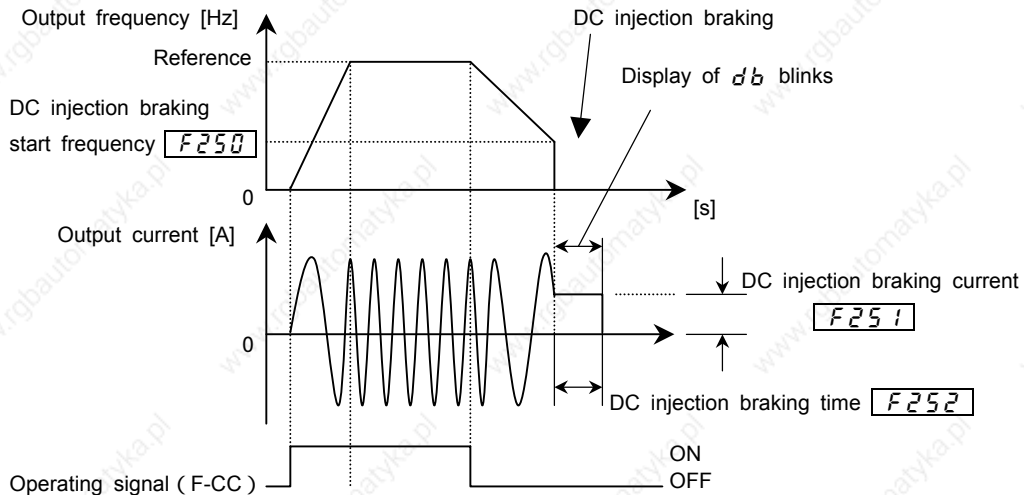

Note) The sensitivity of the inverter's overload protective function increases during D.C. braking. To avoid tripping, the inverter may automatically adjust the D.C. braking rate.

<D.C. braking start conditions>

The forward/reverse DC braking priority control function **F253** recognizes certain conditions as stop commands from the inverter, and is activated when the output frequency goes down below the DC injection braking start frequency set with **F250**. In this case, the conditions under which DC injection braking starts include not only the issue of a start or stop command from the control panel or an external input device, but also a fall in the reference frequency below the value set with **F243** (stop frequency setting) or a fall in the output frequency below the operation stop frequency.

[D.C. braking under normal conditions]

(Forward/reverse DC braking priority control $F253=0$ [OFF])

 : DC injection braking

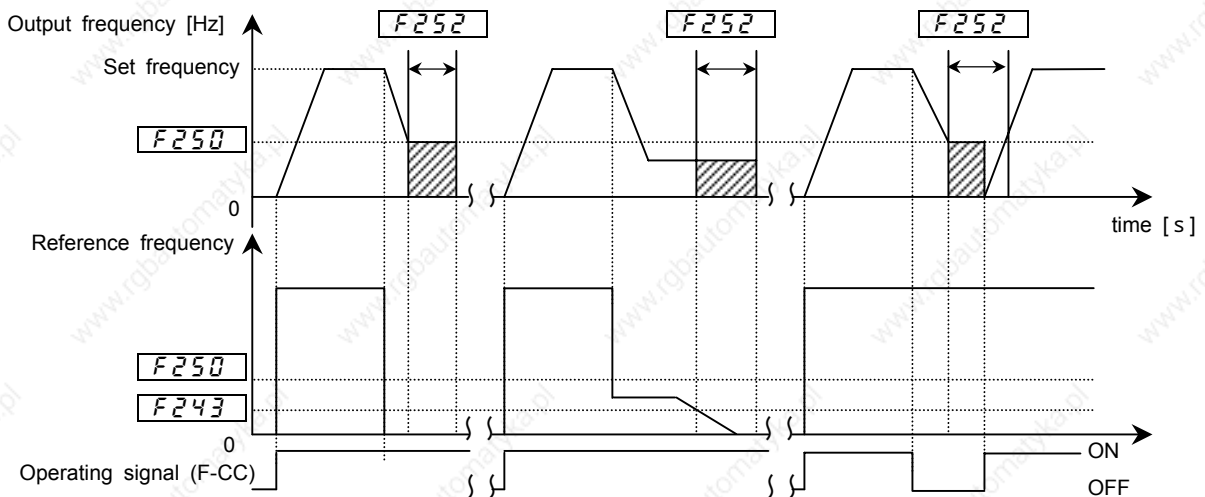

If $F250$ and $F243 >$ reference frequency : DC injection braking ,
 If $F250 >$ reference frequency $> F243$: Operation at command frequencies,
 If $F250$ and $F243 >$ reference frequency : DC injection braking
 If an operation command is entered during D.C. braking : D.C. braking is discontinued to restart the operation.

[Priority to DC injection braking during forward/reverse operation]

(Forward/reverse run D.C. braking priority control $F253 = 1$ (ON))

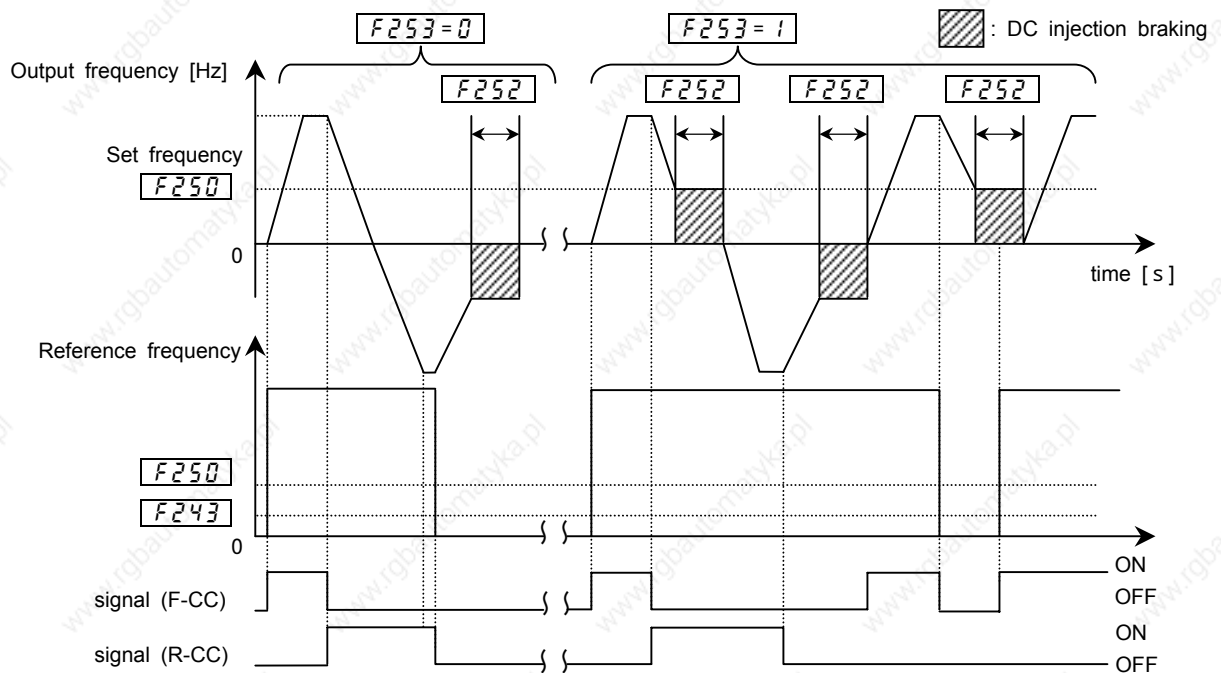

During normal forward/reverse run($F253 = 0$) :

Not recognized as a stop command, so that DC injection braking is not active.

If a reverse run (or forward) command is entered during forward run (or reverse)

($F253 = 1$) : DC injection braking starts when the frequency set with $F250$ exceeds the reference frequency during deceleration.

If an operation command is entered during D.C. braking : priority is given to D.C. braking.

6.8.2 Motor shaft fixing control

$F254$: Motor shaft fixing control

• Function

This function is useful for preventing the motor shaft from rotating freely or for preheating the motor.

[Parameter setting]

Title	Function	Adjustment range	Default setting
F254	Motor shaft fixing control	0: Disabled, 1: Enabled	0

If the motor shaft fixing control parameter **F254** is set at 1, DC braking continue at half a braking rate of that set with **F251** to retain the motor after it has come to a full stop by DC braking. To terminate the motor shaft fixing control, cut off the standby signal (ST signal).

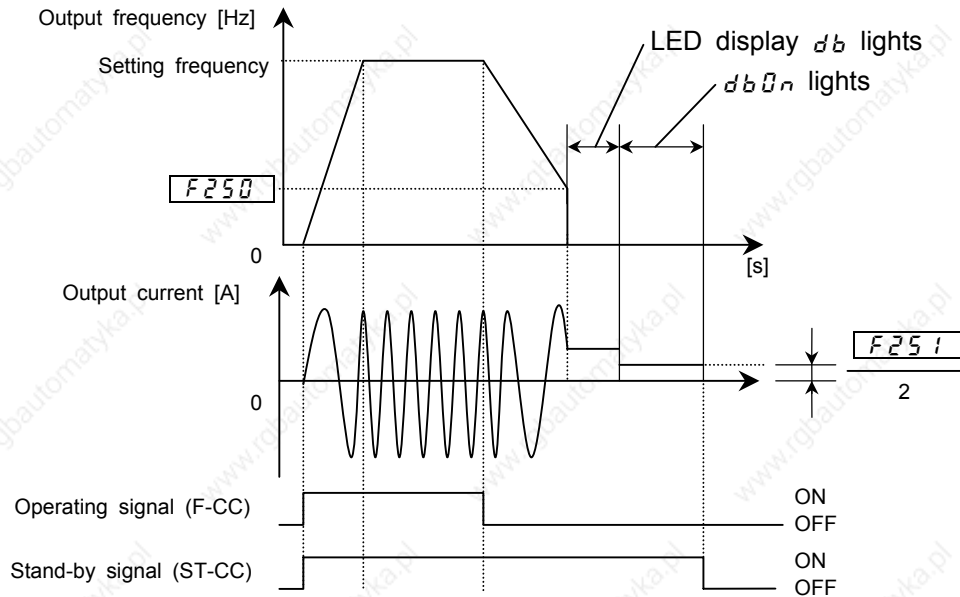

- Note 1) Almost the same motor shaft fixing control can be exercised when DC injection braking is controlled by means of external signals.
- Note 2) If the motor shaft fixing control parameter **F254** is set at 1 (enabled) when the output frequency is below the DC injection braking start frequency **F250** and terminals ST-CC are closed (ON), the DC injection braking function is activated and the motor shaft fixing control continues regardless of the setting of the D.C. braking time parameter **F252**.
However, when a general-purpose motor is operated, if the D.C. braking rate **F251** is set above 60% and the D.C. braking time **F252** is set at a certain value, the overload protective function may be activated by the electronic thermal protective function.
In addition, the inverter may automatically control the D.C. braking rate to avoid tripping.
- Note 3) If the motor shaft is set free because of a power failure, the brake shaft fixing control is discontinued. Also, if the inverter trips when the motor shaft fixing function is active, the fixing control is discontinued, whether or not it automatically recovers from tripping by its retry function.

6.8.3 Zero-speed stop mode selection

F255 : Zero-speed stop mode selection

• Function

This function controls motor in the zero-speed state at the time of a stop. If this function is set up, 0Hz reference will be put out instead of DC braking at the time of a stop, and a motor will be controlled in the setting time stop state. The monitor display serves as *db* during this control operation. This function operates only at the time of vector control ($Pt = 8, 9$) with a sensor.

Refer to the direct-current braking (6.8.1) for conditions of operation. The portion of DC injection braking is served as operation which set frequency reference to 0Hz.

[Parameter setting]

Title	Function	Adjustment range	Default setting
F255	Zero-speed stop mode selection	0: Standard(DC injection braking) 1: 0 Hz command	0
F250	DC injection braking start frequency	0.0 ~ 120.0 [Hz]	0.0
F252	DC injection braking time	0.0 ~ 10.0 [s]	1.0

Note.1) This function doesn't operate when **F250** = 0.0.

Note.2) If this function is set up, motor shaft fixing control(**F254**)cannot be used.

Note.3) This function doesn't operate at the time of a torque control and position control.

Note.4) This function doesn't operate except the time of the vector control ($Pt = 8, 9$) with a sensor. In order to use this function, the option board for PG feedback is required. In other than the vector control ($Pt = 8, 9$) with a sensor, the usual DC injection braking operates.

Note.5) Since the reference frequency that will suspend the motor abruptly from the state of high

rotation if $F250$ is set up highly, please be careful. A trip may occur according to load conditions.

Note.6) Setting of this function will influence following DC injection brakings.

1. DC injection braking by terminal command (the input terminal functions 22 and 23)
2. DC injection braking by command via communication
3. DC injection braking when $F261$ (Jog stop control) is set at 2.
4. DC injection braking when $F603$ (Emergency stop mode selection) is set at 2 or 5.

6.9 Jog run

$F260$: Jog run frequency

$F261$: Jog stop control

• Function

The jog run parameters are used to jog the motor. When a jog run signal is given, the jog run frequency is put out immediately irrespective of the predetermined acceleration time.

Jog run is operational when the terminals S4(assigned to Jog)-CC are active.

[Parameter setting]

Title	Function	Adjustment range	Default setting
$F260$	Jog run frequency	0.0 ~ 20.0 [Hz]	0.0
$F261$	Jog stop control	0: Deceleration stop, 1: Coast stop, 2: DC injection braking stop	0

<Example of jog run>

Forward jog run when S4-CC (Jog terminal) is ON, and F-CC are ON (connected)

Reverse jog run when S4-CC (Jog terminal) is ON, and R-CC are ON (connected)

(Forward run (or reverse) if a frequency reference is given when F-CC are ON (or R-CC are ON))

Output frequency [Hz]

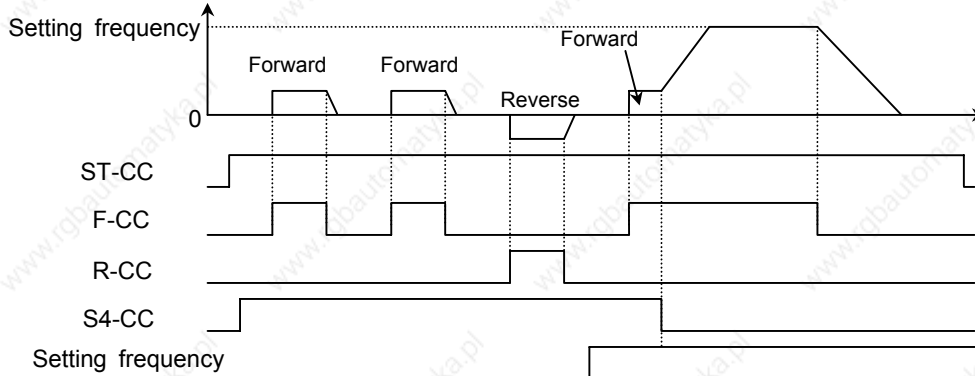

- The terminals S4 and CC assigned to jog run are enabled when the operation frequency is lower than the jog frequency, and they are disabled if not. To switch to jog run during normal operation, set the forced jog run parameter (input terminal function selection) at 50 or 51 (inversion), and 52 or 53 (inversion).
- Jog run is operational when the jog run terminals S4-CC is active (ON).
- Priority is given to jog run even when an operation command is entered during jog run.
- In control panel operation mode, setting the parameter $F106$ (input terminal priority selection) at 1 makes it possible to perform jog run, using the Run and Stop keys.
- Even when $F261$ is set at 0 or 1, an emergency DC injection braking stop can be used ($F603$ is set at 2 or 5).
- If F-CC and R-CC are ON simultaneously when $F105$ (Priority selection) is set at 0 (reverse run), operation modes switches as follows:
Forward jog run -> slowdown stop (jog frequency -> 0 [Hz]) -> reverse jog run.

[Setting of jog terminals S4-CC]

Assign the control terminal S4 to jog run (default setting:16 (preset-speed #4)).

Title	Function	Adjustment range	Setting value
$F118$	Input terminal selection #8 (S4)	0 ~ 135	18 (Jog run)

Note) During jog run, Low-speed signal may be output but not RCH signal, and PID control is disabled.

6.10 Jump frequency - Jumping resonant frequencies

- F270** : Jump frequency #1
- F271** : Jump frequency band #1
- F272** : Jump frequency #2
- F273** : Jump frequency band #2
- F274** : Jump frequency #3
- F275** : Jump frequency band #3

• Function

These parameters are used to jump resonant frequencies to avoid resonance with the natural frequency of the mechanical equipment operated. In jump mode, the motor exhibits hysteresis with respect to the jump frequency.

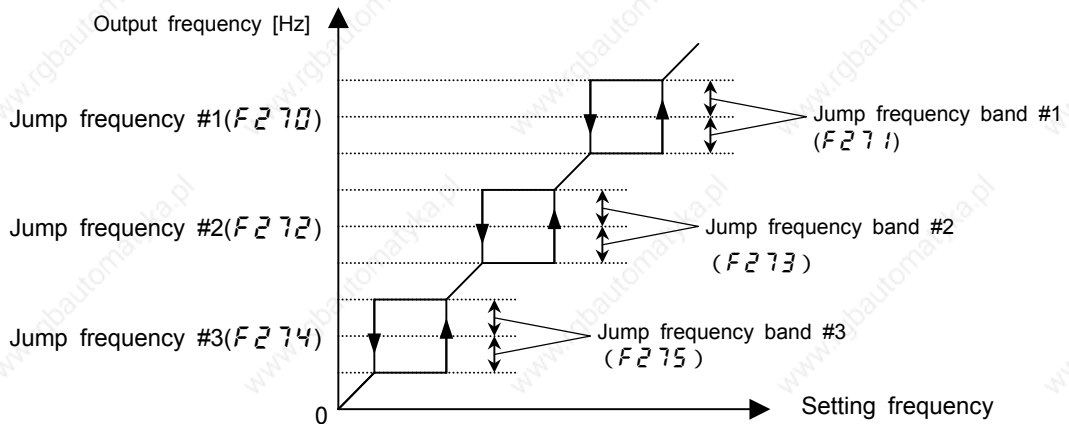

[Parameter setting]

Title	Function	Adjustment range	Default setting
F270	Jump frequency #1	0.0 ~ FH	0.0
F271	Jump frequency band #1	0.0 ~ 30.0	0.0
F272	Jump frequency #2	0.0 ~ FH	0.0
F273	Jump frequency band #2	0.0 ~ 30.0	0.0
F274	Jump frequency #3	0.0 ~ FH	0.0
F275	Jump frequency band #3	0.0 ~ 30.0	0.0

If the upper limit frequency (UL) is within a jump frequency range, it is limited to the lowest frequency in the jump frequency range.

If the lower limit frequency (LL) is within a jump frequency range, it is limited to the highest frequency in the jump frequency range.

Do not overlap the upper limit frequency (UL) and the lower limit frequency (LL) within a jump frequency range. If they overlap, it is operated lowest jump frequency.

Do not overlap two or more jump frequency ranges, or it cannot be operated within normal range.

The operation frequency is not jumped during acceleration or deceleration.

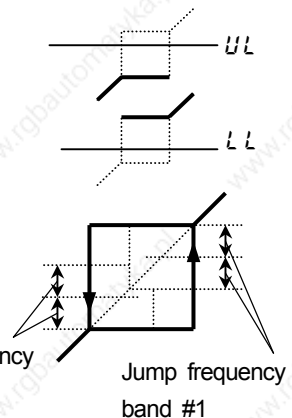

6.11 Preset-speed #8 ~ 15

F287 ~ F294 : Preset-speed #8 ~ #15

Refer to 5.14 for details.

6.12 PWM carrier frequency

F300 : PWM carrier frequency

• Function

- 1) The sound tone of acoustic noise can be changed by adjusting the PWM carrier frequency. This adjustment is effective in preventing the motor from resonating with its load(machine) or its fan cover.
 - 2) Decreasing the carrier frequency is also effective in reducing electromagnetic.
- Note) Decreasing the carrier frequency reduces electromagnetic noise but increases acoustic noise.

[Parameter setting]

Title	Function	Adjustment range	Default setting
F300	PWM carrier frequency	0.5 ~ 15.0(8.0, 5.0) [kHz>(*1) [Upper limits differ by applicable motor capacity. Refer to the table below.]	Model dependent

(*1)Setting the PWM carrier frequency larger than the default value, reduction of rated current is needed. For details, refer to figure and table below.

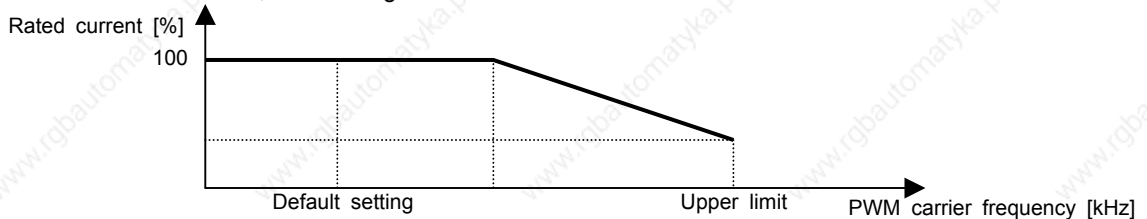

Voltage class [V]	Applicable motor capacity [kW]	PWM carrier freq. [kHz]		Rated current at upper limit [%]	Max value, no rated current reduction is needed [kHz]
		Default setting	Upper limit		
200	18.5	12	15	No need of rated current reduction	
	22	12	15	90	12
	30	12	15	93	12
	37	8	15	No need of rated current reduction	
	45	8	15	80	8
	55	2.2	8	85	3
	75, 90, 110	2.2	5	No need of rated current reduction	
400	18.5	12	15	No need of rated current reduction	
	22	12	15	90	12
	30	12	15	89	12
	37	8	15	70	8
	45	8	15	80	11
	55	8	15	65	8
	75	2.2	8	70	4
	90	2.2	5	75	2.2
	110 ~ 220	2.2	5	80	2.2
	280	2.2	5	75	2.2
315	2.2	5	70	2.2	

Note1) In vector control mode, set the carrier frequency to 2.2 [kHz] or over. Operation may become unstable if the carrier frequency is lower than 2.2 [kHz].

Note2) In the case that the operation frequency is more than 130Hz, carrier frequency is limited to less than 10kHz automatically.

Note3) Set the carrier frequency to 2.2kHz when sine wave filter (LFL,LFC)is used at output side of inverter. Filter can be damaged by fire in the case of other than 2.2kHz

6.13 Trip-less enhancement

6.13.1 Auto-restart (restart during free-run (coast))

F301 : Auto-restart

F314 : Auto-restart mode

F312 : Auto-restart adjustment #1

F315 : Auto-restart adjustment #3

F313 : Auto-restart adjustment #2



Warning



Mandatory

- Do not get near the motor or the machine.
The motor and the machine unexpectedly restart after recovery from a momentary power failure, which might cause injury to persons.
- Stick caution labels to the inverter, the motor and the machine, to prevent accidents due to an unexpected restart of them after recovery from a momentary power failure.

• Function

Auto-restart detect the rotating speed and direction of rotation of the motor during coasting or momentary power failure, to ensure that the motor restarts smoothly (Motor speed search function). With this parameter, you can also switch from commercial power operation to inverter operation without stopping the motor.

When this function is being performed, "rErY" is displayed.

Step 1: Set the control method of Auto-restart

1) Restart after a momentary power failure

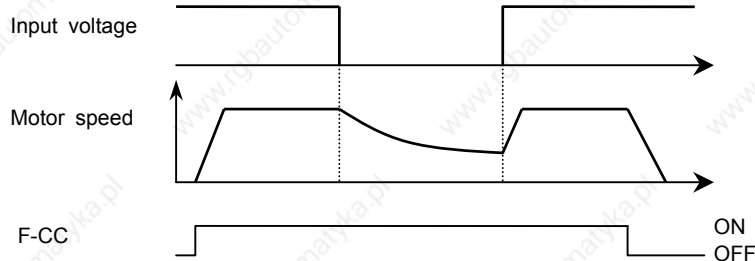

$F301=1$: This function is performed when the inverter recovers from a momentary power failure after under-voltage of the main circuit and the control circuit).

Title	Function	Adjustment range	Default setting	Setting value
$F301$	Auto restart (Motor speed search)	0 : Disabled 1 : Enabled(at power failure) 2 : Enabled(at ST ON/OFF) 3 : Enabled($1 + 2$)	0	1 or 3

* This function is performed in retry mode regardless of the setting of this parameter.

* The function ($F301=1,2,3$) is activated when the reset of trip or the control power is turned on.

* The function ($F301=1,3$) is activated when a voltage is detected in the main circuit.

2) Restart of coasting motor (Motor speed search function)

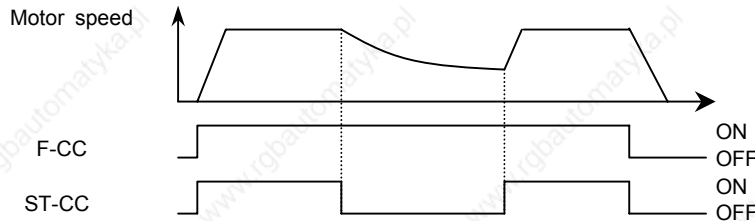

$F301=2$: This function is performed when ST-CC are OFF and then connected again.

Title	Function	Adjustment range	Default setting	Setting value
$F301$	Auto restart (Motor speed search)	0 : Disabled 1 : Enabled(at power failure) 2 : Enabled(at ST ON/OFF) 3 : Enabled($1 + 2$)	0	2 or 3

To restart the inverter in control panel operation mode, press the RUN key after a power failure.

When $F358$ (Number of PG input phases) is set at 1 (single phase) in PG feedback vector control mode ($Pt=8$), the inverter may trip ($E-13$: speed error) if the direction of rotation of the motor does not agree with.

Step 2: Set the mode of Auto-restart

[Parameter setting]

Title	Function	Adjustment range	Default setting
$F314$	Auto-restart mode (When Pt is set at 8 or 9 , set this parameter at 0 .)	0 : Speed search #1 (*1),(*2),(*3) 1 : Restart at coasted frequency #1 (*3) 2 : Restart at coasted frequency #2 (*3) 3 : Speed search #2 (*2),(*3) 4 : Special method	Model dependent

(*1),(*2),(*3): Refer to inside of box in the next page.

: This setting is for special usage. Do not set at this.

[Adjustment value]

0 : Speed search #1

VF-P7 searches the motor speed and restarts. It detects the motor speed also at the time of a power supply injection. This method needs setting of motor constant parameters. Activation of zero speed motor needs waiting times.

1 : Restart at coasted frequency #1

It starts from the frequency, when coast started in instant electric power failure, ST terminal OFF, etc... Usual starting is performed at the time of a power supply injection and after PFFF(Control circuit insufficient voltage) detection, at the time of a trip reset.

2 : Restart at coasted frequency #2

It starts from the frequency, when coast started in instant electric power failure, ST terminal OFF, etc. It starts on setting frequency (speed reference frequency) at the time of a power supply injection and after PFFF(Control circuit insufficient voltage) detection, at the time of a trip reset.

At the case where inverter-commercial change sequence is performed, and the case where the motor is always rotating at the time of starting, selecting this method and setting frequency that corresponds motor speed make it smooth operation.

3 : Speed search #2

This setting is used for the models 37kW or more. Do not set it as F314=3 for other models. If it is set as F314=3 from a model 30kW or less, since the rotational frequency of a motor is normally undetectable, there is a possibility that trips, such as an over-current, overload, and an over-voltage, may occur. The rotational speed and the rotation direction of a motor are searched It searches also at the time of a power supply injection. The time taken to detect the rotational speed of a motor becomes short as compared with the speed search #1.

Use at factory default setting (18.5~30(37)kW:F314=0 37(45)~315kW:F314=3). The setting F314=1,2 is for short time starting without speed searching to save waiting times(*1). It may give the machine load of torque momentarily so use it carefully

Caution!

By using retry function F303 together, auto restart function can be actuated at the time of tripping.

Adaptation for elevator applications

The load may go down in the waiting time after operation start signal is inputted until it starts. When you apply an inverter to an elevator, make the setting as F301=0. And do not use the retry function.

In the case the auto restart function does not work

When a trip occur at the time of auto restart, or auto restart function does not work well, please adjust parameters referring to step 3.

(*1)Case F314=0

For the sake of motor speed detection after the power restoration, there are following waiting times(longest time) at time of auto restart.

Type of inverter	waiting times (longest time) [s]
VFP7-2185P ~ 2300P , 4185P ~ 4370P	About 4

When the auto restart function is selected, the this function is actuated also at time of activation of motor and at the first operation after the reset of tripping. The operation will restart after the waiting time passes.

Before using the auto restart function, be sure to confirm the setting value of the motor constant parameters;F402~F404, F410~F412.

If the wrong setting value is used, motor speed cannot be searched and tripping accident such as over-current, overload, over-voltage, etc. can occur.

In the case of the combination with a motor smaller two or more frames than inverter rated capacity, this function may be unable to detect the rotational speed of the motor.

You cannot use a smaller capacity motor for check of operation etc., please be careful.

Even when the auto restart function is selected, motor speed may not be detected if the frequency is more than 60[Hz]. In this case, tripping accident such as over-current, overload, over-voltage, etc. can occur.

If the motor is idle state and motor-load is light, the motor may rotate a little. Be careful.

Step 3: Set the property of Auto-restart

1) Case $F314=0$

[Parameter setting]

Title	Function	Adjustment range	Default setting
$F312$	Auto-restart adjustment #1	0.50 ~ 2.50	Model dependent
$F313$	Auto-restart adjustment #2	0.50 ~ 2.50	Model dependent

Example of setting) In the case adjustment value is 1.0, set at 1.1 ~ 1.2 and check the property. Notice that in this case, waiting time for the restart grows to 110 ~ 120[%]. If it cannot be adjusted at setting $F312$, $F313$, reset the range of $F403$ (motor constant #2) at 20~30% lower.

2) Case $F314=1\sim3$

[Parameter setting]

Title	Function	Adjustment range	Default setting
$F315$	Auto-restart adjustment #3	0 : Fast(0.5[s])(with a small inertia application) 1 : Normal(1.0[s]) $2\sim8$: 1.5 ~ 4.5[s] 9 : Slow(5.0[s])	Model dependent

This parameter adjusts the rising time of motor torque at time of restarting. Adjust this parameter to inertia moment of the load.

6.13.2 Regenerative power ride-through control / Deceleration stop

$F302$: Regenerative power ride-through control / Deceleration stop

$F310$: Ride-through time / Deceleration time

• Function

1) Regenerative power ride-through control

When instant electric power failure occurs during operation, this function makes operation continue using the regeneration energy from a motor.

2) Deceleration stop

When instant electric power failure occurs during operation, this function stops the motor quickly compulsorily. A forcible stop is carried out in $F310$ (Deceleration time) using the regeneration energy from the motor. (Deceleration time changes with control.) After a compulsive stop, it maintains a stop state until operation instruction is once turned off.

[When power is shut off]

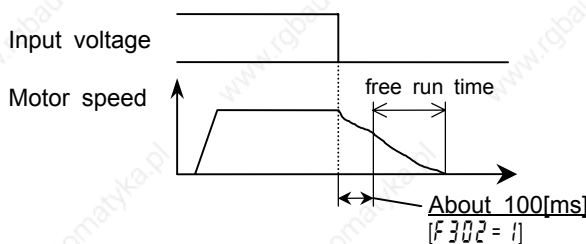

[When power fails momentarily]

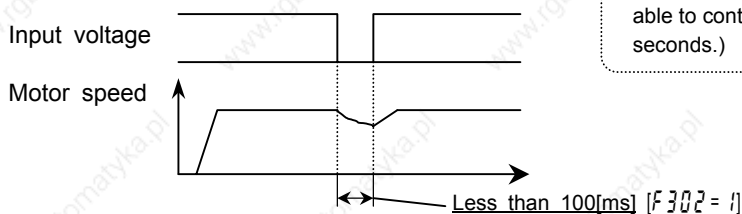

The time for which the motor keeps running varies with the inertial of the machine operated and the loading conditions. So, conduct a test to determine the time before using this function. Using this function in conjunction with the retry function enables the inverter to restart without making a fault stop.

The power ride-through control ($F302=1$) is exercised for about 100 [ms]. (An inverter which Applicable Motor capacity is 22kW or less is able to continue to control the motor a few seconds.)

[Parameter setting]

Title	Function	Adjustment range	Default setting
$F302$	Regenerative power ride-through control / Deceleration stop	0 : OFF 1 : ON (Regenerative power ride-through control) 2 : ON (Deceleration stop)	0
$F310$	Ride-through time / Deceleration time	0.0 ~ 320.0 [s]	2.0



Note) Even if these functions are used, a motor may free run according to load conditions. In this case, please use the auto restart function together.

Note) These functions do not operate at the time of torque control or position control.

Note) Usual slowdown time comes at the time of notes $F302=2$ and $F310=0.0$.

6.13.3 Retry function

F303 : Retry selection

 Warning	
 Mandatory	<ul style="list-style-type: none"> • Do not get near the alarm-stopped motor and machine. When the inverter is in retry mode, the alarm-stopped motor and machine unexpectedly restart when the predetermined time has passed, and thus might cause you to get an injury. • Stick caution labels to the inverter, the motor and the machine, to prevent accidents due to an unexpected restart of them because of the retry function.

• Function

The inverter automatically resets itself when it has tripped. During a retry, according to the setting of **F314** (Auto-restart mode selection) the inverter automatically restarts and this function makes smooth motor activation possible.

[Parameter setting]

Title	Function	Adjustment range	Default setting
F303	Retry selection	0: Disabled, 1 ~ 10 times	0

Causes of tripping and retry process

Cause of tripping	Retry process	Canceling conditions
Momentary power failure Over-current Over-voltage Overload	a maximum of 10 consecutive retries 1st retry : about 1 [s] after tripping 2nd retry: about 2 [s] after tripping 3rd retry : about 3 [s] after tripping ... 10th retry : about 10 [s] after tripping	Retry is canceled if the inverter trips again for reasons other than a momentary power failure, over-current, over-voltage or overload, or if the inverter fails to restart within the predetermined number of retries.

Kinds of trips can be retried

• OC1,2,3 : Over-current	• OL1 : Overload of inverter	• OH : Over heat
• OC1P,2P,3P : Over-current of DC injection	• OL2 : Overload of motor	
• OP1,2,3 : Over-voltage	• OLr : Overload of braking resistor	

No retry is performed if the inverter trips for the following reasons:

- **OCRA1,2,3**: Arm short circuit
- **EPH1** : Phase failure(input side)
- **EPHO** : Phase failure(output side)
- **OCL** : Loaded side over-current at start time
- **EF1,EF2** : Ground-fault
- **E** : Emergency stop
- **EPE1** : EEPROM error
- **Err2** : Main RAM error
- **Err3** : Main ROM error
- **Err4** : CPU fault
- **Err5** : Interruption communication error
- **Err6** : Gate array fault
- **Err7** : Output current detector error
- **Err8** : Optional unit fault
- **Err9** : Flash memory fault
- **E-10** : Sink/source switching error
- **E-13** : Speed error (Over speed)
- **E-17** : Key error
- Others (other than the above)

During a retry, the fault detection relay (FLA, B and C) is not active.

A virtual cooling time is set for trips due to an overload (**OL1,OL2,OLr**). Therefore, a retry is performed after a virtual cooling time and the retry time have passed.

In the case of a trip due to an over-voltage (**OP1~OP3**), the inverter may trips again unless the voltage in its D.C. section falls enough.

In the case of a trip due to overheating (**OH**), the inverter may trip again unless the temperature inside it falls enough; the inverter monitors the temperature in it.

A retry is performed if **F303** is set enabled, even if the trip holding selection parameter **F602** is set at 1.

During a retry, **rEr4** and the value selected with the status monitor selection parameter **F710** are displayed alternately.

6.13.4 Dynamic (regenerative) braking - To urgently stop the motor

F304 : Dynamic braking mode selection

F308 : Dynamic braking resistance

F309 : Dynamic braking resistor capacity

• Function

Dynamic braking is used in the following cases:

- 1) need to stop the motor quickly.
- 2) The inverter trips because of an over-voltage (OP) during deceleration.
- 3) Fluctuation of load condition causes a regenerative power even at a constant speed such as press machine.

[Parameter setting]

Title	Function	Adjustment range	Default setting
F304	Dynamic braking mode selection	0: Disabled 1: Enabled/overload detection enabled	Model dependent
F308	Dynamic braking resistance	1.0 ~ 1000 []	
F309	Dynamic braking resistor capacity	0.01 ~ 600.0 [kW]	

Default settings vary from model dependent. Refer to 6.13.4-4).

Protection level is defined by **F626**(Refer to 6.13.5).

Note 1) While dynamic braking is in operation, "P" blink is displayed at left side of the monitor. (It is not an error.) The blink starts at achieving **F626**(over-voltage stall protection level / dynamic braking protection level).

Note 2) In the case of oscillating of monitor or taking long time at deceleration, set **F305**(over-voltage stall protection) = 1.

Note 3) When using braking unit(PB3), set **F304**(dynamic braking mode selection) = 0, and **F305**(over-voltage stall protection) = 1.

a) External braking resistor (with a thermal fuse) (optional)

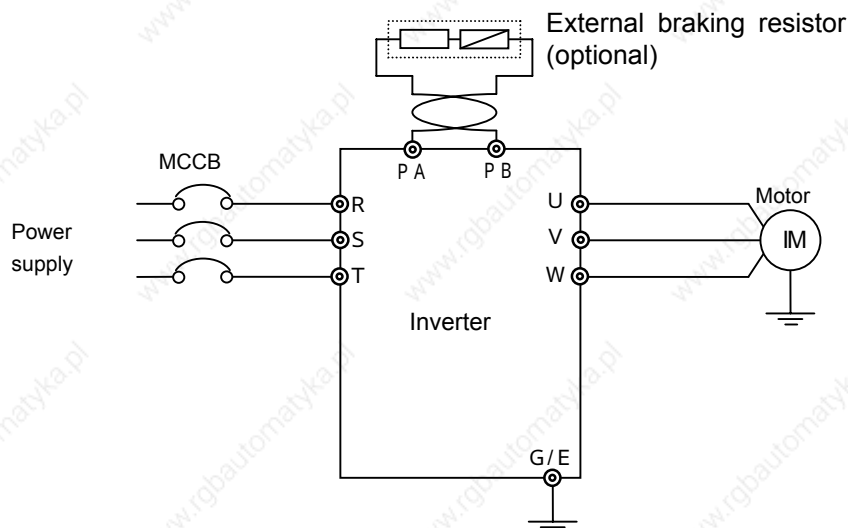

[Parameter setting]

Title	Function	Adjustment range	Setting value
F304	Dynamic braking mode selection	0: Disabled 1: Enabled/overload detection enabled	1

b) When using a braking resistor without thermal fuse

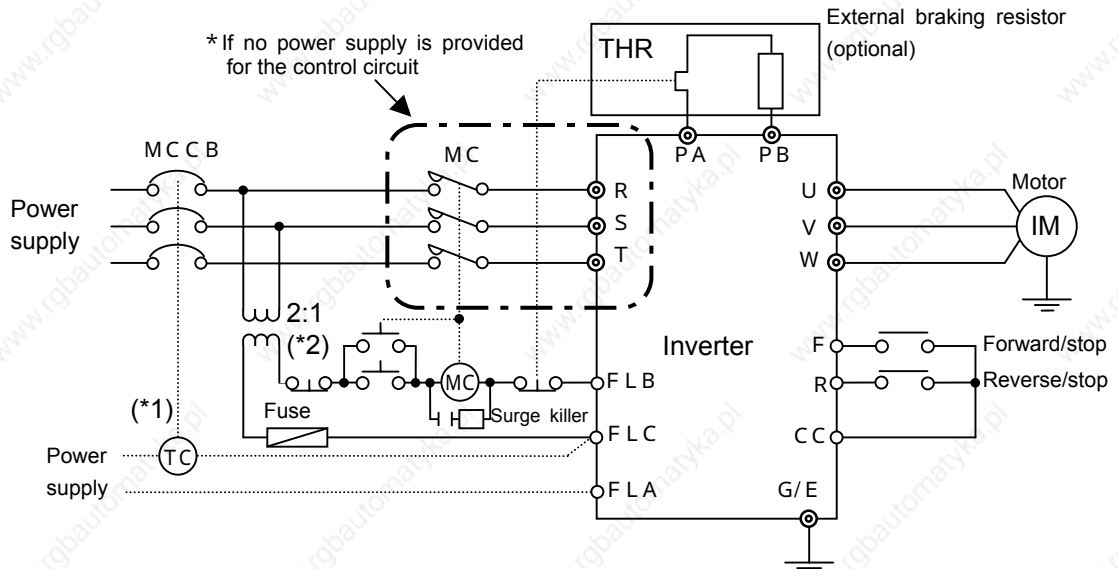

* If no power supply is provided for the control circuit

(*1) Connection when using an MCCB with a top coil instead of an MC.

(*2) A step-down transformer is required for 400V models but not for 200V models.

[Parameter setting]

Title	Function	Adjustment range	Setting value
F304	Dynamic braking mode selection	0: Disabled 1: Enabled with over load detection	1
F308	PBR resistor	1.0 ~ 1000 []	Any value (*3)
F309	PBR resistor capacity	0.01 ~ 600 [kW]	Any value (*3)

(When the standard internal braking resistor option is not used, be sure to set the parameters F308 and F309 properly for overload protection.)

(*3) F309 is for overload protection of our optional PBR and PBR3 type. Please consider the protection at external thermal for DGP type.

A thermal relay (THR) must be connected as the last resort for fire prevention in case a failure occurs in the overload and over-current protective functions provided for the inverter to protect the braking resistor. Select and connect a thermal relay (THR) with a capacity (watt) commensurate with that of the braking resistor used.

- Caution -

In the above circuit, the MC in the main circuit is turned off if an inverter's protective function is activated, and consequently no trip message is displayed. The inverter recovers from a trip if it is turned off. So, check the trip history record after turning off the inverter and then on again. (Refer to 8.1.)

To prevent a trip condition from being cleared by turning off the power and then on again, change the setting of the inverter trip retention selection parameter F602. (Refer to 6.25.3)

* Control power unit option (22kW or less)

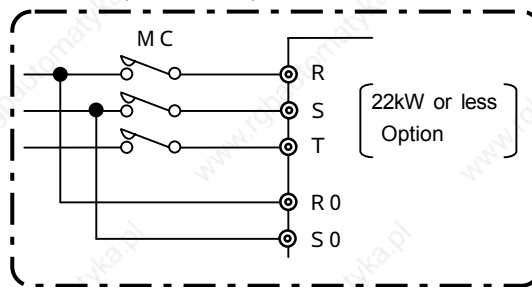

In a circuit where a control power supply is connected to RO and SO, when the MC in the main circuit is turned off when a trip is occurred, trip data is saved so that trip messages can be displayed (FL output also is retained.) For optional control power supply units, refer to 9.4.

When using a custom braking resistor, be sure to select a braking resistor with a resistance larger than the minimum admissible resistance. Refer to 4 on the next page for the minimum admissible resistance.

3) Selection of braking resistor option and braking unit

Model	braking resistor option / braking unit	
	Type form	Rating
VFP7-2185P	PBR3-2150	220[W] - 30[] × 4P (880[W] - 7.5[])
VFP7-2220P	PBR3-2220	220[W] - 27[] × 8P (1760[W] - 3.3[])
VFP7-2300P	PB 3-2300	200[W] - 5[] × 3P2S (1200[W] - 3.3[])
VFP7-2370P ~ 2550P	PB 3-2550	200[W] - 5[] × 5P2S (2000[W] - 2[])
VFP7-2750P ~ 2110KP (*3)	DGP600W-B1	3.4[kW] - 1.7[]
VFP7-4185P	PBR3-4150	220[W] - 120[] × 4P (880[W] - 30[])
VFP7-4220P	PBR3-4220	220[W] - 30[] × 4P2S (1760[W] - 15[])
VFP7-4300P ~ 4370P	PB 3-4300	200[W] - 20[] × 3P2S (1200[W] - 13.3[])
VFP7-4450P ~ 4900P	PB 3-4550	200[W] - 20[] × 5P2S (2000[W] - 8[])
VFP7-4110KP ~ 4160KP (*3)	DGP600W-B2	7.4[kW] - 3.7[]
VFP7-4200KP ~ 4220KP (*3)	DGP600W-B3	8.7[kW] - 1.9[]
VFP7-4280KP ~ 4315KP (*3)	DGP600W-B4	14[kW] - 1.4[]

(*1) The values in () are the total resistor capacities (watt) and resistances () of braking resistors.

(*2) Type form PBR3- : Braking resistor (Connected to PA, PB terminal.)

PB3- : Braking unit ([Braking resistor + Braking resistor drive circuit] are installed. Connected to PA, PC terminal.)

DGP600W-B : Braking resistor (Connected to PA, PB terminal.)

(*3) To use braking resistor(DGP600 series), installing a braking resistor drive circuit option is needed.

4) Connectable braking resistors and their minimum resistances

The table below lists externally-connectable braking resistors and their minimum admissible resistances. Do not connect any braking resistor with a resistance (total resistance) smaller than the minimum resistance admissible for it.

Applicable motor capacity [kW]	200V class		400V class	
	Standard option []	minimum resistance []	Standard option []	minimum resistance []
18.5	7.5	5	30	20
22	3.3	3.3	15	13.3
30	3.3	3.3	13.3	13.3
37	2	1.7	8	13.3
45	2	1.7	8	6.7
55	2	1.7	8	5
75	1.7	1.3	8	3.3
90	1.7	1	3.7	3.3
110	1.7	1	3.7	2.5
132	-	-	3.7	2.5
160	-	-	1.9	2.5
200	-	-	1.9	1
220	-	-	1.9	1
280	-	-	1.4	1
315	-	-	1.4	1

6.13.5 Avoiding over-voltage trip

- F305** : Over-voltage stall protection
- F625** : Over-voltage stall protection level (high response)
- F626** : Over-voltage stall protection level

• Function

The functions automatically keep constant or increase the output frequency to prevent tripping due to over-voltage in the DC bus during deceleration or constant-speed run. When the over-voltage stall protection is active, it may take longer than the deceleration time.

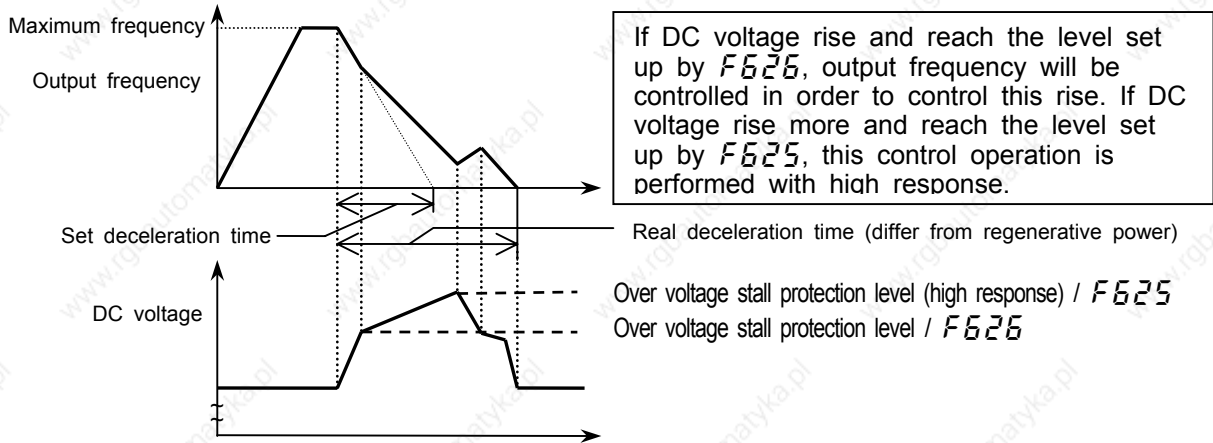

[Parameter setting]

Title	Function	Adjustment range	Default setting
F305	Over-voltage stall protection	0: Enabled, 1: Disabled, 2: Enabled (forced quick deceleration)	0
F625	Over-voltage stall protection level (high response)	50 ~ 250 [%]	135
F626	Over-voltage stall protection level	50 ~ 250 [%]	130

*F626 serves also as the level of dynamic (regenerative) braking operation.(Refer to 6.13.4)

6.13.6 Adjusting the output voltage and voltage compensation

- F306** : Voltage of base frequency(output voltage adjustment)
- F307** : Selection of base frequency voltage(voltage compensation)

• Function

Voltage of base frequency (output voltage adjustment)

This parameter set the base frequency ωL voltage. And this parameter can make it so that no voltage exceeding the F306 value is put out. (This function is active when F307 is set 2 or 3.)

Selection of base frequency voltage (voltage compensation)

The function keeps the V/f ratio constant for prevention of torque drop at low speeds even when the input voltage drop.

Voltage compensation... The V/f ratio is kept constant even at input voltage fluctuation.

Voltage limitation ... The output voltage is limited to F306. If the voltage compensation function is disabled, no limitation is imposed to the output voltage.

[Parameter setting]

Title	Function	Adjustment range	Default setting
F306	Base frequency voltage #1 (output voltage adjustment)	0.0 ~ 600.0 [V]	200.0 [V] 1400.0 [V]
F307	Base frequency voltage (voltage compensation)	0: without voltage compensation(limitless output voltage) 1: with voltage compensation(limitless output voltage) 2: without voltage compensation(limited output voltage) 3: with voltage compensation(limited output voltage)	1

If F307 is set at 0 or 2, the output voltage varies with the input voltage.

The output voltage does not exceed the input voltage, even if the base frequency voltage (F306) is set above the input voltage.

The ratio of the voltage to the frequency can be adjusted to the motor capacity. Setting **F307** at **3** enables the inverter to prevent the output voltage from increasing with the input voltage when the operation frequency is higher than the base frequency.

[**F307**=0: no voltage compensation/not limited]

[**F307**=1: voltage compensation/not limited]

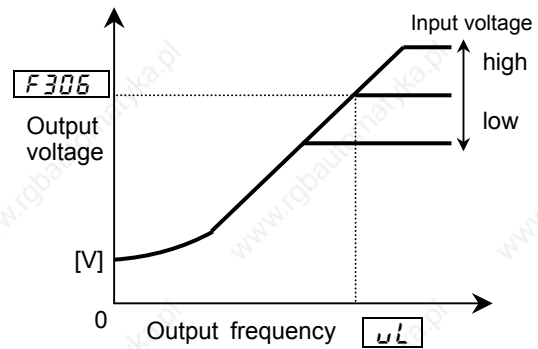
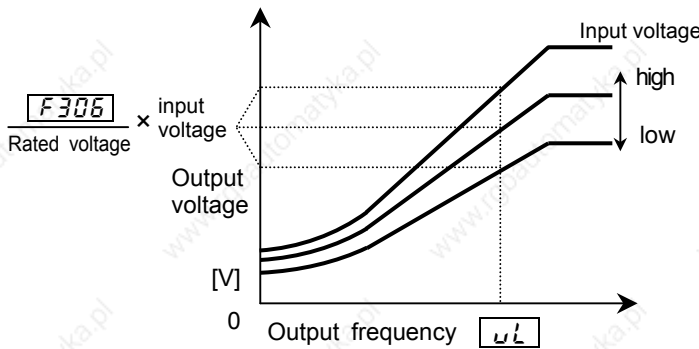

* $Pt = 0, 1, 6$

$\frac{F306}{\text{Rated voltage}} > 1$: no voltage higher than the input voltage is put out.

*The output voltage can exceed **F306** if the output frequency is higher than the base frequency ##, even when **F306** is lower than the input voltage.

[**F307**=2: no voltage compensation/limited]

[**F307**=3: voltage compensation/limited]

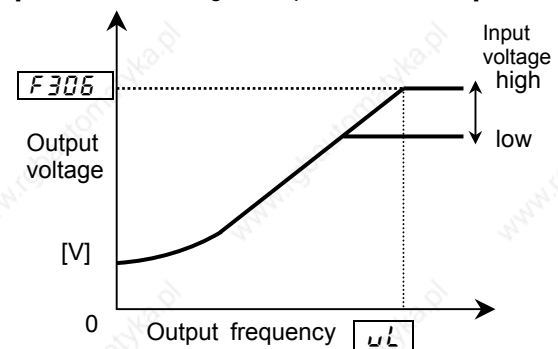
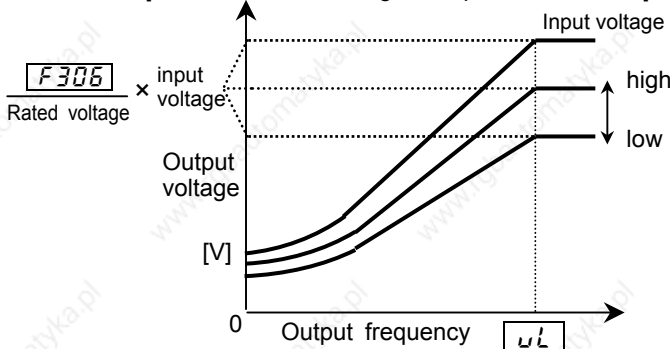

* $Pt = 0, 1, 6$

$\frac{F306}{\text{Rated voltage}} > 1$, no voltage higher than the input voltage is put out.

6.13.7 Prohibiting the reverse operation

F311 : Reverse-run prohibition

• Function

The function prevents the direction of operation from being reversed in case an incorrect operation signal is given.

[Parameter setting]

Title	Function	Adjustment range	Default setting
F311	Reverse-run prohibition	0: Permitted, 1: Reverse run prohibited 2: Forward run prohibited, 3: Direction designated by command permitted(*1)	0

(*1): Top priority is given to the command specifying the direction of rotation (forward run or reverse run command). In preset-speed operation mode or forced jog run mode, you can prevent the motor from rotating in the opposite direction to that specified by the forward run or reverse run command.

Caution!

- This parameter is invalid in positioning mode. In addition, if the motor runs in a prohibited direction in preset-speed mode or forced jog run, operation commands become invalid irrespective of the control mode.
- If the motor constant is not set optimally in vector-control, automatic-torque boost mode, the motor may slightly run in reverse direction because of the slip frequency. Before using this parameter, set parameter **F243** (stop frequency) at a frequency close to the slip frequency. When the inverter is in sensor vector control mode ($Pt = 8$ and $F368 = 2$), depending on the setting of **F301**, the motor may rotate in the opposite direction to that prohibited when it is turned off and then on again, regardless of the setting of this parameter.

6.14 Drooping control

- F320** : Drooping gain
- F321** : Speed at a drooping gain 0%
- F322** : Speed at the drooping gain **F320**
- F323** : Drooping insensitive torque band
- F324** : Output filter for drooping

• Function

When operating a single load with more than one inverter and one motor, these parameters distribute the load to the inverters. These parameters can adjust the frequency range, the insensitive torque band and gains.

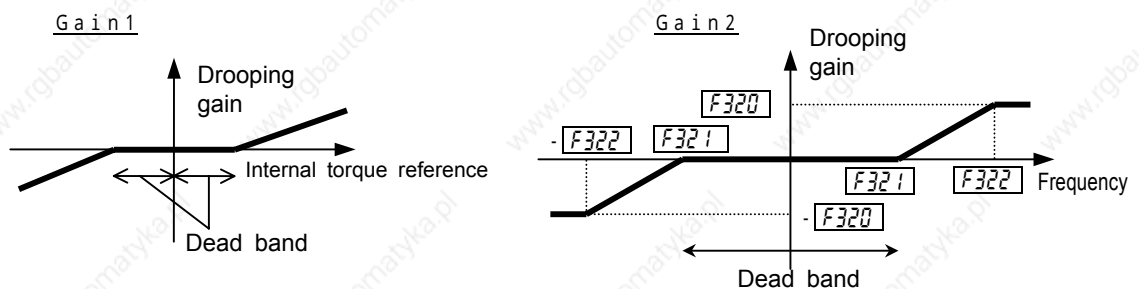

[Parameter setting]

Title	Function	Adjustment range	Default setting
F320	Drooping gain	0 ~ 100 [%]	0
F321	Speed at a drooping gain 0[%]	0 ~ 320.0 [Hz]	60.0
F322	Speed at the drooping gain F320	0 ~ 320.0 [Hz]	60.0
F323	Drooping insensitive torque band	0 ~ 100 [%]	10
F324	Output filter for drooping	0.1 ~ 200.0 [rad/s]	100.0

- When torque larger than the dead band torque is applied, the frequency is decreased (during power running) or increased (during regenerative braking).
- Drooping takes effect within the frequency range above the frequency set with **F321**.
- In the frequency range between **F321** and **F322**, the drooping rate varies with the torque.

The change in the frequency during drooping can be calculated as described below.

a) Gain by internal torque reference (Gain 1)

If internal torque reference [%] 0

$$\text{Gain1} = (\text{internal torque reference} - \text{dead band } \boxed{\text{F323}}) / 100$$

Gain 1 needs to be set at 0 or a positive number.

If internal torque reference [%] < 0

$$\text{Gain1} = (\text{internal torque reference} + \text{dead band } \boxed{\text{F323}}) / 100$$

Gain 1 needs to be set at 0 or a negative number.

b) Gain by frequency after acceleration (Gain 2)

If $\boxed{\text{F321}} < \boxed{\text{F322}}$

| Frequency after acceleration | Frequency 1 set with $\boxed{\text{F321}}$

$$\text{Gain2} = 0$$

| Frequency after acceleration | > Frequency 2 set with $\boxed{\text{F322}}$

$$\text{Gain2} = \text{Drooping gain } \boxed{\text{F320}} / 100$$

$$\text{If frequency 1 } \boxed{F321} < | \text{ frequency after acceleration } | \text{ frequency 2 } \boxed{F322}$$

$$\text{Gain2} = \frac{\text{Drooping gain } \boxed{F320}}{100} \times \left\{ \frac{(| \text{freq. after acceleration } | - \text{freq.1 } \boxed{F321})}{(\text{freq.2 } \boxed{F322} - \text{freq.1 } \boxed{F321})} \right\}$$

If $\boxed{F321} \quad \boxed{F322}$

If | frequency after acceleration | frequency 1 $\boxed{F321}$

Gain2 = 0

If | frequency after acceleration | > frequency 1 $\boxed{F321}$

Gain2 = Drooping gain $\boxed{F320}$ / 100

c) Drooping speed

Drooping speed = base frequency \boxed{UL} ^{Note} × Gain1 × Gain2

Note) For this calculation, assume the base frequency to be 100 Hz if it is higher than 100 [Hz].

6.15 Function for crane/hoist

- $\boxed{F330}$: Light-load high-speed operation
- $\boxed{F331}$: Light-load high-speed operation switching lower limit frequency
- $\boxed{F332}$: Light-load high-speed operation load waiting time
- $\boxed{F333}$: Light-load high-speed operation load detection time
- $\boxed{F334}$: Light-load high-speed operation heavy load detection time
- $\boxed{F335}$: Switching load torque current during forward run
- $\boxed{F336}$: Heavy load torque during acceleration in forward direction
- $\boxed{F337}$: Heavy load torque during fixed speed in forward direction
- $\boxed{F338}$: Switching load torque current during reverse run
- $\boxed{F339}$: Heavy load torque during acceleration in reverse direction
- $\boxed{F340}$: Heavy load torque during fixed speed in reverse direction
- $\boxed{F341}$: Automatic light-load high-speed operation frequency

6.16 Commercial power/inverter switching

- $\boxed{F354}$: Output signal selection of commercial power/inverter switching
- $\boxed{F355}$: Commercial power/inverter switching frequency
- $\boxed{F356}$: Inverter side switching waiting time
- $\boxed{F357}$: Commercial power side switching waiting time
- $\boxed{F358}$: Commercial power switching frequency holding time

• Function

The function switches between the commercial power and the inverter operation without stopping the motor in case of tripping or by sending a signal, and also to transmit switching signals to an external sequence (MC, etc).

[Parameter setting]

Title	Function	Adjustment range	Default setting
F 354	Output signal selection of commercial power/inverter switching	0: OFF 1: Automatic switching in case of trip 2: Commercial power switching frequency setting enabled 3: Both (1 + 2)	0
F 355	Commercial power/inverter switching frequency	0 ~ FH [Hz]	60.0
F 356	Inverter side switching waiting time	[Model dependent] ~ 10.0 [s]	Model dependent
F 357	Commercial power side switching waiting time	0.37 ~ 10.00 [s]	0.62
F 358	Commercial power switching frequency holding time	0.1 ~ 10.0 [s]	2.0

(*1)The trips which is followed by automatic switching are trips other than OCL, EF 1, EF 2 and E.

[Timing chart]

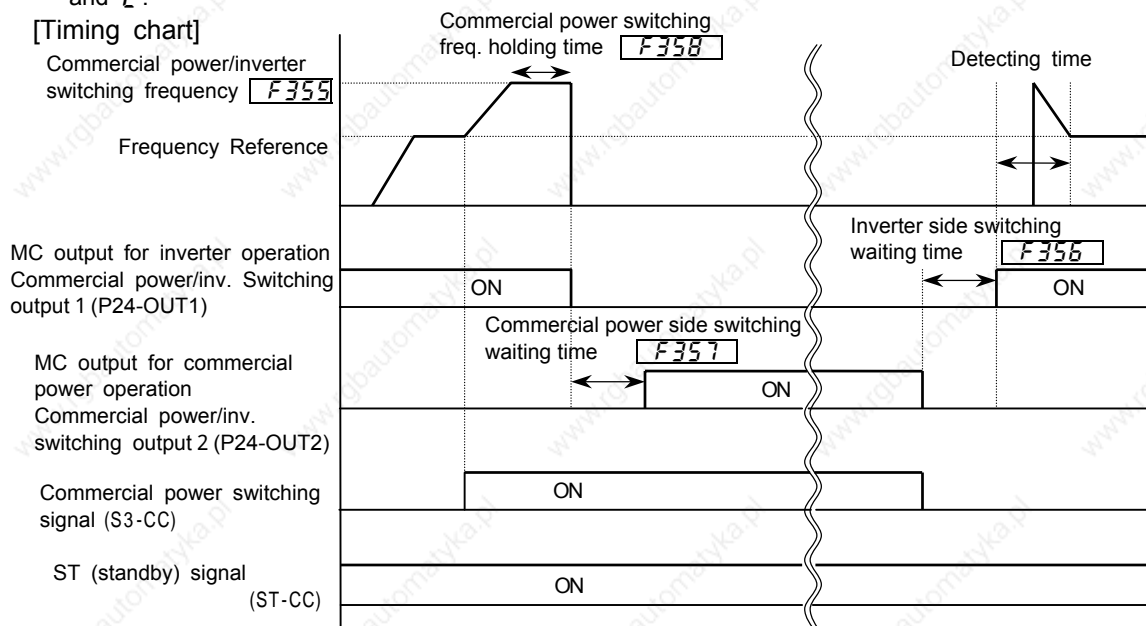

Commercial power switching signal S3-CC ON : Commercial power operation

Commercial power switching signal S3-CC OFF : Inverter operation

Note) If ST-CC is opened, switching cannot be operated normally

Title	Function	Adjustment range	Setting value
F 354	Output signal selection of commercial power/inverter switching	0 ~ 3	2 or 3
F 355	Commercial power/inverter switching frequency	0 ~ FH [Hz]	Power source frequency, etc.
F 356	Inverter side switching waiting time	[Model dependent] ~ 10.0 [s]	Model dependent
F 357	Commercial power side switching waiting time	0.37 ~ 10.00 [s]	0.62
F 358	Commercial power switching frequency holding time	0.1 ~ 10.0 [s]	2.0
F 117	Input terminal selection #7 (S3)	0 ~ 135	102: (Commercial power /inverter switching)
F 130	Output terminal selection #1 (OUT1)	0 ~ 119	46: (Commercial power /inverter switching output #1)
F 131	Output terminal selection #2 (OUT2)	0 ~ 119	48: (Commercial power /inverter switching output #2)

Caution!

- Before switching to the commercial power, make sure that, when the motor takes power directly from the commercial power, it rotates in the forward direction as defined for operation by the inverter.
- Do not set the Reverse-run prohibition parameter F 3 1 1 at 2 or 3 that forward run may be prohibited. These settings make it impossible to switch the inverter to the forward run position, and thus to switch from the inverter to the commercial power.

6.17 PID control

F360	: Signal selection of PID control
F361	: Delay filter
F362	: Proportional (P) gain
F363	: Integral (I) gain
F364	: PID deviation upper limit
F365	: PID deviation lower limit
F366	: Differential (D) gain

6.18 Speed feedback/positioning control

F367	: Number of PG input pulses
F368	: Number of PG input phases
F369	: PG disconnection detection
F370	: Electronic gear
F371	: Position loop gain
F372	: Positioning completion range
F373	: Frequency limit at position control
F374	: Current control proportional gain
F375	: Current control integral gain
F376	: Speed loop proportional gain
F377	: Speed loop integral gain
F378	: Motor counter data selection
F379	: Speed loop parameter ratio

6.19 Preset speed operation mode

F380 ~ **F395** : Preset speed operation modes

Refer to 5.14 for details.

6.20 Setting motor constants

F400	: Auto-tuning	F410	: Motor constant #5
F401	: Slip frequency gain	F411	: Number of motor poles
F402	: Motor constant #1	F412	: Rated capacity of motor
F403	: Motor constant #2	F413	: Motor type
F404	: Motor constant #3	F414	: Auto-tuning prohibition
F405	: Motor constant #4		

Warning

 Mandatory	<ul style="list-style-type: none"> Do not set the motor parameter #3(Exciting inductance: F404) less than or equal to a half of default value. If the motor parameter #3(Exciting inductance: F404) was set at a extremely small value, stall prevention function would work and output frequency would rise.
---	--

When using the vector control or the automatic torque boost, it is necessary to set (tuning) motor constants. You can set motor constants by any of the following three methods.

After setting by one of three methods, drive the motor.

- 1) Using the automatic V/f mode setting (**RU2**) to make the setting of the motor control mode selection (**Pt**) and the auto-tuning parameter (**F400**) at a time
- 2) Setting the motor control mode (**Pt**) and the auto-tuning parameter (**F400**) individually
- 3) Setting the motor control mode (**Pt**) and setting motor constants manually

<Note> If tuning error (**Err**) occurs when the power is turned on, set the motor type **F413** at 4 (others).

[Selection 1: Setting by the automatic V/f mode]

This is the simplest way of setting. With the automatic control parameter, you can set the automatic torque boost, the sensorless vector control and the auto-tuning parameter at a time.

Automatic V/f mode **RU2 = 1 (Automatic torque boost + auto-tuning)**

Automatic V/f mode **RU2 = 2 (Sensorless vector control + auto-tuning)**

Automatic V/f mode **RU2 = 3 (Automatic energy-saving + auto-tuning)**

Refer to 5.2 for details of this setting.

[Selection 2: Individually setting the vector control and the auto-tuning]

This is the method for individually setting the vector control and the auto-tuning. You need to set the control mode with the motor control mode selection **Pt**, before auto-tuning setting.

Set the auto-tuning **F400 = 2 (Automatic tuning execution)**

[Parameter setting]

Title	Function	Adjustment range	Default setting
F400	Auto-tuning	0 : Without auto-tuning (internal table) 1 : Motor constant initialization (0 after execution) 2 : Automatic tuning execution (0 after execution)	0

Here are the setting conditions for each type of motor.

Applicable motor			Auto-tuning
Type	motor poles	Capacity	
Toshiba standard motor	4P	Same capacity as the inverter	Not required
		Different capacity from the inverter	
	others	Same capacity as the inverter	Required
		Different capacity from the inverter	
Other motors			

[Setting procedure]

Key operated	LED display	Operation
	0.0	The running frequency is displayed. (Make this setting when the motor is out of operation.) (If the monitor display mode setting parameter <i>F 7 10</i> is set at 0 [Running frequency])
(MON)	<i>RU 1</i>	Press the Monitor key to call up the first basic parameter <i>RU 1</i> (automatic acceleration/deceleration).
○	<i>F 4 - -</i>	Select the parameter <i>F 4 - -</i> (extended parameters of 400 to 499) by pressing Δ or \square key.
(ENT)	<i>F 4 0 0</i>	Press the Enter key to activate the parameter <i>F 4 0 0</i> .
(ENT)	0	Press the Enter key to display the parameter setting.
○	2	Change the parameter setting to 2 (Automatic tuning execution) by pressing Δ key.
(ENT)	2 <i>F 4 0 0</i>	Press the Enter key to save the change. Then, <i>F 4 0 0</i> and the set value are displayed alternately.

Cautions in setting the auto-tuning parameter

Connect the motor before auto-tuning. Do not proceed to auto-tuning before the motor comes to a full stop. If the auto-tuning function is activated immediately after stopping motor, it sometimes fails to work normally because of a residual voltage.

A voltage is applied to the motor during auto-tuning, though it is too low to rotate the motor. Usually, auto-tuning terminates in some dozens of seconds. If an error occurs, however, the inverter trips (display *E L n*) and no motor constant is set.

The auto-tuning is incapable of tuning special motors, such as high-speed or a high slip motors. When using such a motor, set motor constants manually as described in Section 3.

If auto-tuning causes the inverter to trip easily because of an over-voltage *OP* or an over-current *OC*, change the setting of the load inertia moment parameter *F 4 0 5*. Refer to the Step 2 for the adjustment of *F 4 0 5*.

When the inverter is used for a crane/hoist, equip it with a protective device (mechanical brake, etc.) with a sufficient capacity. Failure to do so might cause the crane/hoist to loose speed and fall because the motor cannot produce sufficiently large torque during auto-tuning.

When operating a motor in vector control mode, set the carrier frequency at 2.2 kHz or over. Failure to do so might cause the vector control to be unstable.

If auto-tuning cannot be made successfully or an auto-tuning error (*E L n*) occurs, set the motor constants manually as described in Selection 3 below.

Notes about vector control: Refer to 5.10 9)

[Selection 3: Individually setting the vector control and the manual tuning]

If a tuning error *E L n* occurs during auto tuning or the sensorless vector control characteristic needs to be improved, you may set motor constants individually.

Title	Function	Adjustment range	Default setting
<i>F 4 1 1</i>	Number of motor poles	2, 4, 6, 8, 10, 12, 14, 16	4
<i>F 4 1 2</i>	Rated capacity of motor	0.1 ~ [Model dependent] [kW]	Model dependent
<i>F 4 1 3</i>	Motor type	0: Toshiba standard motor #1 (*1) 1: Toshiba VF motor 2: Toshiba V3 motor 3: Toshiba standard motor #2 (*1) 4: Other motors	0

(*1) Toshiba standard motor 1: World-energy series of totally-enclosed fan-cooled motors

Toshiba standard motor 2: World-energy 21 series of totally-enclosed fan-cooled motors

Step 1: Setting the rating of the motor

Check the motor for use. (pole number, rating capacity, type)	
Number of motor poles: F411 Adjustment range / 2, 4, 6, 8, 10, 12, 14, 16	Motor type: F413 Adjustment range / 0: Toshiba standard motor #1 1: Toshiba VF motor 2: Toshiba V3 motor 3: Toshiba standard motor #2 ...
Rated capacity of motor: F412 Adjustment range / 0.1 ~ 280 [kW]	

0: Toshiba standard motor #1
 1: Toshiba VF motor
 2: Toshiba V3 motor
 3: Toshiba standard motor #2

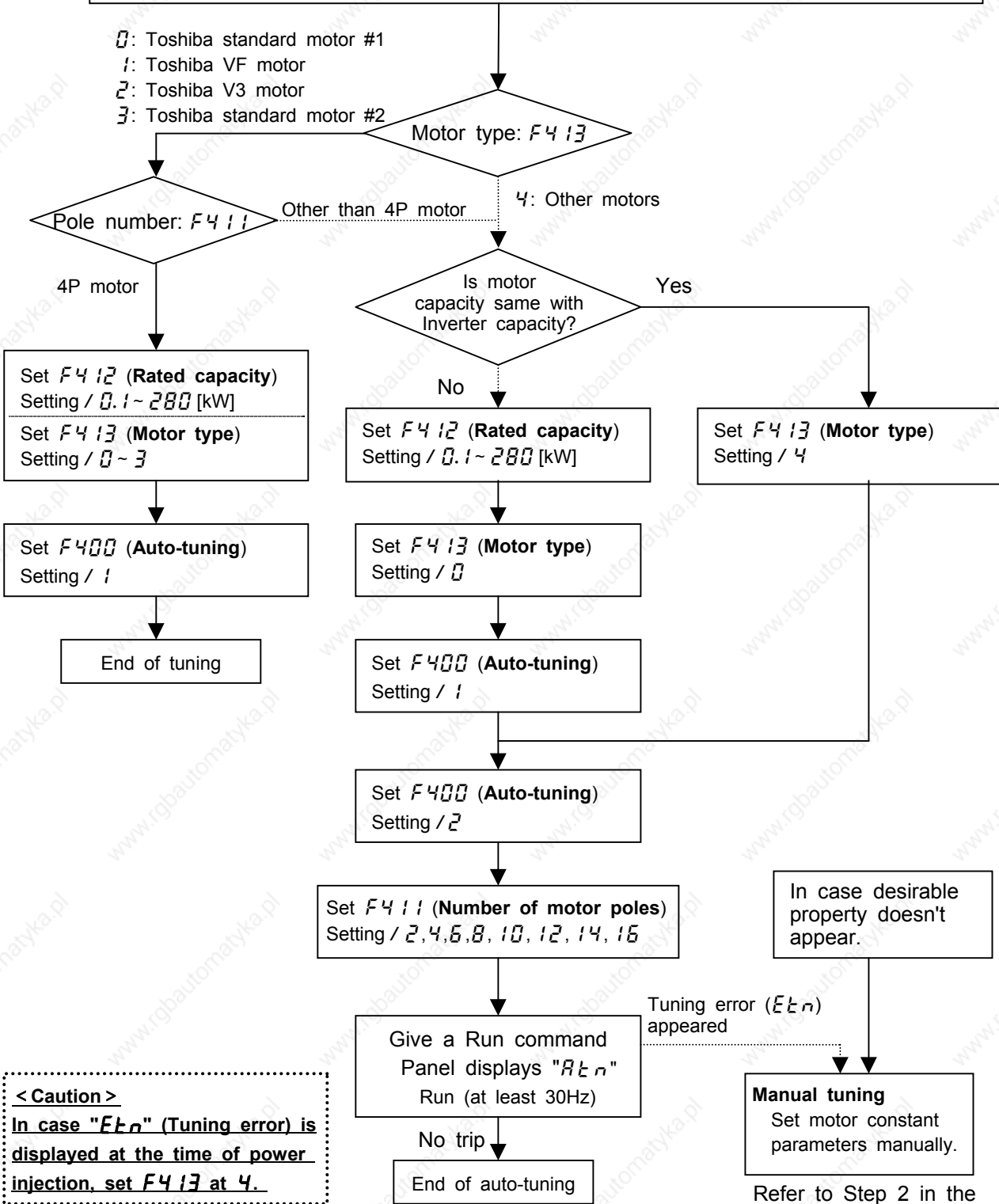

< Caution >
 In case "Etn" (Tuning error) is displayed at the time of power injection, set F413 at 4.

Step 2: Setting motor constants

This section describes how to set motor constants. Select the items to be improved and change the related motor constants.

Slip frequency gain *F401*

This parameter is to adjust the slippage of the motor.

Setting this parameter at a larger number can reduce the slippage of the motor. However, setting it at an excessively large number may result in hunting, etc., and thus cause an unstable operation.

Motor constant #1 *F402* (Primary resistance) (Motor test reports may be useful.)

This parameter is to adjust the primary resistance of the motor.

Setting this parameter at a larger value can prevent the drop of the motor torque in low speed ranges due to a voltage drop. However, setting it at an excessively large number may result in large current in low speed range and appearance of overload trip, etc..

Motor constant #2 *F403* (Secondary resistance)

This parameter is to adjust the secondary resistance of the motor.

The larger the set value, the more the slippage of the motor can be compensated.

Motor constant #3 *F404* (Exciting inductance)

(A motor test record can be used for this setting.)

This parameter is to adjust the exciting inductance of the motor.

The larger the set value, the more the no-load current can be decreased.

Motor constant #4 *F405* (Load inertia moment)

This parameter is to adjust the transient response of the motor.

Setting this parameter at a larger value can reduce overshooting on completion of acceleration or deceleration. Set this parameter at a value, which matches to the effective moment of inertial.

Motor constant #5 *F410* (Leak inductance) (Motor test reports may be useful.)

This parameter is to adjust the leakage inductance of the motor.

The larger the set value, the larger torque the motor can be produced in high-speed ranges.

Examples of setting auto-tuning

Here are setting examples for each of the selections 1, 2 and 3 described in 6.20.

a) Combination with a Toshiba standard motor (4P motor with the same capacity as the inverter)

Inverter : VFP7 - 2185P

Motor : 18.5[kW], 4P, 60[Hz]

[Selection 1]

Set the automatic V/f mode setting parameter *AU2* at *2*.

[Selection 2]

Set the motor control mode selection parameter *Pt* at *3* (Sensorless vector control).

[Selection 3]

Set the motor control mode selection parameter *Pt* at *3* (Sensorless vector control).

b) Combination with a Toshiba VF motor (4P motor with the same capacity as the inverter)

Inverter : VFP7 - 2185P

Motor : 18.5[kW], 4P, 60[Hz]

[Selection 1]

Set the automatic V/f mode setting parameter *AU2* at *2*.

[Selection 2]

1) Set the motor control mode selection parameter *Pt* at *3* (Sensorless vector control).

2) Set the auto-tuning *F400* at *2*.

[Selection 3]

1) Set the motor control mode selection parameter *Pt* at *3* (vector control).

2) Change the motor type *F414* from *0* (Toshiba standard motor) to *1* (Toshiba VF motor).

(When using a Toshiba VF motor with a rated capacity smaller than that of the inverter, properly change the setting of the motor rated capacity parameter *F412*.)

3) Set the auto-tuning *F400* at *1*.

c) Combination with a standard motor other than the above Toshiba motors

Inverter : VFP7 - 2185P

Motor : 15[kW], 4P, 50[Hz]

[Selection 1]

Set the automatic V/f mode setting parameter *AU2* at *2*.

[Selection 2]

1) Set the motor control mode selection *Pt* at *3* (Sensorless vector control).

2) Set the auto-tuning parameter *F400* at *2*.

[Selection 3]

1) Set the motor control mode selection *Pt* at *3* (Sensorless vector control).

2) Change the motor rated capacity parameter *F412* from *18.50* to *15.00*

3) Set the motor type parameter *F413* at *0* (default setting)

4) Set *F400* at *1*

5) Set *F400* at *2*

6) Set the motor pole number parameter *F411* at *2*

7) Change the motor parameters (*F401*~*F405*, *F410*), if needed.

6.21 Torque control

Refer to 5.11 for switch to Torque control

6.21.1 Torque reference

F420 : Torque reference selection	
F429 : Torque reference mode selection	
F205 : VI/II reference point #1 rate	F201 : VI/II reference point #1
F206 : VI/II reference point #2 rate	F203 : VI/II reference point #2
F214 : RR reference point #1 rate	F210 : RR reference point #1
F215 : RR reference point #2 rate	F212 : RR reference point #2
F220 : RX reference point #1 rate	F216 : RX reference point #1
F221 : RX reference point #2 rate	F218 : RX reference point #2
F232 : BIN reference point #1 rate	F228 : BIN reference point #1
F233 : BIN reference point #2 rate	F230 : BIN reference point #2
F725 : Panel torque reference (Refer to 6.29.11 for details.)	

• Function

Selecting a mode of torque command in torque control mode.

1) Current signal 4 ~ 20mA

II terminal

[Default setting]

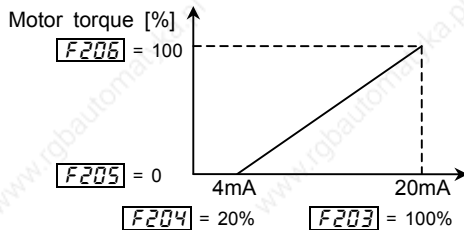

- Torque produced: 0% at 4mA and 100% at 20mA.

[Arbitrary setting]

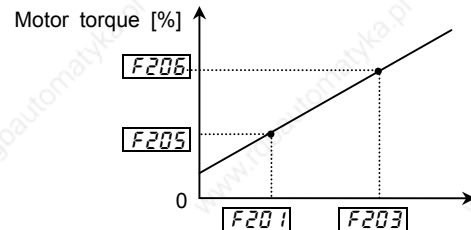

The relationship between the torque command and the motor torque can be changed. The **F201** and **F203** settings 0 and 100% correspond to currents of 0 and 20mA, respectively.

2) Voltage signal 0 ~ 10Vdc

RR terminal

[Default setting]

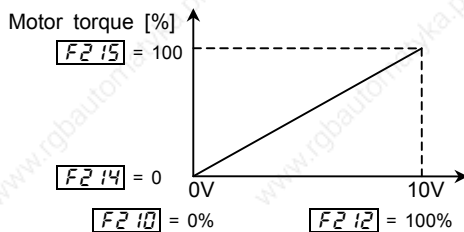

- Torque produced: 0% at 0V and 100% at 10V.

[Arbitrary setting]

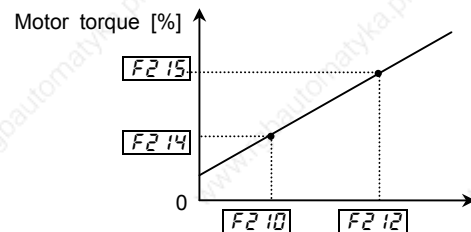

The relationship between the torque command and the motor torque can be changed. The **F210** and **F212** settings 0 and 100% correspond to voltages of 0 and 10V, respectively.

3) Voltage signal 0 ~ ± 10Vdc RX terminal

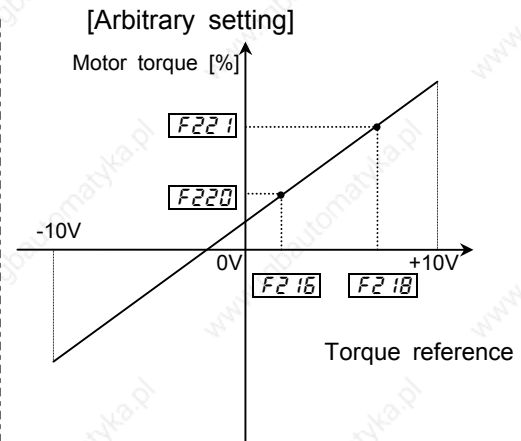
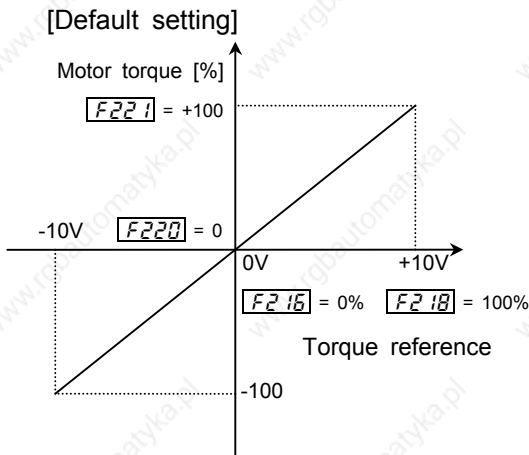

- Motor torque: -100% at -10Vdc, 0% at 0Vdc and +100% at +10Vdc.

The relationship between the torque command and the motor torque can be changed. The $F215$ and $F218$ settings 0 and +/-20% correspond to voltages of 0 and +/-10Vdc, respectively.

[Parameter setting]

Title	Function	Adjustment range	Default setting
$F420$	Torque reference selection	1: V/I 2: RR 3: RX 4: RX2(option) 5: Panel input 6: Binary / BCD input(option) 7: Common serial communication option(FA30) 8: Serial communication RS485(FA32) 9: Communication add-on cassette option(FA33)	3

Note1) Selecting 5 (Panel input) activates the control panel torque reference $F725$.

Note2) Use 2 phases input type sensor when torque control is operated by vector control with a sensor.

Note3) For sensorless vector control, "forward power running reverse regeneration" and "forward regeneration reverse power running" cannot be operated. Use vector control with a sensor (2 phases) for these uses.

6.21.2 Torque reference filter

$F421$: Torque reference filter

• Function

When a motor drives a load with large inertia or when the gain cannot be increased because the machine is not rigid enough to allow it, the motor sometimes vibrates. In such cases, this filter is used to reduce the vibration. The smaller the set value, the larger effect the filter can exert. (The response of the motor decreases to reduce the vibration.)

Title	Function	Adjustment range	Default setting
$F421$	Torque reference filter	10.0 ~ 199.9, 200.0(without filter)	200.0 (without filter)

6.21.3 Speed limits in torque control mode

- F425** : Forward speed limit input selection
- F426** : Forward speed limit input level
- F427** : Reverse speed limit input selection
- F428** : Reverse speed limit input level
- F430** : Speed limit (torque=0) reference
- F431** : Speed limit (torque=0) value
- F432** : Speed limit (torque=0) band
- F433** : Speed limit (torque=0) recovery time

• Function
 The function is to limit the rise in the output frequency of the inverter due to a drop of the load torque during operation in torque control mode. These functions are useful for protecting a machine.

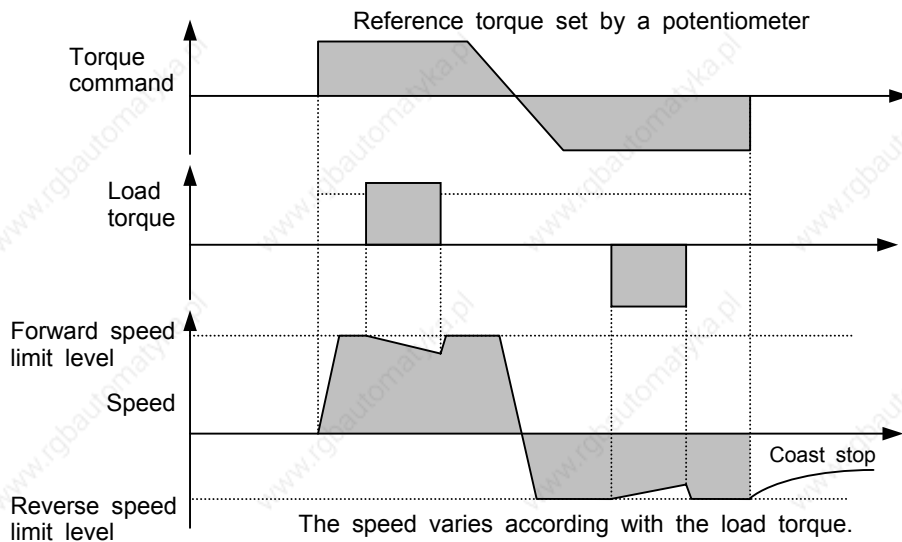

Setting with the control panel

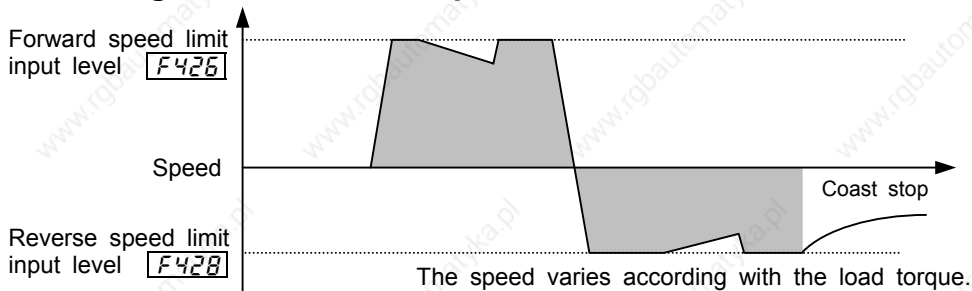

[Setting of forward speed limit level]

- F425**(Forward speed limit input selection) :5 (Parameter **F426**)
- F426**(Forward speed limit input level) :Set a desirable torque limit level.

[Setting of reverse speed limit level]

- F427**(Reverse speed limit input selection) :5 (Parameter **F428**)
- F428**(Reverse speed limit input level) :Set a desirable torque limit level.

Setting by means of external signals

The speed limits can be changed arbitrarily by setting external signals.

[Selection of external signals]

F425, F427

voltage signals	—	RR-CC	0 ~ 10V	2
		RX-CC	0 ~ ±10V	3
		VI-CC	0 ~ 10V	1
current signals	—	II-CC	4(0) ~ 20mA	1

Title	Function	Adjustment range	Default setting
F425	Forward speed limit input selection	0: Invalid 1: VI (voltage input)/II (current input) 2: RR (voltage/voltage input) 3: RX(voltage input) 4: RX2(voltage input)(optional) 5: F426 enabled	0
F426	Forward speed limit input level	0.0 ~ UL [Hz]	80.0
F427	Reverse speed limit input selection	0: Disabled 1: VI (voltage input)/II (current input) 2: RR (voltage/voltage input) 3: RX(voltage input) 4: RX2 (voltage input)(optional) 5: F428 enabled	0
F428	Reverse speed limit input level	0.0 ~ UL [Hz]	80.0

[Speed limit with the center value specified by a reference]

Title	Function	Adjustment range	Default setting
F430	Speed limit (torque=0) reference	0:Invalid, 1:VI/II, 2:RR, 3:RX, 4:RX2(optional), 5: F431	0
F431	Speed limit (torque=0) value	0.0 ~ FH [Hz]	0.0
F432	Speed limit (torque=0) band	0.0 ~ FH [Hz]	0.0
F433	Speed limit (torque=0) recovery time	0.00 ~ 2.50	0.20

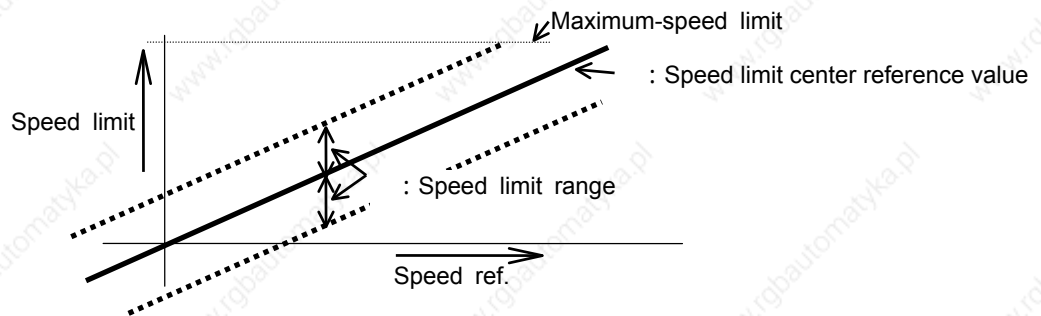

6.21.4 Torque bias and load sharing gain

F422 : Selection of synchronized torque bias input

F423 : Selection of tension torque bias input

F424 : Load sharing gain input selection

1) Selection of synchronized torque bias input

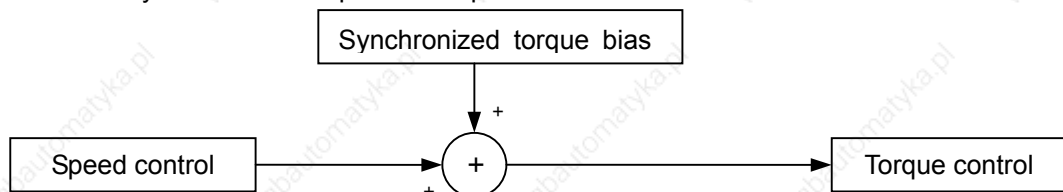

[Parameter]

Title	Function	Adjustment range	Default setting
F 422	Selection of synchronized torque bias input	0: Invalid 1: VI/II 2: RR 3: RX 4: RX2 (optional) 5: Panel input (F 725 is enabled) 6: Binary / BCD input (optional) 7: Common serial communication option(FA30) 8: Serial communication RS485(FA32) 9: Communication add-on cassette option(FA33)	0
F 726	Panel torque revised bias input	- 250 ~ 250 [%]	0

For a crane/hoist, an elevator application, as lifted up and down at controlled speeds, its direction of rotation is frequently reversed. In such cases, the load can be started smoothly, by adding load torque into the torque reference equivalent to the additional torque, when starting acceleration after releasing the brake.

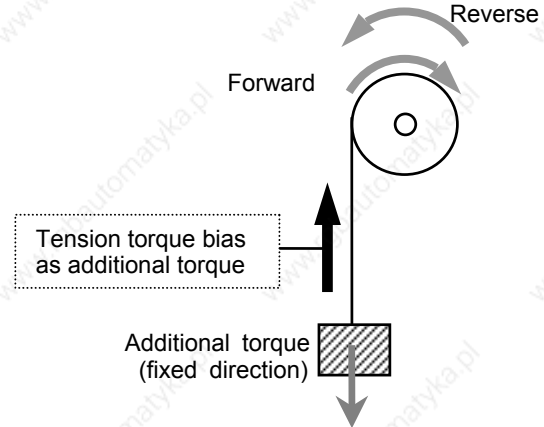

[Selection of external signals]

				F 422
voltage signals	—	RR-CC	0 ~ 10V (0 ~ 250%)	2
		RX-CC	0 ~ ± 10V (0 ~ 250%)	3
		VI-CC	0 ~ 10V (0 ~ 250%)	1
current signals	—	II-CC	4(0) ~ 20mA (0 ~ 250%)	1

2) Selection of tension torque bias input and load sharing gain input

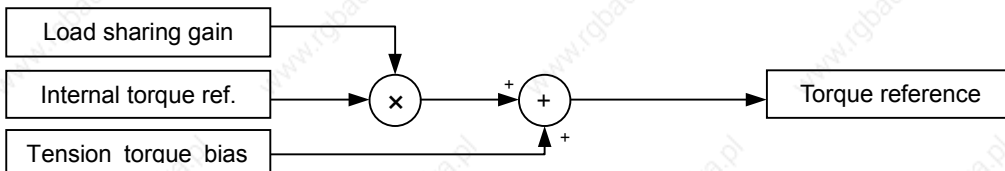

Title	Function	Adjustment range	Default setting
F 423	Selection of tension torque bias input	0: Invalid 1: VI/II 2: RR 3: RX 4: RX2 (optional) 5: Panel input (F 727 is enabled) 6: Binary / BCD input (optional) 7: Common serial communication option(FA30) 8: Serial communication RS485(FA32) 9: Communication add-on cassette option(FA33)	0
F 727	Panel tension torque bias	0 ~ 250 [%]	0
F 424	Load sharing gain input selection	0: Invalid 1: VI/II 2: RR 3: RX 4: RX2 (optional) 5: Panel input (F 728 is enabled) 6: Binary / BCD input (optional) 7: Common serial communication option(FA30) 8: Serial communication RS485(FA32) 9: Communication add-on cassette option(FA33)	0
F 728	Panel load sharing gain	0 ~ 250 [%]	100

voltage signals		RR-CC	0 ~ 10V	(0 ~ 250%)	2
		RX-CC	0 ~ ± 10V	(0 ~ 250%)	3
		VI-CC	0 ~ 10V	(0 ~ 250%)	1
current signals		II-CC	4(0) ~ 20mA	(0 ~ 250%)	1

6.22 Torque limit

- F440** : Selection of power running torque limit #1
- F441** : Power running torque limit #1
- F442** : Selection of regenerative torque limit #1
- F443** : Regenerative torque limit #1
- F444** : Power running torque limit #2
- F445** : Regenerative torque limit #2
- F446** : Power running torque limit #3
- F447** : Regenerative torque limit #3
- F448** : Power running torque limit #4
- F449** : Regenerative torque limit #4
- F450** : Torque limit mode (polarity)

• Function

The function is to decrease or increase the output frequency according to the loading condition when the motor torque reaches the limit level.
Setting a torque limit parameter at 250.0 means "Invalid".

Setting

(1) Power running /regenerative torque limit

First, you need to set the polarity of each torque limit. Set **F450** at 0.

Title	Function	Adjustment range	Setting value
F450	Torque limit mode (polarity)	0: Power running/regenerative torque limit 1: Positive/negative torque limit	0

a) limiting the torque with internal parameters (or on communication mode)

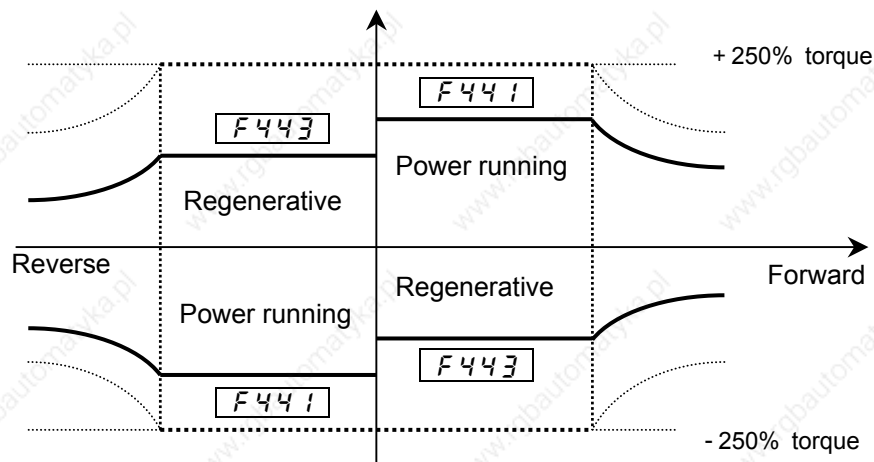

Torque limits can be set with the parameters **F441** and **F443**.

[Setting of power running torque]

F440(Selection of power running torque limit #1) :Set at 5 (**F441**)

F441(Power running torque limit #1) :Set a desirable torque limit level.

[Setting of regenerative torque]

F442(Selection of regenerative torque limit #1) :Set at 5 (**F443**)

F443(Regenerative torque limit #1) :Set a desirable torque limit level.

Parameter setting

Title	Function	Adjustment range	Default setting
<i>F440</i>	Selection of power running torque limit #1	1: VI(voltage) / II(current) 2: RR(volume / voltage) 3: RX(voltage) 4: RX2(voltage)(optional) 5: <i>F441</i>	5
<i>F441</i>	Power running torque limit #1	00~249.9[%], 2500: Invalid	250.0
<i>F442</i>	Selection of regenerative torque limit #1	1: VI(voltage) / II(current) 2: RR(volume / voltage) 3: RX(voltage) 4: RX2(voltage)(optional) 5: <i>F443</i>	5
<i>F443</i>	Regenerative torque limit #1	00~249.9[%], 2500: Invalid	250.0

With these parameters, you can set 4 patterns of positive torque limits and 4 patterns of negative torque limits. Refer to 7.2 for the setting for switching from the terminal board.

Power running torque limit #1 - <i>F441</i>	Regenerative torque limit #1 - <i>F443</i>
Power running torque limit #2 - <i>F444</i>	Regenerative torque limit #2 - <i>F448</i>
Power running torque limit #3 - <i>F446</i>	Regenerative torque limit #3 - <i>F447</i>
Power running torque limit #4 - <i>F446</i>	Regenerative torque limit #4 - <i>F449</i>

Note) If the value set with *F601* (stall prevention level) is smaller than the torque limit, then the value set with *F601* acts as the torque limit.

b) Limiting the torque with external signals

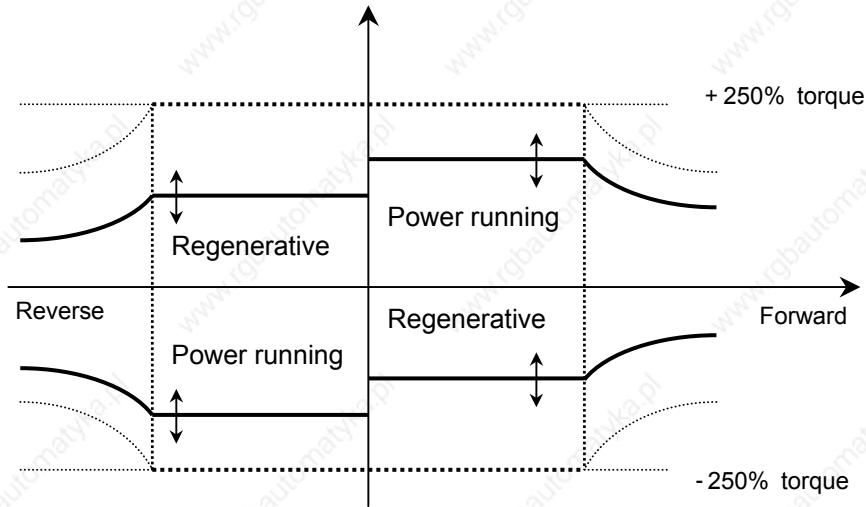

The torque limits can be changed arbitrarily by means of external signals.

[External signals]

			<i>F440, F442</i>	
Voltage signals	—	RR-CC	0 ~ 10V	2
	—	RX-CC	0 ~ ± 10V	3
Current signals	—	VI-CC	0 ~ 10V	1
	—	II-CC	4(0) ~ 20mA	1

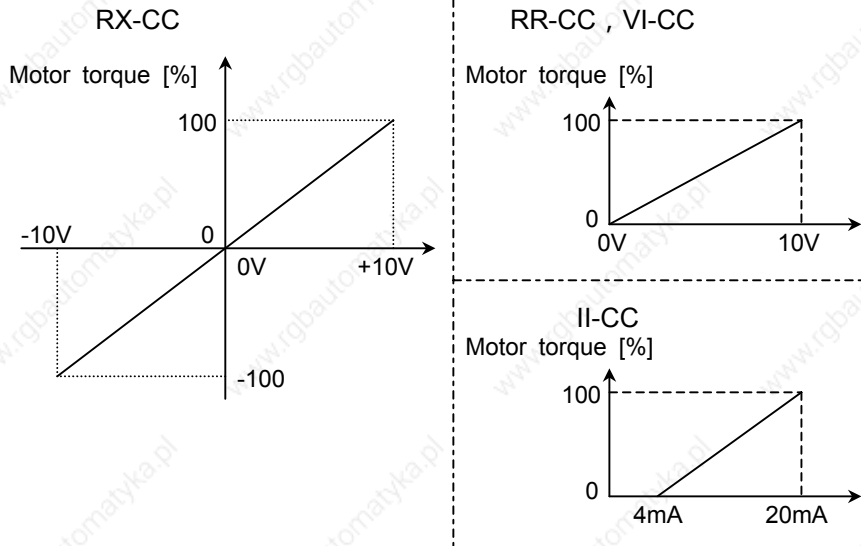

Title	Function	Adjustment range	Default setting
<i>F440</i>	Selection of power running torque limit #1	1: VI(voltage) / II(current) 2: RR(volume / voltage) 3: RX(voltage) 4: RX2(voltage)(optional) 5: <i>F441</i>	5
<i>F442</i>	Selection of regenerative torque limit #1	1: VI(voltage) / II(current) 2: RR(volume / voltage) 3: RX(voltage) 4: RX2(voltage)(optional) 5: <i>F443</i>	5

The torque limit function is active in vector control mode. In V/f constant control mode, square reduction control mode, and automatic torque boost mode, the torque limit function may not be functioned. In torque control mode, the values set with these parameters limit torque reference.

(2) Positive/negative torque limits

First, you need to set the polarity of each torque limit. Set *F450* at 1.

Title	Function	Adjustment range	Setting value
<i>F450</i>	Torque limit mode (polarity)	0: Power running/regenerative torque limit 1: Positive/negative torque limit	1

a) Limiting the torque with parameters

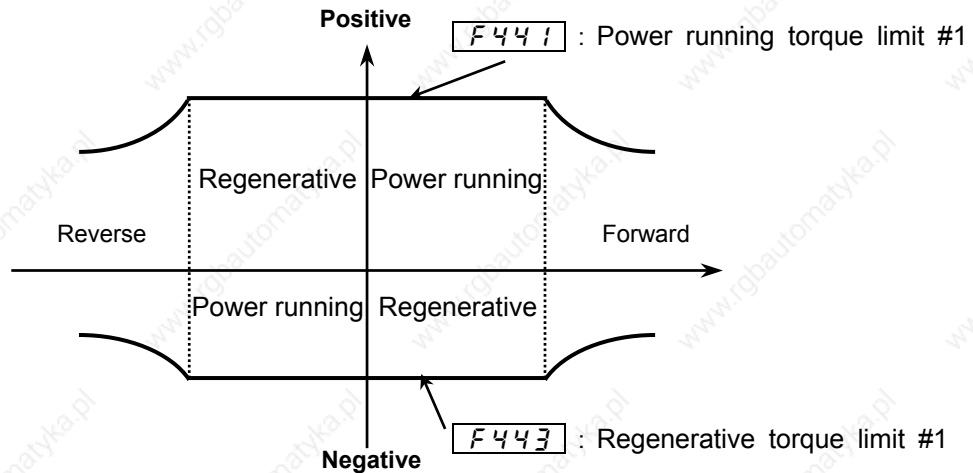

Torque limits can be set with the parameters *F441* and *F443*.

[Positive torque limit]

F440 (Selection of power running torque limit #1) :Set at 5 (*F441*)

F441 (Power running torque limit #1) :Set a desirable torque limit level.

[Negative torque limit]

F442 (Selection of regenerative torque limit #1) :Set at 5 (*F443*)

F443 (Regenerative torque limit #1) :Set a desirable torque limit level.

Parameter setting

Title	Function	Adjustment range	Default setting
<i>F440</i>	Selection of power running torque limit #1	1: VI(voltage) / II(current) 2: RR(volume / voltage) 3: RX(voltage) 4: RX2(voltage)(optional) 5: <i>F441</i>	5
<i>F441</i>	Power running torque limit #1	00~249.9[%], 2500: Invalid	250.0
<i>F442</i>	Selection of regenerative torque limit #1	1: VI(voltage) / II(current) 2: RR(volume/ voltage) 3: RX(voltage) 4: RX2(voltage)(optional) 5: <i>F443</i>	5
<i>F443</i>	Regenerative torque limit #1	00~249.9[%], 2500: invalid	250.0

With these parameters, you can set 4 patterns of positive torque limits and 4 patterns of negative torque limits. Refer to 7.2 for the setting for switching from the terminal board.

Power running torque limit #1 - <i>F441</i>	Regenerative torque limit #1 - <i>F443</i>
Power running torque limit #2 - <i>F444</i>	Regenerative torque limit #2 - <i>F445</i>
Power running torque limit #3 - <i>F446</i>	Regenerative torque limit #3 - <i>F447</i>
Power running torque limit #4 - <i>F448</i>	Regenerative torque limit #4 - <i>F449</i>

Note) If the value set with *F501* (stall prevention level) is smaller than the torque limit, then the value set with *F501* acts as the torque limit.

b) Limiting the torque with external signals

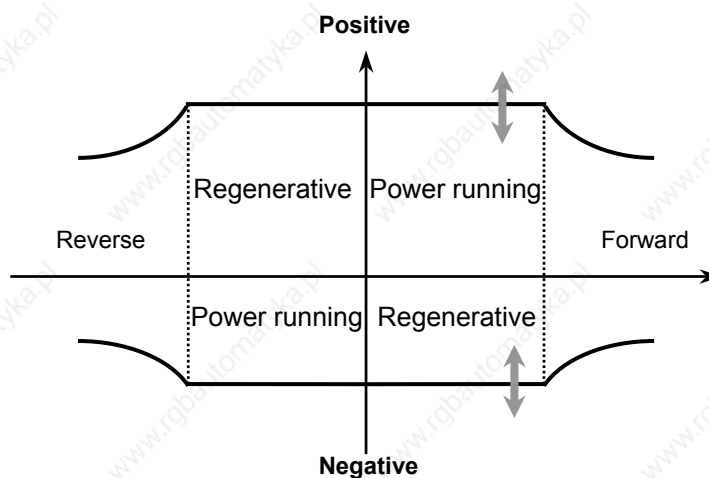

The torque limits can be changed arbitrarily by means of external signals.

[Selection of external signals]

F440, F442

Voltage signals		RR-CC	0 ~ 10V	2
		RX-CC	0 ~ ± 10V	3
		VI-CC	0 ~ 10V	1
Current signals		II-CC	4(0) ~ 20mA	1

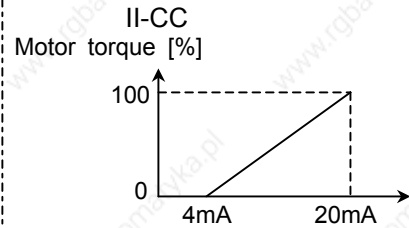
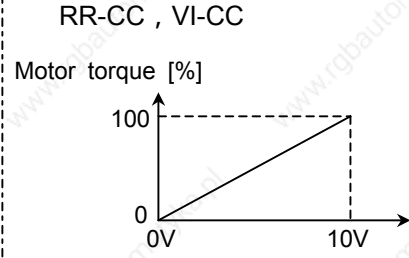
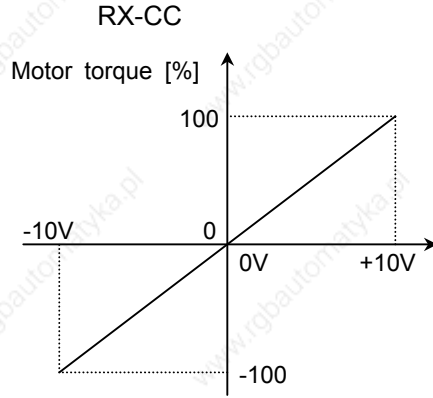

Title	Function	Adjustment range	Default setting
F440	Selection of power running torque limit #1	1: VI(voltage) / II(current) 2: RR(volume / voltage) 3: RX(voltage) 4: RX2(voltage)(optional) 5: F441	5
F442	Selection of regenerative torque limit #1	1: VI(voltage) / II(current) 2: RR(volume / voltage) 3: RX(voltage) 4: RX2(voltage)(optional) 5: F443	5

The torque limit function is active in vector control mode. In V/f constant control mode, square reduction control mode, and V/f 5-point setting mode, the torque limit function plays the same role as the stall preventive function (6.25.2).

In torque control mode, the values set with these parameters limit torque command values.

6.23 Secondary acceleration/deceleration

6.23.1 Acceleration and deceleration patterns

F502 : Acceleration/deceleration pattern #1

F506 : S-pattern lower limit adjustment amount

F507 : S-pattern upper limit adjustment amount

• Function

These parameters are used to select an acceleration pattern and a deceleration pattern.

Title	Function	Adjustment range	Default setting
F502	Acceleration/deceleration pattern #1	0: Linear, 1: S-pattern #1, 2: S-pattern #2	0
F506	S-pattern lower limit adjustment amount	0 ~ 50 [%]	25
F507	S-pattern upper limit adjustment amount	0 ~ 50 [%]	25

1) Linear acceleration and deceleration
Typical pattern of acceleration and deceleration. This pattern is used in most cases.

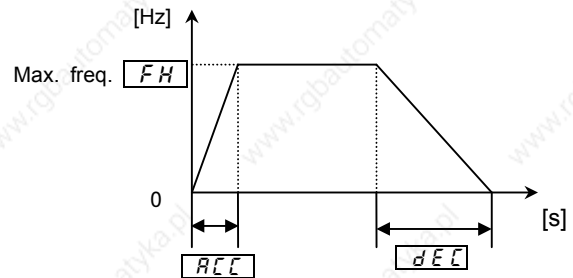

2) S-pattern acceleration/deceleration #1

This pattern is used in cases where a motor needs to be speeded up to or slowed down from a high-speed range of over 60 Hz in a short time or where there is a need to absorb shocks at the start of acceleration and deceleration. This pattern of acceleration and deceleration is suitable for the operation of transportation and lifting equipment.

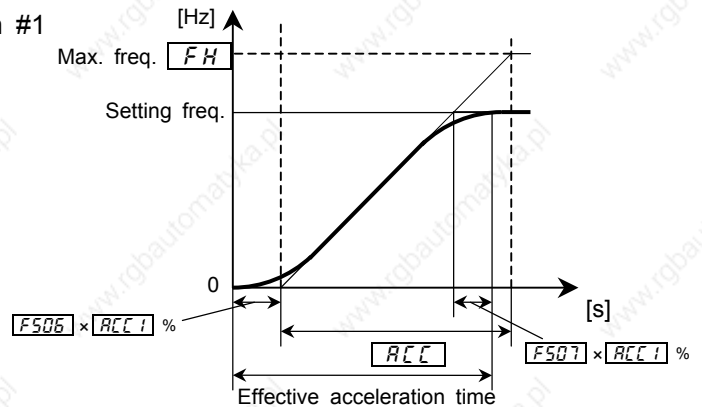

3) S-pattern acceleration/deceleration #2

In this pattern, the motor speeds up slowly in weak-field areas where it produces relatively small torque. This pattern of acceleration and deceleration is suitable for the operation of high-speed spindles, etc.

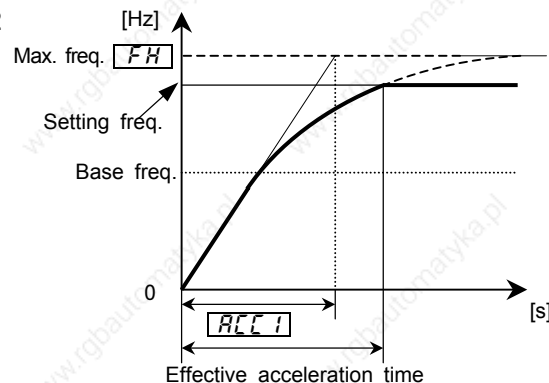

6.23.2 Switching of acceleration/deceleration #1, 2, 3 and 4

F500 : Acceleration time #2	F514 : Acceleration time #4
F501 : Deceleration time #2	F515 : Deceleration time #4
F504 : Acc/dec #1,2,3,4 selection	F517 : Acc/dec switching frequency #3
F505 : Acc/dec switching frequency #1	F503 : Acc/dec pattern #2
F510 : Acceleration time #3	F512 : Acc/dec pattern #3
F511 : Deceleration time #3	F516 : Acc/dec pattern #4
F513 : Acc/dec switching frequency #2	

• Function

With these parameters, you can set 4 acceleration and deceleration times. Acceleration and deceleration times can be selected or switched by any of the following 3 method:

- 1) Selection with parameters
- 2) Switching by means of frequencies
- 3) Switching with terminals

Title	Function	Adjustment range	Default setting
F500	Acceleration time #2	0.1(F508) ~ 6000 [s]	Model dependent
F501	Deceleration time #2	0.1(F508) ~ 6000 [s]	Model dependent
F504	Acc/dec time #1, 2, 3, 4 selection	1: Acc/dec #1, 2: Acc/dec #2, 3: Acc/dec #3, 4: Acc/dec #4	1
F510	Acceleration time #3	0.1(F508) ~ 6000 [s]	Model dependent
F511	Deceleration time #3	0.1(F508) ~ 6000 [s]	Model dependent
F514	Acceleration time #4	0.1(F508) ~ 6000 [s]	Model dependent
F515	Deceleration time #4	0.1(F508) ~ 6000 [s]	Model dependent

1) Selection with parameters

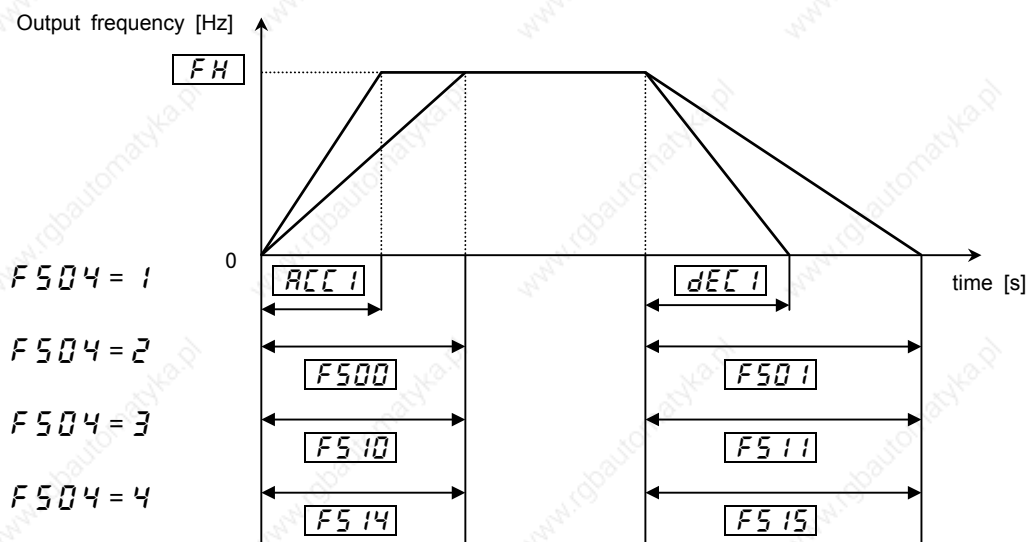

The acceleration/deceleration time selection parameter has been set at 1 by default. The setting of $F504$ can be changed from 1 to 2, 3 or 4. (The setting of $F504$ is valid when CND is set at 1.)

2) Switching by frequencies - Automatically switching acc/dec times at certain frequencies

Title	Function	Adjustment range	Default setting
<i>F505</i>	Acceleration/deceleration switching frequency #1	0.0 ~ FH [Hz]	0.0
<i>F513</i>	Acceleration/deceleration switching frequency #2	0.0 ~ FH [Hz]	0.0
<i>F517</i>	Acceleration/deceleration switching frequency #3	0.0 ~ FH [Hz]	0.0

Note) Regardless of the sequence of input of frequencies, acc/dec times are switched from #1 to #2 at the lowest frequency, from #2 to #3 at the middle frequency and from #3 to #4 at the highest frequency. (For example, if the frequency set with *F505* is higher than that set with *F513*, the acc/dec time #1 is selected in the frequency range below the *F513*-set frequency, while the acc/dec time #2 is selected in the frequency range of the *F513*-set frequency to the *F505*-set frequency.)

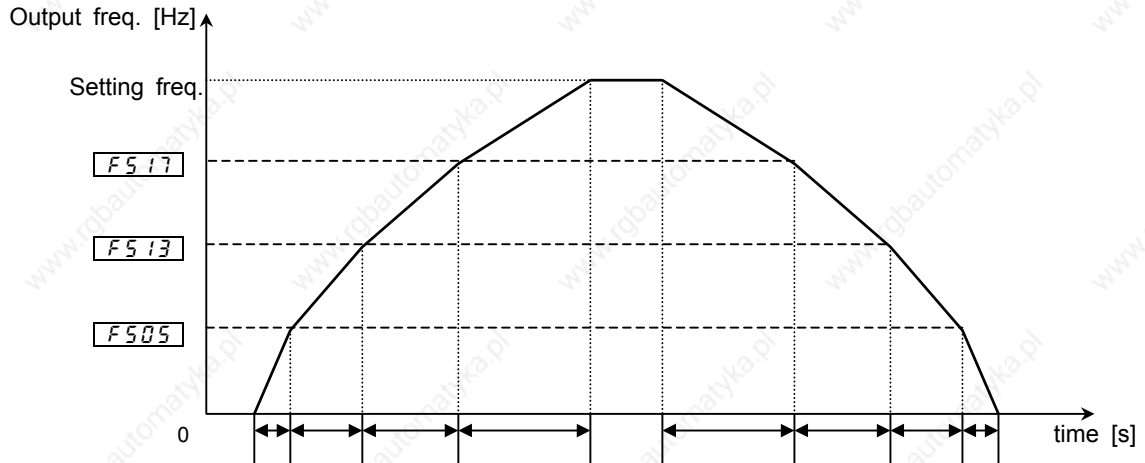

Acceleration at the gradient of *ACC 1*
 Acceleration at the gradient of *F500*
 Acceleration at the gradient of *F510*
 Acceleration at the gradient of *F514*

Deceleration at the gradient of *F515*
 Deceleration at the gradient of *F511*
 Deceleration at the gradient of *F501*
 Deceleration at the gradient of *DEC 1*

3) Switching with terminals - Switching acc/dec times by means of external terminals

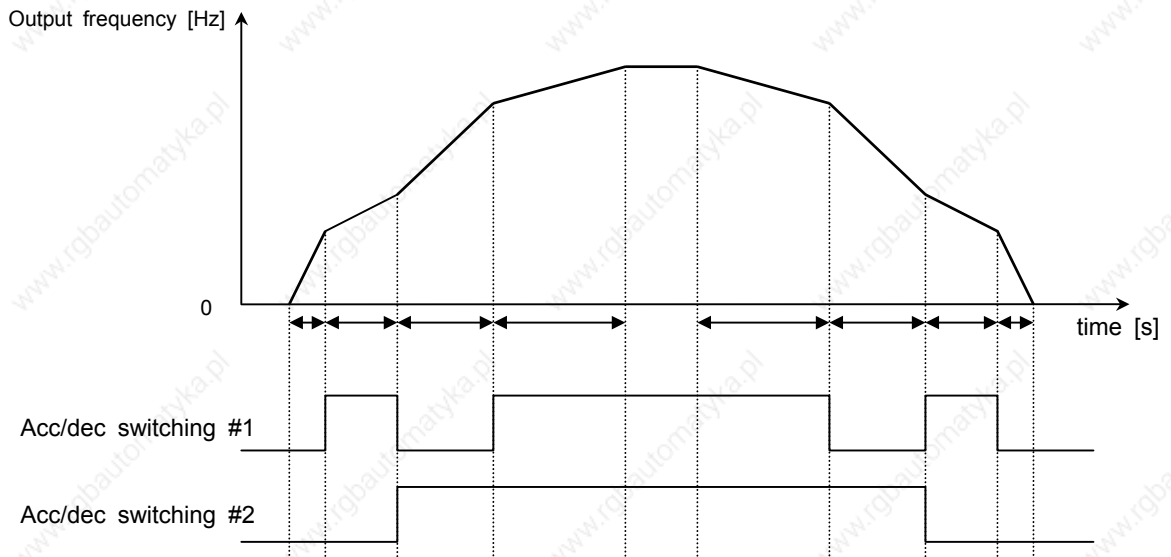

Acceleration at the gradient of *ACC 1*
 Acceleration at the gradient of *F500*
 Acceleration at the gradient of *F510*
 Acceleration at the gradient of *F514*

Deceleration at the gradient of *F515*
 Deceleration at the gradient of *F511*
 Deceleration at the gradient of *F501*
 Deceleration at the gradient of *DEC 1*

Parameter setting

a) Operation mode: Terminal board operation

Set the operation command mode selection $[NOd]$ at 0 .

b) Switching terminals: S3 and S4(Other terminals also can be settled for this purpose.)

S3 : Acceleration/deceleration switching #1

S4 : Acceleration/deceleration switching #2

Title	Function	Adjustment range	Default setting
$F117$	Input terminal selection #7 (S3)	$0 \sim 135$	24 (Acc/dec switching #1)
$F118$	Input terminal selection #8 (S4)	$0 \sim 135$	26 (Acc/dec switching #2)

Acceleration/deceleration patterns

Acceleration and deceleration pattern can be selected individually for each of the acceleration/deceleration times #1, 2, 3 and 4.

- 1) Linear acceleration/deceleration
- 2) S-pattern acceleration/deceleration #1
- 3) S-pattern acceleration/deceleration #2

Title	Function	Adjustment range	Default setting
$F502$	Acceleration/deceleration pattern #1	0 : Linear, 1 : S-pattern #1, 2 : S-pattern #2	0
$F503$	Acceleration/deceleration pattern #2	0 : Linear, 1 : S-pattern #1, 2 : S-pattern #2	0
$F512$	Acceleration/deceleration pattern #3	0 : Linear, 1 : S-pattern #1, 2 : S-pattern #2	0
$F517$	Acceleration/deceleration pattern #4	0 : Linear, 1 : S-pattern #1, 2 : S-pattern #2	0

Refer to 6.23.1 for an explanation of the acceleration/deceleration patterns.

The settings of the S-pattern lower limit adjustment amount $F506$ and the S-pattern upper limit adjustment amount $F507$ are reflected in every acceleration/deceleration pattern.

6.23.3 Minimum acceleration/deceleration times

$F508$: Acceleration/deceleration lower limit

• Function

This parameter sets the minimum acceleration and deceleration times.

[Parameter setting]

Title	Function	Adjustment range	Default setting
$F508$	Acceleration/deceleration time lower limit	$0.01 \sim 10.00$ [s]	0.10

Note) To set the minimum acceleration or deceleration time to less than 0.1 second, set $F704$ (Decimal place number of acc/dec time) at 2 (0.01 second) in advance so that the time can be displayed in units of 0.01 second.

Refer to 6.29.4 for the parameter $F704$ (Decimal place number of acc/dec time).

6.24 Pattern run

- F520** : Pattern run selection
- F521** : Pattern run mode
- F530**, **F540**, **F550**, **F560** : Cycle number of pattern group #1 to #4
- F531** ~ **F538** : Pattern group #1 selection #1 ~ #8
- F541** ~ **F548** : Pattern group #2 selection #1 ~ #8
- F551** ~ **F558** : Pattern group #3 selection #1 ~ #8
- F561** ~ **F568** : Pattern group #4 selection #1 ~ #8
- F570** ~ **F584** : Preset-speed #1 ~ #15 operation continuation mode
- F585** ~ **F599** : Preset-speed #1 to #15 operation time

• Function

These parameters enable you to form up to 60 patterns of automatic operation by variously combining operation frequencies, operation times and acceleration/deceleration times.

- 1) Start-up by control panel operation (CNOd = 1) : up to 15 patterns
- 2) Start-up by terminal board operation (CNOd = 0) : up to 60 patterns (15 types x 4 patterns)

Note) When control is exercised by the operation panel, pattern group #1 is always selected. If you want to operate in a pattern other than pattern group #1, select pattern group #1, #2, #3 or #4, using input terminal selection parameters (F111 ~ F125).

[Parameter setting]

Title	Function	Adjustment range	Default setting
F520	Pattern run selection	0: Disabled, 1: Enabled	0
F521	Pattern run mode	0: Patterned operation canceled during stop 1: Patterned operation continued during stop	0
F530	Cycle number of pattern group #1	1 ~ 254, 255:	1
F531 ~ F538	Pattern group #1 selection #1 ~ #8	0: Skip, 1 to 15	1 ~ 8
F540	Cycle number of pattern group #2	1 ~ 254, 255:	1
F541 ~ F548	Pattern group #2 selection #1 ~ #8	0: Skip, 1 to 15	9 ~ 15, 0
F550	Cycle number of pattern group #3	1 ~ 254, 255:	1
F551 ~ F558	Pattern group #3 selection #1 ~ #8	0: Skip, 1 to 15	1 ~ 8
F560	Cycle number of pattern group #4	1 ~ 254, 255:	1
F561 ~ F568	Pattern group #4 selection #1 ~ #8	0: Skip, 1 to 15	9 ~ 15, 0
F570 ~ F584	Preset-speed #1 ~ #15 operation continuation mode	0: Operation time in second after start of operation 1: Operation time in minute after start of operation 2: Operation time in second after attainment of frequency 3: Operation time in minute after attainment of frequency 4: Infinite (continued until stop command is entered) 5: Continue until next step command	0
F585 ~ F599	Preset-speed #1 ~ #15 operation time	1 ~ 8000 [s]/[min] (The unit depends on F570)	5

* Forward/reverse, Acc/Dec time #1/#2, V/f control mode #1/#2 can be set with F380 ~ F395 (Preset-speed operation frequency #1 to #15 control modes). Refer to 5.14 for details.

Note) When the function of auto-restart is active, the time spent for speed search is added to the operation time set for pattern operation. Consequently, the effective operation time sometimes becomes shorter than the settled operation time.

< Basic operating >

Step	Setting	Parameter															
1	Set the pattern run selection parameter at \bar{I} (Enabled).	$F520 = 0$ (Disabled), \bar{I} (Enabled)															
2	Change all frequencies required to preset-speed frequencies.	$5r1 \sim 5r7$ (Preset-speed #1 to #7) $F287 \sim F294$ (Preset-speed #8 to #15) $F380$ (Preset-speed operation mode) $F381 \sim F395$ (Preset-speed #1 to #15 control mode)															
3	Set the required operation time at each of the set operation frequencies.	$F570 \sim F584$ (Preset-speed #1 to #15 operation continuation mode) $F585 \sim F589$ (Preset-speed #1 to #15 operation time)															
4	Set the sequence of each speed This sequence following three methods. Select a run/stop operation from the pattern run mode	$F521 = 0$ (Patterned operation canceled during stop) Pattern run is reset by stop/switching operation before operating restarts. \bar{I} (Patterned operation continued during stop) Pattern run is started by stop/switching operation. The system stops temporarily on completion of every routine, then proceeds to the next routine.															
	Select a pattern group, and then set the sequence of each speed	$F530$ (Cycle number of pattern group #1) $F531 \sim F538$ (Pattern group #1 selection #1 to #8) $F540$ (Cycle number of pattern group #2) $F541 \sim F548$ (Pattern group #2 selection #1 to #8) $F550$ (Cycle number of pattern group #3) $F551 \sim F558$ (Pattern group #3 selection #1 to #8) $F560$ (Cycle number of pattern group #4) $F561 \sim F568$ (Pattern group #4 selection #1 to #8)															
	According to the required parameter group, select pattern group #1, #2, #3 or #4 from input terminal selection $F111$ to $F126$. If you set $F570 \sim F584$ at 5 at item 3 above, select step trigger signals from $F111 \sim F126$. Selecting pattern run continuation signals makes it possible to select a start/stop method.	$F111 \sim F126$ = 38, 39 (Pattern group #1) 40, 41 (Pattern group #2) 42, 43 (Pattern group #3) 44, 45 (Pattern group #4) 46, 47 (Pattern run continuation signal) 48, 49 (Pattern run trigger signal)															
5	Monitor displayed during pattern run During pattern operation, the following run information is displayed before the normal display.	<table border="1"> <thead> <tr> <th>Condition</th> <th>Display</th> <th>Meaning</th> </tr> </thead> <tbody> <tr> <td>Pattern group and pattern</td> <td>$P1.0$ (A)(B)</td> <td>(A): Number or the pattern group (B): Number of the pattern</td> </tr> <tr> <td>Number of repetitions</td> <td>$n123$</td> <td>Means that the current pattern operation is to be repeated (ex. 123 times).</td> </tr> <tr> <td>Preset operation speed</td> <td>$F1$</td> <td>Frequency reference with preset-speed #1 data.</td> </tr> <tr> <td>Remaining time of the current pattern operation</td> <td>1234 - - - -</td> <td>Current pattern is finished in 1234 seconds. Operation time is set for infinity or the system is waiting for the next step command.</td> </tr> </tbody> </table>	Condition	Display	Meaning	Pattern group and pattern	$P1.0$ (A)(B)	(A): Number or the pattern group (B): Number of the pattern	Number of repetitions	$n123$	Means that the current pattern operation is to be repeated (ex. 123 times).	Preset operation speed	$F1$	Frequency reference with preset-speed #1 data.	Remaining time of the current pattern operation	1234 - - - -	Current pattern is finished in 1234 seconds. Operation time is set for infinity or the system is waiting for the next step command.
Condition	Display	Meaning															
Pattern group and pattern	$P1.0$ (A)(B)	(A): Number or the pattern group (B): Number of the pattern															
Number of repetitions	$n123$	Means that the current pattern operation is to be repeated (ex. 123 times).															
Preset operation speed	$F1$	Frequency reference with preset-speed #1 data.															
Remaining time of the current pattern operation	1234 - - - -	Current pattern is finished in 1234 seconds. Operation time is set for infinity or the system is waiting for the next step command.															

Pattern run switching output (output terminal function : 36, 37)

If the pattern run switching output function is selected (activated), a signal is put out on completion of all the predetermined patterns of operation. When there is no operation command left to be entered or the pattern operation selection signal changes, the output terminals are turned off (in case of a-contact).

Terminal	Title	Function	Adjustment range	Default setting
OUT1	$F130$	Output terminal selection #1	$0 \sim 115$	36 (pattern run switching output: a-contact) or 37 (pattern run switching output: b-contact)

Note) To put out the signals to the terminal OUT2, select the parameter $F131$.

F 5 7 0 ~ F 5 8 4(Preset-speed #1 to #15 operation continuation mode)
 = 4(Infinite(continued until stop command is entered))

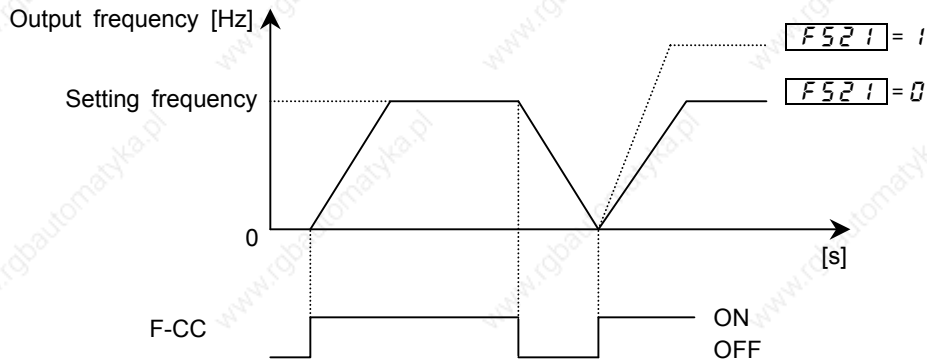

F 5 7 0 ~ F 5 8 4(Preset-speed #1 to #15 operation continuation mode)
 = 5 (Continue until next step command)

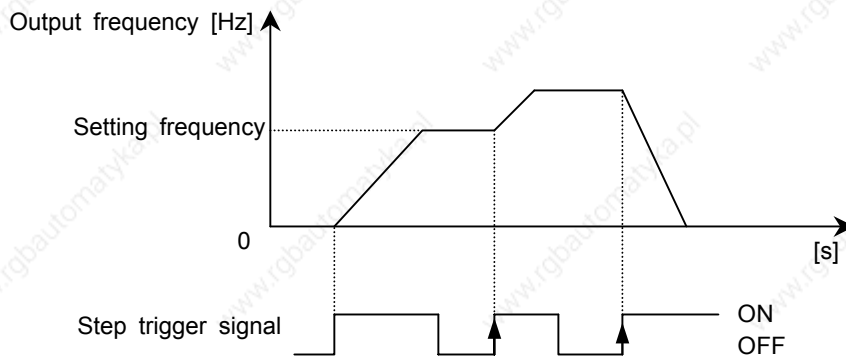

Set the input terminal selection **F 1 1 1 ~ F 1 2 6** at **4 8** (or **4 9**): pattern run trigger signal.

Notes)

- Pattern operation groups should be selected by terminal input.
- When the operation command mode selection is set for panel operation, pattern group #1 is always selected.(If you need a pattern other than pattern group #1, set input terminal selection (**F 1 1 1 ~ F 1 2 6**) at **3 8** to **4 5**, and operate with the terminal input.)
- If no signal is put out from any pattern run signal (all terminals are turned off), or after the pattern run is completed, the system returns to the normal operation mode.
- When two or more pattern group numbers are entered simultaneously, the pattern group operations are performed in ascending order and automatically switched to one another. In this case, it may take about 0.06 seconds to search for each pattern.
- 10 milliseconds after a pattern operation group selection #1, 2, 3 or 4 is activated, turn on the operation signal (F-CC). Within 10 [ms] or less, a signal for ordinary operation may be put out.

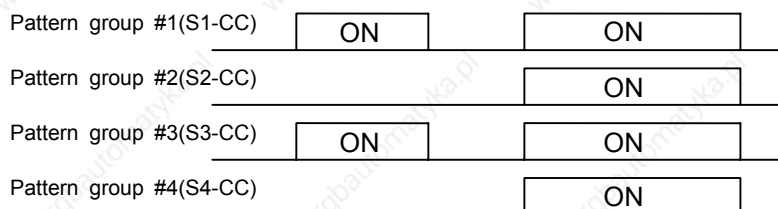
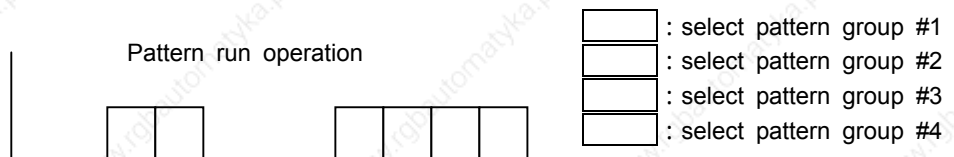

<Parameter setting>

F 1 1 5=38(Pattern group #1)

F 1 1 6=40(Pattern group #2)

F 1 1 7=42(Pattern group #3)

F 1 1 8=44(Pattern group #4)

6.25 Protection functions

6.25.1 Motor over road protection - level adjust / motor types



F600 : Motor over road protection level #1

F606 : Overload reduction start-up frequency

* Refer to 5.13 for details.

6.25.2 Setting of current stall

F601 : Stall prevention level

 Warning	
 Mandatory	<ul style="list-style-type: none"> Do not set the stall prevention level(F601) at a extremely small value. If the stall prevention level(F601) was set at a value that is near the motor's no load current or less, stall prevention function would work and output frequency would rise. In ordinary usage, do not set the stall prevention level at 30% or less.

Function

If the output current exceeds that set with **F601**, the stall protective function is activated to reduce the output frequency.

[Parameter setting]

Title	Function	Adjustment range	Default setting
F601	Stall prevention level	0 ~ 199 [%], 200: Disabled	120

[Display during the alarm 0C]

When 0C is displayed (when the output current is on the point of exceeding **F601**), the output frequency displayed changes and a "C" is displayed on the left side of the frequency.

Example of display

C 50

Note) In V/f constant control mode, the torque limits #1, #2, #3 and #4 can be used as a stall prevention.

You can make various settings by combining these functions with the V/f1, 2, 3 and 4 functions.

6.25.3 Inverter trip holding

F602 : Selection of inverter trip holding

Function

The function is to hold inverter's trip records. If this function is active, trip records are retained and can be displayed even after the inverter is reset.

[Parameter setting]

Title	Function	Adjustment range	Default setting
F602	Selection of inverter trip holding	0: Cleared if power is turned off 1: Hold even if power is turned off	0

The last 4 trip records can be held and displayed in status monitor mode.

Trip data (current, voltage, etc. at the time of a trip) can be displayed in status monitor mode when the inverter trips, but is cleared if the power is turned off.

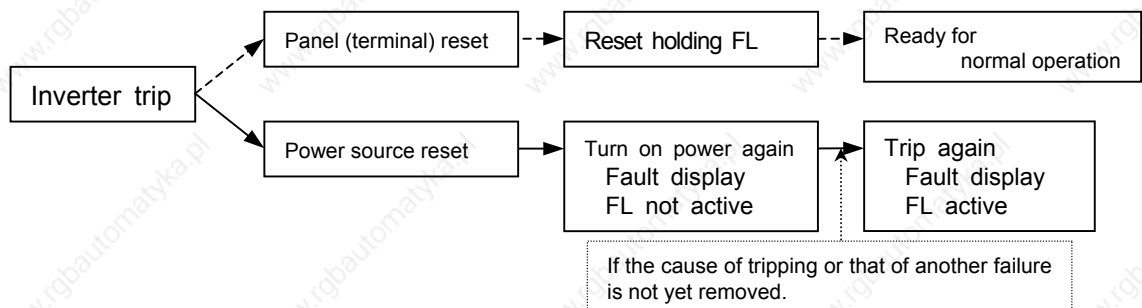

6.25.4 Emergency stop

F603 : Emergency stop

F604 : Emergency DC injection braking control time

• Function

Emergency stop mode of can be selected. At emergency stop, a trip message ("E") is displayed.

Note) When setting **F603** at 2 or 5 (Emergency DC injection braking stop), you need to set also the parameters **F251** (DC injection braking current) and **F604** (Emergency DC injection braking control time).

1) Emergency stop by terminal operation

Emergency stop can be performed with the a or b-contact. Assign the emergency stop function to a terminal as described below, and select a stop mode.

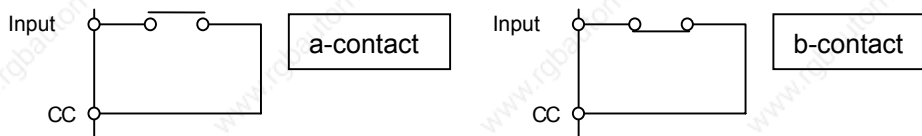

[Parameter setting]

Title	Function	Adjustment range	Default setting
F603	Emergency stop	0: Coast stop 1: Deceleration stop 2: Emergency DC injection braking stop 3: Coast stop without FL output 4: Deceleration stop without FL output 5: Emergency DC injection braking without FL output	0
F604	Emergency DC injection braking control time	0.0 ~ 10.0 [s]	0.1
F251	DC injection braking current	0.0 ~ 100.0 [%]	50.0

(Example of assignment) Assigning the emergency stop function to the terminal S4

Title	Function	Adjustment range	Setting value
F118	Input terminal selection #8 (S4)	0 ~ 135	20 (emergency stop)

Note 1) An emergency stop can be carried out from the terminal even in panel operation mode. In this case, however, holding down the Stop key for more than 5 seconds causes the inverter trip (E-17) even when **F603** is set at 3, 4 or 5.

Note 2) If DC injection braking is not needed for normal stops, though **F603** is set at 2 or 5 (emergency DC injection braking), then set the DC braking time **F252** at 0.0 [s].

2) Emergency stop by panel operation

Emergency stop can be performed with the control panel, in other operation command mode.

Press twice the STOP key on the control panel.

Press the STOP key "EQFF" starts blinking.

Press the STOP key again Emergency stop

Then, "E" is displayed, and also a fault detection signal (FL) is put out at **F603**=0, 1 or 2, while the FL is not active if **F603** is set at 3, 4 or 5.

6.25.5 Overload reduction start-up frequency

F606 : Overload reduction start-up frequency

Refer to 5.13 for details.

6.25.6 Motor's 150%-overload time limit

F607 : Motor 150%-overload time limit

Refer to 5.13 for details.

6.25.7 Action at low currents

F610 : Low-current trip

F611 : Low-current detection level

F612 : Low-current detection time

• Function

If the current is lower than **F611** level and passes for a time longer than **F612**, the inverter trips. When **F610** is set at **1**(tripping disabled), it is necessary to set, with **F612**, the time elapsed before the inverter trips after the detection of a small current.

F610 = **0** : Disabled not trip (FL is not active)

Low-current alarm can be output by output terminal selection.

F610 = **1** : Enabled The inverter trips if low-current passes during operation for the time set with **F612** or over. (FL is active)

Title	Function	Adjustment range	Default setting
F610	Low-current trip	0 : Disabled, 1 : Enabled	0
F611	Low-current detection level	0 ~ 100 [%]	0
F612	Low-current detection time	0 ~ 255 [s]	0

6.25.8 Detection of output phase failure

F613 : Detection of output short-circuit during start-up

F614 : Adjustment of detection pulse for output short-circuit during start-up

• Function

The function is to detect short circuits with inverter's output terminals.

Title	Function	Adjustment range	Default setting
F613	Detection of output short-circuit during start-up	0 : Standard 1 : Only one time at power injection or at first start after reset	0
F614	Adjustment of detection pulse for output short-circuit during start-up	1 ~ 100 [μ s]	50

F613 **0**: Standard detecting at starting

1: A check is made once at the first start of operation after the power is turned on or the inverter is reset.

F614 Set the pulse length for the detection of short circuits.

Note) Shorten the pulse length if the motor trips in error (OCL) at start-up, especially a high-speed motor.

6.25.9 Over-torque trip

F615 : Over-torque trip

F616 : Over-torque detection level during power running

F617 : Over-torque detection level during regeneration

F618 : Over-torque detection time

• Function

If a torque current exceeding the current set with **F616**, **F617** is detected, the inverter trips and the trip message "O τ " is displayed.

$F615 = 0$ (Disabled) · · · · does not trip (FL is not active).

$F615 = 1$ (Enabled) · · · · The inverter trips if a torque current larger than $F616$ (during power running) or $F617$ (during regeneration) passes for a time longer than the time set with $F618$.

Title	Function	Adjustment range	Default setting
$F615$	Over-torque trip	0: Disabled 1: Enabled	0
$F616$	Over-torque detection level during power running	0 ~ 250 [%]	120
$F617$	Over-torque detection level during regeneration	0 ~ 250 [%]	120
$F618$	Over-torque detection time	0.0 ~ 100.0 [s]	0.5

6.25.10 Cooling fan control mode selection

$F620$: Cooling fan control mode

• Function

With this parameter, you can set the condition of cooling fan so that it operates only when the inverter requires cooling, and thus it can be used for a longer period of.

$F620 = 0$: Automatic control of cooling fan, enabled. Operates only when the inverter is in operation.

$F620 = 1$: Automatic control of cooling fan, disabled. The cooling fan always operates when the inverter is energized.

The cooling fan automatically operates whenever the ambient temperature is high, even when the inverter is out of operation.

Title	Function	Adjustment range	Default setting
$F620$	Cooling fan control mode	0: Automatic 1: Always ON	0

6.25.11 Cumulative operation time alarm

$F621$: Cumulative operation time alarm setting

• Function

This parameter is to make a setting so that the inverter puts out a signal when its cumulative operation time has reached the time set with this parameter.

* Panel display of 0.1 corresponds to 10 hours. If 38.55 is displayed, the cumulative operation time is 3855 hours.

Title	Function	Adjustment range	Default setting
$F621$	Cumulative operation time alarm setting	0.1 ~ 999.9 [× 100h]	175.0

Output terminal setting

Ex.) Assigning the cumulative operation time alarm function to the terminal OUT2

Title	Function	Adjustment range	Setting value
$F131$	Output terminal selection#2 (OUT2)	0 ~ 119	56

6.25.12 Over-voltage stall protection level

F625 : Over-voltage stall protection level(high response)

F626 : Over-voltage stall protection level

* Refer to 6.13.5 for details.

6.25.13 Under-voltage trip

F627 : Under-voltage trip mode

F628 : Under-voltage detection time

• Function

This parameter is to select the action when detecting an under-voltage. (Invalid, while the inverter stops.) If **F627** is set at **1**(Enabled), it is necessary to set, with **F628**, the time elapsed before the inverter trips after the detection of an under-voltage.

F627 = **0** : Disabled Inverter stops, but does not trip.(FL is not active)

F627 = **1** : Enabled The inverter trips if an under-voltage passes for the time set with **F628** or over. (FL is active)

Title	Function	Adjustment range	Default setting
F627	Under-voltage trip mode	0 : Disabled, 1 : Enabled	0
F628	Under-voltage detection time	0.00 ~ 10.00 [s]	0.03

6.25.14 UV stall level

F629 : Under-voltage stall level

• Function

This parameter is used to set the operation level of the regenerative power ride-through control and the deceleration stop. (Refer to 6.13.2)

Title	Function	Adjustment range	Default setting
F629	Under-voltage stall level	50 ~ 100 [%]	75

6.25.15 System-supporting sequence (B-timer)

F630 : System-supporting sequence (B-timer)

• Function

This parameter is used to set the waiting time for answer from system(Input terminal function setting: System-supporting sequence (BA: **130**, **131**)). After start of operation, if no answer is received in set time(**F630**), the inverter trips(**E-11**).

Title	Function	Adjustment range	Default setting
F630	System-supporting sequence (B-timer)	0.0 : Invalid 0.1 ~ 10.0 [s]	0.0

6.26 Special analog input

- F650** : Acceleration/deceleration base frequency adjustment
- F651** : Upper-limit frequency adjustment
- F652** : Acceleration time adjustment
- F653** : Deceleration time adjustment
- F654** : Manual torque boost adjustment

• Function

The function is to make it possible to change the fixed settings of some parameters by means of external analog signals.

1) Acceleration/deceleration base frequency adjustment

If this parameter is so set, The signal from the terminal VI, II or RR can be used as data for the adjustment of acceleration/deceleration time reference frequencies. This function is useful for performing proportional operation. Frequency adjustment range: 30 to 400 Hz.

Title	Function	Adjustment range	Default setting
F650	Acceleration/deceleration base frequency adjustment	0: Invalid 1: VI/II 2: RR	0

2) Upper-limit frequency adjustment

The signal from VI, II or RR can be used as the upper limit frequency.

Adjustment range: 0 ~ UL (The frequency cannot be set above the upper-limit frequency (UL)).

Title	Function	Adjustment range	Default setting
F651	Upper-limit frequency adjustment	0: Invalid 1: VI/II 2: RR	0

3) Acceleration time adjustment

Using reference input from VI, II or RR, acceleration time set with the parameter ACC (or acceleration time #2, #3 or #4) can be multiplied the by factors of 1.0 to 10.0 . 10% of reference input act as multiply factor of 1.0 .

Title	Function	Adjustment range	Default setting
F652	Acceleration time adjustment	0: Invalid 1: VI/II 2: RR	0

4) Deceleration time adjustment

Using reference input from VI, II or RR, deceleration time set with the parameter DEC (or deceleration time #2, #3 or #4) can be multiplied the by factors of 1.0 to 10.0 . 10% of reference input act as multiply factor of 1.0 .

Title	Function	Adjustment range	Default setting
F653	Deceleration time adjustment	0: Invalid 1: VI/II 2: RR	0

5) Manual torque boost adjustment

Using reference input from VI, II or RR, manual torque boost set with the parameter ub (or F172, F176 or F180) can be multiplied the by factors of 0.0 to 2.5 .

Title	Function	Adjustment range	Default setting
F654	Manual torque boost adjustment	0: Invalid 1: VI/II 2: RR	0

6.27 Over-ride

F660 : Over-ride addition input selection

F661 : Over-ride multiplication input selection

• Function

These parameters are used to adjust reference frequencies by means of external

Title	Function	Adjustment range	Default setting
F660	Over-ride addition input selection [Hz]	0: Disabled 1: VI(voltage input) / II(current input) 2: RR(volume / voltage input) 3: RX(voltage input) 4: RX2(voltage input)(optional) 5: Operating panel input 6: Binary/BCD input(optional) 7: Common serial communication option(FA01) 8: Serial communication RS485(FA05) 9: Communication add-on cassette option(FA07) 10: Up/down frequency 11: Pulse input #1(optional)	0
F661	Over-ride multiplication input selection [%]	0: Disabled 1: VI(voltage input) / II(current input) 2: RR(volume / voltage input) 3: RX(voltage input) 4: RX2(voltage input)(optional) 5: F729	0

The override functions calculate output frequency by the following expression:

$$\text{Output frequency} \times \left(1 + \frac{F661 [\%]}{100} \right) + F660 [\text{Hz}]$$

1) Additive over-ride

In this mode, an externally input over-ride frequency is added to reference frequency.

[Ex1: RR(reference), VI(over-ride frequency)] [Ex2: RX(reference), VI(over-ride frequency)]

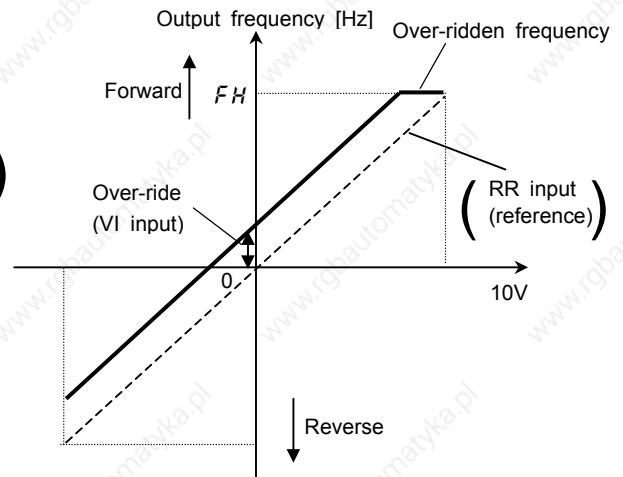
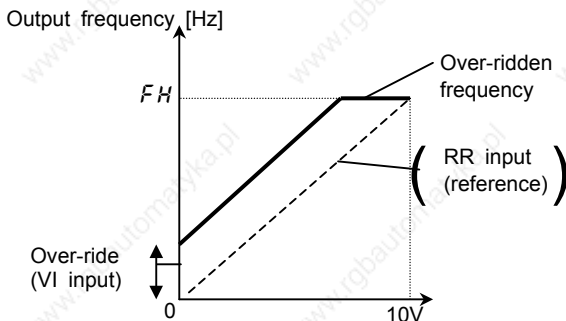

Ex1:

$F660 = 1$ (VI input), $F661 = 0$ (disabled)

$$\text{Output frequency} = \text{Reference} + \text{Over-ride (VI input [Hz])}$$

Ex2:

$F660 = 1$ (VI input), $F661 = 0$ (disabled)

$$\text{Output frequency} = \text{Reference} + \text{Over-ride(VI input [Hz])}$$

2) Multiplicative over-ride

In this mode, each output frequency is multiplied by an externally override frequency.

[Ex1: RR(reference), VI(over-ride frequency)] [Ex2: RX(reference), VI(over-ride frequency)]

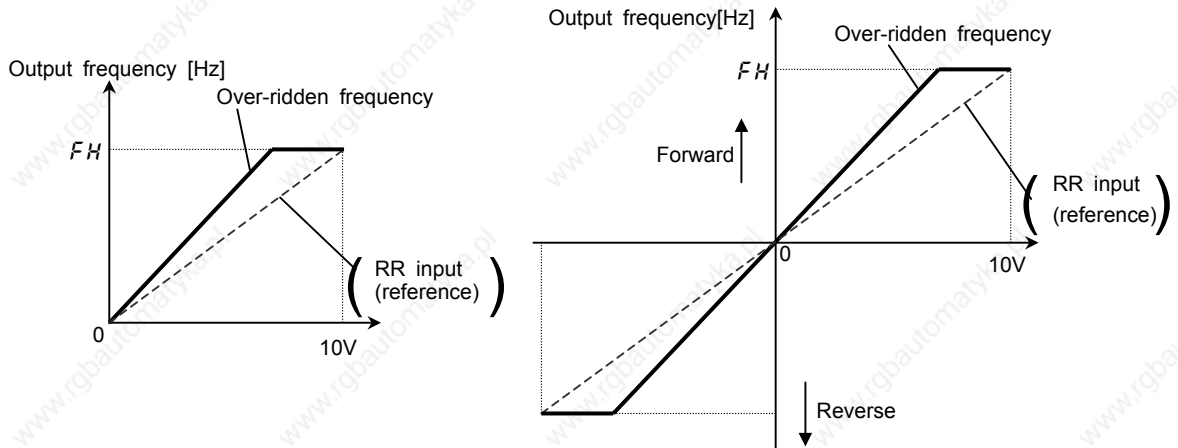

Ex1:

$F660 = 0$ (Disabled), $F661 = 1$ (VI input), $F70d = 2$ (RR input), $FH = 80.0$, $UL = 80.0$

RR input ($F210 = 0$, $F211 = 0.0$, $F212 = 100$, $F213 = 80.0$)

VI input ($F201 = 0$, $F205 = 0$, $F203 = 100$, $F206 = 100$)

Note) Setting of RR input: Refer to 7.3.1, Setting of VI input: Refer to 7.3.2

$$\text{Output frequency} = \text{Reference} \times \{1 + \text{Over-ride(VI input [\%])} / 100\}$$

Ex2:

$F660 = 0$ (Disabled), $F661 = 1$ (VI input), $F70d = 3$ (RX input), $FH = 80.0$, $UL = 80.0$

RX input ($F216 = 0$, $F217 = 0.0$, $F218 = 100$, $F219 = 80.0$)

VI input ($F201 = 0$, $F202 = 0$, $F203 = 100$, $F206 = 100$)

Note) Setting of RX input: Refer to 7.3.1, Setting of VI input: Refer to 7.3.2

$$\text{Output frequency} = \text{Reference} \times \{1 + \text{Over-ride(VI input [\%])} / 100\}$$

Ex3:

Title	Function	Adjustment range	Default setting
$F729$	Panel over-ride multiplication gain	-100 ~ 100 [%]	0

$$\text{Output frequency} = \text{Reference} \times \{1 + \text{Over-ride}(F729 [\%]) / 100\}$$

6.28 Meter output

6.28.1 Setting of meter outputs

- F670** : AM terminal meter selection
- F671** : AM terminal meter adjustment

Refer to 5.4 for details.

6.28.2 Setting of optional meter outputs

- F672** : Optional analog terminal #1 meter selection
- F673** : Optional analog terminal #1 meter adjustment
- F674** : Optional analog terminal #2 meter selection
- F675** : Optional analog terminal #2 meter adjustment
- F678** : Optional analog terminal #1 meter offset
- F679** : Optional analog terminal #2 meter offset
- F680** : Optional analog terminal #2 sign selection

6.28.3 Pulse output to meters

- F676** : FP terminal meter selection
- F677** : FP terminal meter adjustment

The function set with **F676** is output from FP terminal. Set a desired number of output pulses as **F677** with reference to the following table. Refer to 5.4 about adjustment level.

• Function
 These parameters are used to set the pulse output function and the number of pulses output from the output terminal FP.

Ex.) Output Running frequency(0 ~ 80Hz) at 0 ~ 10kHz
 Setting: **FH=80**, **F676=0**, **F677=10**

Title	Function	Adjustment range	Adjustment level	Default setting
F676	FP terminal meter selection	0: Running frequency 1: Frequency command 2: Current indication 3: DC voltage 4: Output voltage 5: After-compensation frequency 6: Speed feedback (real-time value) 7: Speed feedback (1 second filter) 8: Torque 9: Torque reference 10: Internal torque reference (*1) 11: Torque current 12: Exciting current 13: PID feedback value 14: Motor overload factor (OL2 data) 15: Inverter overload factor (OL1 data) 16: PBr overload factor (PBrOL data) 17: PBr load factor (pulse duty) 18: Input power 19: Output power 20: Peak output current 21: Peak DC voltage 22: Motor counter dummy PG 23: Position pulse 24: PR input 25: VI/I input 26: RX input 27: RX2 input 28: FM output 29: AM output 30: Fixed output for meter adjustment 31: Analog output for communication 32: Acc/dec torque removal	(a) (a) (b) (b) (b) (a) (a) (a) (a) (b) (b) (b) (a) (c) (c) (c) (c) (e) (e) (b) (b) (d) (d) (c) (c) (c) (c) (c) (c) (c) (c) (c) (c) (c) (c) (c) (c) (c) (c)	0
F677	FP terminal meter adjustment	1.00 ~ 43.20 [kHz]		3.84

Note). ON pulse width is fixed at a value that depends on the setting of **F677**.(about 50~70%)
 The data of current, torque, etc. are limited by 200 %

6.29 Control panel parameters

6.29.1 Prohibiting the change of parameter settings

F700 : Prohibition of parameter setting

• **Function**

This parameter is used to make a setting to prohibit or allow the change of parameter settings.

Setting method

0 : Allowed.....No parameters are write-protected. (Default setting)

1 : Prohibited....All parameters except for **F700** are write-protected.

[Parameter setting]

Title	Function	Adjustment range	Default setting
F700	Prohibition of parameter setting	0 : Allowed 1 : Prohibited	0

Canceling method

F700 only is designed so that its setting can be changed anytime even when it is set at 1.

To prohibit all operation, including key operation, use the parameter **F730**(Panel operation prohibition).

6.29.2 Changing the units of display

F701 : Current / voltage display mode

• **Function**

This parameter is used to change the units of display of current and voltage.

Display in % <=> Display in A (ampere) or V (volt)

Example of setting

When the VFP7-2185P (rated current: 73A) is operated under the rated 100% load :

1) Display in [%]

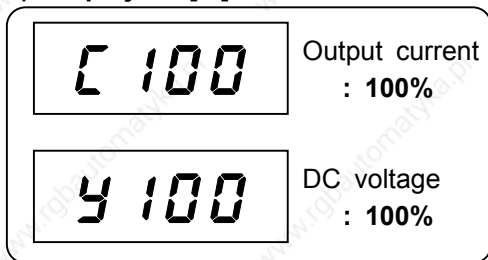

2) Display in [A] or [V]

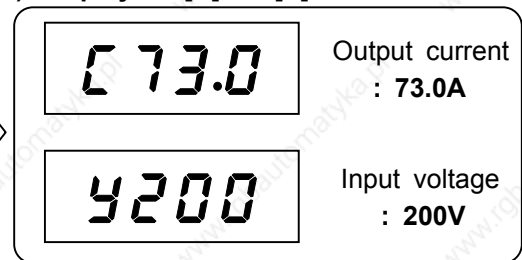

Title	Function	Adjustment range	Default setting
F701	Current / voltage display mode	0 : [%] 1 : [A] or [V]	0

With **F701**, you can convert the units pertaining to the following parameters:

• Display in [A]: Current monitor

Motor overload protection level #1,#2,#3,#4 **F600, F173, F177, F181**

DC injection braking current **F251**

Stall prevention level **F601**

• Display in [V]: Voltage monitor

V/f 5-point setting **F191, F193, F195, F197, F199**

(Note) Base frequency voltage is always displayed in voltage unit.

6.29.3 Display the motor speed and the load speed

F 702 : Frequency free unit magnification

• Function

This parameter is used to convert the monitored or parameter-set frequency into the rotating speed of the motor or the speed of the load.

Value displayed

The LED displays the value obtained by multiplying the monitored or parameter-set frequency by the value set with **F 702**.

$$\text{Displayed value} = \text{Monitored frequency or frequency set with a parameter} \times \text{Value set with } F 702$$

Note) If the display value is more than 9999,4digit from the left and *E 1* are displayed alternately. (Ex. alternate display "2000 E 1" for the value 20000.)

Examples of setting

1) Display of the rotating speed of the motor

To switch from the operation frequency (default setting: 60 Hz) to the rotating speed of the 4P motor (1800 min⁻¹)

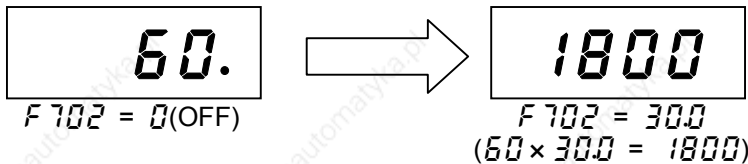

2) Display of the speed of the load

To switch from the operation frequency (default setting: 60 Hz) to the speed of the load (6 m/min-1.)

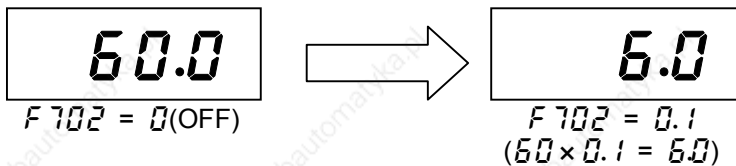

[Parameter setting]

Title	Function	Adjustment range	Default setting
F 702	Frequency free unit magnification	0.00: OFF, 0.0 1~200.0	0

Note: This parameter is to display the value obtained by multiplying the output frequency of the inverter by an integer. Therefore, the value calculated from the output frequency is always displayed regardless of fluctuations of the rotating speed of the motor due to fluctuations of the load.

6.29.4 Column number below decimal point of Frequency, Acc/dec time

F 703 : Decimal place number of frequency

F 704 : Decimal place number of Acceleration/deceleration time

• Function

These parameters are used to change the number of decimal places of the monitored or parameter-set frequency, acceleration time or deceleration time displayed.

Example of setting

Title	Function	Adjustment range	Default setting	Value displayed after change (example)
F 703	Decimal place number of frequency	0: 1 [Hz]	1	60
		1: 0.1 [Hz]		60.0
		2: 0.01 [Hz]		60.00

Title	Function	Adjustment range	Default setting	Value displayed after change (example)
F 704	Decimal place number of Acceleration/deceleration time	0: 1 [s]	1	10
		1: 0.1 [s]		10.0
		2: 0.01 [s]		10.00

6.29.5 Changing items displayed in status monitor mode

F 710 : Monitor display mode setting

F 711 : Status monitor #1 display mode

F 712 : Status monitor #2 display mode

F 713 : Status monitor #3 display mode

F 714 : Status monitor #4 display mode

These parameters are used to select the item to be displayed when the power is turned on and also to change items displayed in status monitor mode. Refer to 8.1 for details.

6.29.6 Switching basic parameters

F 720 : Selection of panel V/f1, 2, 3 or 4

• Function

This parameter is used to switch V/f characteristics during operation or to drive four motors with a single inverter.

This parameter is valid only when the inverter is in panel operation mode.

[Parameter setting]

V/f1 is selected default setting.

Title	Function	Adjustment range	Default setting
F 720	Selection of panel V/f1,2,3 or 4	1: V/f1, 2: V/f2, 3: V/f3, 4: V/f4	1

[Parameters which can be switched with F 720]

1(V/f1)		2(V/f2)	
Base frequency #1	uL	Base frequency #2	F 170
Base frequency voltage #1	F 306	Base frequency voltage #2	F 171
Manual torque boost	ub	Manual torque boost #2	F 172
Motor overload protection level #1	F 600	Motor overload protection level #2	F 173

3(V/f3)		4(V/f4)	
Base frequency #3	F 174	Base frequency #4	F 178
Base frequency voltage #3	F 175	Base frequency voltage #4	F 179
Manual torque boost #3	F 176	Manual torque boost #4	F 180
Motor overload protection level #3	F 177	Motor overload protection level #4	F 181

 : Parameter groups selected by default

Switching by means of terminals

The V/f1, 2, 3 and 4 can also be switched by switching on and off terminals.

Refer to 6.4.1 for details.

6.29.7 Selecting a control panel stop pattern

F 721 : Panel stop pattern

• Function

This parameter is used to select the mode in which the machine is stopped by pressing the **(STOP)** key on the control panel when the operation is started by pressing the **(RUN)** key.

1) Slowdown stop

The motor stops in the deceleration time set with the parameter *DEC(F501, F511 or F515)*.

2) Free-run stop

The output of the inverter is cut off. As a result, the motor coasts to a stop. Depending on the load, the motor can keep rotating for a while before coming to a complete stop.

[Parameter setting]

Title	Function	Adjustment range	Default setting
<i>F 721</i>	Panel stop pattern	<i>0</i> : Deceleration stop <i>1</i> : Coast stop	<i>0</i>

6.29.8 Resetting the inverter from the control panel

F 722 : Panel reset function

• Function

This parameter is used to reset the inverter by control panel operation when it trips because of a failure, a fault, etc.

Resetting method

- 1) Press the Stop key and make sure that *OLr* is displayed.
- 2) Press the Stop key again to reset the inverter.

Note) If the inverter trips because of trouble indicated with the message *OP 1~3, OL 1, OL 2, OLr* or *OH*, it may take a bit of time for the inverter to be reset.

[Parameter setting]

Title	Function	Adjustment range	Default setting
<i>F 722</i>	Panel reset function	<i>0</i> : Disabled, <i>1</i> : Enabled	<i>1</i>

6.29.9 Selecting a torque limit in control panel operation mode

F 723 : Panel torque limit

• Function

With this parameter, you can select a torque limit when torque control is exercised by the control panel.

This parameter is valid only when the inverter is in control panel operation mode.

Control panel operation: The mode of operation obtained by setting the torque command selection parameter *F 420* at *5* (Panel input).

[Parameter setting]

Title	Function	Adjustment range	Default setting
<i>F 723</i>	Panel torque limit	<i>1, 2, 3, 4</i>	<i>1</i>

* Refer to 6.22 for details of torque limit setting.

6.29.10 Canceling PID control in panel operation mode

F 724 : Panel PID control OFF

• Function

This parameter is to switch from PID control to open-loop control (normal control mode) when PID control is exercised by the control panel.

Note) This parameter is valid only when the inverter is in panel operation mode.

0 : PID control enabled

PID control is exercised if F 360 is not set at 0.

1 : PID control disabled

Open-loop control (normal control mode) is exercised instead of PID control.

[Parameter setting]

Title	Function	Adjustment range	Default setting
F 724	Panel PID control OFF	0: ON 1: OFF	0

Note) When F 360 is set at 0, open-loop control is exercised even if this parameter is set at 0 (PID control enabled).

6.29.11 Setting a torque command in panel operation mode

F 725 : Panel torque reference

• Function

This parameter is to set a torque command when torque control is exercised by the operation panel. This parameter is valid only when the inverter is in control panel operation mode.

Panel operation: Torque command selection F 420 is set at 5 (Panel input).

[Parameter setting]

Title	Function	Adjustment range	Default setting
F 725	Panel torque reference	0 ~ 250 [%]	0

* Refer to 3.3.3 for details.

6.29.12 Drooping control in panel operation mode

F 726 : Panel synchronized torque bias

F 727 : Panel tension torque bias

F 728 : Panel load sharing gain

6.29.13 Override in panel operation mode

F 729 : Panel over-ride multiplication gain

*Refer to 6.27 for details.

6.29.14 Restricting or prohibiting key operation

F730 : Panel operation prohibition

• Function

This parameter can prohibit the operation of control panel keys to avoid operation errors.

Note 1) The setting of this parameter take effects as soon as it is saved.

Note 2) Once saved, the setting of this parameter cannot be overridden unless the power is turned off or the inverter is reset after trip.

Setting

Every key operation, enabled **63** (Default setting)

Every key operation, prohibited **0**

Ex.) to enable monitor display operation and Panel operation(start/stop):

Monitor display operation enabled ... + 4

Panel operation(start/stop) enabled ... + 8

$$(+ 4) + (+ 8) = 12$$

Therefore, the number you should key in to enable these functions is **12**.

[Parameter setting]

Title	Function	Adjustment range	Default setting
F730	Panel operation prohibition	0 : Every key operation, inhibited + 1: panel frequency setting enabled + 2: Parameter Load enabled + 4: Monitor display operation enabled + 8: Panel operation(start/stop) enabled (+ 16: No function is assigned) + 32: Emergency stop operation enabled 63 : normal mode(Every key operation enabled)	63

Note) The LED displays "**F730**" immediately after **F730** is set at **0**, but it returns to normal standard mode after the inverter is reset or is locked to trip monitor mode if the inverter trips.



To prohibit the read or write of parameter, refer to 6.29.1.

Canceling methods

1) Temporary cancellation

Every key operation is enabled temporarily, until the power is turned off. (Turning off the power disables every key operation again.)

In standard monitor display mode or trip monitor mode,

press the  key twice while holding down the  key



2) Permanent cancellation

[Canceling method in cases that parameters are not read/write-protected]



F730 is overridden permanently. Changing its setting causes the previous setting to be overridden automatically in a mode where parameters are not read/write-protected.

[Canceling in cases that parameters are read/write-protected]

In standard monitor display mode or trip monitor mode,

press the  key twice while holding down the  key

and then change the setting of **F730** to **63**.

Note) "63" is displayed when F730 is called. Press the  and  keys to make the "63" blink, then press the Enter key to save the setting.

6.30 Communication function (RS485/common serial)

F800	: Communication rate (common serial)
F801	: Parity (common serial/RS485)
F802	: Inverter number (common)
F803	: Communication time-out (common serial/RS485)
F804	: Communication time-out action (common serial/RS485)
F805	: Communication waiting time (common serial)
F806	: Inter-drive communication (common serial)
F810	: Frequency point selection
F811	: Point #1 setting
F812	: Point #1 frequency
F813	: Point #2 setting
F814	: Point #2 frequency
F820	: Communication rate (RS485)
F821	: RS485 wiring system
F825	: RS485 communication waiting time
F826	: Inter-drive communications (RS485)

• Function

These parameters set up a data communications network by connecting inverters to one another and to a host control system, and also establish a data communications link between a computer and each inverter.

< Computer link >

The function is to enable data communications between a host control system (computer) and each inverter.

Monitoring of inverter status (output frequency, current, voltage, etc.)

Command to each inverter (start command, stop command, etc.)

Load, modify, and save of inverter's parameter setting

< Inter-drive communication >

Designed to enable an inverter (master) to send data selected with parameters to the other inverters (slaves) on the network. With this function, you can establish a network to perform simplified synchronous or proportional operation (point frequency setting).

Timer functionDesigned to detect broken communications cables. With this function, you can set the inverter in such a manner that it can trip ("E r 5" is displayed) or an alarm goes off. ("E" is displayed on the panel) if it receives no data within the predetermined time.

Broadcast communication ... Designed to send data to more than one inverter at a time.

Inter-drive communication ...The master inverter transmits the data that was chosen with the parameter to all the slave inverters on the same network. Using this function, the network that performs synchronized operation and proportion operation (point frequency setting) in simple way can be constituted.

6.30.1 Common serial optional device

With RS232C unit (optional), and RS485 unit(optional), connect inverters to a higher-order control system (host computer) to establish a data communications network between them. Also, you can establish a data communications link between a computer and each inverter(RS485).

the common serial options available:

- RS232C communications converter units (model: RS2001Z)
Communication cable (model: CAB0011 (1 m), CAB0013 (3 m), CAB0015 (5 m))
- RS485 communication converter unit (model: RS4001Z, RS4002Z)
Communication cable (model: CAB0011 (1 m), CAB0013 (3 m), CAB0015 (5 m))

(Note) Distance between Inverter and a common serial option should not be more than 5 m apart.

Setting of operation command (common serial)

Title	Function	Adjustment range	Default setting	Setting
<i>CNDd</i>	Operation command mode selection	0 ~ 4	0 (Terminal block enabled)	2 (Common serial communication)

Note) To use inter-drive communication (*F806*), *CNDd* can't be set at 2 for slave inverter.

Setting for speed reference (common serial)

Title	Function	Adjustment range	Default setting	Setting
<i>FNDd</i>	Speed setting mode selection	1 ~ 11	2 (RR)	7 (Common serial communication)

Communication parameters (common serial options)

With these parameters, you can set or change the data transmission speed, the parity, inverter numbers and the communication error trip timer with the control panel or Communication.

Title	Function	Adjustment range	Default setting	
<i>F800</i>	Communication rate(common serial)	0: 1200 [bps] 1: 2400 [bps] 2: 4800 [bps] 3: 9600 [bps]	3	
<i>F801</i>	Parity(common serial/RS485)	0: No parity, 1: Even parity, 2: Odd parity	1	
<i>F802</i>	Inverter number(common)	0 ~ 255	0	
<i>F803</i>	Communication time-out (common serial/RS485)	0: OFF, 1 ~ 100 [s]	0	
<i>F804</i>	Communication time-out action (common serial/RS485)			
			RS485	Common serial
		0	No action	No action
		1	Alarm	No action
		2	Trip	No action
		3	No action	Alarm
		4	Alarm	Alarm
		5	Trip	Alarm
		6	No action	Trip
7	Alarm	Trip		
8	Trip	Trip		
<i>F805</i>	Communication waiting time (common serial)	0.00: Normal communications, 0.01 ~ 2.00 [s]	0.00	
<i>F806</i>	Inter-drive communication (common serial)	0: Normal communications (slave operation) 1: Master (frequency reference) 2: Master (output frequency) 3: Master (torque reference) 4: Master (output torque)	0	
<i>F810</i>	Frequency point selection	0: Invalid 1: Common serial 2: RS485 3: Communication add-on cassette option	0	
<i>F811</i>	Point #1 setting	0 ~ 100 [%]	0	
<i>F812</i>	Point #1 frequency	0 ~ FH [Hz]	0.0	
<i>F813</i>	Point #2 setting	0 ~ 100 [%]	100	
<i>F814</i>	Point #2 frequency	0 ~ FH [Hz]	80.0	

: No action: No action is taken even if a timeout occurs.

Alarm: An alarm goes off if a timeout occurs. The message "E" blinks at the left end of the control panel.

Tripping: The inverter trips if a timeout occurs. The message "E r 5" blinks on the control panel.

Note) Changes to the parameters *F800*, *F801*, *F806* do not take effect until the power is turned off and then on again.

6.30.2 Using the RS485 port fitted as standard

With the standard serial RS485, you can connect each inverter to a higher-order control system (host computer) to set up a data communications network between inverters. Also, you can establish a data communications link between a computer and each inverter.

Serial RS485 connectors should be used to connect inverters to one another.

Data transfer specification

Item	Specification
Interface	RS485
Transmission path specification	Half-duplex transmission [2/4-wire, bus architecture (A terminator needs to be attached at each end of the system.)]
Transmission distance	Up to 500 m (overall length of the cable)
Number of connectable units	Up to 32 units (including a host computer) Up to 32
Synchronization mode	Asynchronous transfer
Data transfer rate	Default setting: 9600 bps (parameter setting) Selectable from among 1200, 2400, 4800, 9600, 19200 and 38400 bps
Transmission character	ASCII code ... JIS X 0201 8-bit (ASCII) Binary code ... Binary code, 8-bit fixed
Stop-bit length	Received by inverter: 1 bit, sent from inverter: 2 bits
Error detecting system	Parity: even/ odd/ non (parameter setting), check sum
Error correction function	Not provided
Response monitoring	Not provided
Transmission code	Sending: 11 bit, Reception: 12 bit(with parity)
Transmission waiting time setting	Possible
Others	Action the inverter takes when an timeout occurs: tripping/alarm/no action When alarm is selected, "E" blinks at the left end of the control panel. When tripping is selected, "ERR5" is displayed on the control panel.

An example of the connection of inverters linked to a computer

< Selective communications >

When an operation frequency reference is issued by the host computer to the inverter No.

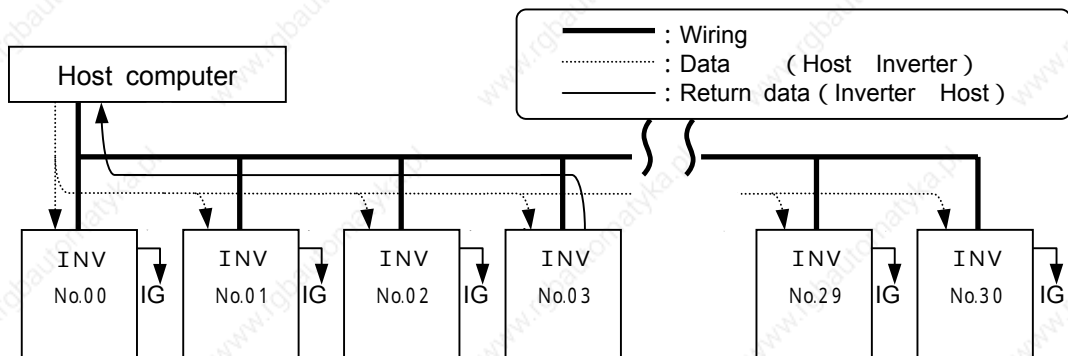

(IG)Ignore: Inverters take no action if their numbers do not agree with the number specified in the command(they ignore data received and get ready to receive the next data.)

: Use a terminal board, etc., to divide each cable into branches.

The host computer transmits data to inverters.

Each inverter receives data from the host computer and checks the number specified by the computer against its number.

Only the inverter with the number that agrees with that specified by the computer decodes the command and takes action according to it.

On completion of the action, the inverter returns the results of the action taken to the host computer, with the inverter number added to this information.

In this case, the inverter No. 3 only operates according to the operation frequency command given by the host computer to it across the network.

< Broadcast communications >

When the host computer to inverters broadcasts an operation frequency reference.

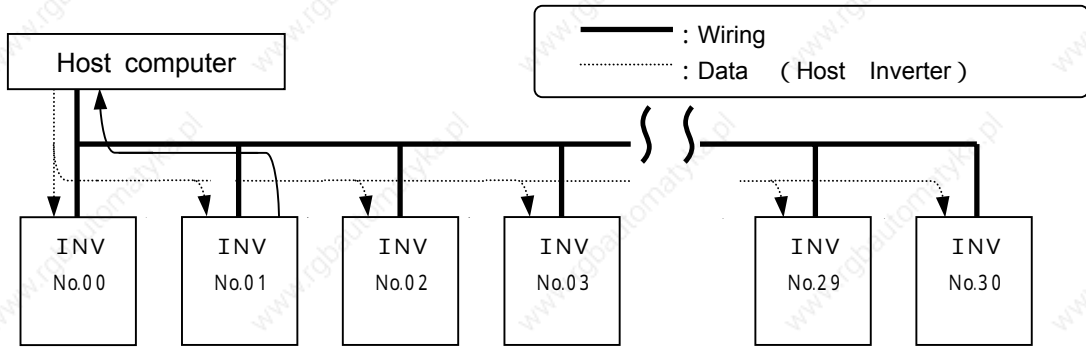

: Use a terminal board, etc., to divide each cable into branches.

The host computer transmits data to inverters.

Each inverter receives data from the host computer and checks the number specified by the computer against its number.

If an asterisk (*) is marked in place of an inverter number, all inverters judge the data to be common to them (broadcast message), decode the command and take action.

To avoid collision between data sets, data from the inverter with an a zero instead of an asterisk only is sent back to the host computer.

In this case, all inverters operate, following the operation frequency command given by the host computer across the network.

Note) Data can also be broadcast to a specific group of inverters (group broadcast communications) by putting a number common to each inverter in the group.(This function is usable only in ASCII mode.)

(Ex.) If "*" is designated, data is broadcast to all inverters bearing the numbers 01, 11, 21, 31, ... 91, and data from the inverter bearing 01 only is sent back to the host.

Inter-drive communications

When inverters (slaves) operate at the same operating frequency as the master inverter to which they are connected (No frequency point is set.)

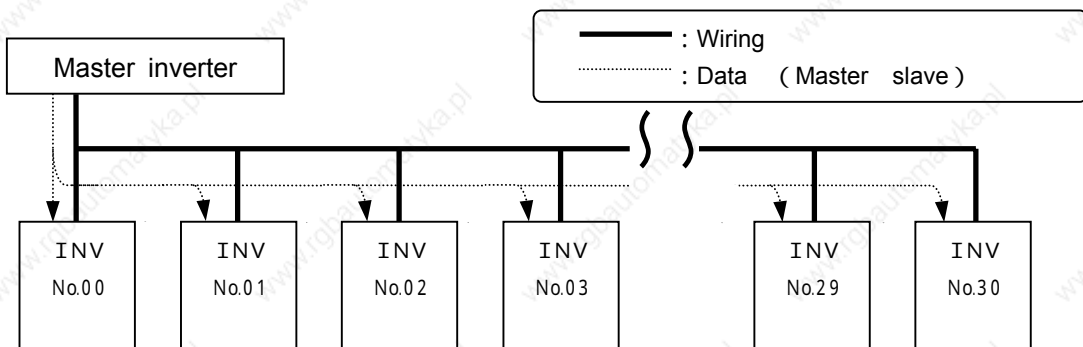

: Use a terminal board, etc., to divide each cable into branches.

The master inverter transmits frequency command data to its slave inverters.

The slave inverters calculate a frequency reference from the data received and save the frequency calculated.

As a result, all slave inverters operate at the same frequency as the master inverter.

(Note) The master inverter always sends frequency command data to its slave inverters, and all slave inverters are always waiting for frequency command data from the master inverter.

Setting of operation command (RS485)

Title	Function	Adjustment range	Default setting	Setting
<i>C00d</i>	Operation command mode selection	0 ~ 4	0(Terminal block enabled)	3(RS485)

Note) To use inter-drive communication (*F826*), *C00d* can't be set at 3 for slave inverter.

Setting of speed reference (RS485)

Title	Function	Adjustment range	Default setting	Setting
<i>F00d</i>	Speed setting mode selection	1 ~ 11	2(RR)	8(RS485)

Communication parameters (standard RS485)

These parameters are used to set or change the data transmission speed, the parity, inverter numbers and the communication error trip timer with the control panel and or a linked control.

Title	Function	Adjustment range	Default setting	
<i>F801</i>	Parity(common serial/RS485)	0: No parity, 1: Even parity, 2: Odd parity	1	
<i>F802</i>	Inverter number	0 ~ 255	0	
<i>F803</i>	Communication time-out (common serial/RS485)	0: OFF, 1 ~ 100 [s]	0	
<i>F804</i>	Communication time-out action (common serial/RS485)			
			RS485	Common serial
		0	No action	No action
		1	Alarm	No action
		2	Trip	No action
		3	No action	Alarm
		4	Alarm	Alarm
		5	Trip	Alarm
		6	No action	Trip
7	Alarm	Trip		
8	Trip	Trip		
<i>F810</i>	Frequency point selection	0: invalid 1: Common serial 2: RS485 3: Communications add-on cassette option	0	
<i>F811</i>	Point #1 setting	0 ~ 100 [%]	0	
<i>F812</i>	Point #1 frequency	0 ~ FH [Hz]	0.0	
<i>F813</i>	Point #2 setting	0 ~ 100 [%]	100	
<i>F814</i>	Point #2 frequency	0 ~ FH [Hz]	80.0	
<i>F820</i>	Communication rate (RS485)	0: 1200 [bps] 1: 2400 [bps] 2: 4800 [bps] 3: 9600 [bps] 4: 19200 [bps] 5: 38400 [bps]	3	
<i>F821</i>	RS485 communication system	0: 2-line system, 1: 4-line system	1	
<i>F825</i>	RS485 communication waiting time	0.00: Norm, 0.01 ~ 2.00 [s]	0.00	
<i>F826</i>	Inter-drive communication (RS485)	0: Normal communications (slave operation) 1: Master (frequency reference) 2: Master (output frequency) 3: Master (torque reference) 4: Master (output torque)	0	

0: No action: No action is taken even if a timeout occurs.

Alarm: An alarm goes off if a timeout occurs. The message "E" blinks at the left end of the control panel.

Tripping: The inverter trips if a timeout occurs. The message "E r s" blinks on the control panel.

Note) Changes to the parameters *F801*, *F820*, *F821*, *F826* do not take effect until the power is turned off and then on again.

7. OPERATION WITH EXTERNAL SIGNAL

7. 1. External Operation

The inverter can be freely controlled externally.

Parameters must be differently set depending on the operation method. Make sure of the operation method before setting parameters, and set parameters properly to the operation mode according to the procedure mentioned below.

[Procedure for setting parameters]

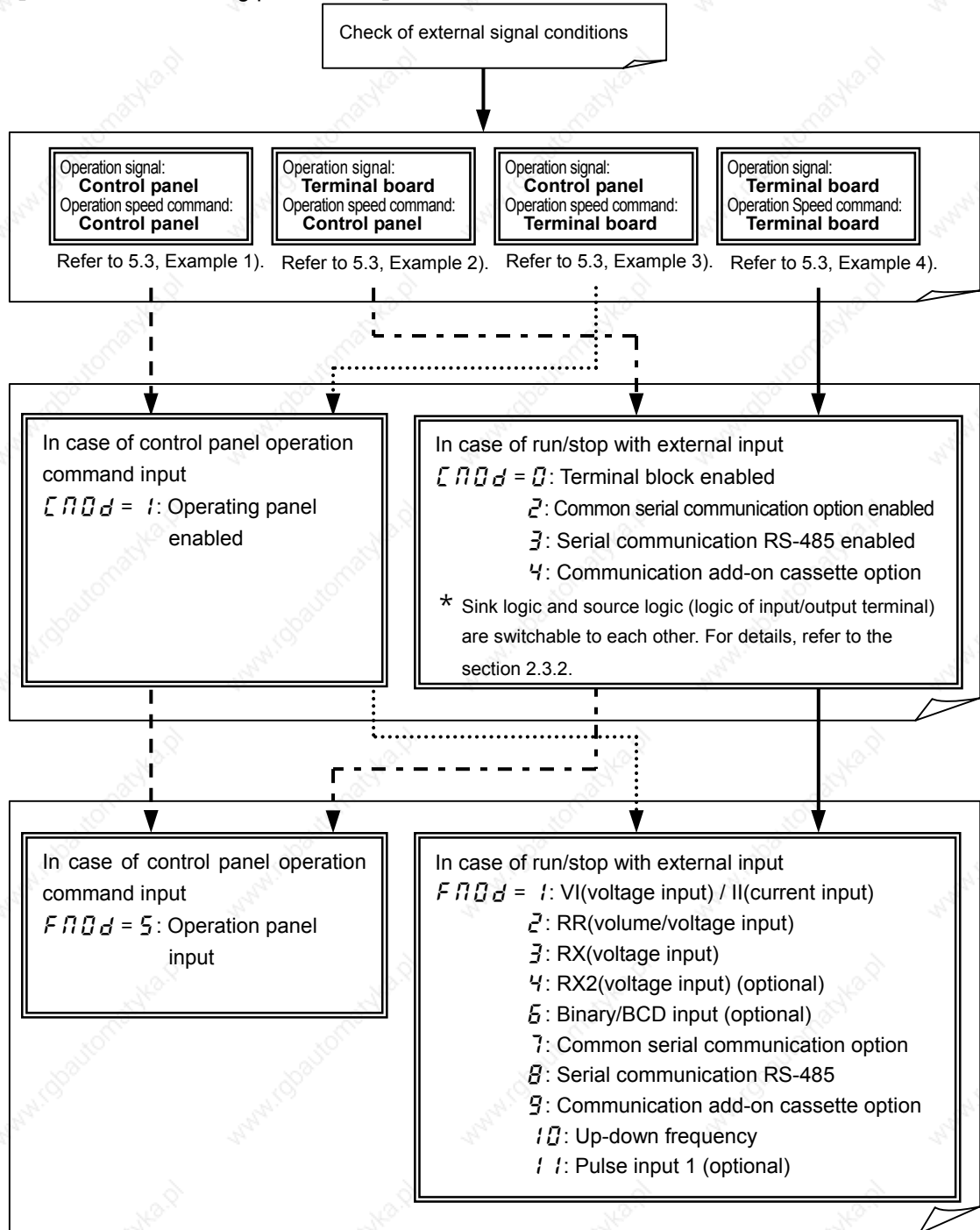

7. 2 Applied operation with input and output signals (operation by the terminal board)

7. 2. 1 Functions of input terminals (in case of sink logic)

Signals that are supplied to control input terminals from the programmable controller, etc. are used to operate or set up the inverter.

Since function of each contact input terminal is selectable from 136 functions, this inverter makes it possible to design a system flexibly.

[Control terminal board]

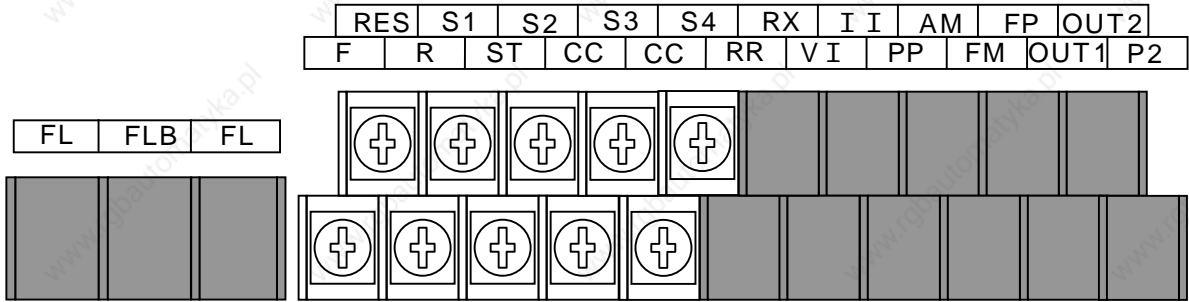

Setting of contact input terminal function

Terminal	Title	Function	Adjustment range	Default setting
-	<i>F 110</i>	Always active function selection	0 ~ 135 (Refer to page G-4.)	0 (No assignment function)
F	<i>F 111</i>	Input terminal selection #1 (F)		2 (Forward rotation)
R	<i>F 112</i>	Input terminal selection #2 (R)		4 (Reverse rotation)
ST	<i>F 113</i>	Input terminal selection #3 (ST)		5 (Standby)
RES	<i>F 114</i>	Input terminal selection #4 (RES)		8 (Reset)
S1	<i>F 115</i>	Input terminal selection #5 (S1)		10 (Preset speed #1)
S2	<i>F 116</i>	Input terminal selection #6 (S2)		12 (Preset speed #2)
S3	<i>F 117</i>	Input terminal selection #7 (S3)		14 (Preset speed #3)
S4	<i>F 118</i>	Input terminal selection #8 (S4)		16 (Preset speed #4)
Option	<i>F 119 ~ F 126</i>	Input terminal selection #9 ~ #16		-

Note: When *F 110* (Always active function selection) is selected, selected function is generally activated regardless of positive or negative logic.

Note: *F 119 ~ F 126* is for use of expansion TB option unit.

Connection method

1) In case of positive logic (a-contact) input

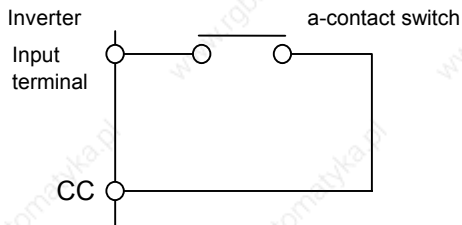

This function is activated when the input terminal and CC (common) are short-circuit, and it is used for forward rotation, reverse rotation, preset speed operation, etc.

2) In case of negative logic (b-contact) input

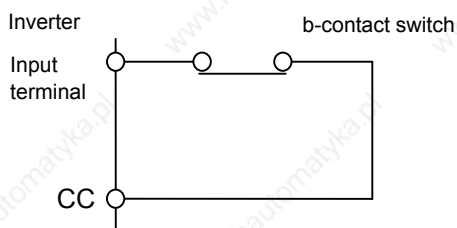

This function is activated when the input terminal and CC (common) are open-circuit, and it is used for standby signal, reset signal, etc.

3) In case of connection with transistor output

Inverter

Programmable controller

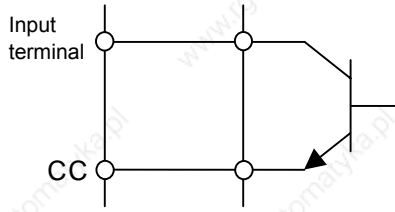

The inverter can be controlled by connecting the input terminal with output (contactless switch) of a programmable controller. This input is used for forward rotation, reverse rotation, preset speed control, etc. Use a transistor that operates on 24VDC, 5mA power.

* Regarding interface between inverter and programmable controller In the case programmable controller of open collector output is used to control the inverter, if the programmable controller is turned off as the power supply to the inverter is on, such a wrong signal as shown in the following figure flows into the inverter because of difference in potential of control power. Be sure to provide the system with an interlock so that the programmable controller cannot be turned off while the inverter is turned on.

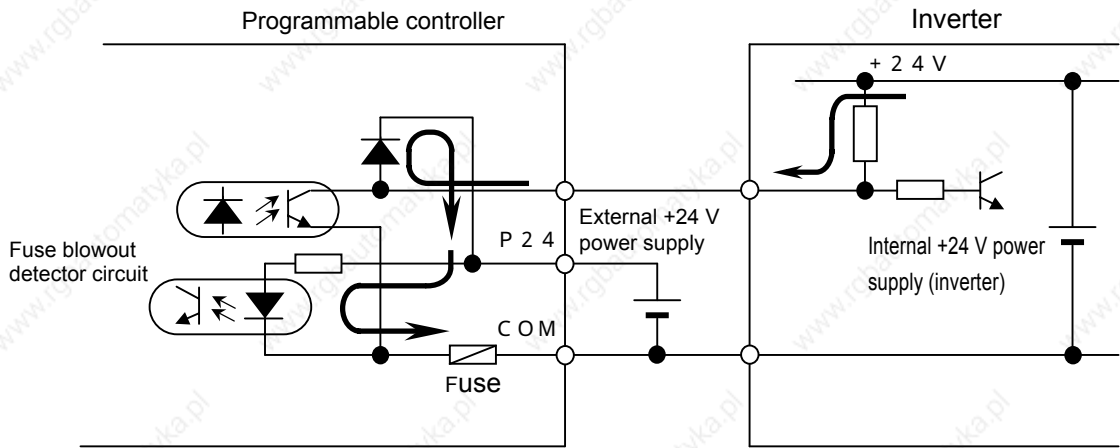

Example of use - Push-type operation stop

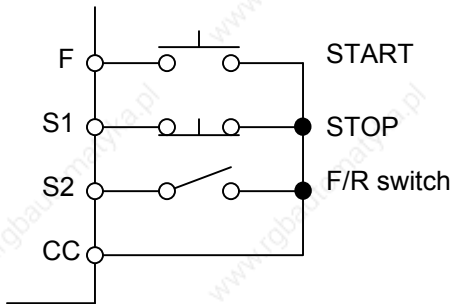

Operation: Press the START button.
 Stop: Press the STOP button.
 Switch between forward and reverse rotation:
 Short circuit between S2 and CC.

[Parameter setting]

Symbol of terminal	Title	Function	Adjustment range	Setting value
F	F 1 1 1	Input terminal selection #1(F)	0 ~ 135 (Refer to page G-4)	94 (PUSH-type run command)
S1	F 1 1 5	Input terminal selection #5(S1)		97 (PUSH-type stop command)
S2	F 1 1 6	Input terminal selection #6(S2)		98 (Forward/reverse selection)

Table of contact input terminal function settings

Parameter setting		Function	Parameter setting		Function
Positive logic	Negative logic		Positive logic	Negative logic	
0	1	No assignment function	70	71	Reservation area(*3)
2	3	F: Forward operation command	72	73	Reservation area(*3)
4	5	R: Reverse operation command	74	75	Reservation area(*3)
6	7	ST: Standby (Inverse)	76	77	Reservation area(*3)
8	9	RES: Reset	78	79	Reservation area(*3)
10	11	S1: Preset-speed #1	80	81	Reservation area(*3)
12	13	S2: Preset-speed #2	82	83	Reservation area(*3)
14	15	S3: Preset-speed #3	84	85	Reservation area(*3)
16	17	S4: Preset-speed #4	86	87	Binary data write
18	19	Jog run	88	89	Up/down frequency (up) (*1)
20	21	Emergency stop	90	91	Up/down frequency (down) (*1)
22	23	DC injection breaking	92	93	Up/down frequency (clear)
24	25	Acceleration/deceleration switching #1(*2)	94	95	PUSH-type run command
26	27	Acceleration/deceleration switching #2(*2)	96	97	PUSH-type stop command
28	29	V/f switching #1(*2)	98	99	Forward/reverse selection
30	31	V/f switching #2(*2)	100	101	Run/stop command
32	33	Torque limit switching #1(*2)	102	103	Commercial power/INV switching
34	35	Torque limit switching #2(*2)	104	105	Frequency reference priority switching
36	37	PID control OFF selection	106	107	VI/II terminal priority
38	39	Pattern group #1	108	109	Command terminal board priority
40	41	Pattern group #2	110	111	Parameter editing enabling
42	43	Pattern group #3	112	113	Control switching (torque, position)
44	45	Pattern group #4	114	115	Deviation counter clear
46	47	Pattern run continuation signal	116	117	Position control forward limit LS
48	49	Pattern run trigger signal	118	119	Position control reverse limit LS
50	51	Forced Jog forward operation	120	121	Light load high-speed operation enabling
52	53	Forced Jog reverse operation	122	123	Reservation area(*3)
54	55	Reservation area(*3)	124	125	Preliminary excitation
56	57	Reservation area(*3)	126	127	System consistent sequence (BC: Braking command)
58	59	Reservation area(*3)	128	129	System-supporting sequence (B: Brake release)
60	61	Reservation area(*3)	130	131	System-supporting sequence (BA: Brake answer)
62	63	Reservation area(*3)	132	133	System-supporting sequence (BT: Brake test)
64	65	Reservation area(*3)	134	135	Reservation area(*3)
66	67	Reservation area(*3)			
68	69	Reservation area(*3)			

(*1): Valid when $F\dot{N}O\dot{D}$ (Speed setting mode selection) is set at $1\dot{0}$ (Up-down frequency).

The frequency setting range is between 0.0 to UL (Upper limit frequency).

In this case, acceleration time is $F500$ (Acceleration time #2), and deceleration time is $F50$!(Deceleration time #2).

(*2): To switch acceleration/deceleration pattern, V/f pattern, torque limit #1 ~ #4, give the following signals to switching functions. (in case of positive logic)

	switching #1	switching #2
Acc/dec, V/f, torque limit #1	OFF	OFF
Acc/dec, V/f, torque limit #2	ON	OFF
Acc/dec, V/f, torque limit #3	OFF	ON
Acc/dec, V/f, torque limit #4	ON	ON

(*3): Reservation area. Do not set at these functions.

Sink logic/source logic

Switching between sink logic and source logic (input/output terminal logic) is possible.

For details, refer to the section 2.3.2.

7. 2. 2 Functions of output terminals (in case of sink logic)

These functions are used to output various signals from the inverter to external equipment. The functions from 0 through 119 can be utilized by setting parameters for the OUT1, OUT2, FL (FLA, FLB, FLC) of the control terminal board.

Control terminal board

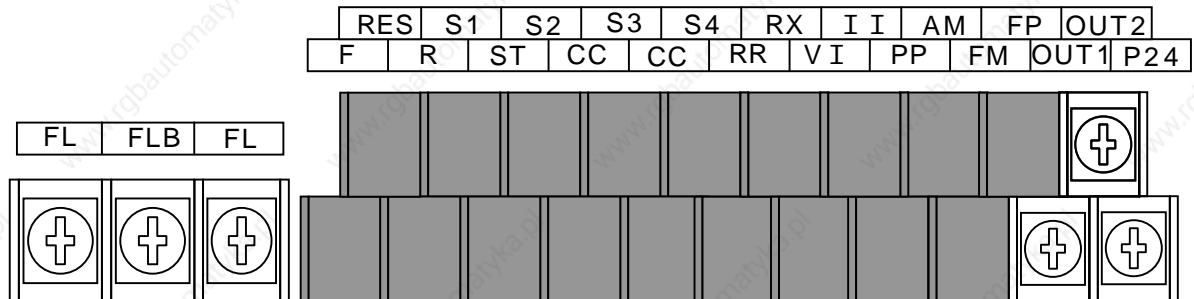

How to use

Function of OUT1 • • To be set by parameter **F 130**

Function of OUT2 • • To be set by parameter **F 131**

Functions of FLA, FLB, FLC • • To be set by parameter **F 132**

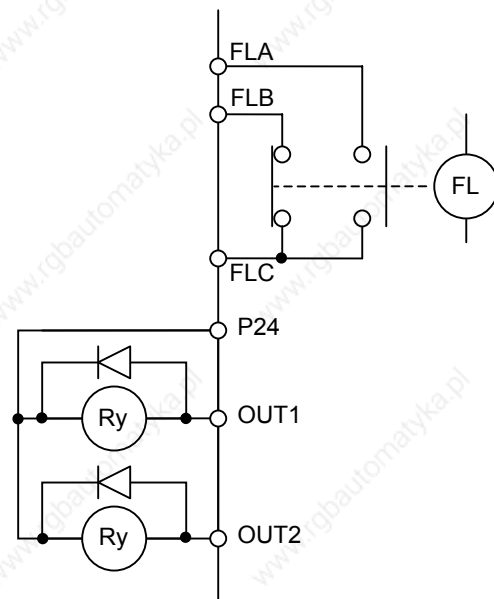

Setting of output terminal functions

Symbol of terminal	Title	Function	Adjustment range	Default setting
OUT1	F 130	Output terminal selection #1(OUT1)	0 ~ 119	4 (Low speed signal)
OUT2	F 131	Output terminal selection #2(OUT2)	0 ~ 119	6 (Acceleration/deceleration completion)
FL	F 132	Output terminal selection #3(FL)	0 ~ 119	10 (Failure FL)
Option	F 133 ~ F 136	Output terminal selection #4 ~ #7	0 ~ 119	-

Output terminal function(open collector, relay outputs) settings and detection levels

< Technical terms >

- Alarm:..... Alarm output beyond a certain setting value
- Pre-alarm: Alarm output of the state where the inverter may carry out a trip by continuation
- Serious failure: Output signal in a serious failure of the protection function of the inverter. (Arm over-current(*OCR 1, 2, 3*), Load side over-current(*OCL*), Short-circuiting(*EF 1, EF 2*), Phase failure(*EPHO, EPH 1*), etc.)
- Light failure: Output signal in a slight failure of the protection function of the inverter. (Over-load(*OL 1, 2*), Over-voltage(*OP 1, 2, 3*), Over-current(*OC 1, 1P, 2, 2P, 3, 3P*), etc.)
- Emergency stop: Output signal when the inverter comes into emergency stop. Stopping manner is set with *F5Q3*(emergency stop).

Table of output terminal functions and detection levels

Parameter setting		Function	Operation output specifications (in case of positive logic)
Positive logic	Negative logic		
0	1	Lower limit frequency (<i>LL</i>)	"ON": The running frequency is equal to or higher than the setting of <i>LL</i> (Lower limit frequency). "OFF": The running frequency is lower than the setting of <i>LL</i> .
2	3	Upper limit frequency (<i>UL</i>)	"ON": The running frequency is equal to or higher than the setting of <i>UL</i> (Upper limit frequency). "OFF": The running frequency is lower than the setting of <i>UL</i> .
4	5	Low speed signal	"ON": The running frequency is equal to or higher than the setting of <i>F 10Q</i> (low-speed signal output frequency). "OFF": The running frequency is lower than the setting of <i>F 10Q</i> .
6	7	Acceleration/deceleration completion	"ON": The difference between the frequency command and the running frequency is within the setting of <i>F 10Z</i> . "OFF": In acceleration or deceleration.
8	9	Specified speed arrival	"ON": The running frequency is in the range of $F 10 1 \pm F 10 2$. "OFF": The running frequency is out of the range of $F 10 1 \pm F 10 2$.
10	11	Failure FL (all trip)	"ON": Inverter is tripped. "OFF": Inverter trip is cancelled.
12	13	Failure FL (except for <i>EF</i> and <i>OCL</i>)	"ON": Inverter is tripped (except <i>EF</i> and <i>OCL</i>). "OFF": Inverter trip is cancelled (reset).
14	15	Over-current pre-alarm	"ON": Inverter output current is over the <i>F5Q 1</i> (Stall prevention level) set value. "OFF": Inverter output current is under the <i>F5Q 1</i> set value.
16	17	Inverter overload pre-alarm	"ON": A certain rate of inverter overload(<i>OL 1</i>) detection time is over. "OFF": The detection time is within a certain limit.
18	19	Motor overload pre-alarm	"ON": A certain rate of motor overload(<i>OL 2</i>) detection time is over. "OFF": The detection time is within a certain limit.
20	21	Overheat pre-alarm	"ON": The temperature of the cooling fin is 85 or higher inside the inverter. "OFF": The temperature drops to 80 or lower after overheat pre-alarm was on.
22	23	Over-voltage pre-alarm	"ON": In over-voltage control operation or PB operation. (200V class: 370 VDC approx., 400V class: 740 VDC approx.)
24	25	Main circuit under-voltage (<i>NOFF</i>) detected	"ON": The main circuit voltage is lower than the main circuit under-voltage detection (<i>NOFF</i>) level. (200V class: 200 VDC approx., 400V class: 380 VDC approx.)
26	27	Low current detected	"ON": <i>F5 1Q</i> is set at <i>Q</i> and the state that inverter output current is <i>F5 1 1</i> set value or larger continued more than <i>F5 1 2</i> set value.
28	29	Over-torque detected	"ON": The state that torque current component is <i>F5 1 6</i> (<i>F5 1 7</i>) set value or larger continued more than <i>F5 1 8</i> set value.
30	31	Braking resistor overload (<i>OL r</i>) pre-alarm	"ON": A certain rate of braking resistor overload trip(<i>OL r</i>) detection time is over. "OFF": The detection time is within a certain limit.
32	33	In emergency stop	"ON": In emergency stop operation (" <i>E</i> " is indicated). "OFF": No emergency stop operation is performed.
34	35	In course of retry	"ON": In retry operation (" <i>r 1 r 3</i> " is indicated). "OFF": No retry operation is performed.
36	37	Pattern run switching output	"ON": In normal operation or pattern operation has finished. "OFF": In pattern operation.

Parameter setting		Function	Operation output specifications (in case of positive logic)
Positive logic	Negative logic		
38	39	PID deviation limit	"ON": PID deviation is in <i>F364</i> or <i>F365</i> set value.
40	41	Run/stop	"ON": Running frequency is output or DC injection breaking (<i>db</i>) is performed.
42	43	Serious failure	"ON": Serious failure(<i>OCA, OCL, EF</i> , phase failure, abnormal output, short-circuit) is detected. "OFF": Inverter has recovered from serious failure. (Serious failure has been reset)
44	45	Light failure	"ON": Light failure (<i>OL, OC1, OC2, OC3, OP</i>) is detected. "OFF": Inverter has recovered from light failure. (Light failure has been reset)
46	47	Commercial/INV switching output #1 (for inverter operation output)	Refer to 6.16.
48	49	Commercial/INV switching output #2 (for commercial operation output)	Refer to 6.16.
50	51	Cooling fan ON/OFF	"ON": Cooling fan is in operation. "OFF": Cooling fan is off operation.
52	53	In Jog run	"ON": In jog run. "OFF": In normal operation.
54	55	Panel operation/terminal board operation switching	"ON": In operation by terminal board. "OFF": In operation by control panel.
56	57	Cumulative operation time alarm	"ON": Cumulative operation time is beyond the <i>F621</i> set value. "OFF": Cumulative operation time is less than the <i>F621</i> set value.
58	59	Abnormal communication alarm #1 (caused by scanning)	"ON": Communication error caused by scanning has occurred. "OFF": Communication error is cancelled (reset).
60	61	Forward/reverse switching	"OFF": In forward operation. "ON": In reverse operation. (The last status is held while operation is suspended.)
62	63	Ready for operation #1	"ON": In operable status or operation can be started with frequency command input as an operation switching answer-back. "OFF": In inoperable status.
64	65	Ready for operation #2	"ON": In operable status or operation can be started with ST and RUN signals and frequency command input "OFF": In inoperable status.
66	67	Poor control power supply (<i>PQFF</i>) pre-alarm	"ON": Control circuit under-voltage is detected (<i>PQFF</i>). (detection level; 200V class: approx. 145 VAC or lower, 400V class: approx. 290 VAC or lower)
68	69	System consistent sequence (BR: Brake release)	Output the braking signal according to the brake sequence.
70	71	In (pre-)alarm status	"ON": More than one of alarm, pre-alarm, under-voltage, low current over-torque, poor control power supply, PID deviation limit, abnormal frequency setting or torque limit have occurred or detected. "OFF": All the alarms above are cancelled.
72	73	Forward speed limit (torque control)	"ON": Forward operation speed is <i>F426</i> set value or over. "OFF": Forward operation speed is less than <i>F426</i> set value.
74	75	Reverse speed limit (torque control)	"ON": Reverse operation speed is <i>F428</i> set value or over. "OFF": Reverse operation speed is less than <i>F428</i> set value.
76	77	Inverter healthy output	"ON" and "OFF" are alternately output at intervals of 1 second.
78	79	Abnormal communication alarm #2 (caused by RS485 logic or message transmission)	"ON": Communication error caused by RS485 logic or message transmission has occurred. "OFF": Communication error is cancelled (reset).
80	81	Error code output #1	Output the failure code in 6bits.
82	83	Error code output #2	
84	85	Error code output #3	
86	87	Error code output #4	
88	89	Error code output #5	
90	91	Error code output #6	

Parameter setting		Function	Operation output specifications (in case of positive logic)
Positive logic	Negative logic		
92	93	Designated data output #1	Output of the designated data in 7 bits.
94	95	Designated data output #2	
96	97	Designated data output #3	
98	99	Designated data output #4	
100	101	Designated data output #5	
102	103	Designated data output #6	
104	105	Designated data output #7	
106	107	Light load signal	"ON": Load is equal to $F335 \sim F340$ (Heavy load torque) set values or less.
108	109	Heavy load signal	"ON": Load is larger than $F335 \sim F340$ set value.
110	111	Positive torque limit	"ON": Positive torque is over the positive torque limit level.
112	113	Negative torque limit	"ON": Negative torque is over the negative torque limit level.
114	115	Output for external rush suppression relay	"ON": External rush suppression relay is actuated.
116	117	Over travel	"ON": Over running
118	119	Completion of positioning	"ON": Positioning has been completed.

Note 1: "ON" in positive logic: Open collector output transistor or relay is turned on.
 "OFF" in positive logic: Open collector output transistor or relay is turned off.
 "ON" in negative logic: Open collector output transistor or relay is turned off.
 "OFF" in negative logic: Open collector output transistor or relay is turned on.

Note 2: Alarm output check conditions are as follows.

- 1) Under-voltage detected: To be checked during operation.
- 2) Low current detected: To be checked during operation command.
- 3) Over-torque detected: To be checked always.

Sink logic/source logic

Sink logic and source logic (input/output terminal logic) can be switched to each other.

Refer to the section 2.3.2

7. 2. 3 Setup of input/output terminal operation time

• Function

The input/output terminal operation time setup function is used to extend response time if there is something malfunctioning because of noise or chattering of input relay.
For each output terminal, delay time at turning on or off can be set individually.

Setup of response time

Title	Function	Adjustment range	Default value
F 140	Input terminal #1 response time (F)	2 ~ 200 [ms]	8
F 141	Input terminal #2 response time (R)	2 ~ 200 [ms]	8
F 142	Input terminal #3 response time (ST)	2 ~ 200 [ms]	8
F 143	Input terminal #4 response time (RES)	2 ~ 200 [ms]	8
F 144	Input terminal #5 ~ 8 response time	2 ~ 200 [ms]	8
F 145	Input terminal #9 ~ 16 response time	2 ~ 200 [ms]	8
F 150	Output terminal #1 delay time (OUT1)	2 ~ 200 [ms]	2
F 151	Output terminal #2 delay time (OUT2)	2 ~ 200 [ms]	2
F 152	Output terminal #3 delay time (FL)	2 ~ 200 [ms]	2
F 153	Output terminal #4 delay time	2 ~ 200 [ms]	2
F 154	Output terminal #5 delay time	2 ~ 200 [ms]	2
F 155	Output terminal #6 delay time	2 ~ 200 [ms]	2
F 156	Output terminal #7 delay time	2 ~ 200 [ms]	2
F 160	Output terminal #1 holding time (OUT1)	2 ~ 200 [ms]	2
F 161	Output terminal #2 holding time (OUT2)	2 ~ 200 [ms]	2
F 162	Output terminal #3 holding time (FL)	2 ~ 200 [ms]	2
F 163	Output terminal #4 holding time	2 ~ 200 [ms]	2
F 164	Output terminal #5 holding time	2 ~ 200 [ms]	2
F 165	Output terminal #6 holding time	2 ~ 200 [ms]	2
F 166	Output terminal #7 holding time	2 ~ 200 [ms]	2

: Setting when vector option unit or expansion TB option unit is used.

Note): The minimum setting unit is 2.5 ms. Please input the value which omitted below the decimal point of a multiple of 2.5.

7. 2. 4 Analog input filter

• Function

This function is effective to remove noise from the frequency setting circuit. If operation is unstable because of noise, increase the time constant of the analog input filter.

Response time setting

Title	Function	Adjustment range	Default value
F 209	Analog input filter	0 (Disabled) to 3 (maximum filter capacity)	0

7. 3 Setup of external speed command (analog signal)

Function of analog input terminals can be selected from four functions (external volume, 0 to 10 VDC, 4 to 20 mA DC, -10 to +10 VDC). The selective function of analog input terminals helps flexible design of a system.

[Control terminal board]

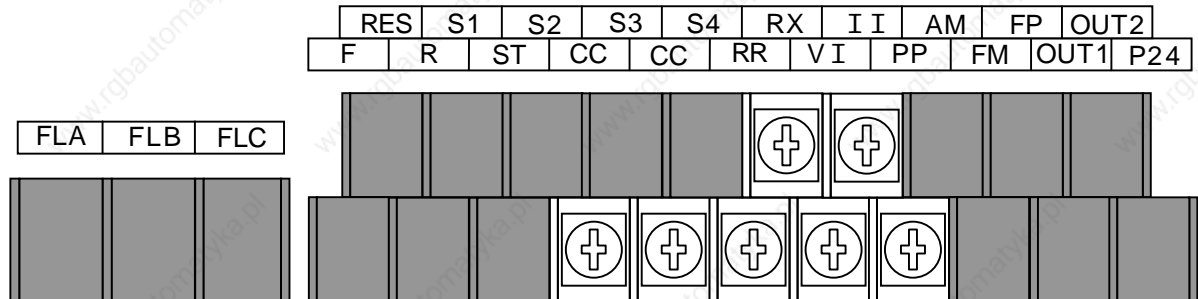

Setting of analog input terminal functions

Terminal symbol	Title	Function	Adjustment range	Default value
-	<i>F200</i>	Reference priority selection	0: <i>F00d</i> 1: <i>F207</i> 2: <i>F00d</i> priority (*1) 3: <i>F207</i> priority (*2) 4: <i>F00d</i> / <i>F207</i> switching (Input terminal function selection 104)	0
VI / II	<i>F201</i>	VI/II reference point #1	0 ~ 100 [%]	20.0
	<i>F202</i>	VI/II reference point #1 frequency	0 ~ <i>FH</i> [Hz]	0.0
	<i>F203</i>	VI/II reference point #2	0 ~ 100 [%]	100
	<i>F204</i>	VI/II reference point #2 frequency	0 ~ <i>FH</i> [Hz]	80.0
	<i>F205</i>	VI/II reference point #1 rate	0 ~ 250 [%]	0
	<i>F206</i>	VI/II reference point #2 rate	0 ~ 250 [%]	100
-	<i>F207</i>	Speed setting mode selection #2	Same as <i>F00d</i> (1 ~ 11)	1
-	<i>F208</i>	fmod/f207 switching frequency	0 ~ <i>FH</i> [Hz]	1.0
All	<i>F209</i>	Analog input filter	0(disabled) to 3(max. filter capacity)	0
RR	<i>F210</i>	RR reference point #1	0 ~ 100 [%]	0
	<i>F211</i>	RR reference point #1 frequency	0 ~ <i>FH</i> [Hz]	0.0
	<i>F212</i>	RR reference point #2	0 ~ 100 [%]	100
	<i>F213</i>	RR reference point #2 frequency	0 ~ <i>FH</i> [Hz]	80.0
	<i>F214</i>	RR reference point #1 rate	0 ~ 250 [%]	0
	<i>F215</i>	RR reference point #2 rate	0 ~ 250 [%]	100
RX	<i>F216</i>	RX reference point #1	- 100 ~ 100 [%]	0
	<i>F217</i>	RX reference point #1 frequency	- <i>FH</i> ~ <i>FH</i> [Hz]	0.0
	<i>F218</i>	RX reference point #2	- 100 ~ 100 [%]	100
	<i>F219</i>	RX reference point #2 frequency	- <i>FH</i> ~ <i>FH</i> [Hz]	80.0
	<i>F220</i>	RX reference point #1 rate	- 250 ~ 250 [%]	0
	<i>F221</i>	RX reference point #2 rate	- 250 ~ 250 [%]	100
Option	<i>F222</i> - <i>F237</i>	RX2,BIN,pulse input point setup	For details, refer to the instructions of the option.	

Note: Input terminals of RX2, BIN and pulse input are at expansion TB option unit.

7. 3. 1 Setup by analog input signals (RR terminal)

If a variable resistor (1-10 kΩ, 1/4 W) for setting up frequency is connected with the RR terminal, the inverter can be run and stopped with external commands.

For bringing this function into practice, connect a potentiometer to the terminals of PP, RR and CC so as to divide the reference voltage (10 VDC) at the terminal PP and to input 0 to 10 VDC of divided voltage between the RR and CC terminals.

If analog voltage signal of 0 to 10 VDC is input between the terminals of RR and CC, frequency can be set up without connection of a potentiometer.

<Related parameters>

Title	Function	Adjustment range	Default value	Setup value
<i>F00d</i>	Operation command mode selection	0 ~ 4	0(Terminal)	0(Terminal)
<i>F00d</i>	Speed setting mode selection	1 ~ 11	2(RR)	2(RR)
<i>F05L</i>	FM terminal meter selection	1 ~ 31	1	1
<i>F0</i>	FM terminal meter adjustment	-	-	-
<i>F200</i>	Reference priority selection	0 ~ 4	0(<i>F00d</i>)	0(<i>F00d</i>)
<i>F209</i>	Analog input filter	0(Disabled) to 3(Max. filter capacity)	0	0
<i>F210</i>	RR reference point #1	0 ~ 100 [%]	0	0
<i>F211</i>	RR reference point #1 frequency	0 ~ FH [Hz]	0.0	0.0
<i>F212</i>	RR reference point #2	0 ~ 100 [%]	100	100
<i>F213</i>	RR reference point #2 frequency	0 ~ FH [Hz]	80.0	80.0
<i>F214</i>	RR reference point #1 rate	0 ~ 250 [%]	0	0
<i>F215</i>	RR reference point #2 rate	0 ~ 250 [%]	100	100

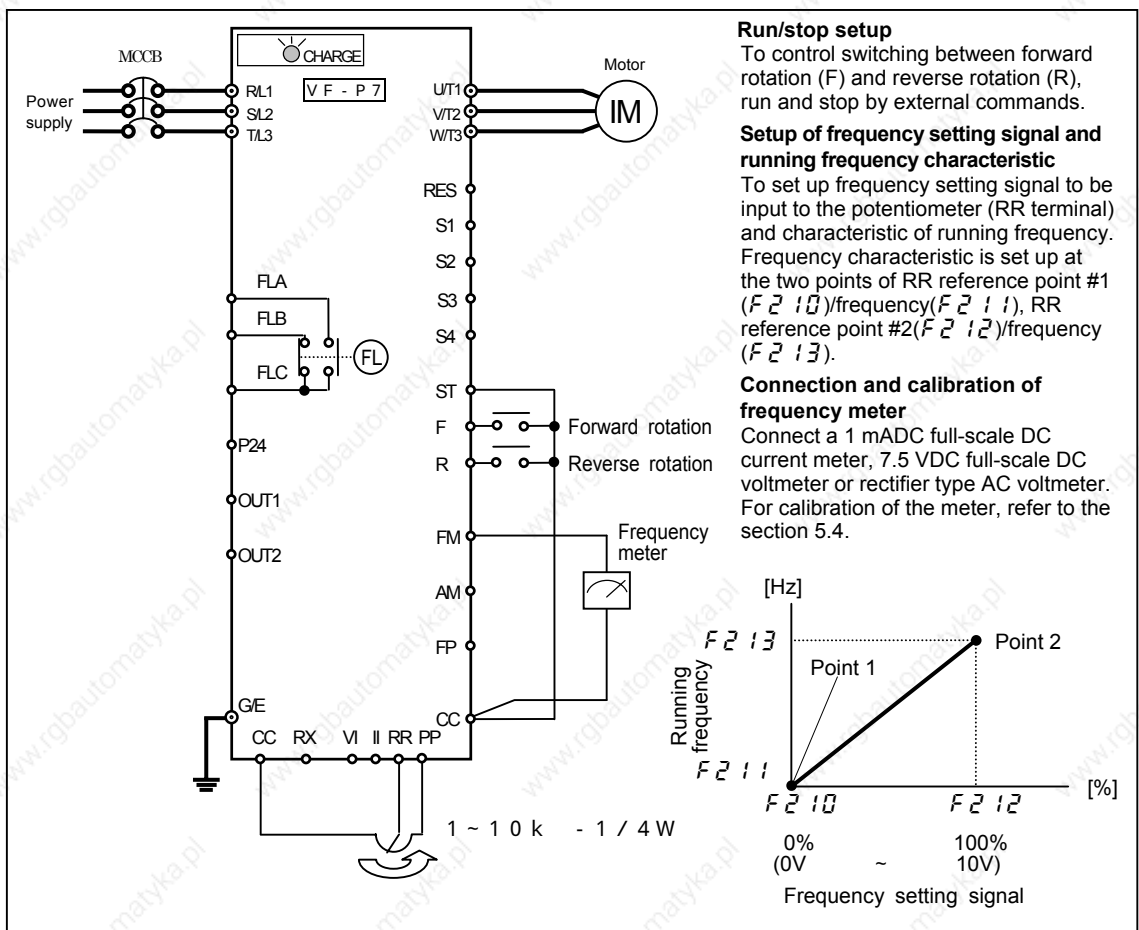

7. 3. 2 Setup by analog input signals (VI/II terminal)

Connect current signal (4 to 20 mADC) to the terminal II or voltage signal (0 to 10 VDC) to the terminal VI so that the inverter can be run and stopped with external commands.

<Related parameters>

Title	Function	Adjustment range	Default value	Setup value
<i>CNOd</i>	Operation command mode selection	0 ~ 4	0(Terminal)	0(Terminal)
<i>FNOd</i>	Speed setting mode selection	1 ~ 11	2(RR)	1(VI/II)
<i>FNSL</i>	FM terminal meter selection	1 ~ 31	1	1
<i>FN</i>	FM terminal meter adjustment	-	-	-
<i>F200</i>	Reference priority selection	0 ~ 4	0(<i>FNOd</i>)	0(<i>FNOd</i>)
<i>F201</i>	VI/II reference point #1	0 ~ 100 [%]	20	
<i>F202</i>	VI/II reference point #1 frequency	0 ~ FH [Hz]	0.0	0.0
<i>F203</i>	VI/II reference point #2	0 ~ 100 [%]	100	100
<i>F204</i>	VI/II reference point #2 frequency	0 ~ FH [Hz]	80.0	80.0
<i>F205</i>	VI/II reference point #1 rate	0 ~ 250 [%]	0	0
<i>F206</i>	VI/II reference point #2 rate	0 ~ 250 [%]	100	100
<i>F209</i>	Analog input filter	0(Disabled) to 3(Max. filter capacity)	0	0

: Set "20" when current signal (4 to 20 mADC) is connected to the terminal II, or set "0" when voltage signal (0 to 10 VDC) is connected to the terminal VI.

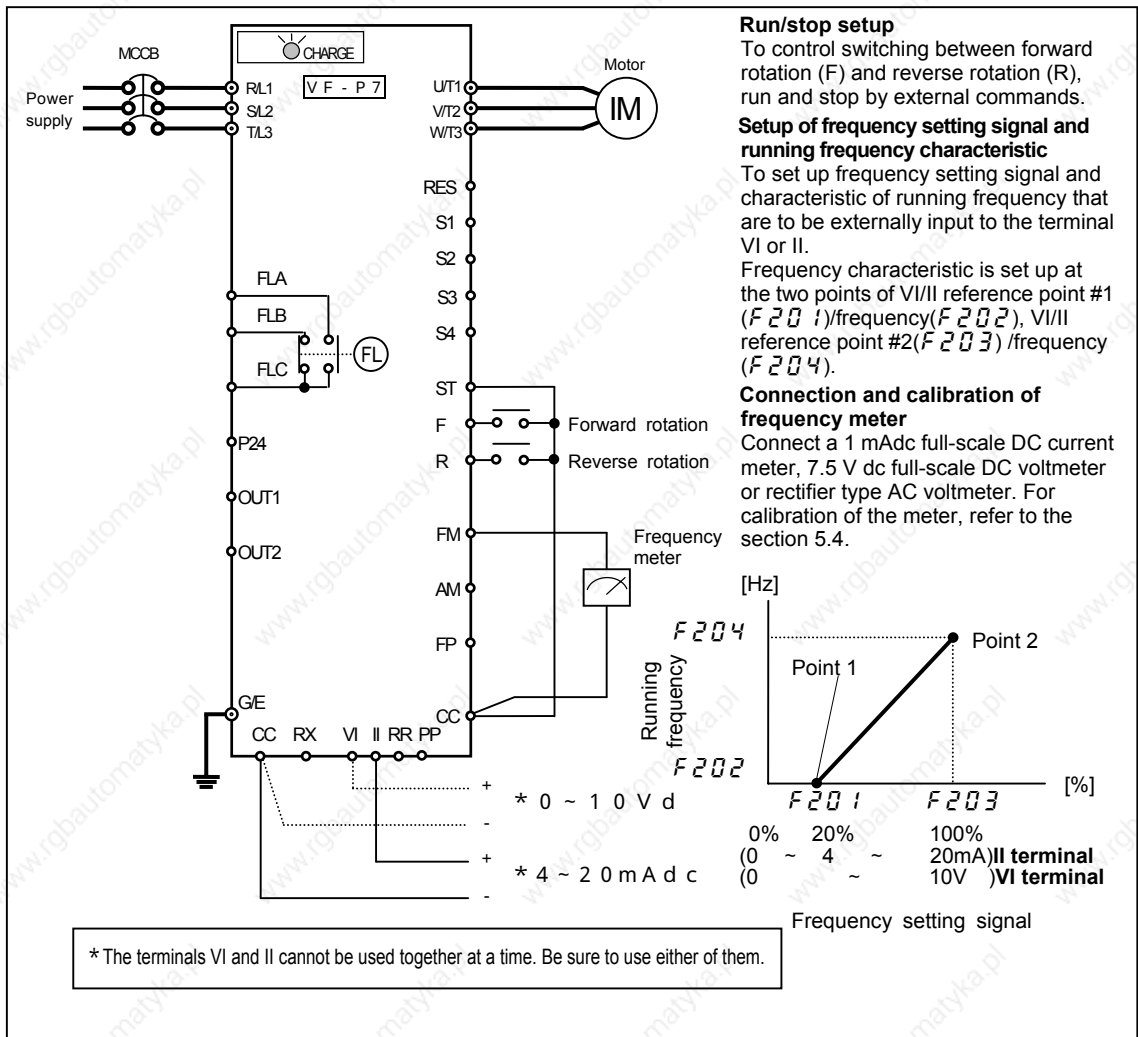

7. 3. 3 Setup by analog input signals (RX terminal)

Connect voltage signal (0 to ± 10 VDC) to the terminal RX so that the inverter can be run and stopped with external commands.

<Related parameters>

Title	Function	Adjustment range	Default value	Setup value
<i>F00d</i>	Operation command mode selection	0 ~ 4	0(Terminal)	0(Terminal)
<i>F00d</i>	Speed setting mode selection	1 ~ 11	2(RR)	3(RX)
<i>F05L</i>	FM terminal meter selection	1 ~ 31	1	1
<i>F0</i>	FM terminal meter adjustment	-	-	-
<i>F200</i>	Reference priority selection	0 ~ 4	0(<i>F00d</i>)	0(<i>F00d</i>)
<i>F209</i>	Analog input filter	0(Disabled) to 3(Max. filter capacity)	0	0
<i>F216</i>	RX reference point #1	- 100 ~ 100 [%]	100	100
<i>F217</i>	RX reference point #1 frequency	- FH ~ FH [Hz]	0.0	0.0
<i>F218</i>	RX reference point #2	- 100 ~ 100 [%]	100	100
<i>F219</i>	RX reference point #2 frequency	- FH ~ FH [Hz]	80.0	80.0
<i>F220</i>	RX reference point #1 rate	- 250 ~ 250 [%]	0	0
<i>F221</i>	RX reference point #2 rate	- 250 ~ 250 [%]	100	100

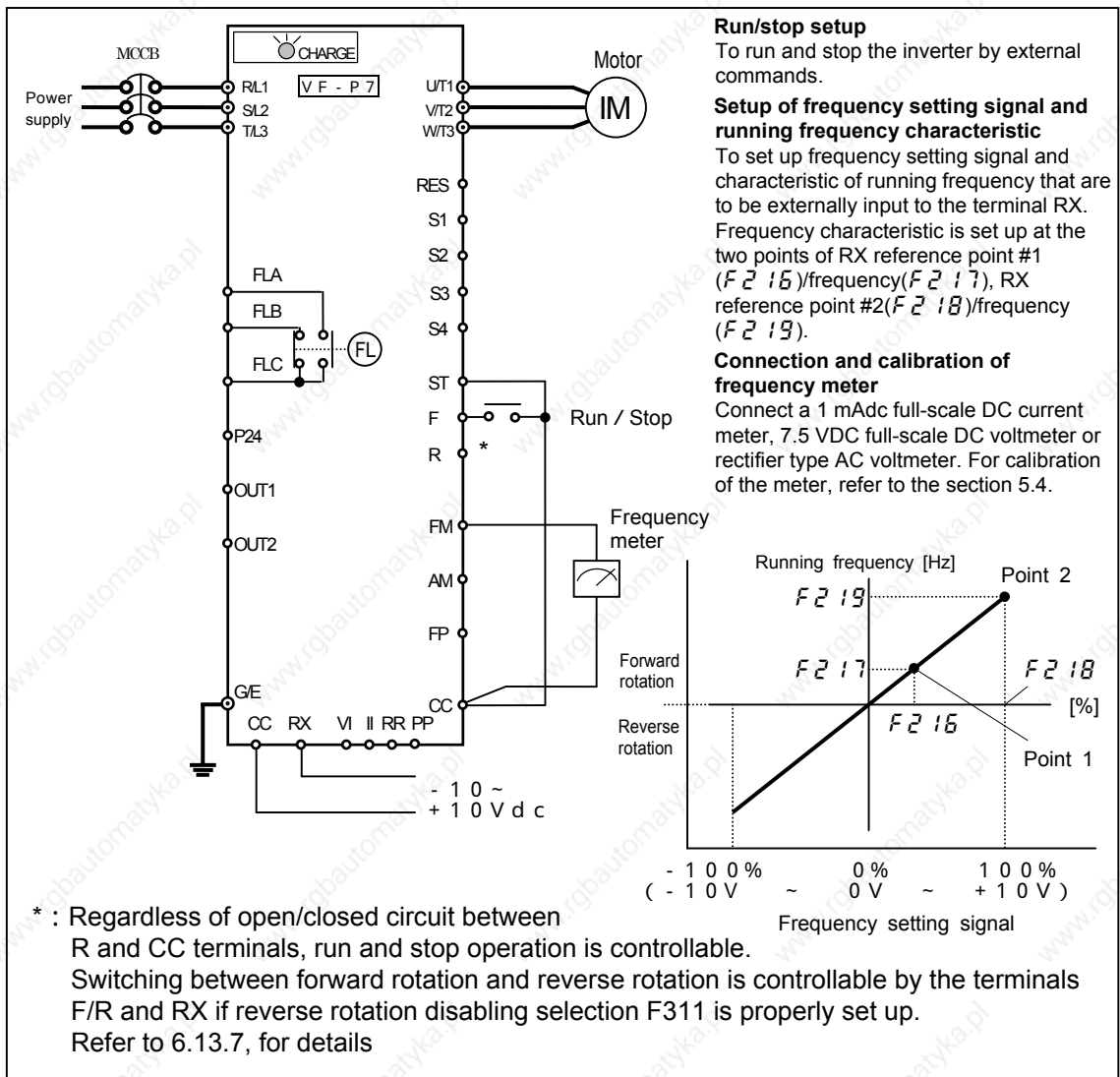





















8. Monitoring operation status

8. 1 Status monitor mode

Status of the inverter can be monitored.
To monitor the inverter when it is normally running,

Press the  key **twice** and the current status is indicated on the LED display.

Setup procedure to monitor the inverter status. (EX. Operation at 60 Hz)

Com.No.	Details of indication	Key operated	LED display	Description
* 1	Standard monitor mode		50.0	Running frequency indication (in operation) (In the case monitor display mode setting F710 is set at 0[running frequency])
FE01	Parameter setup mode		RU 1	Indication of "Automatic acceleration /deceleration(RU 1)" that is the first basic parameter
FE01	Status monitor mode (rotating direction)		F r - F	Indication of rotating direction (F : forward, r : reverse)
* 2	Frequency command		50.0	Indication of frequency command value. (In case of F711=1)
* 3	Load indication		LB0	Indication of inverter output current (load current)(In case of F712=2)
* 4	DC voltage		U 100	Indication of inverter DC voltage (Default setting unit: [%]) (In case of F713=3)
* 5	Output voltage		P 100	Indication of inverter output voltage (Default setting unit: [%]) (In case of F714=4)
FE06	Input terminal information #1		1111111	Indication of ON/OFF status of control input terminals (F, R, RES, ST, S1, S2, S3, S4) in bits
FE50 FE51	Input terminal information #2		A 1111	Indication of ON/OFF status of optional control input terminals (B8,B9,B10,B11) in bits
	Input terminal information #3		b 1111	Indication of ON/OFF status of optional control input terminals (B11,B12,B13,B14) in bits
FE07	Output terminal information #1		111	Indication of ON/OFF status of control output terminals (OUT1,OUT2,FL) in bits
FE52 FE53	Output terminal information #2		0 1111	Indication of ON/OFF status of optional control output terminals (R1,R2,OUT3,OUT4) in bits
	Output terminal information #3		P 1111	Indication of ON/OFF status of optional control output terminals (ALM0,ALM1,ALM2,ALM3) in bits
FE48	Sink/source switching status		L 0	Indication of sink or source status (0: source, 1: sink)
FE47	Type of connected option		0 0	Indication of connected options
FE54	t YP last set data		t 0	Indication of t YP value set last
FE55	RU2 last set data		R 0	Indication of RU2 value set last
FE08	CPU version		U 120	Indication of version of the CPU
FE43	Flush memory version		F 100	Indication of version of the flush memory
FE09	Control EEPROM version		E 0	Indication of version of the control EEPROM
FE44	Drive EEPROM version		d 100	Indication of version of the drive EEPROM

(Continued on the following page)

(Continued from the preceding page)

Com.No.	Details of indication	Key operated	LED display	Description
FE10	Past trip #1	○	0C3 1	(Alternately blinking at intervals of 0.5 second) Past trip #1
FE11	Past trip #2	○	0H 2	(Alternately blinking at intervals of 0.5 second) Past trip #2
FE12	Past trip #3	○	0P3 3	(Alternately blinking at intervals of 0.5 second) Past trip #3
FE13	Past trip #4	○	nErr 4	(Alternately blinking at intervals of 0.5 second) Past trip #4
FE14	Cumulative operation time	○	t 0.1	Indication of total (accumulated) operation hours(Indication of 0.1 represents 10 hours.)
	Standard monitor mode	MON (Note 1)	50.0	Running frequency indication(in operation)

Note 1: When ○ or ○ key is pressed, indication changes in the status monitor mode.

Note 2: Contents of status indications of *1, *2, *3, *4 and *5 can be selected from 30 kinds of information. Unit of current and voltage indications can be changed from % to A (amperage) and V (voltage) and vice versa respectively.

Note 3: Indicated input voltage is DC voltage just after input voltage is rectified multiplied by 1/ 2.

Note 4: Past trip is in order of 1(last) 2 3 4(oldest)

Note 5: Cumulative operation time indicates a total of actually running hours.

Information on input terminals

Information on *A* input terminals and *b* input terminals are for the optional add-on cassette.

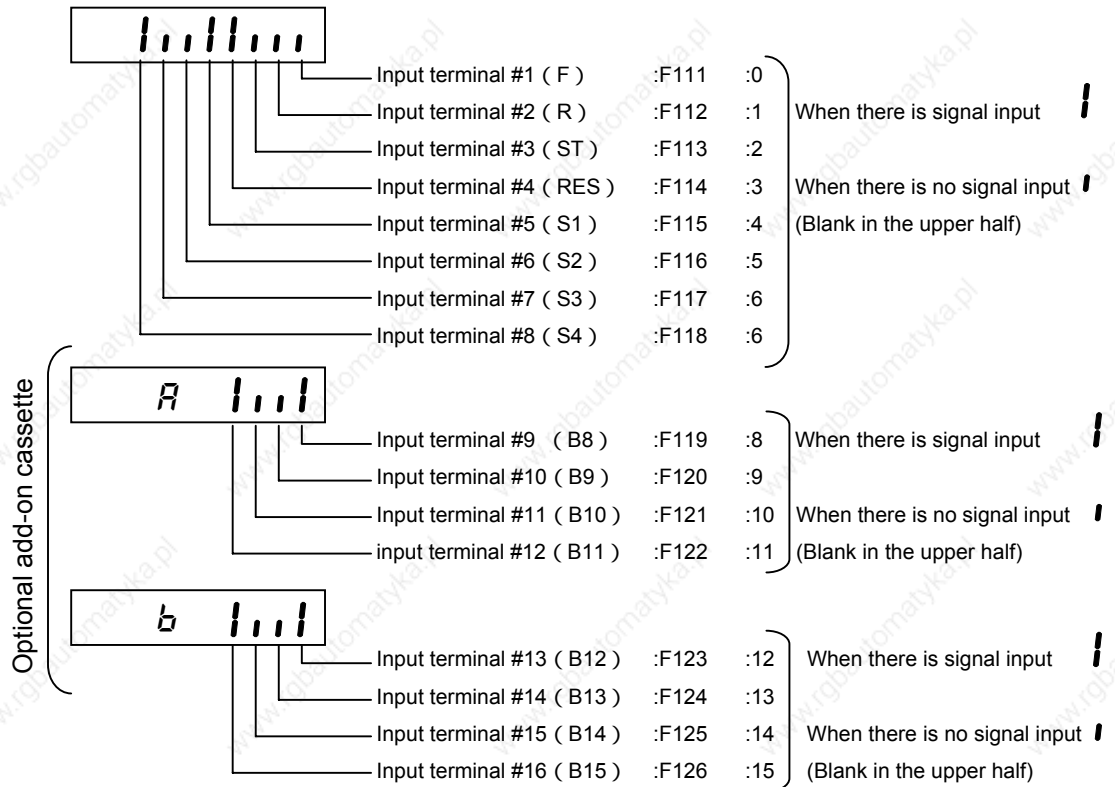

Input terminal #9 to #16: Expansion TB option unit

Note) When *F 10 7* is set at a number of *1* to *8* expansion TB option input terminal information (*A, b*) indicate information of lower 8 bit terminal (B0 ~ B7).

Information on output terminals

Information on □ output terminals and P output terminals are for the optional add-on cassette.

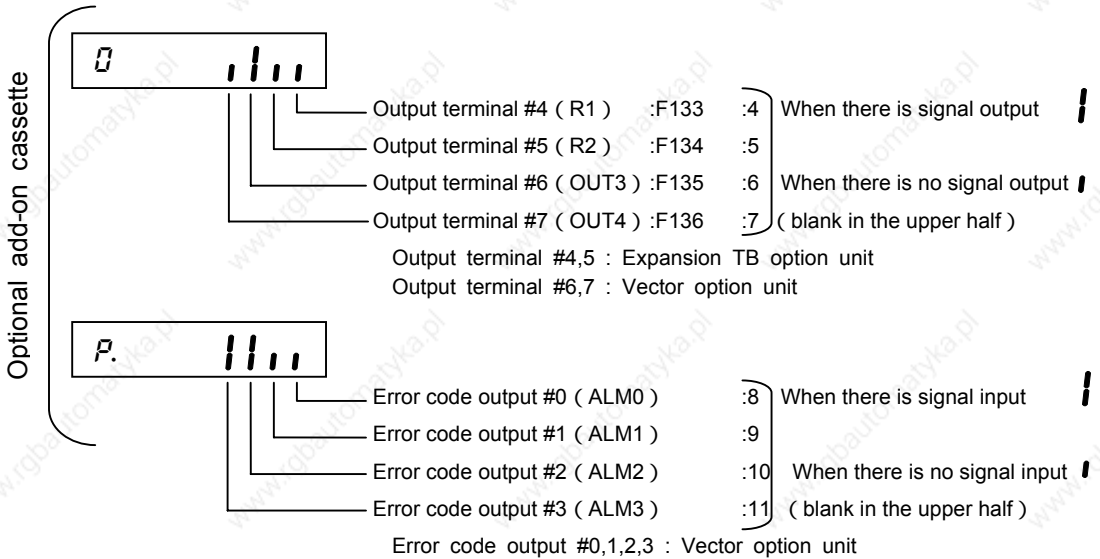
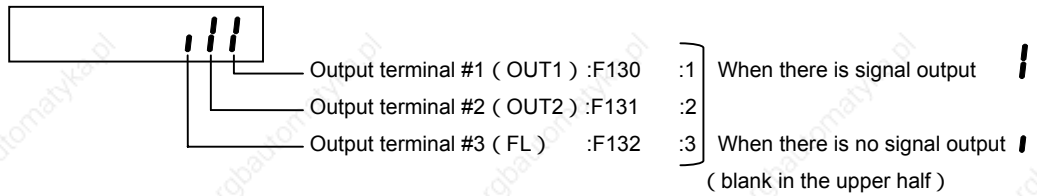

Type of connected option

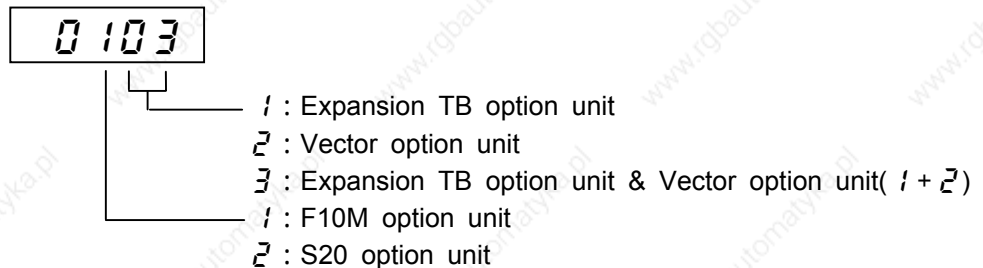

Note1) Connection of add-on cassette options are reflected in this display.

Note2) Connection of PG feedback boards are not in this display.

Total (accumulated) operation hours

For indication of total operation hours, running hours are counted up when the output frequency monitor reads a frequency other than 0.0 Hz. 10 hours is indicated as 0.1 (unit of indication). Total hours is indicated in the range from "0. 1" to "9999" that represent 10 hours and 9999 hours respectively.

8. 2 Changing status monitor function

Changing indication of status with power on

The standard monitor mode (*1) indicates running frequency (with default setting) such as "0.0" when power is on or "0FF" when power is off, however, such the standard indication can be changed into arbitrary indication as shown on page H-5. When the standard monitor indication is changed for an option, each indication appears lacking in the initial letter (E, F, etc.).

• **Standard monitor mode** **Standard monitor indication selection (F 7)**

Title	Function	Adjustment range	Default setting
F 7 10	Monitor display mode setting	0 ~ 29 (Refer to the next page.)	0

Changing contents of status monitor indication

Regarding contents of status monitor indications appearing in the left column of the table on page H-1, those marked with *2 to *5 can be changed for others. Select a desirable monitor function from among optional monitor functions appearing on page H-5.

- *2 Frequency command Changeable by status monitor #1 display mode (F 7 11).
- *3 Load current Changeable by status monitor #2 display mode (F 7 12).
- *4 Input voltage Changeable by status monitor #3 display mode (F 7 13).
- *5 Output voltage Changeable by status monitor #4 display mode (F 7 14).

Title	Function	Adjustment range	Default setting
F 7 11	Status monitor #1 display mode	0 ~ 29 (Refer to the next page.)	1
F 7 12	Status monitor #2 display mode	0 ~ 29 (ditto)	2
F 7 13	Status monitor #3 display mode	0 ~ 29 (ditto)	3
F 7 14	Status monitor #4 display mode	0 ~ 29 (ditto)	4

If F 7 11 to F 7 14 are set at "0" (Running frequency) the running frequency is not held in trip status.

[Setup values of monitor indication parameters(F 7 1 1~F 7 1 4)]

Com. No.	Setup value	Function	Indication	Unit(Panel)	Unit(Communication)
FD00	0	Running frequency	600	Depends on F 7 0 3	0.01[Hz]
FE02	1	Frequency command	600	ditto	0.01[Hz]
FE03	2	Current	C 0	1[%] or F 7 0 1	0.01[%]
FE04	3	DC voltage	Y 0	ditto	0.01[%]
FE05	4	Output voltage	P 0	ditto	0.01[%]
FE015	5	After-compensation frequency	600	Depends on F 7 0 3	0.01[Hz]
FE16	6	Speed feedback (real-time value)	0	ditto	0.01[Hz]
FE17	7	Speed feedback (1 second filter)	0	ditto	0.01[Hz]
FE18	8	Torque	t 0	1[%]	0.01[%]
FE19	9	Torque reference	t 0	1[%]	0.01[%]
FE56	10	Internal torque reference (*1)	t 0	1[%]	0.01[%]
FE20	11	Torque current	t 0	1[%]	0.01[%]
FE21	12	Exciting current	C 0	1[%]	0.01[%]
FE22	13	PID feedback value	d 0	Depends on F 7 0 3	0.01[Hz]
FE23	14	Motor overload factor (OL2 data)	L 0	1[%]	0.01[%]
FE24	15	Inverter overload factor (OL1 data)	G 0	1[%]	0.01[%]
FE25	16	PBr overload factor (PBrOL data)	r 0	1[%]	0.01[%]
FE28	17	PBr load factor (pulse duty)	r 0	1[%]	0.01[%]
FE29	18	Input power	H 0	0.1[kW]	0.01[kW]
FE30	19	Output power	H 0	0.1[kW]	0.01[kW]
FE31	20	Peak output current	C 0	1[%] or F 7 0 1	0.01[%]
FE32	21	Peak DC voltage	Y 0	ditto	0.01[%]
FE33	22	Motor counter dummy PG	P 0	1/100 count	1 count
FE34	23	Position pulse	P 0	1/100 count	1 count
FE35	24	PR input	J 0	1[%]	0.01[%]
FE36	25	VI/II input	J 0	1[%]	0.01[%]
GE37	26	RX input	J 0	1[%]	0.01[%]
FE38	27	RX2 input	J 0	1[%]	0.01[%]
FE39	28	FM output	R 0	1[%]	0.01[%]
FE40	29	AM output	R 0	1[%]	0.01[%]

8. 3 Indication in trip status

When the inverter trips, details of the trip status are indicated. In the status monitor mode, the status when the inverter trips is held.





















Details of indications of trip status

Trip indication	Details	Com. code	Error code
<i>OC1,OC1P</i>	Over-current during acceleration	1,37	25,29
<i>OC2,OC2P</i>	Over-current during deceleration	2,38	26,30
<i>OC3,OC3P</i>	Over-current during constant speed	3,39	27,31
<i>OCL</i>	Trip caused by short-circuit in the loaded side on starting	4	41
<i>OCRA1</i>	U-phase arm over-current	5	61
<i>OCRA2</i>	V-phase arm over-current	6	62
<i>OCRA3</i>	W-phase arm over-current	7	63
<i>EPH1</i>	Input phase failure	8	44
<i>EPH0</i>	Output phase failure	9	40
<i>OP1</i>	Over-voltage during acceleration	10	21
<i>OP2</i>	Over-voltage during deceleration	11	22
<i>OP3</i>	Over-voltage during constant speed	12	23
<i>OL1</i>	Inverter overload	13	17
<i>OL2</i>	Motor overload	14	18
<i>OLr</i>	Dynamic braking resistor trip by overload	15	16
<i>OH</i>	Overheat	16	19
<i>E</i>	Emergency stop	17	14
<i>EEP1</i>	EEPROM error (write error)	18	49
<i>EEP2</i>	Initial read error	19	50
<i>EEP3</i>	Initial read error	20	51
<i>Eerr2</i>	Main RAM error	21	48
<i>Eerr3</i>	Main ROM error	22	53
<i>Eerr4</i>	CPU error	23	55
<i>Eerr5</i>	Communication abnormal interruption	24	15
<i>Eerr6</i>	Gate array fault	25	54
<i>Eerr7</i>	Output current detector error	26	58
<i>Eerr8</i>	Option error	27	57
<i>Eerr9</i>	Flush memory fault	28	52
<i>UC</i>	Trip of low current operation status	29	4
<i>UP1</i>	Trip by insufficient voltage (main circuit power supply)	30	5
<i>UP2</i>	Trip by insufficient voltage (control circuit power supply)	31	6
<i>OLt</i>	Trip by over-torque	32	7
<i>EF1</i>	Trip by short-circuit	33	45
<i>EF2</i>		34	46
<i>Et_n</i>	Auto-tuning error	40	13
<i>Et4P</i>	Inverter type error	41	56
<i>E-10</i>	Sink/source switching error	42	32
<i>E-11</i>	Sequence error	43	37
<i>E-12</i>	Disconnection of encoder	44	36
<i>E-13</i>	Abnormal speed	45	11
<i>E-14</i>	Extreme potential deviation	46	9
<i>E-17</i>	Key error	49	33
<i>nEerr (*1)</i>	No error	0	0

Note: Past trip indications (that have been saved in the memory or that appeared in the past) can be read out. (Refer to "Status monitor mode, 8.1".)

(*1)This is not a trip indication, but it appears when no error record is found in monitoring the past trip indications.

Examples of reading out trip data

Com.No.	Contents of indication	Key operated	LED display	Description
FC90	Trip information		<i>OP2</i>	Status monitor mode (Blinking for trip indication) Motor is in free-run status.
-	Parameter setup mode		<i>AU1</i>	Indication of "Automatic acceleration/deceleration (<i>AU1</i>)" that is the first basic parameters.
FE00	Running frequency		<i>40.0</i>	Indication of running frequency when trip occurred.
FE01	Running direction		<i>F r - F</i>	Indication of direction of rotation when trip occurred. (<i>F</i> : Forward rotation, <i>r</i> : Reverse rotation)
* 2	-		<i>60.0</i>	Indication of frequency command value when trip occurred.
* 3	-		<i>C 130</i>	Indication of inverter output current (load current) when trip occurred.
* 4	-		<i>Y 141</i>	Indication of inverter DC voltage when trip occurred.
* 5	-		<i>P 100</i>	Indication of inverter output voltage when trip occurred.
FE06 FE50 FE51	Input terminal information #1		<i>111111</i>	Indication of ON/OFF status of control input terminals (F, R, RES, ST, S1, S2, S3, S4) when trip occurred.
	Input terminal information #2		<i>A 1111</i>	Indication of ON/OFF status of optional control input terminals (B8, B9, B10, B11) when trip occurred.
	Input terminal information #3		<i>b 1111</i>	Indication of ON/OFF status of optional control input terminals (B12, B13, B14, B15) when trip occurred.
FE07 FE52 FE53	Output terminal information #1		<i>111</i>	Indication of ON/OFF status of control output terminals (OUT1, OUT2, FL) when trip occurred.
	Output terminal information #2		<i>Q 1111</i>	Indication of ON/OFF status of optional control output terminals (R1, R2, OUT3, OUT4) when trip occurred.
	Output terminal information #3		<i>P 1111</i>	Indication of ON/OFF status of optional control output terminals (ALM0, ALM1, ALM2, ALM3) when trip occurred.
FE48	Sink/source switching status		<i>L 1</i>	Indication of sink or source status (<i>1</i> : Sink, <i>Q</i> : Source)
FE47	Type of connected option		<i>Q Q</i>	Indication of connected add-on cassette options
FE54	<i>t YP</i> last set data		<i>t Q</i>	Indication of <i>t YP</i> value set last
FE55	<i>AU2</i> last set data		<i>A Q</i>	Indication of <i>AU2</i> value set last
FE08	CPU version		<i>U 120</i>	Indication of version of the CPU
FE43	Flush memory version		<i>F 100</i>	Indication of version of the flush memory
FE09	Control EEPROM version		<i>E Q</i>	Indication of version of the control EEPROM
FE44	Main circuit EEPROM version		<i>d 100</i>	Indication of version of the drive EEPROM

(Continued on the following page)

(Continued from the preceding page)

Com.No.	Contents of indication	Key operated	LED display	Description
FE10	Past trip #1	○	OC3 1	(Alternately blinking at intervals of 0.5 second) Past trip #1
FE11	Past trip #2	○	OH 2	(Alternately blinking at intervals of 0.5 second) Past trip #2
FE12	Past trip #3	○	OP3 3	(Alternately blinking at intervals of 0.5 second) Past trip #3
FE13	Past trip #4	○	ERR 4	(Alternately blinking at intervals of 0.5 second) Past trip #4
FE14	Cumulative operation time	○	t 0.1	Indication of total (accumulated) operation hours(Indication of 0.1 represents 10 hours.)
	Standard monitor mode	MON x 2	OP2	Status monitor mode(Blinking for trip indication) Reverts to the first trip indication.

Note 1: Failures that occur during initialization of the CPU on turning on the power or after resetting the inverter are not held by the failure trip holding function, and status monitor indications appear for such the failure.

Note 2: Contents of status indications of *2, *3, *4 and *5 can be selected from 30 kinds of information. Contents of indications that are set up at F711 to F714(status monitor #1 to #4 display mode) are displayed.

Unit of current and voltage indications can be changed from % to A (amperage) or V (voltage) and vice versa respectively with F701(Current/voltage display mode).

8. 4 Indication of alarm, pre-alarm, etc...

When the inverter alarm, pre-alarm, etc. occurred, the contents are displayed. (Some are not displayed.) Listed below ones can be monitored via communication(FC91). Refer to 12.1 for the other alarms.

Bit	Contents of indication	Panel indication
0	Over-current pre-alarm	C
1	Inverter overload pre-alarm	L
2	Motor overload pre-alarm	L
3	Overheat pre-alarm	H
4	Over-voltage pre-alarm	P
5	Main circuit under-voltage (NOFF) detected	NOFF
6	Poor control power supply (POFF) pre-alarm	POFF
7	Low current detected	
8	Over-torque detected	
9	Braking resistor overload (OLr) pre-alarm	
10	Cumulative operation time alarm	
11	Abnormal communication alarm #1 (caused by scanning)	t
12	Abnormal communication alarm #2 (caused by RS485 logic or message transmission)	t
13	Reservation area	
14	Reservation area	
15	Reservation area	

Note) For each bit, "0" indicates normal condition and "1" indicates appearance of alarm, etc..

9. Selection of peripheral devices



 Mandatory	<ul style="list-style-type: none"> When using the inverter without the front cover, be sure to place the inverter unit inside a cabinet. If they are used outside the cabinet, it may cause electric shock.
 Be grounded	<ul style="list-style-type: none"> Be sure to ground every unit. If not, it may cause electric shock or fire on the occasion of failure, short-circuit or electric leak.

9. 1 Selection of wiring equipment

Voltage class	Applicable motor [kW]	Inverter model	Wire size AWG (cross-section[mm ²])				
			Main circuit(*1)	DC reactor (optional)	Braking resistor/ Braking unit(optional)	Earth cable	
200V class	18.5	VFP7-2185P	4(22)	2(38)	8(8)	4(22)	
	22	VFP7-2220P	2(38)		6(14)		
	30	VFP7-2300P	2/0(60)	2/0(60)	2(38)	2(38)	
	37	VFP7-2370P		4/0(100)			
	45	VFP7-2450P	4/0(100)	300(150)		2(38)	2/0(60)
	55	VFP7-2550P	300(150)				
	75	VFP7-2750P					400(200)
	90	VFP7-2900P	400(200)				
110	VFP7-2110KP	400(200)		300 × 2 (150 × 2)			
400V class	18.5		VFP7-4185P			8(8)	6(14)
	22	VFP7-4220P	6(14)	4(22)	6(14)		
	30	VFP7-4300P			4(22)	2(38)	6(14)
	37	VFP7-4370P	2(38)	2/0(60)			
	45	VFP7-4450P			4/0(100)	4/0(100)	4(22)
	55	VFP7-4550P	4/0(100)	300(150)			
	75	VFP7-4750P			4/0(100)	300(150)	
	90	VFP7-4900P	4/0(100)	300(150)			
	110	VFP7-4110KP			400(200)	400 (100 × 2)	4/0(100) or 2 × 2(38 × 2)
	132	VFP7-4132KP	400(200)	300 × 2 (150 × 2)			
	160	VFP7-4160KP			300(150)	400 × 2 (200 × 2)	4/0(100) or 2/0(60 × 2)
	200	VFP7-4200KP	400(200)	400 × 2 (200 × 2)			
	220	VFP7-4220KP			300 × 2 (150 × 2)	400 × 2 (200 × 2)	
	280	VFP7-4280KP	300 × 2 (150 × 2)	400 × 2 (200 × 2)			
315	VFP7-4315KP	300 × 2 (150 × 2)			400 × 2 (200 × 2)		

(*1): Indicates wire sizes of input terminals R, S, T and output terminals U, V, W. Wiring distance is supposed to be 30 m at maximum.

(*2): Cable sizes in this table is in case of 75 degree copper wire.

(*3): For the control circuit, use shielded wires whose size (cross-section) is 0.75 mm² or more.

(*4): For the earth cable, use wires larger than the specified ones in size (cross-section).

(*5): Do not connect more than two wires to a terminal block (except for terminal blocks of 2900, 2110K, 4160K to 4315K and PA terminals of models that have only one PA terminal). If wiring with more than two wires is needed, set a external relay terminal.

Selection of wiring equipment

Voltage class	Applicable motor [kW]	Inverter model	Molded case circuit breaker (MCCB)		Magnetic contactor (MC)		Overload relay (THR)		Earth leakage circuit breaker (ELCB)	
			Rated current [A]	Type form (*1)	Rated current [A]	Type form (*1)	Regulated amperage (reference) [A]	Type form (*1)	Rated current [A]	Type form (*1)
200V class	18.5	VFP7-2185P	125	NJ225F	93	C100J	70	T100J	125	NJV225F
	22	VFP7-2220P	150		125	LC1D150J	85	T115J	150	
	30	VFP7-2300P	200		180	LC1-F185	110	T150J	200	
	37	VFP7-2370P	225		220	LC1F225J	138	T185J	225	
	45	VFP7-2450P	300	EH400	300	LC1F330J	198	LR9F53J	350	LEH400
	55	VFP7-2550P	350		252	400				
	75	VFP7-2750P	400		314	LR9F73J	600	LEH600		
	90	VFP7-2900P	600	EH600	400	LC1F400J	396		700	(*4)
	110	VFP7-2110KP	700	EH800	600	LC1F630J				
400V class	18.5	VFP7-4185P	75	NJ100F	48	C50J	35	T65J	75	NJV100F
	22	VFP7-4220P	100		65	C65J	44		100	
	30	VFP7-4300P	125	NJ225F	80	C80J	57	T100J	125	NJV225F
	37	VFP7-4370P			110	LC1-D150	65		150	
	45	VFP7-4450P			180	LC1F185J	85		T115J	
	55	VFP7-4550P	175	EH400	220	LC1F225J	138	T150J	250	LEH400
	75	VFP7-4750P	250		157	LR9F53J	300			
	90	VFP7-4900P	300		198	350				
	110	VFP7-4110KP	350		252	400				
	132	VFP7-4132KP	400	EH600	400	LC1F400J	268	LR9F73J	500	LEH600
	160	VFP7-4160KP	500		384	600				
	200	VFP7-4200KP	600		396	800	(*4)			
	220	VFP7-4220KP	800	EH800	600	LC1F630J	460		1000	(*5)
	280	VFP7-4280KP					800		504	
	315	VFP7-4315KP	1000	S1000B	800	LC1F800J				

(*1): Type forms of Toshiba Schneider Electric Ltd. products.

(*2): Attach surge killers to the magnetic contactor and exciting coil of the relay.

Surge killer for Toshiba Schneider Electric Ltd. magnetic contactor.

200 V class: SS-2 (Manufacture: Toshiba Schneider Electric Ltd.)

(For C11J to C65J, surge absorbing units are served optionally.)

400 V class: For the operation circuit and control circuit, regulate the voltage at 200 V or lower with a voltage regulator.

(*3): In the case the magnetic contactor (MC) with 2a-type auxiliary contacts is used for the control circuit, raise the reliability of the contact by using 2a-type contacts in parallel connection.

(*4): EH800 + LRE(Earth leakage relay) + ZCT

(*5): S1000B + LRE(Earth leakage relay) + ZCT

Among the wiring equipment shown in the above table, the magnetic contactors (MC) and overload relays (THR) are new models of the ESPER Mighty J series. When using old models of the Mighty J series, refer to the following comparison table that shows consistency between models of the two series.

Magnetic contactor (MC)		Overload relay(THR)	
Mighty J series	ESPER Mighty series	Mighty J series	ESPER Mighty series
C50J	C50A	T65J	T65A
C65J	C65A	T100J	T80A
C80J	C80A	T115J	T125A
C100J	C100A	T150J	T150A
LC1-D150	C125A	T185J	T180A
LC1-F185	C180A	LR9-F53	T220A
LC1-F225	C220A	LR9-F73	T400A
LC1-F330	C300A		
LC1-F400	C400A		
LC1-F630	C600A		

9. 2. Installation of electromagnetic contactor

When the inverter is used without electromagnetic contactor (MC) in the primary circuit, use the MCCB (with voltage tripping device) to make the primary circuit open when the inverter protection circuit is in operation.

When the damping resistor/damping resistance unit is used, install the electromagnetic contactor (MC) or fuseless circuit breaker with power tripping device in the temporary power supply circuit of the inverter so that the power circuit becomes open by operation of the error detection relay (EL) built in the inverter or externally installed overload relay.

Electromagnetic contactor in the primary circuit

If an electromagnetic contactor is installed in the power supply circuit of the inverter, it prevents the inverter from power failure, tripping of overload relay (Th-Ry), cutout of the inverter protection circuit after its operation, and double starting.

If the FL contact of the error detection relay built in the VF-P7 is connected with the operation circuit of the primary electromagnetic contactor (MC), the MC is tripped when the inverter protection circuit is actuated.

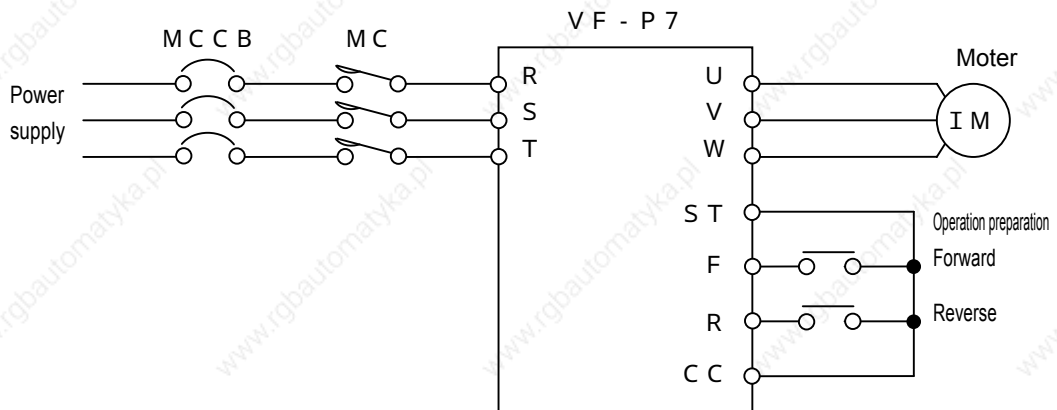

Example of electromagnetic contactor connection in primary circuit

Note on wiring

- If alternate operation to run and stop the inverter is frequently repeated, don't turn it on/off with the primary electromagnetic contactor. Run and stop the inverter with the control terminals F and CC (forward) and R and CC (reverse).
- Attach a surge killer to the exciting coil of the electromagnetic contactor (MC)

Electromagnetic contactor in the secondary circuit

The secondary electromagnetic contactor can be installed for switching the control motor and power supply when the inverter is suspended.

Note on wiring

- To prevent the commercial power supply from impressing the inverter's output terminals, be sure to interlock the secondary electromagnetic contactor with the power supply.
- In the case the electromagnetic contactor (MC) is installed between the inverter and motor, don't turn on/off the electromagnetic contactor on/off while the inverter is running. If the electromagnetic contactor is turned on/off during operation, it may cause a failure of the inverter because rush current flows to it.

9. 3. Installation of overload relay

- 1) The inverter VF-P7 has a built-in electronic thermal overload protection function inside. In the following cases, however, install an overload relay proper to the electronic thermal operation level adjustment and motor used between the inverter and motor.
 - In the case a motor that is different in rated current from Toshiba standard motor is used.
 - In the case a motor whose output is lower than the specified Toshiba motor of the standard specifications is independently operated, or two or more units of such the motors are operated together at a time.
- 2) When the low torque motor "Toshiba VF motor" is operated, properly adjust the electronic thermal protection characteristic of the inverter VF-P7 for the VF motor.
- 3) It is recommended to use a motor with motor winding flush type thermal relay in order to secure motor protection when it runs at low speed.

9. 4 Application and functions of options

Separate type options shown below are prepared for the inverter VF-P7

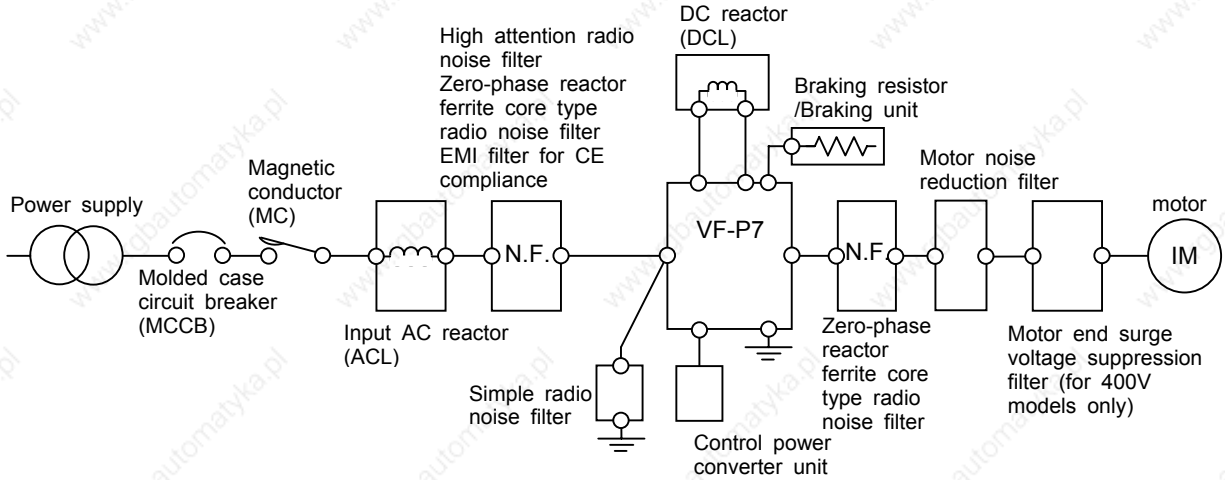

Sorts of separate-type options

No.	Option name	Function, purpose.															
	Input AC reactor (ACL)	To be used for improvement of input power-factor of the inverter power source, for reducing higher harmonic or suppressing external surge. The input reactor can be installed when the power capacity is 500 kVA or more and it is 10 times or more as high as the inverter capacity or there are some source distorted wave generation such as a thyristor, etc. and a high capacity inverter connected with the same distribution system. <table border="1" style="margin-left: 20px;"> <thead> <tr> <th rowspan="2">Type of reactor</th> <th colspan="3">Effect</th> </tr> <tr> <th>Power-factor improvement</th> <th>Harmonic suppression</th> <th>External surge suppression</th> </tr> </thead> <tbody> <tr> <td>Input AC reactor</td> <td>Effective</td> <td>Effective</td> <td>Effective</td> </tr> <tr> <td>DC reactor</td> <td>Very effective</td> <td>Very effective</td> <td>Not effective</td> </tr> </tbody> </table>	Type of reactor	Effect			Power-factor improvement	Harmonic suppression	External surge suppression	Input AC reactor	Effective	Effective	Effective	DC reactor	Very effective	Very effective	Not effective
Type of reactor	Effect																
	Power-factor improvement	Harmonic suppression	External surge suppression														
Input AC reactor	Effective	Effective	Effective														
DC reactor	Very effective	Very effective	Not effective														
	DC reactor(DCL)	The DC reactor is superior to the input AC reactor in power-factor improvement. For the inverter system that is required to be high reliable, it is recommended to use the input AC reactor that effectually suppresses external surge together with the DC reactor.															
	Radio noise reduction filter	High attenuation radio noise filter (LC filter) NF type, (manufactured by Soshin Electric Co., Ltd.) <ul style="list-style-type: none"> • Effectual to prevent audio equipment used near the inverter from radio interference. • Install this filter in the inverter's input side. • Excellent attenuation characteristic for wide frequency band from AM radio band nearly to 10 MHz. • To be used when electric appliances that are easily affected by noise are installed in the periphery of the inverter 															
		Simple radio noise filter (capacitive filter) (Manufactured by Malcon Electronics Co., Ltd.) <ul style="list-style-type: none"> • Effectual to prevent audio equipment used near the inverter from radio interference. • Install this filter in the inverter's input side. • Attenuation characteristic for a certain frequency band. Effectual for noise reduction of specific AM radio broadcastings (weak radio wave in mountain area). • Leak current increases because of the condenser type. If ELCB is installed in the power supply side, avoid using multiple units. 															
		Zero-phase reactor (Inductive filter) (Ferrite core type, manufactured by Soshin Electric Co., Ltd.) <ul style="list-style-type: none"> • Effectual to prevent audio equipment used near the inverter from radio interference. • Effectual to reduce noise in the input and output sides of the inverter. • Excellent attenuation characteristic for several decibels in wide frequency band from AM radio band nearly to 10 MHz. 															
	EMI filter for CE compliance	If EMI filter is installed in proper connection, the inverter has consistency with EMC commands.															
	Braking resistor	To be used to shorten deceleration time for the reason of frequently operated quick deceleration and suspension or high inertia load. This increases consumption of regenerative energy in dynamic braking. <ul style="list-style-type: none"> • Braking resistor: (resistor + protective thermal relay) are built in. 															
	Braking unit	<ul style="list-style-type: none"> • Braking unit:(dynamic brake drive circuit + resistor + protective thermal relay + thermal relay) are built in. 															

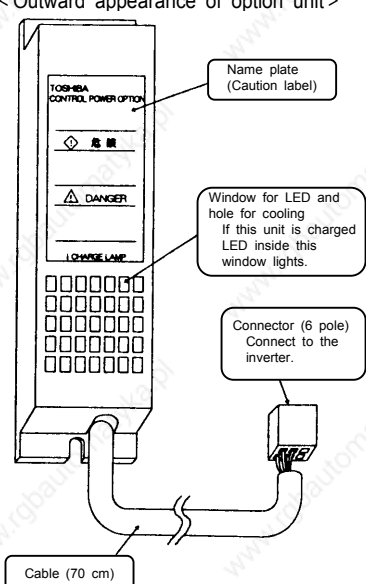
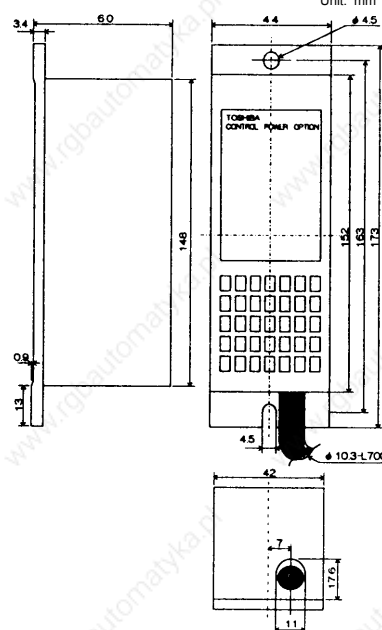
No.	Option name	Function, purpose.
	Motor noise reduction filter (for large capacity model only)	Can be used to suppress the magnetic noise from motor.
	Motor end surge voltage suppression filter (for 400 V models only)	In a system in which 400 V class general motor is driven by a voltage PWM type inverter using a high-speed switching device (IGBT, etc.), surge voltage depending on cable constant may cause deterioration in insulation of motor winding. Take measures against surge voltage such as use of insulation-reinforced motor, installation of AC reactor, surge voltage suppression filter, sine wave filter, and so on in the inverter's output side. Note) Set the carrier frequency to 2.2kHz when sine wave filter is used.
	Control power converter unit	<p>For inverters of 22 kW or less models, it is needless to input control power to the terminal (RO, SO) because those models are internally supplied with control voltage from the main circuit power supply.</p> <p>To use the main circuit power supply and control power supply separately for inverters of 22 kW or less models, use an optional control power supply unit. (Inverters of 30 kW or more models have a built-in control power supply circuit respectively.)</p> <div style="border: 1px dashed black; padding: 5px; margin: 10px 0;"> <p>Installation of optional control power supply unit (for 22 kW or less models) For installing an optional control power supply unit, remove the jumper connector (CN21) inside the inverter and connect the connector of the option to it. Install the optional control power supply unit nearby the inverter.</p> </div> <p style="text-align: center;">< Outward appearance of option unit ></p>  <p style="text-align: center;">< Outside dimensions of optional control power supply unit > Unit: mm</p>  <p style="text-align: center;">(Model: CPS0011) *Common use for 200 V and 400 V models</p>

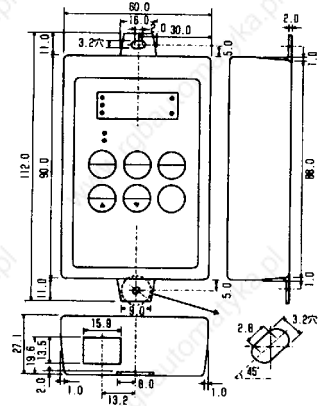
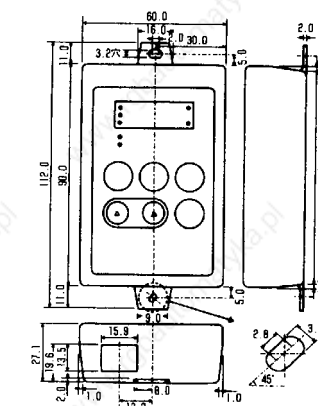
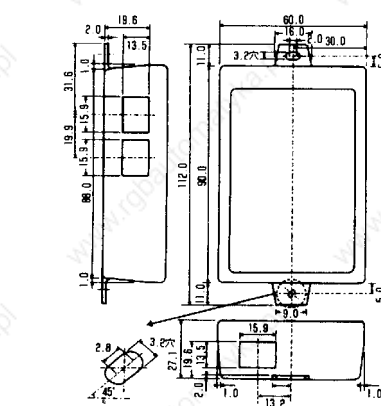
No.	Option name	Function, purpose.
	Parameter writer	<p>This unit collectively reads, copies and writes setup parameters. Therefore, multiple inverters can be set up the same by use of this unit. Storage capacity of one parameter writer is for three inverters. (When using this unit, set as follows: F805 [common serial transmission waiting time] = 0.00 [default setting].)</p> <p>< Outline drawings with dimensions ></p>  <p>(Model: PWU001Z)</p> <div style="border: 1px solid black; padding: 5px; margin-top: 10px;"> <p>(Note) Use a parameter writer manufactured in January, 1997 or after. For using a parameter writer manufactured in December, 1996 or before, connect it to the inverter with cable after turning on the inverter.</p> <p><How to know date of manufacture></p> <p style="text-align: center;">K <u>9</u> <u>9</u> <u>0</u> <u>2</u> <u>1</u> <u>5</u></p> <p style="text-align: center;"> </p> <p style="text-align: center;">Manufactured: Year Month</p> </div>
	Extension control panel	<p>Extension operation control panel unit with LED indicator, RUN/STOP key, UP/DOWN key, Monitor key and Enter key. (When using this unit, set as follows: F805 [common serial transmission waiting time] = 0.00 [default setting].)</p> <p><Outline drawings with dimensions></p>  <p>(Model: RKP001Z)</p> <div style="border: 1px solid black; padding: 5px; margin-top: 10px;"> <p>(Note) Use an extension operation control panel unit manufactured in January, 1997 or after. Units manufactured in December, 1996 or before cannot be used. Date of manufacture can be know by the lot number appearing on the name plate.</p> <p><How to know date of manufacture></p> <p style="text-align: center;">K <u>9</u> <u>9</u> <u>0</u> <u>2</u> <u>1</u> <u>5</u></p> <p style="text-align: center;"> </p> <p style="text-align: center;">Manufactured: Year Month</p> </div>
	RS-232C communication converter unit	<p>If this unit is used to connect the inverter and a personal computer and so on with each other, data communication can be performed between the two besides easy adjustment of parameters, saving and writing data. This unit serves as not only an RS-232C interface but a communication unit that can be connected with two inverters together.</p> <p>Monitor function Parameter setup function Command function Added function</p> <p><Outline drawings with dimensions></p>  <p>(Model: RS2001Z)</p>

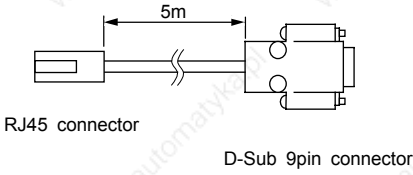
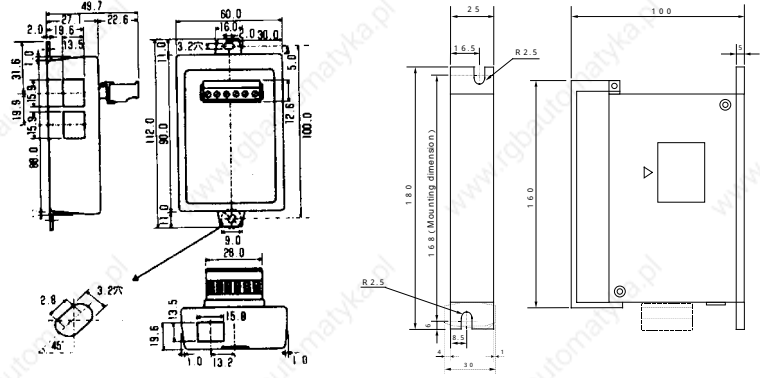
No.	Option name	Function, purpose.														
	RS-232C communication converter cable	<p>If this unit is used to connect the inverter and a personal computer and so on with each other, data communication can be performed between the two besides easy adjustment of parameters, saving and writing data.</p> <p><Outline drawings with dimensions></p>  <p>(Model: RS20035)</p>														
	RS-485 communication converter unit (for communication with multiple inverters)	<p>More than one inverter can be controlled with a personal computer and so on if this unit is used for connection between inverters and personal computer.</p> <ul style="list-style-type: none"> Computer link: Since this unit makes it possible to connect inverters with higher-class computer, FA computer, etc., a data communication network can be constructed among multiple inverters. Communication among inverters: For the purpose of proportional operation of multiple inverters, a frequency data communication network can be constructed among multiple inverters. <p><Outline drawings with dimensions></p>  <p>(Model: RS4001Z) (Model: RS4002Z)</p>														
	Communication cable	<p>Connection cable for connecting parameter writer, extension control panel, RS-232C communication units, and RS-485 communication units.</p> <p>Cable types: CAB0011 (1 m), CAB0013 (3 m), CAB0015 (5 m).</p>														
	Remote control panel	<p>A frequency meter, frequency setup device, RUN/STOP (forward, reverse) switch are built in this operation panel. (Model: CBVR-7B)</p>														
	Application control units	<p>Applied control units of the AP series make various applied control possible if they are used in combination with the inverter.</p> <table border="0"> <tr> <td>Proportional control panel (APP-2B)</td> <td>Process control panel with built-in PI controller (APJ-2B)</td> </tr> <tr> <td>Ratio setup panel (APH-7B)</td> <td>TG follower panel (APF-7B)</td> </tr> <tr> <td>Regulated power supply board (APV-2B)</td> <td>Current detection panel (APD-2B)</td> </tr> <tr> <td>Cushion starter panel (APC-2B)</td> <td>Torque control panel (APL-2B)</td> </tr> <tr> <td>Synchronizing control panel (APS-2B1)</td> <td>FV converter (APR-2B)</td> </tr> <tr> <td>Synchronizing transmitter (DRR-2)</td> <td>Loop controller (APU-2B)</td> </tr> <tr> <td>Remote control panel (APM-2B)</td> <td></td> </tr> </table>	Proportional control panel (APP-2B)	Process control panel with built-in PI controller (APJ-2B)	Ratio setup panel (APH-7B)	TG follower panel (APF-7B)	Regulated power supply board (APV-2B)	Current detection panel (APD-2B)	Cushion starter panel (APC-2B)	Torque control panel (APL-2B)	Synchronizing control panel (APS-2B1)	FV converter (APR-2B)	Synchronizing transmitter (DRR-2)	Loop controller (APU-2B)	Remote control panel (APM-2B)	
Proportional control panel (APP-2B)	Process control panel with built-in PI controller (APJ-2B)															
Ratio setup panel (APH-7B)	TG follower panel (APF-7B)															
Regulated power supply board (APV-2B)	Current detection panel (APD-2B)															
Cushion starter panel (APC-2B)	Torque control panel (APL-2B)															
Synchronizing control panel (APS-2B1)	FV converter (APR-2B)															
Synchronizing transmitter (DRR-2)	Loop controller (APU-2B)															
Remote control panel (APM-2B)																
	Harmonic suppression converter Power regeneration converter	<ul style="list-style-type: none"> Higher harmonic suppressor unit improves input power-factor by suppressing harmonic current. Power regenerator unit protects the inverter from load sprung from frequent rapid deceleration and negative torque. <p>For applicable models and particulars, inquire at our office.</p>														

Option ~ should be used under the condition of 9600 bps or less (F800).

Selection table of separate-type options

Voltage class	Applicable motor [kW]	Inverter model	Input AC reactor (ACL)	DC reactor (DCL)	Radio noise reduction filter			Braking resistor /Braking unit (*3, 4, 5)	Motor end surge suppression filter	Motor noise reduction filter			
					High attenuation type	Simple type	Core type (*1)						
200V class	18.5	VFP7-2185P	PFL-2100S	DCL-2220	NF-3080A-MJ	RCL-M2	RC9129	PBR3-2150	-	-			
	22	VFP7-2220P			NF-3100A-MJ			PBR3-2220					
	30	VFP7-2300P	PFL-2150S	DCL-2370	NF-3150A-MJ			PB3-2300					
	37	VFP7-2370P											
	45	VFP7-2450P	PFL-2200S	DCL-2450	NF-3200A-MJ			PB3-2550					
	55	VFP7-2550P	PFL-2300S	DCL-2550	NF-3250A-MJ			RC9129 (*6)			DGP600W-B1 [DGP600W-C1]	NRL-2220	
	75	VFP7-2750P	PFL-2400S	DCL-2750	NF-3200A-MJ x 2 (parallel)							NRL-2300	
	90	VFP7-2900P	PFL-2600S	DCL-2900	NF-3250A-MJ x 2 (parallel)							NRL-2400 (*2)	
	110	VFP7-2110KP											
400V class	18.5	VFP7-4185P	PFL-4050S	DCL-4220	NF-3040C-MJ	RCL-M4	RC9129	PBR3-4150	MSF-4220Z	-			
	22	VFP7-4220P			NF-3050C-MJ			PBR3-4220					
	30	VFP7-4300P	PFL-4100S	DCL-4450	NF-3060C-MJ			PB3-4300	MSF-4370Z				
	37	VFP7-4370P			NF-3080C-MJ								
	45	VFP7-4450P			NF-3100C-MJ								
	55	VFP7-4550P	PFL-4150S	DCL-4750	NF-3150C-MJ			PB3-4550	MSF-4550Z				
	75	VFP7-4750P	PFL-4300S	DCL-4110K	NF-3250C-MJ				MSF-4750Z		NRL-4155		
	90	VFP7-4900P						RC9129 (*6)	DGP600W-B2 [DGP600W-C2]		NRL-4230		
	110	VFP7-4110KP									(*7)	NRL-4300	
	132	VFP7-4132KP	PFL-4400S	DCL-4160K	NF-3200C-MJ x 2 (parallel)							NRL-4350	
	160	VFP7-4160KP										NRL-4600	
	200	VFP7-4200KP	PFL-4600S	DCL-4220K	NF-3250C-MJ x 2 (parallel)							DGP600W-B3 [DGP600W-C3]	NRL-4550
	220	VFP7-4220KP										DGP600W-B4 [DGP600W-C4]	(*2)
	280	VFP7-4280KP	PFL-4800S	DCL-4280K	NF-3250C-MJ x 3 (parallel)								
	315	VFP7-4315KP											

(*1): This filter needs to be wound 4 turns or more around with the input side power line. This filter can be used for the output side in the same manner. For the wire whose size is 22 mm² or more, install at least 4 filters in series. Round type (Model: RC5078) is also available.

(*2): For a motor noise reduction filter for this class, please consult.

(*3): PBR3- indicates braking resistor, PB3- indicates braking unit (dynamic braking drive circuit and braking resistor(s) are built in it).

(*4): Model in square brackets is fitted with top cover.

(*5): To use 200 V-75 kW or more or 400 V-110 kW or more inverter with an external braking resistor (DGP600 series), installation of a dynamic braking drive circuit inside the inverter is required.

(*6): There is a case that this filter is unusable depending on the type or size of the cable to be used.

(*7): About this filter for inverter models of 90 kW or more, consult with our office

(*8): Be sure to connect DC reactor to 200V-75kW or more or 400V-110kW or more inverter. (Not necessary for DC input.)

9. 5 Optional add-on cassettes

The following add-on cassette options are prepared for the inverter VF-P7.

It can be applied to after CPU version "V300".

Table of optional add-on cassettes

Table of optional add-on cassettes

Option name		Function, purpose	Model	Remarks (*1)
Expansion terminal function	Vector option unit	This option compatible to sensor vector control is usable for speed control and position control by the PG feedback function.	VEC001Z	A
	Expansion TB option unit	This option provides extended terminal functions for use.	ETB001Z	
Communication function	S20 option unit	This option provides TOSLINE-S20 for use.	TLS001Z	B
	F10M option unit	This option provides TOSLINE-F10 for use	TLF001Z	
	Device Net option unit	This option provides Device Net for use	Under planning	
	Profibus option unit	This option provides Profibus for use	Under planning	
Attachment		Attachment for fitting add-on cassette option to the inverter.	SBP001Z	For 75(132) kW or less(*3)
			SBP002Z	For 90(160) kW or more(*3)

(*1): One can use two of Group A together with one of the Group B at a time. (Maximally 3 options)

(*2): To use 37 kW or more models in any of conditions described below, refer to 9.7 and execute the preparation before attachment.

i) install the vector option unit

ii) install the S20 option unit or the F10M option unit and execute PG feedback control

(*3): Inside () indicates case of 400V class models.

Functions of optional add-on cassettes

Vector option unit

Function	Description
PG feedback	<ul style="list-style-type: none"> • Consistent with line driver output encoder (Disconnection detection function is also provided) • Consistent with complementary/open-collector encoder (Pulse train speed command) • Max. pulse freq. 60kHz(2-phase), 120kHz(single-phase), Duty: 50 ± 10%
Power supply for encoder	5 V, 6 V, 12 V, 15 V DC, 160 mA or less
Voltage drop detection	Detection of voltage drop in PG power supply line
Standby signal output	Open-collector output/sink output (30 V DC, 50 mA or less) Approximately 1 second after the main circuit power is turned on, this terminal is connected with COM. In an error status, circuit between this terminal and COM is open regardless of main circuit power supply.
OC pre-alarm	Open-collector output/sink output (30 V DC, 50 mA or less) When current exceeds the limiting range, this terminal is connected with COM.
Alarm output (Error code 0, 1, 2, 3)	With occurrence of an error, the cause of trip is output in 4-bit binary system. Error is detected according to the open/closed status of the circuit between the open-collector of each terminal and COM.
P24 power supply	+24 V DC power supply (200 mA or less) for driving external relay, etc.
PG feedback output	Open-collector outputs of phase-A positioning pulse, phase-B positioning pulse, phase-Z positioning pulse originating from the encoder built in the motor. (30 V DC, 50 mA or less)
PG line driver output	Outputs phase-A positioning pulse, phase-B positioning pulse, phase-Z positioning pulse originating from the line drive output encoder built in the motor.
± 10 V analog command power supply	Power supply for ± 10 V analog voltage command. (Internal impedance: 500 Ω, for 1 k Ω resistor)
± 10 V analog command input	± 10 V programmable voltage command is input to this terminal.
Pulse train position control command input	Pulse train positioning commands for forward rotation and reverse rotation are input to this terminal. This terminal is enabled only when it is set in the position control mode or switched for position control.
Encoder supply voltage check	To check encoder supply voltage.

Expansion TB option unit

Function		Description
Contact input	16-bit binary input (12-bit binary)	• Sink input ON : 5 V DC or less (5 mA type) OFF : 11 V DC or more, or 0.5 mA or less
	4-digit BCD code input (3-digit BCD code)	• Source input
	Multifunction programmable input (high-order 8 bits)	ON : 11 V DC, 2.5 mA or more (maximum 30 V DC) OFF : 5 V DC or less, or 1.4 mA or less
Multifunction programmable analog output (current/voltage output switchable)		• Current: 4 to 20 mA DC output (source output) Maximum connectable resistance: 750 • Voltage: ± 10 V DC output
Multifunction programmable relay contact output		• 1a, 1b contact output (double circuit) Contact rating : 250 V AC, 2 A (cos ϕ = 1) 250 V AC, 1 A (cos ϕ = 0.4) 30 V DC, 1 A

Installation of optional add-on cassettes to (75 kW or less model (200V class)) (160 kW or less model (400V class))

To install optional add-on cassette(s), use the attachment and set the options on the right side of the inverter. To attach the option(s), secure an enough space in the right side of the inverter.

- To install a cassette: L = 48.5 mm or more
- To install two cassettes: L = 73.5 mm or more
- To install three cassettes: L = 98.5 mm or more
- No matter for cassettes number, L1 = 20.0 mm or more

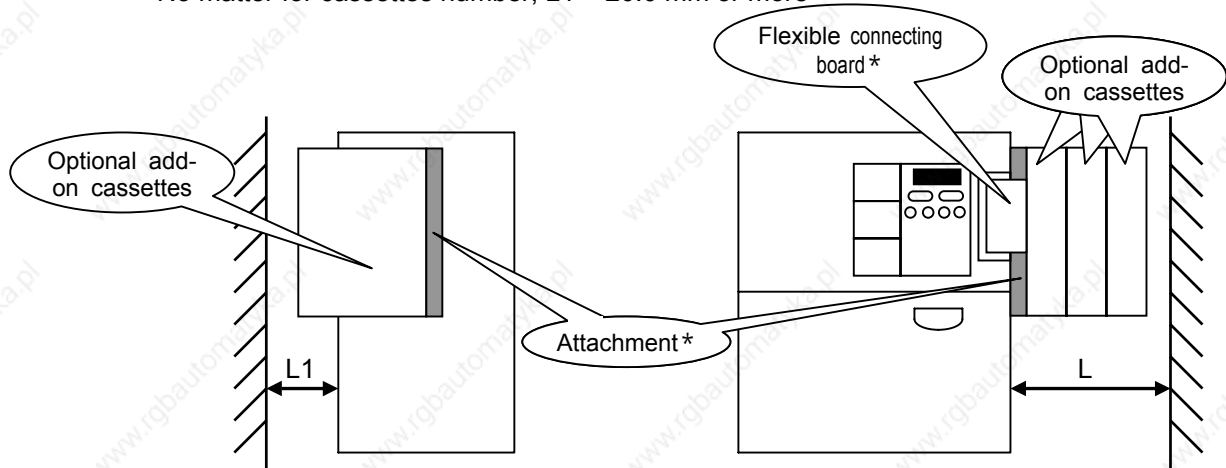

*: In a set with SBP001Z.

Installation of optional add-on cassettes to (90 kW or more model (200V class)) (200 kW or more model (400V class))

To install optional add-on cassette(s), use the attachment and set the options on the right side of the control panel. To attach the option(s), secure an enough space (L: 50 mm or more) in front of the inverter.

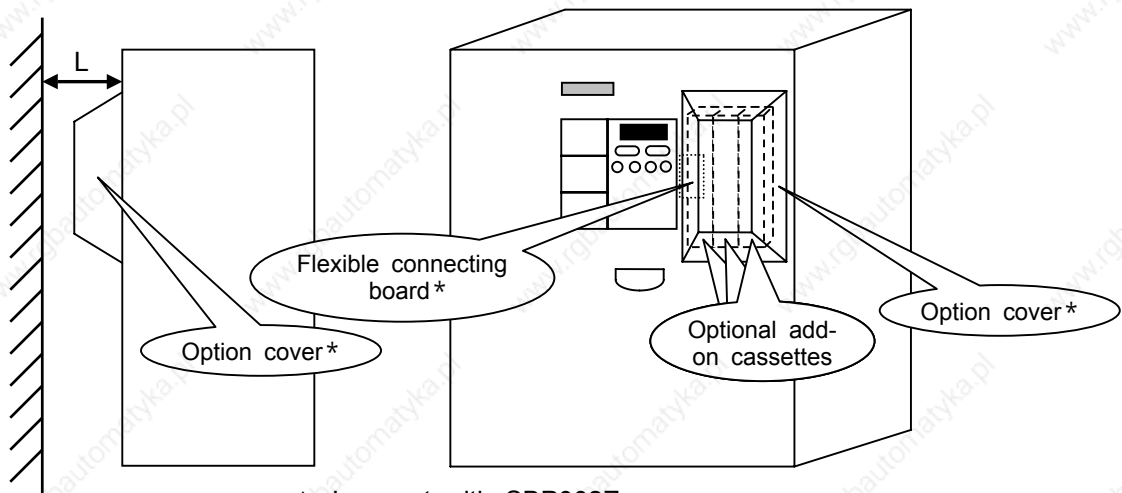

*: In a set with SBP002Z.

9. 6 Board options

Besides the optional add-on cassettes, such the board options as shown below are prepared for the inverter VF-P7.

Table of board options

Option name	Function, purpose	Model	Remarks
PG feedback board	Since this option is compatible to vector option unit, it can be used for speed control and torque control by the PG feedback function.	VEC002Z (For complementary / open collector type encoder)	Cannot be used together with any optional add-on cassettes.
		VEC003Z (For line driver type encoder)	

Functions of board options

Model	Vector option unit (optional add-on cassette)	PG feedback board (board option)	
	VEC001Z	VEC002Z	VEC003Z
Vector control with sensor	Speed controlled operation (150 % torque at zero speed, speed control range: 1:1000 [1000 ppr PG], speed accuracy: ± 0.02 % [50 Hz, basic digital input]) Torque controlled operation (torque control accuracy: ± 10 % [torque control range: -100 to +100 %])		
Position control command operation	Available(pulse command)	Unavailable	Unavailable
PG system	Line driver system (equivalent to 26LS31) Complementary system Open collector system	Complementary system Open collector system	Line driver system (equivalent to 26LS31)
Maximum frequency of input pulse	60 kHz(2-phase), 120 kHz(single phase) Maximum frequency is restricted depending on kind of encoder and wiring distance. Pulse duty: 50 ± 10 %		
Length of PG wiring	100 m (complementary system)	100 m (complementary system)	30 m
Power supply for PG	5 V, 6 V, 12 V, 15 V (switchable), 160 mAdc	12 V (fixed), 160 mAdc	5 V (fixed), 160 mAdc
Voltage drop compensation for PG power supply	Available	Unavailable	Unavailable
Sensor disconnection detection/in running (in rotation)	Available	Available	Available
Sensor disconnection detection/in suspension	Available (line driver system only)	Unavailable	Unavailable
± 10 V analog command input	Available	Unavailable	Unavailable
Multifunction programmable output	2 circuits (sink/source switchable)	Unavailable	Unavailable
Alarm output	4 circuits (sink/source switchable)	Unavailable	Unavailable
Terminal board	Detachable terminal board (Phoenix) + connector for VJV3 sensor	Fixed terminal board (Phoenix) (equivalent to VFS7E control terminal board)	Fixed terminal board (Phoenix) (equivalent to VFS7E control terminal board)
PG wiring	Connector wiring (connector for VJV3 sensor)	Screw terminal	Screw terminal
Connection with other add-on cassette option	Available	Unavailable	Unavailable
Remarks (applied motor, expected)	VJV3 motor/standard motor with sensor	Standard motor with sensor	VJV3 motor

Installation of board option

For installing a board option, fit the bracket to the right side of the inverter and plug the connector of the option board into the connector jack of the control board.

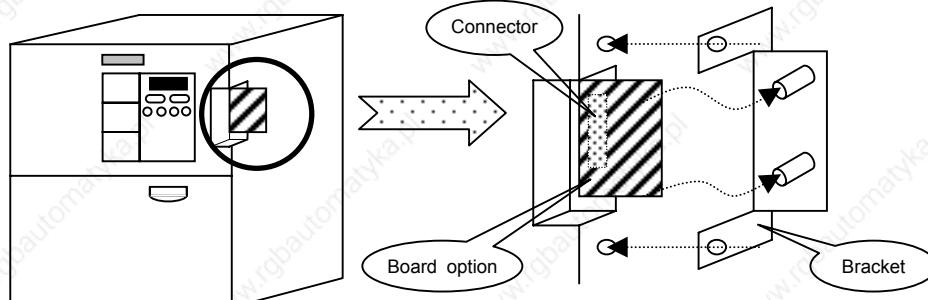

9.7 Before installing optional add-on cassette or board option

When using optional add-on cassette(s) or a board option with a model 200V-37kW or more or 400V-45kW or more, prepare for installing according to explanation below.

In any case, check that all the power sources are OFF before opening the front cover.

Note) Do not open the front cover, unless 10 minutes has passed after the power sources turned off and charge lamp is not lit.

Option name	Model	Reference section
Vector option unit	VEC001Z	9.7.1 Case 1
PG feed back board	VEC002Z VEC003Z	
S20 option unit	TLS001Z	9.7.1 Case 2
F10M option unit	TLF001Z	
Other than models above		9.7.1 Case 3

9.7.1 Case 1



Warning

1. Please extract wire-C from the connector on board-B.
2. Remove board-A(attached to the control board) and wire-C from the control board.
3. For using again in the future, keep board-A and wire-C which were removed.
4. Attach the option according to the instruction manual of each option.
The image after option attachment becomes as follows.
(Left: In the case optional add-on cassette, Right: In the case board option)
5. Switch on power supply and change the setup of the parameter $F314$ into 0 .

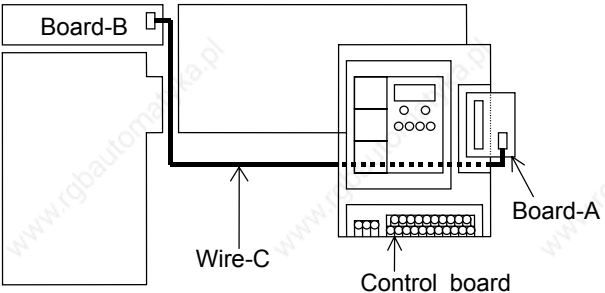

Mandatory 

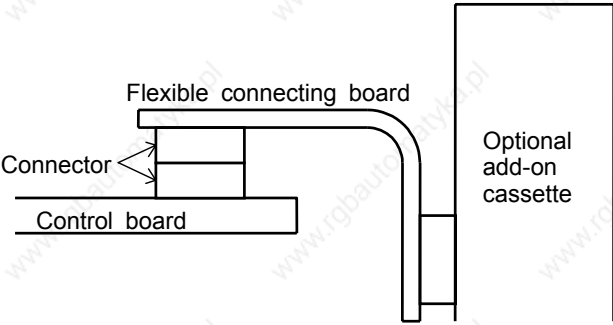

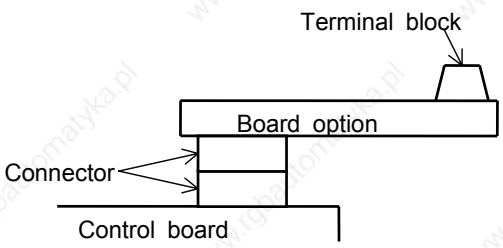

Note) Fix the board option with installation stay and support screw.

Note)
Board-A, board-B and wire-C aim at the function of the speed search #2 among the auto-restart modes described in 6.13.1.
At case 1 or case 2-A, speed search #1 is performed. So, board-A, board-B and wire-C are not needed in these cases.

9.7.2 Case 2

Case 2-A. When PG feedback function is used

Prepare for installing according to 9.7.1, 1 to 5.

Case 2-B. When PG feedback function is not used

Preparation is not needed.

Note1) Attach flexible connecting board to the board-A (not to the control board).

The image after option attachment becomes as follow.

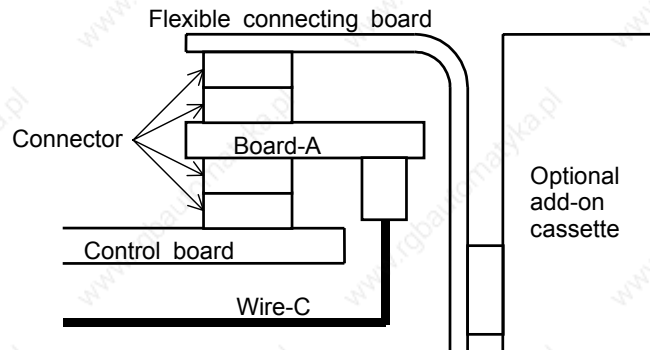

Note2) Do not change the position of the bit switch for PG input (default setting is without PG input) in the option unit (TLS001Z or TLM001Z). If you set at with PG input position, auto-restart function(refer to 6.13.1) dose not work correctly and over-current, overload, over-voltage, etc. trips may occur.

9.7.3 Case 3

Preparation is not needed.

Note) Attach flexible connecting board set with attachment (SBP001Z or SBP002Z) to board-A (not control board).

Refer to attachment image in case 2-B.

10. Table of parameters

(P 7 Ver . 3 1 2)

TOSHIBA

1. Basic parameters (1/2)

Sensorless vector/vector with sensor (/ : valid, - : invalid)

Title	Communication No.	Function	Adjustment range	Minimum setup unit	Default setting	Write during running	Vector control			V/f Constant	Reference section
							Speed control	Torque control	Position control		
<i>RV1</i>	0000	Automatic acceleration/deceleration	0: Manual acceleration/deceleration 1: Automatic acceleration/deceleration	-	0	Disabled	/ -	-	-		5.1
<i>RV2</i>	0001	Automatic V/f mode setting	0: - (0 is always displayed.) 1: Automatic torque boost + auto-tuning 2: Sensorless vector control (speed) + auto-tuning 3: Automatic energy-saving + auto-tuning	-	0	Disabled	/ -	-	-		5.2
<i>CNDd</i>	0003	Operation command mode selection	0: Terminal block enabled 1: Operating panel enabled 2: Common serial communication option enabled 3: Serial communication RS485 enabled 4: Communication add-on cassette option enabled	-	0	Disabled	/	/	- /		5.3
<i>FNDd</i>	0004	Speed setting mode selection	1: VI (voltage input)/II (current input) 2: RR (voltage/voltage input) 3: RX (voltage input) 4: RX2 (voltage input) (optional) 5: Operating panel input 6: Binary/BCD input(optional) 7: Common serial communication option(FA01) 8: Serial communication RS485(FA05) 9: Communication add-on cassette option(FA07) 10: Up-down frequency 11: Pulse input #1 (optional)	-	2	Disabled	/	-	-		5.3
<i>FNSL</i>	0005	FM terminal meter selection	0 ~ 32	-	0	Enabled	/	/	- /		5.4
<i>FN</i>	0006	FM terminal meter adjustment	-	-	-	Enabled	/	/	- /		5.4
<i>LYP</i>	0007	Standard setting mode selection	0: - 1: 50Hz standard setting 2: 60Hz standard setting 3: Factory default setting 4: Trip clear 5: Clearing accumulating operation time 6: Initialization of type form information 7: Memorization of user-defined parameters 8: Reset of user-defined parameters	-	0	Disabled	/	/	- /		5.5

1. Basic parameters (2/2)

* Minimum setup unit is 0.1 in case of 16-bit access. Sensorless vector/vector with sensor (:valid, - :invalid)

Title	Communication No.	Function	Adjustment range		Min. unit (panel/communication)	Default setting	Write during running	Vector control			V/f Constant	Reference section	
								Speed control	Torque control	Position control			
<i>F_r</i>	0008	Forward/reverse selection (At panel control only)	0: Forward, 1: Reverse		-	0	Enabled	/	/	- /		5.6	
<i>A_{CC}</i>	0009	Acceleration time #1	0.1(<i>F₅₀₀</i>) ~ 6000 [s]		0.01/0.01*	See J-28	Enabled	/	-	-		5.1.2	
<i>d_{EC}</i>	0010	Deceleration time #1	0.1(<i>F₅₀₀</i>) ~ 6000 [s]		0.01/0.01*	See J-28	Enabled	/	-	-		5.1.2	
<i>F_H</i>	0011	Maximum frequency	30.0 ~ 400.0 [Hz]		0.01/0.01	80	Disabled	/	/	- /		5.7	
<i>U_L</i>	0012	Upper limit frequency	0.0 ~ <i>F_H</i> [Hz]		0.01/0.01	80	Enabled	/	-	-		5.8	
<i>L_L</i>	0013	Lower limit frequency	0.0 ~ <i>U_L</i> [Hz]		0.01/0.01	0.0	Enabled	/	-	-		5.8	
<i>u_L</i>	0014	Base frequency #1	25.0 ~ 400.0 [Hz]		0.01/0.01	60	Enabled	/	/	- /		5.9	
<i>P_t</i>	0015	Motor control mode selection	0: Constant torque 1: Variable torque mode 2: Automatic torque boost 3: Sensorless vector control (speed) 4: Automatic torque boost + automatic energy-saving 5: Sensorless vector control (speed) + automatic energy-saving 6: V/f 5-points setting 7: Sensorless vector control (speed/torque switching) 8: PG feedback vector control (speed/torque switching) 9: PG feedback vector control (speed/position switching)		-	0	Disabled	- / -	- / -	- / -	-	5.10	
<i>u_b</i>	0016	Manual torque boost	0 ~ 30%		0.1/0.01	See J-28	Enabled	-	-	-		5.12	
<i>OLN</i>	0017	Selection of electronic thermal protection characteristics	Setting	Type	Overload protection	Overload stall	-	0	Disabled	/	/	- /	5.13
			0	Standard motor	protect	not stall							
			1		protect	stall							
			2		not protect	not stall							
			3	VF motor (special motor)	not protect	stall							
			4		protect	not stall							
			5		protect	stall							
6	not protect	not stall											
7	not protect	stall											
<i>S_{r1}</i>	0018	Preset-speed #1	<i>L_L</i> ~ <i>U_L</i> [Hz]		0.01/0.01	0.0	Enabled	/	-	-		5.14	
<i>S_{r2}</i>	0019	Preset-speed #2	<i>L_L</i> ~ <i>U_L</i> [Hz]		0.01/0.01	0.0	Enabled	/	-	-			
<i>S_{r3}</i>	0020	Preset-speed #3	<i>L_L</i> ~ <i>U_L</i> [Hz]		0.01/0.01	0.0	Enabled	/	-	-			
<i>S_{r4}</i>	0021	Preset-speed #4	<i>L_L</i> ~ <i>U_L</i> [Hz]		0.01/0.01	0.0	Enabled	/	-	-			
<i>S_{r5}</i>	0022	Preset-speed #5	<i>L_L</i> ~ <i>U_L</i> [Hz]		0.01/0.01	0.0	Enabled	/	-	-			
<i>S_{r6}</i>	0023	Preset-speed #6	<i>L_L</i> ~ <i>U_L</i> [Hz]		0.01/0.01	0.0	Enabled	/	-	-			
<i>S_{r7}</i>	0024	Preset-speed #7	<i>L_L</i> ~ <i>U_L</i> [Hz]		0.01/0.01	0.0	Enabled	/	-	-			
<i>F₁₋₋</i> ~ <i>F₉₋₋</i>	-	Extended parameter	Setting of extended parameters listed on the following pages		-	-	-	/	/	- /		4.1.2	
<i>Gr.U</i>	-	Automatic edit function	To search parameters different from default value		-	-	-	/	/	- /		4.1.3	

2. Extended parameters

[1] Frequency signal

Sensorless vector/vector with sensor (/ : valid, - : invalid)

Title	Communication No.	Function	Adjustment range	Min. unit (panel/communication)	Default setting	Write during running	Vector control			V/f Constant	Reference section
							Speed control	Torque control	Position control		
F 100	0100	Low-speed signal output frequency	0.0 ~ \underline{UL} [Hz]	0.01/0.01	0.0	Enabled	/	/	- /		6.1.1
F 101	0101	Speed reach setting frequency	0.0 ~ \underline{UL} [Hz]	0.01/0.01	0.0	Enabled	/	/	- /		6.1.2
F 102	0102	Speed reach detection band	0.0 ~ \underline{UL} [Hz]	0.01/0.01	2.5	Enabled	/	/	- /		6.1.2

[2] Input signal selection

Title	Communication No.	Function	Adjustment range	Min. unit (panel/communication)	Default setting	Write during running	Vector control			V/f Constant	Reference section
							Speed control	Torque control	Position control		
F 103	0103	ST (standby) signal selection	0: Standard, 1: Always ON, 2: Interlock with F/R terminal	-	0	Disabled	/	/	- /		6.2.1
F 105	0105	Priority selection (both F-CC, R-CC are ON)	0: Reverse, 1: Stop	-	0	Disabled	/	/	- /		6.2.2
F 106	0106	Priority setting of input terminal	0: Disabled, 1: Enabled	-	0	Disabled	/	/	- /		6.2.3
F 107	0107	Binary/BCD signal selection (Expansion TB option unit)	0: None 1: 12-bit binary input 2: 16-bit binary input 3: 3-digit BCD input 4: 4-digit BCD input 5: Reverse 12-bit binary input 6: Reverse 16-bit binary input 7: Reverse 3-digit BCD input 8: Reverse 4-digit BCD input	-	0	Disabled	/	/	-		
F 108	0108	Up-down frequency	0 ~ 7	1/1	0	Disabled	/	- / -	- / -		

[3] Terminal function selection (1/2)

Title	Communication No.	Function	Adjustment range	Min. unit (panel/communication)	Default setting	Write during running	Vector control			V/f Constant	Reference section
							Speed control	Torque control	Position control		
F 110	0110	Always active function selection	0 ~ 135	-	0	Disabled	/	/	- /		6.3.1
F 111	0111	Input terminal selection #1 (F)	0 ~ 135	-	2(F)	Disabled	/	/	- /		7.2.1
F 112	0112	Input terminal selection #2 (R)	0 ~ 135	-	4(R)	Disabled	/	/	- /		7.2.1
F 113	0113	Input terminal selection #3 (ST)	0 ~ 135	-	6(ST)	Disabled	/	/	- /		7.2.1
F 114	0114	Input terminal selection #4 (RES)	0 ~ 135	-	8(RES)	Disabled	/	/	- /		7.2.1
F 115	0115	Input terminal selection #5 (S1)	0 ~ 135	-	10(S1)	Disabled	/	/	- /		7.2.1
F 116	0116	Input terminal selection #6 (S2)	0 ~ 135	-	12(S2)	Disabled	/	/	- /		7.2.1
F 117	0117	Input terminal selection #7 (S3)	0 ~ 135	-	14(S3)	Disabled	/	/	- /		7.2.1
F 118	0118	Input terminal selection #8 (S4)	0 ~ 135	-	16(S4)	Disabled	/	/	- /		7.2.1
F 119	0119	Input terminal selection #9	0 ~ 135	-	0	Disabled	/	/	- /		7.2.1
F 120	0120	Input terminal selection #10	0 ~ 135	-	0	Disabled	/	/	- /		7.2.1

(Reference section): Refer to the inverter's individual manual.

[3] Terminal function selection (2/2)

Sensorless vector/vector with sensor (valid, - :invalid)

Title	Communication No	Function	Adjustment range	Min. unit (panel/communication)	Default setting	Write during running	Vector control			V/f Constant	Reference section
							Speed control	Torque control	Position control		
F 121	0121	Input terminal selection #11	0 ~ 135	-	0	Disabled	/	/	-/		7.2.1
F 122	0122	Input terminal selection #12	0 ~ 135	-	0	Disabled	/	/	-/		7.2.1
F 123	0123	Input terminal selection #13	0 ~ 135	-	0	Disabled	/	/	-/		7.2.1
F 124	0124	Input terminal selection #14	0 ~ 135	-	0	Disabled	/	/	-/		7.2.1
F 125	0125	Input terminal selection #15	0 ~ 135	-	0	Disabled	/	/	-/		7.2.1
F 126	0126	Input terminal selection #16	0 ~ 135	-	0	Disabled	/	/	-/		7.2.1
F 130	0130	Output terminal selection #1 (OUT1)	0 ~ 119	-	4(Low)	Disabled	/	/	-/		7.2.2
F 131	0131	Output terminal selection #2 (OUT2)	0 ~ 119	-	6(RCH)	Disabled	/	/	-/		7.2.2
F 132	0132	Output terminal selection #3 (FL)	0 ~ 119	-	10(FL)	Disabled	/	/	-/		7.2.2
F 133	0133	Output terminal selection #4	0 ~ 119	-	0	Disabled	/	/	-/		7.2.2
F 134	0134	Output terminal selection #5	0 ~ 119	-	2	Disabled	/	/	-/		7.2.2
F 135	0135	Output terminal selection #6	0 ~ 119	-	8	Disabled	/	/	-/		7.2.2
F 136	0136	Output terminal selection #7	0 ~ 119	-	14	Disabled	/	/	-/		7.2.2

[4] Terminal response time setup

Title	Communication No	Function	Adjustment range	Min. unit (panel/communication)	Default setting	Write during running	Vector control			V/f Constant	Reference section
							Speed control	Torque control	Position control		
F 140	0140	Input terminal #1 response time(F)	2 to 200 [ms] (in steps of 2.5 [ms])	(*1)	8	Disabled	/	/	-/		7.2.3
F 141	0141	Input terminal #2 response time(R)	2 to 200 [ms] (in steps of 2.5 [ms])	(*1)	8	Disabled	/	/	-/		7.2.3
F 142	0142	Input terminal #3 response time(ST)	2 to 200 [ms] (in steps of 2.5 [ms])	(*1)	8	Disabled	/	/	-/		7.2.3
F 143	0143	Input terminal #4 response time(RES)	2 to 200 [ms] (in steps of 2.5 [ms])	(*1)	8	Disabled	/	/	-/		7.2.3
F 144	0144	Input terminal #5-#8 response time	2 to 200 [ms] (in steps of 2.5 [ms])	(*1)	8	Disabled	/	/	-/		7.2.3
F 145	0145	Input terminal #9-#16 response time	2 to 200 [ms] (in steps of 2.5 [ms])	(*1)	8	Disabled	/	/	-/		7.2.3
F 150	0150	Output terminal #1 delay time (OUT1)	2 to 200 [ms] (in steps of 2.5 [ms])	(*1)	2	Disabled	/	/	-/		7.2.3
F 151	0151	Output terminal #2 delay time (OUT2)		(*1)	2	Disabled	/	/	-/		7.2.3
F 152	0152	Output terminal #3 delay time (FL)		(*1)	2	Disabled	/	/	-/		7.2.3
F 153	0153	Output terminal #4 delay time		(*1)	2	Disabled	/	/	-/		7.2.3
F 154	0154	Output terminal #5 delay time		(*1)	2	Disabled	/	/	-/		7.2.3
F 155	0155	Output terminal #6 delay time		(*1)	2	Disabled	/	/	-/		7.2.3
F 156	0156	Output terminal #7 delay time		(*1)	2	Disabled	/	/	-/		7.2.3
F 160	0160	Output terminal #1 holding time (OUT1)	2 to 200 [ms] (in steps of 2.5 [ms])	(*1)	2	Disabled	/	/	-/		7.2.3
F 161	0161	Output terminal #2 holding time (OUT2)		(*1)	2	Disabled	/	/	-/		7.2.3
F 162	0162	Output terminal #3 holding time (FL)		(*1)	2	Disabled	/	/	-/		7.2.3
F 163	0163	Output terminal #4 holding time		(*1)	2	Disabled	/	/	-/		7.2.3
F 164	0164	Output terminal #5 holding time		(*1)	2	Disabled	/	/	-/		7.2.3
F 165	0165	Output terminal #6 holding time		(*1)	2	Disabled	/	/	-/		7.2.3
F 166	0166	Output terminal #7 holding time		(*1)	2	Disabled	/	/	-/		7.2.3

(*1)The minimum setting unit is 2.5 [ms]. Please input a value which is a multiple of 2.5 and omitted below the decimal point.

Sensorless vector/vector with sensor (valid, - :invalid)

[5] Basic parameters #2

Title	Communication No	Function	Adjustment range	Min. unit (panel/communication)	Default setting	Write during running	Vector control			V/f Constant	Reference section
							Speed control	Torque control	Position control		
F 170	0170	Base frequency #2	25.0 ~ 400.0 [Hz]	0.01/0.01	60.0	Enabled	-	-	-		6.4.1
F 171	0171	Base frequency voltage #2	0.0 ~ 600.0 [V]	0.1/0.1	See J-28	Enabled	-	-	-		6.4.1
F 172	0172	Manual torque boost #2	0.0 ~ 30.0 [%]	0.1/0.01	See J-28	Enabled	-	-	-		6.4.1
F 173	0173	Motor overload protection level #2	10 ~ 100 [%]	1/0.01	100.0	Enabled	-	-	-		6.4.1
F 174	0174	Base frequency #3	25.0 ~ 400.0 [Hz]	0.01/0.01	60.0	Enabled	-	-	-		6.4.1
F 175	0175	Base frequency voltage #3	0.0 ~ 600.0 [V]	0.1/0.1	See J-28	Enabled	-	-	-		6.4.1
F 176	0176	Manual torque boost #3	0.0 ~ 30.0 [%]	0.1/0.01	See J-28	Enabled	-	-	-		6.4.1
F 177	0177	Motor overload protection level #3	10 ~ 100 [%]	1/0.01	100	Enabled	-	-	-		6.4.1
F 178	0178	Base frequency #4	25.0 ~ 400.0 [Hz]	0.01/0.01	60.0	Enabled	-	-	-		6.4.1
F 179	0179	Base frequency voltage #4	0.0 ~ 600.0 [V]	0.1/0.1	See J-28	Enabled	-	-	-		6.4.1
F 180	0180	Manual torque boost #4	0.0 ~ 30.0 [%]	0.1/0.01	See J-28	Enabled	-	-	-		6.4.1
F 181	0181	Motor overload protection level #4	10 ~ 100 [%]	1/0.01	100	Enabled	-	-	-		6.4.1
F 182	0182	Motor switching mode selection	0: standard, 1: customized	-	0	Disabled	/	/	-/		
F 183	0183	V/f adjustment coefficient	0 ~ 255	1/1	32	Enabled	-	-	-		

[6] V/f 5-point setting

Title	Communication No	Function	Adjustment range	Min. unit (panel/communication)	Default setting	Write during running	Vector control			V/f Constant	Reference section
							Speed control	Torque control	Position control		
F 190	0190	V/f 5-point setting VF1 frequency	0 ~ 400 [Hz]	1/1	0	Disabled	-	-	-		6.5
F 191	0191	V/f 5-point setting VF1 voltage	0 ~ 100 [%]	0.1/0.01	0.0	Disabled	-	-	-		6.5
F 192	0192	V/f 5-point setting VF2 frequency	0 ~ 400 [Hz]	1/1	0	Disabled	-	-	-		6.5
F 193	0193	V/f 5-point setting VF2 voltage	0 ~ 100 [%]	0.1/0.01	0.0	Disabled	-	-	-		6.5
F 194	0194	V/f 5-point setting VF3 frequency	0 ~ 400 [Hz]	1/1	0	Disabled	-	-	-		6.5
F 195	0195	V/f 5-point setting VF3 voltage	0 ~ 100 [%]	0.1/0.01	0.0	Disabled	-	-	-		6.5
F 196	0196	V/f 5-point setting VF4 frequency	0 ~ 400 [Hz]	1/1	0	Disabled	-	-	-		6.5
F 197	0197	V/f 5-point setting VF4 voltage	0 ~ 100 [%]	0.1/0.01	0.0	Disabled	-	-	-		6.5
F 198	0198	V/f 5-point setting VF5 frequency	0 ~ 400 [Hz]	1/1	0	Disabled	-	-	-		6.5
F 199	0199	V/f 5-point setting VF5 voltage	0 ~ 100 [%]	0.1/0.01	0.0	Disabled	-	-	-		6.5

(Reference section): Refer to the inverter's individual manual.

[7] Speed/torque reference gain/bias setup (1/2)

Sensorless vector/vector with sensor (valid, - :invalid)

Title	Communication No	Function	Adjustment range	Min. unit (panel/communication)	Default setting	Write during running	Vector control			V/f Constant	Reference section
							Speed control	Torque control	Position control		
F200	0200	Reference priority selection	0: F _{00d} 1: F ₂₀₇ 2: F _{00d} priority (*1) 3: F ₂₀₇ priority (*2) 4: F _{00d} /F ₂₀₇ switching	-	0	Enabled	/	-	-		6.6.1
F201	0201	VI/II reference point #1	0 ~ 100 [%]	1/0.01	20.0	Enabled	/	/	-		7.3.2
F202	0202	VI/II reference point #1 frequency	0.0 ~ F _H [Hz]	0.01/0.01	0.0	Enabled	/	/	-		7.3.2
F203	0203	VI/II reference point #2	0 ~ 100 [%]	1/0.01	100	Enabled	/	/	-		7.3.2
F204	0204	VI/II reference point #2 frequency	0.0 ~ F _H [Hz]	0.01/0.01	80.0	Enabled	/	-	-		7.3.2
F205	0205	VI/II reference point #1 rate	-250 ~ 250 [%] (For torque control, etc.)	1/0.01	0	Enabled	/	/	-	-	6.21.1
F206	0206	VI/II reference point #2 rate	-250 ~ 250 [%] (For torque control, etc.)	1/0.01	100	Enabled	/	/	-	-	6.21.1
F207	0207	Speed setting mode selection #2	Same as F _{00d} (1 to 11)	-	1	Enabled	/	-	-		6.61
F208	0208	F _{00d} /F ₂₀₇ switching frequency	0.1 ~ F _H [Hz]	0.01/0.01	1.0	Enabled	/	-	-		6.6.1
F209	0209	Analog input filter	0(Disabled) to 3(Max. filter capacity)	-	0	Enabled	/	/	-		7.2.4
F210	0210	RR reference point #1	0 ~ 100 [%]	1/0.01	0	Enabled	/	/	-		7.3.1
F211	0211	RR reference point #1 frequency	0.0 ~ F _H [Hz]	0.01/0.01	0.0	Enabled	/	-	-		7.3.1
F212	0212	RR reference point #2	0 ~ 100 [%]	1/0.01	100	Enabled	/	/	-		7.3.1
F213	0213	RR reference point #2 frequency	0.0 ~ F _H [Hz]	0.01/0.01	80.0	Enabled	/	-	-		7.3.1
F214	0214	RR reference point #1 rate	0 ~ 250 [%] (For torque control, etc.)	1/0.01	0	Enabled	/	/	-	-	6.21.1
F215	0215	RR reference point #2 rate	0 ~ 250 [%] (For torque control, etc.)	1/0.01	100	Enabled	/	/	-	-	6.21.1
F216	0216	RX reference point #1	-100 ~ 100 [%]	1/0.01	0	Enabled	/	/	-		7.3.3
F217	0217	RX reference point #1 frequency	-F _H ~ F _H [Hz] (*3)	0.01/0.01	0.0	Enabled	/	-	-		7.3.3
F218	0218	RX reference point #2	-100 ~ 100 [%]	1/0.01	100	Enabled	/	/	-		7.3.3
F219	0219	RX reference point #2 frequency	-F _H ~ F _H [Hz] (*3)	0.01/0.01	80.0	Enabled	/	-	-		7.3.3
F220	0220	RX reference point #1 rate	0 ~ 250 [%] (For torque control, etc.)	1/0.01	0	Enabled	/	/	-	-	6.21.1
F221	0221	RX reference point #2 rate	0 ~ 250 [%] (For torque control, etc.)	1/0.01	100	Enabled	/	/	-	-	6.21.1
F222	0222	RX2 reference point #1	-100 ~ 100 [%]	1/0.01	0	Enabled	/	/	-		
F223	0223	RX2 reference point #1 frequency	-F _H ~ F _H [Hz] (*3)	0.01/0.01	0.0	Enabled	/	-	-		
F224	0224	RX2 reference point #2	-100 ~ 100 [%]	1/0.01	100	Enabled	/	/	-		
F225	0225	RX2 reference point #2 frequency	-F _H ~ F _H [Hz] (*3)	0.01/0.01	80.0	Enabled	/	-	-		
F226	0226	RX2 reference point #1 rate	-250 ~ 250 [%] (For torque control, etc.)	1/0.01	0	Enabled	/	/	-		
F227	0227	RX2 reference point #2 rate	-250 ~ 250 [%] (For torque control, etc.)	1/0.01	100	Enabled	/	/	-		

(*1): When setup frequency(signal set up by F_{00d}) is F₂₀₈ or more, signal set up by F_{00d} is accepted, When setup frequency is lower than F₂₀₈, the inverter runs under the signal of F₂₀₇.
 (*2): When setup frequency(signal set up by F₂₀₇) is F₂₀₈ or more, signal set up by F₂₀₇ is accepted, When setup frequency is lower than F₂₀₈, the inverter runs under the signal of F_{00d}.
 (*3): Adjustment range is -327.68 ~ 327.67 [Hz] in case of 16-bit access.
 (Reference section): Refer to the inverter's individual manual.

Sensorless vector/vector with sensor (/ : valid, - : invalid)

[7] Speed/torque reference gain/bias setup (2/2)

Title	Communication No	Function	Adjustment range	Min. unit (panel/communication)	Default setting	Write during running	Vector control			V/f Constant	Reference section
							Speed control	Torque control	Position control		
F228	0228	BIN reference point #1	-100 ~ 100 [%]	1/0.01	0	Enabled	/	/	-		
F229	0229	BIN reference point #1 frequency	-FH ~ FH [Hz] (*1)	0.01/0.01	0.0	Enabled	/	-	-		
F230	0230	BIN reference point #2	-100 ~ 100 [%]	1/0.01	100	Enabled	/	/	-		
F231	0231	BIN reference point #2 frequency	-FH ~ FH [Hz] (*1)	0.01/0.01	80.0	Enabled	/	-	-		
F232	0232	BIN reference point #1 rate	-250 ~ 250 [%] (For torque control, etc.)	1/0.01	0	Enabled	/	/	-		
F233	0233	BIN reference point #2 rate	-250 ~ 250 [%] (For torque control, etc.)	1/0.01	100	Enabled	/	/	-		
F234	0234	Pulse reference point #1	-100 ~ 100 [%]	1/0.01	0	Enabled	/	-	-		
F235	0235	Pulse reference point #1 frequency	-FH ~ FH [Hz] (*1)	0.01/0.01	0.0	Enabled	/	-	-		
F236	0236	Pulse reference point #2	-100 ~ 100 [%]	1/0.01	100	Enabled	/	-	-		
F237	0237	Pulse reference point #2 frequency	-FH ~ FH [Hz] (*1)	0.01/0.01	80.0	Enabled	/	-	-		

(*1): Adjustment range is -327.68 ~ 327.67 [Hz] in case of 16-bit access.

[8] Operation frequency

Title	Communication No	Function	Adjustment range	Min. unit (panel/communication)	Default setting	Write during running	Vector control			V/f Constant	Reference section
							Speed control	Torque control	Position control		
F240	0240	Start-up frequency	0.0 ~ 10.0 [Hz]	0.01/0.01	0.1	Enabled	/	-	-		6.7.1
F241	0241	Run frequency	0.0 ~ FH [Hz]	0.01/0.01	0.0	Enabled	/	-	-		6.7.2
F242	0242	Run frequency hysteresis	0.0 ~ 30.0 [Hz]	0.01/0.01	0.0	Enabled	/	-	-		6.7.2
F243	0243	Stop frequency	0.0 ~ 30.0 [Hz]	0.01/0.01	0.0	Enabled	/	-	-		6.7.1
F244	0244	0 Hz dead band frequency	0.0 ~ 5.0 [Hz]	0.01/0.01	0.0	Enabled	/	-	-		6.7.3

[9] DC injection braking

Title	Communication No	Function	Adjustment range	Min. unit (panel/communication)	Default setting	Write during running	Vector control			V/f Constant	Reference section
							Speed control	Torque control	Position control		
F250	0250	DC injection braking start frequency	0.0 ~ 120.0 [Hz]	0.01/0.01	0.0	Enabled	/	-	-		6.8.1
F251	0251	DC injection braking current	0.0 ~ 100.0 [%]	0.1/0.01	50.0	Enabled	/	-	-		6.8.1
F252	0252	DC injection braking time	0.0 ~ 10.0 [s]	0.1/0.01	1.0	Enabled	/	-	-		6.8.1
F253	0253	Forward/reverse DC braking priority control	0: OFF, 1: ON	-	0	Enabled	/	-	-		6.8.1
F254	0254	Motor shaft fixing control	0: Disabled, 1: Enabled	-	0	Enabled	/	-	-		6.8.2
F255	0255	Zero-speed stop mode selection	0: Standard(DC injection braking), 1: 0Hz command	-	0	Disabled	- /	-	-		6.8.3

[10] Jogging operation

Title	Communication No	Function	Adjustment range	Min. unit (panel/communication)	Default setting	Write during running	Vector control			V/f Constant	Reference section
							Speed control	Torque control	Position control		
F260	0260	Jog run frequency	0.0 ~ 20.0 [Hz]	0.01/0.01	0.0	Enabled	/	-	-		6.9
F261	0261	Jog stop control	0: Deceleration stop 1: Coast stop 2: DC injection braking stop	-	0	Enabled	/	-	-		6.9

(Reference section): Refer to the inverter's individual manual.

[11] Jumper frequency

Sensorless vector/vector with sensor (valid, - :invalid)

Title	Communication No	Function	Adjustment range	Min. unit (panel/communication)	Default setting	Write during running	Vector control			V/f Constant	Reference section
							Speed control	Torque control	Position control		
F270	0270	Jump frequency #1	0.0 ~ FH [Hz]	0.01/0.01	0.0	Enabled	/	-	-		6.10
F271	0271	Jump frequency band #1	0.0 ~ 30.0 [Hz]	0.01/0.01	0.0	Enabled	/	-	-		6.10
F272	0272	Jump frequency #2	0.0 ~ FH [Hz]	0.01/0.01	0.0	Enabled	/	-	-		6.10
F273	0273	Jump frequency band #2	0.0 ~ 30.0 [Hz]	0.01/0.01	0.0	Enabled	/	-	-		6.10
F274	0274	Jump frequency #3	0.0 ~ FH [Hz]	0.01/0.01	0.0	Enabled	/	-	-		6.10
F275	0275	Jump frequency band #3	0.0 ~ 30.0 [Hz]	0.01/0.01	0.0	Enabled	/	-	-		6.10
F276	0276	Object of jump frequency process	0: Process amount, 1: Output frequency	-	0	Enabled	/	-	-		6.10

[12] Preset speed operation frequency (8- to 15-stage speed)

Title	Communication No	Function	Adjustment range	Min. unit (panel/communication)	Default setting	Write during running	Vector control			V/f Constant	Reference section
							Speed control	Torque control	Position control		
F287	0287	Preset-speed #8	LL ~ UL [Hz]	0.01/0.01	0.0	Enabled	/	-	-		5.14
F288	0288	Preset-speed #9	LL ~ UL [Hz]	0.01/0.01	0.0	Enabled	/	-	-		5.14
F289	0289	Preset-speed #10	LL ~ UL [Hz]	0.01/0.01	0.0	Enabled	/	-	-		5.14
F290	0290	Preset-speed #11	LL ~ UL [Hz]	0.01/0.01	0.0	Enabled	/	-	-		5.14
F291	0291	Preset-speed #12	LL ~ UL [Hz]	0.01/0.01	0.0	Enabled	/	-	-		5.14
F292	0292	Preset-speed #13	LL ~ UL [Hz]	0.01/0.01	0.0	Enabled	/	-	-		5.14
F293	0293	Preset-speed #14	LL ~ UL [Hz]	0.01/0.01	0.0	Enabled	/	-	-		5.14
F294	0294	Preset-speed #15	LL ~ UL [Hz]	0.01/0.01	0.0	Enabled	/	-	-		5.14

[13] PWM carrier frequency

Title	Communication No	Function	Adjustment range	Min. unit (panel/communication)	Default setting	Write during running	Vector control			V/f Constant	Reference section
							Speed control	Torque control	Position control		
F300	0300	PWM carrier frequency	0.5 ~ 15.0(8.0, 5.0) [kHz] (*1)	0.1/0.001	See J-28	Disabled	/	/	-/		6.12

(*1)Upper limits differ by applicable motor capacity. For details, refer to 6.12.

Carrier frequency is automatically limited to less than 10kHz when operation frequency is more than 130Hz.

[14] Triplex intensification setup (1/2)

Title	Communication No	Function	Adjustment range	Min. unit (panel/communication)	Default setting	Write during running	Vector control			V/f Constant	Reference section
							Speed control	Torque control	Position control		
F301	0301	Auto-restart	0: Disabled, 1: Enabled(at power failure), 2: Enabled(at ST ON/OFF), 3: Enabled(1+2)	-	0	Enabled	/	/	-/		6.13.1
F302	0302	Regenerative power ride-through control / Deceleration stop	0: OFF, 1: ON, 2:ON(Deceleration stop)	-	0	Enabled	/	-/-	-/-		6.13.2
F303	0303	Retry selection	0: Disabled, 1 to 10 times	-	0	Enabled	/	/	-/		6.13.3
F304	0304	Dynamic braking mode selection	0: Disabled, 1: Enabled/overload detection enabled	-	See J-28	Enabled	/	/	-/		6.13.4
F305	0305	Over-voltage stall protection	0: Enabled, 1: Disabled, 2: Enabled (Forced quick deceleration)	-	0	Enabled	/	/	-/		6.13.5
F306	0306	Base frequency voltage #1 (output voltage adjustment)	0.0 ~ 600.0 [V]	0.1/0.1	See J-28	Enabled	/	/	-/		6.13.6

[14] Tripless intensification setup (2/2)

Sensorless vector/vector with sensor (valid, - :invalid)

Title	Communication No	Function	Adjustment range	Min. unit (panel/communication)	Default setting	Write during running	Vector control			V/f Constant	Reference section
							Speed control	Torque control	Position control		
F307	0307	Base frequency voltage (Voltage compensation)	0: without voltage compensation (limitless output voltage) 1: with voltage compensation (limitless output voltage) 2: without voltage compensation (limited output voltage) 3: with voltage compensation (limited output voltage)	-	1	Disabled	This parameter is changeable, but significant setting value is fixed to 1 in vector control.				6.13.6
F308	0308	Dynamic braking resistance	1.0 ~ 1000 []	0.1/0.1	See J-28	Disabled	/	/	- /		6.13.4
F309	0309	Dynamic braking resistor capacity	0.01 ~ 600.0 [kW]	0.01/0.01	See J-28	Disabled	/	/	- /		6.13.4
F310	0310	Ride-through time / Deceleration time	0.0 ~ 320.0 [s]	0.1/0.01	2.0	Enabled	/	- / -	- / -		6.13.2
F311	0311	Reverse-run prohibition	0: Permitted, 1: Reverse run prohibited, 2: Forward run prohibited, 3: Direction designated by command permitted	-	0	Disabled	/	/	-		6.13.7
F312	0312	Auto-restart adjustment #1	0.50 ~ 2.50	0.01/0.01	See J-28	Enabled	/	/	- / -		6.13.1
F313	0313	Auto-restart adjustment #2	0.50 ~ 2.50	0.01/0.01	See J-28	Enabled	/	- / -	- / -		6.13.1
F314	0314	Auto-restart mode	0 ~ 4	1/1	See J-28	Disabled	/ -	/ -	- / -		6.13.1
F315	0315	Auto-restart adjustment #3	0 ~ 9	1/1	1	Disabled	/ -	/ -	- / -		6.13.1

[15] Drooping control

Title	Communication No	Function	Adjustment range	Min. unit (panel/communication)	Default setting	Write during running	Vector control			V/f Constant	Reference section
							Speed control	Torque control	Position control		
F320	0320	Drooping gain	0 ~ 100 [%] (Enabled if $P_L = 7, 8$ or 9)	1/0.01	0	Enabled	/	-	-	-	6.14
F321	0321	Speed at drooping gain 0%	0.0 ~ 320.0 [Hz] (Enabled if $P_L = 7, 8$ or 9)	0.01/0.01	60.0	Enabled	/	-	-	-	6.14
F322	0322	Speed at drooping gain F320	0.0 ~ 320.0 [Hz] (Enabled if $P_L = 7, 8$ or 9)	0.01/0.01	60.0	Enabled	/	-	-	-	6.14
F323	0323	Drooping insensitive torque band	0 ~ 100 [%] (Enabled if $P_L = 7, 8$ or 9)	1/0.1	10	Enabled	/	-	-	-	6.14
F324	0324	Output filter for drooping	0.1 ~ 200.0 [rad/s] (Enabled if $P_L = 7, 8$ or 9)	0.1/0.1	100.0	Enabled	/	-	-	-	6.14
F325	0325	Load inertia (Acc/Dec torque)	0 ~ 1000	0.1/0.1	1.0	Enabled	/	-	-	-	
F326	0326	Load torque filter (Acc/Dec torque)	0.0 ~ 199.9, 200.0:without filter	0.1/0.1	200.0	Enabled	/	-	-	-	
F327	0327	Drooping reference selection	0: Standard, 1: Acc/dec torque removal 2: Internal torque standard 3: Acc/dec torque removal (internal torque standard)	-	0	Enabled	/	-	-	-	

[16] Functions for lift (1/2)

Title	Communication No	Function	Adjustment range	Min. unit (panel/communication)	Default setting	Write during running	Vector control			V/f Constant	Reference section
							Speed control	Torque control	Position control		
F330	0330	Light-load high-speed operation	0 ~ 5	-	0	Disabled	/	-	-		
F331	0331	Light-load high-speed operation switching lower limit frequency	30.0 ~ $\frac{V_L}{L}$ [Hz]	0.01/0.01	40.0	Enabled	/	-	-		
F332	0332	Light-load high-speed operation load waiting time	0.0 ~ 10.0 [s]	0.1/0.1	1.0	Enabled	/	-	-		
F333	0333	Light-load high-speed operation load detection time	0.0 ~ 10.0 [s]	0.1/0.1	1.0	Enabled	/	-	-		
F334	0334	Light-load high-speed operation heavy load detection time	0.0 ~ 10.0 [s]	0.1/0.1	5.0	Enabled	/	-	-		
F335	0335	Switching load torque current during forward run	0 ~ 250 [%]	1	50	Enabled	/	-	-		
F336	0336	Heavy load torque during acceleration in forward direction	0 ~ 250 [%]	1	120	Enabled	/	-	-		
F337	0337	Heavy load torque during fixed speed in forward direction	0 ~ 250 [%]	1	100	Enabled	/	-	-		
F338	0338	Switching load torque current during reverse run	0 ~ 250 [%]	1	50	Enabled	/	-	-		
F339	0339	Heavy load torque during acceleration in reverse direction	0 ~ 250 [%]	1	120	Enabled	/	-	-		

(Reference section): Refer to the inverter's individual manual.

[16] Functions for lift (2/2)

Sensorless vector/vector with sensor (valid, - :invalid)

Title	Communication No	Function	Adjustment range	Min. unit (panel/communication)	Default setting	Write during running	Vector control			V/f Constant	Reference section
							Speed control	Torque control	Position control		
F340	0340	Heavy load torque during fixed speed in reverse direction	0 ~ 250 [%]	1	100	Enabled	/	-	-		
F341	0341	Automatic light-load high-speed operation frequency	30.0 ~ $\frac{UL}{L}$ [Hz]	0.01/0.01	80.0	Enabled	/	-	-		

[17] Commercial/inverter switching function

Title	Communication No	Function	Adjustment range	Min. unit (panel/communication)	Default setting	Write during running	Vector control			V/f Constant	Reference section
							Speed control	Torque control	Position control		
F354	0354	Output signal selection of commercial power/inverter switching	0: OFF, 1: Automatic switching in case of trip 2: Commercial power switching frequency setting enabled 3: Both (1+2)	-	0	Disabled	/	/	-		6.16
F355	0355	Commercial power/inverter switching frequency	0 ~ FH [Hz]	0.01/0.01	60.0	Enabled	/	/	-		6.16
F356	0356	Inverter side switching waiting time	Model dependent ~ 10.00 [s]	0.01/0.01	See J-28	Enabled	/	/	-		6.16
F357	0357	Commercial power side switching waiting time	0.37 ~ 10.00 [s]	0.01/0.01	0.62	Enabled	/	/	-		6.16
F358	0358	Commercial power switching frequency holding time	0.1 ~ 10.0 [s]	0.1/0.01	2.0	Enabled	/	/	-		6.16

[18] PID control

Title	Communication No	Function	Adjustment range	Min. unit (panel/communication)	Default setting	Write during running	Vector control			V/f Constant	Reference section
							Speed control	Torque control	Position control		
F360	0360	Signal selection of PID control	0: PID control disabled, 1: VI/II, 2: RR, 3: RX, 4: RX2	-	0	Enabled	/	-	-		3.3
F361	0361	Delay filter	0 ~ 255	-	0	Enabled	/	-	-		3.3
F362	0362	Proportional (P) gain	0.01 ~ 100.0	0.01/0.01	0.1	Enabled	/	-	-		3.3
F363	0363	Integral (I) gain	0.01 ~ 100.0	0.01/0.01	0.1	Enabled	/	-	-		3.3
F364	0364	PID deviation upper limit	0 ~ 50 [%]	1/0.01	50	Enabled	/	-	-		3.3
F365	0365	PID deviation lower limit	0 ~ 50 [%]	1/0.01	50	Enabled	/	-	-		3.3
F366	0366	Differential (D) gain	0.00 ~ 2.55	0.01/0.01	0	Enabled	/	-	-		3.3

[19] Speed feedback/positioning control

Title	Communication No	Function	Adjustment range	Min. unit (panel/communication)	Default setting	Write during running	Vector control			V/f Constant	Reference section
							Speed control	Torque control	Position control		
F367	0367	Number of PG input pulses	1 ~ 9999	1/1	500	Disabled	- /	- /	- /	-	
F368	0368	Number of PG input phases	1: Single-phase input, 2: Two-phase input	-	2	Disabled	- /	- /	- /	-	
F369	0369	PG disconnection detection	0: Disabled, 1: Enabled	-	0	Disabled	- /	- /	- /	-	
F370	0370	Electronic gear	100 to 4000 pulses/rotation	1/1	1000	Disabled	-	-	- /	-	
F371	0371	Position loop gain	0.0 ~ 100.0	0.1/0.01	4.0	Enabled	-	-	- /	-	
F372	0372	Positioning completion range	1 ~ 4000	1/1	100	Enabled	-	-	- /	-	
F373	0373	Frequency limit at position control	1 ~ 8000 [Hz/s], 8001: disabled	1/1	800	Disabled	-	-	- /	-	

(Reference section): Refer to the inverter's individual manual.

[20] Vector control

Sensorless vector/vector with sensor (/ : valid, - :invalid)

Title	Communication No	Function	Adjustment range	Min. unit (panel/communication)	Default setting	Write during running	Vector control			V/f Constant	Reference section
							Speed control	Torque control	Position control		
F374	0374	Current control proportional gain	100.0 ~ 1000	0.1/0.1	209.1	Disabled	/	/	- /	-	
F375	0375	Current control integral gain	100.0 ~ 1250	0.1/0.1	See J-28	Disabled	/	/	- /	-	
F376	0376	Speed loop proportional gain	3.2 ~ 1000	0.1/0.1	See J-28	Enabled	/	-	- /	-	
F377	0377	Speed loop integral gain	0.1 ~ 200.0 [rad/s]	0.1/0.1	See J-28	Enabled	/	-	- /	-	
F378	0378	Motor counter data selection	0 ~ 5	-	0	Disabled	- / -	-	- /	-	
F379	0379	Speed loop parameter ratio	0.01 ~ 10.00 [s]	0.01/0.01	1.00	Disabled	/	-	- /	-	

[21] Preset-speed operation mode

Title	Communication No	Function	Adjustment range	Min. unit (panel/communication)	Default setting	Write during running	Vector control			V/f Constant	Reference section
							Speed control	Torque control	Position control		
F380	0380	Preset-speed operation mode	0: Non-mode preset speed 1: Preset speed by mode	-	0	Disabled	/	-	-		5.14
F381	0381	Preset-speed #1 control mode	0: Forward run +1: Reverse run +2: Selection of acc/dec switching #1 +4: Selection of acc/dec switching #2 +8: Selection of V/f switching #1 +16: Selection of V/f switching #2 +32: Selection of torque limit switching #1 +64: Selection of torque limit switching #2	-	0	Disabled	/	-	-		5.14
F382	0382	Preset-speed #2 control mode	Ditto	-	0	Disabled	/	-	-		5.14
F383	0383	Preset-speed #3 control mode	Ditto	-	0	Disabled	/	-	-		5.14
F384	0384	Preset-speed #4 control mode	Ditto	-	0	Disabled	/	-	-		5.14
F385	0385	Preset-speed #5 control mode	Ditto	-	0	Disabled	/	-	-		5.14
F386	0386	Preset-speed #6 control mode	Ditto	-	0	Disabled	/	-	-		5.14
F387	0387	Preset-speed #7 control mode	Ditto	-	0	Disabled	/	-	-		5.14
F388	0388	Preset-speed #8 control mode	Ditto	-	0	Disabled	/	-	-		5.14
F389	0389	Preset-speed #9 control mode	Ditto	-	0	Disabled	/	-	-		5.14
F390	0390	Preset-speed #10 control mode	Ditto	-	0	Disabled	/	-	-		5.14
F391	0391	Preset-speed #11 control mode	Ditto	-	0	Disabled	/	-	-		5.14
F392	0392	Preset-speed #12 control mode	Ditto	-	0	Disabled	/	-	-		5.14
F393	0393	Preset-speed #13 control mode	Ditto	-	0	Disabled	/	-	-		5.14
F394	0394	Preset-speed #14 control mode	Ditto	-	0	Disabled	/	-	-		5.14
F395	0395	Preset-speed #15 control mode	Ditto	-	0	Disabled	/	-	-		5.14
F396	0396	Torque reference filter #2	10.0 ~ 199.9, 200.0(No filters)	1/0.1	200.0	Enabled	/	- / -	-	-	6.21.2
F397	0397	Speed loop proportional gain #2	3.2 ~ 1000	0.1/0.1	See J-28	Enabled	/	-	- /	-	
F398	0398	Speed loop integral gain #2	10.0 ~ 200.0 [rad/s]	0.1/0.1	See J-28	Enabled	/	-	- /	-	

(Reference section): Refer to the inverter's individual manual.

[22] Motor constant

* : To be dealt as an index in case of 16-bit access. Sensorless vector/vector with sensor (/ :valid , - :invalid)

Title	Communication No	Function	Adjustment range	Min. unit (panel/communication)	Default setting	Write during running	Vector control			V/f Constant	Reference section
							Speed control	Torque control	Position control		
F400	0400	Auto-tuning	0:Without auto-tuning (internal table) 1:Motor constant initialization (0 after execution) 2:Automatic tuning execution (0 after execution)	-	0	Disabled	/	/	-/	-	6.20
F401	0401	Slip frequency gain	0.00 ~ 2.55	0.01/0.01	0.60	Enabled	/ -	-	-/	-	6.20
F402	0402	Motor constant #1 (primary resistance)	0.00 ~ 100000 [m] (*1)	0.01/0.01*	See J-28	Disabled	/	/	-/	-	6.20
F403	0403	Motor constant #2 (secondary resistance)	0.00 ~ 100000 [m] (*1)	0.01/0.01*	See J-28	Disabled	/	/	-/	-	6.20
F404	0404	Motor constant #3 (exciting inductance)	0.0 ~ 6500 [mH]	0.1/0.1	See J-28	Disabled	/	/	-/	-	6.20
F405	0405	Motor constant #4 (load inertia moment)	0.0 ~ 100.0	0.1/0.1	1.0	Enabled	/	/	-/	-	6.20
F410	0410	Motor constant #5 (leak inductance)	0.00 ~ 650.0 [mH]	0.01/0.01	See J-28	Disabled	/	/	-/	-	6.20
F411	0411	Number of motor poles	2, 4, 6, 8, 10, 12, 14, 16	1/1	4	Disabled	/	/	-/	-	6.20
F412	0412	Rated capacity of motor	0.10 ~ [Model Dependent]	0.01/0.01	See J-28	Disabled	/	/	-/	-	6.20
F413	0413	Motor type	0: Toshiba standard motor #1 1: Toshiba VF motor 2: Toshiba V3 motor 3: Toshiba standard motor #2 4: Other motors	-	0	Disabled	/	/	-/	-	6.20
F414	0414	Auto-tuning prohibition	0: Prohibited 1: Valid for sensorless vector 2: Valid for vector with PG	-	1	Disabled	/	/	-/	-	6.20

[23] Torque control

Title	Communication No	Function	Adjustment range	Min. unit (panel/communication)	Default setting	Write during running	Vector control			V/f Constant	Reference section
							Speed control	Torque control	Position control		
F420	0420	Torque reference selection	1: V/II, 2: RR, 3: RX, 4: RX2(optional), 5: Panel input, 6: Binary/BCD input(optional), 7: Common serial communication option, 8: Serial communication RS485, 9: Communication add-on cassette option	-	3	Enabled	-	/	-	-	6.21.1
F421	0421	Torque reference filter	10.0 ~ 199.9, 200.0(without filter)	0.1/0.1	200.0	Enabled	/	-/ -	-	-	6.21.2
F422	0422	Selection of synchronized torque bias input	0: Invalid, 1 to 9 (Same as F420)	-	0	Enabled	/	-	-/	-	6.21.4
F423	0423	Selection of tension torque bias input	0: Invalid, 1 to 9 (Same as F420)	-	0	Enabled	-	/	-	-	6.21.4
F424	0424	Load sharing gain input selection	0: Invalid, 1 to 9 (Same as F420)	-	0	Enabled	-	/	-	-	6.21.4
F425	0425	Forward speed limit input selection	0: Invalid, 1: V/II, 2: RR, 3: RX, 4: RX2(optional), 5: F426	-	0	Enabled	-	/	-/	-	6.21.3
F426	0426	Forward speed limit input level	0.0 ~ 44 [Hz]	0.01/0.01	80.0	Enabled	-	/	-/	-	6.21.3
F427	0427	Reverse speed limit input selection	0: Invalid, 1: V/II, 2: RR, 3: RX, 4: RX2(optional), 5: F428	-	0	Enabled	-	/	-/	-	6.21.3
F428	0428	Reverse speed limit input level	0.0 ~ 44 [Hz]	0.01/0.01	80.0	Enabled	-	/	-/	-	6.21.3
F429	0429	Torque reference mode selection	0: Fixed direction, 1:F/R permitted	-	0	Disabled	-	/	-	-	3.3.2
F430	0430	Speed limit (torque = 0) reference	0: Invalid, 1: V/II, 2: RR, 3: RX, 4: RX2(optional), 5: F431	-	0	Enabled	-	/	-	-	6.21.3
F431	0431	Speed limit (torque = 0) level	0.0 ~ F H [Hz]	0.01/0.01	0.0	Enabled	-	/	-	-	6.21.3
F432	0432	Speed limit (torque = 0) band	0.0 ~ F H [Hz]	0.01/0.01	0.0	Enabled	-	/	-	-	6.21.3
F433	0433	Speed limit (torque = 0) recovery time	0.00 ~ 2.50	0.01/0.01	0.20	Disabled	-	/	-	-	6.21.3

When adjustment value is 10 (10000m) or more, 1000(in case of 10000m) and E 1 blink alternately.

When adjustment value is 100 (10000m), 1000 and E 2 blink alternately.

[24] Torque limit

Sensorless vector/vector with sensor (valid, - :invalid)

Title	Communication No	Function	Adjustment range	Min. unit (panel/communication)	Default setting	Write during running	Vector control			V/f Constant	Reference section
							Speed control	Torque control	Position control		
F440	0440	Selection of power running torque limit #1	1 : VI/II, 2: RR, 3: RX, 4: RX2, 5: F441	-	5	Enabled	/	/	-/		6.22
F441	0441	Power running torque limit #1	0 ~ 249.9 [%], 250: Invalid	0.1/0.01	250.0	Enabled	/	/	-/		6.22
F442	0442	Selection of regenerative torque limit #1	1 : VI/II, 2: RR, 3: RX, 4: RX2, 5: F443	-	5	Enabled	/	/	-/		6.22
F443	0443	Regenerative torque limit #1	0 ~ 249.9 [%], 250: Invalid	0.1/0.01	250.0	Enabled	/	/	-/		6.22
F444	0444	Power running torque limit #2	0 ~ 249.9 [%], 250: Invalid	0.1/0.01	250.0	Enabled	/	/	-/		6.22
F445	0445	Regenerative torque limit #2	0 ~ 249.9 [%], 250: Invalid	0.1/0.01	250.0	Enabled	/	/	-/		6.22
F446	0446	Power running torque limit #3	0 ~ 249.9 [%], 250: Invalid	0.1/0.01	250.0	Enabled	/	/	-/		6.22
F447	0447	Regenerative torque limit #3	0 ~ 249.9 [%], 250: Invalid	0.1/0.01	250.0	Enabled	/	/	-/		6.22
F448	0448	Power running torque limit #4	0 ~ 249.9 [%], 250: Invalid	0.1/0.01	250.0	Enabled	/	/	-/		6.22
F449	0449	Regenerative torque limit #4	0 ~ 249.9 [%], 250: Invalid	0.1/0.01	250.0	Enabled	/	/	-/		6.22
F450	0450	Torque limit mode (polarity)	0: Power-running/regenerative torque limit 1: Positive/negative torque limit	-	0	Disabled	/	/	-/		6.22
F451	0451	Torque limit mode	0: Standard, 1: without speed cooperation	-	0	Enabled	/	-	-		
F452	0452	Continuous stall trip detection time during power running	0.0 ~ 1.0 [s]	0.1/0.01	0.0	Enabled	/	-	-		-
F453	0453	Stall prevention during regeneration	0: Stall 1: Stall is prevented	-	0	Enabled	/	-	-		-

[25] Speed/torque reference gain/bias setup #2(1/2)

Title	Communication No	Function	Adjustment range	Min. unit (panel/communication)	Default setting	Write during running	Vector control			V/f Constant	Reference section
							Speed control	Torque control	Position control		
F454	0454	Current differential gain	0.00 ~ 327.6	0.01/0.01	123.0	Enabled	/ -	-			-
F455	0455	High-speed magnetic field control gain	1.64 ~ 327.6	0.01/0.01	16.38	Enabled	/	/	/		-
F456	0456	High-speed magnetic field rate-of-change limitation gain	1.64 ~ 327.6	0.01/0.01	163.8	Enabled	/	/	/		-
F470	0470	VI/II reference bias	0 ~ 255	1/1	99	Enabled	/	/	/		-
F471	0471	VI/II reference gain	0 ~ 255	1/1	142	Enabled	/	/	/		-
F472	0472	RR reference bias	0 ~ 255	1/1	100	Enabled	/	/	/		-
F473	0473	RR reference gain	0 ~ 255	1/1	164	Enabled	/	/	/		-
F474	0474	RX reference bias	0 ~ 255	1/1	67	Enabled	/	/	/		-
F475	0475	RX reference gain	0 ~ 255	1/1	128	Enabled	/	/	/		-
F476	0476	RX2 reference bias	0 ~ 255	1/1	67	Enabled	/	/	/		-
F477	0477	RX2 reference gain	0 ~ 255	1/1	128	Enabled	/	/	/		-
F480	0480	Exciting strengthening coefficient	0 ~ 255	1/1	64	Enabled	/	/			-
F481	0481	Over-excitation cooperation	0: Enabled, 1: Applied by F480 setting	-	0	Enabled	/	/			-
F482	0482	Modulation rate control margin (current control)	80.0 ~ 300.0 [%]	0.1/0.01	90.0	Enabled	/	/	/	-	-

[25] Speed/torque reference gain/bias setup #2(2/2)

* Minimum setup unit is 0.1 in case of 16-bit access. Sensorless vector/vector with sensor (:valid, - :invalid)

Title	Communication No	Function	Adjustment range	Min. unit (panel/communication)	Default setting	Write during running	Vector control			V/f Constant	Reference section
							Speed control	Torque control	Position control		
F483	0483	Modulation rate control margin (voltage control)	80.0 ~ 300.0 [%]	0.1/0.01	105.0	Enabled	/			-	-
F484	0484	Modulation rate control margin (V/f control)	80.0 ~ 300.0 [%]	0.1/0.01	105.0	Enabled					-
F485	0485	Stall cooperation gain at field weakening zone	0 ~ 255	1/1	128	Enabled	/	/	/		-
F486	0486	Exciting starting rate	1.64 ~ 327.6	0.01/0.01	163.8	Enabled	/	/	/		-
F487	0487	Compensation coefficient for iron loss	0 ~ 255	1/1	10	Enabled	/	/	/		-
F488	0488	Voltage compensation coefficient for dead time	0.00 ~ 327.6	0.01/0.01	3.90	Enabled	/	/	/		-
F489	0489	Dead time compensation	0: Enabled, 1: Disabled	-	0	Enabled	/	/	/		-
F490	0490	Dead time compensation (bias time)	-3.27 ~ 3.27	0.01/0.001	0.00	Enabled	/	/	/		-
F491	0491	Current / voltage control switching frequency	10.0 ~ 60.0 [Hz]	0.1/0.01	40.0	Enabled	/				-

[26] Secondary acceleration/deceleration

Title	Communication No	Function	Adjustment range	Min. unit (panel/communication)	Default setting	Write during running	Vector control			V/f Constant	Reference section
							Speed control	Torque control	Position control		
F500	0500	Acceleration time #2	0.1(F508) ~ 6000 [s]	0.01/0.01*	See J-28	Enabled	/	-	-		6.23.2
F501	0501	Deceleration time #2	0.1(F508) ~ 6000 [s]	0.01/0.01*	See J-28	Enabled	/	-	-		6.23.2
F502	0502	Acceleration/deceleration pattern #1	0: Linear, 1: S-pattern #1, 2: S-pattern #2	-	0	Enabled	/	-	-		6.23.1
F503	0503	Acceleration/deceleration pattern #2	0: Linear, 1: S-pattern #1, 2: S-pattern #2	-	0	Enabled	/	-	-		6.23.2
F504	0504	Acceleration/deceleration #1,2,3,4 selection	1: Acceleration/deceleration #1 2: Acceleration/deceleration #2 3: Acceleration/deceleration #3 4: Acceleration/deceleration #4	-	1	Enabled	/	-	-		6.23.2
F505	0505	Acc/dec switching frequency #1	0.0 ~ FH [Hz]	0.01/0.01	0.0	Enabled	/	-	-		6.23.2
F506	0506	S-pattern lower-limit adjustment amount	0 ~ 50 [%]	1/0.01	25	Enabled	/	-	-		6.23.1
F507	0507	S-pattern upper-limit adjustment amount	0 ~ 50 [%]	1/0.01	25	Enabled	/	-	-		
F508	0508	Acc/dec time lower limit	0.01 ~ 10.00 [s]	0.01/0.01*	0.10	Enabled	/	-	-		6.23.3
F510	0510	Acceleration time #3	0.1(F508) ~ 6000 [s]	0.01/0.01*	See J-28	Enabled	/	-	-		6.23.2
F511	0511	Deceleration time #3	0.1(F508) ~ 6000 [s]	0.01/0.01*	See J-28	Enabled	/	-	-		6.23.2
F512	0512	Acceleration/deceleration pattern #3	0: Linear, 1: S-pattern #1, 2: S-pattern #2	-	0	Enabled	/	-	-		6.23.2
F513	0513	Acc/dec switching frequency #2	0.0 ~ FH [Hz]	0.01/0.01	0.0	Enabled	/	-	-		6.23.2
F514	0514	Acceleration time #4	0.1(F508) ~ 6000 [s]	0.01/0.01*	See J-28	Enabled	/	-	-		6.23.2
F515	0515	Deceleration time #4	0.1(F508) ~ 6000 [s]	0.01/0.01*	See J-28	Enabled	/	-	-		6.23.2
F516	0516	Acceleration/deceleration pattern #4	0: Linear, 1: S-pattern #1, 2: S-pattern #2	-	0	Enabled	/	-	-		6.23.2
F517	0517	Acc/dec switching frequency #3	0.0 ~ FH [Hz]	0.01/0.01	0.0	Enabled	/	-	-		6.23.2

(Reference section): Refer to the inverter's individual manual.

[27] Pattern run (1/2)

Sensorless vector/vector with sensor (/ : valid, - : invalid)

Title	Communication No	Function	Adjustment range	Min. unit (panel/communication)	Default setting	Write during running	Vector control			V/f Constant	Reference section
							Speed control	Torque control	Position control		
F520	0520	Pattern run selection	0: Disabled, 1: Enabled	-	0	Disabled	/	-	-		6.24
F521	0521	Pattern run mode	0: Patterned operation canceled during stop 1: Patterned operation continued during stop	-	0	Disabled	/	-	-		6.24
F530	0530	Cycle number of pattern group #1	1 ~ 254, 255:	1/1	1	Disabled	/	-	-		6.24
F531	0531	Pattern group #1 selection #1	0: Skip, 1 to 15	-	1	Disabled	/	-	-		6.24
F532	0532	Pattern group #1 selection #2	0: Skip, 1 to 15	-	2	Disabled	/	-	-		6.24
F533	0533	Pattern group #1 selection #3	0: Skip, 1 to 15	-	3	Disabled	/	-	-		6.24
F534	0534	Pattern group #1 selection #4	0: Skip, 1 to 15	-	4	Disabled	/	-	-		6.24
F535	0535	Pattern group #1 selection #5	0: Skip, 1 to 15	-	5	Disabled	/	-	-		6.24
F536	0536	Pattern group #1 selection #6	0: Skip, 1 to 15	-	6	Disabled	/	-	-		6.24
F537	0537	Pattern group #1 selection #7	0: Skip, 1 to 15	-	7	Disabled	/	-	-		6.24
F538	0538	Pattern group #1 selection #8	0: Skip, 1 to 15	-	8	Disabled	/	-	-		6.24
F540	0540	Cycle number of pattern group #2	1 ~ 254, 255:	1/1	1	Disabled	/	-	-		6.24
F541	0541	Pattern group #2 selection #1	0: Skip, 1 to 15	-	9	Disabled	/	-	-		6.24
F542	0542	Pattern group #2 selection #2	0: Skip, 1 to 15	-	10	Disabled	/	-	-		6.24
F543	0543	Pattern group #2 selection #3	0: Skip, 1 to 15	-	11	Disabled	/	-	-		6.24
F544	0544	Pattern group #2 selection #4	0: Skip, 1 to 15	-	12	Disabled	/	-	-		6.24
F545	0545	Pattern group #2 selection #5	0: Skip, 1 to 15	-	13	Disabled	/	-	-		6.24
F546	0546	Pattern group #2 selection #6	0: Skip, 1 to 15	-	14	Disabled	/	-	-		6.24
F547	0547	Pattern group #2 selection #7	0: Skip, 1 to 15	-	15	Disabled	/	-	-		6.24
F548	0548	Pattern group #2 selection #8	0: Skip, 1 to 15	-	0	Disabled	/	-	-		6.24
F550	0550	Cycle number of pattern group #3	1 ~ 254, 255:	1/1	1	Disabled	/	-	-		6.24
F551	0551	Pattern group #3 selection #1	0: Skip, 1 to 15	-	1	Disabled	/	-	-		6.24
F552	0552	Pattern group #3 selection #2	0: Skip, 1 to 15	-	2	Disabled	/	-	-		6.24
F553	0553	Pattern group #3 selection #3	0: Skip, 1 to 15	-	3	Disabled	/	-	-		6.24
F554	0554	Pattern group #3 selection #4	0: Skip, 1 to 15	-	4	Disabled	/	-	-		6.24
F555	0555	Pattern group #3 selection #5	0: Skip, 1 to 15	-	5	Disabled	/	-	-		6.24
F556	0556	Pattern group #3 selection #6	0: Skip, 1 to 15	-	6	Disabled	/	-	-		6.24
F557	0557	Pattern group #3 selection #7	0: Skip, 1 to 15	-	7	Disabled	/	-	-		6.24
F558	0558	Pattern group #3 selection #8	0: Skip, 1 to 15	-	8	Disabled	/	-	-		6.24
F560	0560	Cycle number of pattern group #4	1 ~ 254, 255:	1/1	1	Disabled	/	-	-		6.24
F561	0561	Pattern group #4 selection #1	0: Skip, 1 to 15	-	9	Disabled	/	-	-		6.24
F562	0562	Pattern group #4 selection #2	0: Skip, 1 to 15	-	10	Disabled	/	-	-		6.24
F563	0563	Pattern group #4 selection #3	0: Skip, 1 to 15	-	11	Disabled	/	-	-		6.24
F564	0564	Pattern group #4 selection #4	0: Skip, 1 to 15	-	12	Disabled	/	-	-		6.24
F565	0565	Pattern group #4 selection #5	0: Skip, 1 to 15	-	13	Disabled	/	-	-		6.24
F566	0566	Pattern group #4 selection #6	0: Skip, 1 to 15	-	14	Disabled	/	-	-		6.24
F567	0567	Pattern group #4 selection #7	0: Skip, 1 to 15	-	15	Disabled	/	-	-		6.24
F568	0568	Pattern group #4 selection #8	0: Skip, 1 to 15	-	0	Disabled	/	-	-		6.24

[27] Pattern run (2/2)

Sensorless vector/vector with sensor (valid, - :invalid)

Title	Communication No	Function	Adjustment range	Min. unit (panel/communication)	Default setting	Write during running	Vector control			V/f Constant	Reference section
							Speed control	Torque control	Position control		
<i>F570</i>	0570	Preset-speed #1 operation continuation mode	0: Operation time in second after start of operation 1: Operation time in minute after start of operation 2: Operation time in second after attainment of frequency 3: Operation time in minute after attainment of frequency 4: Infinite (continued until stop command is entered) 5: Continue until next step command	-	0	Disabled	/	-	-		6.24
<i>F571</i>	0571	Preset-speed #2 operation continuation mode	Ditto	-	0	Disabled	/	-	-		6.24
<i>F572</i>	0572	Preset-speed #3 operation continuation mode	Ditto	-	0	Disabled	/	-	-		6.24
<i>F573</i>	0573	Preset-speed #4 operation continuation mode	Ditto	-	0	Disabled	/	-	-		6.24
<i>F574</i>	0574	Preset-speed #5 operation continuation mode	Ditto	-	0	Disabled	/	-	-		6.24
<i>F575</i>	0575	Preset-speed #6 operation continuation mode	Ditto	-	0	Disabled	/	-	-		6.24
<i>F576</i>	0576	Preset-speed #7 operation continuation mode	Ditto	-	0	Disabled	/	-	-		6.24
<i>F577</i>	0577	Preset-speed #8 operation continuation mode	Ditto	-	0	Disabled	/	-	-		6.24
<i>F578</i>	0578	Preset-speed #9 operation continuation mode	Ditto	-	0	Disabled	/	-	-		6.24
<i>F579</i>	0579	Preset-speed #10 operation continuation mode	Ditto	-	0	Disabled	/	-	-		6.24
<i>F580</i>	0580	Preset-speed #11 operation continuation mode	Ditto	-	0	Disabled	/	-	-		6.24
<i>F581</i>	0581	Preset-speed #12 operation continuation mode	Ditto	-	0	Disabled	/	-	-		6.24
<i>F582</i>	0582	Preset-speed #13 operation continuation mode	Ditto	-	0	Disabled	/	-	-		6.24
<i>F583</i>	0583	Preset-speed #14 operation continuation mode	Ditto	-	0	Disabled	/	-	-		6.24
<i>F584</i>	0584	Preset-speed #15 operation continuation mode	Ditto	-	0	Disabled	/	-	-		6.24
<i>F585</i>	0585	Preset-speed #1 operation time	1 ~ 8000 [s] / [min] (The unit depends on <i>F570</i>)	1/1	5	Enabled	/	-	-		6.24
<i>F586</i>	0586	Preset-speed #2 operation time	Ditto	1/1	5	Enabled	/	-	-		6.24
<i>F587</i>	0587	Preset-speed #3 operation time	Ditto	1/1	5	Enabled	/	-	-		6.24
<i>F588</i>	0588	Preset-speed #4 operation time	Ditto	1/1	5	Enabled	/	-	-		6.24
<i>F589</i>	0589	Preset-speed #5 operation time	Ditto	1/1	5	Enabled	/	-	-		6.24
<i>F590</i>	0590	Preset-speed #6 operation time	Ditto	1/1	5	Enabled	/	-	-		6.24
<i>F591</i>	0591	Preset-speed #7 operation time	Ditto	1/1	5	Enabled	/	-	-		6.24
<i>F592</i>	0592	Preset-speed #8 operation time	Ditto	1/1	5	Enabled	/	-	-		6.24
<i>F593</i>	0593	Preset-speed #9 operation time	Ditto	1/1	5	Enabled	/	-	-		6.24
<i>F594</i>	0594	Preset-speed #10 operation time	Ditto	1/1	5	Enabled	/	-	-		6.24
<i>F595</i>	0595	Preset-speed #11 operation time	Ditto	1/1	5	Enabled	/	-	-		6.24
<i>F596</i>	0596	Preset-speed #12 operation time	Ditto	1/1	5	Enabled	/	-	-		6.24
<i>F597</i>	0597	Preset-speed #13 operation time	Ditto	1/1	5	Enabled	/	-	-		6.24
<i>F598</i>	0598	Preset-speed #14 operation time	Ditto	1/1	5	Enabled	/	-	-		6.24
<i>F599</i>	0599	Preset-speed #15 operation time	Ditto	1/1	5	Enabled	/	-	-		6.24

[28] Protection functions

Sensorless vector/vector with sensor (valid, - :invalid)

Title	Communication No	Function	Adjustment range	Min. unit (panel/communication)	Default setting	Write during running	Vector control			V/f Constant	Reference section
							Speed control	Torque control	Position control		
F600	0600	Motor overload protection level #1	10 ~ 100 [%]	1/0.01	100	Enabled	/	/	-/		5.13
F601	0601	Stall prevention level	0 ~ 199 [%], 200: Disabled	1/0.01	120	Enabled	/	-/-	-/		6.25.2
F602	0602	Selection of inverter trip holding	0: Cleared if power is turned off 1: Held even if power is turned off	-	0	Disabled	/	/	-/		6.25.3
F603	0603	Emergency stop	0: Coast stop 1: Deceleration stop 2: Emergency DC injection braking stop 3: Coast stop without FL output 4: Deceleration stop without FL output 5: Emergency DC injection braking without FL output	-	0	Disabled	/	/	-/		6.25.4
F604	0604	Emergency DC injection braking control time	0.0 ~ 10.0 [s]	0.1/0.01	0.1	Enabled	/	/	-/		6.25.4
F605	0605	Output phase failure detection	0: Disabled, 1: Enabled	-	0	Disabled	/	/	-/		
F606	0606	Overload reduction start-up frequency	0.0 ~ 30.0 [Hz]	0.01/0.01	6.0	Enabled	/	/	-/		5.13
F607	0607	Motor 150%-overload time limit	10 ~ 2400 [s]	1/1	600	Enabled	/	/	-/		5.13
F608	0608	Relay injection timing for rush-current suppression	0.3 ~ 2.5 [s]	0.1/0.01	0.3	Disabled	/	/	-/		
F609	0609	Mode of rush-current suppression relay	0: Standard, 1: in relation to ST	-	0	Disabled	/	/	-/		
F610	0610	Low current trip	0: Disabled, 1: Enabled	-	0	Disabled	/	/	-/		6.25.7
F611	0611	Low current detection level	0 ~ 100 [%]	1/0.01	0	Enabled	/	/	-/		6.25.7
F612	0612	Low current detection time	0 ~ 255 [s]	1/1	0	Enabled	/	/	-/		6.25.7
F613	0613	Detection of output short-circuit during start-up	0: Standard 1: Only one time at power injection or at first start after reset	-	0	Disabled	/	/	-/		6.25.8
F614	0614	Adjustment of detection pulse for output short-circuit during start-up	1 ~ 100 [μ s]	1/1	50	Disabled	/	/	-/		6.25.8
F615	0615	Over-torque trip	0: Disabled, 1: Enabled	-	0	Enabled	/	/	-/		6.25.9
F616	0616	Over-torque detection level during power running	0 ~ 250 [%]	1/0.01	120	Enabled	/	/	-/		6.25.9
F617	0617	Over-torque detection level during regeneration	0 ~ 250 [%]	1/0.01	120	Enabled	/	/	-/		6.25.9
F618	0618	Over-torque detection time	0.0 ~ 100.0 [s]	0.1/0.01	0.5	Enabled	/	/	-/		6.25.9
F620	0620	Cooling fan control mode	0: Automatic, 1: Always ON	-	0	Enabled	/	/	-/		6.25.10
F621	0621	Cumulative operation time alarm setting	0.1 ~ 999.9 [\times 100h]	0.1/0.1	175.0	Enabled	/	/	-/		6.25.11
F622	0622	Abnormal speed detection filter	0.01 ~ 100.0 [s] (*1)	0.01/0.01	10.00	Enabled	-/	-/-	-/-	-/-	
F623	0623	Over-speed detection frequency range	0: Disabled, 0.1 ~ 30.0 [Hz]	0.01/0.01	0.0	Enabled	-/	-/-	-/-	-	
F624	0624	Speed drop detection frequency range	0: Disabled, 0.1 ~ 30.0 [Hz]	0.01/0.01	0.0	Enabled	-/	-/-	-/-	-	
F625	0625	Over-voltage stall protection level (high response)	50 ~ 250 [%]	1/0.01	135	Enabled	/	-	-		6.13.5
F626	0626	Over-voltage stall protection level	50 ~ 250 [%]	1/0.01	130	Enabled	/	-	-		6.13.5
F627	0627	Under-voltage trip mode	0: Disabled, 1: Enabled	-	0	Disabled	/	/	-/		6.25.13
F628	0628	Under-voltage detection time	0.00 ~ 10.00 [s]	0.01/0.01	0.03	Disabled	/	/	-/		6.25.14
F629	0629	Under-voltage stall level	50 ~ 100 [%]	1/0.01	75	Enabled	/	/	-/		6.25.15
F630	0630	System-supporting sequence(B-timer)	0.0: Invalid, 0.1 ~ 10.0 [s]	0.1/0.01	0.0	Enabled	/	/	-/		
F631	0631	Position deviation limit	0.1 ~ 6553	0.1/0.1	16	Disabled	-	-	-/	-	
F632	0632	Brake release inhibition time after run	0.00: Setting of F612 is valid, 0.01 ~ 2.50 [s]	0.01/0.01	0.00	Disabled	/	/	-/		
F633	0633	The trip selection at the V/I low-level input	0 ~ 100	1/1	0.00	Enabled	/	/	-/		

(*1): Set a time longer than the acceleration/deceleration time.

(Reference section): Refer to the inverter's individual manual.

[29] Special analog input

Sensorless vector/vector with sensor (valid, - :invalid)

Title	Communication No	Function	Adjustment range	Min. unit (panel/communication)	Default setting	Write during running	Vector control			V/f Constant	Reference section
							Speed control	Torque control	Position control		
F650	0650	Acceleration/deceleration base frequency adjustment	0: Invalid , 1: VI/II , 2: RR	-	0	Enabled	/	-	-		6.26
F651	0651	Upper-limit frequency adjustment	0: Invalid , 1: VI/II , 2: RR	-	0	Enabled	/	-	-		6.26
F652	0652	Acceleration time adjustment	0: Invalid , 1: VI/II , 2: RR	-	0	Enabled	/	-	-		6.26
F653	0653	Deceleration time adjustment	0: Invalid , 1: VI/II , 2: RR	-	0	Enabled	/	-	-		6.26
F654	0654	Manual torque boost adjustment	0: Invalid , 1: VI/II , 2: RR	-	0	Enabled	-	-	-		6.26

[30] Over-ride

Title	Communication No	Function	Adjustment range	Min. unit (panel/communication)	Default setting	Write during running	Vector control			V/f Constant	Reference section
							Speed control	Torque control	Position control		
F660	0660	Over-ride addition input selection	0: Disabled 1: VI (voltage input)/II (current input) 2: RR (voltage/voltage input) 3: RX (voltage input) 4: RX2 (voltage input) (optional) 5: Operating panel input 6: Binary/BCD input 7: Common serial communication option(FA01) 8: Serial communication RS485(FA05) 9: Communication add-on cassette option(FA07) 10: Up-down frequency 11: Pulse input #1 (optional)	-	0	Enabled	/	-	-		6.27
F661	0661	Over-ride multiplication input selection	0: Disabled,1: VI/II,2: RR,3: RX,4: RX2,5: F 7 2 9	-	0	Enabled	/	-	-		6.27

[31] Meter output (1/2)

Title	Communication No	Function	Adjustment range	Min. unit (panel/communication)	Default setting	Write during running	Vector control			V/f Constant	Reference section
							Speed control	Torque control	Position control		
F670	0670	AM terminal meter selection	0 ~ 32	-	2(output current)	Enabled	/	/	-/		5.4
F671	0671	AM terminal meter adjustment	-	-	-	Enabled	/	/	-/		5.4
F672	0672	Optional analog terminal #1 meter selection	0 ~ 32	-	4	Enabled	/	/	-/		
F673	0673	Optional analog terminal #1 meter adjustment	-	-	-	Enabled	/	/	-/		
F674	0674	Optional analog terminal #2 meter selection	0 ~ 32	-	5	Enabled	/	/	-/		
F675	0675	Optional analog terminal #2 meter adjustment	-	-	-	Enabled	/	/	-/		
F676	0676	FP terminal meter selection	0 ~ 32	-	0	Enabled	/	/	-/		6.28.3
F677	0677	FP terminal meter adjustment	1.00 ~ 43.20	0.01/0.001	3.84	Enabled	/	/	-/		6.28.3
F678	0678	Optional analog terminal #1 meter offset	-10.0 ~ 60.0	0.1/0.1	0.0	Enabled	/	/	-/		
F679	0679	Optional analog terminal #2 meter offset	-10.0 ~ 60.0	0.1/0.1	0.0	Enabled	/	/	-/		
F680	0680	Optional analog terminal sign selection	0 ~ 3	-	0	Enabled	/	/	-/		

(Reference section): Refer to the inverter's individual manual.

[31] Meter output (2/2)

Sensorless vector/vector with sensor (valid, - :invalid)

Title	Communication No	Function	Adjustment range	Min. unit (panel/communication)	Default setting	Write during running	Vector control			V/f Constant	Reference section
							Speed control	Torque control	Position control		
F690 ~ F697	0690 ~ 0697	AM/FM output parameter for adjustment	-	-	-	-	-	-	-	-	-

[32] Control panel parameters

Title	Communication No	Function	Adjustment range	Min. unit (panel/communication)	Default setting	Write during running	Vector control			V/f Constant	Reference section
							Speed control	Torque control	Position control		
F700	0700	Prohibition of parameter setting	0: Allowed , 1: Prohibited	-	0	Enabled	/	/	-/		6.29.1
F701	0701	Current/voltage display mode	0: [%], 1: [A] or [V]	-	0	Enabled	/	/	-/		6.29.2
F702	0702	Frequency free unit magnification	0.00: OFF, 0.01 ~ 200.0	0.01/0.01	0.00	Enabled	/	/	-/		6.29.3
F703	0703	Decimal place number of frequency	0: 1 [Hz], 1: 0.1 [Hz], 2: 0.01 [Hz]	-	1	Enabled	/	/	-/		6.29.4
F704	0704	Decimal place number of acc/dec time	0: 1[s], 1: 0.1[s], 2: 0.01[s]	-	1	Enabled	/	/	-/		6.29.4
F709	0709	Prohibition of user parameter initialization at type form initialization	0: Allowed 1: Prohibited	-	0	Enabled	/	/	/		-
F710	0710	Monitor display mode setting	0 ~ 29	-	0	Enabled	/	/	-/		8.1
F711	0711	Status monitor #1 display mode	0 ~ 29	-	1	Enabled	/	/	-/		8.1
F712	0712	Status monitor #2 display mode	0 ~ 29	-	2	Enabled	/	/	-/		8.1
F713	0713	Status monitor #3 display mode	0 ~ 29	-	3	Enabled	/	/	-/		8.1
F714	0714	Status monitor #4 display mode	0 ~ 29	-	4	Enabled	/	/	-/		8.1
F720	0720	Selection of panel V/f1, 2, 3 or 4	1: V/f #1, 2: V/f #2, 3: V/f #3, 4: V/f #4	-	1	Enabled	-	-	-		6.29.6
F721	0721	Panel stop pattern	0: Deceleration stop , 1: Coast stop	-	0	Disabled	/	/	-/		6.29.7
F722	0722	Panel reset function	0: Disabled, 1: Enabled	-	1	Disabled	/	/	-/		6.29.8
F723	0723	Panel torque limit	1 ~ 4	-	1	Enabled	/	/	-/		6.29.9
F724	0724	Panel PID control OFF	0: ON, 1: OFF	-	0	Enabled	/	-	-		6.29.10
F725	0725	Panel torque reference	0 ~ 250 [%]	1/0.01	0	Enabled	-	/	-		6.29.11
F726	0726	Panel synchronized torque bias	-250 ~ 250 [%]	1/0.01	0	Enabled	/	-	-/		6.21.4
F727	0727	Panel tension torque bias	-250 ~ 250 [%]	1/0.01	0	Enabled	-	/	-		6.21.4
F728	0728	Panel load sharing gain	0 ~ 250 [%]	1/0.01	100	Enabled	-	/	-		6.21.4
F729	0729	Panel over-ride multiplication gain	-100 ~ 100 [%]	1/0.01	0	Enabled	/	-	-		6.29.13
F730	0730	Panel operation prohibition	0: All key operations prohibited +1: Panel frequency setting enabled +2: Parameter reading/writing enabled +4: Monitor display operation enabled +8: Panel drive operation enabled (+16: no function) +32: Emergency stop operation enabled 63: Default mode (all key operation enabled)	-	63	Disabled	/	/	-/		6.29.14

[33] Communication function(1/2)

Sensorless vector/vector with sensor (valid, - :invalid)

Title	Communication No	Function	Adjustment range	Min. unit (panel/communication)	Default setting	Write during running	Vector control			V/f Constant	Reference section
							Speed control	Torque control	Position control		
F800	0800	Communication rate (common serial)	0: 1200, 1: 2400, 2:4800, 3: 9600	-	3	Enabled	/	/	-/		6.30
F801	0801	Parity (common serial/RS485)	0: No parity, 1: Even parity, 2: Odd parity	-	1	Enabled	/	/	-/		6.30
F802	0802	Inverter number(common)(*1)	0 ~ 255	1/1	0	Enabled	/	/	-/		6.30
F803	0803	Communication time-out (common serial/RS485)	0: OFF, 1 ~ 100 [s]	1/1	0	Enabled	/	/	-/		6.30
F804	0804	Communication time-out action (common serial /RS485)	0 ~ 8	-	8	Enabled	/	/	-/		6.30
F805	0805	Communication waiting time (common serial)	0.00: Normal, 0.01 ~ 2.00 [s]	0.01/0.01	0.00	Enabled	/	/	-/		6.30
F806	0806	Inter-drive communication (common serial)	0: Normal, 1: Frequency reference, 2: Output frequency, 3: Torque reference, 4: Output torque	-	0	Enabled	/	/	-/		6.30
F810	0810	Frequency point selection	0: Invalid, 1: Common serial, 2: RS485, 3: Communication add-on cassette option	-	0	Enabled	/	-	-		6.30
F811	0811	Point #1 setting	0 ~ 100 [%]	1/0.01	0	Enabled	/	-	-		6.30
F812	0812	Point #1 frequency	0.0 ~ FH [Hz]	0.01/0.01	0.0	Enabled	/	-	-		6.30
F813	0813	Point #2 setting	0 ~ 100 [%]	1/0.01	100	Enabled	/	-	-		6.30
F814	0814	Point #2 frequency	0.0 ~ FH [Hz]	0.01/0.01	80.0	Enabled	/	-	-		6.30
F820	0820	Communication rate (RS485)	0: 1200, 1: 2400, 2: 4800, 3: 9600, 4: 19200, 5: 38400	-	3	Enabled	/	/	-/		6.30
F821	0821	RS485 wiring system	0: 2-line system, 1: 4-line system	-	1	Enabled	/	/	-/		6.30
F825	0825	RS485 communication waiting time	0.00: Normal, 0.01 ~ 2.00 [s]	0.01/0.01	0.00	Enabled	/	/	-/		6.30
F826	0826	Inter-drive communication (RS-485)	0: Normal, 1: Frequency reference, 2: Output frequency, 3: Torque reference, 4: Output torque	-	0	Enabled	/	/	-/		6.30
F830	0830	Data type	0, 1	1/1	0	Enabled	/	/	-/		
F831	0831	Input reference setting #1	0 ~ 16	1/1	0	Enabled	/	/	-/		
F832	0832	Input reference setting #2	0 ~ 16	1/1	0	Enabled	/	/	-/		
F833	0833	Input reference setting #3	0 ~ 16	1/1	0	Enabled	/	/	-/		
F834	0834	Input reference setting #4	0 ~ 16	1/1	0	Enabled	/	/	-/		
F835	0835	Input reference setting #5	0 ~ 16	1/1	0	Enabled	/	/	-/		
F836	0836	Input reference setting #6	0 ~ 16	1/1	0	Enabled	/	/	-/		
F841	0841	Monitor output setting #1	0 ~ 16	1/1	0	Enabled	/	/	-/		
F842	0842	Monitor output setting #2	0 ~ 16	1/1	0	Enabled	/	/	-/		
F843	0843	Monitor output setting #3	0 ~ 16	1/1	0	Enabled	/	/	-/		
F844	0844	Monitor output setting #4	0 ~ 16	1/1	0	Enabled	/	/	-/		
F845	0845	Monitor output setting #5	0 ~ 16	1/1	0	Enabled	/	/	-/		
F846	0846	Monitor output setting #6	0 ~ 16	1/1	0	Enabled	/	/	-/		
F850	0850	Mode at communication error	0 ~ 4	1/1	0	Enabled	/	/	-/		
F851	0851	Communication error detection time	0 ~ 1000	1/1	200	Enabled	/	/	-/		
F860	0860	Receiving address	0 ~ 1023	1/1	0	Enabled	/	/	-/		
F861	0861	Transmitting address	0 ~ 1023	1/1	0	Enabled	/	/	-/		

(*1): To be only monitoring available when using S20 option.

(*2): Parameters F800, F801, F820, F821, and F826 can be reflected at resetting (power OFF → ON).

(Reference section): Refer to the inverter's individual manual.

[33] Communication function(2/2)

Sensorless vector/vector with sensor (/ : valid, - : invalid)

Title	Communication No	Function	Adjustment range	Min. unit (panel/communication)	Default setting	Write during running	Vector control			V/f Constant	Reference section
							Speed control	Torque control	Position control		
F862	0862	Inter-drive communication(speed reference) opposite station number	0 ~ 64	1/1	0	Enabled	/	/	- /		
F863	0863	Inter-drive communication(speed reference) opposite station address	0 ~ 1023	1/1	0	Enabled	/	/	- /		
F865	0865	Inter-drive communication(torque reference) opposite station number	0 ~ 64	1/1	0	Enabled	/	/	- /		
F866	0866	Inter-drive communication(torque reference) opposite station address	0 ~ 1023	1/1	0	Enabled	/	/	- /		
F868	0868	S20 fault detection station number	0 ~ 64	1/1	0	Enabled	/	/	- /		
F869	0869	Station mode selection	0 ~ 4	1/1	0	Enabled	/	/	- /		
F890 ~ F894	8090 ~ 0894	Parameters for options	Depend on options	1/1	0	Disabled	/	/	- /		
F899	0899	Reset function	0, 1	-	0	Disabled	/	/	- /		

[34] Reservation area

Title	Communication No	Function	Adjustment range	Min. unit (panel/communication)	Default setting	Write during running	Vector control			V/f Constant	Reference section
							Speed control	Torque control	Position control		
F900	0900	Reservation area #1	0	-	0	-	-	-	-	-	-
F901	0901	Reservation area #2	0	-	0	-	-	-	-	-	-
F902	0902	Reservation area #3	0	-	0	-	-	-	-	-	-
F903	0903	Reservation area #4	0	-	0	-	-	-	-	-	-
F904	0904	Reservation area #5	0	-	0	-	-	-	-	-	-

☐ : These titles are displayed but unusable. Only the standard default value is displayed.
(reference section): Refer to the designated section of the inverter's individual manual.

[Contents of monitor indications]

Sensorless vector/vector with sensor (: valid, - : invalid)

Communication number	Function	Communication unit	Monitor output selection	Trip holding	Meter output selection	Speed control	Torque control	Position control	V/f constant	Reference section	
	Standard monitor		F710		(*1)					8.1	
FE00	Trip frequency monitor	0.01 [Hz]	when tripped	when tripped	-	/	/	- /			
Contents of status monitor indications											
FE90	Pattern run group selection		at a pattern run	hold	-	/	-	-			
FE91	Number of times to repeat current pattern	1	at a pattern run	hold	-	/	-	-			
FE92	Number of stages for multistage pattern run	1	at a pattern run	hold	-	/	-	-			
FE93	Remaining time of current pattern run	1	at a pattern run	hold	-	/	-	-			
FE01	Status (rotation direction)		Fixed	hold	-	/	/	- /			
	Status monitor #1		F711		(*1)						
	Status monitor #2		F712		(*1)						
	Status monitor #3		F713		(*1)						
	Status monitor #4		F714		(*1)						
FE06	Input terminal information		Fixed	hold	-	/	/	- /			
FE50	Input terminal information (optional)		Fixed	hold	-	/	/	- /			
FE51	Input terminal information (optional)		Fixed	hold	-	/	/	- /			
FE07	Output terminal information		Fixed	hold	-	/	/	- /			
FE52	Output terminal information (optional)		Fixed	hold	-	/	/	- /			
FE53	Output terminal information (optional)		Fixed	hold	-	/	/	- /			
FE48	Sink/source switching status		Fixed	not hold	-	/	/	- /			
FE47	Type of connected option		Fixed	not hold	-	/	/	- /			
FE54	Standard default value set last	1	Fixed	not hold	-	/	/	- /			
FE55	Last set automatic control (RUC)	1	Fixed	not hold	-	/	/	- /			
FE08	CPU version	1	Fixed	not hold	-	/	/	- /			
FE43	Flush memory version	1	Fixed	not hold	-	/	/	- /			
FE09	Control EEPROM version	1	Fixed	not hold	-	/	/	- /			
FE44	Main circuit EEPROM version	1	Fixed	not hold	-	/	/	- /			
FE10	Past trip #1		Fixed	not hold	-	/	/	- /			
FE11	Past trip #2		Fixed	not hold	-	/	/	- /			
FE12	Past trip #3		Fixed	not hold	-	/	/	- /			
FE13	Past trip #4		Fixed	not hold	-	/	/	- /			
FE14	Cumulative operation time	1 hour	Fixed	not hold	-	/	/	- /			

Status in a trip may not be held depending on selected function. Refer to next page.

[Monitor FM/AM/pulse output function selection]

Sensorless vector/vector with sensor (/ : valid, - : invalid)

	Communication number	Function	Communication unit	Monitor output selection	Trip holding	Meter output selection	Speed control	Torque control	Position control	V/f constant	Reference section
0	FD00	Running frequency	0.01 [Hz]	0	(*3)	0	/	/	- /		5.4
1	FE02	Frequency command	0.01 [Hz]	1	hold	1	/	-	-		
2	FE03	Current	0.01 [%]	2	hold	2	/	/	- /		
3	FE04	DC voltage	0.01 [%]	3	hold	3	/	/	- /		
4	FE05	Output voltage	0.01 [%]	4	hold	4	/	/	- /		
5	FE15	After-compensation frequency	0.01 [Hz]	5	hold	5	/	/	- /		
6	FE16	Speed feedback (real-time value)	0.01 [Hz]	6	hold	6	- /	- /	- /		
7	FE17	Speed feedback (1 second filter)	0.01 [Hz]	7	hold	7	- /	- /	- /	-	
8	FE18	Torque	0.01 [%]	8	hold	8	/	/	- /	(*2)	
9	FE19	Torque reference	0.01 [%]	9	hold	9	-	/	-	-	
10	FE56	Internal torque reference (*1)	0.01 [%]	10	hold	10	/	/	- /	-	
11	FE20	Torque current	0.01 [%]	11	hold	11	/	/	- /	(*2)	
12	FE21	Exciting current	0.01 [%]	12	hold	12	/	/	- /	(*2)	
13	FE22	PID feedback value	0.01 [Hz]	13	hold	13	/	-	-		
14	FE23	Motor overload factor (OL2 data)	0.01 [%]	14	hold	14	/	/	- /		
15	FE24	Inverter overload factor (OL1 data)	0.01 [%]	15	hold	15	/	/	- /		
16	FE25	PBr overload factor (PBrOL data)	0.01 [%]	16	hold	16	/	/	- /		
17	FE28	PBr load factor (pulse duty)	0.01 [%]	17	hold	17	/	/	- /		
18	FE29	Input power	0.01 [kW]	18	hold	18	/	/	- /		
19	FE30	Output power	0.01 [kW]	19	hold	19	/	/	- /		
20	FE31	Peak output current	0.01 [%]	20	hold	20	/	/	- /		
21	FE32	Peak DC voltage	0.01 [%]	21	hold	21	/	/	- /		
22	FE33	Motor counter dummy PG	1 count	22	hold	22	/	/	- /		
23	FE34	Position pulse	1count	23	hold	23	-	-	- /	-	
24	FE35	PR input	0.01 [%]	24	not hold	24	/	/	- /		
25	FE36	VI/II input	0.01 [%]	25	not hold	25	/	/	- /		
26	FE37	RX input	0.01 [%]	26	not hold	26	/	/	- /		
27	FE38	RX2 input	0.01 [%]	27	not hold	27	/	/	- /		
28	FE39	FM output	0.01 [%]	28	not hold	28	/	/	- /		
29	FE40	AM output	0.01 [%]	29	not hold	29	/	/	- /		
30	FE57	Fixed output for meter adjustment	0.01 [%]	-	hold	30	/	/	- /		
31	FE64	Analog output for communication	0.01 [%]	-	not hold	31	/	/	- /		
32	FE60	Acc/dec torque removal	0.01 [%]	-	not hold	32	- /	- / -	- /	-	

(*1): When $P \neq 7, 8, 9$, / under speed control.

(*2): Reference data

(*3): Trip frequency is displayed in another way.

For details, refer to section 5.4; [Terminal FM-related parameters].

For monitor indications, refer to section 8.2; [Set up values of monitor indication parameters].

Communication number 31 (Analog output for communication) outputs analog data of FA51.

[Input terminal function setting (1/2)]

Sensorless vector/vector with sensor (: valid, - : invalid)

Positive logic	Negative logic	Function	Speed control	Torque control	Position control	V/f constant	\overline{CND}	$F106=1$	Reference section
0	1	No assignment function	/	/	- /			-	7.2.1
2	3	F: Forward operation command	/	/	- /			-	
4	5	R: Reverse operation command	/	/	- /			-	
6	7	ST: Standby (Inverse)	/	/	- /		(*1)	-	
8	9	RES: Reset	/	/	- /		(*2)	-	
10	11	S1: Preset-speed #1	/	-	-			-	
12	13	S2: Preset-speed #2	/	-	-			-	
14	15	S3: Preset-speed #3	/	-	-			-	
16	17	S4: Preset-speed #4	/	-	-			-	
18	19	Jog run	/	-	-			-	
20	21	Emergency stop	/	/	- /		(*2)	-	
22	23	DC injection breaking	/	-	-			-	
24	25	Acc/dec switching #1	/	-	-			-	
26	27	Acc/dec switching #2	/	-	-			-	
28	29	V/f switching #1	/	-	-			-	
30	31	V/f switching #2	/	-	-			-	
32	33	Torque limit switching #1	/	/	- /		(*3)	-	
34	35	Torque limit switching #2	/	/	- /		(*3)	-	
36	37	PID control OFF selection	/	-	-			-	
38	39	Pattern group #1	/	-	-		-	-	
40	41	Pattern group #2	/	-	-		-	-	
42	43	Pattern group #3	/	-	-		-	-	
44	45	Pattern group #4	/	-	-		-	-	
46	47	Pattern run continuation signal	/	-	-		-	-	
48	49	Pattern run trigger signal	/	-	-		-	-	
50	51	Forced Jog forward operation	/	-	-			-	
52	53	Forced Jog reverse operation	/	-	-			-	
54	55	Reservation area	-	-	-	-	-	-	
56	57	Reservation area	-	-	-	-	-	-	
58	59	Reservation area	-	-	-	-	-	-	
60	61	Reservation area	-	-	-	-	-	-	
62	63	Reservation area	-	-	-	-	-	-	
64	65	Reservation area	-	-	-	-	-	-	
66	67	Reservation area	-	-	-	-	-	-	
68	69	Reservation area	-	-	-	-	-	-	

(*1): Valid any time

(*2): Independent of \overline{CND} , and all command are valid.(*3): Dependent on \overline{CND} .

□ : Reservation area. Do not set at these functions.

[Input terminal function setting (2/2)]

Sensorless vector/vector with sensor (: valid, - : invalid)

Positive logic	Negative logic	Function	Speed control	Torque control	Position control	V/f constant	τ_{POd}	$F_{106}=1$	Reference section
70	71	Reservation area	-	-	-	-	-	-	7.2.1
72	73	Reservation area	-	-	-	-	-	-	
74	75	Reservation area	-	-	-	-	-	-	
76	77	Reservation area	-	-	-	-	-	-	
78	79	Reservation area	-	-	-	-	-	-	
80	81	Reservation area	-	-	-	-	-	-	
82	83	Reservation area	-	-	-	-	-	-	
84	85	Reservation area	-	-	-	-	-	-	
86	87	Binary data write	/	/	-		-	-	
88	89	Up/down frequency (up) (*1)	/	-	-		-	-	
90	91	Up/down frequency (down) (*1)	/	-	-		-	-	
92	93	Up/down frequency (clear)	/	-	-		-	-	
94	95	PUSH-type run command	/	/	- /			-	
96	97	PUSH-type stop command	/	/	- /			-	
98	99	Forward/reverse selection	/	/	- /			-	
100	101	Run/stop command	/	/	- /			-	
102	103	Commercial power/INV switching	/	-	-		-	-	
104	105	Frequency reference priority switching	/	-	-		-	-	
106	107	VI/II terminal priority	/	-	-		-	-	
108	109	Command terminal board priority	/	/	- /		-	-	
110	111	Parameter editing enabling	/	/	- /		-	-	
112	113	Control switching (torque, position)	/	/	- /	-	(*2)	-	
114	115	Deviation counter clear	-	-	- /	-	-	-	
116	117	Position control forward limit LS	-	-	- /	-	-	-	
118	119	Position control reverse limit LS	-	-	- /	-	-	-	
120	121	Light load high-speed operation enabling	/	-	-		-	-	
122	123	Reservation area	-	-	-	-	-	-	
124	125	Preliminary excitation	/	/	- /			-	
126	127	System consistent sequence (BC: Braking command)	/	-	-			-	
128	129	System-supporting sequence (B: Brake release)	/	-	-			-	
130	131	System-supporting sequence (BA: Brake answer)	/	-	-			-	
132	133	System-supporting sequence (BT: Brake test)	/	-	-			-	
134	135	Reservation area	-	-	-	-	-	-	

(*1): Acceleration/ Deceleration time depend on $F500$ or $F501$.

(*2): Dependent on τ_{POd} .

: Reservation area. Do not set at these functions.

[Output terminal function setting (1/2)]

Sensorless vector/vector with sensor (: valid, - : invalid)

Positive logic	Negative logic	Function	Speed control	Torque control	Position control	V/f constant	Reference section
0	1	Lower limit frequency(L _L)	/	/	- /		7.2.2
2	3	Upper limit frequency(U _L)	/	/	- /		
4	5	Low speed signal	/	/	- /		
6	7	Acceleration/deceleration completion	/	-	-		
8	9	Specified speed arrival	/	/	- /		
10	11	Failure FL (all trip)	/	/	- /		
12	13	Failure FL (except for EF and OCL)	/	/	- /		
14	15	Over-current pre-alarm	/	/	- /		
16	17	Inverter overload pre-alarm	/	/	- /		
18	19	Motor overload pre-alarm	/	/	- /		
20	21	Overheat pre-alarm	/	/	- /		
22	23	Over-voltage pre-alarm	/	/	- /		
24	25	Main circuit under-voltage (ROFF) detected	/	/	- /		
26	27	Low current detected	/	/	- /		
28	29	Over-torque detected	/	/	- /		
30	31	Braking resistor overload (OLr) pre-alarm	/	/	- /		
32	33	In emergency stop	/	/	- /		
34	35	In course of retry	/	/	- /		
36	37	Pattern run switching output	/	-	-		
38	39	PID deviation limit	/	-	-		
40	41	Run/stop	/	/	- /		
42	43	Serious failure (OCR, OCL, EF, phase failure, etc.)	/	/	- /		
44	45	Light failure (OL, OC 1, 2, 3, OP)	/	/	- /		
46	47	Commercial/INV switching output #1(for inverter operation output)	/	-	-		
48	49	Commercial/INV switching output #2(for commercial operation output)	/	-	-		
50	51	Cooling fan ON/OFF	/	/	- /		
52	53	In Jog run	/	-	-		
54	55	Panel operation/terminal board operation switching	/	/	- /		
56	57	Cumulative operation time alarm	/	/	- /		
58	59	Abnormal communication alarm #1 (caused by scanning)	/	/	- /		
60	61	Forward/reverse switching	/	/	- /		
62	63	Ready for operation #1	/	/	- /		

[Output terminal function setting (2/2)]

Sensorless vector/vector with sensor (/ : valid, - : invalid)

Positive logic	Negative logic	Function	Speed control	Torque control	Position control	V/f constant	Reference section
64	65	Ready for operation #2	/	/	-/		7.2.2
66	67	Poor control power supply (PQFF) pre-alarm	/	/	-/		
68	69	System consistent sequence (BR: Brake release)	/	-	-		
70	71	In (pre-)alarm status	/	/	-/		
72	73	Forward speed limit (torque control)	-	/	-/	-	
74	75	Reverse speed limit (torque control)	-	/	-/	-	
76	77	Inverter healthy output	/	/	-/		
78	79	Abnormal communication alarm #2 (caused by RS485 logic or message transmission)	/	/	-/		
80	81	Error code output #1 (6-bit output)	/	/	-/		
82	83	Error code output #2 (6-bit output)	/	/	-/		
84	85	Error code output #3 (6-bit output)	/	/	-/		
86	87	Error code output #4 (6-bit output)	/	/	-/		
88	89	Error code output #5 (6-bit output)	/	/	-/		
90	91	Error code output #6 (6-bit output)	/	/	-/		
92	93	Designated data output #1 (7-bit output)	/	/	-/		
94	95	Designated data output #2 (7-bit output)	/	/	-/		
96	97	Designated data output #3 (7-bit output)	/	/	-/		
98	99	Designated data output #4 (7-bit output)	/	/	-/		
100	101	Designated data output #5 (7-bit output)	/	/	-/		
102	103	Designated data output #6 (7-bit output)	/	/	-/		
104	105	Designated data output #7 (7-bit output)	/	/	-/		
106	107	Light load signal	/	-/-	-/-		
108	109	Heavy load signal	/	-/-	-/-		
110	111	Positive torque limit	/	/	-/		
112	113	Negative torque limit	/	/	-/		
114	115	Output for external rush suppression relay	/	/	-/		
116	117	Over travel	-/-	-/-	-/	-	
118	119	Completion of positioning	-/-	-/-	-/	-	

[Default settings]

Inverter model	Acc/dec time <i>ACC/DEC</i> F500/F501 F510/F511 F514/F515	Torque boost <i>ub</i> F172 F176 F180	Base freq. voltage F171 F175 F306	Dynamic braking mode F304	Dynamic braking resistance F308	Dynamic braking resistor capacity F309	PWM carrier frequency F300	Inverter side switching waiting time F356	Auto-restart adjustment #1 F312	Auto-restart adjustment #2 F313	Auto-restart mode F314	Current control integral gain F375	Speed loop proportional gain F376 F397	Speed loop integral gain F377 F398	Motor constant #1 (primary resistance) F402	Motor constant #2 (secondary resistance) F403	Motor constant #3 (exciting inductance) F404	Motor constant #5 (leak inductance) F410	Rated capacity of motor (*2) F412	Voltage compensation coefficient for dead time F488
VFP7-2185P	30.0	3.0	200.0	0	7.5	0.88	12.0	1.37	1.00	1.00	0	385.0	62.5	32.5	56.92	39.20	17.0	1.24	18.50	3.90
VFP7-2220P	30.0	3.0	200.0	0	3.3	1.76	12.0	1.37	1.00	1.00	0	385.0	62.5	32.5	44.28	36.80	15.5	1.05	22.00	3.90
VFP7-2300P	30.0	3.0	200.0	0	3.3	1.20	12.0	1.37	1.00	1.00	0	385.0	62.5	32.5	34.04	30.50	11.7	0.79	30.00	3.90
VFP7-2370P	30.0	3.0	200.0	0	2.0	2.00	8.0	1.87	1.00	1.00	3	385.0	62.5	32.5	24.38	30.20	9.9	0.66	37.00	0.00
VFP7-2450P	30.0	3.0	200.0	0	2.0	2.00	8.0	1.87	1.00	1.00	3	385.0	62.5	32.5	18.28	22.90	7.8	0.51	45.00	0.00
VFP7-2550P	30.0	3.0	200.0	0	2.0	2.00	2.2	1.87	1.00	1.00	3	385.0	62.5	32.5	13.22	12.40	6.1	0.38	55.00	0.00
VFP7-2750P	60.0	2.0	200.0	0	1.7	3.40	2.2	2.37	1.20	1.20	3	270.0	75.0	25.0	10.35	12.20	6.2	0.36	75.00	0.00
VFP7-2900P	60.0	2.0	200.0	0	1.7	3.40	2.2	2.37	1.20	1.20	3	270.0	75.0	25.0	7.48	9.30	4.8	0.29	90.00	0.00
VFP7-2110KP	60.0	2.0	200.0	0	1.7	3.40	2.2	2.87	1.20	1.20	3	270.0	75.0	25.0	5.06	8.00	3.7	0.25	110.0	0.00
VFP7-4185P	30.0	3.0	400.0	0	30.0	0.88	12.0	1.37	1.00	1.00	0	385.0	62.5	32.5	227.9	156.9	70.4	4.96	18.50	3.90
VFP7-4220P	30.0	3.0	400.0	0	15.0	1.76	12.0	1.37	1.00	1.00	0	385.0	62.5	32.5	176.9	147.0	62.1	4.20	22.00	3.90
VFP7-4300P	30.0	3.0	400.0	0	13.3	1.20	12.0	1.37	1.00	1.00	0	385.0	62.5	32.5	135.9	122.1	46.8	3.16	30.00	3.90
VFP7-4370P	30.0	3.0	400.0	0	13.3	1.20	8.0	1.87	1.00	1.00	3	385.0	62.5	32.5	97.52	120.7	39.8	2.65	37.00	3.90
VFP7-4450P	30.0	3.0	400.0	0	8.0	2.00	8.0	1.87	1.00	1.00	3	385.0	62.5	32.5	73.26	91.60	31.3	2.03	45.00	0.00
VFP7-4550P	30.0	3.0	400.0	0	8.0	2.00	8.0	1.87	1.00	1.00	3	385.0	62.5	32.5	52.78	49.50	24.4	1.52	55.00	0.00
VFP7-4750P	60.0	3.0	400.0	0	8.0	2.00	2.2	2.37	1.10	1.10	3	270.0	75.0	25.0	41.63	48.60	24.7	1.43	75.00	0.00
VFP7-4900P	60.0	2.0	400.0	0	8.0	2.00	2.2	2.37	1.00	1.00	3	270.0	75.0	25.0	29.78	37.30	19.4	1.18	90.00	0.00
VFP7-4110KP	60.0	2.0	400.0	0	3.7	7.40	2.2	2.87	1.10	1.10	3	270.0	75.0	25.0	20.47	32.20	14.9	1.02	110.0	0.00
VFP7-4132KP	60.0	2.0	400.0	0	3.7	7.40	2.2	2.87	1.20	1.20	3	270.0	75.0	25.0	12.42	22.80	11.8	0.80	132.0	0.00
VFP7-4160KP	60.0	1.5	400.0	0	3.7	7.40	2.2	3.37	1.00	1.00	3	270.0	75.0	25.0	9.43	7.80	8.9	0.59	160.0	0.00
VFP7-4200KP	60.0	1.5	400.0	0	1.9	8.70	2.2	3.37	0.50	0.50	3	270.0	75.0	25.0	5.98	8.80	7.2	0.45	200.0	0.00
VFP7-4220KP	60.0	1.5	400.0	0	1.9	8.70	2.2	3.37	0.50	0.50	3	270.0	75.0	25.0	5.98	8.80	7.2	0.45	220.0	0.00
VFP7-4280KP	60.0	1.0	400.0	0	1.4	14.00	2.2	3.37	1.40	0.50	3	270.0	75.0	25.0	4.83	4.30	6.8	0.34	280.0	0.00
VFP7-4315KP	60.0	1.0	400.0	0	1.4	14.00	2.2	3.37	1.40	0.50	3	270.0	75.0	25.0	2.65	1.90	4.0	0.27	315.0	0.00

(*1): For each inverter model, F412's upper limit is rated capacity of one rank larger inverter. (Example: For the model VFP7-2185P, the upper limit is 22.00)

11. Specifications by types

11. 1 Standard specifications by types

1) Standard specifications by types

Item		Description					
Voltage class		200 V class					
Applicable motor [kW]		18.5	22	30	37	45	55
Ratings	Model No.	VFP7-					
	Type	2185P	2220P	2300P	2370P	2450P	2550P
	Output capacity [kVA] (*1)	28	34	46	55	69	84
	Output current [A]	73	88	120	144	180	220
	Output voltage	3-phase 200 to 230 V (Maximum output voltage corresponds to input supply voltage.)					
Rated overload current		120% for 1 minutes, 180% for 0.5 second					
Electric braking	Dynamic braking circuit	Built-in dynamic braking drive circuit			Optional		
	Dynamic braking resistor	External braking resistor/ braking unit is optionally available. Rating: Refer to 6.13.4.					
Power supply	Voltage, frequency	Main circuit		3-phase 200-220 V, 50 Hz 3-phase 200-230 V, 60 Hz			
	Control circuit(*2)	Option		Single phase 200-220 V, 50 Hz Single phase 200-230 V, 60 Hz			
Allowable fluctuation		Voltage: +10% / -15% (*5), Frequency: +/-5%					
Protection structure		Enclosed type (JEM1030) IP20 (*3)			Open type (JEM1030) IP00 (*4)		
Cooling system		Forced-air cooling					
Coating color		Munsell 5Y-8/0.5					
EMI filter		Option to be installed externally					

Item		Description							
Voltage class		400 V class							
Applicable motor [kW]		18.5	22	30	37	45	55	75	90
Ratings	Model No.	VFP7-							
	Type	4185P	4220P	4300P	4370P	4450P	4550P	4750P	4900P
	Output capacity [kVA] (*1)	28	34	46	55	69	84	110	143
	Output current [A]	37	44	60	72	90	110	144	180
	Output voltage	3-phase 380 to 400 V (Maximum output voltage corresponds to input supply voltage.)							
Rated overload current		120 % for 1 minutes, 180 % for 0.5 second							(*6)
Electric braking	Dynamic braking circuit	Built-in dynamic braking drive circuit			Optional				
	Dynamic braking resistor	External braking resistor/ braking unit is optionally available. Rating: Refer to 6.13.4.							
Power supply	Voltage, frequency	Main circuit		3-phase 380-440 V, 50 Hz 3-phase 380-460 V, 60 Hz					
	Control circuit(*2)	Option		Single phase 380-440 V, 50 Hz Single phase 380-460 V, 60 Hz					
Allowable fluctuation		Voltage: +10%/-15% (*5), Frequency: +/-5%							
Protection structure		Enclosed type (JEM1030) IP20 (*3)			Open type (JEM1030) IP00 (*4)				
Cooling system		Forced-air cooling							
Coating color		Munsell 5Y-8/0.5							
EMI filter		Option to be installed externally							

- (*1): Rated output capacity indicates a value based on the condition that output voltage is 220 V in case of the 200 V class or 440 V in case of the 400 V class.
- (*2): The models of 22 kW or lower has no control power supply terminals(R0, S0). Optional control power supply is available for those types.
- (*3): There are three openings for wiring; namely, wiring holes for main circuit input, for main circuit output and for control circuit. After wiring is complete, close the openings properly.
- (*4): The models of 30 kW or higher have neither cover for the wiring hole that has a big aperture nor space for bending external cables inside the unit. When a protector is installed externally, use an optional cover for the wiring hole.
- (*5): Allowable voltage variation is +/-10 % in continuously operation (100 % load).
- (*6): 120 % for 1 minutes, 150 % for 0.3 second

2) Standard specifications by types

Item		Description			
Voltage class		200 V class			
Applicable motor [kW]		75	90	110	
Ratings	Model No.		VFP7-		
	Type		2750P	2900P	2110KP
	Output capacity [kVA] (*1)		110	133	160
	Output current [A]		288	350	420
	Output voltage		3-phase 200 to 230 V (Maximum output voltage corresponds to input supply voltage.)		
	Rated overload current		120% for 1 minute, 150% for 0.3 second (*5)		
Electric braking	Dynamic braking circuit		Built-in type dynamic braking drive circuit is optionally available		
	Dynamic braking resistor		External braking resistor is available optionally		
Power supply	Voltage, frequency	Main circuit	3-phase 200-230 V, 50/60 Hz		
		Control circuit	Single phase 200-230 V, 50/60 Hz		
	Allowable fluctuation		Voltage: +10%/-15% (*3), Frequency: +/-5%		
Protection structure		Open type (JEM1030) IP00 (*2)			
Cooling system		Forced-air cooling			
Coating color		Munsell 5Y-8/0.5			
EMI filter		Option to be installed externally			

Item		Description							
Voltage class		400 V class							
Applicable motor [kW]		110	132	160	200	220	280	315	
Ratings	Type		VFP7-						
	Form		4110KP	4132KP	4160KP	4200KP	4220KP	4280KP	4315KP
	Output capacity [kVA] (*1)		160	194	236	300	320	412	470
	Output current [A]		210	255	310	377	420	540	590
	Output voltage		3-phase 380-460 V (Maximum output voltage corresponds to input supply voltage.)						
	Rated overload current		120% for 1 minute, 150% for 0.3 second (*5)						
Electric braking	Dynamic braking circuit		Built-in type dynamic braking drive circuit is optionally available						
	Dynamic braking resistor		External braking resistor is available optionally						
Power supply	Voltage, frequency	Main circuit	3-phase 380-460 V, 50/60 Hz						
		Control circuit	Single phase 380-460 V, 50/60 Hz						
	Allowable fluctuation		Voltage: +10%/-15% (*3), Frequency: +/-5%						
Protection structure		Open type (JEM1030) IP00 (*2)							
Cooling method		Forced-air cooling							
Coating color		Munsell 5Y-8/0.5							
EMI filter		Option to be installed externally							

(*1): Rated output capacity indicates a value based on the condition that output voltage is 220 V in case of the 200 V class or 440 V in case of the 400 V class.

(*2): The models of 30 kW or higher have neither cover for the wiring hole that has a big aperture nor space for bending external cables inside the unit. When a protector is installed externally, use an optional cover for the wiring hole.

(*3): Allowable voltage variation is +/-10 % in continuously operation (100 % load)

(*4): Be sure to attach DC reactor for the models: 200V class 75kW or more and 400V class 110kW or more. (Not necessary for DC input.)

(*5): This regulation is overload value from the stop state at ambient temperature state within regulation value.

3) Comparison in specifications (different points only)

Item	VFP7-2185P ~ 2550P VFP7-4185P ~ 4750P	VFP7-2750P ~ 2110KP VFP7-4900P ~ 4315KP
1. Rated overload current	120 % for 1 minutes 180 % for 0.5 second	120 % for 1 minutes 150 % for 0.3 second
2. PWM carrier frequency	Default setting: 12 kHz (200 V class 37,45 kW type: 8 kHz 200 V class 55 kW type: 2.2 kHz 400 V class 37-55 kW type: 8 kHz 400 V class 75 kW type: 2.2 kHz) Adjustable between 0.5 and 15 kHz 2550P,4750P: Adjustable between 0.5 and 8 kHz	Default setting: 2.2 kHz Adjustable between 0.5 and 5 kHz
3. Acceleration/deceleration time (default setting)	30 seconds 4750P: 60 seconds	60 seconds

4) Common specifications

Item	Description	
Control specifications	Control method	Sinusoidal PWM control
	Output voltage adjustment	Main circuit voltage feedback control (Automatic regulation, "fixed" and "control off" selections possible)
	Output frequency range	0.01 to 400Hz, set to 0.01 to 80Hz by default, max. frequency adjustable from 30 to 400Hz
	Frequency setting resolution	0.01Hz: operation panel input (60Hz base), 0.015Hz: analog input (60Hz base, 12/16 bit/0-10Vdc)
	Frequency precision	+/-0.2% of the max. output frequency (25+/-10°C): analog input, +/-0.01% (25+/-10°C): digital input
	Voltage/frequency characteristic	Constant V/f, variable torque, automatic torque boost, vector control and automatic energy-saving control, base frequency 1·2·3·4 adjustment (25 to 400Hz) arbitrary V/f 5-point settings, torque boost adjustment (0 to 30%), start-up frequency adjustment (0 to 10Hz), end frequency adjustment (0 to 30Hz)
	Frequency setting signal	3kΩ potentiometer (1 to 10kΩ-potentiometer connection also possible), 0 to 10Vdc (input impedance Zin: 33kΩ), 0 to +/-10Vdc (Zin: 67kΩ), 4 to 20mAdc (Zin: 500Ω)
	Terminal board reference frequency input	2 sources can be set from a total of seven types, including analog input (RR, VI, II, RX, RX2), pulse and binary/BCD (*RX2 and binary/BCD: optional)
	Frequency jump	Can be set in three places, jump frequency and band setting
	Upper/lower limit frequencies	Upper limit frequency: 0 to maximum frequency, lower limit frequency: 0 to upper limit frequency
	PWM carrier frequency selections	Adjustable within a range of 0.5 to 15kHz (0.5 to 8kHz for 200V 55kW models and 400V 75kW models, 0.5 to 5kHz for 200V 75-110kW models and 400V 90-315kW models)
	PID control	Proportional gain, integral time, anti-hunting gain, filter delay adjustments
	Torque control	Voltage control reference: DC0 to +/-10V
Operation specifications	Acceleration/deceleration time	0.01 to 6000 sec., acceleration/deceleration time selectable from among 1, 2, 3 and 4, automatic acceleration/deceleration function, S-pattern acceleration/deceleration patterns 1 and 2 adjustment
	DC injection braking	Braking start frequency: adjustment (0 to 120Hz), braking current adjustment: (0 to 100%), braking time adjustment: (0 to 10 sec.), emergency stop braking function, motor shaft stationary control function
	Forward/reverse run (*1)	Forward run F-CC "closed", reverse when R-CC "closed", reverse when both "closed" coast stop when ST-CC "opened", Emergency stop from panel or terminal block
	Jog run (*1)	Jog run from panel with JOG mode selection. Terminal block operation possible with parameter settings.
	Preset-speed operation (*1)	Set frequency +15-speed preset speeds possible with open/close combinations. S1, S2,S3, S4 and CC Acceleration/deceleration time, torque limit and V/f selectable on a frequency.
	Retry	When a protective function activities, after main circuit devices are checked, running restarts. Settable to a max. of 10times. wait time adjustment (0 to 10sec)
	Soft-stall	Automatic load reduction control during overload (Default setting: OFF)
	Cooling fan ON/OFF	Fan is automatically stopped, When not necessary to ensure to extended life time.
	Panel key operation ON/OFF switching	Prohibit functions such as reset only or monitor only etc., can be selected. All key operations can be also prohibited. A protection reset function which requires special operation to enable it is available.
	Regenerative power ride-through control	Operation is continued even during momentary power failure using regenerative energy from the motor. (Default setting: OFF)
	Auto-restart in	The motor can be restarted at the same speed in the same direction it run under no-load conditions before stop. (Default setting: OFF)
	Simple pattern run	32 patterns in 4 groups (8 pattern in each group) can be set according to 15-speed operation frequency. Up to 32 patterns of operation, control from terminal board/repeated operation possible.
	Commercial power/inverter switching	Power supply to motor, switchable between commercial power and inverter
	High-speed run at low-load	With this function, the load applied to the motor can be monitored. Its rotating speed is increased to improve the operation efficiency when the load applied to it is low.
	Drooping function	This function prevent a load from being imposed to a single inverter because of imbalance, when more than one inverter is used in combination to drive the load.
Override function	Preset frequency control value adjustable by signals from an external control unit	
Protection	Protective function	Stall prevention, current limit, over-current, over-voltage, load-side short-circuit, load-side ground fault(*6), undervoltage, momentary power failure (15ms or longer), regeneration power ride-through control, electronic thermal overload protection, armature over-current during start-up, load-side over-current during start-up, dynamic braking resistor overload, heat sink overheat, emergency stop
	Electronic thermal characteristic	Standard motor/constant-torque VF motor switching, electronic thermal stall prevention operational level adjustment
	Reset	Reset triggered by closing 1a-contact (or opening 1b-contact), by control panel operation, or by turning on the power after turning off temporarily. Tripped state retention and clear settings

(Continued on the following page)

(Continued from the preceding page)

Item		Description
Display functions	Warning message	Stall prevention during operation, over-current suppression, overload, power source-side undervoltage (optional), DC circuit undervoltage, setting error, retry in process, upper/lower limits.
	Fault causes trouble	Overcurrent, over-voltage, heat sink overheat, load-side short-circuit, load-side ground fault, inverter overload, armature over-current during start-up, load-side over-current during start-up, EEPROM error, RAM error, ROM error, transfer error (dynamic braking resistor overload), (emergency stop), (undervoltage), (weak current), (over-torque), (motor overload), (output open-phase). Items in parentheses are selectable.
	4-digit 7-segment LED Monitoring function	Operation frequency, operation frequency command, operating direction (forward/reverse), output current, DC voltage, output voltage, compensated frequency, terminal board input/output information, CPU version, control EEPROM version, tripping history, cumulative operation time, speed feedback, torque, torque command, torque current, exciting current, PID feedback value, motor overload rate, inverter overload rate, PBR overload rate, PBR load rate, power supply, output current, peak output current, peak DC voltage, motor counter pseudo PG, position pulse, RR input, VI/II input, RX input, RX2 input, FM output, AM output, fixed output for meter adjustment, flash memory version, main circuit EEPROM version, connection option types, previous default setting, previous automatic control (AU2), sink/source switching status.
	Selectable unit display	Can select frequency display to match motor speed, line speed, etc. Selection of display of current in amperes/%, voltage in voltage/%.
	Edit function	Parameters different from those set by default are retrieved automatically, so that parameters changed can be detected easily.
	User settings initialization	Original parameters set by user can be stored. Parameters stored can be reset to original user-defined parameters.
LED	Charge indicator	Indicates that main circuit capacitors are charged.
Input/output terminal logic switching		A-contact/B-contact switchable by making a selection from the programmable I/O terminal function menu. (*1), (*2) (Default setting: A-contact)
Sink/source switching		Negative common (CC) and positive common (P24) of control terminal are switchable to each other. (On shipment, negative common [CC] is selected as default setting.)
Output signals	Fault detection signal	1c contact output (250Vac-2A-cos ϕ = 1,250Vac-1A-cos ϕ = 0.4, 30Vdc-1A)
	Low-speed/speed reach signal output (*2)	Open-collector output (24Vdc, Max. 50mA, output impedance: 33 Ω)
	Upper/lower limit frequency output (*2)	Open-collector output (24Vdc, Max. 50mA, output impedance: 33 Ω)
	Frequency meter output/ammeter output (*3)	Analog output, 1mAdc full-scale ammeter or 7.5Vdc-1mA voltmeter.
	Pulse train frequency output	Open-collector output (24Vdc, Max. 50mA)
Communication functions		RS485 equipped as standard (connector: modular 8P, optional device required for communication with more than one unit) RS232C, TOSLINE-F10M and TOSLINE-S20 are optional. DeviceNet and ProfiBus are on the drawing board.
Service conditions	Service environment	Indoor, altitude 1000m or less, not subject to direct sunlight or corrosive/explosive gas or steam.
	Ambient temperature	-10 to +50°C
	Storage temperature	-25 to +65°C
	Relative humidity	20 to 93% (no condensation allowed)
	Vibration	5.9m/s ² {0.6G} or less (10 to 55Hz) (according to JIS C0911)

(*1): The 16 contact-input terminals (8 of which are optional) are programmable. For each of them, a signal can be selected from among 136 signals.

(*2): For each programmable ON/OFF output terminal, a signal can be selected from among 120 signals.

(*3): For each programmable analog output terminal, a signal can be selected from among 32 signals.

(*4): When the cover is removed, the unit must be placed in the panel to prevent the charger from being exposed. For the 30kW and larger models, the unit can be used in a temperature range of -10 to +50°C with the cover left attached.

(*5): The models with a capacity of 30kW or more have uncovered wide-opened wiring holes and the unit has no space in it which is large enough to bend external cables. So, use a optional wiring hole covers when installing the unit outside.

(*6): Protect the inverter from over-current caused by output-side ground fault.

11.2 External dimensions and mass

External dimensions and mass

Voltage class	Applicable motor [kW]	Inverter type	Dimensions [mm]					Outline drawing	Approx. mass [kg]
			W	H	D	W1	H1		
200V	18.5	VFP7-2185P	245	390	207	225	370	A	16
	22	VFP7-2220P							16
	30	VFP7-2300P	300	555	197	200	537	B	23
	37	VFP7-2370P	370	630	290	317.5	609	C	44
	45	VFP7-2450P							46
	55	VFP7-2550P							46
	75	VFP7-2750P	480	680	330	426	652	D	72
	90	VFP7-2900P	660	950	370	598	920	E	148
110	VFP7-2110KP	148							
400V	18.5	VFP7-4185P	245	390	207	225	370	A	16
	22	VFP7-4220P							16
	30	VFP7-4300P	300	555	197	200	537	B	24
	37	VFP7-4370P							24
	45	VFP7-4450P	370	630	290	317.5	609	C	48
	55	VFP7-4550P							48
	75	VFP7-4750P							49
	90	VFP7-4900P	480	680	330	426	652	D	49
	110	VFP7-4110KP							75
	132	VFP7-4132KP	480	680	330	426	652	D	77
	160	VFP7-4160KP							77
	200	VFP7-4200KP	660	950	370	598	920	E	166
	220	VFP7-4220KP							166
280	VFP7-4280KP	168							
315	VFP7-4315KP	168							
		168							

Outline drawings

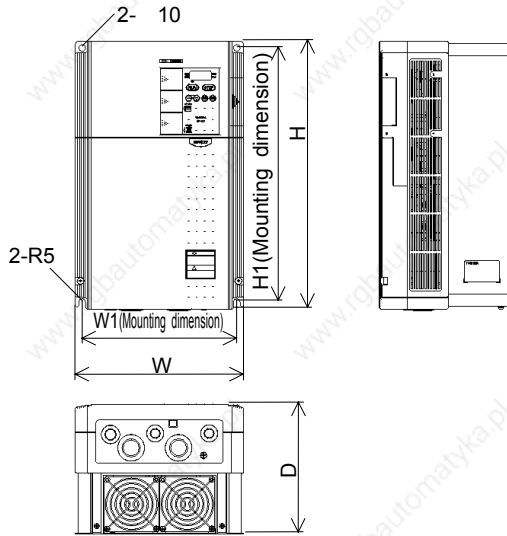

Note) VFP7-2185P, -2220P, -4185P, -4220P have cooling fan in the upper part.

Drawing A

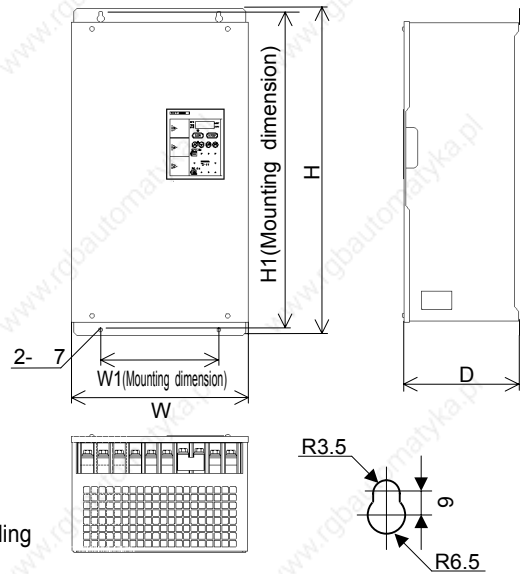

Drawing B

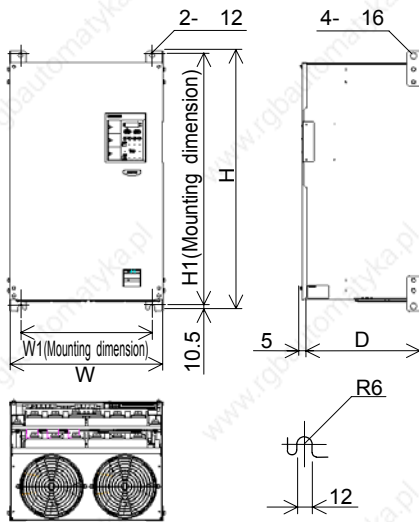

Drawing C

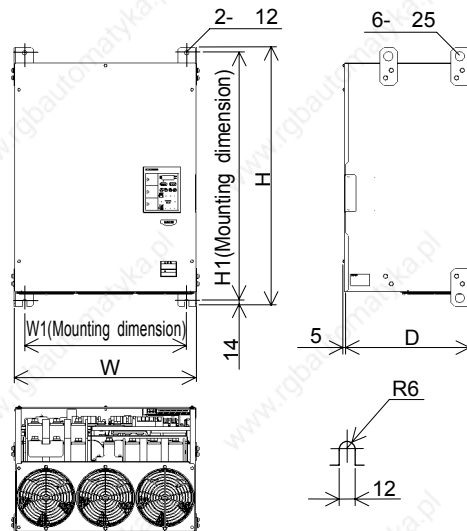

Drawing D

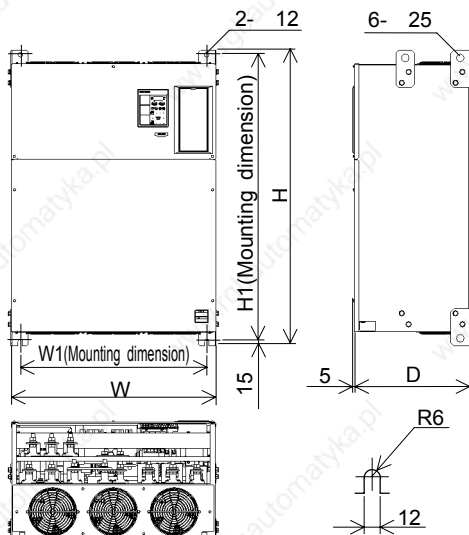

Drawing E

Dimensions for heat-sink going out attachment(simple type)

Dimensions when heat-sink going out attachment (simple type, refer to page A-18) is carried out becomes as follows. For dimensions not in the table below, refer to the dimensions for normal attachment (Drawing C, D, E). Mass is as same as the time of the normal attachment.

Voltage class	Applicable motor [kW]	Inverter type	Dimensions [mm]				Panel-cut dimensions [mm]					
			W2	H2	D2	D3	W3	H3	W4	H4	H5	Screw hole
200V	37	VFP7-2370P	445	630	161	287	375	590	417	609	9.5	4-M10 screw
	45	VFP7-2450P										
	55	VFP7-2550P										
	75	VFP7-2750P	573	680	186	330	500	630	527	652	12.5	4-M10 screw
	90	VFP7-2900P	762	950	173	370	680	890	712	920	15	4-M12 screw
	110	VFP7-2110KP										
400V	45	VFP7-4450P	445	630	161	287	375	590	417	609	9.5	4-M10 screw
	55	VFP7-4550P										
	75	VFP7-4750P										
	90	VFP7-4900P										
	110	VFP7-4110KP	573	680	186	330	500	630	527	652	12.5	4-M10 screw
	132	VFP7-4132KP										
	160	VFP7-4160KP	762	950	173	370	680	890	712	920	15	4-M12 screw
	200	VFP7-4200KP										
	220	VFP7-4220KP										
	280	VFP7-4280KP										
315	VFP7-4315KP											

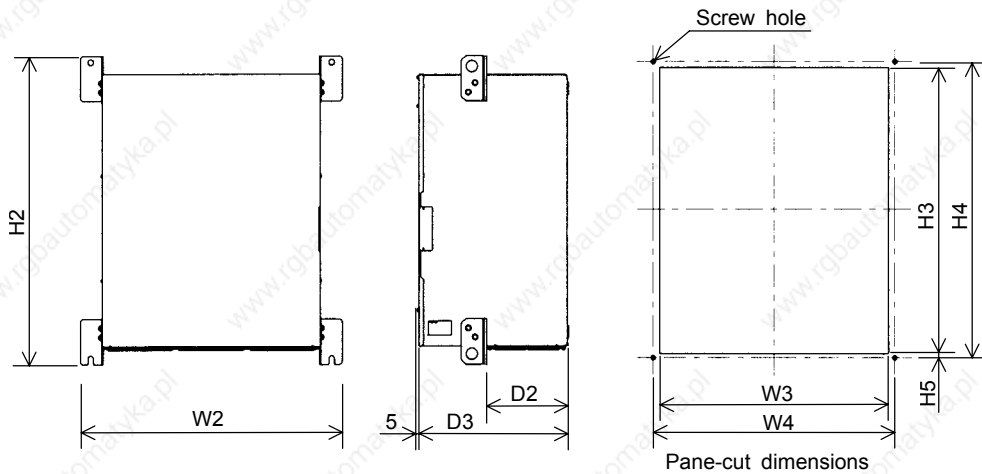

12. Prior to service call - Trip information and countermeasures

12. 1 Cause of trip, warning indication (in detail and countermeasures)

If there is something abnormal in the inverter or system, troubleshoot referring to the following table before calling service. If the inverter needs to replace some part or the cause of the trouble cannot be removed by the measures mentioned in the table, consult the dealer of the inverter about the trouble.

[Trip information]

Indication	Contents	Expected causes	Countermeasures
<i>OC1</i> <i>OC1P</i>	Overcurrent during acceleration (DC current)	<ul style="list-style-type: none"> Acceleration time #1 <i>ACC</i> is too short. V/f parameter is improperly set. Running motor is started during momentary power failure. Special motor (low impedance) is used, isn't it? Manual torque boost value (<i>ub</i>) is large. 	<ul style="list-style-type: none"> Extend acceleration time #1 <i>ACC</i>. Check V/f parameter. Use <i>F301</i> (Auto-restart) or <i>F302</i> (Regenerative power ride-through control). Raise carrier frequency <i>F300</i>. Decrease <i>ub</i> setting value.
<i>OC2</i> <i>OC2P</i>	Overcurrent during deceleration (DC current)	<ul style="list-style-type: none"> Deceleration time #1 <i>dEC</i> is too short (in deceleration). 	<ul style="list-style-type: none"> Extend deceleration time #1 <i>dEC</i>.
<i>OC3</i> <i>OC3P</i>	Overcurrent during fixed speed (DC current)	<ul style="list-style-type: none"> Load rapidly varied. Load is abnormal. 	<ul style="list-style-type: none"> Reduce load variation. Check loading unit.
Note: <i>OC1P</i> , <i>OC2P</i> , <i>OC3P</i> originate from causes other than those mentioned above.		<ul style="list-style-type: none"> A device of main circuit is faulty. Overheat protection is activated. (5.5 to 15 kW, 30 kW) Control voltage drop prevention function is activated. (5.5 to 15 kW, 30 kW types) 	<ul style="list-style-type: none"> Make a service call. Check operation of cooling fan. Check cooling fan control mode parameter <i>F520</i>.
<i>OCL</i>	Overcurrent (loaded side over-current at start time)	<ul style="list-style-type: none"> Failure in wiring of main output circuit or motor insulation. Motor impedance is too low. 	<ul style="list-style-type: none"> Check the wiring and motor insulation. Properly set output short-circuit detection parameter <i>F613</i> and <i>F614</i>.
<i>OCRA1</i>	U-phase arm short-circuit	<ul style="list-style-type: none"> Something abnormal in some device of main circuit (U-phase). 	<ul style="list-style-type: none"> Make a service call.
<i>OCRA2</i>	V-phase arm short-circuit	<ul style="list-style-type: none"> Something abnormal in some device of main circuit (V-phase). 	<ul style="list-style-type: none"> Make a service call.
<i>OCRA3</i>	W-phase arm short-circuit	<ul style="list-style-type: none"> Something abnormal in some device of main circuit (W-phase). 	<ul style="list-style-type: none"> Make a service call.
<i>EPH1</i>	Phase failure (input side)	<ul style="list-style-type: none"> Phase lacking in input side of main circuit. 	<ul style="list-style-type: none"> Check connection of main input circuit for phase lacking in input side.
(*1) <i>EPH0</i>	Phase failure (output side)	<ul style="list-style-type: none"> Phase lacking in output side of main circuit. 	<ul style="list-style-type: none"> Check connection of main output circuit and motor for phase lacking in output side. Select output phase failure detection parameter <i>F605</i> for checking.
<i>OP1</i>	Overvoltage during acceleration	<ul style="list-style-type: none"> Input voltage abnormally varied. <ol style="list-style-type: none"> Power-factor improving capacitor was turned on/off. Some unit using thyristor is connected with the same power supply line. Running motor is started during momentary power failure status. 	<ul style="list-style-type: none"> Try to insert input reactor. Use <i>F301</i> (Auto-restart) and <i>F302</i> (Regenerative power ride-through control).
<i>OP2</i>	Overvoltage during deceleration	<ul style="list-style-type: none"> Deceleration time #1 <i>dEC</i> is too short (too much regenerated energy). PBR resistance is too high. Dynamic braking mode <i>F304</i> is disabled. Over-voltage stall protection <i>F305</i> is disabled. Input voltage abnormally varied. <ol style="list-style-type: none"> Power capacity is 500 kVA or more. Power-factor improving capacitor was turned on/off. Some unit using thyristor is connected with the same power supply line. 	<ul style="list-style-type: none"> Extend deceleration time #1 <i>dEC</i>. Install dynamic braking resistor. Decrease dynamic braking resistance. (Also reset the <i>F308</i>.) Set dynamic braking mode parameter <i>F304</i> properly. Set over-voltage stall protection <i>F305</i> properly. Try to insert input reactor.

(*1): Presence or absence of parameter trip can be selected.

(Continued on the following page)

(Continued from the preceding page)

Indication	Contents	Expected causes	Countermeasures
<i>OP3</i>	Over-voltage during fixed speed	<ul style="list-style-type: none"> Input voltage abnormally varied. <ol style="list-style-type: none"> Power capacity is 500 kVA or more. Power-factor improving capacitor was turned on/off. Some unit using thyristor is connected with the same power supply line. Motor falls into regeneration status because it is rotated fast exceeding inverter's output frequency by power of loaded side. 	<ul style="list-style-type: none"> Try to insert input reactor. Install dynamic braking resistor.
<i>OL1</i>	Inverter overloaded	<ul style="list-style-type: none"> Rapid acceleration is operated. DC braking rate is too high. V/f parameter is improperly set. Running motor is started during momentary power failure status or so. Load is too heavy. 	<ul style="list-style-type: none"> Extend acceleration time #1 <i>ACC</i>. Decrease values of DC injection braking current <i>F251</i> and DC injection braking time <i>F252</i>. Check V/f parameter. Use <i>F301</i> (Auto-restart) and <i>F302</i> (Regenerative power ride-through control). Raise rating of the inverter.
<i>OL2</i>	Motor overloaded	<ul style="list-style-type: none"> V/f parameter is improperly set. Motor is locked. Continuous operation in low speed range. Motor is operated with overload. 	<ul style="list-style-type: none"> Check V/f parameter. Check loading unit. Reset <i>F505</i> properly to motor's overload reduction start-up frequency.
<i>OLr</i>	Dynamic braking resistor overload	<ul style="list-style-type: none"> Rapid deceleration is operated. Dynamic braking rate is too high. Set over-voltage limit operation level parameter <i>F525</i> too small. 	<ul style="list-style-type: none"> Extend deceleration time #1 <i>DEC</i>. Increase capacity (wattage) of dynamic braking resistor and reset the PBR capacity parameter <i>F309</i>. Increase the setting value of <i>F525</i>.
<i>OH</i>	Overheat	<ul style="list-style-type: none"> Cooling fan is not actuated. Ambient temperature is too high. Vent of cooling fan is shut. Some heat generating matter is located nearby. Internal thermistor of unit is disconnected. 	<ul style="list-style-type: none"> After cooling down inverter, reset it from failure and try to restart it. If cooling fan does not work in operation, it needs replacement. Secure spaces in the periphery of the inverter. Don't locate any heat generating thing near the inverter. Make a service call.
<i>E</i>	Emergency stop	<ul style="list-style-type: none"> Inverter is stopped by panel operation during automatic or remote operation. 	<ul style="list-style-type: none"> Reset the inverter.
<i>EEP1</i>	EEPROM error	<ul style="list-style-type: none"> Error occurs during writing data. 	<ul style="list-style-type: none"> Again turn on the inverter. If it is not reset, make a service call.
<i>EEP2</i>	Initial read-error	<ul style="list-style-type: none"> Something abnormal in internal data. 	<ul style="list-style-type: none"> Make a service call.
<i>EEP3</i>	Initial read-error	<ul style="list-style-type: none"> Something abnormal in internal data. 	<ul style="list-style-type: none"> Make a service call.
<i>Err2</i>	Main RAM fault	<ul style="list-style-type: none"> Something abnormal in control RAM. 	<ul style="list-style-type: none"> Make a service call.
<i>Err3</i>	Main ROM fault	<ul style="list-style-type: none"> Something abnormal in control ROM. 	<ul style="list-style-type: none"> Make a service call.
<i>Err4</i>	CPU fault	<ul style="list-style-type: none"> Something abnormal in control CPU. 	<ul style="list-style-type: none"> Make a service call.
<i>Err5</i>	Interruption communication fault	<ul style="list-style-type: none"> Something abnormal occurred during communication operation. 	<ul style="list-style-type: none"> Check communication units and their connections.
<i>Err6</i>	Gate array fault	<ul style="list-style-type: none"> Main gate array is abnormal. 	<ul style="list-style-type: none"> Make a service call.
<i>Err7</i>	Output current detector error	<ul style="list-style-type: none"> Main output current detector is abnormal. 	<ul style="list-style-type: none"> Make a service call.
<i>Err8</i>	Optional unit fault	<ul style="list-style-type: none"> Something abnormal occurred in some optional unit (including abnormal communication [optional add-on cassettes]). 	<ul style="list-style-type: none"> Check connection of optional board(s). Refer to instructions of options concerned.
<i>Err9</i>	Flush memory fault	<ul style="list-style-type: none"> Something abnormal in flush memory. 	<ul style="list-style-type: none"> Make a service call.
<i>(*1)UL</i>	low-current operation	<ul style="list-style-type: none"> Output current declined to the low-current detection level during operation. 	<ul style="list-style-type: none"> Check to see if low-current detection level is set properly to the system or not (<i>F511</i>). If low-current detection level is properly set, make a service call.

(Continued on the following page)

(Continued from the preceding page)

Indication	Contents	Expected causes	Countermeasures
(*1) UP1	Under-voltage (main circuit)	<ul style="list-style-type: none"> Input voltage (main circuit) becomes insufficient in operation. Momentary power failure occurs because undervoltage continues longer than under-voltage detection time F528. 	<ul style="list-style-type: none"> Check input voltage. If undervoltage is detected, set F302 (regenerative power ride-through control), F301 (auto-restart) and F528 (under-voltage detection time) as countermeasures against future momentary power failure.
(*1) UP2	Under-voltage (control circuit)	<ul style="list-style-type: none"> Input voltage (control circuit) becomes insufficient in operation. Momentary power failure occurs because undervoltage continues longer than under-voltage detection time F528. 	<ul style="list-style-type: none"> Check input voltage. If undervoltage is detected, set F302 (regenerative power ride-through control), F301 (auto-restart) and F528 (under-voltage detection time) as countermeasures against future momentary power failure.
(*1) OL	Over-torque	<ul style="list-style-type: none"> Load torque reaches over-torque detection level in operation. 	<ul style="list-style-type: none"> Check the system if there is something abnormal in it or not.
EF1 EF2	Ground-fault	<ul style="list-style-type: none"> Output cable or motor falls into ground-fault. 	<ul style="list-style-type: none"> Check units and connections if there is ground-fault or not.
EEn	Auto-tuning error	<ul style="list-style-type: none"> Check settings of F400 to F414 parameters for motor. Motor whose capacity is smaller by two or more ranks than that of inverter is used, isn't it? Extremely thick cable is used as inverter output cable, isn't it? Motor is running, isn't it? Motor other than three-phase inductive type is used, isn't it? If EEn error occurs as power is turned on, set motor type parameter as F413 = 4 (others). 	
EtYP	Inverter type error	<ul style="list-style-type: none"> Is control board (or drive board of main circuit) replaced? 	<ul style="list-style-type: none"> When board has been replaced, input 6 for tYP.
E-10	Sink/source switching error	<ul style="list-style-type: none"> Sink/source switch of input/output terminal is set wrong (reversely switched on/off). 	<ul style="list-style-type: none"> Check connections and set proper logic. After making sure that sequence is normal, proceed in operation. If the same error does not occur when the power is turned on again, the system has recovered normal status. (Check control terminals and sink/source switches including those of add-on options.)
E-11	Sequence error	<ul style="list-style-type: none"> The signal from a system is not inputted into input terminals. The input terminal function (130 or 131) is not set up. For not using the system-supporting sequence F530 function, it is set up except 0.0 at F530. 	<ul style="list-style-type: none"> Please check if the sequence is normal or not. Please set 130 or 131 as the input terminal to use. Please set up 0.0, when you do not use system-supporting sequence.
E-12	Encoder error	<ul style="list-style-type: none"> Disconnection of encoder circuit. 	<ul style="list-style-type: none"> Check connection of encoder. Connect encoder correctly.
E-13	Speed error (Over speed)	<ul style="list-style-type: none"> Something abnormal in encoder (inverter) 	<ul style="list-style-type: none"> Check connection of encoder. Connect encoder correctly.
E-14	To much potential deviation	<ul style="list-style-type: none"> Potential deviation exceeded the F531 set value during position control. 	<ul style="list-style-type: none"> Check connection of encoder. Increase the setting value of F531. Adjust the parameters on position control
E-17	Key error	<ul style="list-style-type: none"> RUN or STOP key is depressed for 5 seconds or more. Key is faulty. 	<ul style="list-style-type: none"> Check operation panel.
E-18	VI/II input error	<ul style="list-style-type: none"> Breaking down of a wire for VI/II input signal. 	<ul style="list-style-type: none"> Check VI/II input signal

Presence or absence of parameter trip can be selected.

(Note) Please contact us if you find any trips other than the above.

TOSHIBA

[Message] The following are messages only. No trip is developed.

Indication	Contents	Expected causes	Countermeasures
<i>OFF</i>	ST-CC opened	• ST terminal is in open-circuit.	• Close ST-CC circuit.
<i>P OFF</i>	Control circuit undervoltage	• Undervoltage between RO and SO of control power supply (when option is used for 22 kW or lower type).	• Measure supply voltage of control power. If voltage is normal, it needs repair service.
<i>n OFF</i>	Main circuit undervoltage	• Undervoltage between R, S and T of main circuit power supply. • Trouble of pre-charge circuit or DC circuit fuse.	• Measure supply voltage of main circuit power. If voltage is normal, it needs repair service. • Make a service call.
<i>r t r y</i>	Retry indication	• In retry operation. • Momentary power failure is occurred.	• If inverter automatically restarts dozens of seconds later, it is normal. Be careful of inverter in retry status, because there is a fear that it may suddenly restart.
<i>P - E r</i>	Frequency point setting error alarm	• Points 1 and 2 of frequency setting signal are set too close to each other.	• Set points 1 and 2 of frequency setting signal apart from each other.
<i>CL r</i>	Clear enabling indication	• If STOP key is pressed after trip indication, this indication appears.	• Press STOP key once more for resetting.
<i>E OFF</i>	Emergency stop enabling indication	• Stop operation is performed by panel during automatic or remote operation.	• If STOP key is pressed, emergency stop is executed. To cancel emergency stop, press any other key.
<i>H I L D</i>	Alarm for setup value error (Error indication and data are alternately displayed twice each.)	• Setup value error is detected in reading out or writing data.	• Check setup value for input error.
<i>db</i> <i>db ON</i>	DC braking indication	• Under DC braking	• If message disappears dozens of seconds later, it is normal. (Note)
		• Under motor shaft fixing control	• If message disappears by stop command (ST-CC open), it is normal.
<i>E 1</i> <i>E 2</i>	Panel indication overflow	• Number to be shown on panel such as frequency and so on overflows figures of display. (Number of overflowing digits is indicated.)	• For indication of frequency, set multiplying rate (<i>F 7 0 2</i>) lower. (Parameter setting that results in overflow is of course valid.)
<i>t</i>	Communication error	• Various transmission errors occur when computer is linked up with inverter system. • Various transmission errors occur in inverter to inverter communication (slave side). Time-out or trip in master side.	• For countermeasures against various transmission errors, refer to the "Manual for communication". • Check the master inverter.
<i>in it</i>	Parameter is under initialization.	• Parameters are initialized to be standard default values.	• If message disappears dozens of seconds later, it is normal.
<i>A t n</i>	In auto-tuning	• Under auto-tuning.	• If message disappears several seconds later, it is normal.

Note: In the case DC injection braking ON/OFF function is selected for an input terminal; if "*db*" disappears as a result of open-circuit between the terminal and CC, it is normal.

[Pre-alarm display]

Indication	Contents	Expected causes and countermeasures
<i>CL</i>	Overcurrent alarm	Same as <i>OFF</i> (over-current)
<i>P</i>	Overvoltage alarm Achieving PBR operation level	Same as <i>OP</i> (over-voltage) P blink while PBR is operating is not an error.
<i>L.</i>	Overload alarm	Same as <i>OL 1 / OL 2</i> (overload)
<i>H.</i>	Overheat alarm	Same as <i>OH</i> (overheat)

When two or more alarms occur at the same time, such the message as shown in the following blinks.

CP, PL, LH, CPL,, CPLH

Blinking indications appear in order of *C, P, L, H* from the leftmost place to right.

12. 2 Method of resetting causes of trip

If the inverter trips because of trouble or malfunction, remove the cause of trip before resetting it. If the inverter is reset as the cause of trip remaining with it, it again trips in spite of resetting.

For recovering inverter from trip status,

- (1) Cut off power supply (until nothing appears on the LED display).
Note: Refer to the section 6.25.3, Inverter trip holding parameter $F602$.
- (2) Use external signal (make short-circuit between RES and CC of the control terminal board).
- (3) Operate on the panel.
- (4) Clear the trip by communication (refer to "manual for communication" for details).

reset it in one of the following ways.

Resetting procedure by panel operation is as follows.

1. Press the STOP key and make sure that $\text{C} \text{L} \text{r}$ message appears on the display.
2. Press the STOP key once more. If the cause of the trip is removed, the inverter is reset by the second pressing of the STOP key.

If the inverter trips as a result of overload protection ($\text{OL} 1$: inverter overload, $\text{OL} 2$: motor overload, $\text{OL} r$: Dynamic braking resistor overload) function, it cannot be reset for a period of virtual cooling time.

Standard virtual cooling time;

In case of $\text{OL} 1$: for about 30 seconds after trip

In case of $\text{OL} 2$: for about 120 seconds after trip

In case of $\text{OL} r$: for about 20 seconds after trip

If the inverter trips because of overheat (OH), reset it after a considerably long time enough for cooling it down completely, because overheat is detected based on its internal temperature.

~ Point! ~

For quickly recovering inverter from trip status, turn it off once and reset it. However, this measure is taken frequently, it may cause damage to the motor and other component units.

12. 3 In the case motor does not run in spite of no trip message appearing ...

When the motor does not run in spite of no trip message appearing on the display, proceed to troubleshooting according to the following flowchart.

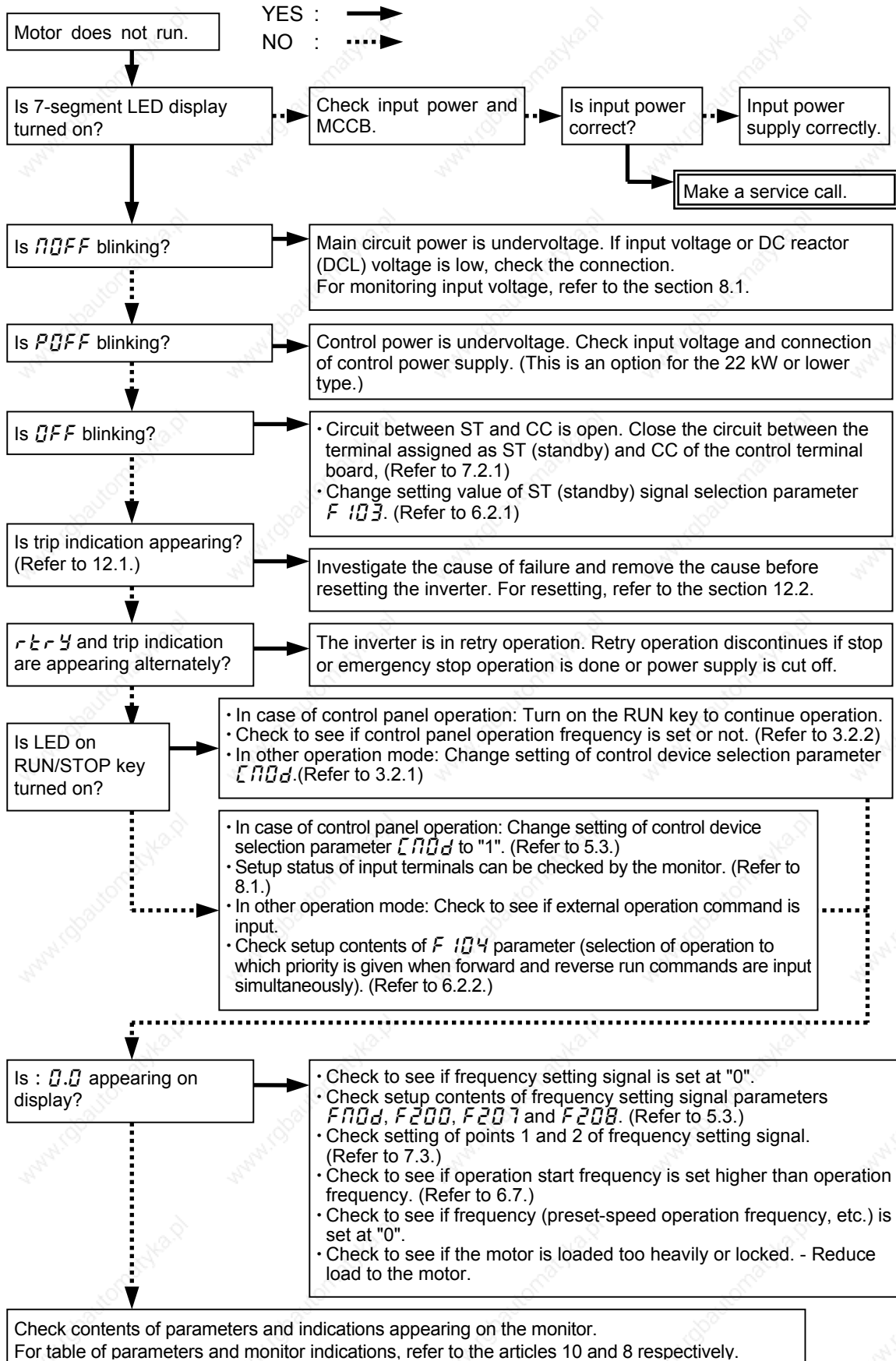

12. 4 How to check other troubles



Expected causes of other troubles (abnormal operations and conditions) and measures to settle those troubles are shown below.

Abnormal operation/condition	Causes and measures
Motor runs reversely.	<ul style="list-style-type: none"> • Change phase sequence of output terminals U, V and W. • Change forward and reverse signal inputs of external operation signals for each other. (Refer to 7.2, Control terminal function allotment.)
Motor runs but speed cannot be varied.	<ul style="list-style-type: none"> • Load to motor is too heavy. Reduce the load. • Soft stall function is activated. Switch off soft stall function. (Refer to 5.13.) • Setting values of maximum frequency FH and upper limit frequency UL are low. Raise maximum frequency FH and upper limit frequency UL to higher level. • Frequency setting signal is low (weak). Check input level of signal, circuit and connection, etc. • Check setup specifications of frequency setting signal (setting of point 1, point 2). (Refer to 7.3.) • Check to see if stall prevention function is activated at low-speed operation because of too high torque boost rate. Adjust manual torque boost (μb) and acceleration time #1 (ACC). (Refer to 5.12 and 5.1.)
Acceleration/deceleration of motor is rough.	<ul style="list-style-type: none"> • Acceleration time #1 (ACC) and deceleration time #1 (DEC) are set short. Increase setting values of acceleration time #1 (ACC) and deceleration time #1 (DEC).
Large motor current	<ul style="list-style-type: none"> • Load to motor is too heavy. Reduce load to motor. • Check to see if torque boost rate is too high at low-speed operation. (Refer to 5.12.)
Motor speed is high or low.	<ul style="list-style-type: none"> • Improper voltage setting for the motor. Set voltage properly to the motor. • Terminal voltage of the motor is low. Check setting value of base frequency voltage #1 ($F305$). (Refer to 6.13.6.) Change the cable for thicker one. • Improper gear ratio for acceleration and deceleration. Change gear ratio properly for smooth acceleration and deceleration. • Output frequency is set improperly. Check setup of output frequency range. • Tune basic frequency. (Refer to 5.9.)
Motor speed varies in operation.	<ul style="list-style-type: none"> • Load to the motor is too heavy or light. Reduce load fluctuation. • Rating of inverter or motor is improper to load. Change the motor or inverter for another of higher rating. • Check to see if frequency setting signal input fluctuates. • If V/f control parameter is set at 3 or larger, check setting value and setup conditions of vector control. (Refer to 5.10.)
Some or all of six keys on operation panel don't work.	<ul style="list-style-type: none"> • Change panel operation prohibition parameter $F730$. (Refer to 6.30.14.)
Access to parameter results in failure.	<ul style="list-style-type: none"> *Parameter is occasionally set for key operation prohibition mode. Cancel key operation prohibition mode according to the following procedure. Press the [] key twice while pressing the [ENT] key.
Parameter cannot be changed.	<ol style="list-style-type: none"> 1: If parameter setting prohibition parameter $F700$ is set at " / " (prohibited), change the setting to " 0 " (allowed).
Monitor (display) is uncontrollable.	<ol style="list-style-type: none"> 2: If there is an input terminal that is set for " / / 0 " (or " / / / ") (parameter editing enabling) by input terminal function parameter, turn on the terminal.

Measures against trouble with parameter setting

How to check the parameters that have been changed.	<ul style="list-style-type: none"> • Changed parameters can be searched and reset. For details, refer to 4.1.3.
How to reset changed parameters to default values	<ul style="list-style-type: none"> • Parameters whose values have been changed can be reset to their respective default values in bulk. For details, refer to 4.1.5.

13. Regular inspection and maintenance

 Danger	
 Mandatory	<ul style="list-style-type: none"> • Be sure to inspect the inverter regularly. If the inverter is used without regular inspection, it may cause trouble or accident because sign of disorder or failure is missed. • Complete the following steps before proceeding to inspection. <ol style="list-style-type: none"> 1 Cut off power supply (turn off the inverter). 2 10 minutes or more after power cutoff, check to see if the charge indicator lamp is turned off. 3 Make sure that voltage in the DC main circuit (between PA and PC) is 45 V or lower by use of a tester capable of measuring high DC tension (800 V DC or more). <p>If the above-mentioned steps are skipped before inspection, it may cause an electricshock.</p>

To prevent the inverter from failure caused by operating environment such as influence of temperature, humidity, dust and so on, vibration, and aging of component parts, and end of estimated service life, execute daily or regular inspection without fail.

13.1 Regular inspection

Since electronic parts are easily affected by heat, install the inverter in a cool, well-ventilated, dust-free place for making it demonstrate its original performance for a long time. Purpose of regular inspection is to find sign of failure or malfunction by comparing current data on operation with recorded data on past operation.

Subject of inspection	Gist of inspection			Criteria of judgment
	Inspection item	Inspection cycle	Inspection method	
1. Indoor environment	1) Dust, humidity, gas 2) Dropping of water and other liquid 3) Room temperature	As occasion demands	1) Eye-check, thermometer, sense of smell 2) Eye-check 3) Thermometer	1) Improve bad points. 2) Pay heed to trace left of water drop. 3) Maximum 40°C (50°C inside cabinet)
2. Component parts and units	1) Vibration, noise		By feel (touch) of outside of the board	If something feels abnormal, open the door and check transformer, reactor, contactor, relay, cooling fan, etc. Stop the inverter as occasion demands.
3. Operation data (output side)	1) Load current 2) Voltage* 3) Temperature		Moving-iron type AC ammeter Rectifier type AC voltmeter Thermometer	Within the rating Little difference from data on normal status



*)Voltage is differently read depending on the measuring instrument used. Use the same tester or voltmeter for every inspection and record measurement result each time.

Check points

1. Something unusual in the installation environment
2. Something unusual in the cooling system
3. Unusual vibration and noise
4. Overheat, discoloration
5. Unusual smell
6. Unusual motor vibration, noise and overheat

13. 2 Periodical inspection

Make periodical inspection at intervals of three or six months depending on operating conditions.

 Danger	
 Mandatory	<ul style="list-style-type: none"> • Complete the following steps before proceeding to periodical inspection. <ol style="list-style-type: none"> 1 Cut off power supply (turn off the inverter). 2 10 minutes or more after power cut off, check to see if the charge indicator lamp is turned off. 3 Make sure that voltage in the DC main circuit (between PA and PC) is 45 V or lower by use of a tester capable of measuring high DC tension (800 V DC or more). <p>If the above-mentioned steps are skipped before inspection, it may cause an electric shock.</p>
 Prohibited	<ul style="list-style-type: none"> • Don't replace any component part. <p>Replacement of a component part by user may cause electric shock, fire or injury. Ask the dealer for replacement of part.</p>

Points of inspection

1. Check to see if there is some wire terminal screw getting loose. If any, tighten it with a screwdriver.
2. Make sure by eye-check that there is neither poorly clinched part nor overheated clinch in wire terminals.
3. Check to see by eyes if there is any damage on wire or cable.
4. Clean up dust and soil. Absorb dust by a vacuum cleaner. Carefully clean the vents, printed circuit boards and so on. If those parts get dusty, it may cause an unexpected accident. Keep them clean always.
5. If the inverter won't be used for a long time, turn it on once every another year to check operation. Furthermore, disconnect the motor and supply power to the inverter for five hours or more. For turning on the inverter very seldom, it is recommended not to supply commercial mains power directly to the inverter but to use a step-up transformer to supply power at a low voltage first and to raise the voltage gradually.
6. If insulation test is needed, conduct it for the main circuit terminal board and control power terminal board using a 500 V insulation resistance tester only. Don't conduct insulation test for control terminals and circuit terminals on printed circuit boards except of the main circuit. For insulation test of motor, disconnect output terminals of U, V and W and conduct test for the motor only.

Note: Disconnect all cables from terminals of the main circuit terminal board, and conduct insulation test with the inverter only.

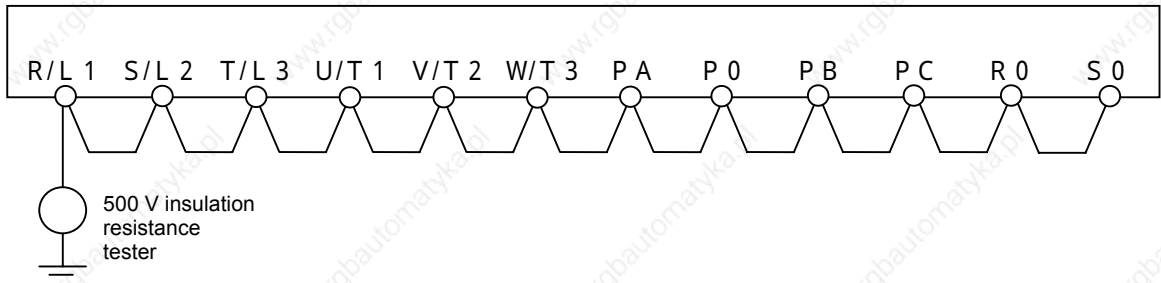

7. Make no pressure test, because it may cause damage to internal parts.
8. Voltage and temperature check

Recommended voltmeter:

For input side: Moving-iron type voltmeter ()

For output side: Rectifier type voltmeter ()

If ambient temperature is measured at start time, during operation, and at stop time usually, recorded data will be helpful to find sign of failure or malfunction.

Replacement of expendable parts

The inverter incorporates a great deal of electronic parts such as semiconductors, etc. The following parts deteriorate because of their constructions, physical characteristics and aging. If those parts are used as they have aged, it may cause the inverter to deteriorate in performance and to become faulty. Such being the case, the inverter needs periodical inspection for preventing itself from failure and deterioration.

Note: Service life of part is affected by ambient temperature and operating conditions. Service life of main parts shown below is just standard when the inverter is used in the usual environmental conditions.

1) Cooling fan

Service life of the cooling fan to cool down heat generation parts is 30000 hours (2 to 3 years under continuous operation) approximately. If it generates unusual noise or vibration, it is a sign of replacement.

2) Aluminum electrolytic capacitor

The aluminum electrolytic capacitor of the DC main circuit deteriorates in characteristic because of influence of ripple current, etc. If the inverter is used in the usual operating condition, the capacitor needs to be replaced every five years. For the inverter that applicable motor output is 3.7 kW or less, replace the capacitor together with the printed circuit board.

<Criteria of external inspection>

- No liquid leak
- Proper setting of safety valve
- Measurement of electrostatic capacity and insulation resistance

Aim of replacement time of each component part can be fixed by checking operation hours of the inverter. For the replacement of parts, contact Toshiba branch office printed on the back cover of this manual. (Operation hours can be known by alarm output, if it is set.)

Standard period of years to replace main component parts

If the inverter is used under the standard operating conditions (ambient temperature: 30 °C on average, load factor: 80 % or less, 12-hours operation a day), standard period of years to replace main component parts is as shown below. The following period does not indicate the estimated end of service life of the part but indicates the period that failure rate of the part becomes sharply high thenceforth.

Part name	Standard period for replacement	Replacement method, others
Cooling fan	2 to 3 years	Replace with new one.
Main circuit capacitor	5 years	Replace with new one (depending on inspection result).
Contactors, Relay, etc.	-	Depending on inspection result
Timer	-	Depending on operation hours
Fuse	10 years	Replace with new one.
Aluminum electrolytic capacitor on printed circuit board	5 years	Change together with printed circuit board for new board (depending on inspection result).

Note: Service life of part differs depending on operating environment.

13. 3 When making a service call

For the Toshiba service network, refer to the back cover of this instruction manual. If defective conditions are encountered, please contact the Toshiba service section in charge via your Toshiba dealer.

When making a call for servicing, let us know the contents of the rating plate on the right side of the inverter and connection of options besides details of the trouble.

13. 4 When retaining the inverter out of operation

When retaining the inverter out of operation temporarily or for a long time, pay heed to the following points.

1. Keep the inverter in a well-ventilated place that is free from high temperature, high humidity, dust and metallic particles.
2. For the inverter whose printed circuit boards are covered with the charge-proof cover (black), don't remove the cover throughout retention. However, be sure to remove the cover before the inverter is turned on.
3. If the large-capacity electrolytic condenser mounted in the inverter is left without power supply for a long time, it deteriorates in the characteristic.
If the inverter won't be used for a long time, turn it on for 5 hours or more once every another years in order to recover the characteristic of the electrolytic condenser. At the same time, check operation status of the inverter. For turning on the inverter very seldom, it is recommended to use a step-up transformer to supply power at a low voltage first and to raise the voltage gradually.

14. Warranty

The inverter is warranted by Toshiba for repair and adjustment free of charge based on the following conditions.

1. Warranty is limited to the inverter's main body only.
2. If the inverter becomes out of order or damaged under the usual operating condition within 12 months after delivery, it will be repaired free of charge by Toshiba.
3. Even in the term of the warranty, repair/adjustment service will be charged for the following cases.
 - Fault or damage resulting from misuse, unauthorized modification or repair.
 - Fault or damage resulting from falling down of the product or traffic accident during transportation.
 - Fault or damage originating from fire, salt water/salty breezes, some kind of gas, earthquake, storm and flood, lightning, abnormal supply voltage, other natural disasters.
 - Fault or damage caused by improper use of the inverter as it is used for a purpose out of its original application.
4. If field inspection of the inverter is carried out at the spot of installation, all travelling expenses incurred will be charged. If there is another special warranty contracted for the inverter, the special warranty has priority over this warranty.

15. When disposing the inverter



Warning



Mandatory

- When disposing an inverter, do it as an industrial waste following regulations and local rules concerned.
If it is disposed otherwise, it may cause injury to persons.

When disposing a used inverter, pay heed to the following points.

Blasting during incineration: There is a danger that electrolytic condensers used in the inverter may burst if it is burnt in an incinerator, because electrolyte inside the condenser expands with heat. Be careful of blasting of electrolytic condensers.

Plastics: Plastics used as covers of the inverter and so on generate poisonous gas when the inverter is burnt. When burning the inverter, be careful of such poisonous gas.

Disposing manner: Be sure to dispose the inverter properly as an industrial waste.