

Absolute Maximum Ratings			
Symbol	Conditions ¹⁾	Values	Units
Inverter			
V _{CES}		1200	V
V _{GES}		± 20	V
I _C	T _{heatsink} = 25 / 80 °C	65 / 45	A
I _{CM}	t _p < 1 ms; T _{heatsink} = 25 / 80 °C	130 / 90	A
I _F = -I _C	T _{heatsink} = 25 / 80 °C	60 / 40	A
I _{FM} = -I _{CM}	t _p < 1 ms; T _{heatsink} = 25 / 80 °C	120 / 80	A
Bridge Rectifier			
V _{RRM}		1500	V
I _D	T _{heatsink} = 80 °C	35	A
I _{FSM}	t _p = 10 ms; sin. 180 °, T _J = 25 °C	700	A
I ² t	t _p = 10 ms; sin. 180 °, T _J = 25 °C	2400	A ² s
T _J		- 40 ... + 150	°C
T _{stg}		- 40 ... + 125	°C
V _{isol}	AC, 1 min.	2500	V

MiniSKiiP 3 SEMIKRON integrated intelligent Power SKiiP 32 NAB 12 T1 3-phase bridge rectifier + braking chopper 3-phase bridge inverter

Case M3

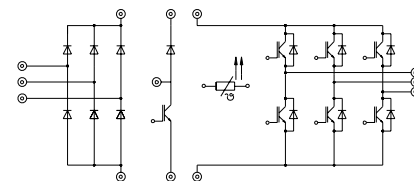

UL recognized file no. E63532

Options

- also available with powerful chopper. For characteristics please refer to Inverter IGBT

¹⁾ T_{heatsink} = 25 °C, unless otherwise specified

²⁾ CAL = Controlled Axial Lifetime Technology (soft and fast recovery)

* For diagrams of the Chopper IGBT please refer to SKiiP 30 NAB 12 T10

Characteristics					
Symbol	Conditions ¹⁾	min.	typ.	max.	Units
IGBT - Inverter					
V _{CEsat}	I _C = 50 A T _J = 25 (125) °C	-	2,5(3,1)	3,0(3,7)	V
t _{d(on)}	V _{CC} = 600 V; V _{GE} = ± 15 V	-	44	100	ns
t _r	I _C = 50 A; T _J = 125 °C	-	56	100	ns
t _{d(off)}	R _{gon} = R _{goff} = 22 Ω	-	380	500	ns
t _f	inductive load	-	70	100	ns
E _{on} + E _{off}		-	13	-	mJ
C _{ies}	V _{CE} = 25 V; V _{GE} = 0 V, 1 MHz	-	3,3	-	nF
R _{thjh}	per IGBT	-	-	0,5	K/W
IGBT - Chopper *					
V _{CEsat}	I _C = 25 A T _J = 25 (125) °C	-	2,5(3,1)	3,0(3,7)	V
t _{d(on)}	V _{CC} = 600 V; V _{GE} = ± 15 V	-	75	150	ns
t _r	I _C = 25 A; T _J = 125 °C	-	65	130	ns
t _{d(off)}	R _{gon} = R _{goff} = 47 Ω	-	400	600	ns
t _f	inductive load	-	50	100	ns
E _{on} + E _{off}		-	6,2	-	mJ
C _{ies}	V _{CE} = 25 V; V _{GE} = 0 V, 1 MHz	-	1,65	-	nF
R _{thjh}	per IGBT	-	-	1,0	K/W
Diode ²⁾ - Inverter & Chopper					
V _F = V _{EC}	I _F = 50 A T _J = 25 (125) °C	-	2,0(1,8)	2,5(2,3)	V
V _{TO}	T _J = 125 °C	-	1,0	1,2	V
r _T	T _J = 125 °C	-	16	22	mΩ
I _{RRM}	I _F = 50 A, V _R = - 600 V	-	40	-	A
Q _{rr}	di _F /dt = - 800 A/μs	-	8,0	-	μC
E _{off}	V _{GE} = 0 V, T _J = 125 °C	-	2,0	-	mJ
R _{thjh}	per diode	-	-	1,0	K/W
Diode - Rectifier					
V _F	I _F = 35 A T _J = 25 °C	-	1,2	-	V
R _{thjh}	per diode	-	-	1,6	K/W
Temperature Sensor					
R _{TS}	T = 25 / 100 °C		1000 / 1670		Ω
Mechanical Data					
M ₁	Mounting torque	2	-	2,5	Nm
Case			M3		

This technical information specifies semiconductor devices but promises no characteristics. No warranty or guarantee expressed or implied is made regarding delivery, performance or suitability. www.DataSheet4U.com

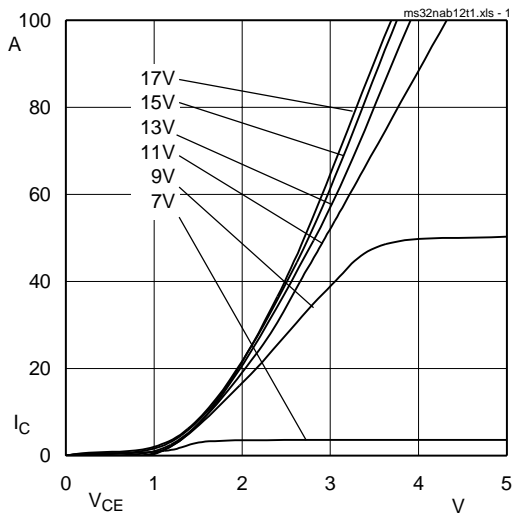

Fig. 1 Typ. output characteristic, $t_p = 80 \mu s$; $25 \text{ }^\circ\text{C}$

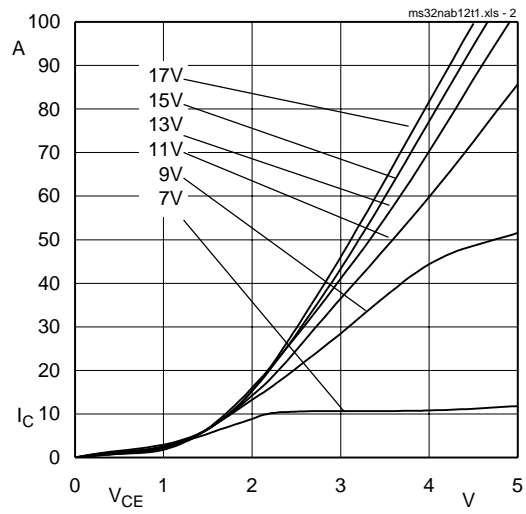

Fig. 2 Typ. output characteristic, $t_p = 80 \mu s$; $125 \text{ }^\circ\text{C}$

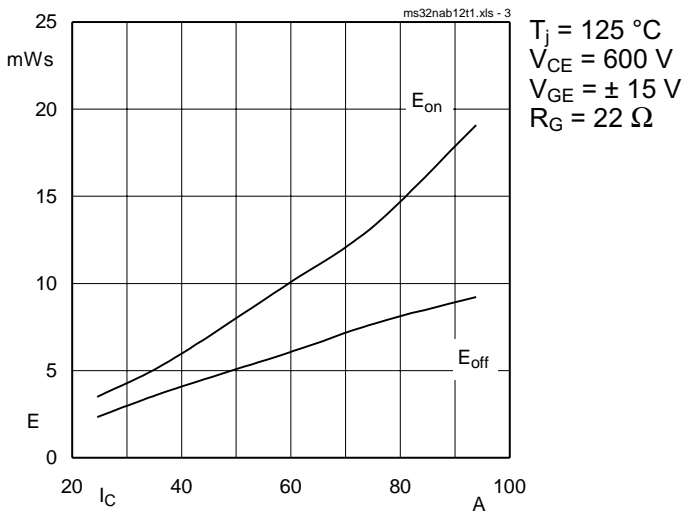

Fig. 3 Turn-on /-off energy = $f(I_C)$

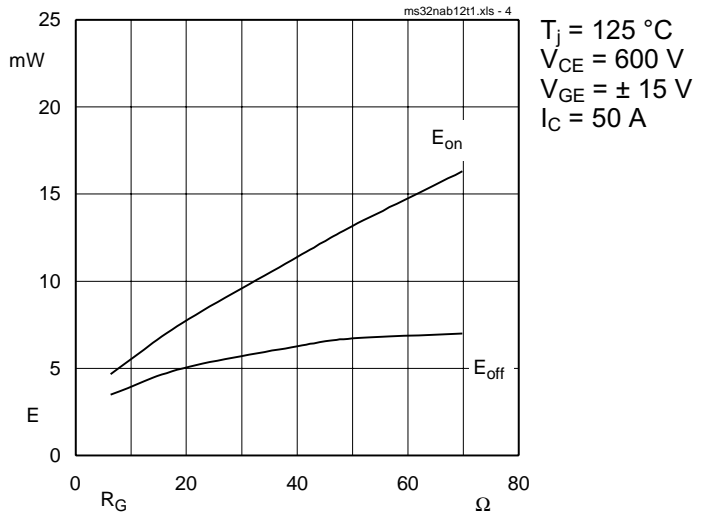

Fig. 4 Turn-on /-off energy = $f(R_G)$

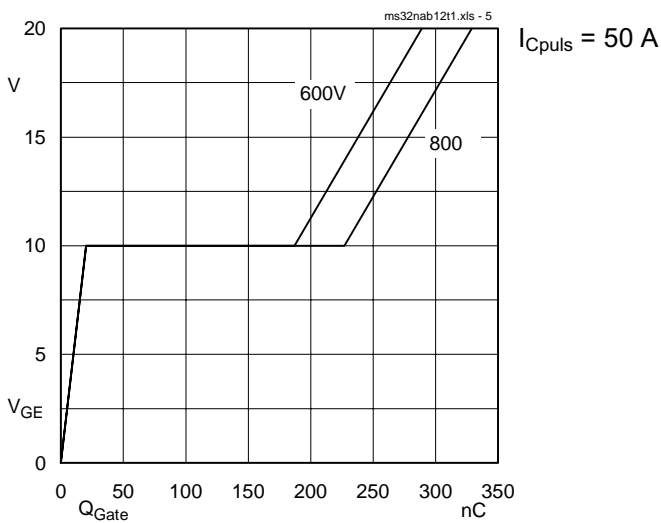

Fig. 5 Typ. gate charge characteristic

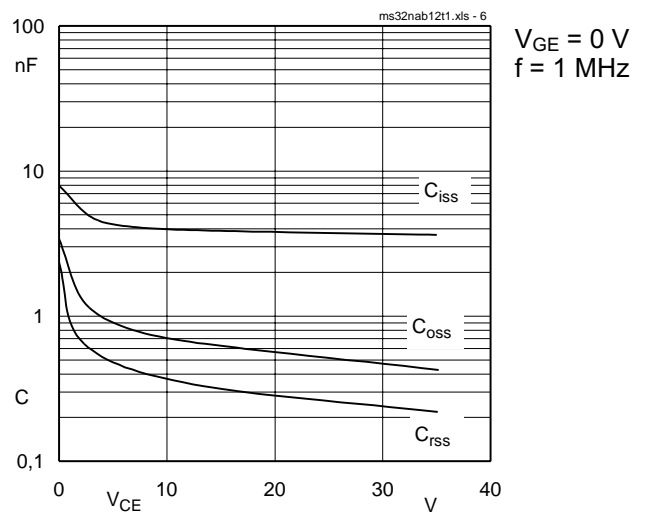

Fig. 6 Typ. capacitances vs. V_{CE}

MiniSKiiP 1200 V

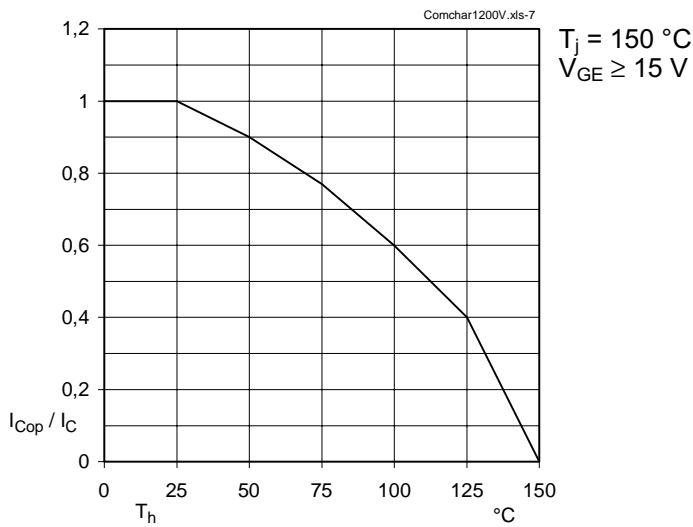

Fig. 7 Rated current of the IGBT $I_{COp} / I_C = f(T_h)$

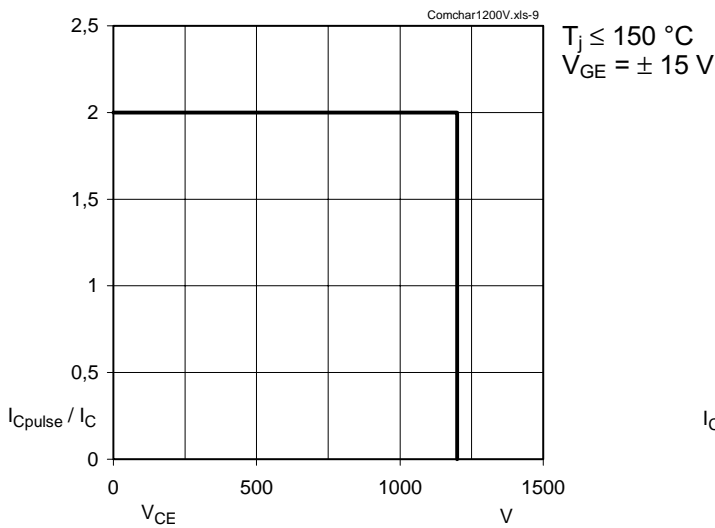

Fig. 9 Turn-off safe operating area (RBSOA) of the IGBT

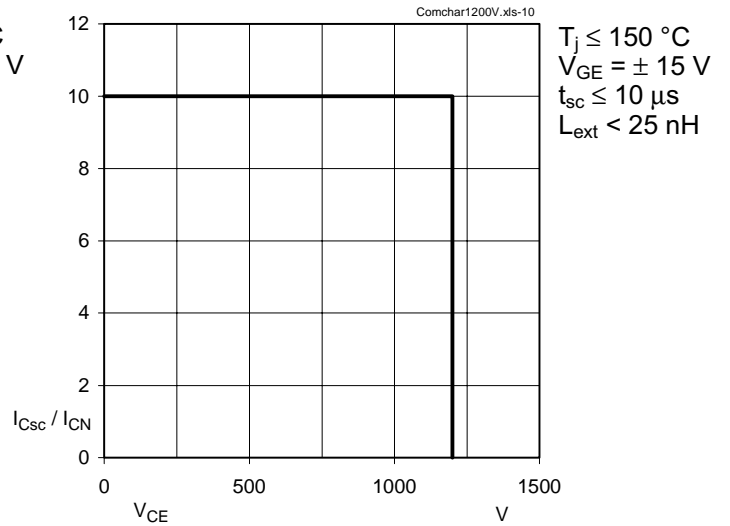

Fig. 10 Safe operating area at short circuit of the IGBT

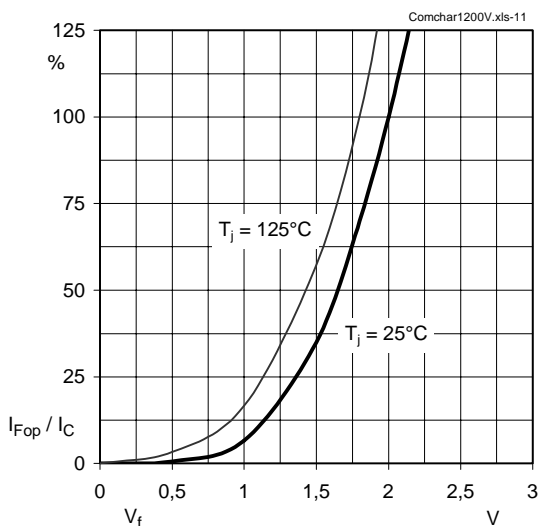

Fig. 11 Typ. freewheeling diode forward characteristic

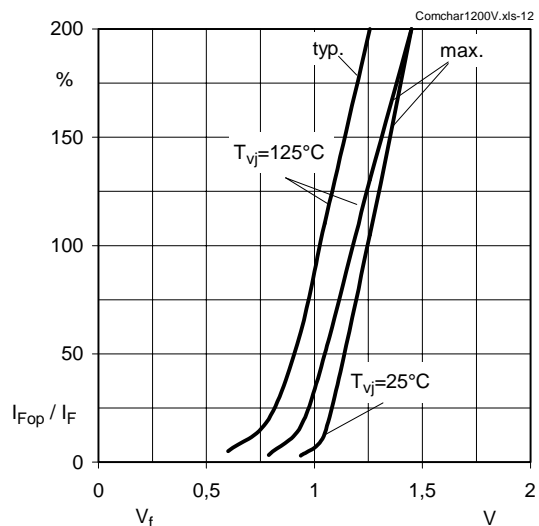
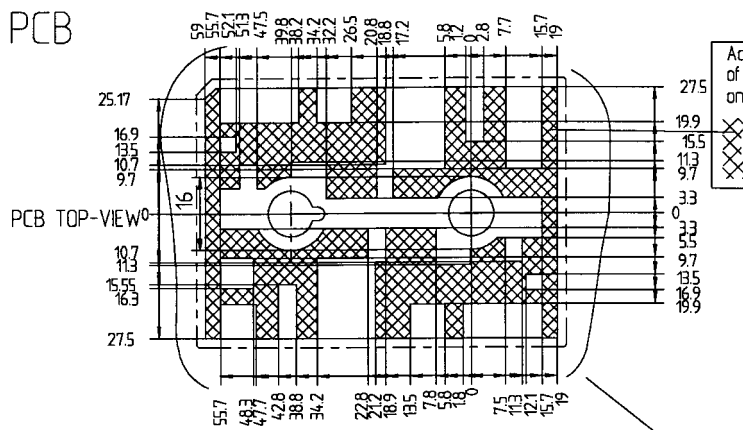
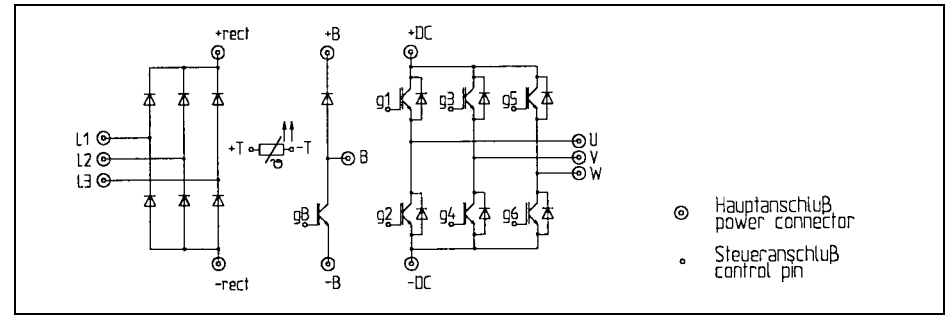

Fig. 12 Forward characteristic of the input bridge diode

MiniSKiiP 3

- SKiiP 30 NAB 12 T10
- SKiiP 31 NAB 12 T11
- SKiiP 32 NAB 12 T1



Mini-SKiiP 3

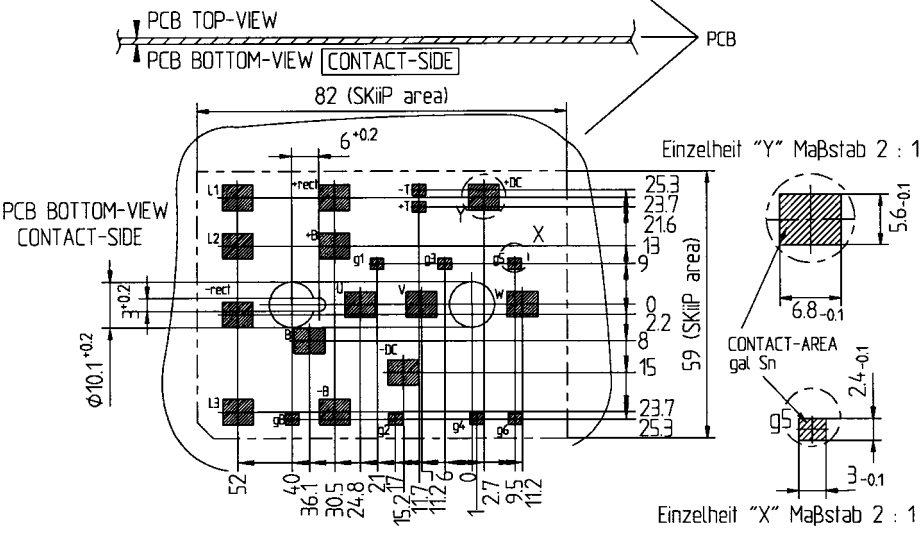
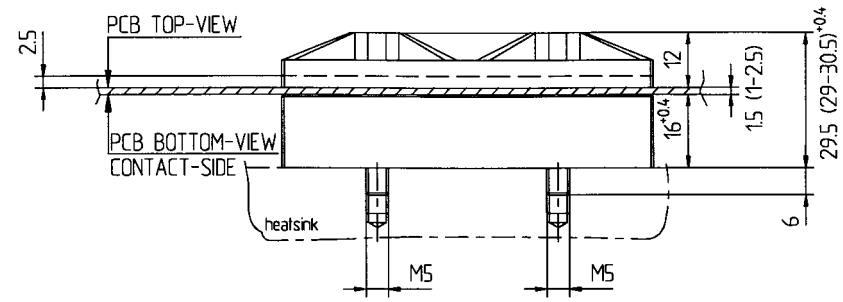

Bitte beachten Sie die Montagevorschrift
For mounting please follow the assembly instruction

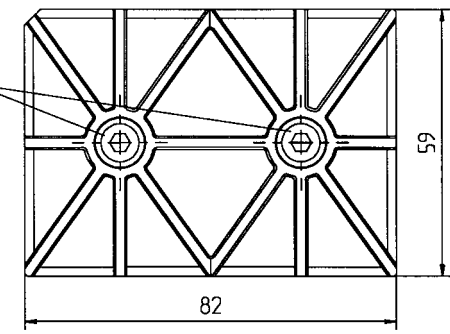

Tolerance: ISO 2768-f