

High h_{FE}
 LOW $V_{CE(sat)}$

2SC3852/3852A

Silicon NPN Epitaxial Planar Transistor

Application : Driver for Solenoid and Motor, Series Regulator and General Purpose

Absolute maximum ratings ($T_a=25^\circ\text{C}$)

Symbol	Ratings		Unit
	2SC3852	2SC3852A	
V_{CBO}	80	100	V
V_{CEO}	60	80	V
V_{EBO}	6		V
I_C	3		A
I_B	1		A
P_C	25 ($T_C=25^\circ\text{C}$)		W
T_j	150		$^\circ\text{C}$
T_{stg}	-55 to +150		$^\circ\text{C}$

Electrical Characteristics ($T_a=25^\circ\text{C}$)

Symbol	Conditions	Ratings		Unit
		2SC3852	2SC3852A	
I_{CBO}	$V_{CB} =$	80	100	μA
I_{EBO}	$V_{EB} = 6\text{V}$	100max		μA
$V_{(BR)CEO}$	$I_C = 25\text{mA}$	60min	80min	V
h_{FE}	$V_{CE} = 4\text{V}, I_C = 0.5\text{A}$	500min		
$V_{CE(sat)}$	$I_C = 2\text{A}, I_B = 50\text{mA}$	0.5max		V
f_T	$V_{CE} = 12\text{V}, I_E = -0.2\text{A}$	15typ		MHz
C_{OB}	$V_{CB} = 10\text{V}, f = 1\text{MHz}$	50typ		pF

External Dimensions FM20(TO220F)

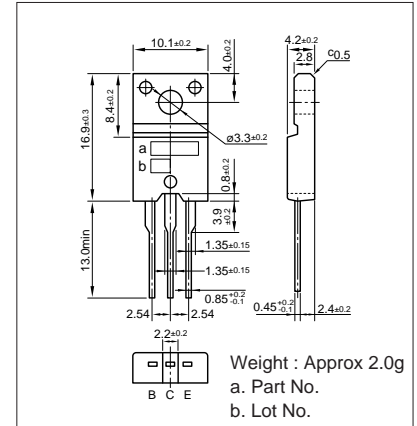

Typical Switching Characteristics (Common Emitter)

V_{CC} (V)	R_L (Ω)	I_C (A)	V_{BB1} (V)	V_{BB2} (V)	I_{B1} (mA)	I_{B2} (mA)	t_{on} (μs)	t_{stg} (μs)	t_f (μs)
20	20	1.0	10	-5	15	-30	0.8typ	3.0typ	1.2typ

$I_C - V_{CE}$ Characteristics (Typical)

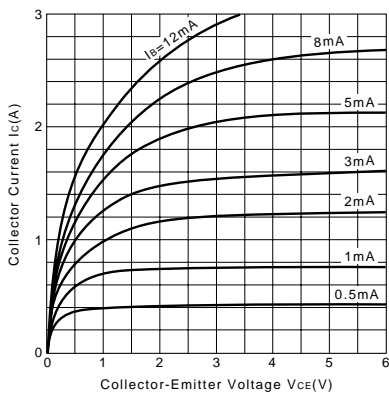

$V_{CE(sat)} - I_B$ Characteristics (Typical)

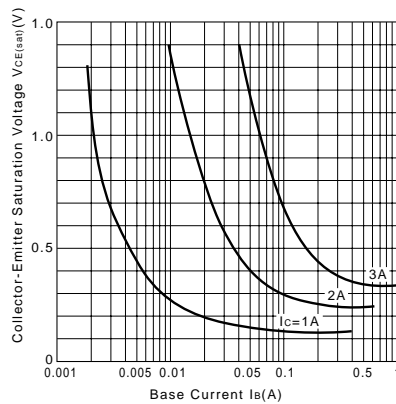

$I_C - V_{BE}$ Temperature Characteristics (Typical)

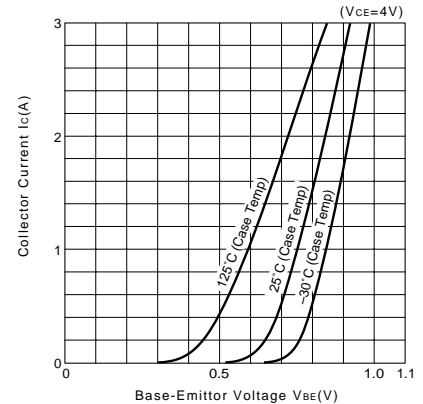

$h_{FE} - I_C$ Characteristics (Typical)

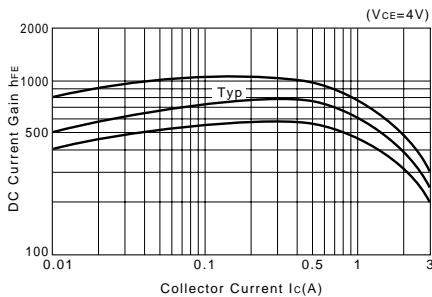

$h_{FE} - I_C$ Temperature Characteristics (Typical)

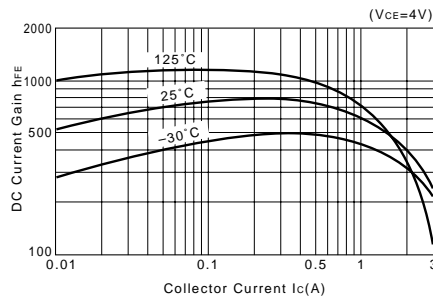

$\theta_{j-a} - t$ Characteristics

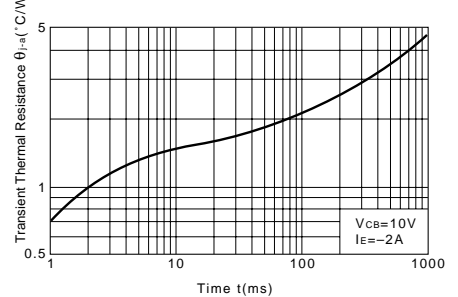

$f_T - I_E$ Characteristics (Typical)

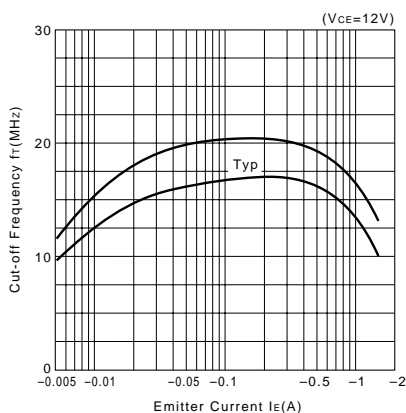

Safe Operating Area (Single Pulse)

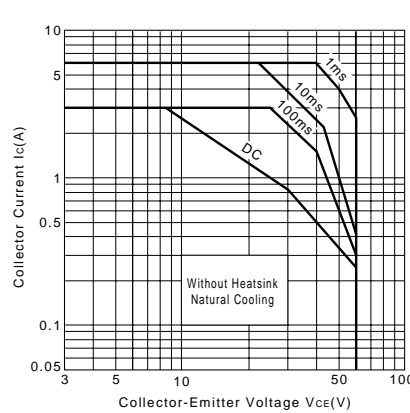

$P_C - T_a$ Derating

