

# COMBIVERT



0,37...0,75 kW

- D** BETRIEBSANLEITUNG
- GB** INSTRUCTION MANUAL
- F** MANUEL D'INSTRUCTIONS
- I** MANUALE D'ISTRUZIONE
- E** MANUAL DE INSTRUCCIONES

KEB COMBIVERT F4-S



Erst Betriebsanleitung Teil 1 lesen !  
Read instruction manual part 1 first !  
Lisez d'abord le manuel d'instructions partie 1 !  
Prima leggere le manuale di istruzione 1 parte !  
Leer manual de instrucciones parte 1 antes !

**KEB**  
ANTRIEBSTECHNIK

**D**

Seite 3 ..... 24

Diese Betriebsanleitung muß jedem Anwender zugänglich gemacht werden. Vor jeglichen Arbeiten muß sich der Anwender mit dem Gerät vertraut machen. Darunter fällt insbesondere die Kenntnis und Beachtung der Sicherheits- und Warnhinweise. Die in dieser Betriebsanleitung verwendeten Pictogramme entsprechen folgender Bedeutung:



**Gefahr  
Warnung  
Vorsicht**



**Achtung,  
Unbedingt  
beachten**



**Information  
Hilfe  
Tip**

**GB**

Page 25 ..... 46

This instruction manual must be made available to any user. Before working with this unit the user must be familiarized with it. This is especially true for the attention, safety and warning guides. The meaning of the pictograms used in this manual are:



**Danger  
Warning  
Caution**



**Attention,  
observe at  
all costs**



**Information  
Help  
Tip**

**F**

Page 47 ..... 68

Ce manuel d'instructions doit être rendu accessible à tout utilisateur. Avant tous travaux, l'utilisateur doit se familiariser d'abord avec le variateur, notamment tenir compte des mesures de sécurité et des avertissements. Les pictogrammes utilisés dans ce manuel ont les significations suivantes:



**Danger  
Avertissement  
Précaution**



**Attention,  
à respecter  
obligatoirement**



**Information  
Aide  
Astuces**

**I**

Página 69 ..... 90

Questo manuale di istruzioni deve essere messo a disposizione di tutti gli utenti. Prima di impregare questa apparecchiatura. L'utente deve prima familiarizzare con essa. In particolare modo prestare attenzione alle sottoindicate direttive di avvertimento e sicurezza personale nell'uso dell'apparecchiatura.



**Pericolo  
Avvertimento  
Cautela**



**Attenzione,  
osservare  
assolutamente**



**Informazione  
Aiuto  
Suggerimento**

**E**

Página 91 ..... 112

Este manual de instrucciones debe ser accesible a todos los usuarios. Antes de conectar el convertidor, el usuario debe familiarizarse con el convertidor, especialmente debe tener en cuenta las medidas de seguridad y advertencias. Los pictogramas utilizados en este manual tienen los significados siguientes:



**Peligro  
Advertencia  
Precaución**



**Atención  
de obligado  
cumplimiento**



**Información  
Ayuda  
Nota**

<b>1.</b>	<b>General .....</b>	<b>26</b>
1.1	Product Description .....	26
1.2	Identifikation of the unit .....	27
<b>2.</b>	<b>Power Circuit .....</b>	<b>27</b>
2.1	Performance Data .....	27
2.2	Dimensions .....	26
2.3	Installation Instructions .....	26
2.4	Terminals .....	29
2.5	Connection of the Power Circuit .....	29
<b>3.</b>	<b>Control circuit .....</b>	<b>30</b>
3.1	Assignment of Terminal Strip X1 .....	30
3.2	Connection of the control .....	30
3.2.1	<i>Digital inputs</i> .....	30
3.2.2	<i>Analog input</i> .....	30
3.2.3	<i>Outputs</i> .....	31
<b>4.</b>	<b>Operation of the unit .....</b>	<b>31</b>
4.1	Digital operator .....	31
4.1.1	Interface operator .....	31
4.1.2	<i>Keyboard</i> .....	32
4.2	Parameter Summary .....	33
4.3	Password Input .....	33
4.4	Operating Display .....	34
4.5	Basic Adjustment of the Drive .....	35
4.6	Special Adjustments .....	37
4.7	The Drive Mode .....	42
4.7.1	<i>Start / Stop Drive</i> .....	42
4.7.2	<i>Change Direction of Rotation</i> .....	42
4.7.3	<i>Preset Set Value</i> .....	42
4.7.4	<i>Leave Drive Mode</i> .....	42
<b>5.</b>	<b>Error Diagnosis .....</b>	<b>43</b>
<b>6.</b>	<b>Index .....</b>	<b>44</b>
<b>7.</b>	<b>Password .....</b>	<b>113</b>

## 1. General

### 1.1 Product Description

In selecting the KEB COMBIVERT you have chosen a frequency inverter with the highest demands on quality and dynamic.



It exclusively serves for a stepless speed regulation of the three-phase motor.



The operation of other electrical utilization equipment is forbidden and can lead to the destruction of the unit.

GB

This instruction manual describes the COMBIVERT F4-S

- **0.37kW / 230V-class**
- **0.75kW / 230V-class**

Through small dimensions and an optimal price the unit is convincing with following features:

- operator-friendly interface
- low switching losses due to IGBT power circuit
- short-time overload up to 200%
- extensive protection devices for current, voltage and temperature
- conditional short-circuit and earth-fault-proof
- immunity to interference according to IEC1000
- potential-separated digital inputs
- programmable relay output
- DC-brake
- 3 fixed frequencies
- slip compensation
- auto-boost
- output voltage stabilization
- speed search
- adjustable current limits for acceleration and constant operation
- fast commissioning by way of keyboard (Drive-Mode)
- optional networking via gateway with Interbus-S, CAN and Profibus

## 1.2 Identification of the unit

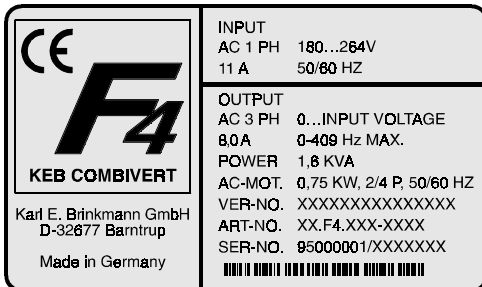

**Input Specifications:**

Input mains perm. mains voltage range  
 Input current during nominal load mains frequency

**Output Specifications:**

Output phases Output voltage range  
 Output current during nominal load Output frequency range  
 Max. output rated power of the inverter in relation to 230VAC  
 Recommended nominal data of the motor to be used  
 COMBIVIS Identification number:  
 Part number: 07.F4.S0C-1220  
 Serial number: /

### Unit Size

## 2. Power Circuit

### 2.1 Performance Data

The following performance data apply to 2/4-pole standard motors. For other pole numbers the frequency inverter must be dimensioned onto the rated motor current. With regard to special-purpose or medium frequency motors please contact KEB.

Size		05	07
Nominal power output <sup>1)</sup>	[kVA]	0,9	1,6
Peak current (<30s)	[A]	4,6	8,0
Nominal output current	[A]	2,3	4,0
Max. rated motor power	[kW]	<b>0,37</b>	<b>0,75</b>
Max. switching frequency	[kHz]	<b>8</b>	<b>8</b>
Power loss	[W]	<b>35</b>	<b>50</b>
<b>Load capacity</b>		30s max. peak current	
Mains voltage	[V]	180...264 ± 0 %	
Network phase		1	
Mains frequency	[Hz]	50 / 60 ± 2	
Output voltage	[V]	3 x 0 ... U <sub>Mains</sub>	
Output frequency	[Hz]	0...409,58	
Max. permissible mains fuse	[A]	10	20
Supply cross section <sup>2)</sup>	[mm <sup>2</sup> ]	1,5	2,5
Permissible temp. limit value		-25...70°C storage -10...45°C in operation	
Relative humidity		max.95% (without precipitation)	
Design-/protective system		IP20	
Noise suppression <sup>3)</sup>		EN 50081-1/ 50082-2	
Noise immunity		IEC 1000 4-2/-3/-4/-5/-6	
Emitted interferences		EN55011-B / EN 55022-A	

<sup>1)</sup> In relation to 230V rated voltage

<sup>2)</sup> Recommended minimal cross section at rated power and cable length up to 100m (copper).

<sup>3)</sup> Only with optional built-in filter und shielded, grounded motor cable on both sides

GB

2.2 Dimensions

GB

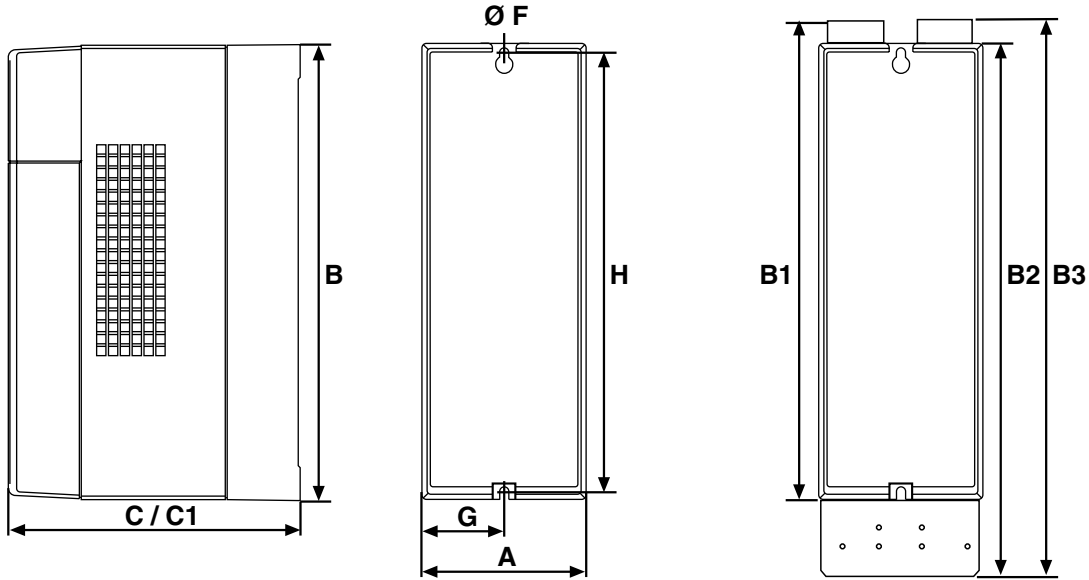

Size	A	B	B1	B2	B3	C	C1	F	G	H	H1	Weight [kG]
C	90	230	264	260	300	115	165	5	45	220	240	1,5

**B1/C1/H1** with submounted filter  
**B2** with screening plate  
**B3** with submounted filter and screening plate

2.4 Installation Instructions

**i** Installation height max. 2000 m. At installation heights over 1000 m a power reduction of 1% per 100m must be taken into consideration.

Direction of the cooling fins

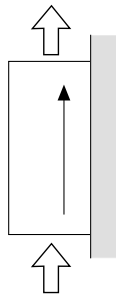

Always install vertically!

minimum clearance in mm

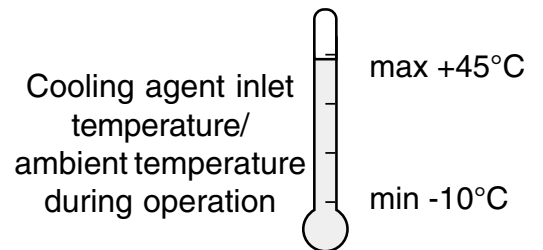
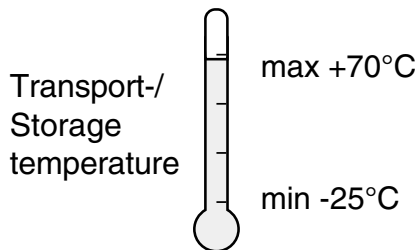
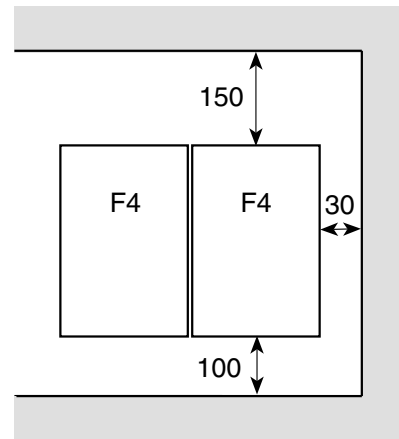

2.3 Terminals

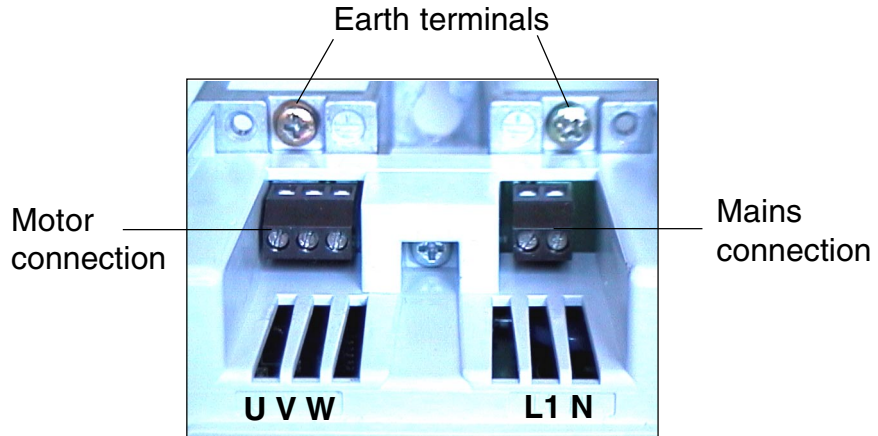

GB

2.5 Connection of the Power Circuit

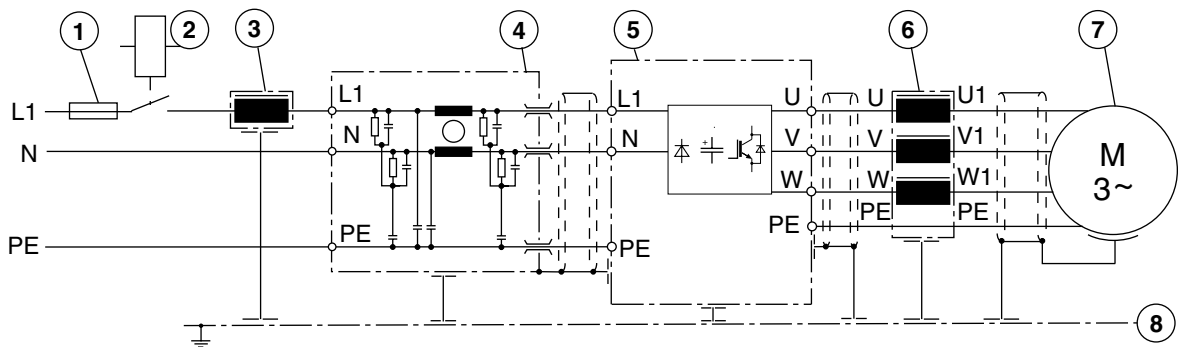

- ① Mains fuse (see „Technical Data“)
- ② Mains contactor !!! Generally switch only the phase !!!
- ③ Input reactor (Part.No. Size 05: 00.90.291-4848 / Size 07: 00.90.291-2948)
- ④ Interference suppression filter (GEN.No. Size 05: 05.U4.00C-B600 / 07: 07.U4.00C-B600)
- ⑤ KEB COMBIVERT F4-S
- ⑥ Motor choke (Part.No. Size 05: 00.90.290-4245 / Size 07: 00.90.291-2845)  
!!! Only use up to 4 KHz switching and 51 Hz output frequency !!!  
For other switching or output frequencies ask KEB.
- ⑦ Motor
- ⑧ Mounting plate

## 3. Control circuit

### 3.1 Assignment of Terminal Strip X1

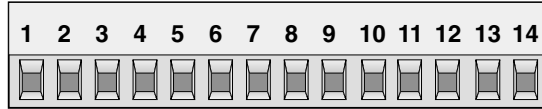

PIN	Function	Name	Description
X1.1	NO contact	RLA	Relay output (30V DC / 1A)
X1.2	NC contact	RLB	Function see parameter CP.22
X1.3	Main contact	RLC	( factory setting: fault indication)
X1.4	Fixed frequency 1	I1	X1.4 + X1.5 = fixed frequency 3 no input = analog set value
X1.5	Fixed frequency 2	I2	
X1.6	Digital Ground	0V	Zero potential for digital in-/outputs
X1.7	+10V	CRF	Supply voltage for set value potentiometer (max. 4mA) 0...10VDC for analog set value Ground for analog in- and outputs
X1.8	Set value input	REF	
X1.9	Common	COM	
X1.10	Analog output	AOUT	Analog output of real frequency 0...10VDC = 0...100Hz
X1.11	15V	+15V	voltage supply for digital in-/outputs (max. 100mA)
X1.12	Reverse	R	Preset rotation; forward has priority
X1.13	Forward	F	
X1.14	Control release	ST/RST	Power modules are enabled; Reset at opening

### 3.2 Connection of the control

In order to prevent a malfunction caused by interference voltage supply on the control inputs, the following directions should be observed:



- Use shielded/drilled cables
- Lay shield **on one side** of the inverter onto earth potential
- Lay control and power cable **separately** (about 10...20 cm apart)
- Lay crossings in a right angle (in case it cannot be prevented)

#### 3.2.1 Digital input

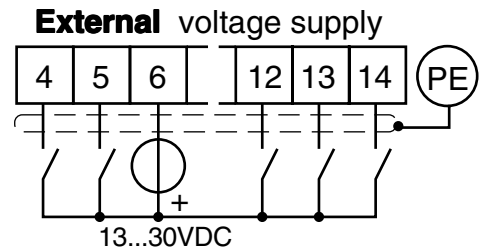
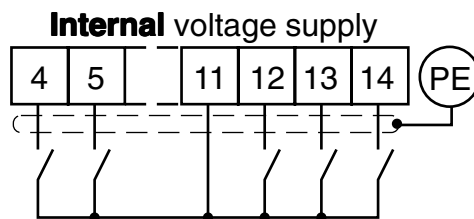

#### 3.2.2 Analog input

Internal analog set-point setting 0...10V

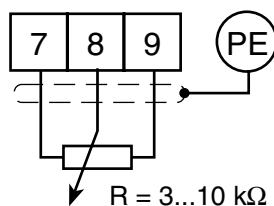

External analog set-point setting

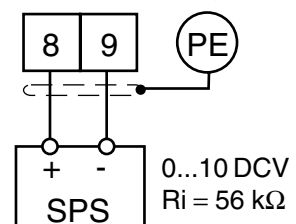



### 3.2.3 Outputs

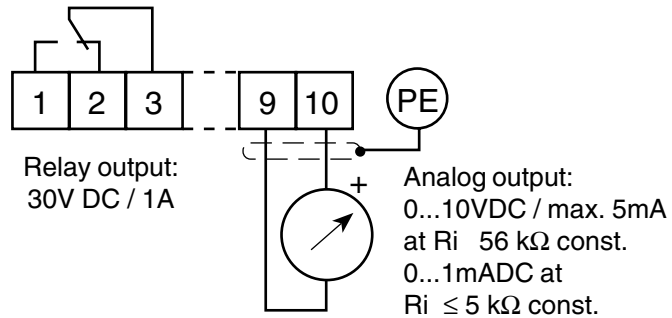

## 4. Operation of the unit

As an accessory to the local operation an operator is necessary. To prevent malfunctions, the inverter must be brought into **nOP** status before connecting/disconnecting the operator (open control release terminal X1.14). When starting the inverter without an operator, it is started with the last stored values or factory setting. The operator is obtainable in different versions:

### 4.1 Digital operator Part-No. 00.F4.010-2009

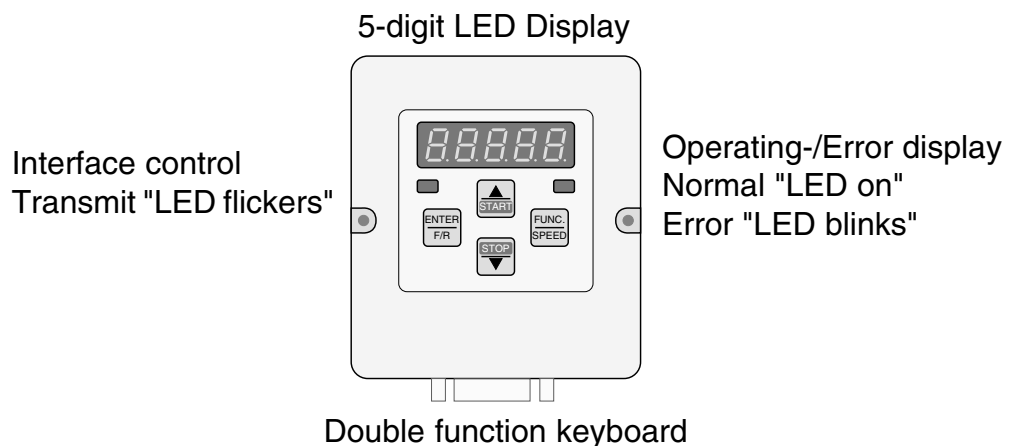

#### 4.1.1 Interface operator Part-No. 00.F4.010-1009

In the Interface operator there is an additional isolated RS232/RS485-Interface integrated.

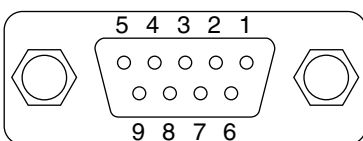
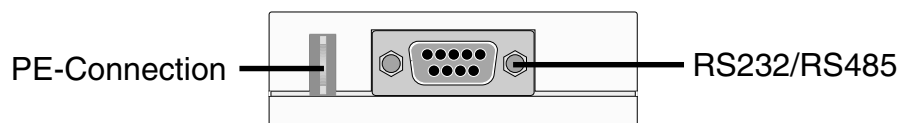

PIN	RS485	Signal	Meaning
1	–	–	reserved
2	–	TxD	Transmitter signal/RS232
3	–	RxD	Receiver signal/RS232
4	A'	RxD-A	Receiver signal A/RS485
5	B'	RxD-B	Receiver signal B/RS485
6	–	VP	Voltage supply-Plus +5V ( $I_{max} = 10\text{ mA}$ )
7	C/C'	DGND	Data reference potential
8	A	TxD-A	Transmitter signal A/RS485
9	B	TxD-B	Transmitter signal B/RS485

Informations about other versions of operators contact KEB!

## 4.1.2 Keyboard

When switching on KEB COMBIVERT the value of parameter CP.1 appears. (See Drive mode to switch the keyboard function)

The **function key** (FUNC) changes between the parameter value and parameter number.



With **UP** (▲) and **DOWN** (▼) the value of the parameter number is increased/decreased with **changeable** parameters.

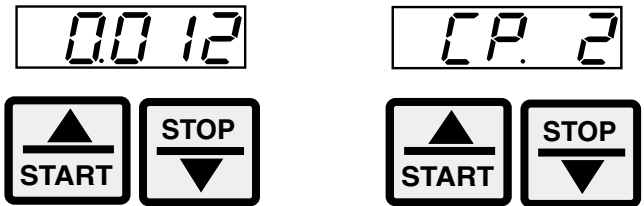

Principally during a change, parameter values are immediately accepted and stored non-volatile. With some parameters it is not useful, that the adjusted value immediately be accepted. When this type of parameter is changed, then a point appears behind the last digit.

By pressing **ENTER** the adjusted value is accepted and non-volatile stored.



If a malfunction occurs during operation, then the actual display is overwritten by the alarm message. The alarm message in the display is reset by ENTER.

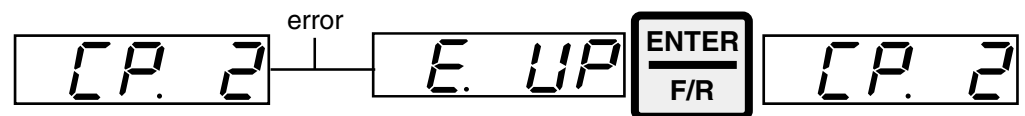

With ENTER the error message is only reset in the display. In order to reset an error oneself, the cause must be removed and a reset on terminal X1.14 or a power-on reset must occur. In the Inverter status display (CP. 2) the error is still displayed.

### 4.2 Parameter Summary

Display	Parameter	Adjust. range	Resolution	Factory setting
CP. 0	Password input	0...9999	1	-
CP. 1	Actual frequency display	-	0,1 Hz	-
CP. 2	Inverter status display	-	-	-
CP. 3	Actual load	-	1 %	-
CP. 4	Peak load	-	1 %	-
CP. 5	Rated frequency	0...409.58 Hz	0.0125 Hz	50.0 Hz
CP. 6	Boost	0...25.5 %	0.1 %	2 %
CP. 7	Acceleration time	0.01...300 s	0.01 s	10 s
CP. 8	Deceleration time	0.01...300 s	0.01 s	10 s
CP. 9	Minimal frequency	0...409.58 Hz	0.0125 Hz	0 Hz
CP.10	Maximal frequency	0...409.58 Hz	0.0125 Hz	70 Hz
CP.11	Fixed frequency 1	±0...409.58 Hz	0.0125 Hz	5 Hz
CP.12	Fixed frequency 2	±0...409.58 Hz	0.0125 Hz	50 Hz
CP.13	Fixed frequency 3	±0...409.58 Hz	0.0125 Hz	70 Hz
CP.14	Max. ramp current	10...200 %	1 %	140 %
CP.15	Max. constant current	10...200 %	1 %	200 %
CP.16	Speed search	0...7	1	0
CP.17	Voltage stabilization	150...649 V, oFF	1 V	oFF
CP.18	Slip compensation	-2.50...2.50	0.01	0=oFF
CP.19	Autoboost	-2.50...2.50	0.01	0=oFF
CP.20	DC-braking	0...9	1	0
CP.21	Braking time	0...100 s	0.01 s	10 s
CP.22	Relay output	0...25 (0...24) <sup>1)</sup>	1	2
CP.23	Frequency level	0...409.58 Hz	0.0125 Hz	4 Hz

GB

<sup>1)</sup> Value 0...24 is valid as of software version 1.1

### 4.3 Password Input



Ex works the frequency inverter is supplied without password protection, this means that all changeable parameters can be adjusted. After parameterizing the unit can be barred against unauthorized access. The adjusted mode is stored.

#### Locking the CP-Parameter

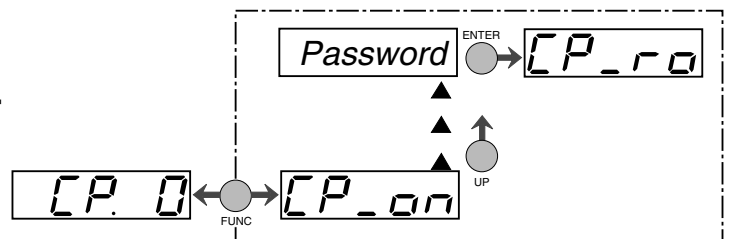

#### Releasing the CP-Parameter

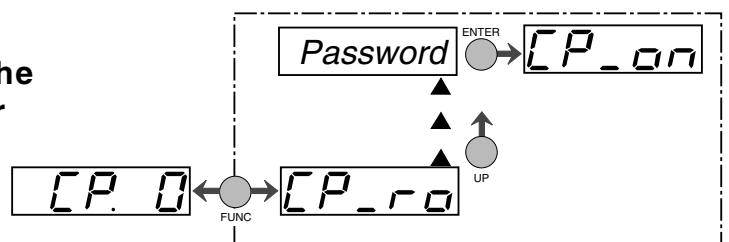

## 4.4 Operating Display

### Actual frequency display



The 4 parameters below serve to control the frequency inverter during operation.

Display of the actual output frequency with a resolution of 0.0125 Hz. The rotation of the inverter is indicated by the sign.

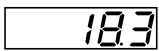
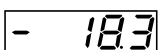
Examples:  Output frequency 18.3 Hz, rotation forward  
 Output frequency 18.3 Hz, rotation reverse

### Inverter status display

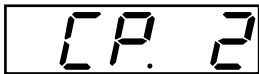

The status display shows the actual working conditions of the inverter. Possible displays and their meanings are:

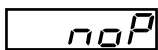

" no Operation " control release (terminal X1.14) not bridged, modulation switched off, output voltage = 0 V, drive is not controlled.

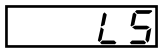

" Low Speed " no rotation preset ( terminal X1.12 or X1.13), modulation switched off, output voltage = 0 V, drive is not controlled.

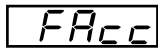

" Forward Acceleration " drive accelerates with a forward direction of rotation.

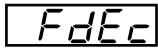

" Forward Deceleration " drive decelerates with a forward direction of rotation.

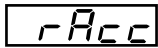

" Reverse Acceleration " drives accelerates with a reverse direction of rotation.

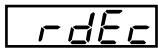

" Reverse Deceleration " drive decelerates with a reverse direction of rotation.

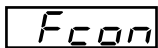

" Forward Constant " drive runs with a constant speed and a forward direction of rotation.



" Reverse Constant " drive runs with constant speed and a reverse direction of rotation.

Other status messages are described at the parameters, which they cause.

### Actual load

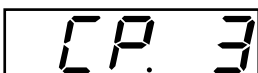

Display of the actual inverter rate of utilization in percent. 100% rate of utilization is equal to the inverter rated current. Only positive values are displayed, meaning there is no differentiation between motor and regenerative operation.

### Peak load



This display makes it possible to recognize short-term fluctuations of the rate of utilization by storing the highest value that occurred. The display occurs in percent (100% = inverter rated current).



With the UP or DOWN key the peak value can be reset when the unit is on. Switching off the unit deletes the peak value.

### 4.5 Basic Adjustment of the Drive

Rated frequency



The following parameters determine the fundamental operating data of the drive. They should be checked and/or adapted to the application.

With the adjusted frequency here the inverter reaches a maximal output voltage. The adjustment of the motor rated frequency is typical here. Note: Motors can overheat when the rated frequency is incorrectly adjusted!

Adjustment range: 0...409.58 Hz  
 Resolution: 0.0125 Hz  
 Factory setting: 50.0 Hz  
 Customer adjustment: \_\_\_\_\_ Hz

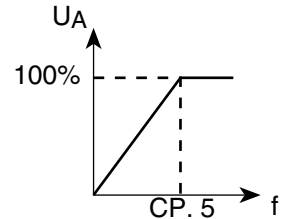

GB

Boost

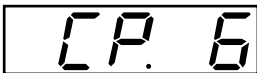

In the lower speed range a large part of the motor voltage decreases on the stator resistance. In order that the breakdown torque of the motor remains almost constant in the entire speed range, the voltage decrease can be compensated by the boost.

Adjustment range: 0...25.5 %  
 Resolution: 0.1 %  
 Factory setting: 2.0 %  
 Customer adjustment: \_\_\_\_\_ %

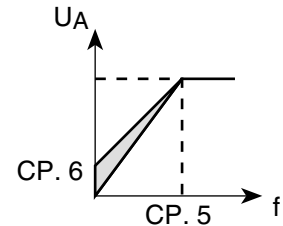

- Adjustment:
- Determine the rate of utilization in no-load operation during rated frequency
  - Preset about 10 Hz and adjust the boost, so that about the same rate of utilization is reached as with the rated frequency.



When the motor, during continuous operation, drives with low speed and too high voltage it can lead to an overheating of the motor.

Acceleration time

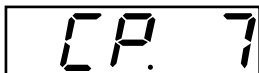

The parameter determines the time needed, in order to accelerate from 0 to 100 Hz. The actual acceleration time is proportional to the frequency change.

$$\text{actual acceleration time} = \frac{\text{CP. 7} \times \Delta f}{100 \text{ Hz}}$$

Adjustment range: 0.01...300 s  
 Resolution: 0.01 s  
 Factory setting: 10 s  
 Customer adjustment: \_\_\_\_\_ s

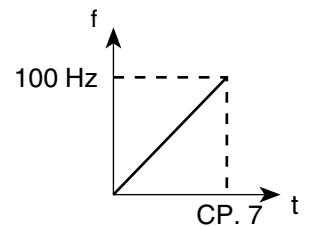

Example: CP. 7 = 10 s ; the drive should accelerate from 10 Hz to 60 Hz  
 $\Delta f = 60 \text{ Hz} - 10 \text{ Hz} = 50 \text{ Hz}$

$$\text{actual acceleration time} = (50 \text{ Hz} / 100 \text{ Hz}) \times 10 \text{ s} = 5 \text{ s}$$

## Deceleration time

CP. 8

The parameter determines the time needed in order to decelerate from 100 to 0 Hz. The actual deceleration time is proportional to the frequency change.

$$\text{actual acceleration time} = \frac{\text{CP. 8} \times \Delta f}{100 \text{ Hz}}$$

Adjustment range: 0.01...300 s  
 Resolution: 0.01 s  
 Factory setting: 10 s  
 Customer adjustment: \_\_\_\_\_ s

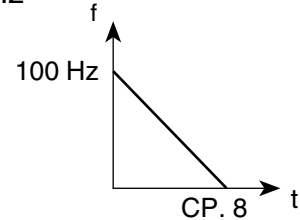

Example: CP. 8 = 10 s ; the drive should decelerate from 60 Hz to 10 Hz  
 $\Delta f = 60 \text{ Hz} - 10 \text{ Hz} = 50 \text{ Hz}$

$$\text{actual deceleration time} = (50 \text{ Hz} / 100 \text{ Hz}) \times 10 \text{ s} = 5 \text{ s}$$

## Minimal frequency

CP. 9

Frequency on which the inverter runs without presetting an analog set value. Internal limiting of the fixed frequencies CP.11...CP.13.

Adjustment range: 0.0...409.58 Hz  
 Resolution: 0.0125 Hz  
 Factory setting: 0.0 Hz  
 Customer adjustment: \_\_\_\_\_ Hz

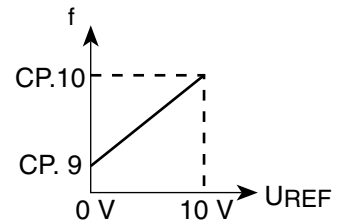

## Maximal frequency

CP. 10

Frequency on which the inverter runs with maximum analog set value. Internal limiting of the fixed frequencies CP.11...CP.13.

Adjustment range: 0.0...409.58 Hz  
 Resolution: 0.0125 Hz  
 Factory setting: 70 Hz  
 Customer adjustment: \_\_\_\_\_ Hz

## Fixed frequency 1...3

terminal X1.4

CP. 11

terminal X1.5

CP. 12

terminals X1.4+X1.5

CP. 13

Three fixed frequencies can be adjusted. The selection of the fixed frequencies occurs with the terminals X1.4 and X1.5.

Adjustment range: 0.0...±409.58 Hz  
 Resolution: 0.0125 Hz  
 Factory setting: 5/50/70 Hz  
 Customer adjustment 1: \_\_\_\_\_ Hz  
 Customer adjustment 2: \_\_\_\_\_ Hz  
 Customer adjustment 3: \_\_\_\_\_ Hz

If presetting occurs outside of the fixed limits of CP.9 and CP.10, then the frequency is internally limited.

### 4.6 Special Adjustments

Max. ramp current

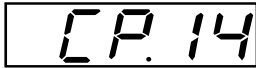

The following parameters serve to optimize the drive and adaption onto certain applications. These adjustments can be ignored at the initial startup.

This function protects the frequency inverter against switching off by overcurrent during the acceleration ramp. When the ramp reaches the adjusted value here, then it is stopped as long as the current decreases again. CP.2 displays "LAS" at active function.

Adjustment range: 10...200%, 200% = oFF  
 Resolution: 1 %  
 Factory setting: 140 %  
 Customer adjustment: \_\_\_\_\_ %

GB

Max. constant current

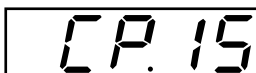

This function protects the frequency inverter against switching off due to overcurrent during constant output frequency. When exceeding the adjusted value here, the output frequency is reduced until the value drops below the adjusted value. CP. 2 displays "SSL" at active function.

Adjustment range: 10...200%, 200% = oFF  
 Resolution: 1 %  
 Factory Setting: 200 %  
 Customer adjustment: \_\_\_\_\_ %

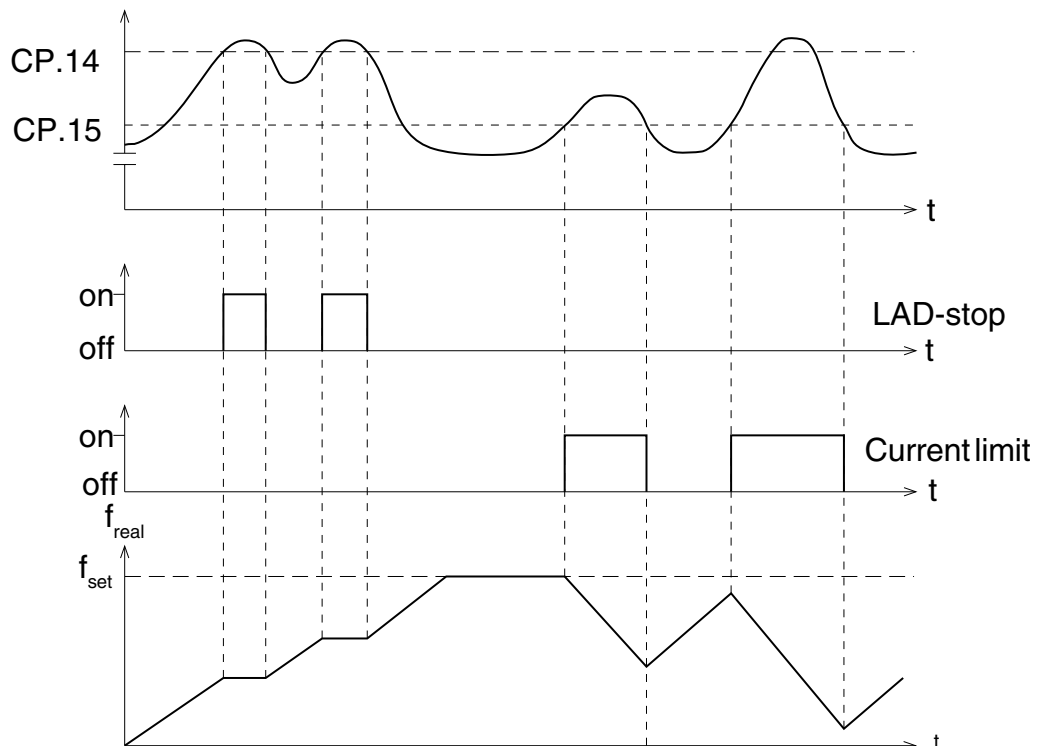

## Speed search

CP.16

When connecting the frequency inverter onto a decelerating motor, an error can be triggered by the differing rotating field frequencies. At activated speed search the inverter searches the actual motor speed, adapts its output frequency and accelerates with the adjusted ramp onto the given set value. During speed search CP.2 displays "SSF". The parameter determines, under what conditions the functions operate. With several conditions the sum of the value must be entered.

Example: CP.16 = 5 means at control release and after reset

Adjustment range: 0...7  
 Resolution: 1  
 Factory setting: 0  
 Customer adjustment: \_\_\_\_\_

Value	Condition
0	function off
1	at control release
2	at switch on
4	after reset

## Voltage stabilization

CP.17

This parameter can adjust a regulated output voltage in relation to the rated frequency. Because of this voltage variations at the input as well as in the intermediate circuit only have a small influence on the output voltage (U/f-characteristic). The function allows, among other things, an adaption of the output voltage onto the special motors. In the example below the output voltage is stabilized onto 230 V (0% boost).

Adjustment range: 150...649 V, oFF  
 Resolution: 1 V  
 Factory setting: oFF  
 Customer adjustment: \_\_\_\_\_ V

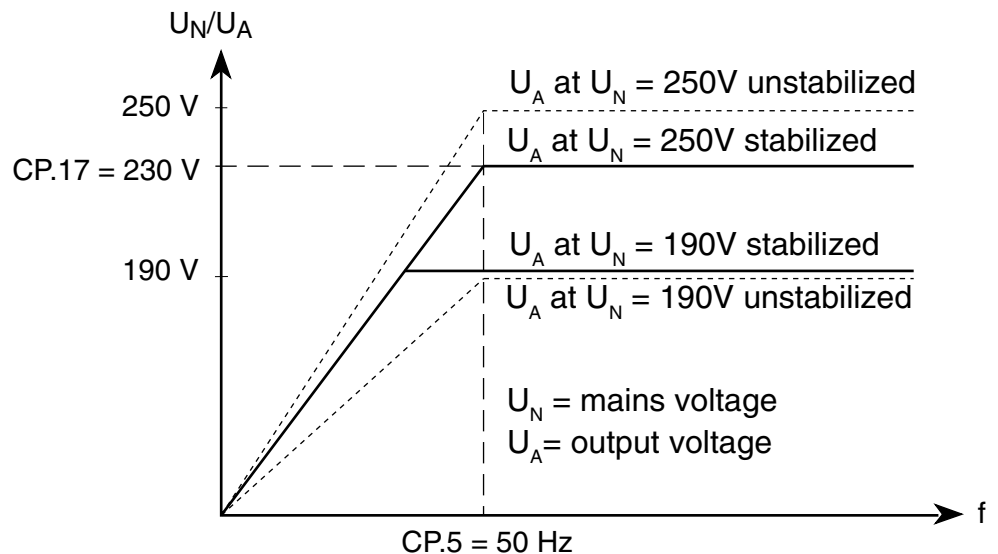



## Slip compensation

CP.18

Slip compensation balances the speed changes caused by the load variation. In order to activate the function, set the value at 1.00 and optimize as directed in the examples below.

Adjustment range: -2.50...2.50  
 Resolution: 0.01  
 Factory setting: 0.00 (= oFF)  
 Customer adjustment: \_\_\_\_\_

## Autoboost

CP.19

Autoboost causes an automatic I\*R-compensation by raising the output voltage during high load torques. The magnetizing current remains constant. To activate the function set the value to 1.00 and optimize as directed in the examples below. Check the motor voltage to see, whether it returned to the normal value after no load of the drive. Otherwise reduce CP.19.

Adjustment range: -2.50...2.50  
 Resolution: 0.01  
 Factory setting: 0.00 (= oFF)  
 Customer adjustment: \_\_\_\_\_

GB



Slip compensation and autoboost work on the basis of preset motor data. When using a special motor or in case of overdimensioning of more than one size, then both functions should be deactivated.

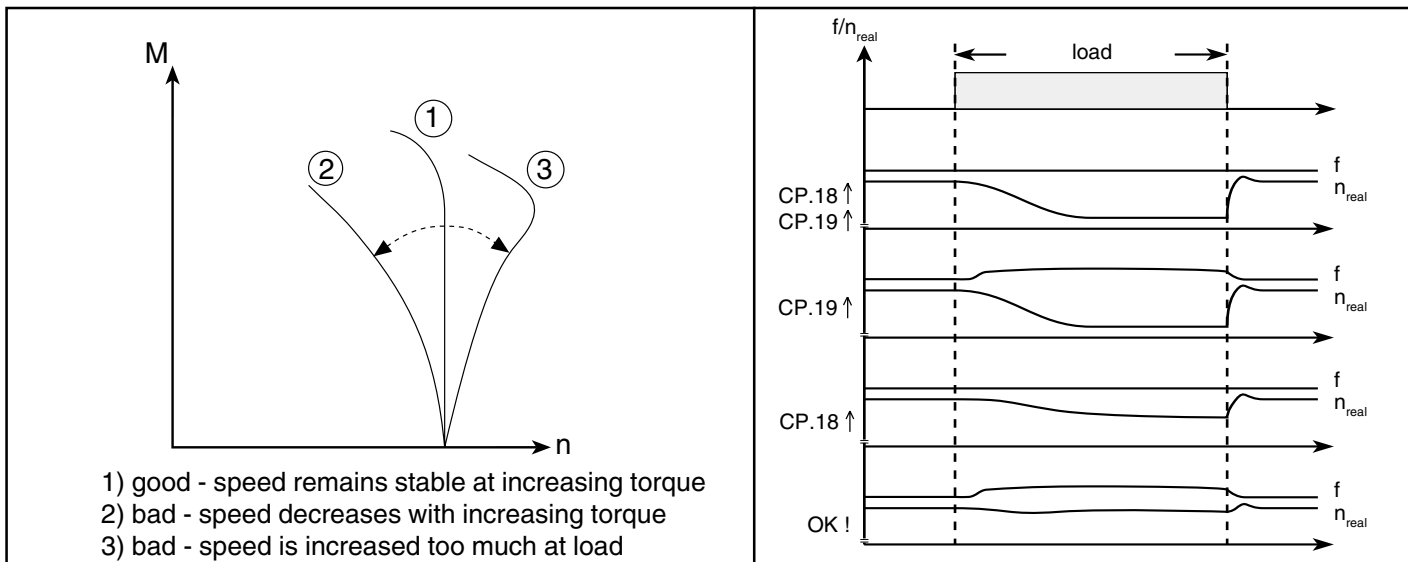

## DC-braking

CP.20

With DC-braking the motor is not decelerated by the ramp. Quick braking is caused by DC voltage, which is applied onto the motor winding. This parameter determines how the DC-braking is triggered.

Value	Activation
0	DC-braking deactivated
1	DC-braking at switch off of the direction of rotation and in reaching 0Hz. Braking time is dependent on CP.21 or until the next direction of rotation presetting.
2	DC-braking as soon as the direction of rotation presetting is absent. Braking time dependent on the real frequency
3	DC-braking, as soon as the direction of rotation changes. Braking time dependent on the real frequency.
4	DC-braking at switch off of the direction of rotation and the real frequency goes below 4 Hz.
5	DC-braking, when the real frequency goes below 4 Hz.
6	DC-braking, as soon as the set value goes below 4 Hz.
7	DC-braking deactivated
8	DC-braking deactivated
9	DC-braking after switching on the modulation on. Braking time is dependent on CP.21.

Factory setting: 0  
 Note: Enter-Parameter  
 Customer adjustment: \_\_\_\_\_

## Braking time

CP.21

The braking time is evaluated depending on CP.20 as follow:

- entered time = braking time
- entered time relates to 100 Hz and decreases/increases proportionally to the real frequency.

Adjustment range: 0.00...100 s  
 Resolution: 0.01 s  
 Factory setting: 10 s  
 Customer adjustment: \_\_\_\_\_

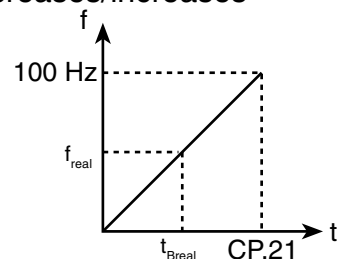

Calculation of the braking time:

$$t_{Breal} = \frac{CP.21 * f_{real}}{100 \text{ Hz}}$$

## Relay output

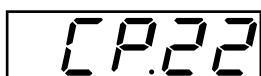

Relay output (terminal X1.1...X1.3) is adjusted in the factory as a fault relay. This parameter can adjust the function of the output onto any function listed in the table below.

Value	Function
0	No function
1	Generally on
2	Fault relay
3	No function
4	Overload alert signal (10s before switch off)
5	* Overtemperature alert signal inverter
6	* Overtemperature alert signal motor (10s before switch off)
7	No function
8	Max. constant current (stall, CP.15) exceeded
9	Max. LA-/LD-Stop (CP.14) exceeded
10	DC-braking active
11	No function
12	Rate of utilization (CP.3) > 100%
13	No function
14	Actual value = set value (CP.2 = Fcon, rcon; not at noP, LS, error, SSF)
15	Accelerate (CP.2 = FAcc, rAcc, LAS)
16	Decelerate (CP.2 = FdEc, rdEc, LdS)
17	Right handed rotation (not at noP, LS error)
18	Left handed rotation (not at noP, LS error)
19	Real direction of rotation = set direction of rotation
20	Real value > frequency level CP.23
21	Set value > frequency level CP.23
22	No function
23	Operating signal (after initialization as long as no error is active)
24	Run signal
25	No function (not available since software version 1.1)

GB

Factory setting: 2 \* available as of software version 1.1  
 Note: Enter-Parameter  
 Customer adjustment: \_\_\_\_\_

## Frequency level

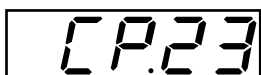

This parameter determines the switching point for the relay output X1.1...X1.3 at CP.22 = "20" or "21"

After the switching of the relay, the frequency can move within a 0.5 Hz window, without the relay dropping off.

Adjustment range: 0.0...409.58 Hz  
 Resolution: 0.0125 Hz  
 Factory setting: 4 Hz  
 Customer adjustment: \_\_\_\_\_

## 4.7 The Drive Mode

The drive mode is a operating mode of KEB COMBIVERT to start the drive manually by the operator. After switching the control release the set value and rotation presetting is done exclusively by the keyboard. In order to activate the drive mode the corresponding **password in CP.0** must be entered. The display switches over as follows.

### Direction of rotation

F=forward / r=reverse

### Status

noP = no control release /

LS = neutral position

Modulation blocked  
Drive not controlled

F LS

Drive decreases to 0 Hz and switches the modulation off



Drive accelerates onto the adjusted set value

F 500

Drive operates with adjusted set value

### 4.7.1 Start / Stop Drive

### 4.7.2 Change Direction of Rotation



Drive changes direction of rotation

r 500

### 4.7.3 Preset Set Value



Display changes when key is pressed to set value display/presetting



500

Set value can be changed with UP/DOWN at pressed FUNC/SPEED key

### 4.7.4 Leave Drive Mode

To exit the drive mode the inverter must be in status “stop” (Display noP or LS). Press the FUNC and ENTER keys simultaneously for about 3 seconds in order to leave the drive mode. The CP-parameters appear in the display.



+



for 3 seconds

## 5. Error Diagnosis

### Undervoltage

E. UP

Error messages are represented with an "E. " and the corresponding error in the display of the KEB COMBIVERT. The displays and their causes are described below.

Occurs, when the intermediate circuit voltage falls below the permissible value.

Possible causes are

- input voltage too low or unstable
- inverter power too small
- voltage loss due to incorrect cabling
- power supply by generator/transformer breaks down, because ramps are too short

### Overvoltage

E. OP

Occurs, when the intermediate circuit voltage rises above over the permissible value.

Possible causes are

- input voltage too high
- disturbance voltages at the input
- delay ramps too short

### Overcurrent

E. OC

Occurs, when exceeding the peak current or at ground fault.

### Overload

E. OL

Occurs when a too high load is applied for more than the allowed time (see "Performance Data"). Possible causes for this are

- error or overload in the application
- inverter incorrectly dimensioned
- motor incorrectly wired

### Cooling down phase completed

E.nOL

After error E. OL you must wait for a cooling down time. This message appears after the cooling down phase is completed. The error can be reset.

### Overheat

E. OH

Occurs, when the heat sink temperature  $> 85^{\circ}\text{C}$ . Possible causes for this are

- insufficient cooling
- surrounding temperature too high

### no Overheat

E.nOH

Internal or external excess-temperature error do not occur anymore. Error "E. OH" can be reset.

### Current limit resistor error

E.LSF

Current limit resistor not bridged, occurs for a short time during the turn on phase and is reset immediately. If the error message remains the following may be the cause

- incorrect or input voltage too small
- high loss in the supply line

## 7. Index

### A

Acceleration time 33, 35, 45  
Actual frequency display 33, 34, 45  
Actual load 33, 34, 45  
Analog inputs 30  
Analog output 30  
Autoboost 33, 39, 45

### B

Basic Adjustment 35  
Boost 33, 35, 45  
Braking time 33, 45

### C

Change Direction 42  
Common 30  
Control circuit Version S 30  
Control release 30  
Cooling down phase 43  
Current limit 37  
current limit 37  
Current limit resistor error 43

### D

DC-braking 33, 40, 45  
Deceleration time 36  
Deceleration time 33, 45  
Digital inputs 30  
Digital Mass 30  
Drive Mode 42

### E

Error Diagnosis 43  
Error messages 43

### F

Fixed frequency 30, 33, 36, 45  
Forward 30  
Frequency value 33, 41, 45

### I

I\*R-compensation 39  
Interface operator 31  
interference voltage supply 30  
Inverter status display 33, 34, 45

### K

Keyboard 31, 32

### L

LAD-stop 37

LED 31  
load variation 39

### M

Max. constant current 33, 37, 45  
Max. ramp current 33, 37, 45  
Maximal frequency 33, 36, 45  
Minimal frequency 33, 36, 45  
modulation 34  
Modulation blocked 42  
Motor data 39

### N

no Overheat 43

### O

Operating Display 34  
optimize 39  
Overcurrent 43  
Overheat 43  
Overload 43  
Overvoltage 43

### P

Password input 33, 45  
Peak load 33, 34, 45  
peak value 34

### R

Rated frequency 33, 35, 45  
Relay output 30, 33, 41, 45  
Releasing 33  
RS232/485 31

### S

Set value input 30  
Slip compensation 33, 39, 45  
Special Adjustments 37  
Speed search 33, 38, 45  
Start / Stop 42

### U

Undervoltage 43

### V

Voltage stabilization 33, 38, 45

### X

X1 30

Display	Parameter	Adjust. range	Resolution	Customer setting
CP. 0	Password input	0...9999	1	-
CP. 1	Actual frequency display	-	0,1 Hz	-
CP. 2	Inverter status display	-	-	-
CP. 3	Actual load	-	1 %	-
CP. 4	Peak load	-	1 %	-
CP. 5	Rated frequency	0...409.58 Hz	0.0125 Hz	_____
CP. 6	Boost	0...25.5 %	0.1 %	_____
CP. 7	Acceleration time	0.01...300 s	0.01 s	_____
CP. 8	Deceleration time	0.01...300 s	0.01 s	_____
CP. 9	Minimal frequency	0...409.58 Hz	0.0125 Hz	_____
CP.10	Maximal frequency	0...409.58 Hz	0.0125 Hz	_____
CP.11	Fixed frequency 1	0...±409.58 Hz	0.0125 Hz	_____
CP.12	Fixed frequency 2	0...±409.58 Hz	0.0125 Hz	_____
CP.13	Fixed frequency 3	0...±409.58 Hz	0.0125 Hz	_____
CP.14	Max. ramp current	10...200 %	1 %	_____
CP.15	Max. constant current	10...200 %	1 %	_____
CP.16	Speed search	0...7	1	_____
CP.17	Voltage stabilization	150...649 V, oFF	1 V	_____
CP.18	Slip compensation	-2.50...2.50	0.01	_____
CP.19	Autoboost	-2.50...2.50	0.01	_____
CP.20	DC-braking	0...9	1	_____
CP.21	Braking time	0...100 s	0.01 s	_____
CP.22	Relay output	0...25 (0...24) <sup>1)</sup>	1	_____
CP.23	Frequency level	0...409.58 Hz	0.0125 Hz	_____

<sup>1)</sup> Value 0...24 is valid as of software version 1.1

The **function key** (FUNC) changes between the parameter value and parameter number.



With **UP** (▲) and **DOWN** (▼) the value of the parameter number is increased/decreased with **changeable** parameters.

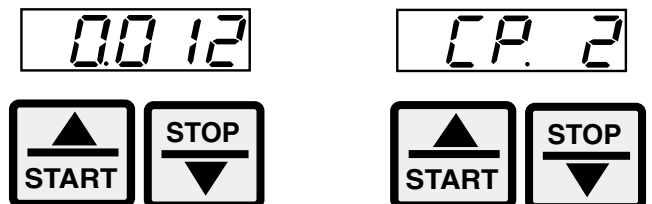

Password input:

Locking the CP-Parameter

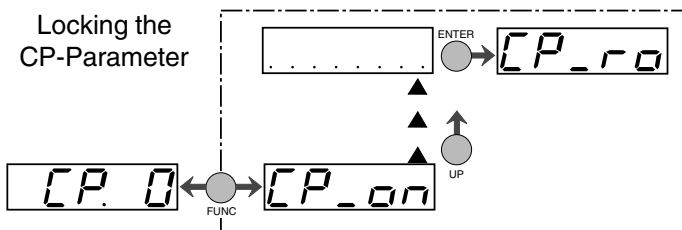

Releasing the CP-Parameter

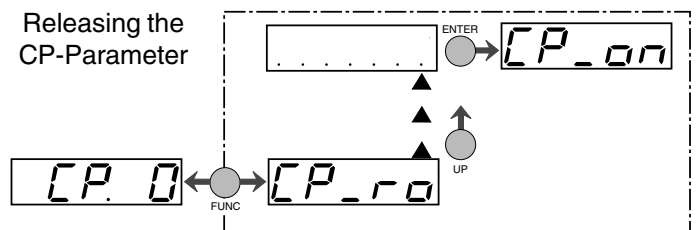





## 7. Password

a) CP-Parameter "read only"

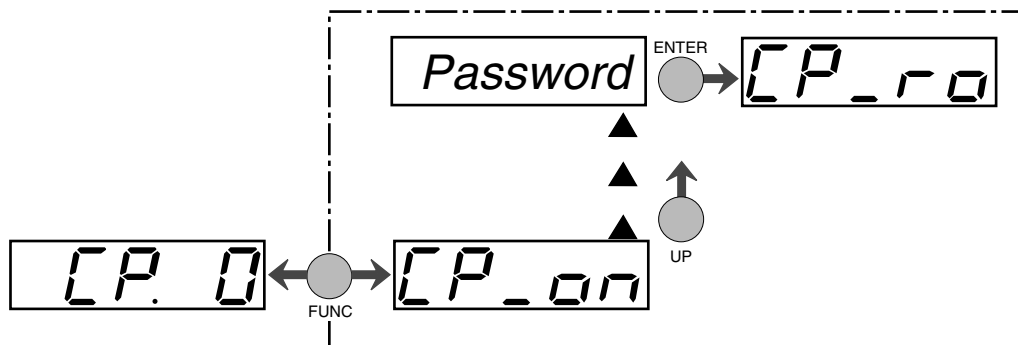

b) CP-Parameter "read/write"

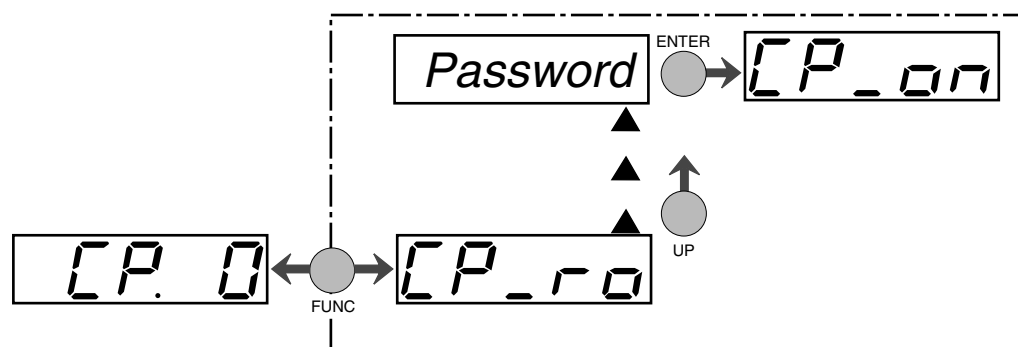

c) Drive mode activ

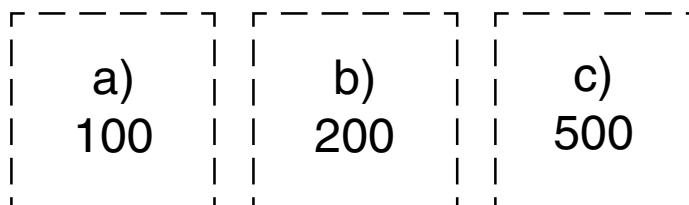
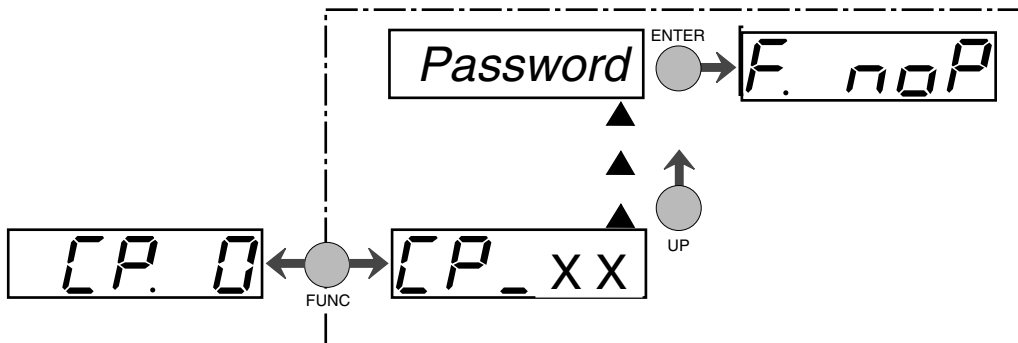



**(D)** Vor Auslieferung durchlaufen alle Produkte mehrfach eine Qualitäts- und Funktionskontrolle, so daß Fehler auszuschließen sind. Bei Beachtung unserer Betriebsanleitung sind keine Störungen zu erwarten. Sollte sich trotzdem ein Grund zur Reklamation ergeben, so ist das Gerät mit Angabe der Rechnungsnummer, des Lieferdatums, der Fehlerursache und der Einsatzbedingungen an uns zurückzusenden. Für Fehler, die aufgrund falscher Behandlung, falscher Lagerung oder sonstigen allgemeinen Irrtümern auftreten, übernehmen wir keine Verantwortung. Prospekte, Kataloge und Angebote enthalten nur Richtwerte. Technische Änderungen jeder Art behalten wir uns vor. Alle Rechte vorbehalten. Nachdruck, Vervielfältigung und fotomechanische Wiedergabe sind ohne schriftliche Genehmigung durch KEB auch auszugsweise verboten.

**(GB)** Prior to delivery all products pass several quality and performance inspections so that malfunctions can be ruled out. When used in accordance with the operating instructions failure is most unlikely. However, if you have cause for complaint the unit should be returned stating invoice number, delivery date, cause of failure and field conditions. We do not accept the responsibility for failures due to misuse, wrong storage or similar causes. Leaflets, catalogues and quotations contain only standard values. We reserve the right to make technical changes without obligation. All rights reserved. Any piratic printing, mimeographing or photomechanical reproduction, even in extracts, is strictly prohibited.

**(F)** Avant la livraison tous les produits passent par différents contrôles fonctionnels et qualitatifs de manière à éliminer les mauvais fonctionnements. L'apparition de défauts sur ces produits est très improbable s'ils sont raccordés et utilisés selon les recommandations des manuels d'instructions. Néanmoins, si un défaut apparaissait, le matériel doit être retourné en indiquant le numéro du bon de livraison, la date d'expédition et les détails apparents du défaut ainsi que le type d'application. Un mauvais emploi, de mauvaises conditions de stockage ou d'autres causes de ce type excluent notre responsabilité en cas de défectuosité. Les documents techniques et commerciaux, les offres de prix ne contiennent que des valeurs standards. Nous nous réservons le droit de procéder à des modifications techniques sans préavis. Tout droit réservé. Toutes contrefaçons imprimées, ou reproductions photomécaniques; même partielles, sont strictement interdites.

**(I)** Prima di essere spediti, tutti i nostri prodotti sono soggetti a severi controlli di qualità e funzionamento, questo al fine di evitare malfunzionamenti. Se utilizzati seguendo il manuale di istruzione si evita qualsiasi malfunzionamento. Comunque, qualora dovesse verificarsi un guasto, l'unità dovrà essere rispedita specificando il numero di bolla, la data di spedizione, i dettagli del guasto ed il tipo di applicazione. Non si assumono responsabilità per errori dovuti a manomissioni, cattivo stoccaggio o simili. Ci riserviamo di effettuare qualsiasi modifica senza preavviso alcuno. Tutti i diritti sono riservati. Qualsiasi riproduzione non autorizzata, anche parziale, è rigorosamente proibita.

**(E)** Antes de la expedición, todos nuestros productos han sido sometidos a severos controles de calidad y funcionamiento, con la finalidad de evitar funcionamientos defectuosos. La posibilidad de defectos es casi improbable utilizando estos productos de acuerdo con el manual de instrucciones. Sin embargo, si se detectase algún defecto, la unidad deberá ser devuelta indicando número de expedición, fecha de envío, causa del fallo y condiciones de instalación. No se aceptarán responsabilidades debidas a un mal uso, almacenaje defectuoso o causas similares. Los documentos técnicos y comerciales indican sólo valores estándar. Nos reservamos el derecho de efectuar modificaciones técnicas sin previo aviso. Todos los derechos reservados. Cualquier reproducción parcial o total, no autorizada, está totalmente prohibida.







### **Karl E. Brinkmann GmbH**

Försterweg 36 - 38 • D - 32683 Barntrup  
Telefon 00 49 / 52 63 / 4 01 - 0 • Fax 00 49 / 52 63 / 4 01 - 1 16  
Internet: [www.keb.de](http://www.keb.de) • E-mail: [info@keb.de](mailto:info@keb.de)

### **KEB Antriebstechnik GmbH & Co. KG**

Wildbacher Str. 5 • D - 08289 Schneeberg  
Telefon 0049 / 37 72 / 67 - 0 • Telefax 0049 / 37 72 / 67 - 2 81  
E-mail: [info@keb-combidrive.de](mailto:info@keb-combidrive.de)

### **KEB Antriebstechnik Austria GmbH**

Ritzstraße 8 • A - 4614 Marchtrenk  
Tel.: 0043 / 7243 / 53586 - 0 • FAX: 0043 / 7243 / 53586 - 21  
E-mail: [info@keb.at](mailto:info@keb.at)

### **KEB Antriebstechnik**

Herenveld 2 • B - 9500 Geraadsbergen  
Tel.: 0032 / 5443 / 878 • FAX: 0032 / 5443 / 7898  
E-mail: [info@keb.de](mailto:info@keb.de)

### **KEB China**

Xianxia Road 299 • CHN - 200051 Shanghai  
Tel.: 0086 / 21 / 62350922 • FAX: 0086 / 21 / 62350015  
E-mail: [cn\\_keb@sina.com](mailto:cn_keb@sina.com)

### **Société Française KEB**

Z.I. de la Croix St. Nicolas • 14, rue Gustave Eiffel  
F - 94510 LA QUEUE EN BRIE  
Tél.: 0033 / 1 / 49620101 • FAX: 0033 / 1 / 45767495  
E-mail: [sfkeb.2@wanadoo.fr](mailto:sfkeb.2@wanadoo.fr)

### **KEB (UK) Ltd.**

6 Chieftain Business Park, Morris Close  
Park Farm, Wellingborough, GB - Northants, NN8 6 XF  
Tel.: 0044 / 1933 / 402220 • FAX: 0044 / 1933 / 400724  
Internet: [www.keb-uk.co.uk](http://www.keb-uk.co.uk) • E-mail: [info@keb-uk.co.uk](mailto:info@keb-uk.co.uk)

### **KEB Italia S.r.l.**

Via Newton, 2 • I - 20019 Settimo Milanese (Milano)  
Tel.: 0039 / 02 / 33500782 • FAX: 0039 / 02 / 33500790  
Internet: [www.keb.it](http://www.keb.it) • E-mail: [kebitalia@keb.it](mailto:kebitalia@keb.it)

### **KEB - YAMAKYU Ltd.**

711 Fukudayama, Fukuda  
J - Shinjo-Shi, Yamagata (996-0053)  
Tel.: 0081 / 233 / 29 / 2800 • FAX: 0081 / 233 / 29 / 2802  
E-mail: [kebjs001@d4.dion.ne.jp](mailto:kebjs001@d4.dion.ne.jp)

### **KEB Taiwan Co., Ltd.**

1F, No.19-5, Shi Chou Rd., Tounan Town  
R.O.C. - Yin-Lin Hsian / Taiwan  
Tel.: 00886 / 5 / 5964242 • FAX: 00886 / 5 / 5964240  
E-mail: [keb\\_taiwan@mail.apol.com.tw](mailto:keb_taiwan@mail.apol.com.tw)

### **KEBCO Inc.**

1335 Mendota Heights Road  
USA - Mendota Heights, MN 55120  
Tel.: 001 / 651 / 4546162 • FAX: 001 / 651 / 4546198  
Internet: [www.kebco.com](http://www.kebco.com) • E-mail: [info@kebco.com](mailto:info@kebco.com)