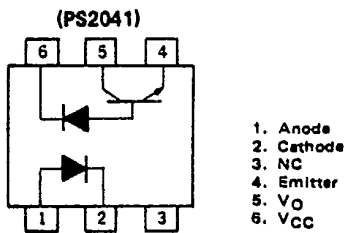
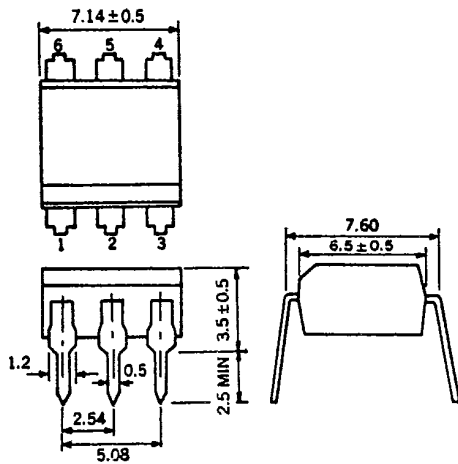

PHOTO COUPLER

PS2041

HIGH SPEED 6PIN PHOTO COUPLER

PACKAGE DIMENSIONS  
(Unit: mm)



FEATURES

- High Speed Response 0.3  $\mu$ s TYP.
- High Isolation Voltage 2500  $V_{r.m.s.}$
- Compact, Dual In-Line Package

APPLICATIONS

1. Interface circuit for various instrumentations, control equipments.
2. Computer and peripheral manufactures.
3. TV sets.

ABSOLUTE MAXIMUM RATINGS ( $T_a = 25^\circ\text{C}$ )

Diode

Forward Current	$I_F$	25	mA
Reverse Voltage	$V_R$	5	V
Power Dissipation	$P_D$	45	mW

Detector

Supply Voltage	$V_{CC}$	-0.5 to 15	V
Output Voltage	$V_O$	-0.5 to 15	V
Output Current	$I_O$	8	mA
Power Dissipation	$P_C$	100	mW
Isolation Voltage*	BV	2500	$V_{r.m.s.}$
Storage Temperature	$T_{stg}$	-55 to +125	$^\circ\text{C}$
Operating Temperature	$T_{opt}$	-55 to +100	$^\circ\text{C}$
Lead Temperature (10 s)		260	$^\circ\text{C}$

\* Condition

AC Voltage for 1 minute at  $T_a = 25^\circ\text{C}$ , RH = 60 %  
between input (pin No. 1, 2, 3, Common) and output (pin No. 4, 5, 6)

PS2041

T-41-83

ELECTRICAL CHARACTERISTICS (T<sub>a</sub> = 25 °C)

CHARACTERISTIC		SYMBOL	MIN.	TYP.	MAX.	UNIT	TEST CONDITIONS
Diode	Forward Voltage	V <sub>F</sub>		1.7	2.2	V	I <sub>F</sub> = 16 mA
	Reverse Current	I <sub>R</sub>		0.01	10	μA	V <sub>R</sub> = 5 V
	Forward Voltage Temperature Coefficient	$\frac{\Delta V_F}{\Delta T}$		-1.6		mV/°C	I <sub>F</sub> = 16 mA
	Capacitance	C <sub>t</sub>		60		pF	V = 0, f = 1 MHz
Detector	High Level Output Current	I <sub>OH</sub> (1)		3	500	nA	I <sub>F</sub> = 0 mA, V <sub>CC</sub> = V <sub>O</sub> = 5.5 V
	High Level Output Current	I <sub>OH</sub> (2)			100	μA	I <sub>F</sub> = 0 mA, V <sub>CC</sub> = V <sub>O</sub> = 15 V
Coupled	Current Transfer Ratio	CTR *	15	22		%	I <sub>F</sub> = 16 mA, V <sub>CC</sub> = 4.5 V, V <sub>O</sub> = 0.4 V
	Low Level Output Voltage	V <sub>OL</sub>		0.1	0.4	V	I <sub>F</sub> = 16 mA, V <sub>CC</sub> = 4.5 V, I <sub>O</sub> = 2.4 mA
	Low Level Supply Current	I <sub>CCL</sub>		50		μA	I <sub>F</sub> = 16 mA, V <sub>O</sub> = Open, V <sub>CC</sub> = 15 V
	High Level Supply Current	I <sub>CCH</sub>		0.01	1	μA	I <sub>F</sub> = 0 mA, V <sub>O</sub> = Open, V <sub>CC</sub> = 15 V
	Isolation Resistance	R <sub>1-2</sub>	10 <sup>11</sup>			Ω	V <sub>in-out</sub> = 1 kVDC
	Isolation Capacitance	C <sub>1-2</sub>		0.7		pF	V = 0, f = 1 MHz
	Propagation Delay Time to Low Output Level	t <sub>PHL</sub> **		0.3	0.8	μs	I <sub>F</sub> = 16 mA, V <sub>CC</sub> = 5 V, R <sub>L</sub> = 1.9 kΩ
Propagation Delay Time to High Output Level	t <sub>PLH</sub> **		(K/L/R) 0.3/1.0/0.8	(K/L/R) 0.8/1.5/1.25	μs	I <sub>F</sub> = 16 mA, V <sub>CC</sub> = 5 V, R <sub>L</sub> = 1.9 kΩ	

- \* CTR rank  
K: 15 % ~  
L: 25 % ~  
R: 20 % ~

\*\* Measuring circuit

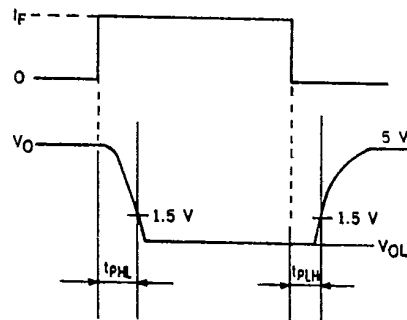
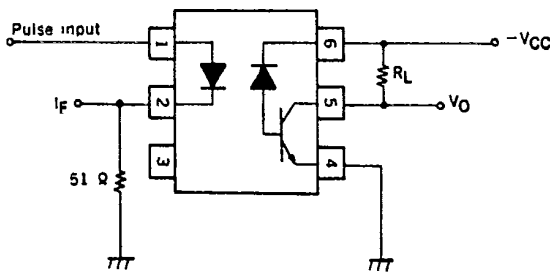

TYPICAL CHARACTERISTICS ( $T_a = 25^\circ\text{C}$ )

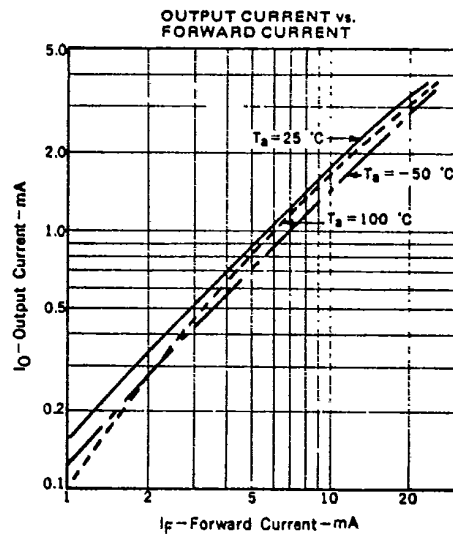
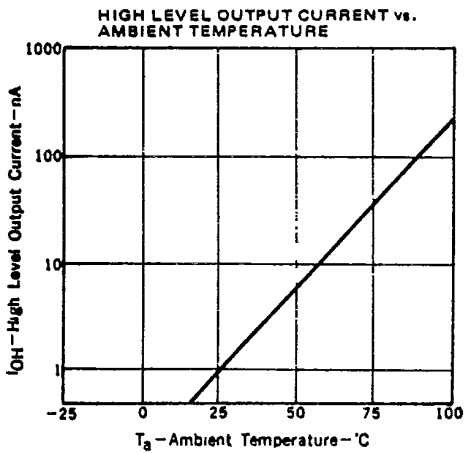
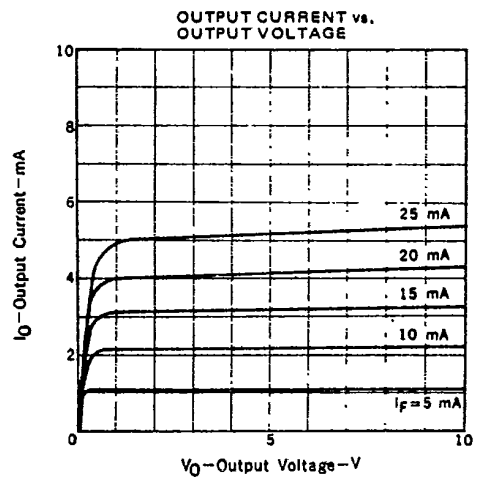
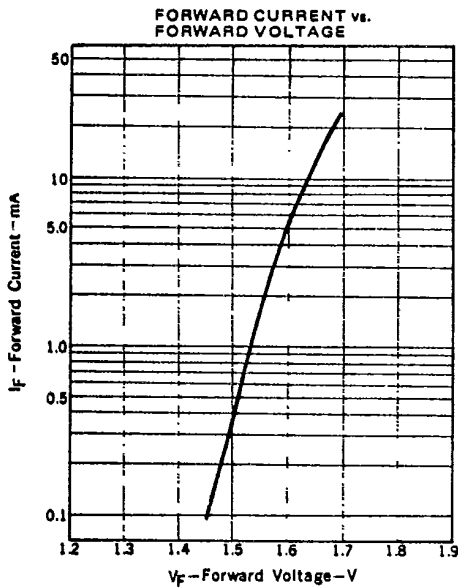
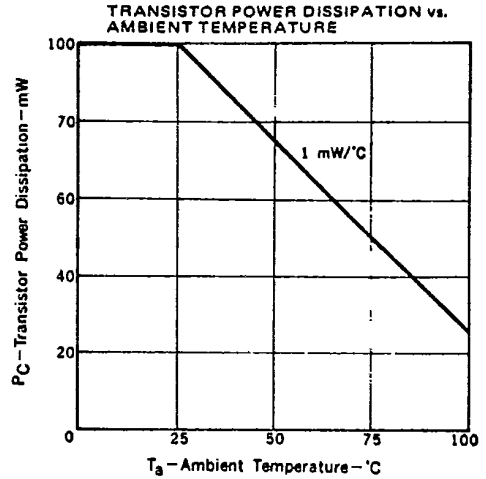
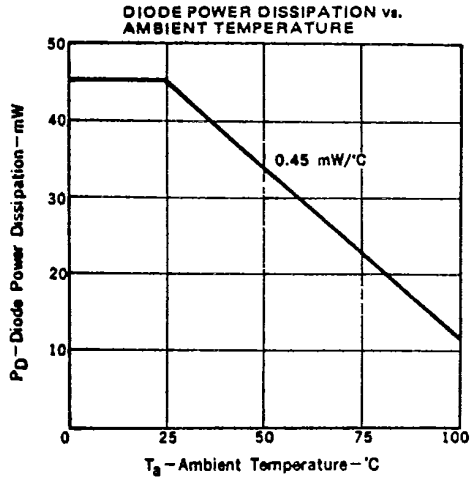

PS2041

T-41-83

