

# SKiiP 23NAB126V1



MiniSKiiP<sup>®</sup> 2

3-phase bridge rectifier +  
brake chopper + 3-phase  
bridge inverter  
SKiiP 23NAB126V1

## Features

- Fast Trench IGBTs
- Robust and soft freewheeling diodes in CAL technology
- Highly reliable spring contacts for electrical connections
- UL recognised file no. E63532

## Typical Applications\*

- Inverter up to 16 kVA
- Typical motor power 7,5 kW

## Remarks

- $V_{CEsat}$ ,  $V_F$  = chip level value

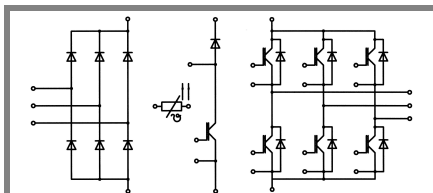

NAB

Absolute Maximum Ratings		$T_s = 25\text{ °C}$ , unless otherwise specified		
Symbol	Conditions	Values	Units	
<b>IGBT - Inverter, Chopper</b>				
$V_{CES}$	$T_s = 25\text{ (70) °C}$	1200	V	
$I_C$		41 (31)	A	
$I_{CRM}$		50	A	
$V_{GES}$		$\pm 20$	V	
$T_j$		- 40 ... + 150	°C	
<b>Diode - Inverter, Chopper</b>				
$I_F$	$T_s = 25\text{ (70) °C}$	30 (22)	A	
$I_{FRM}$		50	A	
$T_j$		- 40 ... + 150	°C	
<b>Diode - Rectifier</b>				
$V_{RRM}$	$T_s = 70\text{ °C}$	1600	V	
$I_F$		46	A	
$I_{FSM}$		$t_p = 10\text{ ms, sin } 180\text{ °, } T_j = 25\text{ °C}$	370	A
$i^2t$		$t_p = 10\text{ ms, sin } 180\text{ °, } T_j = 25\text{ °C}$	680	A <sup>2</sup> s
$T_j$		- 40 ... + 150	°C	
<b>Module</b>				
$I_{tRMS}$	per power terminal (20 A / spring)	40	A	
$T_{stg}$		- 40 ... + 125	°C	
$V_{isol}$	AC, 1 min.	2500	V	

Characteristics		$T_s = 25\text{ °C}$ , unless otherwise specified			
Symbol	Conditions	min.	typ.	max.	Units
<b>IGBT - Inverter, Chopper</b>					
$V_{CEsat}$	$I_{Cnom} = 25\text{ A, } T_j = 25\text{ (125) °C}$		1,7 (2)	2,1 (2,4)	V
$V_{GE(th)}$	$V_{GE} = V_{CE}, I_C = 1\text{ mA}$	5	5,8	6,5	V
$V_{CE(TO)}$	$T_j = 25\text{ (125) °C}$		1 (0,9)	1,2 (1,1)	V
$r_T$	$T_j = 25\text{ (125) °C}$		28 (44)	36 (52)	mΩ
$C_{ies}$	$V_{CE} = 25\text{ V, } V_{GE} = 0\text{ V, } f = 1\text{ MHz}$		1,8		nF
$C_{oes}$	$V_{CE} = 25\text{ V, } V_{GE} = 0\text{ V, } f = 1\text{ MHz}$		0,3		nF
$C_{res}$	$V_{CE} = 25\text{ V, } V_{GE} = 0\text{ V, } f = 1\text{ MHz}$		0,2		nF
$R_{th(j-s)}$	per IGBT		0,9		K/W
$t_{d(on)}$	under following conditions		85		ns
$t_r$	$V_{CC} = 600\text{ V, } V_{GE} = \pm 15\text{ V}$		30		ns
$t_{d(off)}$	$I_{Cnom} = 25\text{ A, } T_j = 125\text{ °C}$		465		ns
$t_f$	$R_{Gon} = R_{Goff} = 30\text{ Ω}$		100		ns
$E_{on}$	inductive load		3,5		mJ
$E_{off}$			3		mJ
<b>Diode - Inverter, Chopper</b>					
$V_F = V_{EC}$	$I_{Fnom} = 25\text{ A, } T_j = 25\text{ (125) °C}$		1,8 (1,8)	2,1 (2,2)	V
$V_{(TO)}$	$T_j = 25\text{ (125) °C}$		1 (0,8)	1,1 (0,9)	V
$r_T$	$T_j = 25\text{ (125) °C}$		32 (40)	40 (52)	mΩ
$R_{th(j-s)}$	per diode		1,7		K/W
$I_{RRM}$	under following conditions		33		A
$Q_{rr}$	$I_{Fnom} = 25\text{ A, } V_R = 600\text{ V}$		5,7		μC
$E_{rr}$	$V_{GE} = 0\text{ V, } T_j = 125\text{ °C}$		2,5		mJ
	$di_F/dt = 1140\text{ A/μs}$				
<b>Diode - Rectifier</b>					
$V_F$	$I_{Fnom} = 25\text{ A, } T_j = 25\text{ °C}$		1,1		V
$V_{(TO)}$	$T_j = 150\text{ °C}$		0,8		V
$r_T$	$T_j = 150\text{ °C}$		13		mΩ
$R_{th(j-s)}$	per diode		1,25		K/W
<b>Temperature Sensor</b>					
$R_{ts}$	3 %, $T_r = 25\text{ (100) °C}$		1000(1670)		Ω
<b>Mechanical Data</b>					
w			65		g
$M_s$	Mounting torque	2		2,5	Nm

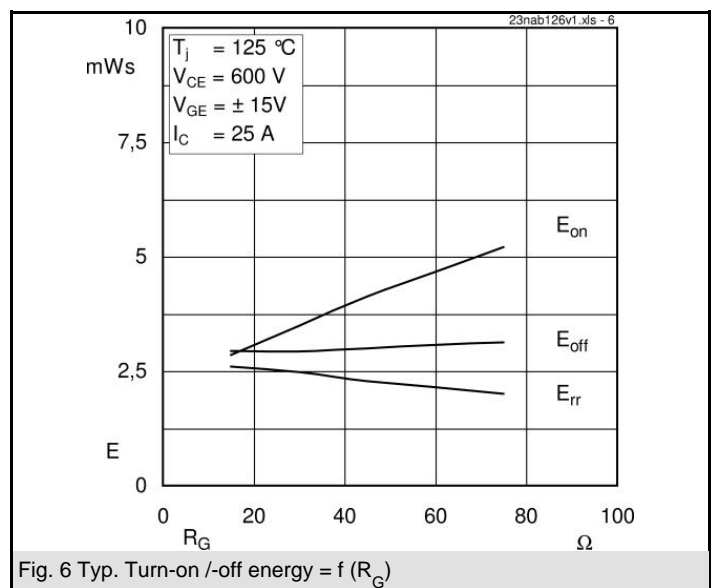
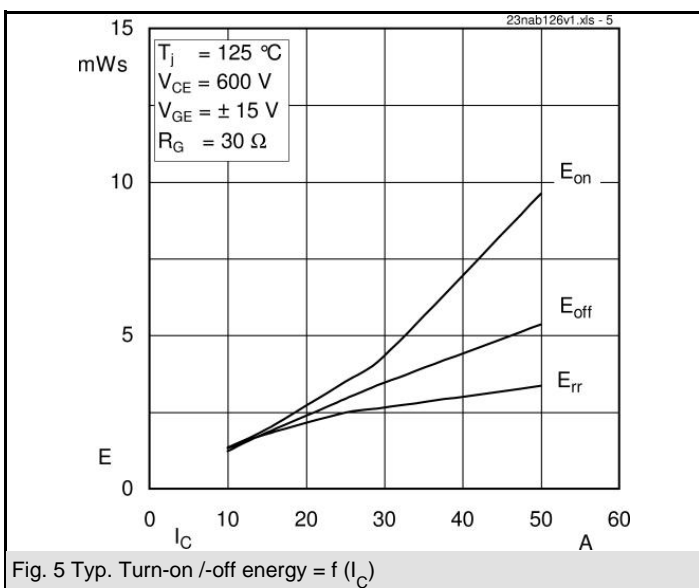
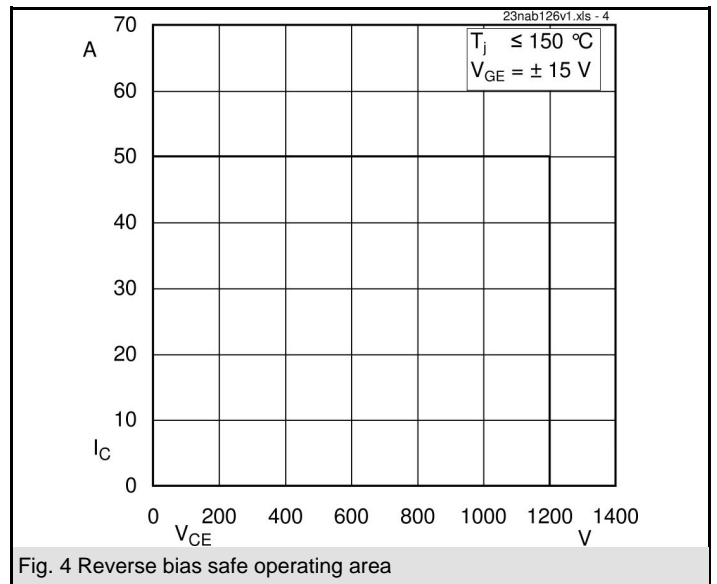
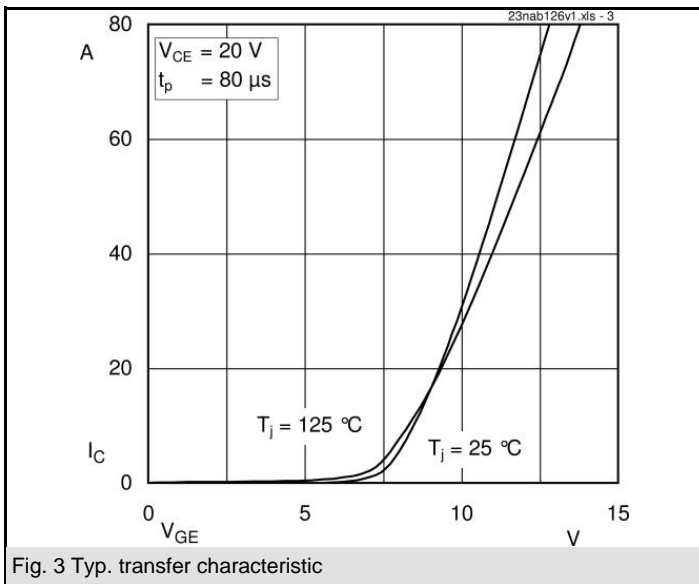
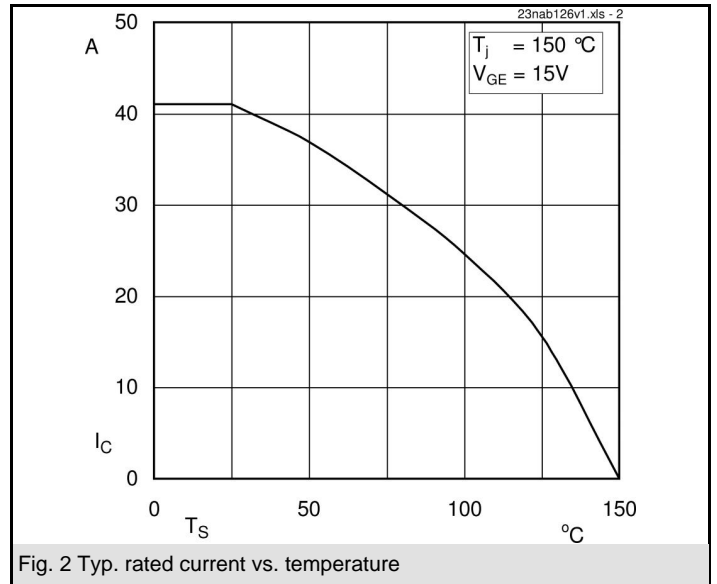
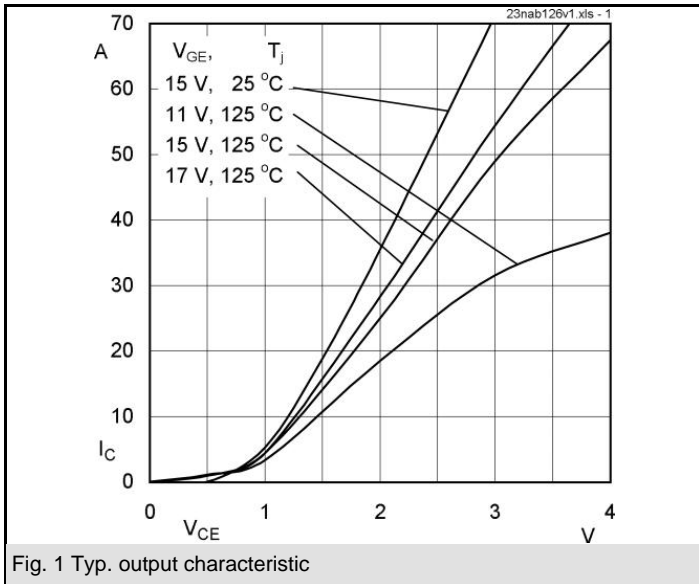

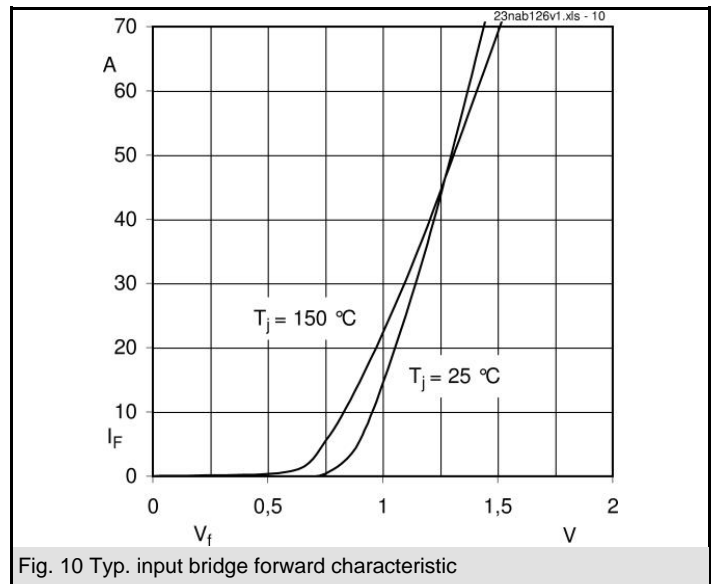
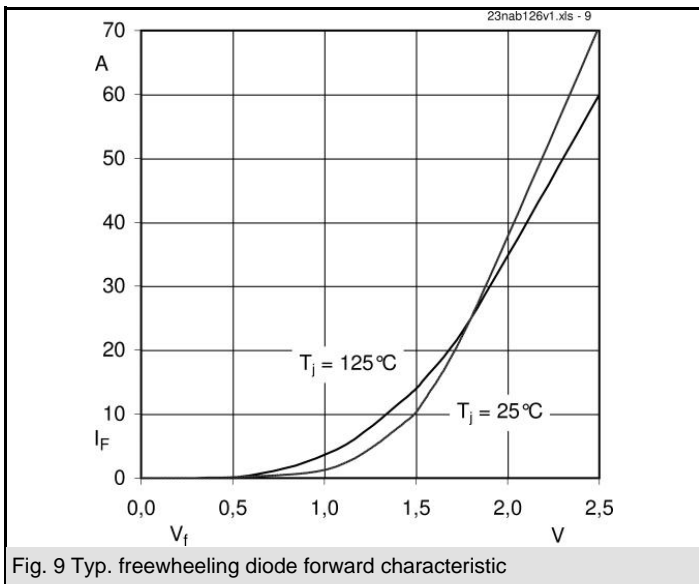
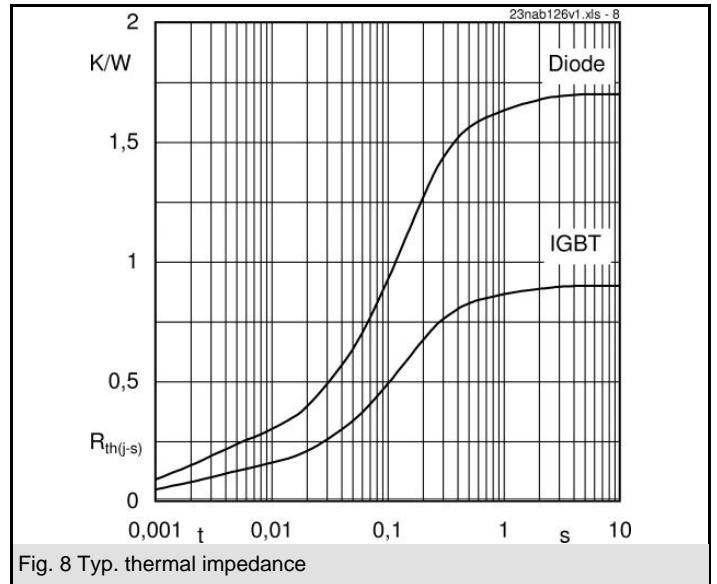
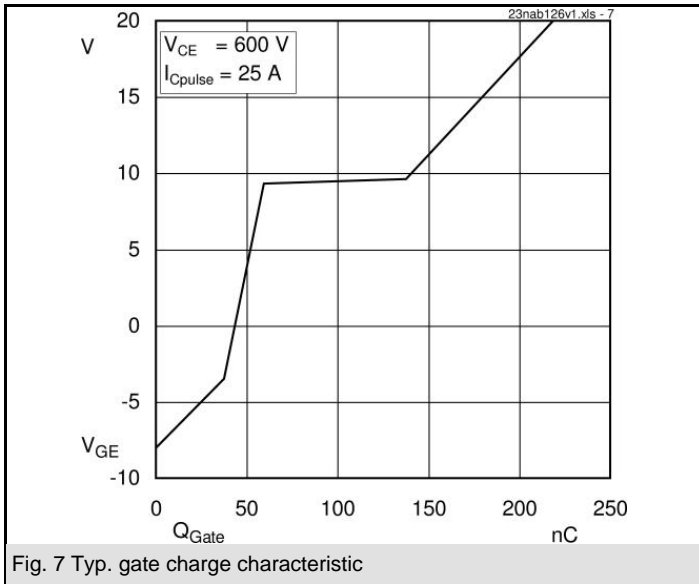

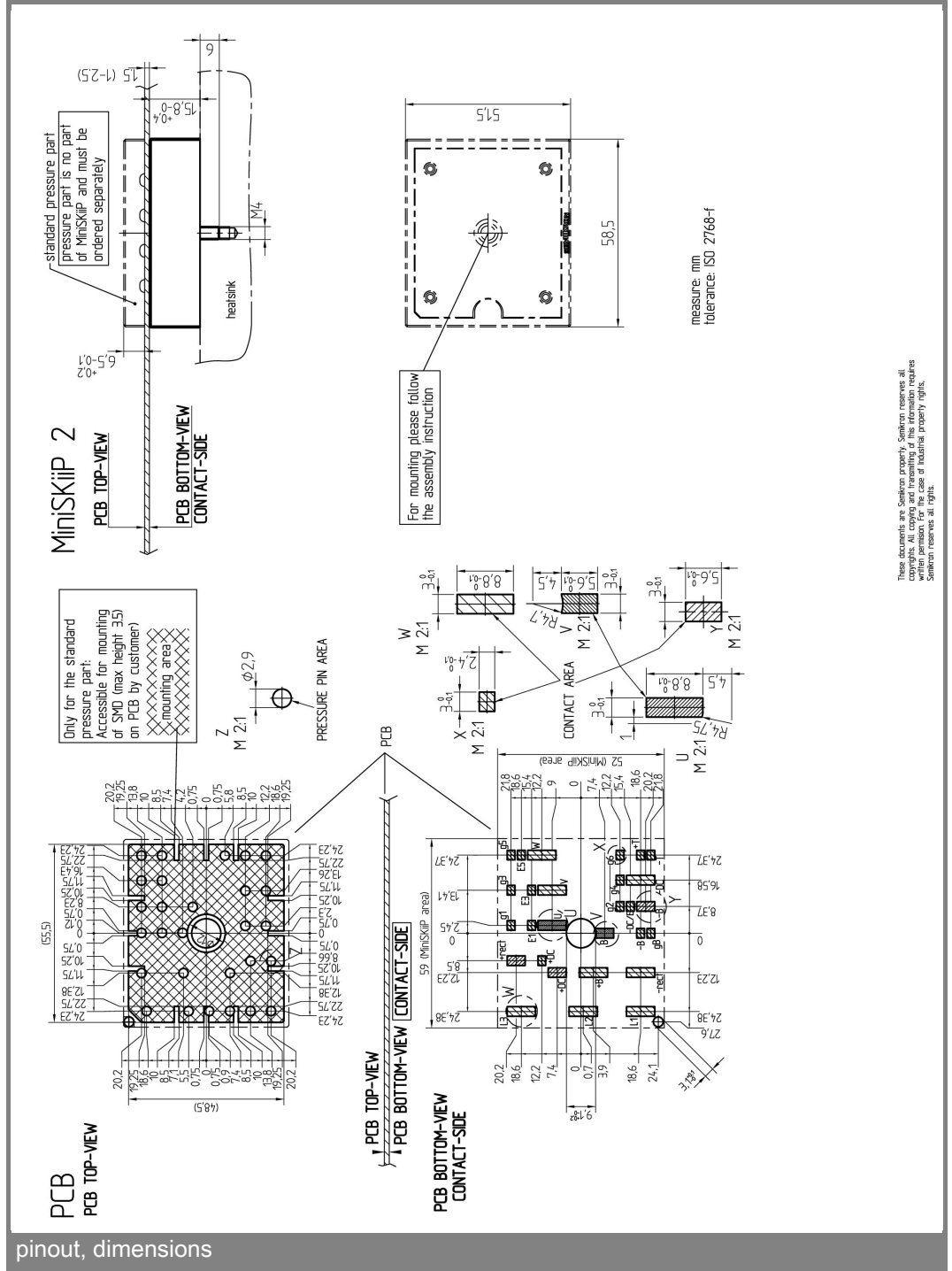
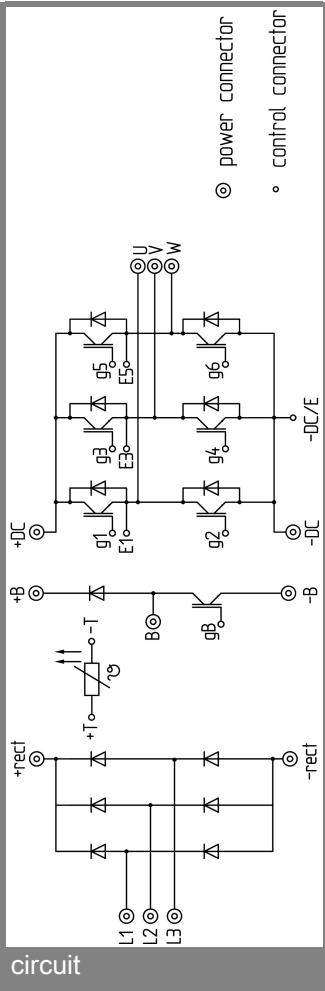

This is an electrostatic discharge sensitive device (ESDS), international standard IEC 60747-1, Chapter IX.

\* The specifications of our components may not be considered as an assurance of component characteristics. Components have to be tested for the respective application. Adjustments may be necessary. The use of SEMIKRON products in life support appliances and systems is subject to prior specification and written approval by SEMIKRON. We therefore strongly recommend prior consultation of our personal.