

SIEMENS

Programmable Controller S5 110S/B

E811 - STANDEXEMPLAR

Manual

Order No. 6ES5 998-0SA22

Issue 2

Contents

Order No.

Operating Instructions

GWA - 4NEB 807 2121-02

Programming Instructions

GWA - 4NEB 807 2122-02

Operating Instructions

Programming Instructions

SIEMENS

SIMATIC S5

SIMATIC S5–110S/B Programmable Controller

Operating Instructions

SIEMENS

SIMATIC S5-110S/B Programmable Controller

6ES5 110

Operating Instructions

Order No. GWA 4NEB 807 2121-02

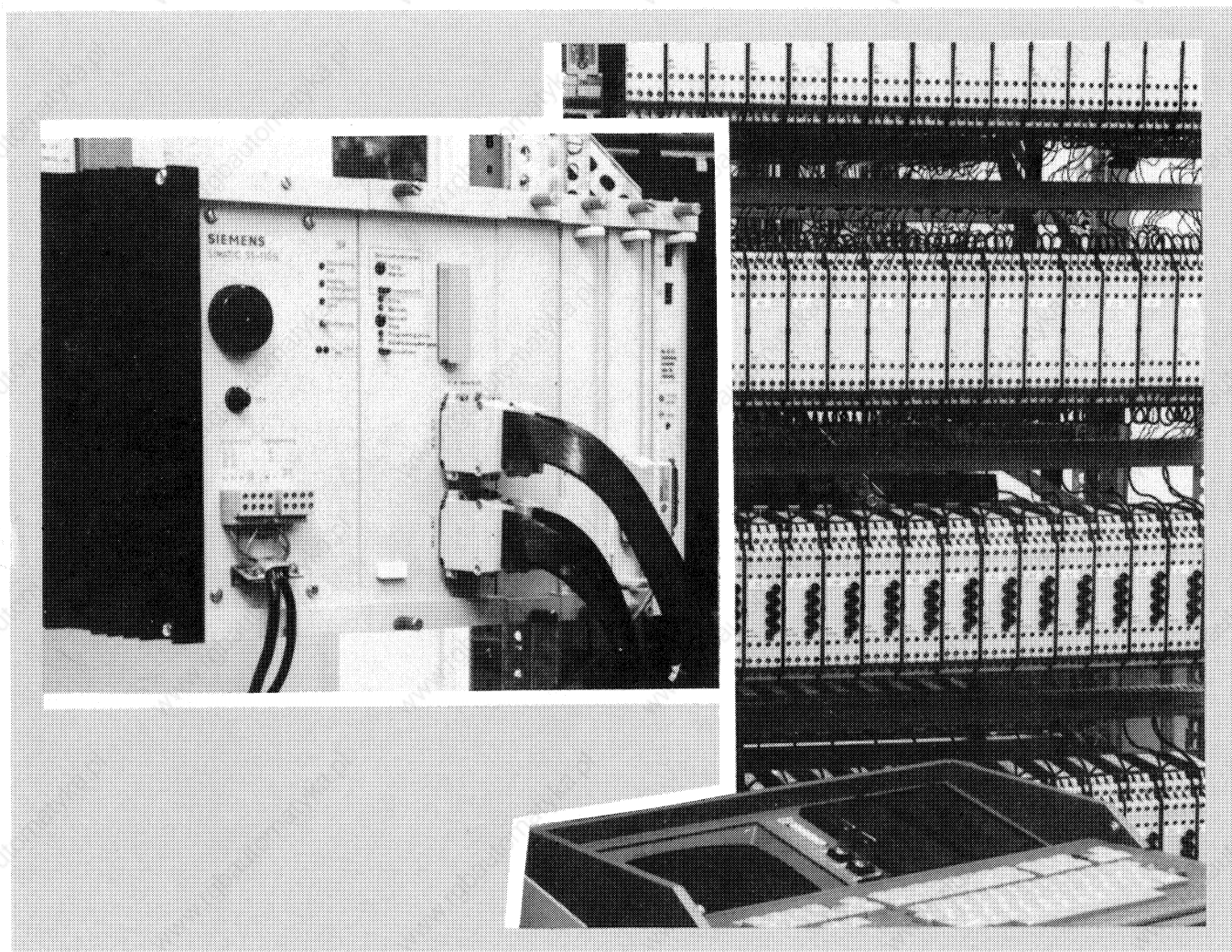

Fig. 1 S5-110S programmable controller. On the left: Central controller. On the right: I/O modules. In the foreground: the 670 programming unit.

1. Description

1.1 Application

1.2 Construction

Contents

Contents	Page		
1. Description	2	2.2.5 Digital compact I/O modules	14
1.1 Application	2	2.2.6 Analog compact I/O modules	14
1.2 Construction	2	2.2.7 302 serial I/O interface module	15
1.3 Principle of operation	3	2.2.8 MC210 monitor interface module	15
1.4 Technical specification	6	2.3 Digital input/output modules	15
1.4.1 General data of the S5-110S PC	6	3. Operation	18
1.4.2 Power supply unit	6	3.1 Power supply (PS)	18
1.4.3 CPU/memory submodule	7	3.2 CPU	20
1.4.4 511/512 interface module and 340/350 memory module	7	4. Maintenance and repairs	22
1.4.5 Digital/analog compact I/O modules, 302 serial I/O interface module and 210 monitor interface module	8	4.1.1 S5-110S fault diagnosis	22
1.4.6 I/O modules (digital input/output modules)	8	4.1.2 Interrupt analysis	23
2. Installation	11	4.1.3 Interrupt stack	24
2.1 General	11	4.1.4 System parameters	25
2.2 Central controller	11	4.2 Connector pin assignments in the central controller backplane	26
2.2.1 Power supply	12	4.3 Connector pin assignments of the 110 bus	28
2.2.2 CPU/memory submodule	13	5. Spare parts	29
2.2.3 Interface module 511 and 512C	13	6. Maximum I/O configuration	30
2.2.4 340/350 memory module	14		

1.1 Application

The 110S programmable controller (PC) is part of the SIMATIC S5 System.

It is designed for automation tasks in the middle and upper performance ranges. The degree of expansion and the range of functions are matched to the typical requirements in these ranges.

The PC can be easily adapted to the required tasks on account of its expandability.

Combination with other SIMATIC programmable controllers and hard-wired controllers is possible.

1.2 Construction

The 110S is available in various basic versions and can be equipped with different power supply units (220 V AC/240 V AC, 115 V AC or 24 V DC). The programmable controller is designed for operation without fans.

The modules are accommodated in a rugged housing, which can be mounted without difficulty in electronic cabinets and which is also suitable for wall mounting. The modules are interconnected via the flow-soldered backplane PCB located in the rear wall of the housing. Connectors with 48 or 64 pins are used in the backplane PCB.

The programmable controller uses the familiar digital input/output modules of the 110 A PC range. These modules are available in 24 V AC/DC, 48 V AC/DC, 115 V AC and 220 V AC versions and contain either 8 inputs or 8 outputs each. The modules are mounted on a separate mounting rack and controlled directly from the CPU.

In addition, module locations 3, 4, 5 or 6 of the central controller in Fig. 3 can also be used for digital/analog peripheral I/O modules (compact version 20 mm wide), the 302 serial peripheral interface module and the MC210 monitor interface module.

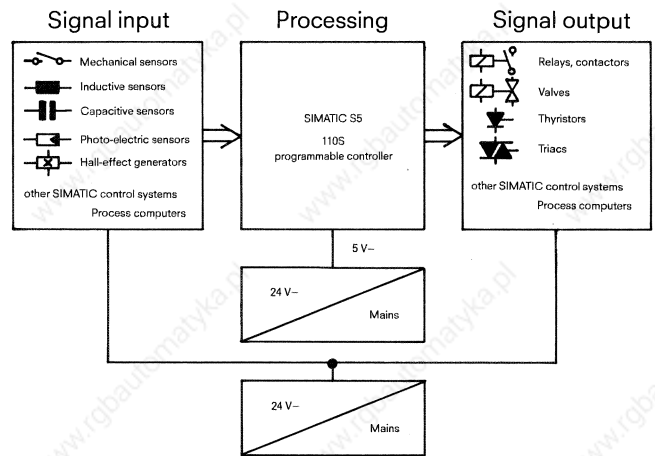

Fig. 2 Application of the S5-110S programmable controller

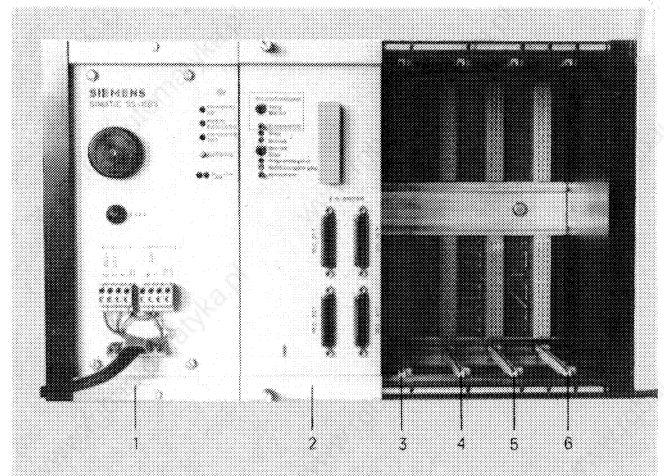

Fig. 3 S5-110S central controller (equipped with power supply unit and CPU module)

- 1 Power supply (PS) (220 V AC/240 V AC; 115 V AC or 24 V DC)
- 2 CPU
- 3 Test module
- 4 Memory module 340 (RAM) or 350 (RAM/EPROM)
- 5 PU interface module 511
- 6 Interface module 512C

1. Description

1.3 Principle of operation

110S Programmable controller

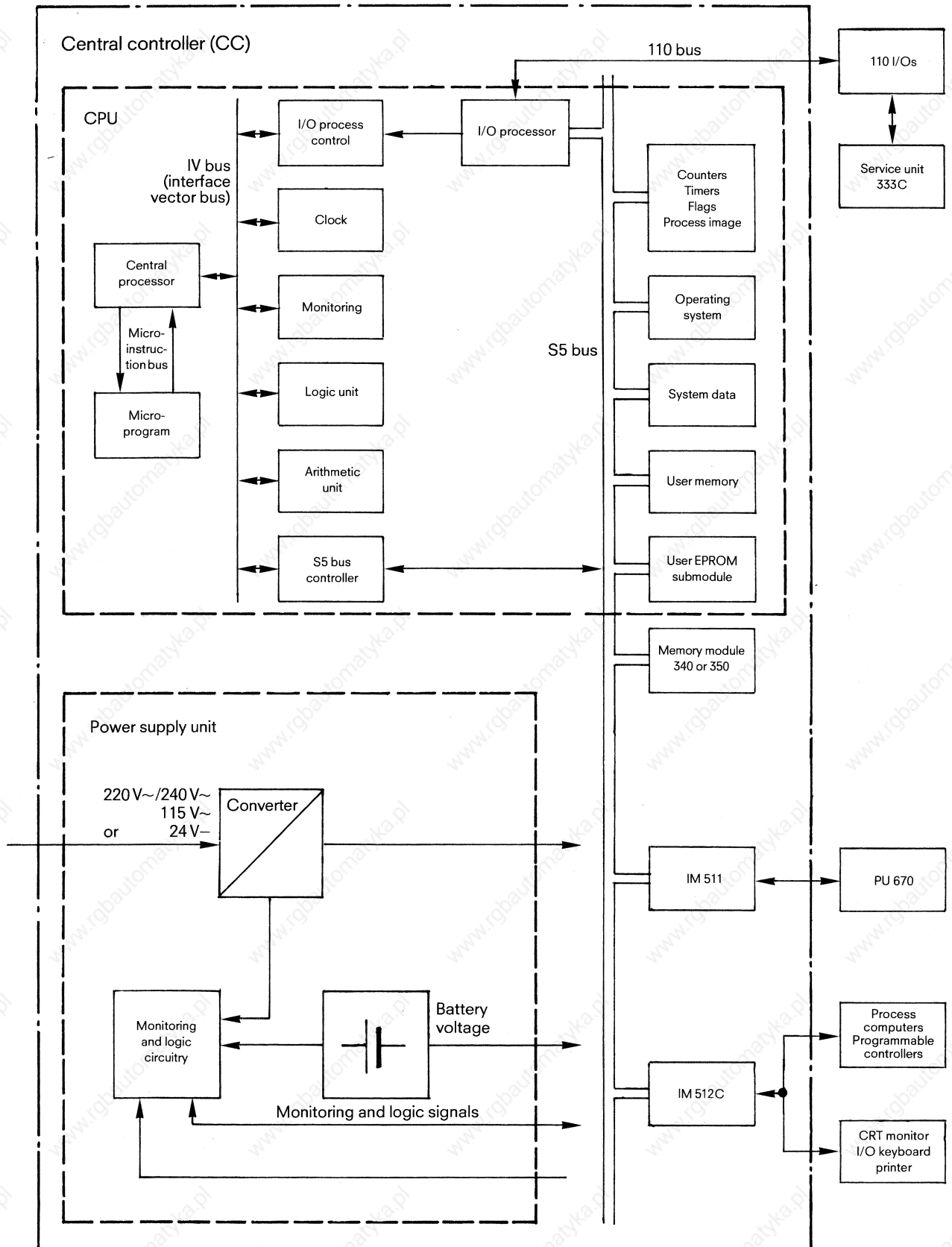

Fig. 4 Block diagram of the S5-110S programmable controller

1. Description

1.3 Principle of operation

S5 bus:	For exchanging data within the CPU and between the CPU and the various interface modules.	Interface module 512C:	Used for connecting up 4 external units: a) SIMATIC S5 programmable controllers b) Terminals c) Process computers d) Keyboard printers
IV bus:	Input/output bus of the microprocessor.		
Microbus:	Used for controlling the central processor.		
110 bus:	Input/output bus connecting the I/O processor and the digital input/output modules.	PU interface module 511:	For connecting the 670/675 programming unit.
User EPROM module:	Contains the user program (2K, 4K or 8K statements, EPROM)	PU 670C/675:	The 670/675 is a very powerful video programming unit. It is used for programming and debugging all SIMATIC S5 programmable controllers. The user can program in ladder diagram, control system flow-chart or statement list representations.
User memory:	Contains the user program (½K statements, RAM)	Monitoring and logic in the PS:	For monitoring the external and internal voltages.
Blocks:	128 program blocks 48 function blocks 63 data blocks (without DB0)	I/O modules 110:	A max. of 128 input and output modules each with 8 inputs or outputs can be connected.
I/O processor:	The I/O processor scans the digital inputs/outputs and transfers the contents to the central processor and also sets the digital outputs as required by the CPU.	Service unit 333C:	Used for testing the 110S PC. The following functions are possible: Output of data, timer and counter values. Input of data, timer and counter values. Signal state display of inputs, outputs and flags. (The user program of the PC cannot be modified with the service unit). The service unit is connected to the PC via digital inputs and outputs.
CPU and microprogram:	Decoding and execution of the STEP 5 statements.		
Flags:	1K bits retentive, 1K bits non-retentive		
Process image:	Signal state of the digital inputs and outputs stored in memory.		
Timers:	128 integrated timers.		
Counters:	128 integrated counters.		
Monitor:	Monitors faults such as acknowledgement delay (time-out) or cycle time exceeded.		
Memory module: 340 or 350 (with battery backup)	Data expansion and extension of user program. RAM module 340; 8 or 16K statements RAM/EPROM module 350; 4K statements (RAM) and 2 to 12K statements (EPROM)		

1. Description

1.3 Principle of operation

Function diagram

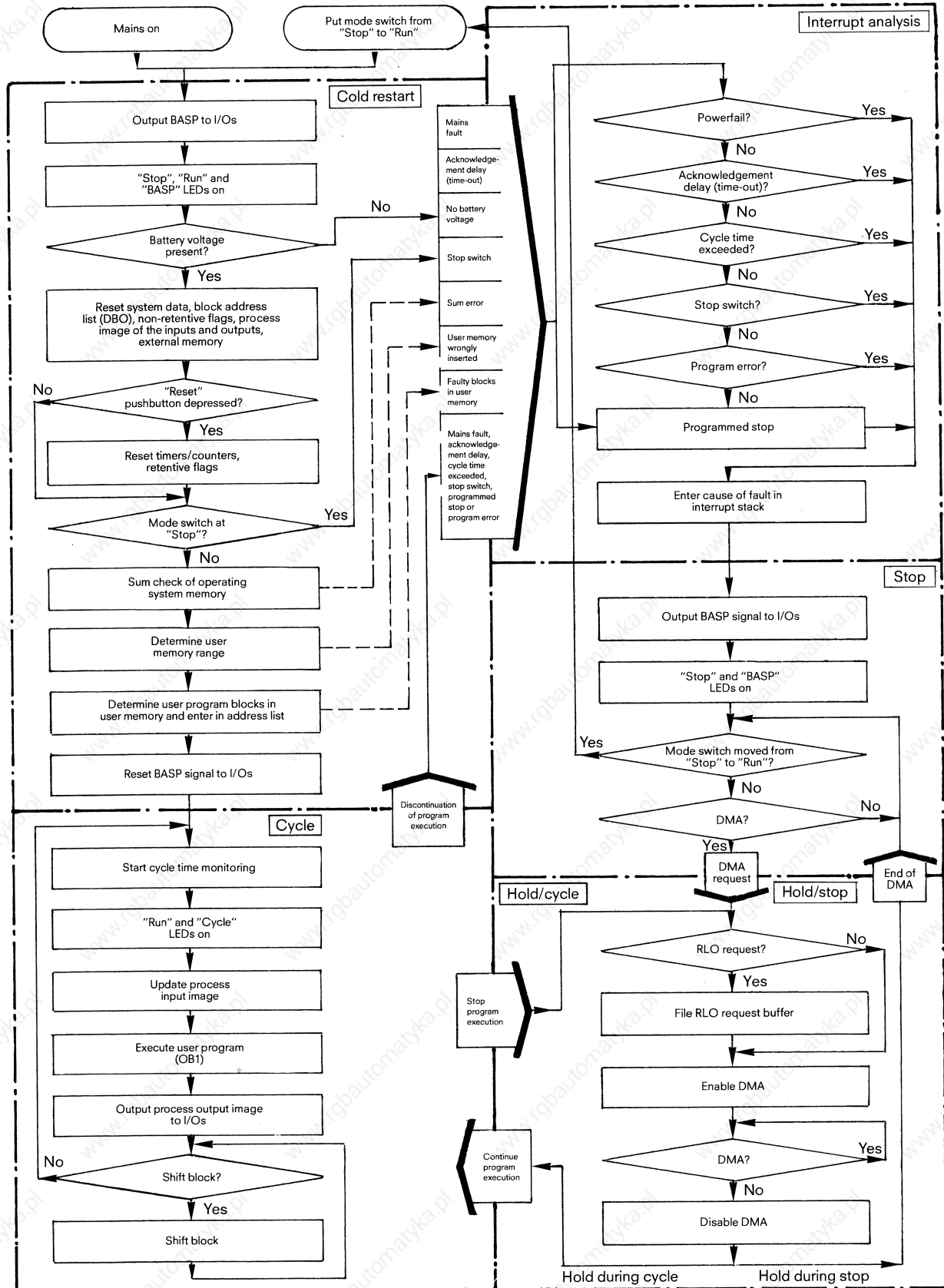

1. Description

1.4 Technical specification

1.4 Technical specification

1.4.1 General data of the 110S programmable controller

Input voltage: a) 220 V/240 V AC (+10%, -15%)
 b) 115 V AC (+10%, -15%)
 c) 24 V DC (+25%, -17%)

Current input: a) 0.6 A at 220 V AC
 b) 1.2 A at 115 V AC
 c) 3.2 A at 24 V DC

Ambient temperature: According to SN 26556 B, the air intake temperature can be 0 to 55°C (5°C derating per 1000 m altitude difference); storage temperature: -40 to +70°C.

Humidity rating: F to DIN 40040 (95% relative humidity at 25°C).

Degree of protection: IP 20 to DIN 40050.

Shock test: to SN 29010, class 13.

Frequency range Hz	Constant amplitude of the displacement	
	displacement	acceleration
10 to 58	0.15 mm	
over 58 to 500		2 g

Shock test: 15 g/11 ms, trapezoidal to DIN 40046, Section 7.

All parts of the central controller are connected galvanically to each other. In order to achieve effective electromagnetic shielding, all the parts are connected to each other through low resistance paths. I/O modules are galvanically isolated.

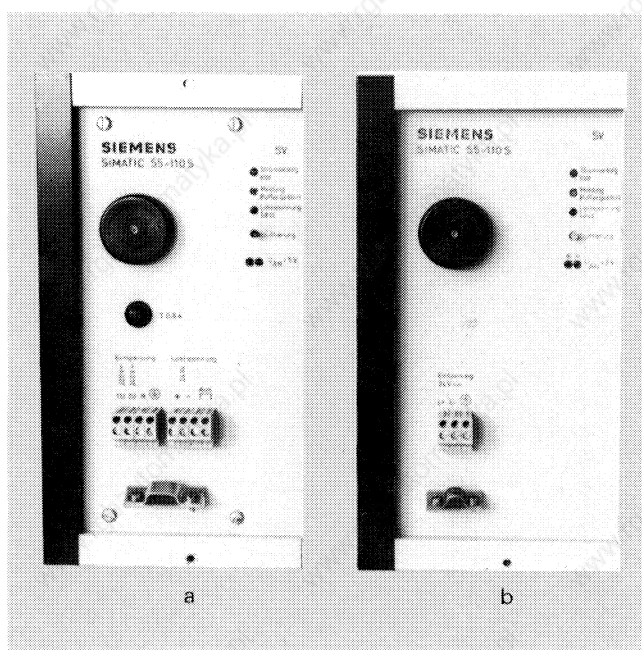

Fig. 5 Power supply units a) 220 V AC/240 V AC b) 24 V DC

1.4.2 Power supply unit with housing

Power supply	6ES5 932-3SA12	6ES5 932-3SA22	6ES5 932-3SA32
Input voltage	220 V AC or 240 V AC	115 V AC	24 V DC
Tolerance of the input voltage	+10%, -15%	+10%, -15%	+25%, -17%
Permissible mains frequency range	48 to 63 Hz	48 Hz to 63 Hz	-
Current input for rated load	0.6 A	1.2 A	3.2 A
Max. input current	approx. 0.9 A	approx. 1.8 A	3.3 A
Fuse	0.8 A	1.6 A	-
Output voltage	+5 V DC ±1%	+5 V DC ±1%	+5 V DC ±1%
Rated current I_{AN}	10 A	10 A	10 A
Maximum output power	50 W	50 W	50 W
Overvoltage protection	6 V DC +4%	6 V DC +4%	6 V DC +4%
Current limiting	$1.05 \times I_{AN}$	$1.05 \times I_{AN}$	$1.05 \times I_{AN}$
Galvanic isolation between input and output circuits	yes	yes	no
Back-up battery	Lithium	Lithium	Lithium
Battery voltage	approx. +3.4 V DC/5 Ah	approx. +3.4 V DC/5 Ah	approx. +3.4 V DC/5 Ah
Life of back-up battery	6 years	6 years	6 years
Back-up period	1 year at 25°C	1 year at 25°C	1 year at 25°C
Connection for monitoring the 24 V DC load voltage	yes	yes	no
Weight of the PSU with housing	9.5 kg	9.5 kg	6.7 kg

1. Description

1.4 Technical specification

1.4.3 CPU / Memory submodule

DC voltage supply: +5 V +1 %

Current input typ.: 1.6 A
max: 2.6 A

Current input of the user memory:
with 2K statements max. 160 mA
with 4K statements max. 185 mA
with 8K statements max. 235 mA

Current input during back-up operation: typ. 2 μ A
max. 128 μ A

Execution time for a binary statement: < 8 μ s

Bus driver (110 bus): designed for driving max. 64 input/output modules

Range of operations: 45 binary statements
13 block call and jump statements
14 timer and counter statements
27 load and transfer statements
16 organizational statements
21 digital substitution statements
17 logical and arithmetic statements

Addressing range: max. 512 inputs/outputs
1024 retentive flags (0.0 ... 127.7)
1024 non-retentive flags (128.0 ... 255.7)
128 integrated timers each with one of 4 optional time bases
0.01 s
0.1 s
1 s
10 s
Time base 0 ... 999
128 integrated counters from 0 ... 99

Memory: 1K statements for operating system
 $\frac{1}{2}$ K statements user RAM
1 EPROM memory submodule for the user program consisting of:
1 \times 2532 up to 2K statements
2 \times 2532 up to 4K statements
4 \times 2532 up to 8K statements

Weight: approx. 1100 g

1.4.4 511/512 interface module and 340 or 350 memory module

a) PU interface module 511

DC supply voltage: +5 V
Current input (typical): 1.7 A
Weight: approx. 300 g

b) Interface module 512C

DC supply voltage: +5 V
Current input (typical): 1.6 A
Weight: approx. 300 g

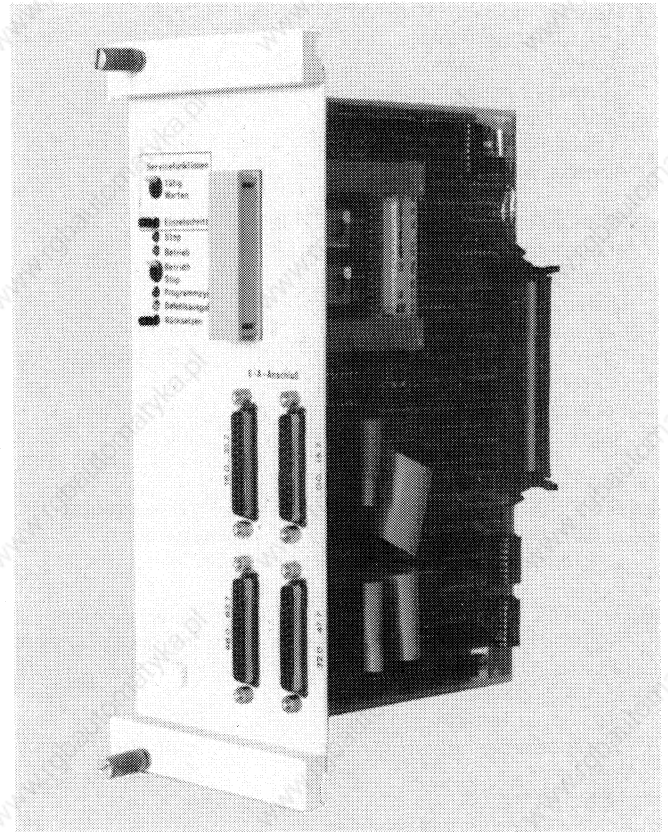

Fig. 6 CPU

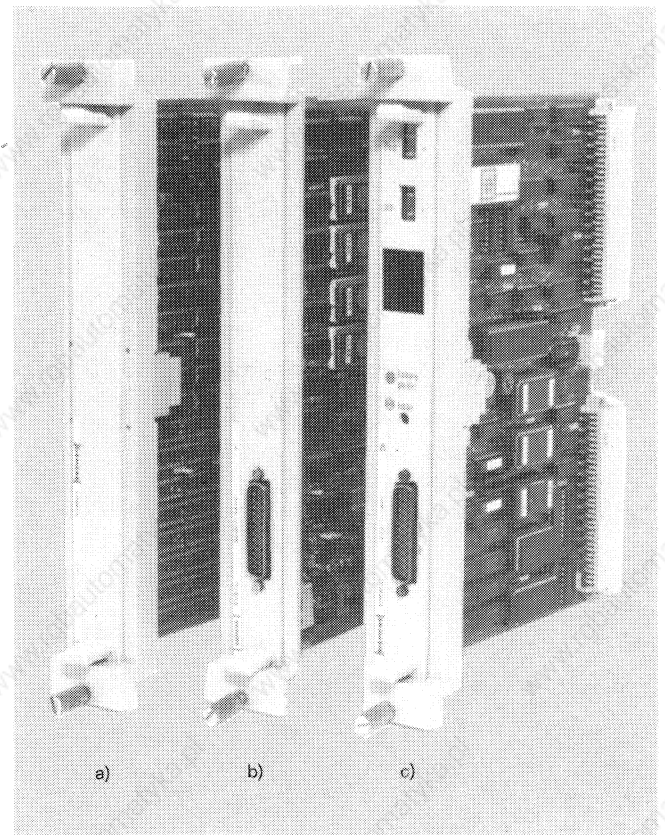

Fig. 7 a) 340 memory module, b) 511 PU interface module, c) 512C interface module

1. Description

1.4 Technical specification

- c) Memory module 340 (RAM)
8 or 16K statements
DC supply voltage: +5 V
Current consumption (typ.): 0.8 or 0.9 A
Current consumption in backup operation: max. 0.6 or 1 mA
Approx. weight: 300 g

- d) Memory module 350 (RAM/EPROM)
4K statements (RAM) and 2K to 12K statements (EPROM)
DC supply voltage: +5 V
Current consumption: max. 1.4 A
(memory submodule 370/371: 0.27 A each)
Current consumption in backup operation: max. 0.3 mA
Approx. weight: 300 g

1.4.5 Digital/analog compact peripheral I/O modules, 302 serial peripheral interface module and 210 monitor interface module

- a) Digital I/O compact modules (only 20 mm wide)
Digital I/O compact modules with 16 to 32 inputs/outputs (also as mix) can be plugged into locations 3, 4, 5 or 6 in the central controller (Fig. 3).
DC supply voltage: 5 V
Current consumption: approx. 0.2 A
Weight: approx. 200 g

- b) Analog I/O compact modules
Analog I/O compact modules with 4 to 16 input/output channels can be plugged into locations 3, 4, 5 or 6 in the central controller (Fig. 3).
DC supply voltage: 5 V
Current consumption: approx. 0.3 A
Weight: approx. 200 g

- c) 302 serial peripheral interface module
The 302 interface module can be plugged into locations 3, 4, 5 or 6 in the central controller (fig. 3). However, only one expansion unit (EU182) may be connected to each connector.
DC supply voltage: 5 V
Current consumption: 2 A
Weight: approx. 300 g

- d) 210 monitor interface module
The 210 monitor interface module from the ESU902 packaging system can be plugged into location 3 in the central controller (Fig. 3). The image memory is a 2K byte RAM.
DC supply voltage: +5 V
Current consumption: 1.2 A
Weight: approx. 200 g

1.4.6 I/O modules (digital inputs/outputs)

The following I/O modules are available:

Input modules

Output modules

(Dimensions H×W×D: 166 mm × 40 mm × 150 mm)

The input/output modules described on the following pages are identical to those of the 110 A PC.

The modules are snapped onto a mounting rack. This consists of a 75 mm high standard sectional rail with either ten or eighteen socket connectors wired up to the 110 bus.

The socket connectors for the input/output modules are wired according to their mounting locations, i.e. a module on the first I/O mounting location has the address 0 (see diagram on p. 30).

The modules are simply snapped onto the module mounting rail. This simultaneously establishes the electrical connection between the module and the socket connector.

The maximum I/O configuration consists of 16 racks each with 8 module locations or 8 racks each with 16 module locations.

Each input/output module has 8 inputs or 8 outputs.

Five different versions of the digital input module are available:

- a) 24 V DC
- b) 24 V DC with interrupt processing (group signal)
- c) 48 V AC/DC
- d) 115 V AC
- e) 220 V AC

Digital output modules are available in five different versions:

- a) 24 V DC 2 A
- b) 48 V DC 2 A
- c) 24 V AC/48 V AC 2 A
- d) 115 V AC 2 A
- e) 220 V AC 2 A

The signals in the input/output modules are galvanically isolated by opto-couplers. The signal states of the inputs or outputs are indicated on the front of the modules by light-emitting diodes.

SIMATIC S5-110 input/output modules,
1024 inputs/outputs (max.)

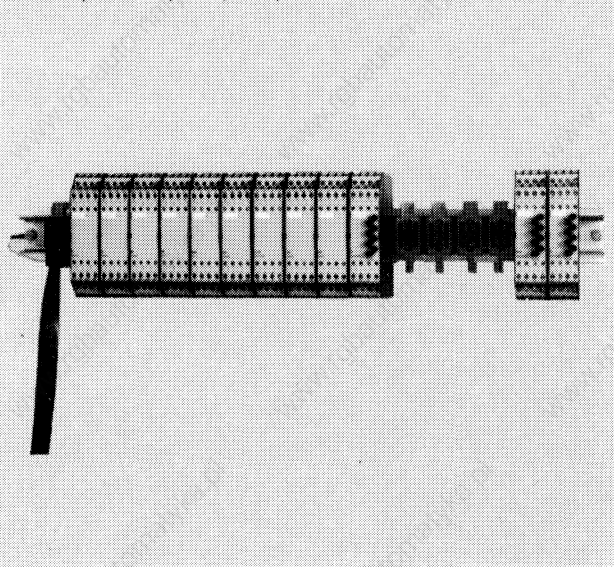

Fig. 8 I/O modules

1. Description

1.4 Technical specification

Digital input modules	6ES5 400-7AA13	6ES5 401-7AA13	6ES5 405-7AB11	6ES5 405-7AB21	6ES5 405-7AB31
Number of inputs	8	8 (with group signal)	8	8	8
Galvanic isolation	yes		yes	yes	yes
Input voltage U_N	24 V DC		115 V AC/DC	220 V AC/DC	48 V AC/DC
Input voltage corresponding to – "0" signal – "1" signal	–35 V to +4.5 V +13 V to +35 V		0 to 40 V AC/DC 85 V AC/DC to 132 V AC/DC	0 to 70 V AC/DC 170 V AC/DC to 264 V AC/DC	0 to 18 V AC/DC 38 V AC/DC to 65 V AC/DC
Input current at "1" signal – connectable proximity switches	8.5 mA	8.5 mA	10 mA AC, 5.7 mA DC	15 mA AC, 2.4 mA DC	13 mA AC, 12 mA DC
Delay on signal change – ON: "0" → "1" – OFF: "1" → "0"	1.5 ms to 5 ms 1.5 ms to 5 ms		2.3 ms to 13 ms 2.0 ms to 20 ms		
Total load capability at 1.2 U_N	100% referred to sum of currents of all inputs		75% referred to sum of currents of all inputs		
Max. permissible length of leads – in common cable (multi-core cables) max.	1000 m at 24 V/48 V AC/DC 100 m at 115 V AC 50 m at 220 V AC		100 m at 24 V/48 V AC/DC 500 m at 115 V AC/DC 250 m at 220 V AC/DC	50 m at 24 V/48 V AC/DC 100 m at 115 V AC 500 m at 220 V AC	800 m at 24 V/48 V AC/DC 400 m at 115 V AC 200 m at 220 V AC
– with cables run separately max.	600 m		600 m		
Insulation voltage to VDE 0160 – for rated value – tested with	Internal 5 V voltage to external input voltage: 36 V DC 500 V AC		Inputs/outputs of one module with respect to each other 250 V AC/DC 2000 V AC		
Weight approx.	0.39 kg		0.4 kg		

The 24 V DC input module with interrupt can be mounted in locations 0, 16, 32 or 48. These input modules supply a group signal to the CPU when the signal state on an input changes from "0" to "1" or vice versa (can be switched on the input module via two externally accessible switches for each group of four inputs).

1. Description

1.4 Technical specification

Digital output modules, static	6ES5 410-7AA11	6ES5 410-7AA21	6ES5 415-7AB11	6ES5 415-7AB21	6ES5 415-7AA31
Number of outputs	8	8	8	8	8
Galvanic isolation	yes	yes	yes	yes	yes
Supply voltage U_s – rated value – permissible range	24 V DC 3 V DC to 33 V DC	48 V DC 3 V DC to 53 V DC	115 V AC 88 V AC to 132 V AC	220 V AC 176 V AC to 264 V AC	24 V AC to 48 V AC 20 V AC to 65 V AC
Output current at "1" signal max.	2 A	2 A resistive 0.5 A inductive	2 A	2 A	2 A
Short-circuit protection	Fuse (module 6ES5 410-7AA21, only current limited up to 24 V and with resistive load)				
Limitation of voltage induced on circuit interruption	to	at $U_s = 30$ V DC: –17 V	at $U_s = 53$ V DC: –13 V	switch-off at $f = 0$	
Switching frequency					
– resistive loads	100 Hz	11 Hz	20 Hz		
– lamps	11 Hz	11 Hz	11 Hz		
– inductive loads	2 Hz	0.1 Hz	2 Hz		
Total load capability	100% at 20°C (50% at 55°C) (with respect to sum of the currents of all outputs)				
Residual current at "0" signal	max.	1 mA	5 mA	8 mA AC	10 mA AC
Signal level of outputs – "1" signal	$U_s - 1.8$ V		–		
Insulation voltage rating to VDE 0160 – tested with	500 V AC			2000 V AC	1500 V AC
Weight	approx.	0.68 kg	0.68 kg		
Notes	Digital input modules with the same voltage can be driven (see page 9)			Contactors of 3TJ range cannot be driven	

Digital output modules with relays	6ES5 417-7AA11	6ES5 417-7AA21
Number of outputs	8	8
Galvanic isolation	yes, for 4 outputs each	
Supply voltage/ current input (rated)	24 V DC/0.1 A	24 V DC/0.2 A
Continuous current I_{th2} max.	1 A	5 A
Switching capacity of contacts		
– resistive load	max. 30 V AC/DC/0.5 A min. 80 mV/50 μA	250 V AC/5 A 30 V DC/2.5 A
– inductive load	max. – min. –	250 V AC/1.5 A 30 V DC/0.5 A
Contact life in switching cycles	at 0 to 30 V: $5 \cdot 10^5$ at 80 mV: $10 \cdot 10^6$	to DC11: $2 \cdot 10^5$ to AC12: $1.5 \cdot 10^6$
Switching frequency		
– resistive load	max. 100 Hz	10 Hz
– inductive load	max. –	2 Hz
Simultaneity factor (with respect to sum of the currents of all outputs)	100% at 40°C 50% at 55°C	
Insulation voltage to VDE 0160 – tested with	500 V AC	2000 V AC
Weight	approx.	0.7 kg

NB: Relay modules require an additional internal 24 V DC power supply. (These power supplies are snapped at the end of the I/O mounting rack.)

2. Installation

2.1 General

2.2 Central controller (CC)

2.1 General

The following guidelines should be adhered to when wiring:

- The mains cables must be kept as far away as possible from the remaining cables.
- The M connection from the load power supply to the M_{ext} terminal should be made via a short connecting wire (see Fig. 11).
- 24 V lines (input/output modules, power supply) and 220V AC lines (input/output modules, power supply) should be run separately or bundled separately.
- If the 110S programmable controller is mounted inside a cabinet, the side sections and the door must have a low resistance interconnection. The cabinet must be connected to the PE conductor.
- The housing for the input/output modules should be connected via a low resistance path to M_{ext} terminal of the CC housing (conductor cross-section 2.5 mm²).

Caution

The modules of the 110S programmable controller should not be inserted or removed with the power on.

2.2 Central controller (CC)

The central controller can be mounted in cabinets with dimensions specified in inches, cabinets with metric units or on any vertical mounting surface.

The central controller should be mounted above the input/output modules. If the maximum configuration is used, the CC should be mounted between the second and third input/output mounting racks in order to keep the bus cable to the I/Os as short as possible and minimize external interference.

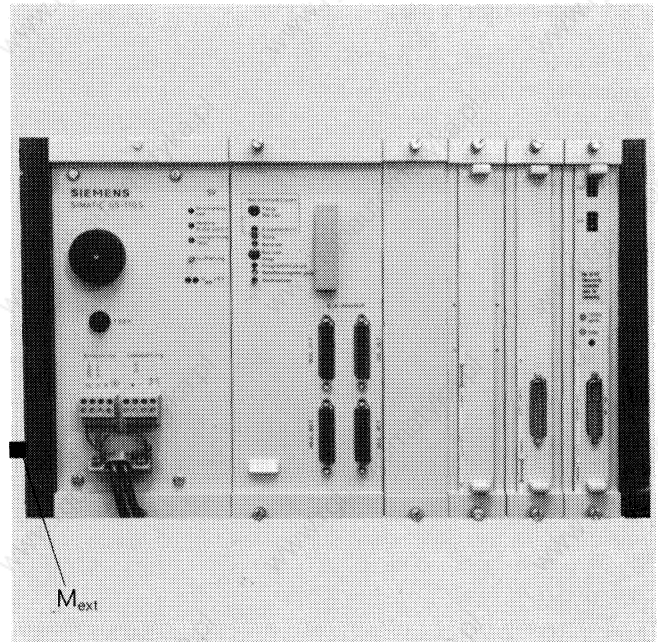

Fig. 9 110S central controller (with full module complement)

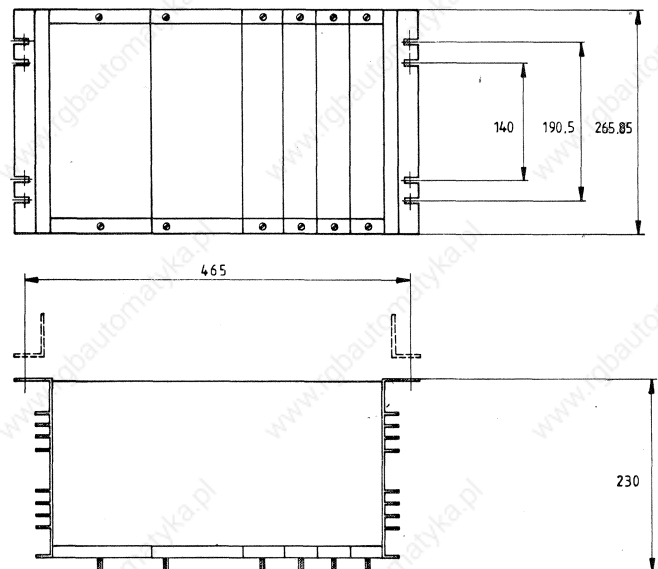

Fig. 10 110S central controller dimension drawing

2. Installation

2.2 Central controller

2.2.1 Power supply (PS)

The power supply (220 V AC, 115 V AC or 24 V DC) should be connected according to the type of power supply used. The 24 V load voltage monitoring circuit should also be connected. If the 24 V load voltage monitoring is to be switched off, as is always required when using 220 V AC I/Os, two additional terminals next to the load voltage monitoring input have to be short-circuited. There is never any load voltage monitoring in the 24 V DC power supply. For thermal reasons, the power supply unit is an integral part of the housing and cannot be removed.

The battery can be replaced by unscrewing the cover (1) and removing the battery. The battery should be changed at least once a year.

To prevent the battery from discharging when not in use, it must be correctly inserted (+ pole pointing to the front) when putting the programmable controller into operation.

In the case of the 24 V power supply, the negative potential is always connected to earth \oplus .

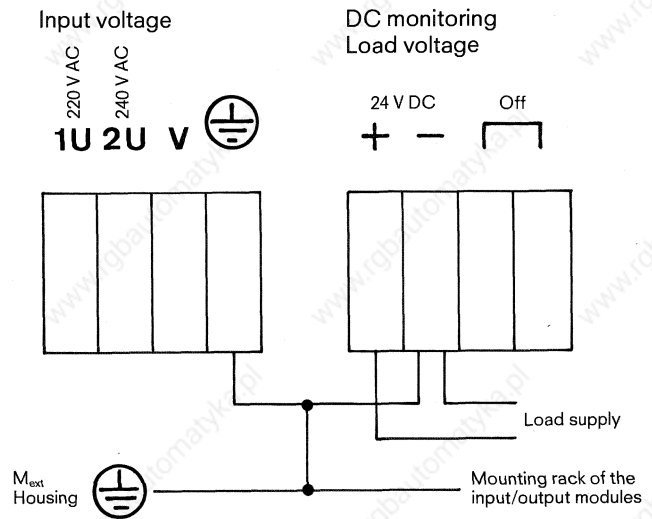

Fig. 11 Mains connections of the power supply unit

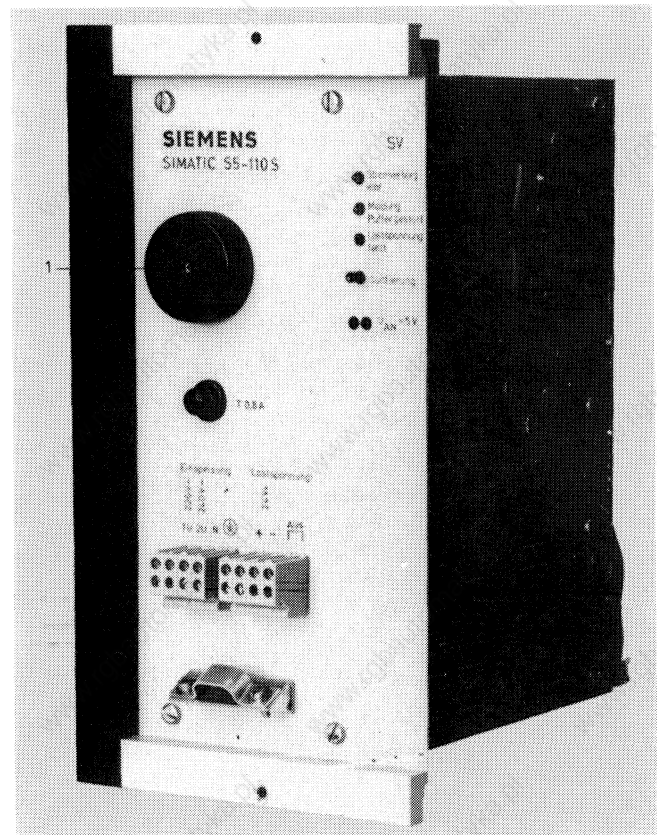

Fig. 12 Power supply unit

2. Installation

2.2 Central controller

2.2.2 CPU / memory submodule

One or more front connectors are used for connecting up the 110 bus for the digital I/Os. Each front connector (1) connects a maximum number of 128 input/output modules to the CPU.

The connector designation (2) on the CPU corresponds not only to the numbering of the digital inputs/outputs (see p. 28) but also designates the I/O parameters during programming.

A maximum of 512 inputs/outputs can be accessed by the CPU, using all four front panel connectors.

The memory submodule (3) for the CPU has optional capacities of 2K, 4K or 8K statements.

The CPU is plugged in as follows: The module is pushed onto the guides of the housing as far as possible until the two knurled screws (4) grip. The module is then evenly pushed into the connector, using these screws.

The CPU and memory submodule must not be removed or inserted with the power supply turned on.

Do not touch the components or etched conductors with the hands or fingers! This can cause destruction of the MOS chips!

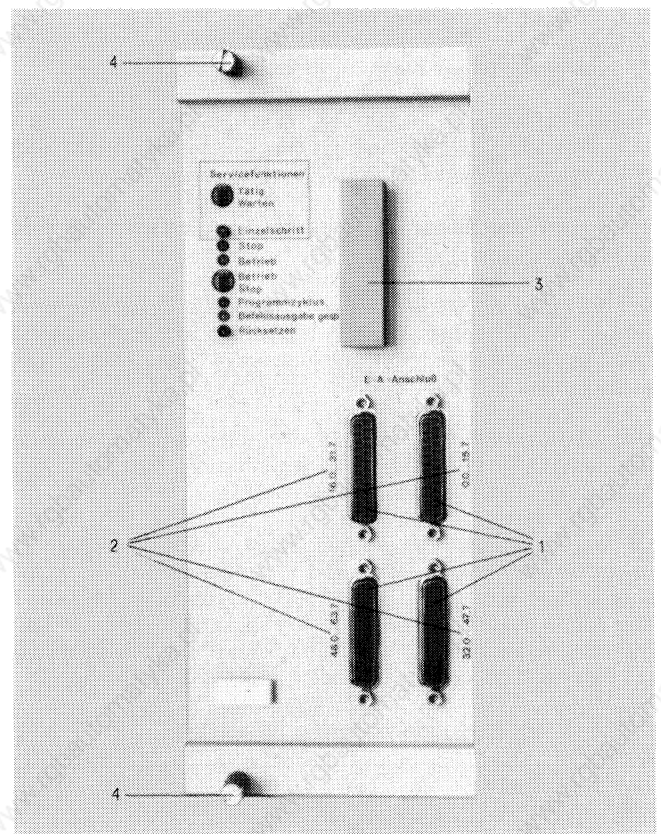

Fig. 13 CPU

2.2.3 Interface module 511 and 512C

The 110S PC has locations for two interface modules. The 511 interface module is used for connecting the 670/675 programming unit. When using the 511 interface module, make sure that jumper 8 is connected and jumper 9 is open. (Changeover from 10 MHz operating frequency to 2 MHz.)

The 512C interface module is used for connecting keyboard printers, process computers, CRT monitors and other programmable controllers of the S5 family. Exact details are given in the description of the 512C interface module (jumper assignments, switch position).

Caution: The connecting lead for the 670 PU and the 511 interface module should not be used for connecting the 512C module.

The 110S can only be used with software version 08 of the 511 interface module and software version 07 of the 670 PU.

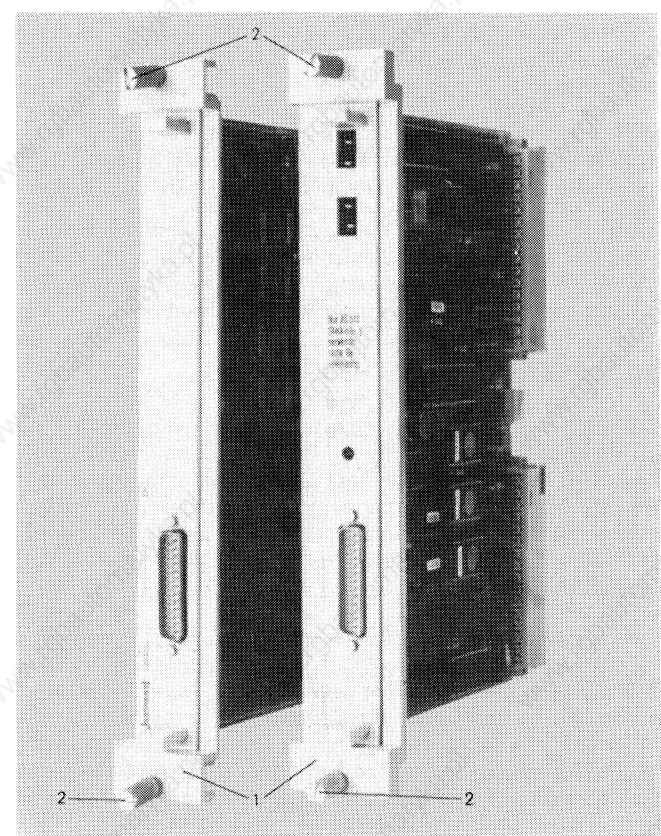

Fig. 14 511 and 512C interface modules

2. Installation

2.2 Central controller

2.2.4 340 or 350 memory module

There are two different memory modules available:

- the 340 RAM module with 8 or 16K statements
- the 350 RAM/EPROM module with 4K statements (RAM) and 2 to 12K statements (EPROM)

The memory modules are used to extend memory space for data and user programs.

In the case of the 340 RAM module, jumpers 2, 6, 9 and 10 must be inserted. Jumpers 5–12 and 7–11 on address coding socket 51 must also be inserted for 8K and jumpers 6–11 and 7–10 for 16K statements.

If the 350 RAM/EPROM module is used, jumpers 3 and 6 must be inserted. On the RAM address coding socket, jumpers 4–13 and 5–12 must be inserted.

Coding socket 19 (memory submodule 1) and coding socket 26 (memory submodule 2) are used for addressing the EPROM submodules. If memory submodule 1 (3) is used, jumpers 6–11 and 7–10 must be inserted on coding socket 19. Depending on the configuration of memory submodule 2 (4), the following jumpers must be inserted on coding socket 26:

Configuration of memory submodule 1	2K statements	4K statements	8K statements
Jumper assignment on coding socket 26	6–11, 7–10, 8–9	5–12	5–12, 7–10
Max. configuration of memory submodule 2	8K statements	8K statements	4K statements

If the memory submodules are used on the 350 RAM/EPROM module, one EPROM submodule with 8K statements must always be plugged into the CPU of the PC even if it does not contain an user program.

If the user program is in the RAM, it is advisable to transfer it to a floppy disk of the programming unit before switching the PC off, otherwise the user program might be lost should the battery fail.

When installing the two interface modules and the memory modules, a frame (1) must be slipped over the front cover in order to be able to plug the modules in and withdraw them without having to apply force, using the two knurled screws (2).

2.2.5 Digital I/O compact modules

512 digital inputs and 512 digital outputs of the rugged "A" type 110 A peripheral I/Os can be connected to the central controller of the PC (see 2.2.9 peripheral I/O modules). If this number of digital inputs and outputs is insufficient, the digital I/O compact modules can be plugged into locations 3, 4, 5 or 6 in the central controller (Fig. 3) or into the 182 expansion unit (only serial interface possible).

These compact modules can only be addressed from address 64 (40_H) to 127 (7F_H). This makes it possible to address a further 512 digital inputs and 512 digital outputs. However, as these modules were not originally designed for the 110S PC, the process image exchange must be executed by the user program itself. This means that, at the beginning of organisation block 0B1, the process input image must be renewed and the process output image transferred to the peripherals at the end of 0B1. Only peripheral I/Os may be referenced which are actually connected, otherwise the PC will enter the "Stop" state due to

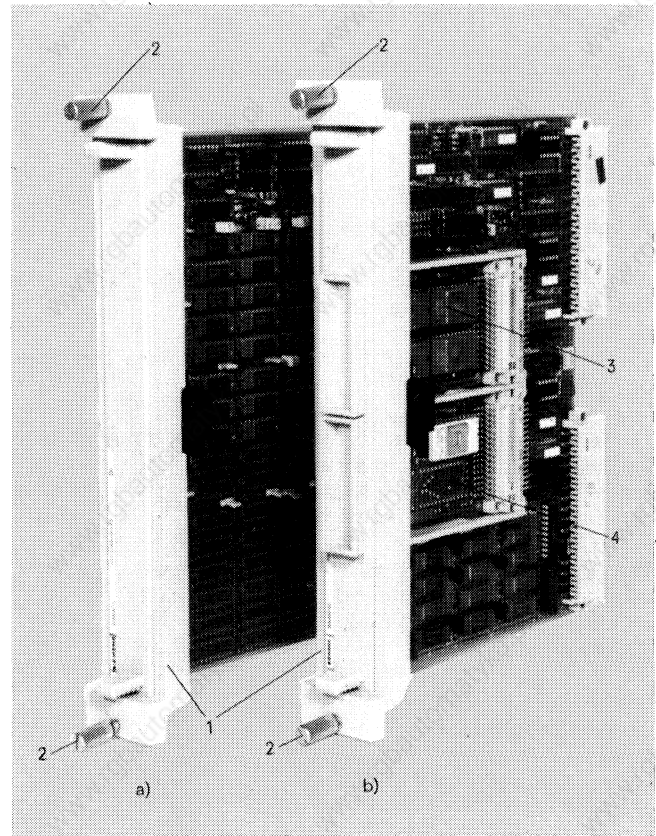
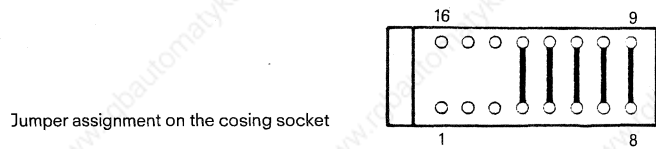

Fig. 15 Memory module
a) 340 (RAM)
b) 350 (RAM/EPROM) with memory submodules



Jumper assignment on the coding socket

an acknowledgement delay (time-out).

Examples of compact modules

0B1	}	Renew process image of the inputs (insofar as peripheral inputs are connected)
L PB64		
T IB64		
L PB65	}	User program
T IB65		
...		
L PB127	}	Transfer process output image to the peripheral outputs (insofar as peripheral outputs are connected)
T IB127		
JU FB1		
...	}	
L QB64		
T PB64		
L QB65	}	
T PB65		
...		
L QB127	}	
T PB127		

2. Installation

2.2 Central controller

2.3 Input and output modules

2.2.6 Analog I/O compact modules

Analog I/O compact modules can only be plugged into the central controller (locations 3, 4, 5 or 6, Fig. 3) or into a 182 expansion unit (only serial interface possible).

Like the digital I/O compact modules, the analog I/O compact modules can only be addressed from address 64 (40_H) to 127 (7F_H). See the operating instructions for "Analog I/O modules (compact version)" for notes on jumpering and modification of input range.

2.2.7 302 serial peripheral interface module

The 302 serial peripheral interface module can be plugged into the locations 3, 4, 5 or 6 of the central controller (Fig. 3). This interface makes it possible to address three 182 expansion units or three 110S racks via a 311 interface module. Each 182 expansion unit with a 311 interface module can be further expanded with the 300 and 312 interface modules. It must be ensured that the analog modules are plugged into the 182 expansion unit containing the 311 interface module, whereas digital modules can be plugged into any parallel expansion unit. The 110S racks with the 311 interface module can be extended with further 110S racks.

Addressing on the 302 interface module for digital/analog peripheral I/Os starts at address 64 (40_H) and can go as far as address 127 (7F_H) (see 2.2.5, 2.2.6). For further details, see the operating instructions "Serial interface between central controller and expansion unit".

2.2.8 MC210 monitor interface module

The 210 monitor interface module can be plugged into location 3 in the central controller (Fig. 3). This interface module makes it possible to operate a monochrome monitor with BAS input (BNC socket) via a 75 Ω coaxial cable. The image format of the monitor can consist of 16 or 32 lines per image and of 32 or 64 characters per line.

The image memory of the monitor interface has a capacity of 2K bytes RAM. The starting address of the image memory must be set to the address 2K (0800_H), 4K (1000_H) or 6K (1800_H) for the 110S PC. The interface module must be assigned parameters in order to be able to be addressed by the CPU. These parameters take up 16 addresses in the peripheral address area and must be situated between peripheral addresses 64 (40_H) and 127 (7F_H) in the case of the 110S PC.

For further information, see the operating instructions "Monitor interface module for the 210 micro-computer system".

Note: When using the compact modules, the plastic snap-in holders at the back of the rack must be removed.

2.3 Digital input/output modules

The mounting rack for the input/output modules can be attached to mounting plates or any other vertical mounting surface or mounted in cabinets with dimensions in inches or metric units.

Fig. 17 shows the configuration (32 module locations) of the I/O modules for one connector in the CPU. The modules are location-coded. Identical modules must not be plugged into locations with the same address, i.e. if an input module is plugged into the location with the address O, only one output module may be plugged in under the same address (see Fig. 17). The maximum I/O configuration consists of eight extra-long mounting racks or 16 short mounting racks (corresponding in both cases to 128 module locations for the input/output modules).

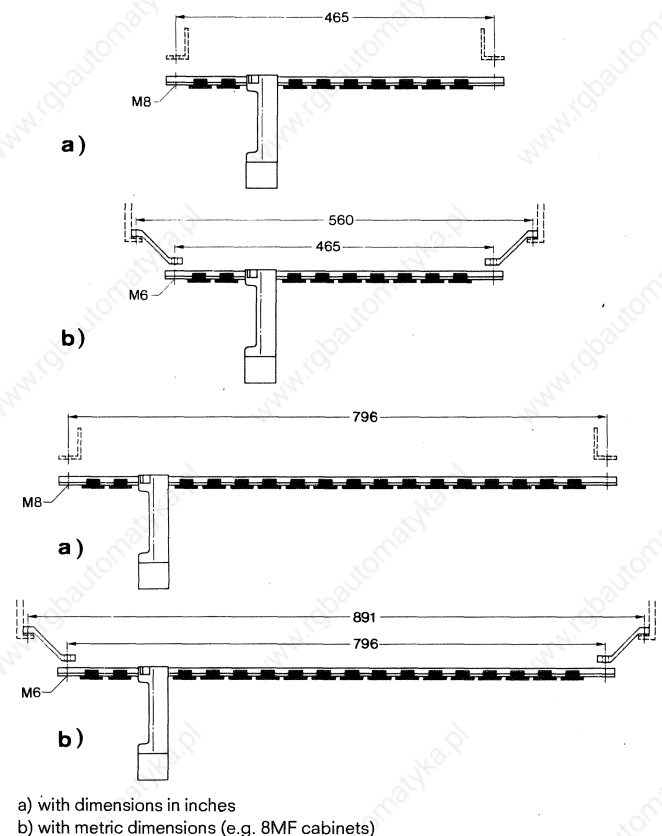

Fig. 16 Installation in cabinets

The length of the mounting rack is determined by the space available. If wide cabinets are used (Fig. 16), two mounting racks each with eight module locations (Fig. 17b) can be replaced by one mounting rack with 16 module locations (Fig. 17a).

In this case, the addressing is not changed and one less cable connector (3) is required. The complete addressing for the maximum configuration is shown in a diagram in the appendix (Page 30).

2. Installation

2.3 Input/output modules

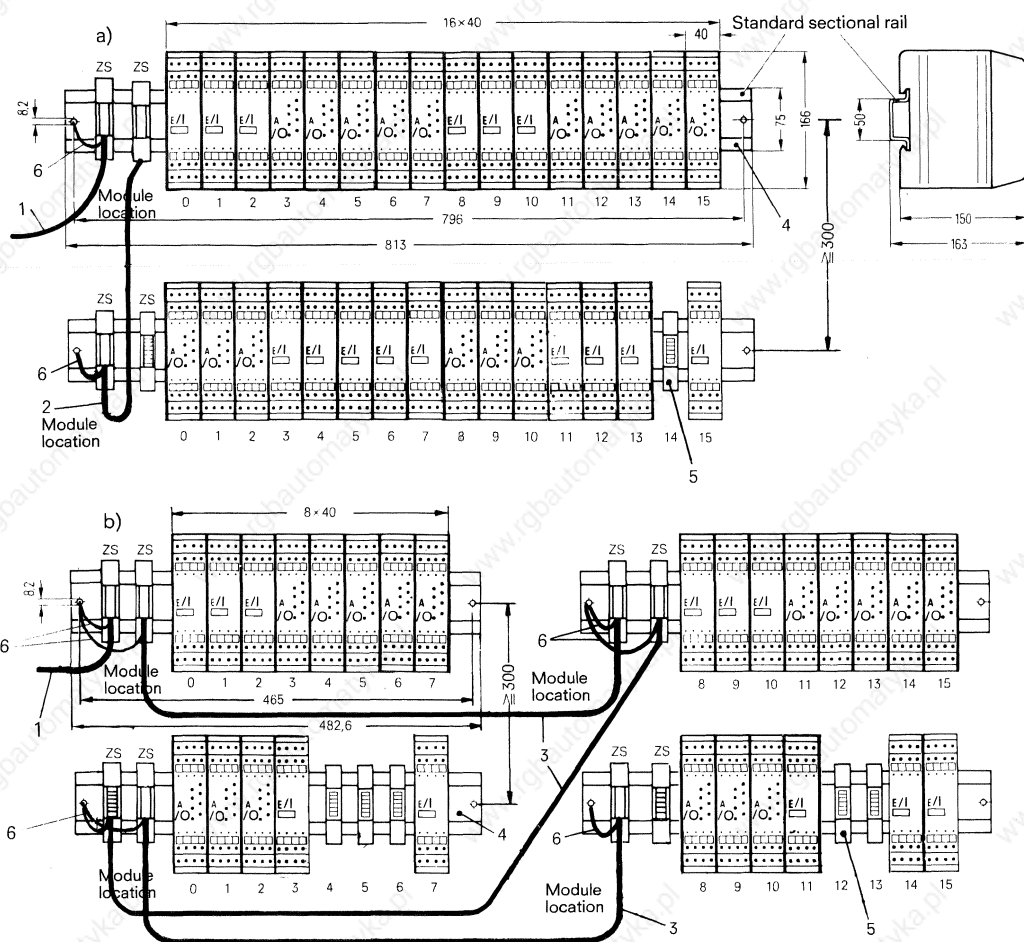

Fig. 17 I/O module configuration for one CPU connector a) With extra-long mounting racks b) With short mounting racks
 1 Cable to central controller, 2 Cable between two extra-long mounting racks, 3 Cable between two short mounting racks,
 4 Mounting rack, 5 Socket connector, 6 Earth connection (M_{ext})

The I/O modules are mounted as follows:

1. Securely mount the sectional rail. Make sure that the terminals (6) on the left hand side are connected up (earth connections).
2. Snap the socket connectors onto the rail.
3. Snap the input/output modules onto the connectors.
4. Wire up the input/output modules to sensors, contactors etc.

In order not to impede the air circulation and to allow easy access, a centre spacing of at least 300 mm should be observed between the rails.

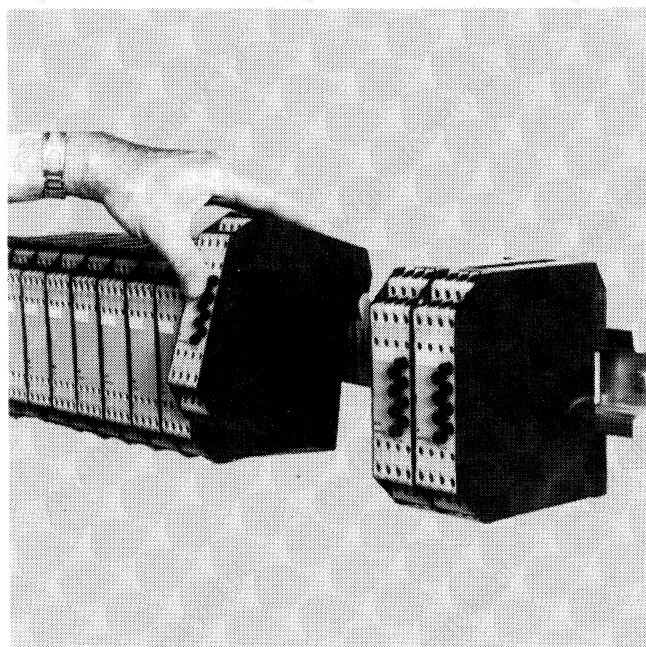

Fig. 18 Snapping an I/O module onto the mounting rack

www.rgbautomatyka.pl

3. Operation

3.1 Power supply (PS)

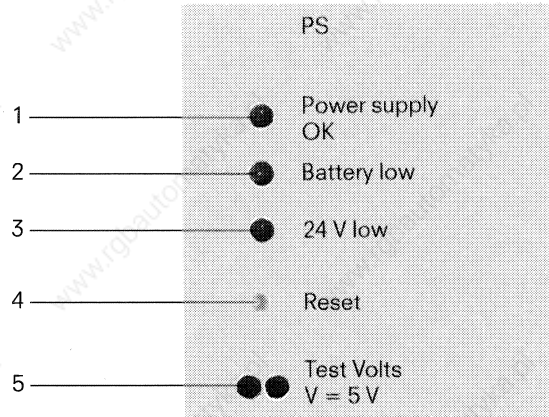

Fig. 19 Controls and displays on the power supply module

Control or display element	Function	Control action	Cause	Effect	LED
Green LED (1) "Power supply OK"	indicates that the internal voltage $U_A = 5\text{ V}$ is present			If the internal power supply $U_A \leq 4.75\text{ V}$ or $\geq 5.7\text{ V}$, the LED goes out	
Yellow LED (2) "Battery low"	indicates that the back-up voltage is too low		Back-up voltage of the Lithium cell $\leq 3\text{ V}$	If, during operation , a back-up voltage of less than 3 V is detected, the "Battery low" signal is given. This does not affect the back-up RAM area in the CPU if the battery is exchanged during operation. If a back-up voltage of $\leq 3\text{ V}$ is detected after power-up, the "Battery low" signal also appears. In this case, the back-up battery must be changed and a system reset function and system boot function must be carried out with the programming unit since the complete RAM contents have been erased.	
Red LED (3) "24 V low"	indicates the absence of or an excessively low 24 V load voltage		24 V load voltage absent or too low ($\leq 17.5\text{ V}$)	If the load voltage falls below a value of 17.5 V , the output modules are disabled. The central processor continues to process the user program. If the voltage again exceeds 17.5 V , the output modules are enabled again.	

3. Operation

3.1 Power supply (PS)

Control or display element	Function	Control action	Cause	Effect	LED
Pushbutton "Reset"	Acknowledges fault states in the power supply	The power supply can be switched on again by pressing the acknowledgement pushbutton	In the event of overvoltages ($U_{AN} \geq 5.7 \text{ V}$) or short-circuits on the internal power supply PS bus, the power supply switches off automatically. "Power Supply OK" LED is no longer illuminated.	"Power supply OK" LED lights up again	green
		Pressing the acknowledgement pushbutton resets the "Battery low" signal	During operation or when switching on the power, an excessively low backup voltage ($\leq 3 \text{ V}$) has been detected. The "Battery low" display appears (see explanation for yellow LED).	"Battery low" LED is no longer illuminated	green
Test socket " $U_{AN} = 5 \text{ V}$ " (5)	Test socket for output voltage (5 V) of the power supply	Connecting a measuring instrument to the measuring sockets with the polarity designations.			
Back-up battery	Back-up of the internal RAM memory of the CPU (timers, counters, retentive flags, user program) and also the 340 or 350 memory module.	The lithium primary battery must be changed at least once a year . This should be carried out with the power supply voltage switched on in order to prevent loss of information from the RAM. The battery is inserted in the compartment as indicated on the screw-on cap with the minus pole first.			
Terminal block	Power supply 220 V AC/ 240 V AC or 115 V AC For connecting the cables for 240 V AC, 220 V AC or 115 V AC, including the PE conductor.	Connection of the mains supply cable is carried out as shown on the terminal block.			
	Connecting up the load voltage monitoring circuit (24 V DC) Switching off the load voltage monitoring circuit (24 V DC)	The 24 V load voltage to be monitored is connected up as indicated on the terminal block. The "Off" jumper should be connected if monitoring is to be switched off when the load power supply is not connected.			
Terminal block	Power supply 24 V DC Connecting the power supply cables for +24 V and N.	The mains cable is connected up as indicated on the terminal block.			
	There is no load voltage monitoring				

3. Operation

3.2 CPU

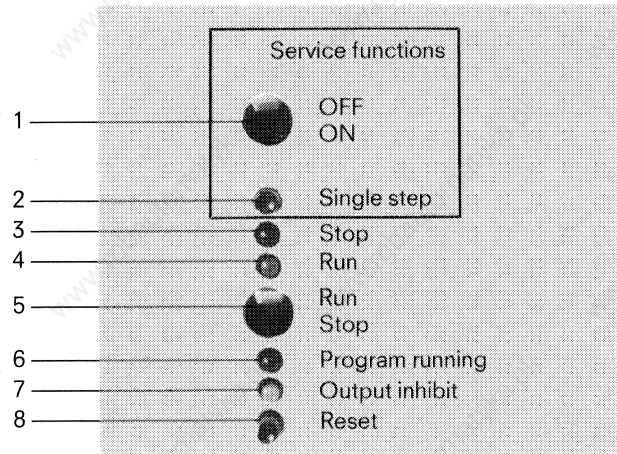

Fig. 20 Controls and displays elements on the CPU

Control or display element	Function	Control action	Cause	Effect	LED
"OFF/ON" switch (1)	<p>For service functions only</p> <p>Starting and stopping the central processor (microprogram). In the stop state, the microprogram can be enabled for single step operation.</p> <p>This can only be done in conjunction with a test module plugged into the central controller.</p>	1. Set switch to "OFF"		The central processor executes the microprogram cyclically (normal state)	green and orange
		2. Set switch to "ON"		The central processor is stopped immediately . The I/Os are disabled (BASP signal). Since the microprogram stop loop, which switches over the LEDs, is not processed, the green LED remains illuminated.	green and yellow
"Single step" button (2)	<p>For service functions only</p> <p>Initiates single microinstructions</p> <p>Can only be used in conjunction with the test module in the central controller.</p>	Set "OFF/ON" switch to "ON". Then operate the single step pushbutton.		One microinstruction is executed each time the button is actuated.	
Red "Stop" LED (3)	Indicates the "Stop" state of the central processor and lights up together with the yellow "Output Inhibit (BASP)" LED.		Mains failure, acknowledgement delay (time-out), cycle time exceeded, "Run/Stop" switch at "Stop", programmed stop, program error, etc.	The programmable controller is in the microprogrammed stop loop (no user program processing). The I/Os are disabled (BASP signal).	red and yellow
Green "Run" LED (4)	Indicates the run state of the central processor (cyclic processing of the microprogram). The following combinations can occur:				
		Green + orange LED		After completed cold restart routine	User program is executed

3. Operation

3.2 CPU

Control or display element	Function	Control action	Cause	Effect	LED
Green "Run" LED (4)	Green + red + yellow LED (only for a few seconds)		The mains voltage has been switched on or the "Run/Stop" switch has been moved to the "Stop" position and then back to the "Run" position.	Cold restart routine is processed. The following are reset: – system data – block address list – non-retentive flags – process I/O image – memory module system and user memory check	red and green and yellow
	Green + yellow LED		The "OFF/ON" switch has been put to the "ON" position (test state of the central processor). Undefined state of the central processor.	The outputs are disabled (PESP signal)	green and yellow
"Run/Stop" switch (5)	Cold restart and stop of user program execution	1. "Run" switch position (The user program is only executed if the "OFF/ON" switch is in the "OFF" position).		The user program is processed. The cold restart routine is started automatically on power-up.	green and orange
		2. "Stop" switch position		The central processor is brought to the micro-programmed stop loop (the user program is not executed). The outputs are disabled (BASP signal).	red and yellow
		Caution: When initiating a cold restart, the switch should be put to "Run" then to "Stop" and back to "Run".			
Orange LED (6) "Program running"	Shows the cyclic processing of the user program (lights up together with the green "Run" LED)		Completed cold restart routine	Cyclic execution of the user program. Cycle time is max. 270 ms.	orange and green
Yellow "Output Inhibit" LED (7)	Indicates the state of the disabled I/Os (BASP)		Mains failure, acknowledgement delay (time-out), cycle time exceeded, "Run/Stop" switch at "Stop" position, programmed stop, program error	The outputs are disabled	
"Reset" button (8)	Resetting of counters, timers and flags.	The reset button is pressed simultaneously with the initiation of the cold restart, i.e. putting the "Run/Stop" switch from "Stop" to "Run"		Resetting of all counters, timers, retentive and non-retentive flags during the cold restart routine.	red and green and yellow

Caution: The memory submodule must not be inserted or removed with the power on.

4. Maintenance and repairs

4.1.1 S5-110S fault diagnosis

In the case of a fault, the S5-110S programmable controller should be checked in the following sequence.

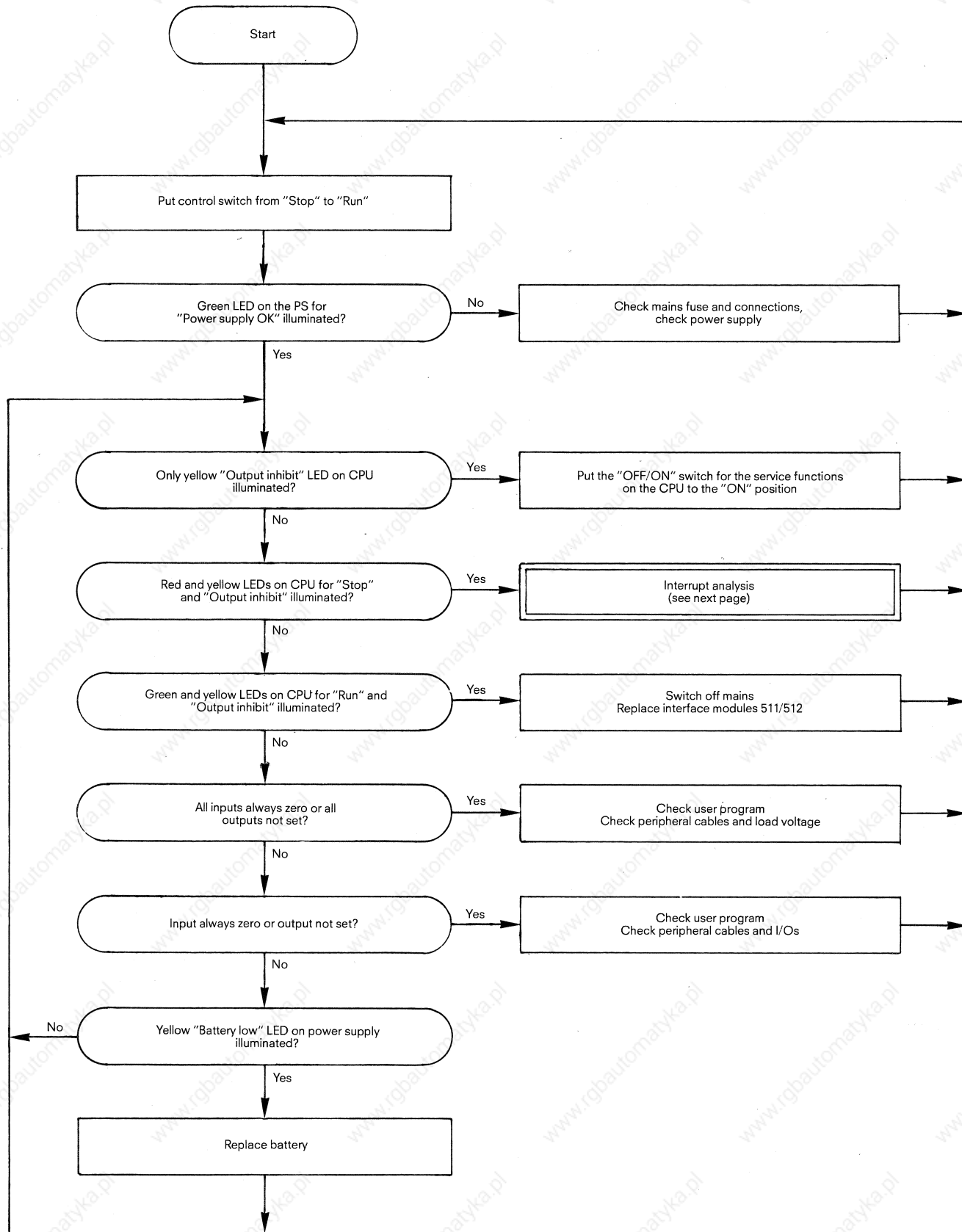

Fig. 21 Sequence diagram for fault diagnosis

4. Maintenance and repairs

4.1.2 Interrupt analysis

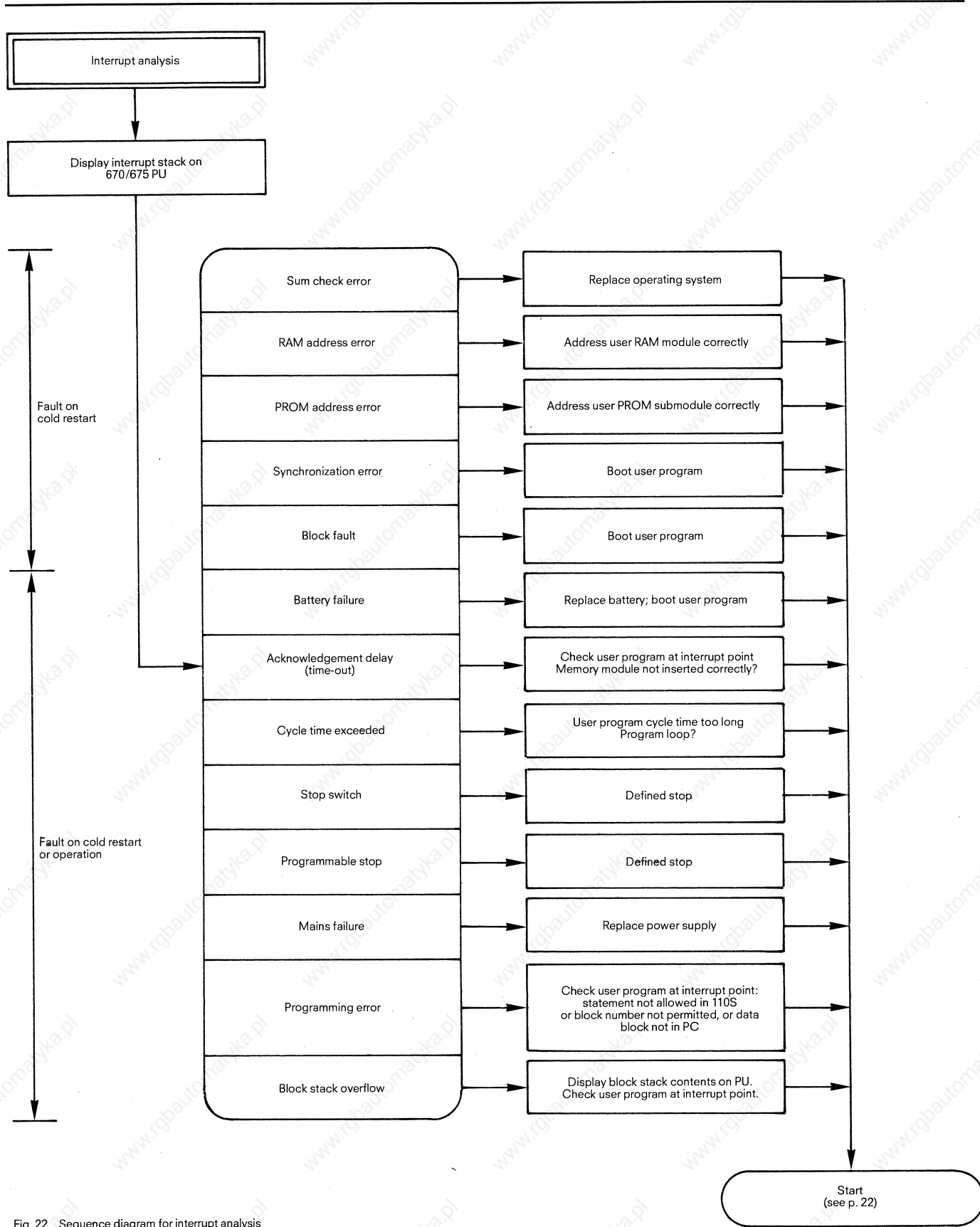

Fig. 22 Sequence diagram for interrupt analysis

4. Maintenance and repairs

4.1.3 Interrupt stack

4.1.3 Interrupt stack

The interrupt stack (ISTACK) is a stack register in which the system program stores information when the PC enters the stop state.

1. In the case of "Output ISTACK" with the 670/675 programming unit, the control bits (Fig. 23a) which are contained in the system data words SD 5 to SD 7 (absolute address EAOA_H to EAOE_H) are output in the first part. The control bits have the following significance:

- | | |
|--|--|
| <ul style="list-style-type: none"> a) PBS SCH: shift block before PROM b) BST SCH: shift block c) SCHTAE: shift operation d) ADR BAU: address list construction e) SPABBR: memory shift discontinuation f) NAU AS: mains failure for interface modules g) QUITT: acknowledgement for PBS SCH h) STOZUS: the PC is in the microprogrammed stop loop (external request/cold restart) i) STOANZ: the PC is in the microprogrammed STOP state (internal request/cold restart) j) NEUSTA: the PC is in the cold restart (new start) routine k) BATPUF: back-up battery for internal RAM memory is ok l) BARB: the PC is in the single step mode | <ul style="list-style-type: none"> m) BARB END: the PC indicates the end of the single step mode n) MAFEHL: group alarm for machine error word SD 7 o) EOVBH: interrupt input byte 0 present p) ASPNPR: only EPROM user memory present q) ASPNRA: only RAM user memory present r) KOPFNI: block header cannot be interpreted (erase, boot and cold restart) s) PROEND: shift before EPROM use ended (cold restart) t) PADRFE: addressing error in EPROM memory (reset, boot and cold restart) u) ASPLUE: address gap in user memory (erase, boot and cold restart) v) RAMADFE: addressing error in RAM memory (erase, boot and cold restart) w) KEINAS: no user memory module inserted x) SYNFEH: synchronization error (erase, boot and cold restart) y) NINEU: cold restart not possible (erase, boot and cold restart) z1) SUMF: sum error in system program (cold restart) z2) URLAD: boot (reset and boot) |
|--|--|

C O N T R L B I T S									
NB	PBSSCH	BSTSCH	SCHTAE	ADRBAU	SPABBR	NAUAS	QUITT	}	System data word SD 5 EA 0 A _H
NB	NB	NB	NB	NB	NB	NB	NB		
STOZUS	STOANZ	NEUSTA	NB	BATPUF	NB	BARB	BARBEND	}	SD 6 EA 0 C _H
NB	X	MAFEHL	EOVBH	NB	NB	NB	NB		
ASPNPR	ASPNRA	KOPFNI	PROEND	NB	PADRFE	ASPLUE	RAMADFE	}	SD 7 EA 0 E _H
KEINAS	SYNFEH	NINEU	NB	NB	NB	SUMF	URLAD		

Fig. 23a Interrupt stack, part 1 (control bits) NB signifies unassigned

2. The interrupt stack proper is output in the second part of the ISTACK (Fig. 23b)

The "Cause of interrupt" is displayed in the interrupt condition code word (SD 214 absolute address EBAC_H) – one of the most important debugging aids. The mnemonics have the following significance:

- | | |
|---|--|
| <ul style="list-style-type: none"> a) STOPS: "Run/Stop" switch is in stop position b) STUEB: block stack overflow | <ul style="list-style-type: none"> c) NAU: mains voltage failure d) QVZ: acknowledgement delay (time-out) e) ZYK: cycle time exceeded f) BAU: battery failure g) NNN: programming error; statement is not permissible in the 110S or block number is not permitted or data block not present h) STS: programmable STOP |
|---|--|

4. Maintenance and repairs

4.1.3 Interrupt stack

4.1.4 System parameters

3. The "Result bits" (absolute address EBAA_H) show the state the PC was in when the interrupt occurred.

- FLG1 (CC1); FLG0 (CC0): condition code for arithmetic, logical and shift operations
- OVFL: condition code for arithmetic overflow
- OR: condition code for OR memory
- RLO: condition code for result of logic operation
- FOP: condition code first scan

The "Brackets" line (SD 209 – SD 212) indicates which bracket level the PC was in when the interrupt occurred. The condition codes for OR, RLO and AND/OR are displayed.

The contents of the accumulator (SD 203 and SD 204), the step address counter SAC (SD 206), the block stack pointer BK-STP (SD 207) and the initial address of the data block selected DB-ADD (SD 208) at the time the interrupt occurred are also displayed.

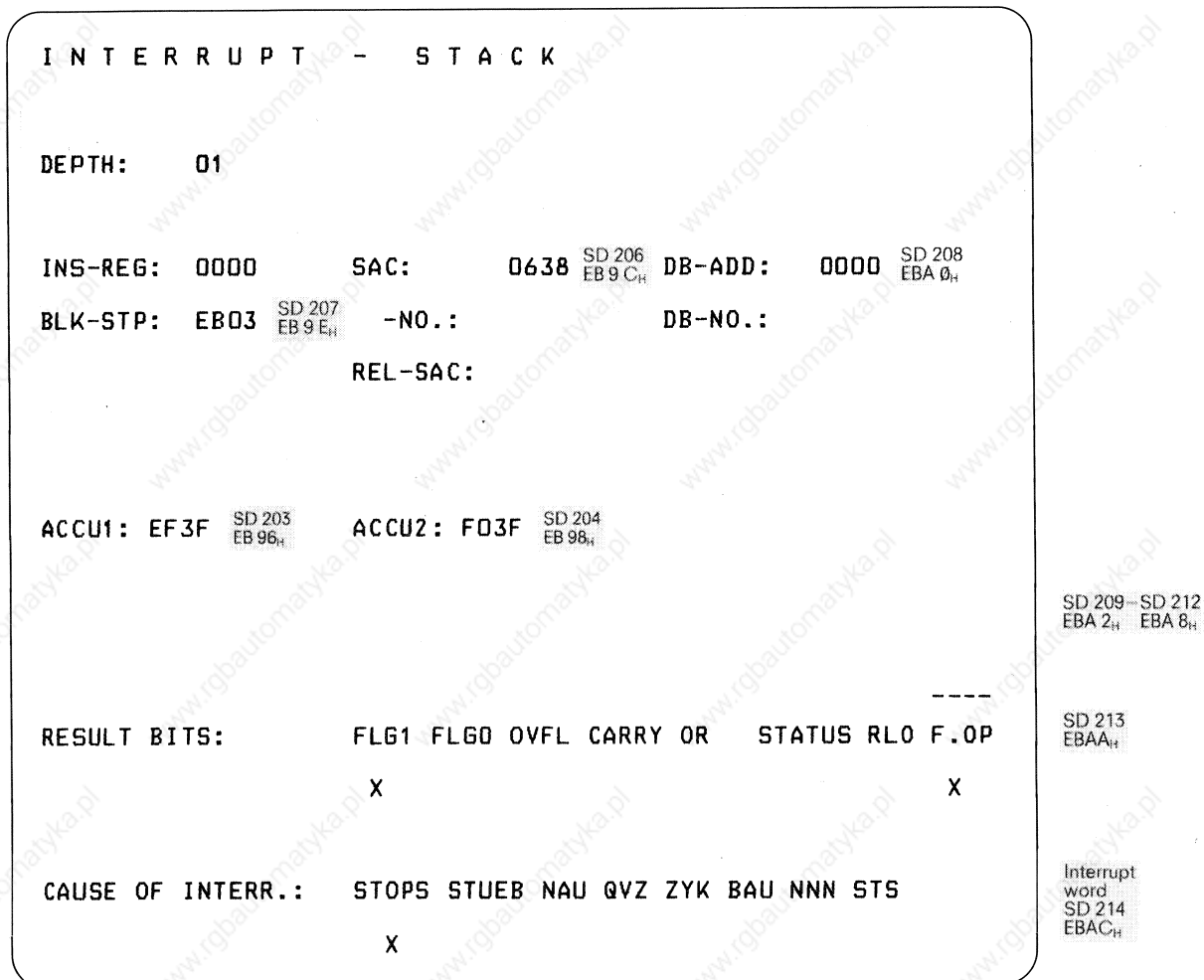

Fig. 23b Interrupt stack, part 2

4.1.4 System parameters

The system parameters provide information about the PC and the memory configuration.

- Release of the PC software
- CPU identifier
- Release of the PU and IM software
- Memory configuration (absolute addresses)
 - Input modules (I/O memory F000_H to F07F_H)
 - Output modules (I/O memory F080_H to F0FF_H)
 - Process image of the inputs EF00_H to EF7F_H
 - Process image of the outputs EF80_H to EFFF_H
 - Retentive flags EE00_H to EE7F_H
Non-retentive flags EE80_H to EFFF_H
 - Timers ED00_H to EDF7_H
 - Counters EC00_H to ECFF_H
 - ST memory area (system data area) EA00_H to EBFF_H

4. Maintenance and repairs

4.2 Connector pin assignments in the central controller backplane

Signal name	Connector with pin assignment						
	Power supply X 11	Indicating unit X 12	CPU-X 1	Diagnostics-X 3	RAM-X 5	IM 511-X 7	IM 512-X 9
+5 V M E/A SAZLL	1/2 3/4		Z2 b2 d2 f2	Z2 b2 d2 f2	Z2 b2	Z2 b2	Z2 b2
Ø 2TTL PESP UBATT SAZLH		b5	Z4 b4 d4 f4	Z4 b4 d4 f4	Z4 b4 d4	Z4 b4 d4	Z4 ¹⁾ b4 d4
CPKL ADBØ ADB12 SAZRL		a2	Z6 b6 d6 f6	Z6 b6 d6 f6	Z6 b6 d6	Z6 b6 d6	Z6 b6 d6
EMR ADB1 ADB13 SAZRH			Z8 b8 d8 f8	Z8 b8 d8 f8	Z8 b8 d8	Z8 b8 d8	Z8 b8 d8
EMW ADB2 ADB14 SAZL			Z10 b10 d10 f10	Z10 b10 d10 f10	Z10 b10 d10	Z10 b10 d10	Z10 b10 d10
RØY ADB3 ADB15 SAZS			Z12 b12 d12 f12	Z12 b12 d12 f12	Z12 b12 d12	Z12 b12 d12	Z12 b12 d12
DBØ ADB4 TXR1 INC			Z14 b14 d14 f14	Z14 b14 d14 f14	Z14 b14 d14	Z14 b14 d14	Z14 b14 d14
DB1 ADB5 S-Test 0 DEC			Z16 b16 d16 f16	Z16 b16 d16 f16	Z16 b16 d16	Z16 b16 d16	Z16 b16 d16
DB2 ADB6 S-Test 1 IMR			Z18 b18 d18 f18	Z18 b18 d18 f18	Z18 b18 d18	Z18 b18 d18	Z18 b18 d18
DB3 ADB7 RXR2 IMW			Z20 b20 d20 f20	Z20 b20 d20 f20	Z20 b20 d20	Z20 b20 d20	Z20 b20 d20
DB4 ADB8 S-Test BASPI			Z22 b22 d22 f22	Z22 b22 d22 f22	Z22 b22 d22	Z22 b22 d22	Z22 b22 d22
DB5 ADB9 BASF ANZØ			Z24 b24 d24 f24	Z24 b24 d24 f24	Z24 b24	Z24 b24	Z24 b24
DB6 ADB1Ø OVF ANZ1			Z26 b26 d26 f26	Z26 b26 d26 f26	Z26 b26	Z26 b26	Z26 b26
DB7 ADB11 DSI QVZM		b2	Z28 b28 d28 f28	Z28 b28 d28 f28	Z28 b28 d28	Z28 b28 d28	Z28 b28 d28
MWPH BASP MEMSEL QVZVM			Z30 b30 d30 f30	Z30 b30 d30 f30	b30 d30	b30 d30	b30 d30
CSPAØV M BASPA QVZHM	3/4	a3	Z32 b32 d32 f32	Z32 b32 d32 f32	b32 d32	b32 d32	b32 d32

Fig. 24a Upper connector row of the CC backplane

1) X9/Z4 connected to the lower connector row X10/Z32

4. Maintenance and repairs

4.2 Connector pin assignments in the central controller backplane

Signal name	Connector with pin assignment						
	Power supply-X 11	Indicating unit-X 12	CPU-X 2	Diagnostics-X 4	RAM-X 6	IM 511-X 8	IM 512-X 10
+5 V M NABA M HOLD	1/2 3/4		Z2 b2 Z24 b32 d32	Z2 b2 Z24 b32 d32	Z2 b2 Z24 b32	Z2 b2 Z24 b32 d32	Z2 b2 Z24 b32 d32
BUBE BUSEN 1∅MHz				b4 Z16 Z32		Z28 d22 Z32	Z28 d22 Z32 ¹⁾
CPUK1 CPUK∅			d6 Z30			d6 Z30	d6 Z30
DB12 DB8 DB13 DB9 DB14 DB1∅ DB15 DB11					Z4 b4 Z6 b6 Z8 b8 Z10 b10	Z4 b4 Z6 b6 Z8 b8 Z10 b10	Z4 b4 Z6 b6 Z8 b8 Z10 b10
PLPG HOLDA HOLDA1 HOLDA2 DMAFA			Z20 d20 Z18			Z16 d20 Z20	
VKEA TFA			d28 b30	b30		d28	
NAU BAU		b1 a1	Z14 Z16				
ADVS μ∅ DBA8 EAZL			d2 f2 Z4 d4	d2 f2 Z4 d4			
μ1 DBA9 DBA13 μ2			f4 Z6 b6 f6	f4 Z6 b6 f6			
DBA1∅ DBA14 μA∅ μ5			Z8 b8 d8 f8	Z8 b8 d8 f8			
DBA11 DBA15 μA1 μ4			Z10 b10 d10 f10	Z10 b10 d10 f10			
DBA12 μA5 μA2 μ5			Z12 b12 d12 f12	Z12 b12 d12 f12			
μA6 μA3 μ6 μA7			b14 d14 f14 b16	b14 d14 f14 b16			
μA4 μ7 μA8 EAZS			d16 f16 b18 d18	d16 f16 b18 d18			
μ8 μA9 μ9 EAPSF			f18 b20 f20 Z22	f18 b20 f20 Z22			
μA1∅ EAINT μ1∅ μA11			b22 d22 f22 b24	b22 d22 f22 b24			
VKE μ11 EATAE OR			d24 f24 Z26 b26	d24 f24 Z26 b26			
ERAB μ12 EACSF μA12			d26 f26 Z28 b28	d26 f26 Z28 b28			
μ13 EICLEAR μ14 EAPRES			f28 d30 f30 Z32	f28 d30 f30 Z32			
μ15 SPK∅			f32	f32 Z30	AD AE AC	d26 U V T	d26 H K G
+5 V M SPK1	1/2 3/4			d6	AA AB Z	b26 R S P	b26 E F D
+5 V M SPK2	1/2 3/4			Z14	X Y W	Z14 M N L	Z14 B C A

Fig. 24b Lower connector row of the CC backplane

4. Maintenance and repairs

4.3 Connector pin assignments of the 110 bus

4.3 Connector pin assignments of the 110 bus

Fig. 25 shows the pin assignments of the connectors for the 110 bus for each mounting rack. If the I/O bit is "0", only the inputs are addressed, whereas if it is "1", only the outputs are addressed. The addressing of each module on the mounting rack is carried out using bits Z1, Z2 and F0 to F7 (see Fig. 26). The individual inputs/outputs on the modules are selected by bits K0 to K2.

I/O	Enable the input (= "0") or output modules (= "1")
Z1, Z2 and	
F0 to F7	Addressing of the input/output modules
K0 to K2	Addressing of the inputs or outputs on the selected modules
D _{IN}	DATA IN, signal state of inputs
D _{OUT}	DATA OUT, signal state for setting the outputs
RI	Initialising pulse (resets output modules)
IR	Interrupt group signal of the corresponding digital input module
M	0 V DC

Socket connectors

2	+5 V		E/A	1
4	Z2		Z1	3
6	F6		F7	5
8	JR		RI	7
10	F4		F5	9
12	D _{OUT}		D _{IN}	11
14	F2		F3	13
16	K1		K2	15
18	F0		F1	17
20	M-		K0	19

Fig. 25 Pin assignments of the socket connector on the 110 bus

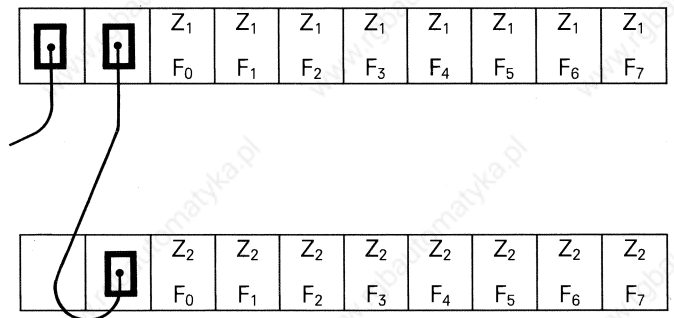

Fig. 26a Coding of the 110 bus with short mounting racks

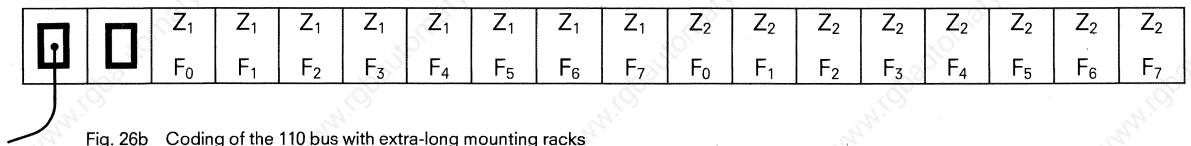

Fig. 26b Coding of the 110 bus with extra-long mounting racks

5. Spare parts

Description	Order No.	Weight approx. kg
Housing , complete with power supply 220 V AC/240 V AC/5 V DC	6ES5 932-3SA12	9.5
Housing , complete with power supply 115 V AC/5 V DC	6ES5 932-3SA22	9.5
Housing , complete with power supply 24 V DC/5 V DC	6ES5 932-3SA32	6.7
CPU	6ES5 902-3SA12	1.0
Memory submodul for CPU a) with EPROM for 2K statements b) with EPROM for 4K statements c) with EPROM for 8K statements	6ES5 911-0AA31 6ES5 911-0AA42 6ES5 911-0AA52	0.06
340 Memory module* RAM for 8K statements RAM for 16K statements	6ES5 340-5AA11 6ES5 340-5AA21	0.3 0.3
350 Memory module* RAM for 4K statements	6ES5 350-5AA21	0.3
Associated EPROM submodules* 371 for 2K statements 371 for 4K statements 371 for 8K statements	6ES5 371-0AA31 6ES5 371-0AA41 6ES5 371-0AA51	0.07 0.07 0.07
511 PU interface module*	6ES5 511-5AA12	0.3
512C Interface module* for computer, keyboard printer and CRT monitor	6ES5 512-5BC12	0.3
302 Serial peripheral interface module* (can be plugged into central controller)	6ES5 302-5AA11	0.3
731 Cable connector* between 670 PU and 511 IM	6ES5 731-0□□□0 ▲▲▲	
732 Cable connector between 512 IM and 3913 keyboard printer (TTY)*	6ES5 732-1□□□0	
3914 keyboard printer (PT80, TTY)*	6ES5 732-2□□□0	
3964 Data transmission controller (PROME A)*	6ES5 732-3□□□0	
3974 (TTY)* Alphanumeric display unit	6ES5 732-4□□□0	
3974 R (TTY)* Alphanumeric display unit	6ES5 732-5□□□0	
512 Interface module (S5-S5 interface TTY)*	6ES5 732-6□□□0	
3964 Data transmission controller*	6ES5 732-7□□□0	
Length of 731 and 732 cable connectors ▲▲▲		
1 m	BB0	
2 m	BC0	
4 m	BE0	
5 m	BF0	
10 m	CB0	
20 m	CC0	
40 m	CE0	
80 m	CJ0	
100 m	DB0	
200 m	DC0	
400 m	DE0	
800 m	DJ0	
1000 m	EB0	
736 Cable connector* Length 3.20 m; for connecting a PT 80 (TTY) printer to the 670/675 PU	6ES5 736-0BD20	
737 Cable connector* Length 3.20 m; for connecting a printer (V.24) to the 670/675 PU	6ES5 737-0BD20	

Description	Order No.	Weight approx. kg
670C Programming unit* consisting of: video monitor with UV erasing unit and printer interface German labelling English labelling French labelling	6ES5 670-0CA21 6ES5 670-0CB21 6ES5 670-0CC21	20
675 programming unit* consisting of: video monitor with printer interface but without UV erasing unit	6ES5 675-0UA11	18
Mounting rack with 8 module locations with 16 module locations	6ES5 710-0SA11 6ES5 710-0SA41	1.53 2.56
Cable connector , shielding between CC and I/Os, 0.9 m between CC and I/Os, 1.5 m between CC and I/Os, 2.5 m	6ES5 716-0AK00 6ES5 716-0BB50 6ES5 716-0BC50	
Cable connector , shielded between short mounting racks, 0.8 m	6ES5 717-0BJ00	
Cable connector , shielded between extra-long mounting racks, 0.5 m	6ES5 718-0AF00	
Input modules , each with 8 inputs		
Digital input module 24 V DC	6ES5 400-7AA13	0.4
Digital input module with group signal 24 V DC	6ES5 401-7AA13	
Digital input module 115 V AC/DC 220 V AC/DC 48 V AC/DC	6ES5 405-7AB11 6ES5 405-7AB21 6ES5 405-7AB31	
Output modules , each with 8 outputs		
Digital output module 24 V DC, 2 A 48 V DC, 0.5 A 115 V AC, 2 A 220 V AC, 2 A 48 V AC/24 V AC, 2 A	6ES5 410-7AA11 6ES5 410-7AA21 6ES5 415-7AB11 6ES5 415-7AB21 6ES5 415-7AA31	0.68
Relay output module up to 30 V AC/DC/500 mA up to 250 V AC/DC/1.5 A	6ES5 417-7AA11 6ES5 417-7AA21	0.7
333C Service unit* without connector	6ES5 333-0AC21	3.0
Standard function blocks for 333C service unit, on mini-diskette	P71200-A0121-A253-04	
Fuses for output modules 220 V AC, 6.3 A fast 115 V AC, 6.3 A fast 24 V DC, 2.5 A fast	261 312 GWA 261 312 GWA 261 131 GWA	
Power supply blocks 220/240 V AC, 0.8 A slow 115 V AC, 1.6 A slow	256 263 GWE 256 255 GWE	
Power supply modules for external 24 V supply 220 V AC/24 V DC; 0.8 A 115 V AC/24 V DC; 0.8 A	6ES5 931-7AA11 6ES5 931-7AA21	0.7 0.7
Back-up battery (Li) 3.4 V	6ES5 980-0AA31	

* Order from GWK

6. Maximum I/O configuration

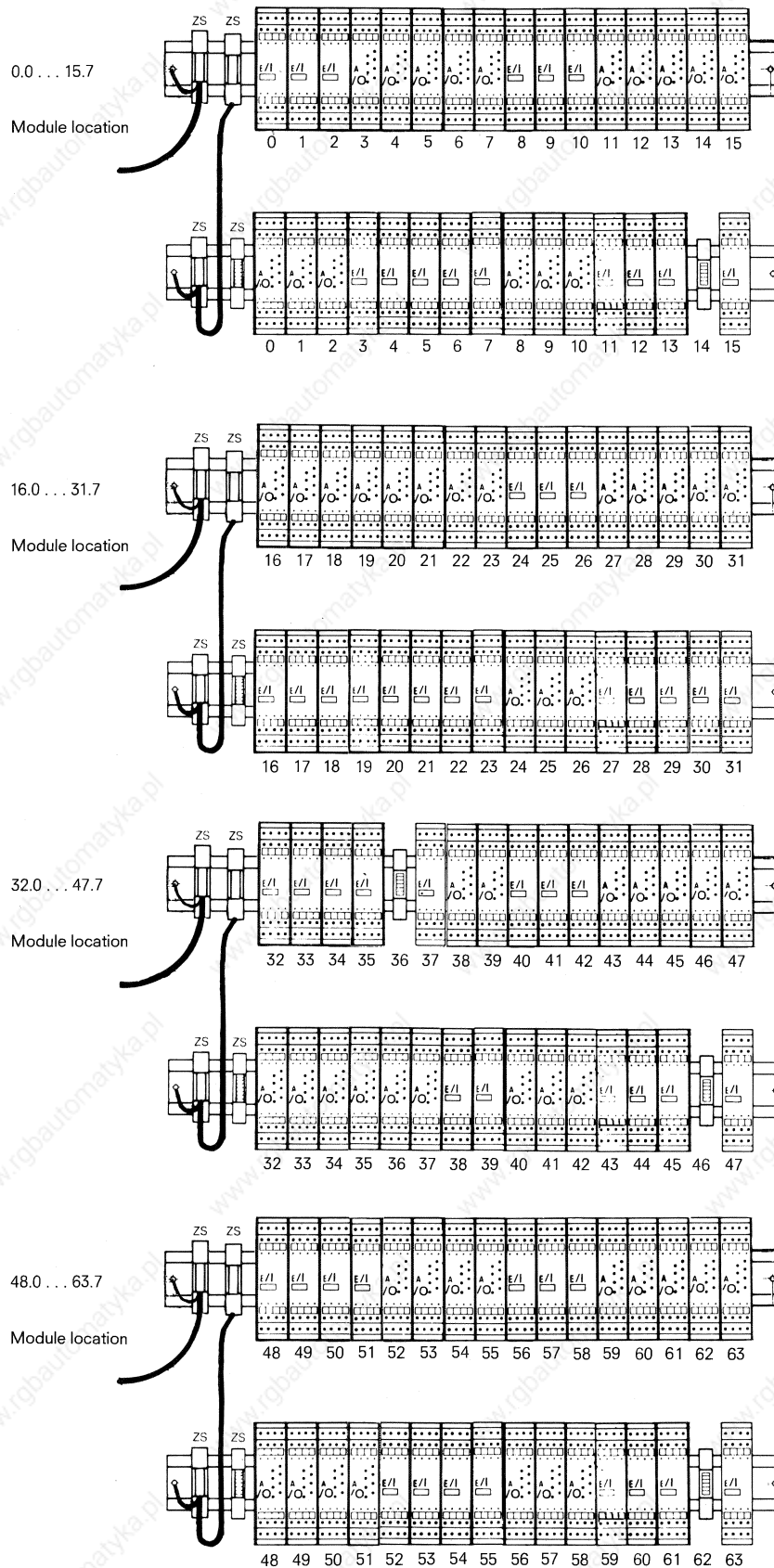

Fig. 27a Maximum configuration of the I/Os with extra-long mounting racks and addressing of the input/output modules.

6. Maximum I/O configuration

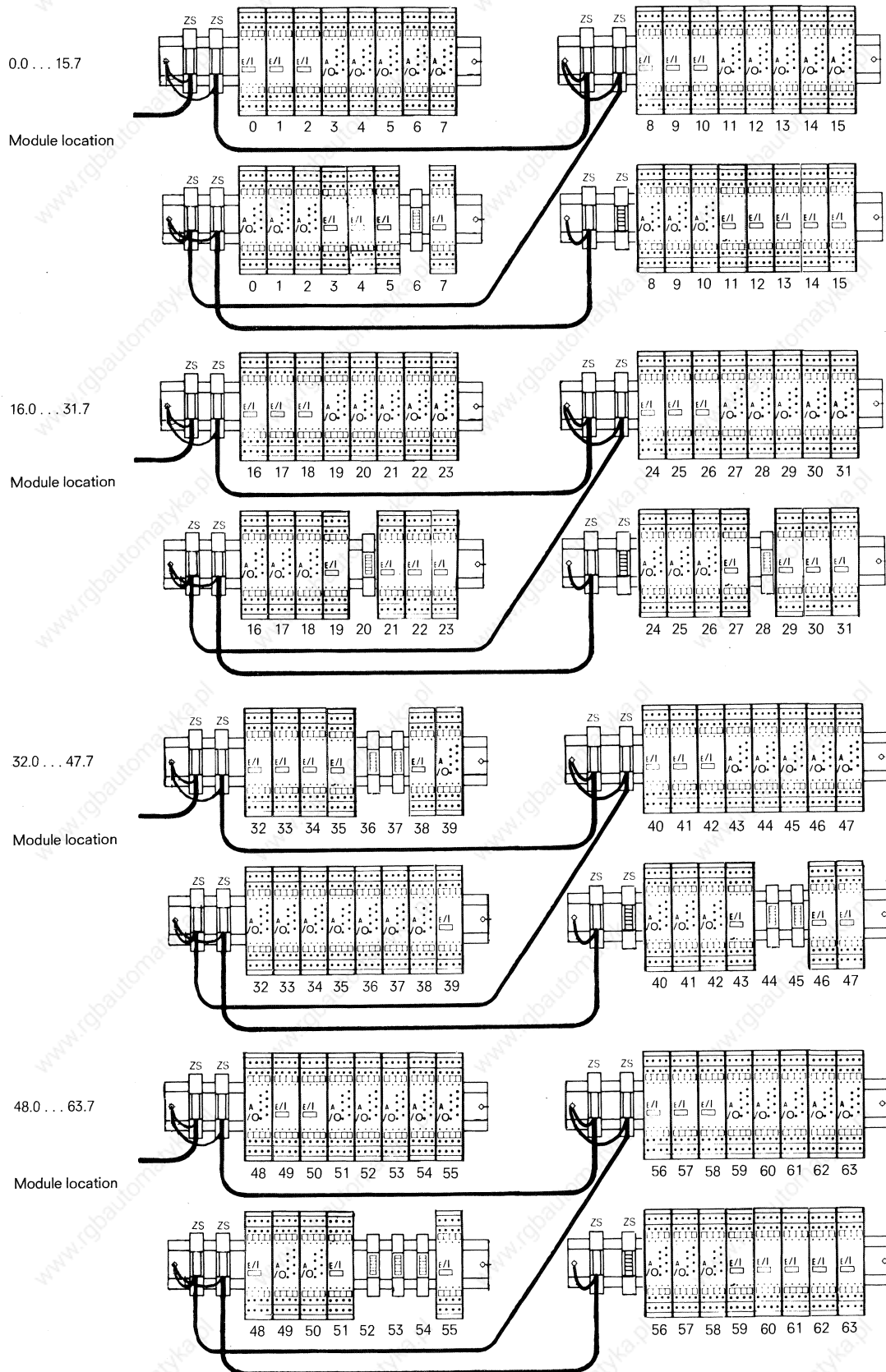

Fig. 27b Maximum configuration of the I/O modules with short mounting racks and addressing of the input/output modules.

SIEMENS