

# OPERATING MANUAL

## **NORDAC *vector mc***

### **Frequency Inverter**

SK 250/1 FCT ... SK 750/1 FCT  
SK 1100/1 FCT ... SK 2200/1 FCT  
SK 750/3 FCT ... SK 3000/3 FCT

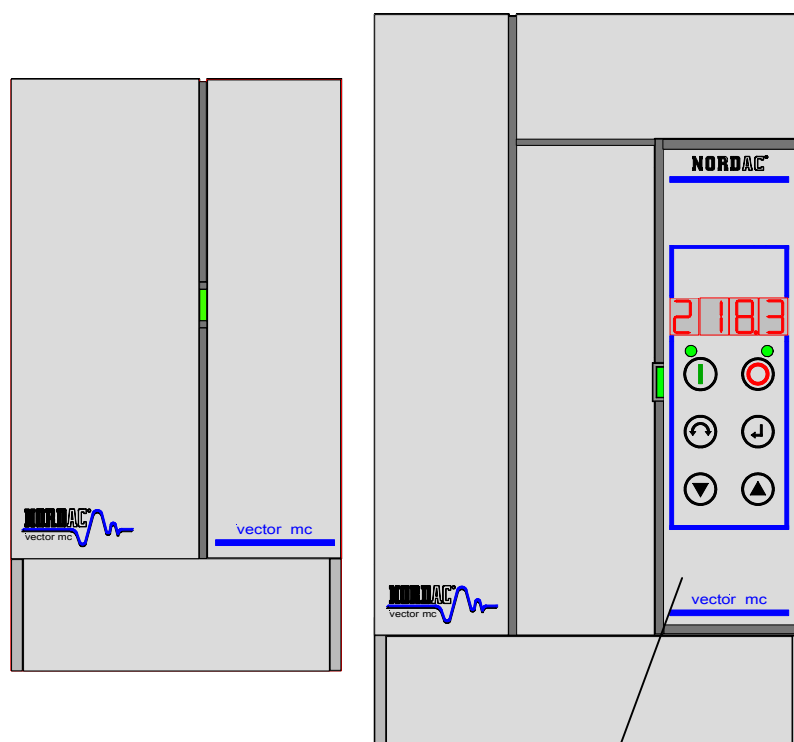

**Control Box *mc***  
available as an accessory

T. Nr. 0606 4181

**BU 4100 GB**

Last update: December 2003

**Getriebebau NORD**  
GmbH & Co. KG



**... NORD Gear**



## NORDAC *vector mc* frequency inverter

---



### Instructions for the safety and use of converters feeding drives

(as provided in the 73/23/EEC low-voltage directive)

---

#### 1. General

Depending on their type of enclosure, variable frequency inverter may have live, bare, in some cases even moving or rotating parts as well as hot surfaces during operation.

Inadmissibly removing the required covers, improper use, incorrect installation or handling can be dangerous and may lead to serious damage to persons or to property.

See the documentation for more detailed information.

Any transport, installation, starting-up or maintenance work shall be performed by properly qualified, skilled and competent personnel (IEC 364 or CENELEC HD 384 respectively or DIN VDE 0100 and IEC 664 or DIN VDE 0110 and national accident prevention regulations to be observed).

Qualified, skilled personnel as mentioned in these basic safety instructions is understood to refer to persons who are familiar with the installation, assembly, setting-up and operation of the product and who have the qualifications required for the job of which they are in charge.

#### 2. Intended use

Variable frequency inverter are components designed to be integrated into electrical installations or machinery.

If the converters are installed in machines, they must not be put into operation (in other words, operation as intended by the manufacturer must not begin) until it has been established that the machine in question actually meets the requirements mentioned in the EG directive 89/392/EEC (Directive For Machines); EN 60204 is to be observed.

The device must not be put into operation (i.e. operation as intended by the manufacturer must not be started) unless the stipulations of the EMC directive (89/336/EEC) are fulfilled.

Variable frequency inverter meet the requirements stated in the low-voltage directive 73/23/EEC. Likewise the accorded standards of the series prEN 50178/DIN VDE 0160 in conjunction with EN 60439-1/ VDE 0660 Part 500 and EN 60146/ VDE 0558 are applied to the variable frequency inverter.

Refer to the rating plate and the documentation for details on technical data and connecting requirements and do not fail to observe them and to follow instructions.

#### 3. Transport, storage

Follow the instructions for transport, storage, and proper handling.

Ensure climatic conditions as specified in prEN 50178.

#### 4. Installation

The devices must be installed and cooled as directed in the relevant documentation.

The variable frequency inverter must be protected against inadmissible stress. It is of particular importance that no components are bent and/or insulation distances changed during transport and handling. Do not touch electronic components and contacts.

Variable frequency inverter contain electrostatically sensitive components which are easily damaged through improper handling. Electrical components must not be damaged or destroyed mechanically (potential health risks!).

#### 5. Electrical connection

Follow the applicable national accident prevention rules (e.g. VBG 4) when working on variable frequency inverter while they are live.

Electrical installation is to be performed in accordance with applicable rules and regulations (e.g. regarding conductor cross sections, fusing, PE connection). Apart from these, more instructions may be mentioned in the documentation.

Recommendations for meeting EMC standards in installation - for instance with regard to screening, earthing, filter arrangement and the routing of lines - are found in the converter documentation. CE-marked variable frequency inverter are always subject to such instructions as well. It is the responsibility of the machine or plant manufacturer to ensure that the limit values stipulated by EMC legislation are duly met.

#### 6. Operation

It may be necessary to provide facilities in which variable frequency inverter are installed with additional monitoring and protecting devices to satisfy the applicable safety regulations, e.g. the law on technical work materials, accident prevention regulations etc. Modifications of the variable frequency inverter by means of the operating software are allowed.

Do not touch live parts of the device or power terminals right after the converter has been disconnected from the supply voltage as capacitors may still be charged. The information plates on the driving current converter will give you precise details on the subject.

Keep all covers closed during operation.

#### 7. Service and maintenance

As described in the manufacturer's documentation.

**Do keep these Safety Instructions for future reference!**

<b>1 GENERAL</b> .....	<b>4</b>	<b>5 PARAMETERISATION</b> .....	<b>25</b>
1.1 Overview .....	4	5.1 Survey of parameters, user settings .....	26
1.2 Delivery .....	5	5.2 Parameter description .....	29
1.3 Scope of delivery.....	5	5.2.1 Operating parameters displayed .....	29
1.4 Instructions for safety and installation.....	5	5.2.2 Basic parameters .....	29
<b>2 MOUNTING AND INSTALLATION</b> .....	<b>7</b>	5.2.3 Parameters for motor data and characteristic curves .....	32
2.1 Installation .....	7	5.2.4 Control terminals .....	35
2.2 Dimensions of the frequency inverter .....	8	5.2.5 Additional parameters .....	43
2.3 Installation with DIN attachment clip .....	9	5.2.6 Information .....	48
2.4 Installation of screen-receiving angle sockets .....	9	<b>6 ERROR SIGNALS</b> .....	<b>50</b>
2.5 Line filters (optional).....	10	6.1 Control Box <i>mc</i> (optional) error messages ....	50
2.6 Brake resistors (optional) .....	11	<b>7 TECHNICAL DATA</b> .....	<b>53</b>
2.7 Wiring instructions.....	12	7.1 SK 250/1 FCT to SK 2200/1 FCT.....	53
2.8 Electrical connection .....	13	7.2 SK 750/3 FCT to SK 3000/3 FCT.....	53
2.8.1 Block diagram.....	13	7.3 General technical data .....	54
2.8.2 Mains and motor connections.....	14	<b>8 ADDITIONAL INFORMATION</b> .....	<b>55</b>
2.8.3 Motor cable.....	15	8.1 Electromagnetic compatibility (EMC) .....	55
2.8.4 Power supply terminals 1 ~ 230 Volt .....	15	8.2 EMC table:.....	56
2.8.5 Power supply terminals 3 ~ 380 - 460 Volt .....	15	8.3 PID controller.....	58
2.8.6 Control terminals .....	16	8.4 Process controller.....	58
2.8.7 +/-10V Setpoint board (optional).....	18	8.4.1 Typical use of a process controller .....	59
<b>3 OPERATION AND DISPLAY</b> .....	<b>19</b>	8.4.2 Parameter settings on the frequency inverter.....	59
3.1 Displays without additional options .....	19	8.5 Recommendations for service and maintenance .....	60
3.2 Control Box <i>mc</i> (Option).....	19	8.6 Additional information.....	60
3.3 RS 232 Box (Option).....	22	8.7 UL/CUL certification .....	60
3.4 Profibus module (option).....	22	<b>9 INDEX</b> .....	<b>61</b>
3.5 CAN bus module (option).....	22	<b>10 SUBSIDIARIES AND BRANCHES</b> .....	<b>62</b>
3.6 CANopen module (option) .....	22		
3.7 DeviceNet module (option) .....	22		
<b>4 SETTING UP THE SYSTEM</b> .....	<b>23</b>		
4.1 Basic settings .....	23		
4.1.1 Condensed instructions for basic operation using the (optional) Control Box <i>mc</i> .....	24		

## 1 General

NORDAC *vector mc* are voltage source d.c. link inverters with microprocessor electronics designed to control the speed of three-phase motors in the power ranges 250W to 750W and 1.1kW to 2.2kW (1 ~ 230V) and 0.75kW to 3.0kW (3 ~ 380...460V). Multiple control functions, optimized power characteristics, easy handling, compact construction, and high operational dependability are the special features of these frequency inverters.

Owing to a system of vectorial current control for which no sensor is required and a motor operation analogue simulator, the inverter is capable of calculating in what way output voltage and frequency must be varied to ensure stability of the desired motor speed over a wide range of fluctuating load conditions.

### 1.1 Overview

Features and characteristics:

- high starting torque and precise control of motor speed ensured by vectorial current control without a sensor
- overload capacity: 150% of the nominal current for a period of 30 seconds
- easy installation, programming, and starting-up
- two compact housing varieties of equal mounting depth
- units can be mounted side-by-side without leaving a clearance
- 0 to 50°C permissible ambient temperature (cf. 7, technical data)
- integrated line filter meeting limit curve A requirements as per EN 55011
- can be controlled via the serial RS485 interface with the USS protocol, a single bus line affording collective control of up to 31 inverters
- default settings pre-programmed in the factory
- the stator resistance is measured and evaluated automatically
- two separate parameter sets which are switchable on-line
- the output frequency can be controlled in various ways as required:
  - by setting a frequency via a keyboard input (optional)
  - by using a highly resolving, scalable analogue setpoint (also for  $\pm 10V$  as an optional feature)
  - by applying 4 fixed frequencies to binary inputs
  - by using the motor potentiometer function
  - via a serial interface
- two programmable relay outputs
- programmable d.c. braking
- integrated braking chopper for 4-quadrant operation
- the length of acceleration/deceleration periods can be selected and a ramp smoothing programmed
- scalable analogue output, 0 – 10V
- optional: Control Box *mc*, detachable control and display module
- optional: *p-box*, external control panel with clear text display and data storage function
- optional: RS 232 *mc*
- optional: CAN Bus *mc*
- optional: Profibus *mc*
- optional: CANopen *mc*
- optional: DeviceNet *mc*

## 1.2 Delivery

Examine the device for transport damage such as distortions or loose parts **immediately** after it has arrived/been unpacked.

If damage has indeed occurred, contact the transport company without delay and ask for a precise assessment of the damage.

**Important! The same provision shall apply if the packing is undamaged.**

## 1.3 Scope of delivery

Standard package: IP 20 panel mounting unit  
 integrated braking chopper  
 integrated line filter meeting limit curve A standards as per EN 55011 (see cf. 8)  
 wall-mounting rail and DIN rail clip  
 shield connection bar  
 cover for control panel connection point  
 serial RS 485 interface  
 burden ( $250\Omega$ ), for setpoint 0/4 – 20mA (see cf. 2.8.6)  
 operating instructions

Accessories available: **Control Box mc**, detachable control panel    Caution! Follow safety instructions!  
 Additional p.c. board for  $\pm 10V$  setpoint evaluation  
 Brake resistor IP 20 to be fitted on bottom side  
 Line filter meeting limit curve B requirements as per EN 55011, for underside fitting Line  
 and output chokes, IP 00  
**RS 232 mc**, additional module for RS 232 interface  
**CAN BUS mc**, additional module for CAN bus configurations  
**CANopen BUS mc**, additional module for CANopen bus configurations  
**DeviceNet mc**, additional module for DeviceNet configurations  
**Profibus mc**, additional module for Profibus DP configurations  
 Interface converter RS 232 → RS 485  
**p-box**, (ParameterBox) external control panel and clear text display

## 1.4 Instructions for safety and installation

NORDAC *vector mc* frequency inverters are operational equipment for use in industrial power plant. That is why touching them may cause, due to the voltages at which they are operated, serious injuries or even death.



- Only skilled personnel qualified in electrotechnical professions is allowed to perform installation or any other work on the devices provided that these have previously been disconnected from supply. The personnel involved must have access to the Operating Instructions any time and observe them conscientiously without exception.
- Local regulations governing the installation of electric plant as well as any regulations for accident prevention have to be observed.
- The device is still dangerously live for up to 5 minutes after its disconnection from the mains. Therefore the device must not be opened or either the cover or the control panel be detached until 5 minutes after it has been disconnected from supply. Reattach all covers before switching the mains voltage on again.
- Even when the motor has stopped (e.g. as a result of electronic disable, jamming of the drive, or a short-circuit of the output terminals), the supply terminals, the motor terminals, and the terminals for the braking resistor can be dangerously live. Even if the motor is not running it can by no means be assumed that it is also electrically isolated from the mains.
- **Caution**, parts of the control board and especially the edge socket connector for the detachable control panel are dangerously live, too, whereas the control terminals are not at mains potential.
- **Attention**, certain setting configurations may cause the inverter to start up automatically when it is connected to the mains.



- The printed circuit boards carry highly sensitive MOS semiconductor components for which static electricity can be particularly harmful. That is why you should avoid to touch the conductive tracks or electronic components with your hands or with metallic objects. When connecting the cables take care to touch the screws of the terminal strips only using insulated screwdrivers for the procedure.
- The frequency inverter is designed for permanent connection only and must not be operated without having been effectively earthed as stipulated by the local regulations for high leakage currents (> 3,5mA). VDE 0160 demands that either a second earth conductor be laid or that the earth conductor cross section be 10mm<sup>2</sup> minimum.
- If local regulations do not permit the leakage current of three-phase frequency inverters to contain any amount of direct current, other protection equipment must be used in addition to the conventional **fault-current circuit breakers**. The construction of the standard fault-current circuit breakers is supposed to meet the new VDE 0664 requirements.
- NORDAC *vector mc* frequency inverters are maintenance-free provided that they are operated according to instructions. If there is dust in the air, the cooling surfaces must be cleaned with compressed air regularly.

**CAUTION! DANGER!**

**The power section can still be live for up to 5 minutes after disconnection from the mains. Inverter terminals, motor supply cables, and motor terminals can be live, too!**

**Touching exposed or unconnected terminals, cables, or parts of the device may lead to serious injuries or even death!**

	<p><b>CAUTION</b></p> <hr/> <ul style="list-style-type: none"> <li>• Ensure that neither children nor the general public will have access to the device or a chance to manipulate it!</li> <li>• The device must not be used for any purpose other than the one intended by the manufacturer. Unauthorized modifications and the use of replacement parts and attachments which are not sold or recommended by the manufacturer, may cause fire, electric shock and injuries.</li> <li>• Keep these Operating Instructions in a place where it will be accessible any time to anyone wishing to read them, or hand them on your own accord to anyone involved in using the device!</li> </ul>
--	---

**European EMC Directive**

If the NORDAC *vector mc* is installed in accordance with the instructions of the present manual, it will meet all of the requirements of the EMC directive as stipulated in the EN61800-3 EMC product standard for motor-driven systems (cf. Section 8.1/8.2 Electromagnetic compatibility (EMC)).



**North America, UL and CUL licenses**

*“Suitable for use on a circuit capable of delivering not more than 5000 rms symmetrical amperes, 230 volts (single-phase current / 460 volts (three-phase current))” and “when protected by J class fuses as indicated in section 7.”*

**File: E171342, Vol.1 Sec.2**



## 2 Mounting and Installation

### 2.1 Installation

NORDAC *vector mc* frequency inverters come in two sizes covering a higher and a lower output range. Both inverter types have the same installation depth however, and it is only the frame dimensions which are different (cf. 2.2 Frequency inverter dimensions). To ensure sufficient ventilation, a clearance of  $>100\text{mm}$  should remain above the frequency inverters and one of  $>120\text{mm}$  below them and the confinements of the switch cabinet.

This extra room can be used to accommodate electrical components (such as cable ducts, contactors etc.). The distance to be ensured between such objects and the inverter depends on how high they are. It should amount to  $2/3$  of the object height minimum (example: height of cable duct  $60\text{mm} \rightarrow 2/3 \cdot 60\text{mm} = 40\text{mm} = \text{distance from inverter}$ ).

No extra lateral distance will have to be provided between the devices however. They may be installed in a row right beside one another on a DIN rail or directly on the mounting plate using the attachment rails which are supplied along with each new device. The mounting position is vertical always.

**Make provisions for the hot air above the devices to be properly carried off!**

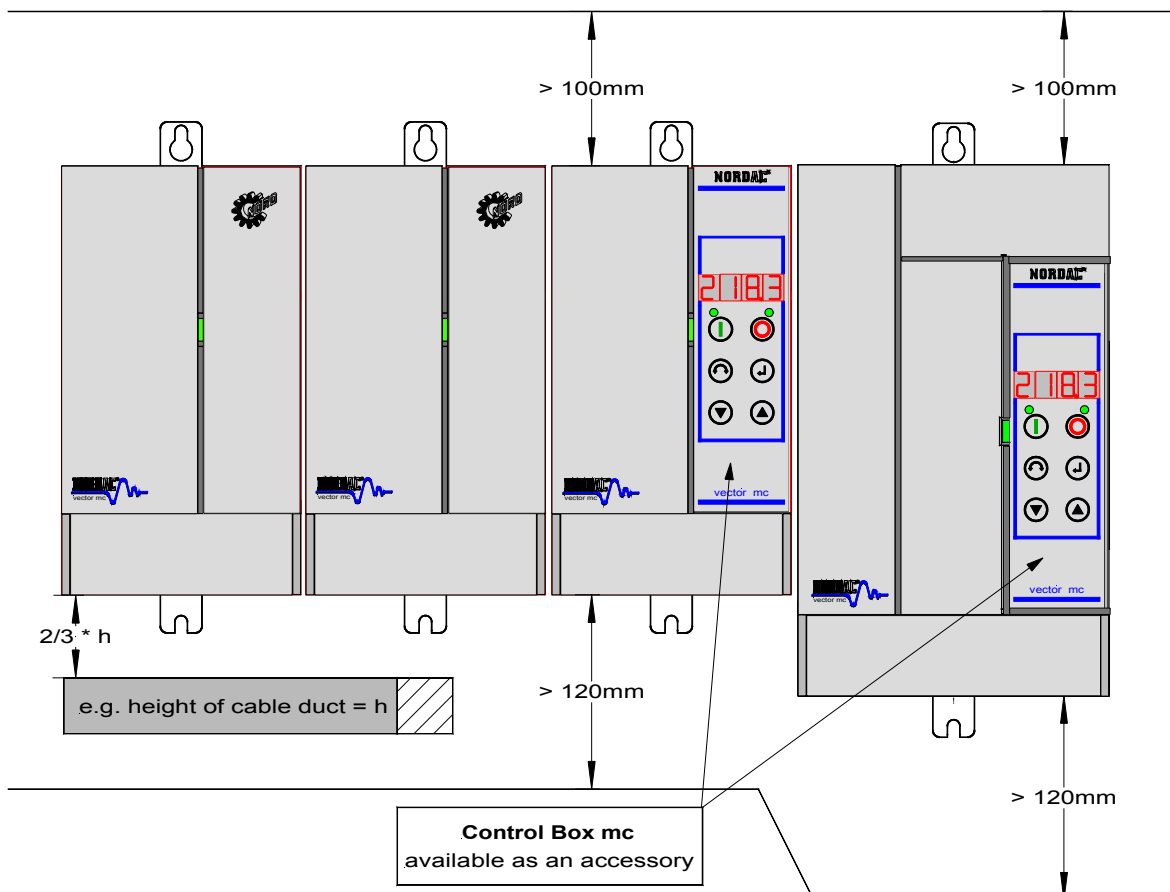

If several inverters are arranged one above the other, the temperature of the air that is drawn in should not exceed neither the upper nor the lower limit  $\rightarrow 0 \dots 50^\circ\text{C}$  (cf. Section 7 Technical data). It would be a good idea to provide an “obstacle” (e.g. a cable duct) between the inverters which will divert the upward current of warm air.

More information on how to fit the DIN rail clip is offered in paragraph 2.3 Installation with DIN attachment clip.

## 2.2 Dimensions of the frequency inverter

Version shown: IP 20

Inverter type	Length "L1"	Width "W1"	Depth "D"	Detail: Attachment rail			DIN clip	
				Length "L2"	Hole spacing "L3"	"a"	"b"	
SK 250/1 FCT to SK 750/1 FCT	154	86	134	184	177	15	35	
SK 1100/1 FCT to SK 2200/1 FCT	191	112	135	221	213,5	15	74	
SK 750/3 FCT to SK 3000/3 FCT								

All dimensions in mm

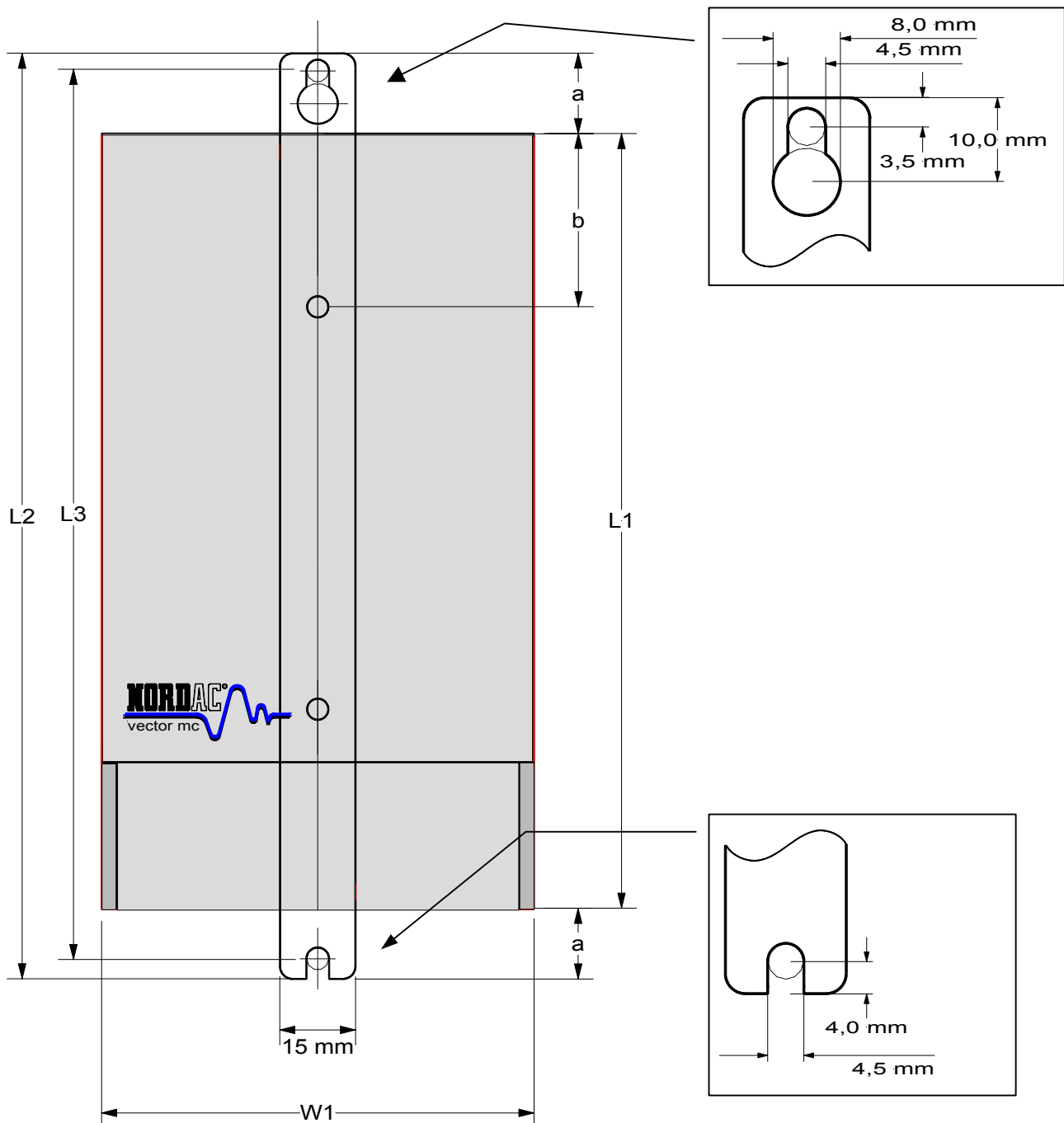



### 2.3 Installation with DIN attachment clip

Use the DIN rail clip enclosed with the inverter to convert the device for DIN rail mounting.

The picture below shows how this is done. Do not remove the standard mounting rail however – simply leave it in its place.

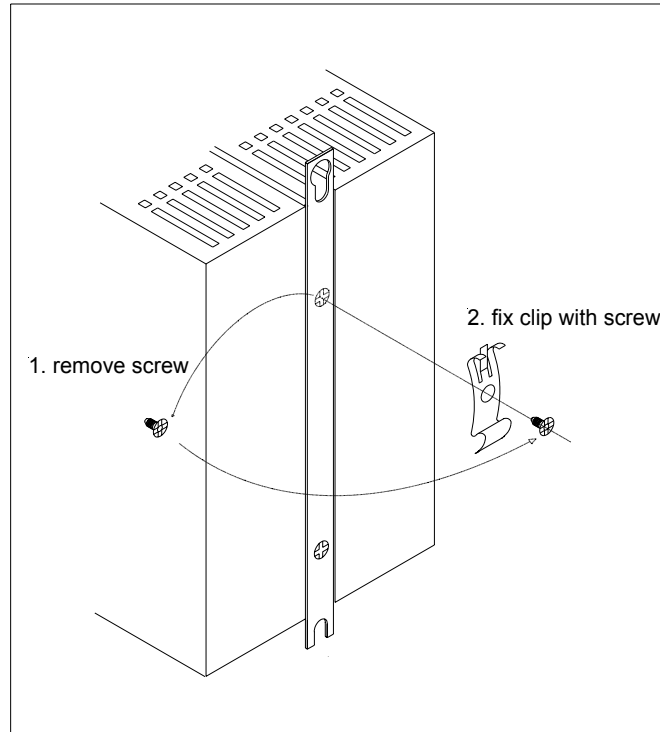

### 2.4 Installation of screen-receiving angle sockets

The best way to connect the screen of a motor cable or a control line is to use the angle socket with screws and clamps provided for the purpose. Electromagnetic compatibility of the wiring is thus ensured as stipulated (cf. Section 8.1/8.2 EMC).

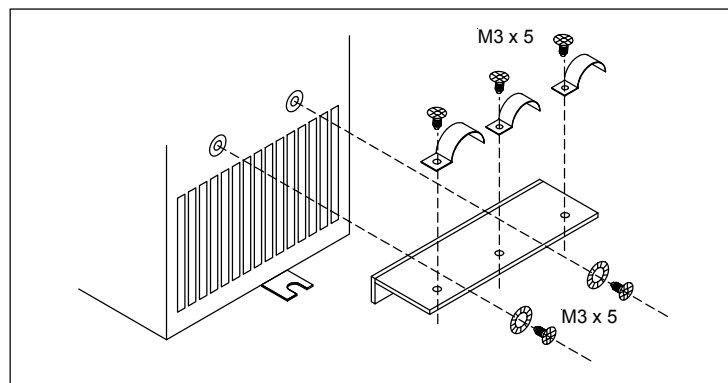

**NOTE:** To attach a cable lug (PE) to the PE stud terminals of the inverter, two fan-type lock washers must be used for each M3 screw.  
The SK 3000/3 FCT need screws M3 x 8.

## 2.5 Line filters (optional)

To ensure that the requirements for a higher radio interference suppression level are met (class B as per EN 55011), an additional line filter can be looped in the supply line of the inverter.

The filter may be installed either in a vertical ("bookshelf") fashion on the inverter side or horizontally below it. Two sizes are available – one for outputs up to and including 750W and one for outputs greater than 750W, or for single- or three-phase power supply respectively.

When connecting the line filter please make sure that the "Wiring Instructions" (Section 2.7) and EMC regulations (Sections 8.1/8.2) are followed.

Table referring to IP 20 type of protection.

Inverter type	Filter type	Length „L1“	Width „W“	Depth „D“	Detail: Attachment		
					Length „L2“	Spacing of holes „L3“	„a“
SK 250/1 FCT to SK 750/1 FCT	<b>HFE 141-230/ 9</b> 230V/ 9A	188	87	44	220	174	43,5
SK 1100/1 FCT to SK 2200/1 FCT	<b>HFE 141-230/18</b> 230V/18A	228	112	44	260	214	56
SK 750/3 FCT to SK 3000/3 FCT	<b>HFD 141-400/10</b> 400V/10A	228	112	44	260	214	56

All dimensions in mm

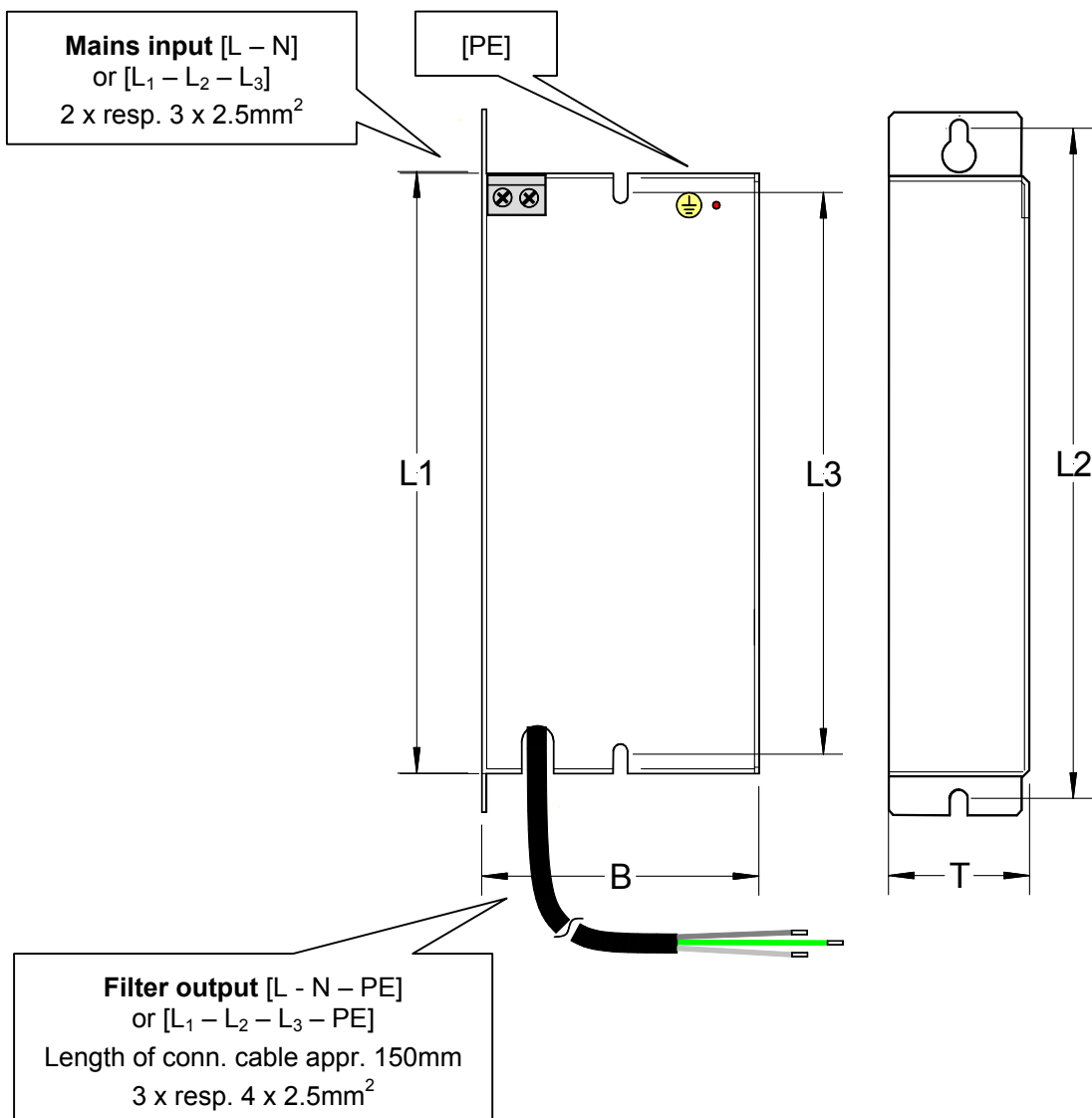

### 2.6 Brake resistors (optional)

Dynamic deceleration of a three-phase motor (with the frequency being reduced) involves a recovery of electric energy which is fed back to the frequency inverter. To prevent the inverter from being disconnected for over voltage, an external brake resistor can be connected which will enable the integrated braking chopper to convert the recovered energy into heat.

The brake resistor can be installed on the bottom side of the inverter. Sufficient protection against accidental contact must be ensured. The resistor may grow very hot during operation. Three brake resistor sizes are available, one for outputs up to 750W, one for outputs up to 2.2kW (230V), and one for outputs up to 3kW (380-460V). Regarding their electrical properties, the resistors specified are rated for standard applications. The continuous rating indicated in the table below must not be exceeded. The pulse power is related to a percentage duty cycle of 4 % (5 sec.) with a cycle duration of 120 seconds.

When connecting the brake resistors see to it that the "Wiring Instructions" (Section 2.7) are observed.

Table referring to IP 20 type of protection.

Inverter type	Brake resistor			Length „L1“	Width „W1“	Depth „D“	Hole spacing „L2“
	Resistance	Continuous rating	Pulse power				
SK 250/1 FCT to SK 750/1 FCT	180Ω	50W	800W	190	82	30	177
SK 1100/1 FCT to SK 2200/1 FCT	82Ω	100W	2000W	224	108	30	214
SK 750/3 FCT to SK 3000/3 FCT	120Ω	180W	3000W				

All dimensions in mm

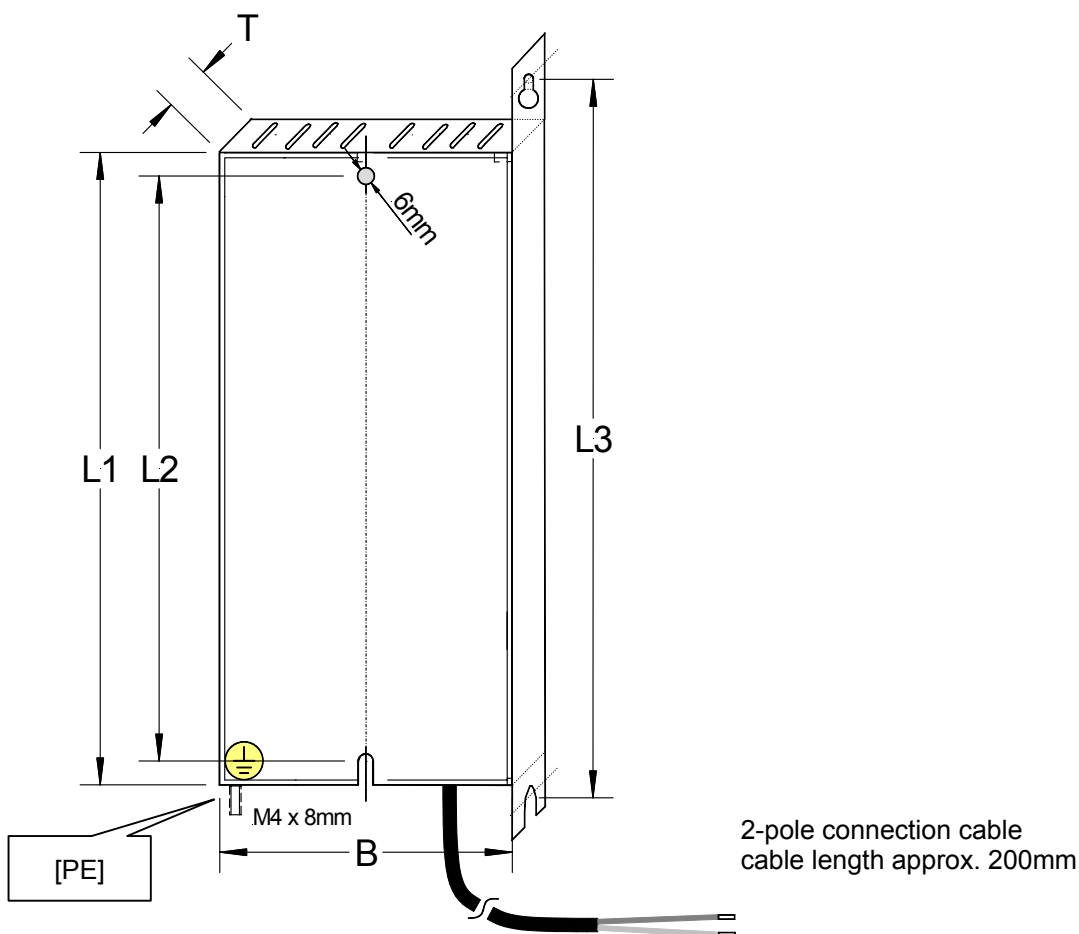

## 2.7 Wiring instructions

The inverters were designed for operation in industrial environments where electromagnetic interference can be expected to attain high values. In general, if installation is carried out in a workmanlike manner, inverters will work safely and without giving trouble. If limit values more rigid than those indicated in the EMC rules must be met, the instructions given below should be useful:

- (1) It is very important that all devices in the cabinet are effectively earthed. That is why you should use short earth conductors with a large cross-section and connect them to a common earth connection point or earth bus bar. Any control device (e.g. an automation unit) connected to an inverter must by all means be connected to the same earth connection point as the inverter itself via a short conductor with a large cross sectional area. With their lower impedance at high frequencies flat conductors (such as metal bows) are best suited for the purpose.

If possible, the PE conductor of the motor controlled by an inverter should be connected directly to the earth connection point which is connected to the heat sink, as should the PE of the mains supply cable of the respective inverter. By providing a central earth bus bar in the switch cabinet and jointly connecting all PE conductors to this bar, trouble free operation is normally ensured (cf. Mains and motor connections, Section 2.8 and EMC, Section 8.1).

- (2) Use shielded cables for control circuits if possible. Terminate the cable ends carefully and see to it that the wires are not left unshielded for any significant length. Only one end of the shield of analogue setpoint cables should be connected to earth at the frequency inverter (cf. Section 2.4).
- (3) Control wires and load wires should be laid at an adequate distance from each other if possible, for instance by using separate cable ducts etc. If line crossings can't be avoided, try to arrange a 90° angle.
- (4) Take appropriate measures to ensure that no interference will be emitted by the contactors in the cabinets. Alternate voltage contactors should be included in an RC circuit while direct current contactors should be provided with freewheeling diodes, **with the interference suppression components being fixed to the contactor coils**. Varistors for over voltage limitation have a noise suppression effect as well. Interference suppression is indispensable especially if the contactors are controlled by the relays in the inverter.
- (5) Use screened or armoured cables for the load connections, and connect the screening/armouring to earth at both ends - if possible directly at the PE / shield-supporting bar of the frequency inverter (cf. Section 2.4).
- (6) If the drive is to work in an environment which is sensitive to electromagnetic interference, we recommend to use radio interference suppression filters to reduce the noise emitted by the inverter and the cabling. Fit the filter as closely as possible to the inverter and ensure effective earthing.

In addition the inverter must be installed in an interference-proof housing along with the filter. The wiring is to meet EMC requirements (cf. Section 8.1/8.2, EMC).

- (7) Select the lowest switching frequency the inverter will allow. With this measure the intensity of the electromagnetic interference produced by the inverter is reduced.

**While you are installing the inverters never do anything to violate the safety regulations!**



### Note

Control lines, supply lines, and motor leads must be laid separately. They should never be laid in the same conduit/installation duct together. The test equipment for high-voltage insulation's must not be used for cables which are connected to the inverter.

## 2.8 Electrical connection

### 2.8.1 Block diagram

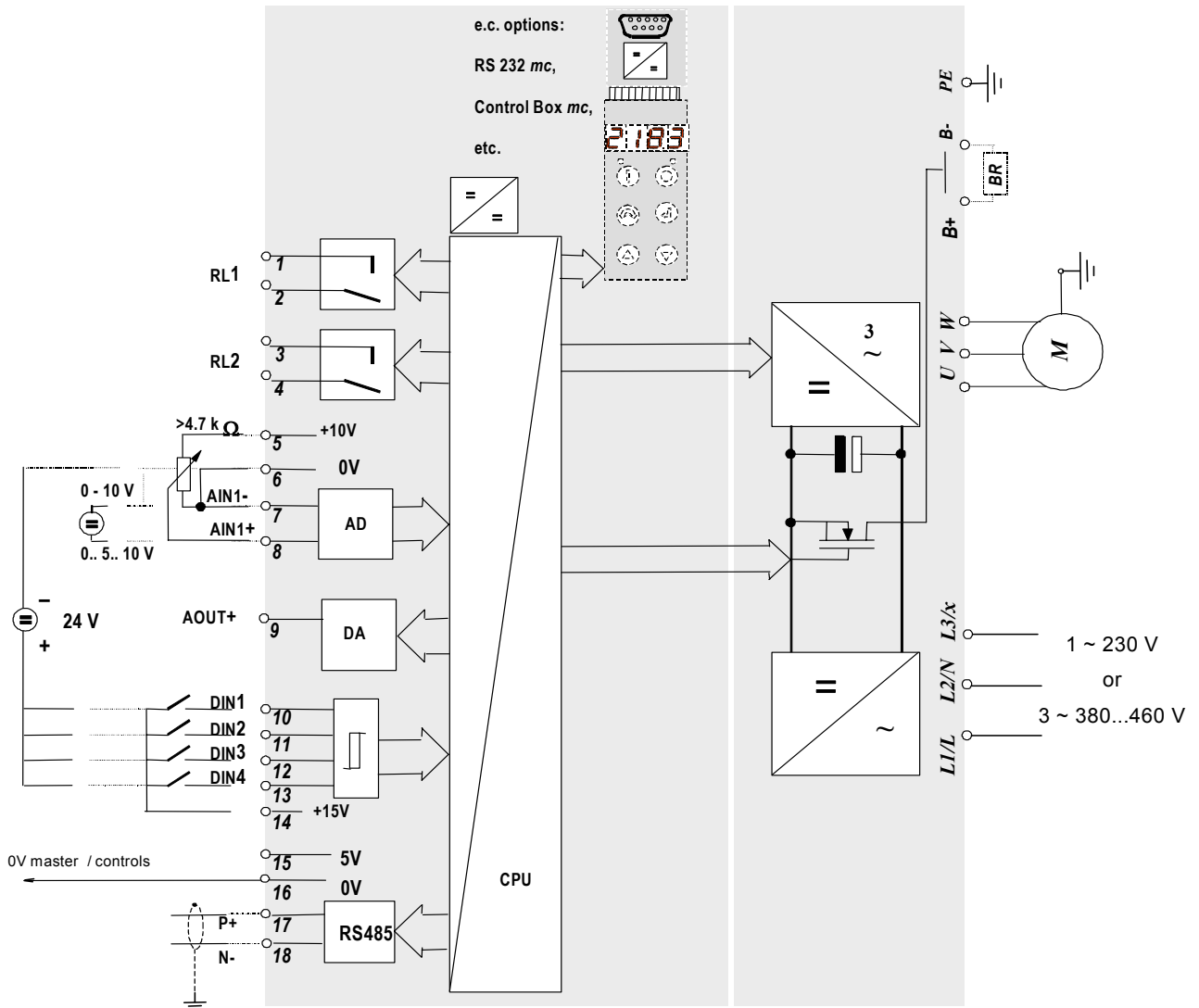

## 2.8.2 Mains and motor connections



### WARNING

---

THESE DEVICES MUST BE EARTHED.

For the device to work safely and reliably it must have been installed and put into operation by qualified personnel in a workmanlike manner, with all of the instructions mentioned in the present Operating Manual being followed as specified.

In particular both the generally and locally applicable installation and safety regulations for work on power installations (e.g. VDE) and the regulations concerning the professional use of tools and the use of any equipment for personal protection must be observed.

The mains input and the motor connecting terminals may be dangerously live even if the inverter is out of operation. Always use insulated screwdrivers in these terminal areas.

Make sure that the source of input voltage is disconnected before you establish connections to the unit or change them.

**Make sure that the frequency inverter and the motor are rated to match the connecting voltage. Single-phase 230V NORDAC *vector mc* frequency inverters must not be connected to a 400/460V three-phase network.**

**Note:** Whenever synchronous machines are connected or several motors are coupled in parallel, inverter operation must be based on a linear voltage-to-frequency characteristic, (P211=0) and (P212=0).

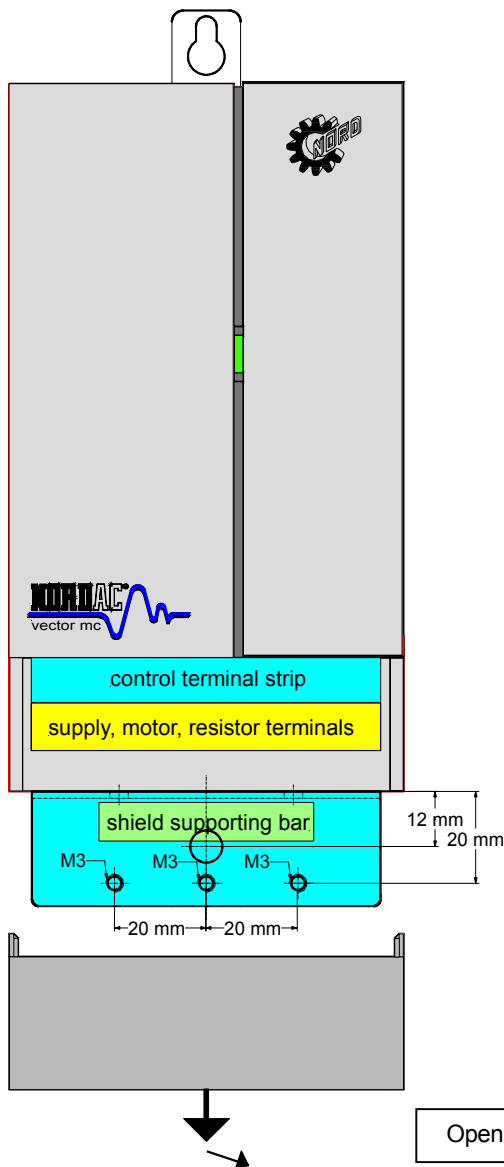

The supply, motor, brake resistor and control connections are located on the bottom side of the device. To access the terminals the cover plate must be pushed downwards or unhooked altogether as shown in the picture (push downwards and unlock by exerting a slight pressure towards the front). Now the two terminal strips are accessible from the front. Before the supply voltage is connected the cover must be hooked in again vertically and closed!

As a rule the supply, motor, and brake resistor lines are wired first as the terminals required are located on the lower p.c. board. The cable is fed through a slot-shaped opening on the bottom side of the device.

#### Important procedures:

1. Make sure that the voltage source is supplying the right voltage and is rated for the required current (cf. Section 7, Technical Data). Ensure that power switches suitable for the specified nominal current range are connected between voltage source and inverter.
2. Connect the mains input directly to the mains terminals L-N (single-phase), or L<sub>1</sub> – L<sub>2</sub> – L<sub>3</sub> (three-phase) respectively, and to earth (PE). Individual wire cross sections see Section 8.
3. Use a four-wire cable to connect the motor. The cable is connected to the motor terminals U, V, W, and to PE (cf. the illustrations on the following pages).
4. If shielded cables are used, a generous length of the cable shield can additionally be connected to the shield clamping device.

**Note:** Be sure to use shielded cables only, otherwise there is no guarantee that the specified radio interference suppression levels (cf. 8.1/8.2 EMC) are ensured.

### 2.8.3 Motor cable

The **total length** of the motor cable must not exceed **150m** (please note also Section 8.1 EMC). If a shielded motor cable is used or if the metallic cable duct is effectively earthed, **maximum** should not exceed **50m**. If longer cables are necessary, additional output chokes must be provided.

In case of multiple-motor operation the sum of the individual cable lengths will be considered as the total cable length. If the sum total of the various cable lengths is too high, one output choke each per motor / per cable should be used.

### 2.8.4 Power supply terminals 1 ~ 230 Volt

#### SK 250/1 FCT ... SK 1500/1 FCT

The power supply terminals are suitable for a maximum line cross sectional area of **2.5mm<sup>2</sup>**.

A cross section of only 1.5mm<sup>2</sup> max. will be available though if special end sleeves for wires are used.

#### SK 2200/1 FCT

The terminals of the SK 2200/1 FCT inverter type providing an output of 2200W are rated at a maximum cross section of **4mm<sup>2</sup>**.

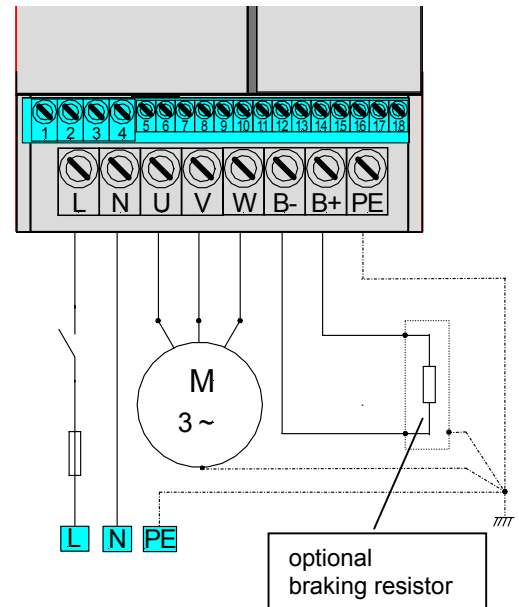

### 2.8.5 Power supply terminals 3 ~ 380 - 460 Volt

#### SK 750/3 FCT ... SK 3000/3 FCT

The power supply terminals allow for connection of conductors with a maximum cross sectional area of **2.5mm<sup>2</sup>**.

Only a cross section of 1.5mm<sup>2</sup> max. will be available if a special type of end sleeves for wires is used.

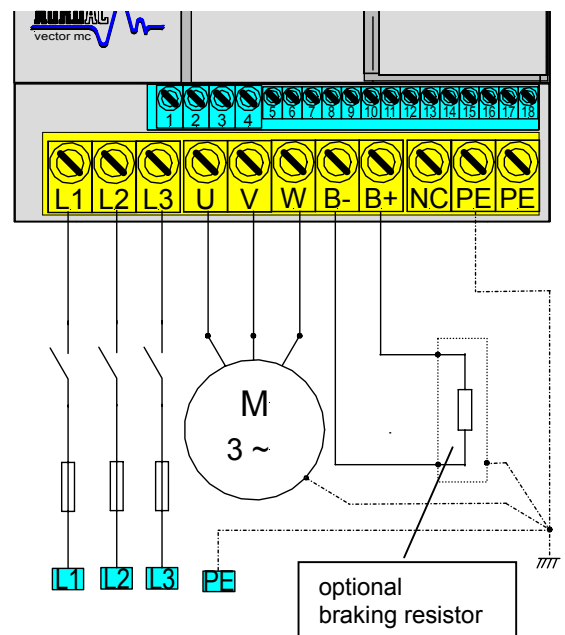

## 2.8.6 Control terminals

- Control wires to be connected to: - 18-pole control terminal strip, divided into 2 blocks
- Maximum connection cross section: - 1.5 mm<sup>2</sup> for relay outputs (left block)  
- 1.0 mm<sup>2</sup> for analogue and digital inputs and outputs (right block)
- Cables: - to be laid separately from supply/motor leads and to be shielded
- Control voltages: - 5V, 400mA max., also for supply of the optional *p-box*  
(*short-circuit-proof*) - 10V, 10mA max., reference voltage for a potentiometer  
- 15V, 100mA max., to feed the digital inputs  
- analogue output 0 – 10V, 5mA, for an external display unit

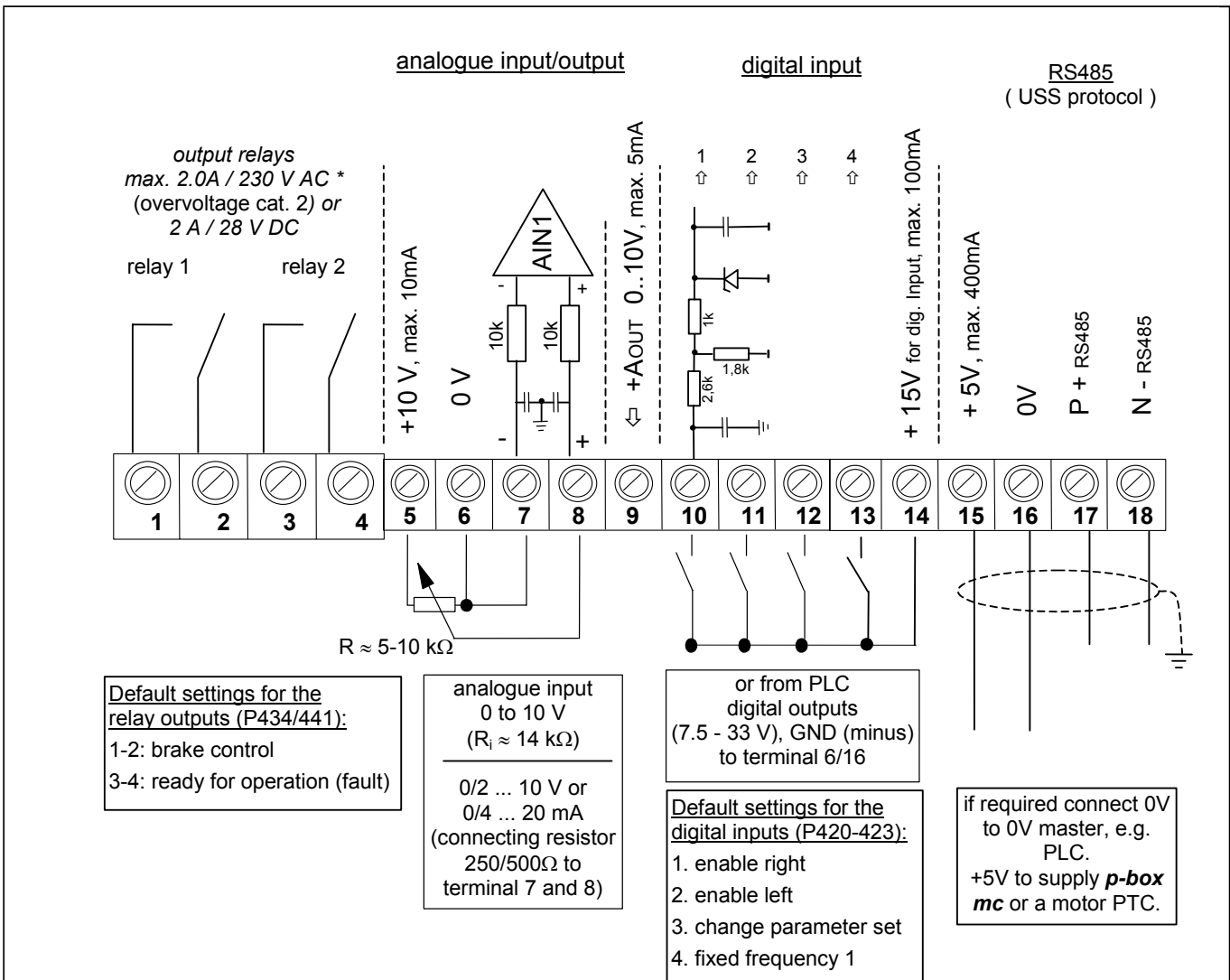

**Notes:**

All voltages are related to a common reference potential (GND, terminals 6 / 16).

**Dig. inputs:**

Digital input 1 is designed as a fast-reacting input with a total response time of approx. 1.2 ms.

The other digital inputs take about 6-10 ms to respond.

**Output relays**

\*) control clamps 2-3 maximum 230 V AC



**Motor temperature sensor:**

To protect the motor from overheating, a **temperature sensor (PTC resistor)** can be connected to any of the digital inputs. For this monitoring function to be ensured the parameter assigned to it (P420 ... P423) must be set to the value of 13. Too high a PTC resistor voltage is prevented by internal inverter control.

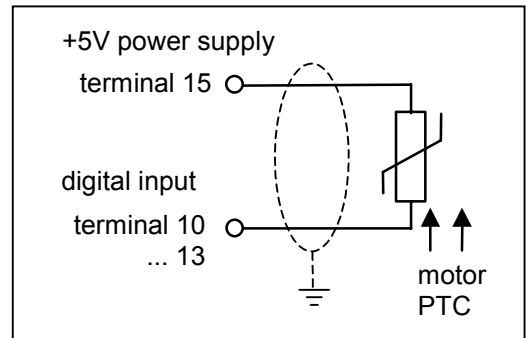

**0/4 ... 20mA current setpoint:**

A 250Ω load resistor is supplied with the inverter. This is used to convert the current setpoint into a voltage setpoint.

The following parameters may need adjusting

**P401 = 2** (0-10Volt monitored,....below 10V (or 2mA) the inverter output turns off.

**P402 = 0.0** (for 0mA minimum setpoint)  
or = **1.0** (for 4mA minimum setpoint)

**P403 = 5.0** (for 20mA maximum setpoint)

[20mA \* 250Ω = 5V]

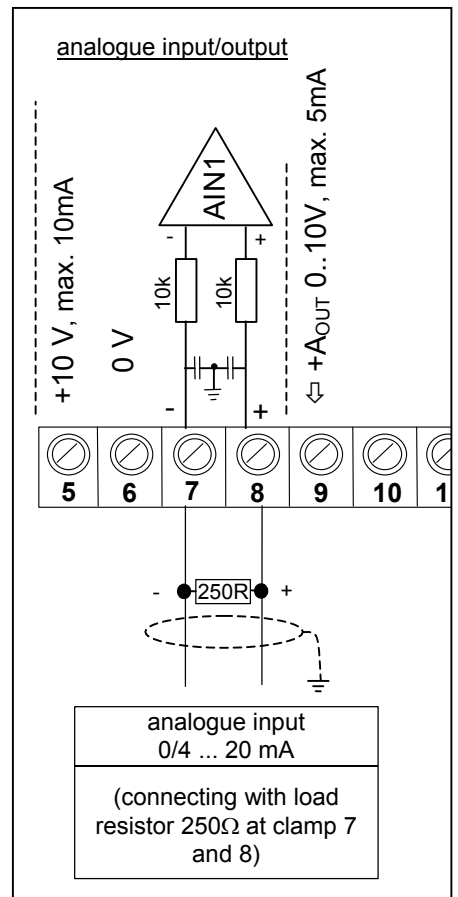

### 2.8.7 +/-10V Setpoint board (optional)

With the +/- 10V setpoint board for NORDAC *vector mc* frequency inverters it is possible to control the devices via bipolar setpoint (+/- 10V).

#### Installation

The setpoint board is connected directly to terminals 5 to 14 of the control terminal strip.  
The terminals for the digital inputs **are directly plated through** becomes “are directly connected through”.

#### Operation and parameter adjustment

The +/- 10V setpoint board ensures that an external bipolar voltage setpoint signal (-10V to +10V) is converted and represented as a 0 to 10V signal. In being adapted the setpoint is also inverted. Some of the inverter parameters need to be adjusted so as to enable this additional function to be processed.

Parameter no.	Designation	Range of values	Factory setting	Setting for +/- 10V setpoint	
				P. set 1	P. set 2
<b>P401</b>	Analogue input mode	0 ... 2	0	1	
A <b>0 – 10V</b> signal enables the inverter to supply output frequencies below the programmed minimum frequency (P104) if a setpoint less than the programmed 0%-alignment (P402) is applied. So this is a way to effect a commutation of the phase sequence.					
<b>P402</b>	Analogue input alignment to 0%	0.0 ... 10.0 V	0.0	5.0	
The offset may have to be slightly adjusted → 5.1V					
<b>P403</b>	<b>Analogue input alignment to 100%</b>	0.0 ... 10.0 V	10.0	0.0	
The offset may have to be slightly adjusted → 0.2V					
<b>P505 (P)</b>	<b>Absolute minimum frequency</b>	0.1 ... 10.0 Hz	2.0	2.0	2.0
To extend the hysteresis range, the absolute minimum frequency may be very slightly increased (to 3.0 Hz max.).					

The terminals for the digital inputs as well as the analogue output are directly plated through.



An unconnected setpoint input may result in the inverter recognizing a voltage signal which was never defined (>0V).

**Note:** When the analogue setpoint is not used, a jumper should be connected to terminals 7 / 8.

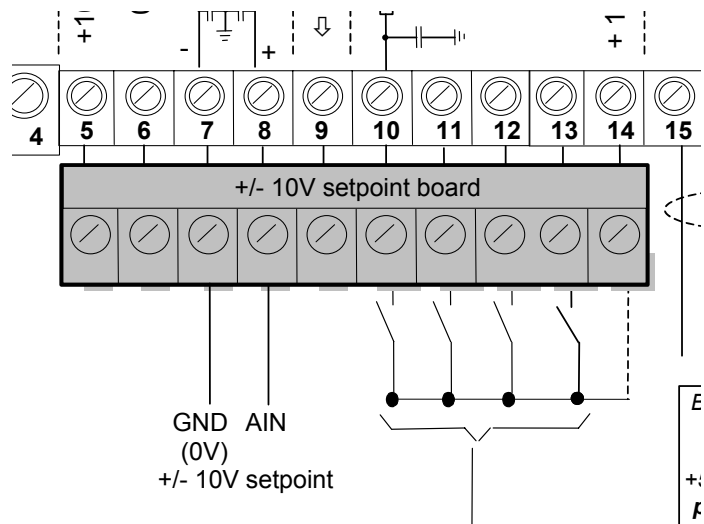

### 3 Operation and display

As the **standard equipment** of the NORDAC *vector mc* frequency inverter **does not include** a manual control panel, parameter settings must necessarily be transmitted via the RS 485 interface using the US protocol. Alternatively any of the following options are available:

- RS 232 *mc*
- Profi Bus *mc*
- CAN Bus *mc*
- CANopen *mc*
- DeviceNet *mc*
- **Control box *mc*** (key pad)
- **p-box** (clear text key pad)  
see manual BU 4040 or BU 0040

Please check whether any supplementary equipment or software will be required for the modules mentioned above.

#### 3.1 Displays without additional options

**Mains voltage being applied** to the NORDAC *vector mc* is indicated by an LED illuminated green.

If a **fault** has occurred a red LED will be glowing as well.

Moreover factory settings allow for verification of the inverter's readiness for operation via the fault signalling relay (relay 2, control terminals 3-4 or relay 1, control terminals 1-2, with P434=7).

- contact closed = FI is ready for operation
- contact open = fault has occurred

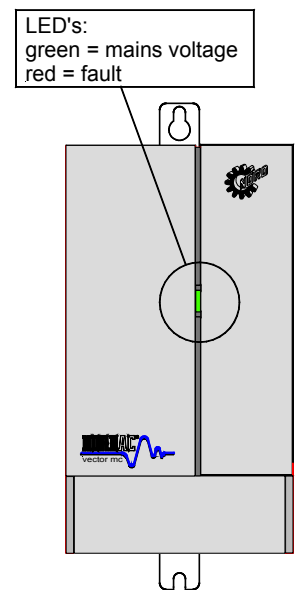

#### 3.2 Control Box *mc* (Option)

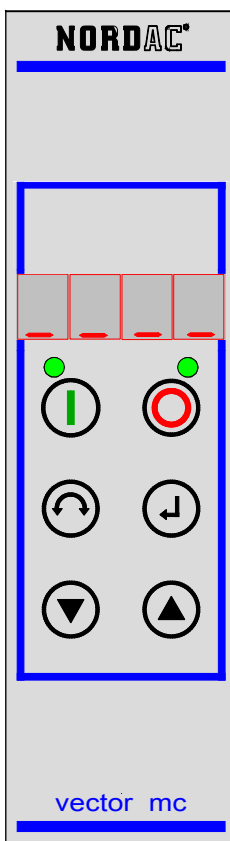

### CAUTION



The digital frequency setpoint is pre-set at 0Hz at the factory. In order to check whether the drive is working, either a frequency setpoint should be entered by operating the  button, or a start-off frequency be set via the applicable parameter (P113).

Only properly qualified personnel should be allowed to perform settings, while strictly complying with the warnings and safety instructions.

To **assemble** the Control Box *mc* with the inverter proceed as follows:









1. Switch off the mains voltage, wait for the period specified before you
2. remove the blind cover by simply pulling it off at the upper edge.
3. First hook in the Control Box *mc* at its lower end and then let it snap into place at the upper end with a click by pushing it lightly upwards and towards the assembly surface at the same time.

After the power has been turned on again, four dashes are displayed signalling readiness for operation.

The required **parameter settings** can be made using the three buttons ,  and  on the Control Box *mc* of the inverter. The parameter numbers and values are read out by a 4-digit, 7-segment LED display.

The Control Box *mc* **cannot be installed anywhere else** but directly on the inverter.

**Functions of the Control Box *mc* :**

	Operate this button to switch the inverter on. If a start-off frequency has been set (P113), the inverter is now enabled at this frequency. Any pre-set minimum frequency (P104) is added to it. Parameter 509 must be = 0.
	Operate this button to switch the inverter off. The output frequency is reduced to the absolute minimum frequency (P505), and the inverter disconnects the output side.
<b>7-segment LED display</b>	While operation is in progress the display indicates the value currently set (selection in P001) or the error codes. During parameterisation it reads out the parameter number or the parameter value.
 	While P000 is activated, the LED's show the current set of operation parameters, and during parameterisation the parameter set (1 or 2) in which the settings are being made.
	Operation of this button will cause a reversal of the phase sequence of the motor. A negative phase sequence (rotation left) is indicated by a minus sign. <b>Caution!</b> This function is inappropriate where pumps, conveyor screws, fans etc. are involved. The button is <b>disabled</b> via parameter P540.
	Use this button to INCREASE the frequency. During parameterisation it will be the parameter number or value that is increased.
	Use this button to DECREASE the frequency. During parameterisation it will be the parameter number or value that is decreased.
	Operate the ENTER key to save a parameter value after a modification or to switch between parameter number and parameter value.  <b>NOTE:</b> If you have changed a value but <u>don't</u> want to <u>save</u> it, the  key can be used to quit the parameter without the change being read into memory.

**Controlling the inverter with the Control Box *mc***

If you want to control the inverter via the Control Box *mc*, do not previously enable the inverter via the control terminals or via a serial interface (P509 = 0).

If the "START" button is pressed, the operating value display of the inverter is activated (to be selected in P001).

The inverter will supply 0Hz or any higher minimum frequency set in P104. Only after the inverter has been switched off with the "STOP" key is it possible to quit the operating value display mode and to parameterise the inverter.

**Frequency setpoint:**

The frequency setpoint currently active will depend on the value set in the start-off frequency parameter (P113) and on the selected minimum frequency (P104). When the inverter is operated via the keyboard, the frequency setpoint can be varied with the value+ and value- keys and be permanently stored in P113 as a start-off frequency for the next time it will be used.

**Instant stopping:**

To bring about instant stopping, the „STOP“ and „Phase sequence reversal“ keys should be pressed simultaneously.

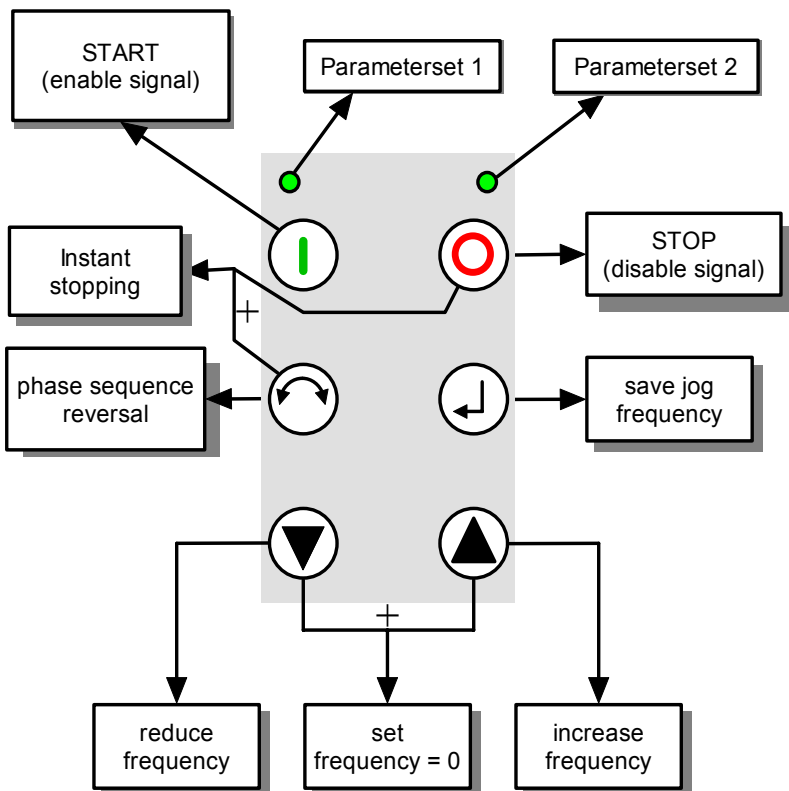

**Parameterisation with the Control Box *mc***

Parameter setting in this mode can be made

- a) if the inverter has not been enabled (START) via the Control Box *mc* ...

if the inverter is controlled via the control terminals, all of the parameters can be changed "on-line" any time.

or

- b) if the inverter has been enabled via the Control box *mc*, after the "START" and "ENTER" keys have been operated simultaneously.

To return to the control mode while the inverter is in an enabled state, the "START" key should be used.

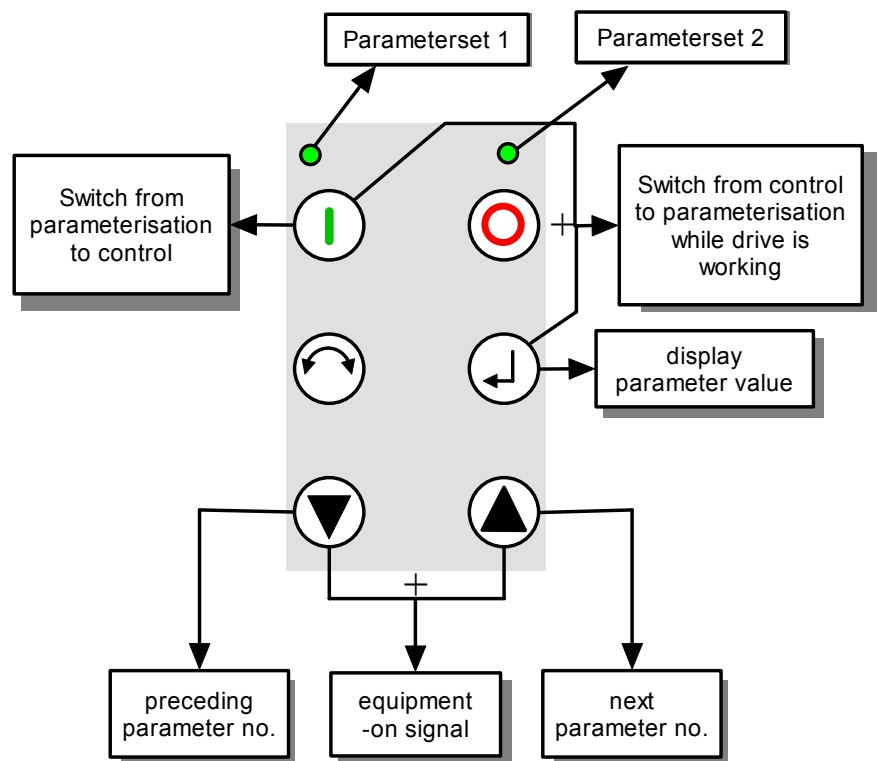

All parameters are arranged in numerical order and in an annular structure at the same time. This will enable you to page forward or back-ward as required.

Each parameter is assigned a parameter number → Pxxx.

To **change a parameter value**, the ENTER key must be pressed when the parameter number in question is displayed.

The value display keeps flashing until a value after having been changed is also validated with the "Enter" command and thus transferred to the inverter memory. While parameter adjustment is going on, display is steady to facilitate reading.

If you do not want the change to be permanent, you can quit the parameter using the key for phase sequence reversal.

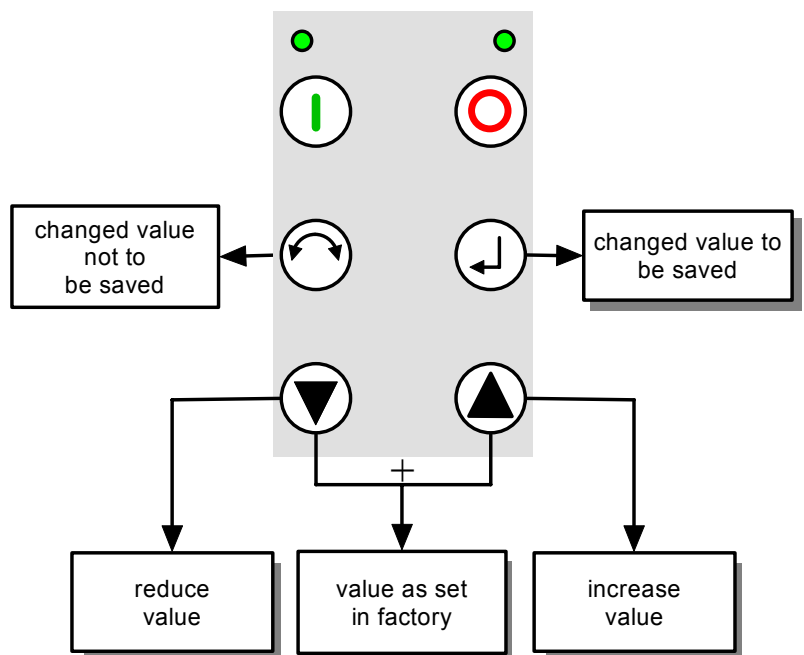

### 3.3 RS 232 Box (option)

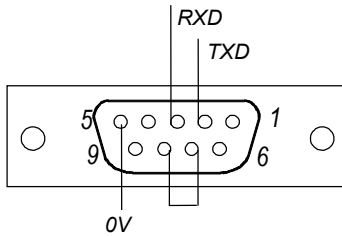

**RS 232 mc  
SUB-D 9**

The RS 232 Box is installed in the same way as the Control Box *mc* (cf. 3.2). Then a cable connection must be laid from the serial PC interface to the RS 232 module.

For communication between PC and inverter the NORD CON software (Windows) can be used.

This interface will allow control and parameterisation of the inverter connected to it so that a performance check of the inverter can easily be run, and when parameterisation is finished the data record can be stored in the inverter's memory as a file.

Be sure to set parameter P509 to 0.

### 3.4 Profibus module (optional component)

A detailed description of the Profibus interface is enclosed with the module on delivery. Besides it is available for downloading from the Getriebbau NORD site in the internet (<http://nord.com>) → **BU 0020** ....

Please contact the component supplier should you require any information in addition to that provided in the description.

### 3.5 CAN bus module (optional component)

A detailed description of the CAN bus interface is enclosed with the module on delivery. Besides it is available for downloading from the Getriebbau NORD site in the internet (<http://nord.com>) → **BU 0030** ....

Please contact the component supplier if you require any information in addition to that provided in the description.

### 3.6 CANopen module (optional component)

A detailed description of the CANopen bus interface is enclosed with the module on delivery. Besides it is available for downloading from the Getriebbau NORD site in the internet (<http://nord.com>) → **BU 0060** ....

Please contact the component supplier if you require any information in addition to that provided in the description.

### 3.7 DeviceNet module (optional component)

A detailed description of the DeviceNet bus interface is enclosed with the module on delivery. Besides it is available for downloading from the Getriebbau NORD site in the internet (<http://nord.com>) → **BU 0080** ....

Please contact the component supplier if you require any information in addition to that provided in the description.

## 4 Setting up the system

### 4.1 Basic settings

You will find a detailed description of each parameter in the paragraphs below.

#### General

As no master power switch is provided on the inverter, the device is always live while connected to line voltage. With its output disabled the inverter will not respond until the START key is operated or until an external start signal is received.

**Please bear in mind** that perfect working of the drive cannot be ensured unless the motor data are set as precisely as possible (check with the nameplate). Be sure also to initiate a stator resistance measurement (as described in P 208) before starting up the drive.

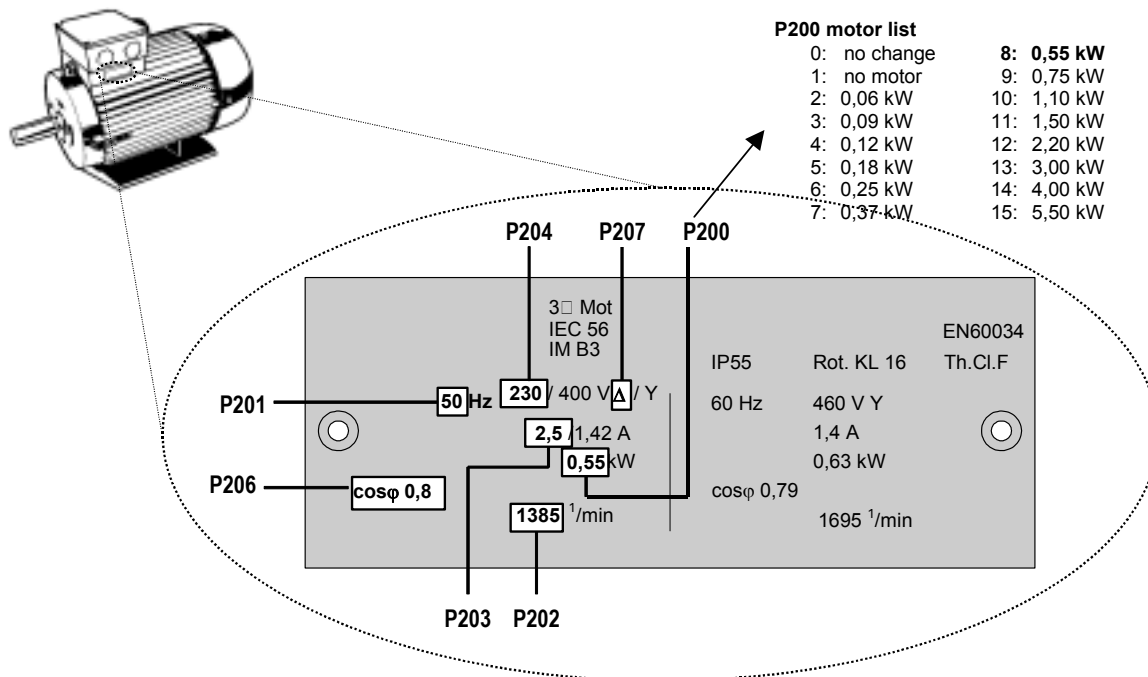

**Please note:** In this instance the motor needs to be connected in delta (230 V, P207 = 1).

In the factory the inverter is programmed in advance for standard uses involving 4-pole three-phase A.C. standard motors. A list of motors is stored in the device. The motor used is selected via P200. The data are loaded into the parameters P201 and P208 automatically where they can be viewed to be compared once again with the actual data on the motor's nameplate.

For any motor which is not mentioned in the list, the data on its nameplate must be entered into parameters P201 through P208.

For the stator resistance to be determined automatically, P208 must be set = 0 and the ENTER key pressed afterwards for input acknowledgement. The system will store the value after converting it to the phase resistance (depending on P 207).

#### Initial checking

Check proper connection of all cables (Paragraphs 2.7/2.8) and whether all relevant safety instructions are being followed.

Connect the inverter to mains voltage.

Make sure that motor starting up will not lead to dangerous situations.

Operate the ON key on the inverter. The display will change to **0.0**.











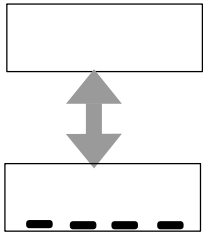

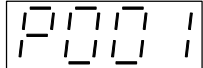

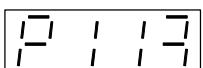

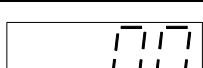

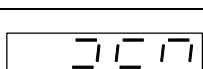

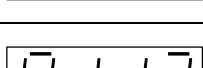



Check whether the motor will be rotating in the sense desired by pushing the  key.

The display shows the current output frequency.

Operate the OFF key. The motor will stop within the period set for braking. At the end of this period the contents of the display will change to .

### 4.1.1 Condensed instructions for basic operation using the (optional) Control Box mc

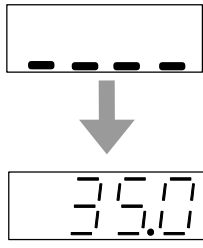
The easiest way to set up the inverter for operation is described below. In this mode the start-off frequency (P113) is used. Except for one parameter a change of the default settings will not be necessary.

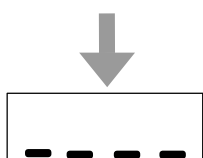
Measure	Key	Display
1. Connect the inverter to mains voltage. The operation display changes to the "equipment-on" mode.		
2. Operate  key. Parameter no. P001 and the subsequent parameters are displayed.		
3. Operate  key until parameter P 113 (start-off frequency) is displayed.		
4. Operate  key to display the current frequency setpoint (default setting by manufacturer = 0Hz).		
5. Operate  key to set the desired frequency setpoint (e.g. 35 Hz).		
6. Operate  key to read the setting into memory.		
7. Operate  key until the equipment-on signal is shown. Or press  and  simultaneously to switch directly to the equipment-on signal. With the  key the inverter is switched on directly. The inverter will show the equipment-on signal immediately.		
8. Switch the inverter on using the  key. The motor shaft starts rotating while the display shows that the frequency is rising towards the 35Hz setpoint value. <b>Note:</b> The frequency will have reached the setpoint after 1.4 seconds (35Hz / 50Hz x 2s). Standard ramp-up time is 2s to settle at a 50Hz value (as defined in P102 and P105). If required the motor speed (i.e. the frequency) can be varied directly with the   keys. Press the  key to immediately save the new setting in P113.		
9. Use the  key to switch the inverter off. The motor is decelerated to a stop at a controlled rate (this will take 1.4s ). Standard ramp-down time is 2s from 50Hz to stop (as defined by P103, P105). <b>Note:</b> After having been switched off the inverter will supply 0Hz for another 0.5 secs (P559). This state of transition is terminated if the inverter is enabled again immediately.		



## 5 Parameterisation

Two parameter sets are available which can be switched during operation. All parameters can be visualised any time, allowing for on-line adjustment.

As the parameters are interdependent to some extent, varying one of them may lead to conflicting commands and temporary operating trouble due to illegal internal data. While operation is in progress, edit the inactive parameter set only.

The various parameters are arranged in groups according to their major purpose. The first digit of a parameter number denotes the **menu group** to which the parameter belongs.

The following main functions are allocated to the *menu groups*:

Menu group	No.	Main function
<b>Operational values</b>	<b>(P0xx):</b>	Here the physical unit of the indicated value is selected.
<b>Basic parameters</b>	<b>(P1xx):</b>	Based on the motor data they are sufficient for standard applications. Refer to basic inverter settings such as behaviour at power-on and power-off.
<b>Motor / characteristic curve parameters</b>	<b>(P2xx):</b>	For setting the specific motor data, important for ISD current control and the selection of the characteristic which is determined by setting the dynamic and the static boost.
<b>Control terminals</b>	<b>(P4xx):</b>	Scaling the analogue inputs and outputs, assigning functions to the digital inputs and relay outputs and defining the controller parameters.
<b>Additional parameters</b>	<b>(P5xx):</b>	are functions dealing e.g. with the interface, the pulse frequency or fault acknowledgement
<b>Information</b>	<b>(P7xx):</b>	to display e.g. current operating values, historic fault messages, device status messages, or the software version

**Note:** With the parameter P523, the factory setting of any parameter can be restored any time. This may be helpful for instance when a frequency inverter is to be set up for operation whose parameters were modified and deviate from the factory settings.

**Important:** All parameter settings will be lost as soon as P523 is set equal to 1 and the ENTER key pressed. To save the current parameter settings they should be transferred into the Control Box *mc* memory → P550 = 1 followed by ENTER.



## 5.1 Survey of parameters, user settings

(P) ⇒ only valid in one parameter set. These parameters can be set differently in the 2 parameter sets.

Parameter No.	Designation	Range of values	Resolution	Factory setting	Settings after intervention by the user	
					P.set 1	P.set 2
P000	Operating parameter display	as selected				
P001	Selection of value to be displayed	0 ... 6	1	0		
P100	Parameter set	0 ... 1	1	0		
P101	Copy parameter set	0 ... 1	1	0		
P102	(P) Acceleration time [s]	0 ... 99.99	0.01	2.0		
P103	(P) Deceleration time [s]	0 ... 99.99	0.01	2.0		
P104	(P) Minimum frequency [Hz]	0 ... 400.0	0.1	0.0		
P105	(P) Maximum frequency [Hz]	0.1 ... 400.0	0.1	50.0		
P106	(P) Ramp smoothing [%]	0 / 10.0 ... 100.0	0.1	0		
P107	(P) Brake reaction time [s]	0 ... 2.50	0.01	0.0		
P108	(P) Disconnection mode	0 ... 4	1	1		
P109	(P) DC brake current [%]	0 ... 250	1	100		
P112	(P) Torque current limit [%]	25 ... 400 / 401	1	401		
P113	(P) Start-off frequency [Hz]	-400.0 ... 400.0	0.1	0.0		
P200	(P) Motor list	0 ... 15	1	0		
P201	(P) Nominal frequency [Hz]	20.0 ... 399.9	0.1	50.0		
P202	(P) Nominal speed [rpm]	300 ... 24000	1	1375 *		
P203	(P) Nominal current [A]	0.00 ... 15.00	0.01	3.64 *		
P204	(P) Nominal voltage [V]	100 ... 500	1	230		
P205	(P) Nominal power [W]	0 ... 9999	1	750 *		
P206	(P) cos φ	0.50 ... 0.90	0.01	0.74 *		
P207	(P) Motor connection [ star / delta ]	0 ... 1	1	1 *		
P208	(P) Stator resistance [Ω]	0.00 ... 300.00	0.01	10.20 *		
* These settings vary with the inverter type. The data mentioned refer to an SK 750/1 FCT model.						
P210	(P) Static boost [%]	0 ... 250	1	100		
P211	(P) Dynamic boost [%]	0 ... 150	1	100		
P212	(P) Slip compensation [%]	0 ... 150	1	100		
P213	(P) ISD control loop gain [%]	5 ... 400	1	100		
P214	(P) Torque derivative action [%]	-200 ... 200	1	0		
P215	(P) Boost derivative action [%]	0 ... 200	1	0		
P216	(P) Time boost derivative action [s]	0.0 ... 10.0	0.1	0.0		
P400	Analogue input function	0 ... 16	1	1		
P401	Analogue input mode	0 ... 3	1	0		
P402	Analogue input bal. 0% [V]	0.0 ... 10.0	0.1	0.0		
P403	Analogue input bal. 100% [V]	0.0 ... 10.0	0.1	10.0		
P404	Analogue input filter [ms]	10 ... 400	1	100		
P410	Secondary setpoint minimum frequ. [Hz]	0.0 ... 400.0	0.1	0.0		
P411	Secondary setpoint maximum frequ. [Hz]	0.0 ... 400.0	0.1	50.0		
P413	PID controller P component [%]	0.0 ... 400.0	0.1	10.0		
P414	PID controller I component [%/ms]	0.0 ... 400.0	0.1	1.0		
P415	PID controller D component [%ms]	0.0 ... 400.0	0.1	1.0		
P416	PID ramp [s]	0.00 ... 99.99	0.01	2.00		

Parameter No.	Designation	Range of values	Resolution	Factory setting	Settings after intervention by the user	
					P.set 1	P.set 2
P418	Analogue output function	0 ... 30	1	0		
P419	Analogue output scaling [%]	10 ... 500	1	100		
P420	Function digital input 1	0 ... 42	1	1		
P421	Function digital input 2	0 ... 42	1	2		
P422	Function digital input 3	0 ... 42	1	8		
P423	Function digital input 4	0 ... 42	1	4		
P426 (P)	Quick stopping time [s]	0 ... 10.00	0.01	0.1		
P428	Automatic starting [Off / On]	0 ... 1	1	0		
P429 (P)	Fixed frequency 1 [Hz]	-400.0 ... 400.0	0.1	0		
P430 (P)	Fixed frequency 2 [Hz]	-400.0 ... 400.0	0.1	0		
P431 (P)	Fixed frequency 3 [Hz]	-400.0 ... 400.0	0.1	0		
P432 (P)	Fixed frequency 4 [Hz]	-400.0 ... 400.0	0.1	0		
P434 (P)	Function relay 1	0 ... 12	1	1		
P435 (P)	Relay scaling [%]	-400 ... 400	1	100		
P441 (P)	Function relay 2	0 ... 12	1	1		
P460	Watchdog cycle time [s]	0.0 / 0.1 ... 999.9	0.1	10.0		
P503	Output master function	0 ... 4	1	0		
P504	Pulse frequency [kHz]	3.0 ... 15.0	0.1	6.0		
P505 (P)	Absolute minimum frequency [Hz]	0.1 ... 10.0	0.1	2.0		
P506	Automatic acknowledgement	0 ... 7	1	0		
P507	PPO type	1 ... 4	1	1		
P508	Profibus address	1 ... 126	1	1		
P509	Interface	0 ... 20	1	0		
P511	USS baud rate	0 ... 3	1	3		
P512	USS address	0 ... 30	1	0		
P513	Telegram time-out [s]	0.0 ... 100.0	0.1	0.0		
P514	CAN bus baud rate	0 ... 7	1	4		
P515	CAN bus address	0 ... 255	1	0		
P516 (P)	Skip frequency [Hz]	0.0 ... 400.0	0.1	0.0		
P518 (P)	Skip frequency [Hz]	0.0 ... 400.0	0.1	0.0		
P520 (P)	Flying start feature	0 ... 4	1	0		
P523	Factory setting	0 ... 2	1	0		
P535	I <sup>2</sup> t motor	0: off 1: on	1	0		
P537	Current limit	0: off 1: on	1	1		
P540	Disable phase sequence	0 ... 3	1	0		
P541	Ext. control of the relays	0 ... 3	1	0		
P542	Ext. control of the analogue output	0.0 ... 10.0	0.1	0.0		
P543	Bus transmission actual value 1	0000...FFFF hex	1	1		
P544	Bus transmission actual value 2	0000...FFFF hex	1	0		
P545	Bus transmission actual value 3	0000...FFFF hex	1	0		
P546	Bus transmission setpoint 1	0000...FFFF hex	1	1		
P547	Bus transmission setpoint 2	0000...FFFF hex	1	0		
P548	Bus transmission setpoint 3	0000...FFFF hex	1	0		
P550	Back up data record, with <b>Control Box</b>	0 ... 3	1	0		
P551	Drive profile	0 ... 1	1	0		
P558 (P)	Magnetisation time [ms]	0 / 1 / 2 ... 500	1	1		
P559 (P)	DC injection time [s]	0.00 ... 5.00	0.01	0.00		

Parameter No.	Designation	Range of values	Resolution	Factory setting	Settings after intervention by the user					
					P.set 1	P.set 2				
P700	Current fault	Details cf. Sec. 6, Error signals	0 ... 20	1						
P701	Last fault		0 ... 20	1						
P707	[01] Software version (27.x) [02] Revision number (x.0)		0 ... 9999	1						
P708	State of digital inputs (binary)		0000 ... 1111	1						
P709	Analogue input voltage		0 ... 10.0	0.1						
P710	Analogue output voltage		0 ... 10.0	0.1						
P711	State of output relays (binary)		00 ... 11	1						
P716	Current frequency [Hz]		-400 ... 400.0	0.1						
P717	Current speed [1/min]		0 ... 9999	1						
P718	[01] Current setpoint ... from setpt source [02] frequency [Hz] ... after processing [03] ... after f-ramp		-400 ... 400.0	0.1						
P719	Instantaneous current [A]		0 ... 20.0	0.1						
P720	Instantaneous torque current [A]		-20.0 ... 20.0	0.1						
P722	Output voltage [V]		0 ... 1000	1						
P728	Current input voltage [V]		0 ... 1000	1						
P736	D.C. link voltage [V]		0 ... 1000	1						
P740	[01] Control word [02] Bus control word (process input data) [03] [04]	Control word Setpoint 1 (P546) Setpoint 2 (P547) Setpoint 3 (P548)	0000...FFFF hex	1						
P741	[01] Status word [02] Status word (process input data) [03] [04]	Status word Act. value 1 (P543) Act. value 2 (P544) Act. value 3 (P545)			0000...FFFF hex	1				
P742	Data base version						0 ... 9999	1		
P743	Inverter type						0 ... 9999	1		
P744	Scope of extension (RS485 / CANBus)		0 / 1	1						
P745	Subassembly version *		0 ... 9999	1						
P746	Subassembly status *		0000...FFFF hex	1						

Information parameters

\*) only provided that the (optional) CANopen or DeviceNet subassembly is connected

## 5.2 Parameter description

### 5.2.1 Operating parameters displayed

Parameter [default setting]	Setting / Description / Note
<b>P000</b> Operational values	As selected in P001 The operating parameter selected in parameter P001 is displayed here.
<b>P001</b> Selection of operating parameters to be displayed [ 0 ]	Selection of the operating parameter wanted to be displayed <b>0 = Actual frequency [Hz]</b> , is the output frequency currently supplied by the FI <b>1 = Speed [1/min]</b> , is the actual speed as calculated by the inverter <b>2 = Nominal frequency [Hz]</b> , is the output frequency which corresponds to the active setpoint value without however being necessarily equal to the current output frequency <b>3 = Current [A]</b> , is the instantaneous output current measured by the FI <b>4 = Torque current [A]</b> , is the torque generating output current of the FI <b>5 = Voltage [Vac]</b> , is the current alternating voltage the FI supplies at its output <b>6 = D.C. link voltage [Vdc]</b> , is the internal direct voltage of the FI which depends on - among other factors – the mains voltage.

### 5.2.2 Basic parameters

Parameter [default setting]	Setting / Description / Note
<b>P100</b> Parameter set [ 0 ]	Selection of the parameter set you want to work with. Two parameter sets are available. All parameters which can be set differently according to the parameter set to which they belong are marked <b>(P)</b> . <b>0</b> = parameter set 1 <b>1</b> = parameter set 2 The set of operating parameters is selected by activation of a digital input or via bus control. It is perfectly all-right to switch parameter sets while operation is in progress (on-line switching). If the keyboard is used to enable the inverter (Control box <i>mc</i> ) the set of operating parameters will be the one selected in P100.
<b>P101</b> Copy parameter set	Setting the value to <b>1</b> will initiate copying of the parameter set selected in P100 into the other parameter set. No effect is produced by setting the value to <b>0</b> . Example: The P100 = 0, P101 = 1 → "Enter" command will copy parameter set 1 into parameter set 2!
<b>P102 (P)</b> Acceleration time 0 ... 99.99 s [ 2.00 ]	is the time which corresponds to the linear frequency rise (ramp) from 0Hz to the maximum frequency set (P105). Using a current setpoint <100% will lead to a linear reduction of the acceleration time in accordance with the adjusted setpoint. Under certain circumstances acceleration may take longer than provided for by the setting as e.g. as a result of inverter overload, setpoint delay or of the current limit being reached.
<b>P103 (P)</b> Deceleration time 0 ... 99.99 s [ 2.00 ]	is the time which corresponds to the linear frequency decrease from the maximum frequency set (P105) down to 0Hz. If a current setpoint < 100% is used, deceleration time is reduced accordingly. Under certain circumstances deceleration may be prolonged for instance as a result of a deceleration delay or a setpoint delay.

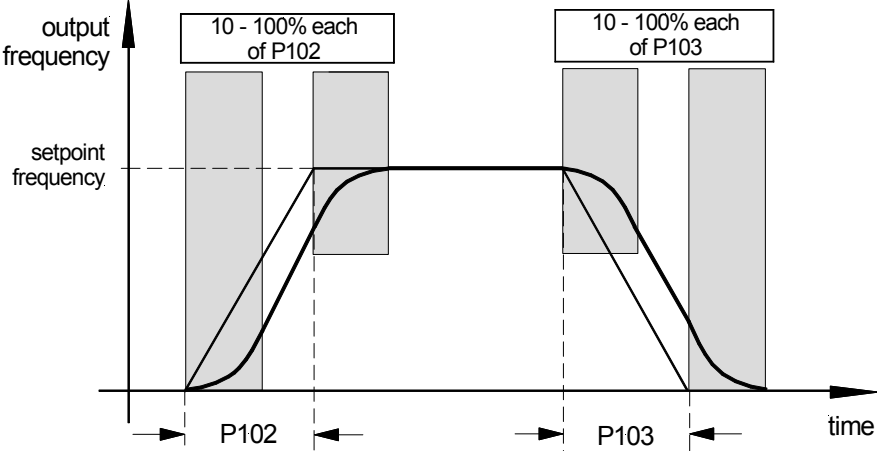
Parameter [default setting]	Setting / Description / Note
<p><b>P104 (P)</b> Minimum frequency 0.0 ... 400.0 Hz [ 0.0 ]</p>	<p>is the frequency the inverter supplies the moment it is enabled, if no additional setpoint is applied. If other setpoints have been defined (such as an analogue setpoint or fixed frequencies), they are added to the minimum frequency set. The inverter will supply less than the above frequency value when</p> <ol style="list-style-type: none"> <li>it is disabled. The frequency then drops to the absolute minimum frequency (P505) right before the inverter is actually disabled, and</li> <li>when the inverter reverses the rotating field. This happens at the absolute minimum frequency (P505).</li> </ol> <p>The frequency may permanently drop below the value described above if</p> <ol style="list-style-type: none"> <li>the "Maintain frequency" function (P420-423 = 09) is executed during acceleration / deceleration.</li> </ol>
<p><b>P105 (P)</b> Maximum frequency 0.1 ... 400.0 Hz [ 50.0 ]</p>	<p>is the frequency supplied by the inverter after it has been enabled when the maximum setpoint is applied, e.g. an analogue setpoint as defined in P403, a corresponding fixed frequency, or a maximum value set via the Control Box <i>mc</i>. This frequency will not be exceeded unless the "Maintain frequency" function (P420-423 = 09) is activated while the operator switches to the other parameter set where a lower maximum frequency has been selected.</p>
<p><b>P106 (P)</b> Ramp smoothing 0 / 10 ... 100 % [ 0 ]</p>	<p>With this parameter the acceleration and deceleration ramps can be smoothed. This measure is necessary for applications where speed variation is to be performed in a soft but dynamical fashion. Control will ensure ramp smoothing each time a setpoint is changed. The value best to be selected depends on which acceleration and deceleration times have been set. Values &lt;10% will have no effect however. The following formula is used to calculate the total acceleration or deceleration time including the smoothing function :</p> $t_{\text{tot accel.}} = t_{P102} + t_{P102} \cdot \frac{P106 [\%]}{100\%}$ $t_{\text{tot decel.}} = t_{P103} + t_{P103} \cdot \frac{P106 [\%]}{100\%}$ 

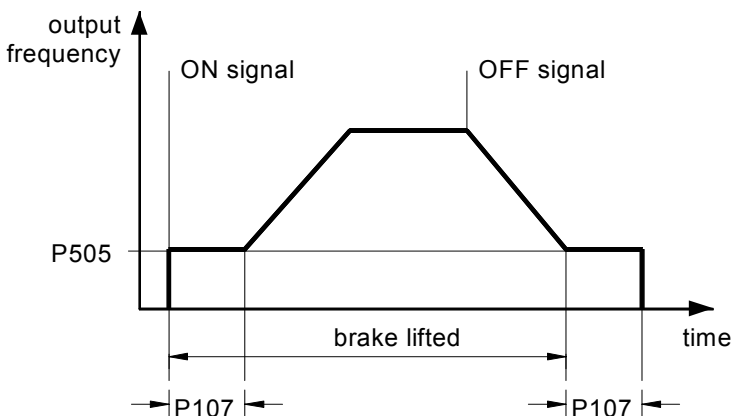
Parameter [default setting]	Setting / Description / Note
<p><b>P107 (P)</b> Setpoint delay (or brake reaction time) 0 ... 2.50 s [ 0.00 ]</p> <p>Setting example: lifting gear with brake P107 = 0.2 sec. P434 = 1 P505 = 2.0 ... 4.0 Hz</p>	<p>For physical reasons electromagnetic brakes take a certain amount of time before responding. As a result</p> <p>(1) the motor may start up while the brake is still holding (there is a delay before the brake actually lifts) or</p> <p>(2) load sagging may occur in lifting gear applications because brake reaction is delayed.</p> <p>This kind of delay can be taken into account by providing a suitable setting of parameter 107.</p> <p>During the period of delay which can be adjusted as required the frequency inverter will supply the absolute minimum frequency set in P505. With this measure it is ensured that the motor will not start up before the brake is lifted and that loads will not sag when a hoisting gear stops.</p> <p>According to our experience using the internal relay 1 (P434, control terminals 1 and 2) → function 1, external brake, is a good way of controlling electromagnetic brakes (especially in lifting applications). Better do not set a value less than 2.0 Hz as the absolute minimum frequency.</p> 
<p><b>P108 (P)</b> Disconnection mode [ 1 ]</p>	<p>This parameter determines the way the output frequency will be reduced after „disable“ (controller enable → low).</p> <p><b>0 = Voltage disable:</b> The output signal is switched off undelayed. The inverter no longer supplies any output frequency. The motor is decelerated by mechanical friction only. If the inverter is switched on again immediately, a disconnection for fault may result.</p> <p><b>1 = Ramping down:</b> The current output frequency is reduced in accordance with the proportionate deceleration time which is still left from the period set in P103.</p> <p><b>2 = Delayed ramping:</b> as in "ramping down", however with a prolonged deceleration ramp in regenerative operation, or with an increase of the output frequency in static operation. Under certain conditions this function may have the effect of preventing an overvoltage disconnection or of reducing the power loss at the braking resistor.</p> <p><b>Note:</b> Do not program this function if deceleration must proceed in a specific way as for instance with lifting gear applications.</p> <p><b>3 = Instant d.c. braking:</b> The inverter will switch to the preselected direct current (P109) immediately. This direct current is supplied for the remaining proportion of the deceleration time (P103).</p> <p>The motor will stop within a time varying with the application. The stopping time depends on the mass moment of inertia of the load and on the d.c. current set (P109). This type of deceleration does not involve energy feedback to the inverter. Heat losses will occur chiefly in the rotor of the motor.</p> <p><b>4 = Constant stopping distance:</b> There will be a certain time lag before the deceleration ramp is started, provided that the drive is not operated at the maximum output frequency (P105). This means that the stopping distance will be more or less equal regardless of the operating frequency used.</p> <p>This function also works when the frequency setpoint is reduced to 0Hz. (Setpoint = 0.0V and Minimum frequency = 0Hz) → switched setpoint!</p> <p><b>Note:</b> This function must not be used as a positioning function. Neither should it be combined with a ramp smoothing command (P106).</p>

Parameter [default setting]	Setting / Description / Note
<b>P109</b> (P) D.C. brake current 0 ... 250 % [ 100 ]	Setting the current for d.c. braking (P108 = 3). The appropriate setting value depends on the mechanical load and the desired stopping time. With high setting values, big loads can faster be decelerated to a stop.
<b>P112</b> (P) Torque current limit 25 ... 400 % / 401 [ 401 ]	<p>With this parameter a limit value for the torque generating current can be set. While this limit value can prevent mechanical overloading of the drive, no protection is ensured in case of mechanical jamming (drive is blocked). A slipping clutch is a preferable and even indispensable alternative.</p> <p>Continuous adjustment of the torque-generating current is also possible via the analogue input (terminals 7/8, P400). In that case the maximum setpoint (cf. alignment to a 100% value, P403) will be equal to the value set in P112.</p> <p>Even if a lesser analogue setpoint is applied, it is not possible for the torque current to decrease below the limit of 25%!</p> <p><b>401% = AUS</b> steht für die Abschaltung der Momentstromgrenze! Dies ist gleichzeitig die Grundeinstellung des Umrichters.</p>
<b>P113</b> (P) Start-off frequency -400 ... 400 Hz [ 0 ]	<p>If the <b>Control Box mc</b> is used to control the inverter, the start-off frequency is the initial frequency of the inverter after it has been enabled.</p> <p>The start-off frequency can be set right here in this parameter or, if the inverter has been enabled via the keypad, by pressing the ENTER key. The current output frequency which has been set using the INCREASE/DECREASE buttons, is stored.</p> <p>Alternatively, with the control terminals being used for control, the start-off frequency can be released via any of the digital inputs (P420-423 = 15). If none of the digital inputs are configured as enable signals (function 1 or 2), P113 requires no additional inputs to be set, to enable the inverter.</p> <p>Setpoints transmitted to the system via the control terminals such as the start-off frequency, any fixed frequencies or the analogue setpoint, are always added taking their signs into account. Whatever the result may be, the actual frequency will never exceed the set maximum frequency (P105) nor decrease below the minimum frequency limit (P104).</p>

### 5.2.3 Parameters for motor data and characteristic curves

Parameter [default setting]	Setting value / Description / Note																				
<b>P200</b> (P) Motor list	<p>With this parameter the default settings of the motor data can be changed. Factory settings presume a 4-pole three-phase standard motor and nominal output of the inverter.</p> <p>Select the number applicable in your case from the list represented below and operate the ENTER key, then the system will activate the default settings of all of the motor parameters described below (P201 to P208). The motor data refer to 4-pole three-phase standard motors.</p> <p>If the “<b>no motor</b>” option is selected the inverter will operate <u>without</u> a biasing period. This setting is suitable for applications where no motor is connected to the inverter output, for instance for filament lamps or coils.</p> <table style="width: 100%; border: none;"> <tr> <td style="width: 25%;"><b>0 = no data change *</b></td> <td style="width: 25%;"><b>4 = 0.12kW</b></td> <td style="width: 25%;"><b>9 = 0.75kW</b></td> <td style="width: 25%;"><b>14 = 4,0kW **</b></td> </tr> <tr> <td></td> <td><b>5 = 0.18kW</b></td> <td><b>10 = 1.1kW</b></td> <td><b>15 = 5,5kW **</b></td> </tr> <tr> <td><b>1 = no motor</b></td> <td><b>6 = 0.25kW</b></td> <td><b>11 = 1.5kW</b></td> <td>** ) only for the 3-phase <i>vector mc</i></td> </tr> <tr> <td><b>2 = 0.06kW</b></td> <td><b>7 = 0.37kW</b></td> <td><b>12 = 2.2kW</b></td> <td></td> </tr> <tr> <td><b>3 = 0.09kW</b></td> <td><b>8 = 0.55kW</b></td> <td><b>13 = 3.0kW</b></td> <td></td> </tr> </table> <p><b>Note:</b> Select parameter P205 to verify whether the motor power was correctly set (after input acknowledgement P200 will return to 0).</p> <p><b>Important:</b> Perfect operation of the drive presupposes that the motor data have been set as correctly as possible (check nameplate). Be sure always to initiate automatic stator resistance measurement (P208).</p> <p>*) By setting the value 1 (= <b>no motor</b>) a mains-operation simulation can be parameterised for which the following data are pre-set: 50.0 Hz / 1500 rpm / 15.00 A / 230 V / cos φ = 1.00 / 1.00 Ω. This setting implies that the inverter will operate without current control, slip compensation and premagnetization period so that it cannot be recommended for motor control. Potential applications are induction furnaces or other applications involving coils.</p>	<b>0 = no data change *</b>	<b>4 = 0.12kW</b>	<b>9 = 0.75kW</b>	<b>14 = 4,0kW **</b>		<b>5 = 0.18kW</b>	<b>10 = 1.1kW</b>	<b>15 = 5,5kW **</b>	<b>1 = no motor</b>	<b>6 = 0.25kW</b>	<b>11 = 1.5kW</b>	** ) only for the 3-phase <i>vector mc</i>	<b>2 = 0.06kW</b>	<b>7 = 0.37kW</b>	<b>12 = 2.2kW</b>		<b>3 = 0.09kW</b>	<b>8 = 0.55kW</b>	<b>13 = 3.0kW</b>	
<b>0 = no data change *</b>	<b>4 = 0.12kW</b>	<b>9 = 0.75kW</b>	<b>14 = 4,0kW **</b>																		
	<b>5 = 0.18kW</b>	<b>10 = 1.1kW</b>	<b>15 = 5,5kW **</b>																		
<b>1 = no motor</b>	<b>6 = 0.25kW</b>	<b>11 = 1.5kW</b>	** ) only for the 3-phase <i>vector mc</i>																		
<b>2 = 0.06kW</b>	<b>7 = 0.37kW</b>	<b>12 = 2.2kW</b>																			
<b>3 = 0.09kW</b>	<b>8 = 0.55kW</b>	<b>13 = 3.0kW</b>																			

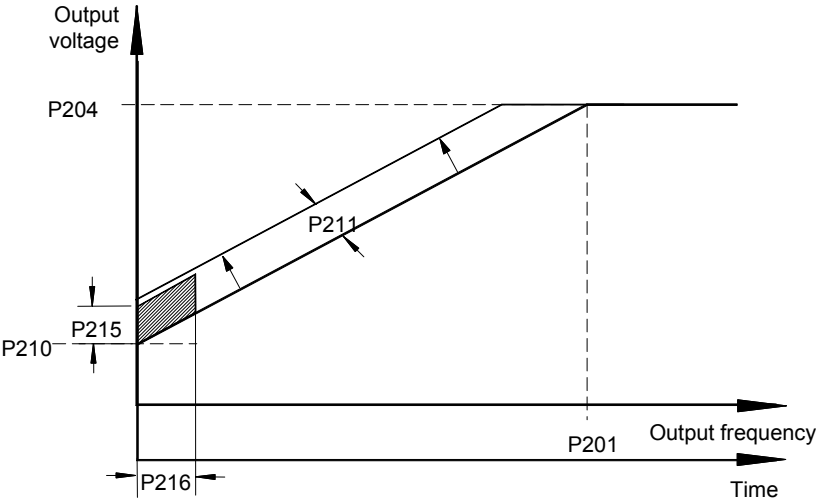

Parameter [default setting]	Setting value / Description / Note
<b>P201</b> (P) Nominal frequency 20.0 ... 399.9 Hz	The nominal motor frequency determines the voltage/frequency break-point where the inverter will be supplying the nominal voltage (P204) at the output.
<b>P202</b> (P) Nominal speed 0 ... 24000 rpm	The nominal motor speed is important to ensure that motor slippage and speed indication (P001 = 1) are properly calculated and corrected.
<b>P203</b> (P) Nominal current 0.00 ... 15.00 A	The nominal motor current is a crucial quantity with regard to vectorial current control.
<b>P204</b> (P) Nominal voltage 100 ... 500 V	Proceeding from the nominal motor voltage the mains voltage is adjusted to the motor voltage.
<b>P205</b> (P) Rating 0 ... 9999 W	The motor rating parameter can be activated to verify the power of the motor set in P200.
<b>P206</b> (P) cos $\varphi$ 0.50 ... 0.90	The motor cosine $\varphi$ is essential for vectorial current control.
<b>P207</b> (P) Motor connection	<p>0 = <b>star</b>                      Measurement of the stator resistance and hence vectorial current control are essentially dependent on the way the motor is connected.</p> <p>1 = <b>delta</b></p>
<b>P208</b> (P) Stator resistance 0.00 ... 300.00 $\Omega$	<p>Stator resistance of the motor <math>\Rightarrow</math> resistance of a <u>phase winding</u> in the three-phase motor.</p> <p>Has a direct effect on current control by the inverter. If the value is too high, overcurrent may result, if it is too low the motor torque will be insufficient.</p> <p>For easy measurement of the stator resistance this parameter should be set to "zero". When the ENTER key has been pressed, measurement is effected automatically between two motor phases. The measured value is then converted to the phase resistance on the basis of the delta or star connection (P207) and afterwards stored in the inverter's memory.</p>
<b>P210</b> (P) Static boost 0 ... 250 % [ 100 ]	The static boost has an effect on the current by which the magnetic field is produced. This current is equivalent to the no-load current of the respective motor and hence is <u>independent of the load</u> . The no-load current is calculated from the motor data. The 100% factory setting is sufficient for standard applications.
<b>P211</b> (P) Dynamic boost 0 ... 150 % [ 100 ]	<p>The dynamic boost has an effect on the torque generating current which means that it is a quantity which is in fact related to the load. As with the static boost the factory setting of 100% will be sufficient for standard applications.</p> <p>Setting too high a dynamic boost value may lead to inverter overcurrent because the output voltage will be raised too much when a load is applied.</p> <p>If the setting is too low the torque of the motor will be low too.</p>
<b>P212</b> (P) Slip compensation 0 ... 150 % [ 100 ]	<p>Slip compensation is a feature which ensures that the speed of a three-phase asynchronous motor is maintained at a fairly constant level by raising the output frequency with increasing loads.</p> <p>The 100% value set in the factory will be optimum for three-phase asynchronous motors if the motor data are correctly set.</p> <p>If <b>several motors</b> (with different outputs or different loads respectively) are connected to and controlled by a single inverter, we recommend to set the slip compensation P212 = 0% to exclude any adverse effect on their operation.</p> <p>A 0% setting should be used for <b>synchronous motors</b> as well where no slipping occurs at all due to the way they work.</p>

Parameter [default setting]	Setting value / Description / Note				
<p><b>P213 (P)</b> ISD control gain 5 ... 400 % [ 100 ]</p>	<p>With this parameter the dynamic response of the vectorial current control (ISD control) mode of the inverter can be varied. High setting values will make the controller fast, low settings will make it slow.</p> <p>With this parameter the control action can be adjusted to the requirements of the application, for instance to prevent instability of operation.</p>				
	<div style="text-align: center;">  </div> <p>“Typical” setting for:</p> <table border="0" style="width: 100%; border-collapse: collapse;"> <tr> <td style="width: 50%; vertical-align: top;"> <p><b>vectorial current control</b> (factory settings)</p> <p>P201 to P208 = motor data</p> <p>P210 = 100%</p> <p>P211 = 100%</p> <p>P212 = 100%</p> <p>P213 = 100%</p> <p>P214 = 0%</p> <p>P215 = not relevant</p> <p>P216 = not relevant</p> </td> <td style="width: 5%; border-left: 1px dashed black;"></td> <td style="width: 45%; vertical-align: top;"> <p><b>Linear v/f characteristic</b></p> <p>P201 to P208 = motor data</p> <p>P210 = 100% (static boost)</p> <p>P211 = <b>0%</b></p> <p>P212 = <b>0%</b></p> <p>P213 = 100% (not relevant)</p> <p>P214 = 0% (not relevant)</p> <p>P215 = 0% (dynamic boost)</p> <p>P216 = 0s (time dyn. boost)</p> </td> </tr> </table>		<p><b>vectorial current control</b> (factory settings)</p> <p>P201 to P208 = motor data</p> <p>P210 = 100%</p> <p>P211 = 100%</p> <p>P212 = 100%</p> <p>P213 = 100%</p> <p>P214 = 0%</p> <p>P215 = not relevant</p> <p>P216 = not relevant</p>		<p><b>Linear v/f characteristic</b></p> <p>P201 to P208 = motor data</p> <p>P210 = 100% (static boost)</p> <p>P211 = <b>0%</b></p> <p>P212 = <b>0%</b></p> <p>P213 = 100% (not relevant)</p> <p>P214 = 0% (not relevant)</p> <p>P215 = 0% (dynamic boost)</p> <p>P216 = 0s (time dyn. boost)</p>
<p><b>vectorial current control</b> (factory settings)</p> <p>P201 to P208 = motor data</p> <p>P210 = 100%</p> <p>P211 = 100%</p> <p>P212 = 100%</p> <p>P213 = 100%</p> <p>P214 = 0%</p> <p>P215 = not relevant</p> <p>P216 = not relevant</p>		<p><b>Linear v/f characteristic</b></p> <p>P201 to P208 = motor data</p> <p>P210 = 100% (static boost)</p> <p>P211 = <b>0%</b></p> <p>P212 = <b>0%</b></p> <p>P213 = 100% (not relevant)</p> <p>P214 = 0% (not relevant)</p> <p>P215 = 0% (dynamic boost)</p> <p>P216 = 0s (time dyn. boost)</p>			
<p><b>P214 (P)</b> Torque derivative action -200 ... 200 % [ 0 ]</p>	<p>With this function it is possible to impress a value for the expected torque requirement on the controller. This is particularly helpful with hoisting gear applications where this feature will enable more effective load-taking during the starting-up period.</p> <p><b>Note:</b> If the driving power is exclusively supplied by the motor, the torque is entered with a positive sign, while torque obtained from regenerative operation are marked with a negative one.</p>				
<p><b>P215 (P)</b> Boost derivative action 0 ... 200 % [ 0 ]</p>	<p><b>Only with linear characteristic (P211 = 0% and P212 = 0%).</b></p> <p>Drives requiring a high starting torque can be assisted during this period by feeding them a certain amount of extra current. This is ensured by selecting a percentage which is deemed adequate in this parameter. The time during which the boost will be available is limited. It is set in parameter P216, &gt;Time boost derivative action&lt;.</p>				
<p><b>P216 (P)</b> Time boost derivative action 0.0 ... 10.0 s [ 0.0 ]</p>	<p><b>Only with linear characteristic (P211 = 0% and P212 = 0%).</b></p> <p>On-period of the boosted starting current.</p>				

A pre-set torque control (P214 – P216) is useful for applications involving driving against a high positive or negative torque (e.g. hoisting or other applications with back-driving forces).

## 5.2.4 Control terminals

Parameter [default setting]	Setting value/ Description / Note
<b>P400</b>  Analogue input function  [ 1 ]	<p>The analogue input of the inverter can be used for various functions. Please keep in mind that only one of the functions indicated below can be selected at a time.</p> <p>If for instance the PID actual frequency is selected, the frequency setpoint cannot possibly be an analogue signal. In that case a fixed value can be defined to be the setpoint.</p> <p><b>0 = Off</b>, no function is assigned to the analogue input at all. When the inverter has been enabled via the control terminals it will supply the minimum frequency, if a setting has been made (P104).</p> <p><b>1 = Nominal frequency</b>, according to the analogue range specified (P402/P403) the output frequency is varied between the minimum and maximum frequencies set (P104/P105).</p> <p><b>2 = Torque current limit</b>, proceeding from the torque current limit as set in P112, this limit can be changed by providing an analogue value. The torque current limit that was set is considered to be the 100% setpoint value. The actual value will not decrease below the 25% limit!</p> <p><b>3 = PID actual frequency</b>, is required for control loop configuration. The analogue input (actual value) is compared with the setpoint (e.g. a fixed frequency). The output frequency is adjusted as far as possible until the actual value has become equal to the setpoint (cf. controlled variables P413 – P415).</p> <p><b>4 = Frequency addition</b>, this function is available on the condition that a setpoint is transmitted via a bus system (cf. P509) or secondary setpoint (P410/411). In such a case an analogue setpoint or a fixed frequency will be added to the bus or secondary setpoint.</p> <p><b>5 = Frequency subtraction</b>, any frequency value transmitted to the analogue input will be subtracted from the setpoint.</p> <p><b>6 = Assigned</b></p> <p><b>7 = Assigned</b></p> <p><b>8 = PID actual frequency limited</b>, same as function 3 PID actual frequency, with the additional effect however that the output frequency is prevented from dropping below the value programmed as minimum frequency in parameter P104 (no spontaneous phase reversal)</p> <p><b>9 = PID actual frequency monitored</b>, same as function 3 PID actual frequency, however with the additional effect that the inverter will stop supplying an output frequency when the value has decreased so far as to equal the P104 minimum frequency.</p> <p><b>10 = Assigned</b></p> <p><b>11 = Assigned</b></p> <p><b>12 = Assigned</b></p> <p><b>13 = Assigned</b></p> <p><b>14 = Process controller actual value *</b>, will activate the PI process controller. Analogue input 1 is connected to the actual value encoder (dancer, pressure capsule, flowmeter, ...). The mode (0-10V or 0/4-20mA respectively) is set in P401.</p> <p><b>15 = Process controller setpoint *</b>, basically the same as function 14, however with the setpoint being transmitted to the system (e.g. by a potentiometer). The actual value must be applied to a different input.</p> <p><b>16 = Process controller derivative action *</b>, an additional setpoint which is selected as required will be added following the PI process controller action.</p> <p>*) Refer to section 8.4 for more information regarding the process controller.</p>

Parameter [default setting]	Setting value/ Description / Note
--------------------------------	-----------------------------------

<p><b>P401</b></p> <p>Analogue input mode [ 0 ]</p>	<p><b>0 = 0 – 10V limited:</b> analogue setpoints less than the programmed matched value of 0% (P402) neither result in a decrease of the frequency below the programmed minimum value (P104) nor in a reversal of the phase sequence.</p> <p><b>1 = 0 – 10V:</b> will even permit output frequencies below the programmed minimum frequency (P104) if a setpoint less than the programmed matched value of 0% (P402) is effective. This is a convenient way of ensuring a reversal of the phase sequence by means of a simple voltage source and a potentiometer.</p> <p>For instance internal setpoint with phase sequence reversal: P402 = 5V, P104 = 0Hz, potentiometer 0 – 10V ⇒ reversal of phase sequence at 5V with the potentiometer at midway-position</p> <p><b>2 = 0 – 10V monitored:</b> When the setpoint value drops below: [min. setpoint (P402) - (10% * (max. setpoint (P403) – min setpoint (P402)))]], the inverter output is turned off. The output signal is restored when the setpoint is increased to above [P402 – (10%*(P403-P402))].</p> <p><u>Setpoint example 4-20mA:</u> Analogue input alignment 0% = 2V; Analogue input alignment 100% = 10V; 10% of the setpoint corresponds to 0.8V. This means 2-10V (or 4-20mA) = the typical working range (min. to max. frequency), 1.2-2V = minimum frequency setpoint, below 1.2V (or 2.4mA) the inverter output turns off.</p> <div style="text-align: right;"> </div> <p><b>3 = ± 10V:</b> when reversing with the analogue setpoint (P402 &gt; 0V), a relay that is configured for 'Brake Control' (P434/P441 = 1/6) does not drop out below the absolute minimum frequency (P505).</p>
---	--

<p><b>P402</b></p> <p>Analogue input alignment 0% 0.0 ... 10.0 V [ 0.0 ]</p>	<p>With the parameters P402 and P403 the working range of the analogue input is defined, or in other words the analogue setpoint is aligned with the analogue input.</p> <p>The basic setting implies that the setpoint alignment range (0 to 10 volts) corresponds to output frequencies between the minimum and the maximum frequency. Alignments with any other commonly used setpoints can be made in this parameter as well without any difficulty.</p>
<p><b>P403</b></p> <p>Analogue input alignment 100% 0.0 ... 10.0 V [ 10.0 ]</p>	<p>e.g. 0 to 5V ⇒ 0 to 20mA (with R = 250Ω) 2 to 10V ⇒ 4 to 20mA (with R = 500Ω) 1 to 5V ⇒ 4 to 20mA (with R = 250Ω)</p> <p>Inverted alignment is possible too → setpoint rising, frequency dropping.</p>

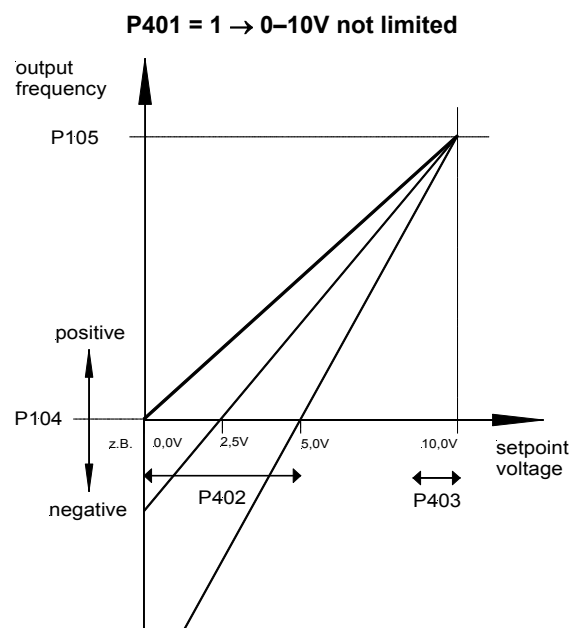
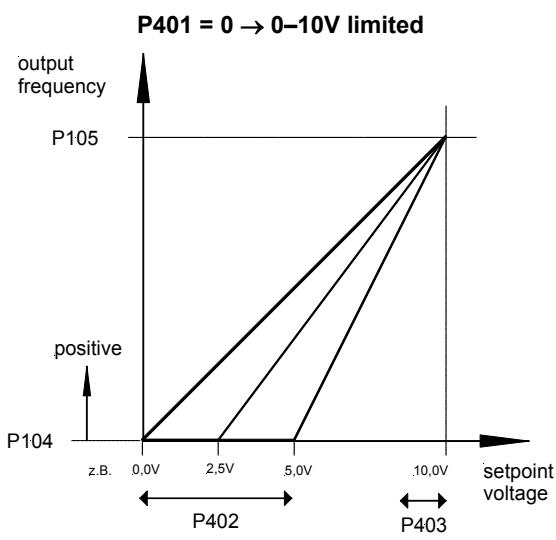

Parameter [default setting]	Setting value/ Description / Note
<b>P404</b> Analogue input filter 10 ... 400 ms [ 10 ]	Adjustable digital filter for the analogue setpoint signal
<b>P410</b> Secondary setpoint minimum frequency 0.0 ... 400.0 Hz [ 0.0 ]	Is the minimum/maximum frequency which may affect the principal setpoint through the secondary setpoint.  The term secondary setpoint is applied to any of the frequencies which are additionally supplied to the inverter so that more functions can be executed.
<b>P411</b> Secondary setpoint maximum frequency 0.0 ... 400.0 Hz [ 50.0 ]	(1) PID actual frequency      (2) frequency addition      (3) frequency subtraction
<b>P412</b> Process controller setpoint 0.0 ... 10.0 V [ 5.0 ]	This parameter is for selection of a fixed setpoint for the process controller if the setpoint is presumed to remain valid for a considerable time before it may be necessary to change it.  Not available unless either option 14, 15, or 16 (process controller) of P400 has been activated as well. For more details see sections 8.3 / 8.4.
<b>P413</b> P component of PID controller 0 ... 400.0 % [ 10.0 ]	Only with P400 = 3 (PID actual frequency).  The P component of the PID controller determines the extent of the frequency jump in the event of a controlling error in relation to the control offset.  This means that if the setting of P413 = 10% and if the controlling error amounts to 50%, the current setpoint is increased by 5%.
<b>P414</b> I component of PID controller 0 ... 400.0 %/ms [ 1.0 ]	Only with P400 = 3 (PID actual frequency).  In the event of a controlling error the I component of the PID controller determines the frequency change in relation to time.
<b>P415</b> D-component of PID controller 0 ... 400.0 %ms [ 1.0 ]	Only with P400 = PID actual frequency  In the event of a control deviation the D component of the PID controller will determine the frequency change multiplied by the time.  Ist P400 = 14, 15 oder 16 (Prozessregler) gewählt, wirkt dieser Parameter als Regler- Begrenzung.
<b>P416</b> Rampe PID- Regler 0.00 ...99.99 s [ 2.00 ]	Nur wirksam wenn die Funktion Istfrequenz PID (P400 = 3) gewählt ist.  Rampe für den Sollwert- PID

Parameter [default setting]	Setting value/ Description / Note
<p><b>P418</b></p> <p>Analogue output function [ 0 ]</p>	<p>An analogue voltage (0 to 10 V) can be picked off at the control terminals 6/9 (5mA max.) The function can be parameterised to allow for various dependent relationships.</p> <p>0 volts of analogue voltage always correspond to 0% of the selected value.</p> <p>10 volts are always equal to the nominal motor value multiplied by the scaling factor.</p> $\Rightarrow 10\text{Volt} = \frac{\text{nominal motor value}}{100\%} P419$ <p><b>0 = Off</b>, no output signal at the terminals</p> <p><b>1 = output frequency</b>, the analogue voltage is proportional to the frequency at the inverter output</p> <p><b>2 = motor speed</b>, is the synchronous speed calculated by the inverter on the basis of the setpoint which is effective at the time. Load-dependent speed fluctuations are not taken into account.</p> <p><b>3 = Output current</b>, is the effective value of the output current supplied by the inverter.</p> <p><b>4 = Moment current</b>, indicates the load moment of the motor computed by the inverter.</p> <p><b>5 = Output voltage</b>, is the output voltage supplied by the inverter.</p> <p><b>6 = D.C. link voltage</b>, is the direct current in the inverter. This current is not related to nominal motor data. 10 volts, with 100% scaling, correspond to 600 volts D.C.!</p> <p>Proceeding from the d.c. link voltage the mains voltage being applied can be calculated.</p> $\rightarrow V_{\text{mains}} = V_{\text{dc}} / \sqrt{2}$ <p><b>7 = External control</b>, by setting the P542 parameter the analogue output can be controlled whatever the current operating status of the inverter may be.</p> <p>... Options <b>8 - 29</b> are not available for setting.</p> <p><b>30 = Current setpoint frequency prior to ramping</b>, reads out the frequency resulting from the action of any controllers (ISD, PID, ...) connected on line side. When this frequency value has been adjusted by providing the appropriate acceleration or deceleration ramp setting (P102, P103), it will be treated as the setpoint frequency for the power stage.</p>
<p><b>P419</b></p> <p>Analogue output scaling 10 ... 500 % [ 100 ]</p>	<p>This parameter can be used to adjust the analogue output to the desired working range. The maximum analogue output (10V) will correspond to the respective scaling value selected.</p> <p>Consequently if this parameter is increased from 100% to 200% while the working point remains constant, the analogue output voltage is reduced to half the original value. A 10V output signal then corresponds to twice the nominal value.</p>
<p><b>P420</b></p> <p>Function dig. input 1 0 ... 42 [ 1 ]</p>	<p><b>Enable right</b> → control terminal 10 as factory setting</p> <p>This input allows for programming 16 different functions. For further details see table below.</p> <p><b>Note: Dig. Input 1, response time approx. 1.2ms</b></p>
<p><b>P421</b></p> <p>Function dig. input 2 0 ... 42 [ 2 ]</p>	<p><b>Enable left</b> → control terminal 11 as factory setting</p> <p>This input allows for programming 16 different functions. For further details see table below.</p> <p>Response time (dig. input 2) approx. 6-10ms</p>
<p><b>P422</b></p> <p>Function dig. input 3 0 ... 42 [ 8 ]</p>	<p><b>Parameter set switching</b> → control terminal 12 as factory setting</p> <p>This input allows for programming 16 different functions. For further details see table below.</p> <p>Response time (dig. input 3) approx. 6-10ms</p>
<p><b>P423</b></p> <p>Function dig. input 4 0 ... 42 [ 4 ]</p>	<p><b>Fixed frequency 1</b> → control terminal 13 as factory setting</p> <p>This input allows for programming 16 different functions. For further details see table below.</p> <p>Response time (dig. input 4) approx. 6-10ms</p>

Parameter [default setting]	Setting value/ Description / Note			
<b>Re: P420 to 423</b>	<b>List of the potential functions of the 4 digital inputs</b>			
	Setting value	Function	Description	Signal
	<b>00</b>	no function	Input is de-energized	---
	<b>01</b>	enable right	Inverter supplies output, phase sequence clockwise ( <b>default input 1, terminal 10</b> )	0→1 edge
	<b>02</b>	enable left	Inverter supplies output, phase sequence anticlockwise ( <b>default input 2, terminal 11</b> )	0→1 edge
		If the functions enable right and enable left are activated at the same time, the inverter is disabled. If the automatic start feature is active (P428 = 1), a high level is sufficient.		
	<b>03</b>	Phase sequence reversal	Triggers a reversal of the phase sequence if combined with enable right or enable left	high level
	<b>04</b>	Fixed frequ. 1 <sup>1</sup>	FF 1 ( <b>default input 4, terminal 13</b> )	high level
	<b>05</b>	Fixed frequ. 2 <sup>1</sup>	Fixed frequency 2	high level
	<b>06</b>	Fixed frequ. 3 <sup>1</sup>	Fixed frequency 3	high level
	<b>07</b>	Fixed frequ. 4 <sup>1</sup>	Fixed frequency 4	high level
		If several fixed frequencies are activated simultaneously they are added allowing for their respective signs. The analogue setpoint (even the minimum frequency) and the start-off frequency are added too.		
	<b>08</b>	Parameter set switching	Switching from parameter set 1 (low level) to parameter set 2 (high level) ( <b>default input 3, terminal 12</b> )	high level
	<b>09</b>	Maintain the frequency <sup>3</sup>	During the acceleration or deceleration period a low level ensures that the output frequency is maintained. A high level allows for the ramping to be continued.	low level
	<b>10</b>	Voltage disable <sup>2</sup>	The inverter output voltage is switched off. Not being driven any longer the motor slows down to full stop.	low level
	<b>11</b>	Quick stopping <sup>2</sup>	The inverter reduces the frequency according to the programmed quick stopping period (P426).	low level
	<b>12</b>	Fault acknowledgement <sup>2</sup>	If this function is not assigned, faults are reset by invalidating the enable command.	0→1 edge
	<b>13</b>	PTC resistor input <sup>2</sup>	analogue interpretation of the applied signal – switching threshold approx.2.5V	Analogue
	<b>14</b>	Remote control	With control proceeding via RS485/ CAN-Bus/ RS232, the system will switch to control terminal mode at low level.	high level
	<b>15</b>	Start-off frequency	Fixed frequency value, adjustable via the Increase/Decrease buttons plus Enter.	high level
	<b>16</b>	Maintain the frequency, "motor potentiometer" <sup>3</sup>	Same as with <b>09</b> setting, however a constant level is not maintained at values below minimum frequency and above maximum frequency.	low level
	<sup>1</sup> If none of the digital inputs is programmed to enable right or enable left, activation of a fixed frequency or of the start-off frequency will enable the inverter. The phase sequence depends on whether the sign of the setpoint is minus or plus.			
	<sup>2</sup> Also effective if control takes place via RS485/ CAN Bus/ CANopen/ Profibus DP / RS232			
	<sup>3</sup> A setpoint needs to be applied, e.g. analogue input, fixed frequency, minimum frequency ...			

Continued next page

Parameter [default setting]	Setting value/ Description / Note			
<i>further</i> <b>Re P420 to P423</b>	<b>List of the potential functions of the 4 digital inputs</b>			
	Setting value	Function	Description	Signal
	<b>18</b>	Watchdog <sup>2</sup>	A high edge is to be applied to the input on a cyclic basis (P460). If this pulse fails to be provided, the inverter will disconnect the output generating an E012 error message. The first high edge will initiate the watchdog function.  Ein Dauer- High- Signal löst ebenfalls einen externen Watchdog- Fehler E012 aus.	0→1 edge
	<b>19</b>	Analogue setpoint OFF	The analogue input is switched on or off (high = off) P400-P404	high level
	<b>20 ... 25</b>	reserved		
	<b>Analogue functions</b> for the digital inputs (0...10V), are programmable for each input, the resolution is 7 bit, usable for simple applications.			
	<b>26</b>	Torque current limit <sup>2</sup>		0...10V
	<b>27</b>	PID actual frequency <sup>2</sup>		0...10V
	<b>28</b>	Frequency addition <sup>2</sup>		0...10V
	<b>29</b>	Frequency subtraction <sup>2</sup>		0...10V
		....		
	<b>30</b>	Disable PID controller <sup>2</sup>	The PID controller function is switched ON with a "high" signal.	0→1 edge
	<b>31 ... 39</b>	Assigned		
	<b>40</b>	Process controller actual value	as in P400 = 14-16	0...10V
	<b>41</b>	Process controller setpoint	More information on the process controller is provided in section 8.4	0...10V
	<b>42</b>	Process controller derivative action		0...10V
	<sup>2</sup> Also effective with bus control - RS485/ CAN Bus/ CANopen/ DeviceNet/ Profibus DP/ RS232			

<b>P426</b> (P) Quick stopping time 0 ...10.00 s [ 0.10 ]	Setting the deceleration time for the quick stop function (digital input, bus or keypad)  This period is based on the frequency reduction from the maximum frequency set (P105) down to 0 Hz.
<b>P428</b> Automatic start feature [ 0 ]	To enable the inverter an edge (change of signal from "low to high") will have to be applied to the respective digital input if the default setting (P428 = <b>0</b> → <b>Off</b> ) is active.  With the setting <b>1</b> → <b>ON</b> the inverter responds to a High level.  In some instances the inverter is required to start up the moment it is connected to the mains. For this purpose P428 is set to = <b>1</b> → <b>On</b> . If the enable signal is permanently on or provided with a jumper, the inverter will start up immediately.  This function is not available unless inverter control is ensured via the digital inputs (cf. P509).



Parameter [default setting]	Setting value/ Description / Note																												
<b>P429</b> (P) Fixed frequency 1 ±400 Hz	Settings for the 1st to the 4th fixed frequency. A negative setting value will produce a reversal of the phase sequence (in relation to the phase sequence at enable). The fixed frequency will be supplied as soon as the inverter has been enabled (for either the positive or the negative phase sequence).																												
<b>P430</b> (P) Fixed frequency 2 ±400 Hz	If several fixed frequencies are activated simultaneously, the respective values are added allowing for their signs. This is true also if they are combined with the start-off frequency (P113), the analogue setpoint (if P400 = 1) or the minimum frequency (P104).																												
<b>P431</b> (P) Fixed frequency 3 ±400 Hz	The frequency limits (P104 = $f_{min}$ , P105 = $f_{max}$ ) will never be exceeded. If none of the digital inputs is programmed to enable the inverter (for either the positive or the negative phase sequence), the inverter is enabled simply by the fixed frequency signal being applied. In that case a positive fixed frequency will enable the inverter for a positive phase sequence (rotating field turning right), while a negative fixed frequency will enable it for a negative phase sequence (rotating field turning left).																												
<b>P432</b> (P) Fixed frequency 4 ±400 Hz	[ standard setting = 0.0 Hz ]																												
<b>P434</b> (P) Relay 1 functions [ 1 ]	<p>Functions that can be assigned to the signalling relay 1 (control terminals 1 / 2)</p> <p>The settings 3 to 5 and 11 imply a hysteresis of 10%, i.e. the relay contact will close when the limit value is reached and open when the value has dropped below a level which is lower by 10%.</p> <table border="1"> <thead> <tr> <th>Setting / function</th> <th>Relay contact ... at limit value or with function</th> </tr> </thead> <tbody> <tr> <td><b>0 = no function</b></td> <td>open</td> </tr> <tr> <td><b>3 = external brake</b>, to control a brake on the motor. The relay will make or break at the programmed absolute minimum frequency (P505). It is advisable to provide a setpoint delay (see also P107) for typical brakes.  Mechanical brakes are allowed to be switched directly if connected to an a.c. supply. (Please take the technical specification of the relay contacts into account.)</td> <td>closes circuit</td> </tr> <tr> <td><b>4 = The inverter is working</b>, the closed relay contact signals that voltage is being supplied at the inverter output.</td> <td>closes circuit</td> </tr> <tr> <td><b>5 = Current limit</b>, depends on the value of the nominal motor current set in P203. The scaling parameter (P435) can be used to adjust this value.</td> <td>closes circuit</td> </tr> <tr> <td><b>6 = Torque current limit</b>, is based on the motor data set in P203 and P206. The relay signals a corresponding torque load on the motor. This value can be adjusted by scaling (P435).</td> <td>closes circuit</td> </tr> <tr> <td><b>7 = Frequency limit</b>, is based on the nominal motor frequency set in P201. This value can be adjusted by scaling (P435).</td> <td>closes circuit</td> </tr> <tr> <td><b>8 = Level with setpoint</b>, with this function the relay signals that the inverter has terminated the frequency rise or the frequency reduction. After the contact has made the circuit, the setpoint must be changed by at least 1Hz ( → value failing to reach setpoint) for the contact to open again.</td> <td>closes circuit</td> </tr> <tr> <td><b>9 = Fault</b>, total failure indication, fault is active or has not yet been acknowledged</td> <td>opens circuit</td> </tr> <tr> <td><b>10 = Warning</b>, overall warning, a limit value was reached, a condition which could result in a disconnection of the inverter.</td> <td>opens circuit</td> </tr> <tr> <td><b>11 = Overcurrent warning</b>, following a 30 s period of at least 130% of nominal inverter current</td> <td>opens circuit</td> </tr> <tr> <td><b>12 = Motor overtemperature warning</b>: the motor temperature is evaluated via a digital input. → Motor is too hot. The warning is triggered after 15 seconds, disconnection for overtemperature after 30 seconds.</td> <td>opens circuit</td> </tr> <tr> <td><b>13 = Torque current limit active (warning)</b>, the limit value set in P112 has been reached. Hysteresis = 10%. P435 has no effect.</td> <td>opens circuit</td> </tr> <tr> <td><b>14 = External control</b>, the relay may be controlled by means of a parameter P541 setting independently of the current operating status of the inverter.</td> <td>opens circuit</td> </tr> </tbody> </table>	Setting / function	Relay contact ... at limit value or with function	<b>0 = no function</b>	open	<b>3 = external brake</b> , to control a brake on the motor. The relay will make or break at the programmed absolute minimum frequency (P505). It is advisable to provide a setpoint delay (see also P107) for typical brakes.  Mechanical brakes are allowed to be switched directly if connected to an a.c. supply. (Please take the technical specification of the relay contacts into account.)	closes circuit	<b>4 = The inverter is working</b> , the closed relay contact signals that voltage is being supplied at the inverter output.	closes circuit	<b>5 = Current limit</b> , depends on the value of the nominal motor current set in P203. The scaling parameter (P435) can be used to adjust this value.	closes circuit	<b>6 = Torque current limit</b> , is based on the motor data set in P203 and P206. The relay signals a corresponding torque load on the motor. This value can be adjusted by scaling (P435).	closes circuit	<b>7 = Frequency limit</b> , is based on the nominal motor frequency set in P201. This value can be adjusted by scaling (P435).	closes circuit	<b>8 = Level with setpoint</b> , with this function the relay signals that the inverter has terminated the frequency rise or the frequency reduction. After the contact has made the circuit, the setpoint must be changed by at least 1Hz ( → value failing to reach setpoint) for the contact to open again.	closes circuit	<b>9 = Fault</b> , total failure indication, fault is active or has not yet been acknowledged	opens circuit	<b>10 = Warning</b> , overall warning, a limit value was reached, a condition which could result in a disconnection of the inverter.	opens circuit	<b>11 = Overcurrent warning</b> , following a 30 s period of at least 130% of nominal inverter current	opens circuit	<b>12 = Motor overtemperature warning</b> : the motor temperature is evaluated via a digital input. → Motor is too hot. The warning is triggered after 15 seconds, disconnection for overtemperature after 30 seconds.	opens circuit	<b>13 = Torque current limit active (warning)</b> , the limit value set in P112 has been reached. Hysteresis = 10%. P435 has no effect.	opens circuit	<b>14 = External control</b> , the relay may be controlled by means of a parameter P541 setting independently of the current operating status of the inverter.	opens circuit
Setting / function	Relay contact ... at limit value or with function																												
<b>0 = no function</b>	open																												
<b>3 = external brake</b> , to control a brake on the motor. The relay will make or break at the programmed absolute minimum frequency (P505). It is advisable to provide a setpoint delay (see also P107) for typical brakes.  Mechanical brakes are allowed to be switched directly if connected to an a.c. supply. (Please take the technical specification of the relay contacts into account.)	closes circuit																												
<b>4 = The inverter is working</b> , the closed relay contact signals that voltage is being supplied at the inverter output.	closes circuit																												
<b>5 = Current limit</b> , depends on the value of the nominal motor current set in P203. The scaling parameter (P435) can be used to adjust this value.	closes circuit																												
<b>6 = Torque current limit</b> , is based on the motor data set in P203 and P206. The relay signals a corresponding torque load on the motor. This value can be adjusted by scaling (P435).	closes circuit																												
<b>7 = Frequency limit</b> , is based on the nominal motor frequency set in P201. This value can be adjusted by scaling (P435).	closes circuit																												
<b>8 = Level with setpoint</b> , with this function the relay signals that the inverter has terminated the frequency rise or the frequency reduction. After the contact has made the circuit, the setpoint must be changed by at least 1Hz ( → value failing to reach setpoint) for the contact to open again.	closes circuit																												
<b>9 = Fault</b> , total failure indication, fault is active or has not yet been acknowledged	opens circuit																												
<b>10 = Warning</b> , overall warning, a limit value was reached, a condition which could result in a disconnection of the inverter.	opens circuit																												
<b>11 = Overcurrent warning</b> , following a 30 s period of at least 130% of nominal inverter current	opens circuit																												
<b>12 = Motor overtemperature warning</b> : the motor temperature is evaluated via a digital input. → Motor is too hot. The warning is triggered after 15 seconds, disconnection for overtemperature after 30 seconds.	opens circuit																												
<b>13 = Torque current limit active (warning)</b> , the limit value set in P112 has been reached. Hysteresis = 10%. P435 has no effect.	opens circuit																												
<b>14 = External control</b> , the relay may be controlled by means of a parameter P541 setting independently of the current operating status of the inverter.	opens circuit																												

Parameter [default setting]	Setting value/ Description / Note																												
<b>P435 (P)</b> Relay 1 scaling -400 ... 400 % [ 100 ]	Adaptation of the limit values of the relay functions based on the nominal motor data. Current limit = x[%] * P203 Torque current limit = x[%] * P203 * P206 Frequency limit = x[%] * P201																												
<b>P441 (P)</b> Relay 2 functions [ 1 ]	<p>Functions which can be assigned to the signal relay 2 (control terminals 3 / 4).</p> <p>The contact is closed as soon as the inverter is ready for operation. The contact is opened whenever a fault has occurred. Moreover one of the warnings or brake control can be programmed as relay functions. Warnings are signalled by an open contact. The "external brake" function will close the contact as soon as the absolute minimum frequency is exceeded.</p> <table border="1" style="width: 100%; border-collapse: collapse;"> <thead> <tr> <th style="background-color: #d3d3d3;">Setting / function</th> <th style="background-color: #d3d3d3;">Relay contact ... at limit value or with function</th> </tr> </thead> <tbody> <tr> <td><b>0 = no function</b></td> <td>open</td> </tr> <tr> <td><b>1 = fault</b>, total failure indication, fault is active or has not been acknowledged yet</td> <td>opens circuit</td> </tr> <tr> <td><b>2 = warning</b>, overall warning, a limit value has been reached which could eventually lead to a disconnection of the inverter</td> <td>opens circuit</td> </tr> <tr> <td><b>3 = Overcurrent warning</b>, following a 30 s period of at least 130% of nominal inverter current</td> <td>opens circuit</td> </tr> <tr> <td><b>4 = motor overtemperature warning</b>: the motor temperature is evaluated via a digital input. → Motor is too hot. The warning is read out by the end of a 15 sec. period, dis-connection for overtemperature after 30 seconds.</td> <td>opens circuit</td> </tr> <tr> <td><b>5 = Torque current limit active</b>, the limit value set in P112 has been reached. Hysteresis = 10%.</td> <td>opens circuit</td> </tr> <tr> <td><b>6 = External brake</b>, control of an external brake (cf. P107 and P434). Output frequency &gt; absolute minimum frequency (P505) → contact will close.</td> <td>closes circuit</td> </tr> <tr> <td><b>7 = External control</b>, the relay may be controlled via a parameter P541 setting regardless of the current inverter status.</td> <td>closes circuit</td> </tr> <tr> <td><b>8 = no fault</b> (inverse of 1)</td> <td>closes circuit</td> </tr> <tr> <td><b>9 = no warning</b> (inverse of 2)</td> <td>closes circuit</td> </tr> <tr> <td><b>10 = no overcurrent warning</b> (inverse of 3)</td> <td>closes circuit</td> </tr> <tr> <td><b>11 = no motor overtemp. warning</b> (inverse of 4)</td> <td>closes circuit</td> </tr> <tr> <td><b>12 = torque limit not exceeded</b> (warning) (inverse of 5)</td> <td>closes circuit</td> </tr> </tbody> </table>	Setting / function	Relay contact ... at limit value or with function	<b>0 = no function</b>	open	<b>1 = fault</b> , total failure indication, fault is active or has not been acknowledged yet	opens circuit	<b>2 = warning</b> , overall warning, a limit value has been reached which could eventually lead to a disconnection of the inverter	opens circuit	<b>3 = Overcurrent warning</b> , following a 30 s period of at least 130% of nominal inverter current	opens circuit	<b>4 = motor overtemperature warning</b> : the motor temperature is evaluated via a digital input. → Motor is too hot. The warning is read out by the end of a 15 sec. period, dis-connection for overtemperature after 30 seconds.	opens circuit	<b>5 = Torque current limit active</b> , the limit value set in P112 has been reached. Hysteresis = 10%.	opens circuit	<b>6 = External brake</b> , control of an external brake (cf. P107 and P434). Output frequency > absolute minimum frequency (P505) → contact will close.	closes circuit	<b>7 = External control</b> , the relay may be controlled via a parameter P541 setting regardless of the current inverter status.	closes circuit	<b>8 = no fault</b> (inverse of 1)	closes circuit	<b>9 = no warning</b> (inverse of 2)	closes circuit	<b>10 = no overcurrent warning</b> (inverse of 3)	closes circuit	<b>11 = no motor overtemp. warning</b> (inverse of 4)	closes circuit	<b>12 = torque limit not exceeded</b> (warning) (inverse of 5)	closes circuit
Setting / function	Relay contact ... at limit value or with function																												
<b>0 = no function</b>	open																												
<b>1 = fault</b> , total failure indication, fault is active or has not been acknowledged yet	opens circuit																												
<b>2 = warning</b> , overall warning, a limit value has been reached which could eventually lead to a disconnection of the inverter	opens circuit																												
<b>3 = Overcurrent warning</b> , following a 30 s period of at least 130% of nominal inverter current	opens circuit																												
<b>4 = motor overtemperature warning</b> : the motor temperature is evaluated via a digital input. → Motor is too hot. The warning is read out by the end of a 15 sec. period, dis-connection for overtemperature after 30 seconds.	opens circuit																												
<b>5 = Torque current limit active</b> , the limit value set in P112 has been reached. Hysteresis = 10%.	opens circuit																												
<b>6 = External brake</b> , control of an external brake (cf. P107 and P434). Output frequency > absolute minimum frequency (P505) → contact will close.	closes circuit																												
<b>7 = External control</b> , the relay may be controlled via a parameter P541 setting regardless of the current inverter status.	closes circuit																												
<b>8 = no fault</b> (inverse of 1)	closes circuit																												
<b>9 = no warning</b> (inverse of 2)	closes circuit																												
<b>10 = no overcurrent warning</b> (inverse of 3)	closes circuit																												
<b>11 = no motor overtemp. warning</b> (inverse of 4)	closes circuit																												
<b>12 = torque limit not exceeded</b> (warning) (inverse of 5)	closes circuit																												
<b>P460 (P)</b> Watchdog cycle time 0.0 / 0.1 ... 999.9 s [ 10.0 ]	<p><b>0.0</b> = Customer error function – as soon as a low-to-high edge is received at the input (P420-P423), the inverter effects a disconnection while generating an E012 error message. For reset this error, it is first necessary to set the watchdog on high level.</p> <p><b>0.1 ... 999.9</b> = The time interval between the signals to be provided to the watchdog can be assigned as a function to the digital inputs (P420-P423). If no pulse is received within the period specified, the inverter disconnects the output and generates an E012 error message.</p>																												

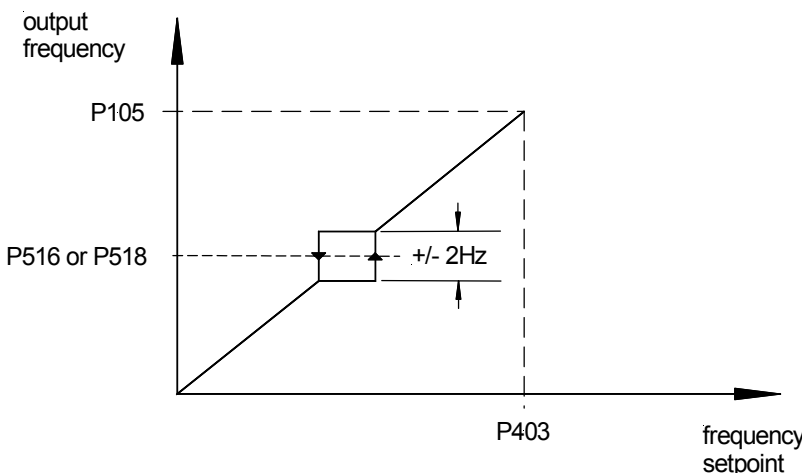

Parameter [default setting]	Setting value / Description / Note				
<b>P507</b> PPO type 1 ... 4 [ 1 ]	Only with the Profibus <b>optional</b> equipment  More information provided in the supplementary description on Profibus control - BU 0020 DE -				
<b>P508</b> Profibus address 0 ... 126 [ 1 ]	Profibus address, only with the Profibus <b>option</b>				
<b>P509</b> Interface 0 ... 20 [ 0 ]	Selection of the interface used to control the inverter <b>0 = control terminals or keypad control **</b> with the Control Box <i>mc</i> (option) or <i>p-box</i> (option) <b>1 = control terminals only *</b> , the inverter can be controlled exclusively via the analogue input and the 4 digital inputs. <b>2 = USS setpoint *</b> , the frequency setpoint is transmitted via the USS protocol. Control via the digital inputs is still active as well. <b>3 = USS control word *</b> , the control signals (enable, phase sequence,...) are transmitted via USS, the setpoint via the analogue input or the fixed frequencies. <b>4 = USS *</b> , all of the control information is transmitted via the USS protocol. No function is assigned to the analogue input and the digital ones. <b>5 = CAN setpoint *</b> (option) <b>6 = CAN control word *</b> (option) <b>7 = CAN *</b> (option) <b>8 = Profibus setpoint *</b> (option) <b>9 = Profibus control word *</b> (option) <b>10 = Profibus *</b> (option) <b>11 = CAN broadcasting *</b> (option) <b>12 = Assigned</b> <b>13 = Assigned</b> <b>14 = Assigned</b> <b>15 = CANopen setpoint *</b> (option) <b>16 = CANopen control word *</b> (option) <b>17 = CANopen *</b> (option) <b>18 = DeviceNet setpoint *</b> (option) <b>19 = DeviceNet control word *</b> (option) <b>20 = DeviceNet *</b> (option)				
	<p><b>Please note:</b>                      Kindly refer to the descriptions of the various optional modules for detailed information on the respective bus systems.                      BU 0020 = Profibus                      BU 0030 = CANbus                      BU 0050 = USS                      BU 0060 = CANopen                      BU 0080 = DeviceNet</p>				
	*) Keypad control (Control Box <i>mc</i> ) is disabled, parameter setting continues to be available. **) If during keypad control communication is disturbed (time out 0.5 sec), the inverter will disconnect the output without generating an error message.				
<b>P511</b> USS baud rate [ 3 ]	For setting the rate of transmission via the RS 485 interface. The same baud rate must be set for all users connected to the bus system.  <table style="width: 100%; border: none;"> <tr> <td style="text-align: center;"><b>0 = 4800 baud</b></td> <td style="text-align: center;"><b>2 = 19200 baud</b></td> </tr> <tr> <td style="text-align: center;"><b>1 = 9600 baud</b></td> <td style="text-align: center;"><b>3 = 38400 baud</b></td> </tr> </table>	<b>0 = 4800 baud</b>	<b>2 = 19200 baud</b>	<b>1 = 9600 baud</b>	<b>3 = 38400 baud</b>
<b>0 = 4800 baud</b>	<b>2 = 19200 baud</b>				
<b>1 = 9600 baud</b>	<b>3 = 38400 baud</b>				
<b>P512</b> USS address 0 ... 30 [ 0 ]	For setting the inverter address				

Parameter [default setting]	Setting value / Description / Note
<b>P513</b> Telegram time-out 0.1 ... 100.0 s [ 0.0 ]	Function monitoring the bus interface active at the time (USS or CAN). After a valid telegram has been received the next one is to arrive within the set interval of time. If it doesn't, the inverter will signal a fault and break the circuit reading out the E010 error message. By setting the time-out value to 0 the monitoring function is switched off.
<b>P514</b> CAN bus baud rate (option) [ 4 ]	Setting the rate of transmission via the CAN interface. The same baud rate must be set for all of the users connected into the bus system. 0 = 10kbaud                      3 = 100kbaud 1 = 20kbaud                     4 = 125kbaud                      6 = 500kbaud 2 = 50kbaud                     5 = 250kbaud                      1Mbaud (with certain reserves)
<b>P515</b> CAN bus address (option) 0 ... 255 [ 0 ]	Setting the CAN bus address More information provided in the supplementary description on CAN bus control, - BU 0030 -
<b>P516 (P)</b> Skipped frequency 1 0.0 ... 400.0 Hz Range of skipped frequency $\pm 2$ Hz [ 0.0 ]	The output frequency is skipped in the range around the frequency value set in this parameter. The acceleration and deceleration ramps pass through this range ( $\pm 2$ Hz) where the corresponding frequency cannot be permanently supplied at the output. Do not select frequencies $< 2$ Hz for this setting. 0 = skip frequency inactive 
<b>P518 (P)</b> Skipped frequency 2 0.0 ... 400.0 Hz $\pm 2$ Hz range of skipped frequency [ 0.0 ]	
<b>P520 (P)</b> Flying start feature [ 0 ]	This function is required to enable connection of the inverter into the control circuit of motors which are already rotating, as e.g. with fan drives. 0 = <b>switched off</b> , no flying start connection provided 1 = <b>both directions</b> , the inverter will search for the correct speed in either sense of rotation 2 = <b>in the direction of the setpoint</b> , search only in the direction of the setpoint applied 3 = <b>both directions, only after mains failure and fault</b> 4 = <b>in the direction of the setpoint, only after mains failure and fault</b>
<b>P523 (P)</b> Factory setting 0 ... 2 [ 0 ]	To retrieve and reactivate the default settings originally provided in the factory (cf. section 5.1), the operator should select the range of parameters he has in mind and make the change permanent by pressing the <i>Enter</i> key. Whenever a setting has been made in the present parameter P523, the system will restore the zero setting automatically. 0 = <b>No change</b> : current parameter settings are acknowledged. 1 = <b>Load default settings</b> : all of the inverter parameters are reset to the values defined in the factory. The system will not retain any parameter settings made by the operator before this action is initiated. 2 = <b>Default settings except the bus</b> : All of the inverter parameters are reset to the default values. This operation will not affect the bus parameters however.

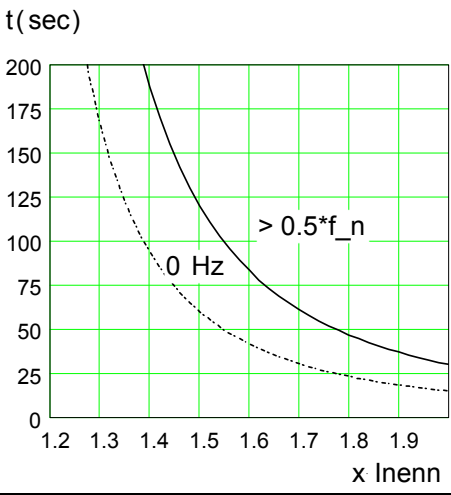
Parameter [default setting]	Setting value / Description / Note										
<p><b>P535</b> I<sup>2</sup>t- motor [ 0 ]</p>	<p>The motor temperature is calculated from the output current, time, and output frequency. Reaching the temperature limit leads to output disconnection and generation of an E002 (Motor Over Temperature) error display. Any positive or negative environmental influences are not allowed for.</p> <p><b>0 = OFF</b> <b>1 = ON</b></p> 										
<p><b>P537</b> Inverter current limit (Pulse disconnection) [ 1 ]</p>	<p>With this function instant disconnection of the inverter as a result of substantial overload (&gt;200% nominal inverter current) is prevented. If the current limit parameter is switched on the output current is limited to about 150% of the nominal inverter current. This limitation is achieved by a short-time disconnection of the final stage.</p> <p><b>0 = switched off</b>      <b>1 = switched on</b></p>										
<p><b>P540</b> Disable phase sequence [ 0 ]</p>	<p>With this parameter a reversal of the phase sequence can be excluded for safety reasons.</p> <p><b>0 = no limitation regarding the phase sequence</b></p> <p><b>1 = disable phase sequence switching</b>, the phase sequence key on the Control Box mc is disabled</p> <p><b>2 = positive phase sequence (to the right) only *</b>, phase reversal is entirely disabled. Only the positive phase sequence is available. Selection of the „wrong“ phase sequence is of no consequence - the inverter will only supply 0 Hz or the set minimum frequency (P104) respectively at its output.</p> <p><b>3 = negative phase sequence (to the left) only *</b>, phase reversal is entirely disabled. Only the negative phase sequence is available. Selection of the „wrong“ phase sequence will only make the inverter output supply 0Hz or the set minimum frequency (P104) respectively.</p> <p>* The phase sequence key on the Control Box mc is disabled as well!</p>										
<p><b>P541</b> External control of relays [ 0 ]</p>	<p>This parameter enables control of the two relays of the inverter whatever its current operating status may be. Before external control can be activated, the options of the parameters in which the relay functions are assigned must have been selected accordingly, i.e. P434 = 12 (relay 1) and/or P441 = 7 (relay 2).</p> <p>This function is binary-coded: <b>0 = no change</b>    <b>1 = relay 1</b>    <b>2 = relay 2</b>    <b>3 = both relays</b></p> <p>This function may be used on a manual control basis by setting the present parameter as desired (function test) or in combination with bus control. In the latter case the present parameter is varied and with it the relay controlled by communicating the information required over the bus.</p>										
<p><b>P542</b> External control of the analogue output [ 0.0 ]</p>	<p>This parameter provides for control of the analogue inverter output independently of the current operating status of the inverter. The value set here will be supplied at the analogue output (terminal 7/8, cf. setting in P418).</p> <p>This function may be used on a manual control basis by setting the present parameter as desired (function test) or in combination with bus control. In the latter case the present parameter is varied and with it the analogue output controlled by communicating the required information over the bus.</p>										
<p><b>P543 (P)</b> Selection of bus actual value 1 0 ... 9 [ 1 ]</p>	<p>When the inverter is bus-controlled, this parameter allows for selecting feedback value 1.</p> <p><b>Note:</b> For more information kindly refer to the applicable bus operating instructions.</p> <table border="0"> <tr> <td><b>0 = Off</b></td> <td><b>5 = State of digital inputs and relays</b></td> </tr> <tr> <td><b>1 = Actual frequency</b></td> <td><b>6 = Assigned</b></td> </tr> <tr> <td><b>2 = Actual speed</b></td> <td><b>7 = Assigned</b></td> </tr> <tr> <td><b>3 = Current</b></td> <td><b>8 = Setpoint frequency</b></td> </tr> <tr> <td><b>4 = Torque current</b></td> <td><b>9 = Error number</b></td> </tr> </table>	<b>0 = Off</b>	<b>5 = State of digital inputs and relays</b>	<b>1 = Actual frequency</b>	<b>6 = Assigned</b>	<b>2 = Actual speed</b>	<b>7 = Assigned</b>	<b>3 = Current</b>	<b>8 = Setpoint frequency</b>	<b>4 = Torque current</b>	<b>9 = Error number</b>
<b>0 = Off</b>	<b>5 = State of digital inputs and relays</b>										
<b>1 = Actual frequency</b>	<b>6 = Assigned</b>										
<b>2 = Actual speed</b>	<b>7 = Assigned</b>										
<b>3 = Current</b>	<b>8 = Setpoint frequency</b>										
<b>4 = Torque current</b>	<b>9 = Error number</b>										

Parameter [default setting]	Setting value / Description / Note
<b>P544 (P)</b> Selection of bus actual value 2 0 ... 9 [ 0 ]	When the inverter is bus-controlled, this parameter allows for selecting feedback value 2. <b>Note:</b> For more information kindly refer to the applicable bus operating instructions. <b>0</b> = Off <b>1</b> = Actual frequency <b>2</b> = Actual speed <b>3</b> = Current <b>4</b> = Torque current <b>5</b> = State of digital inputs and relays <b>6</b> = Assigned <b>7</b> = Assigned <b>8</b> = Setpoint frequency <b>9</b> = Error number
<b>P545 (P)</b> Selection of bus actual value 3 0 ... 9 [ 0 ]	When the inverter is bus-controlled, this parameter allows for selecting feedback value 3. Not available unless P546 ≠ 3. <b>Note:</b> For more information kindly refer to the applicable bus operating instructions. <b>0</b> = Off <b>1</b> = Actual frequency <b>2</b> = Actual speed <b>3</b> = Current <b>4</b> = Torque current <b>5</b> = State of digital inputs and relays <b>6</b> = Assigned <b>7</b> = Assigned <b>8</b> = Setpoint frequency <b>9</b> = Error number
<b>P546 (P)</b> Selection of bus setpoint 1 0 ... 1 [ 1 ]	When the inverter is bus-controlled, this parameter allows for assigning a function to setpoint 1 fed to the inverter over the bus. <b>Note:</b> For more information kindly refer to the applicable bus operating instructions. <b>0</b> = Off <b>1</b> = Setpoint frequency (16 bits)
<b>P547 (P)</b> Selection of bus setpoint 2 0 ... 16 [ 0 ]	When the inverter is bus-controlled, this parameter allows for assigning a function to setpoint 2 fed to the inverter over the bus. <b>Note:</b> For more information kindly refer to the applicable bus operating instructions. <b>0</b> = Off <b>1</b> = Setpoint frequency <b>2</b> = Torque current limit <b>3</b> = PID actual frequency <b>4</b> = Frequency addition <b>5</b> = Frequency subtraction <b>6</b> = Current limit <b>7</b> = Maximum frequency <b>8</b> = PID actual frequency limited <b>9</b> = PID actual frequency monitored <b>10</b> = Torque <b>11</b> = Torque derivative action <b>12</b> = <i>Assigned</i> <b>13</b> = Multiplication <b>14</b> = Process controller actual value <b>15</b> = Process controller setpoint <b>16</b> = Process controller offset
<b>P548 (P)</b> Selection of bus setpoint 3 0 ... 16 [ 0 ]	When the inverter is bus-controlled, this parameter allows for assigning a function to setpoint 3 fed to the inverter over the bus. Not available unless P546 ≠ 3. <b>Note:</b> For more information kindly refer to the applicable bus operating instructions. <b>0</b> = Off <b>1</b> = Setpoint frequency <b>2</b> = Torque current limit <b>3</b> = PID actual frequency <b>4</b> = Frequency addition <b>5</b> = Frequency subtraction <b>6</b> = Current limit <b>7</b> = Maximum frequency <b>8</b> = PID actual frequency limited <b>9</b> = PID actual frequency monitored <b>10</b> = Torque <b>11</b> = Torque derivative action <b>12</b> = <i>assigned</i> <b>13</b> = Multiplication <b>14</b> = Process controller actual value <b>15</b> = Process controller setpoint <b>16</b> = Process controller offset





Parameter	Array*	Setting / Description / Note
<b>P710</b> Analogue output voltage		Indicates the value of the analogue output put out (0.0 ... 10.0V)
<b>P711</b> Status of multifunctional relay		Indicates the current status of the two signalling relays. 00 ... 11 (binary) – left = relay 1 (P434), right = relay 2 (P441)
<b>P716</b> Current frequency [Hz]		Indicates the current inverter output frequency. -400 ... 400.0 Hz
<b>P717</b> Current speed [rpm]		Indicates the current motor speed calculated by the inverter. The values read out will always be positive. 0 ... 9999 rpm
<b>P718</b> Current setpoint frequency [Hz]	... - 01 ... - 02 ... - 03	Indicates the frequency defined as the setpoint. -400 ... 400.0 Hz [01] = ... from setpoint source [02] = ... after having been processed passing through a fixed sequence of inverter stages [03] = ... following the frequency ramp
<b>P719</b> Instantaneous current [A]		Instantaneous value of inverter output current. 0 ... 20.0 A
<b>P720</b> Instantaneous torque current [A]		The torque generating output current calculated at a particular moment -20.0 ... 20.0 A → negative values = regenerative, positive values = directly by motor.
<b>P722</b> Current output voltage [V]		Indicates the voltage currently being supplied at the inverter output. 0 ... 1000 V ac
<b>P728</b> Current input voltage [V]		Indicates the voltage currently being consumed at the inverter input. 0 ... 1000 V ac
<b>P736</b> d.c. link voltage [V]		Indicates the d.c. link voltage of the inverter → Proceeding from this value the mains voltage can be calculated. → $V_{\text{mains}} = V_{\text{dc}}/\sqrt{2}$ 0 ... 1000 V dc
<b>P740</b> Bus control word	... - 01 ... - 02 ... - 03 ... - 04	Will read out the current control word and the setpoints in the bus operation mode (value displayed as selected) 0 ... FFFF hex [01] = Control word [02] = Setpoint 1 (P546) [03] = Setpoint 2 (P547) [04] = Setpoint 3 (P548)
<b>P741</b> Status word	... - 01 ... - 02 ... - 03 ... - 04	Will read out the current inverter status and the actual values in the bus operation mode (value displayed as selected) 0 ... FFFF hex [01] = Status word [02] = Actual value 1 (P543) [03] = Actual value 2 (P544) [04] = Actual value 3 (P545)
<b>P742</b> Data base version		0 ... 9999 [ 6 ]
<b>P743</b> Inverter type		Indication of inverter type by wattage, e.g. "750" ⇒ FI with a rating of 750W. 0 ... 9999
<b>P744</b> Scope of extension		Displays the control board type being used <b>0</b> = RS485 (USS) normally used <b>1</b> = CAN Bus, special type
<b>P745</b> Subassembly version		Only provided that CANopen or DeviceNet are being used For more information please refer to the Supplementary Description of the system involved.
<b>P746</b> Subassembly status		Only provided that CANopen or DeviceNet are being used For more information please refer to the Supplementary Description of the system involved.

## 6 Error signals

Trouble of various origins may cause inverter disconnection. If the red LED on the control board (visible from the outside) is illuminated a fault has occurred.

The following options are available to reset (acknowledge) a fault:

1. by switching the power off and then on again,
2. by programming a digital input for the purpose (function 12 of any of the parameters P420 to 423),
3. by invalidating the "enable" command on the inverter (if no digital input is programmed for acknowledgement),
4. by an acknowledgement command transmitted via the bus,
5. by setting P506, the automatic fault acknowledgement parameter.

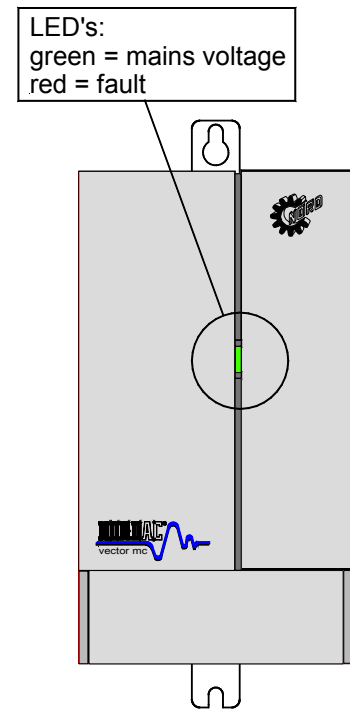

### 6.1 Control Box *mc* (optional) error messages

The **Control Box *mc*** (optional) will display errors by their number preceded by the letter "E". Current errors can also be visualised by activating parameter P700. The last error signalled is stored in parameter P701.

If the cause of the failure has been eliminated, the error display in the Control Box *mc* will be flashing and the error can also be acknowledged with the Enter key.

### Table of the error signals the system is able to provide

Display		Type of failure	Cause
group	details see P700 / P701		➤ <b>What to do about it</b>
<b>E001</b>	<b>1.0</b>	Inverter overtemperature	(Static) error signal from the output stage module ➤ Reduce ambient temperature (to <50°C or even to <40°C, see also 'Technical Data' section 8) ➤ Check ventilation of switching cabinet
<b>E002</b>	<b>2.0</b>	Motor overtemperature (PTC resistor) <u>Not displayed unless</u> a digital input (function = 13) has been programmed	The motor temperature sensor has picked up ➤ Reduce load on the motor ➤ Increase motor speed ➤ Use forced ventilation on the motor
	<b>2.1</b>	Motor overtemperature ( $I^2t$ ) <u>Not displayed unless</u> $I^2t$ motor (P535) has been programmed	Disconnection at $I^2t$ motor temperature limit ➤ Reduce load on the motor ➤ Increase motor speed
<b>E003</b>	<b>3.0</b>	Inverter overcurrent	Disconnection at $I^2t$ inverter temperature limit, e.g. > 1.5 x $I_n$ for 30s (it will be a good idea also to check the setting of the pulse frequency in P504) ➤ Avoid sustained overloading of the inverter output
<b>E004</b>	<b>4.0</b>	Module overcurrent	(Brief) error signal from module ➤ Short-circuit or ground fault at inverter output ➤ Use external output choke (motor cable is too long)

Display		Type of failure	Cause
group	details see P700 / P701		➤ <b>What to do about it</b>
<b>E005</b>	<b>5.0</b>	D.C. link overvoltage	Inverter D.C. link voltage too high ➤ Reduce recovered energy by providing a brake resistor ➤ Extend braking time (P103) ➤ Except for lifting gear applications the mode for a delayed disconnection could be set (P108) ➤ Prolong "quick stop time" (P426)
	<b>5.1</b>	Mains overvoltage	Mains voltage is too high ➤ Please check the mains voltage (380V –20% to 460V +10%)
<b>E006</b>	<b>6.0</b>	D.C. link undervoltage (charging error)	Inverter D.C. link voltage too low ➤ Check mains voltage (380V –20% to 460V +10%), may be too weak
	<b>6.1</b>	Mains undervoltage	
<b>E007</b>	<b>7.0</b>	Mains phase failure (only with 3~ 400V <i>vector mc</i> )	One of the three mains supply phases was or still is interrupted or too weak. ➤ Check supply phases (380V -20% to 460V +10%), is any of them too weak? ➤ All of the three mains phases must be symmetrical when applied.
	<b>OFF</b>	<b>Note:</b> (only with 3~ 400V <i>vector mc</i> )	Shown in the display when the inverter is regularly disconnected from the mains, with all three phases being equally reduced
<b>E008</b>	<b>8.0</b>	Parameter lost	EEPROM data corruption Software version of the stored data record does not match the software version of the inverter <b>Note:</b> Parameters which have been incorrectly set are reloaded automatically (with factory settings) Interference suppression is inadequate (cf. E020)
	<b>8.1</b>	Wrong inverter type	➤ EEPROM defective
	<b>8.2</b>	External EEPROM copying error (Control Box <i>mc</i> )	➤ Check proper fit of Control Box <i>mc</i> . ➤ Control Box <i>mc</i> EEPROM defective (P550 = 1).
<b>E009</b>	<b>---</b>	Control Box <i>mc</i> error	Communication fault between inverter and Control box <i>mc</i> ➤ Switch mains voltage off and then on again ➤ Clip on Control Box <i>mc</i> again
<b>E010</b>	<b>10.0</b>	USS timeout (P513)	➤ Telegrams are not transmitted correctly, check connection of external devices.
	<b>10.2</b>	Telegram timeout external bus subassembly	➤ Check program flow of bus protocol. ➤ Check bus master.
	<b>10.4</b>	External bus subassembly initialization error	➤ Check P746. ➤ Bus subassembly was not plugged in properly. ➤ Check power supply of bus subassembly.
	<b>10.1</b>		
	<b>10.3</b>		
	<b>10.5</b>	External bus subassembly system error	For more information see the respective Supplementary Operating Instructions of the bus subassembly involved.
	<b>10.6</b>		
	<b>10.7</b>		

Display		Type of failure	Cause
group	details see P700 / P701		➤ <b>What to do about it</b>
<b>E011</b>	<b>11.0</b>	Reference voltage	Reference voltage of customer interface is not right (10V/15V). This error signal is not displayed unless control proceeds via the control terminals (P509 = 0/1). ➤ Check control terminals for short-circuit fault
<b>E012</b>	<b>12.0</b>	External watchdog	The watchdog function having been assigned to a digital input, the required "high edge" was not applied within the time interval selected in P460 >watchdog cycle time<. ➤ External control error ➤ Cable interruption
<b>E013</b>	<b>13.2</b>	Disconnection control response error	The motor was brought to a halt by means of an "emergency stop". ➤ The torque current has reached the limit value (P112) .
<b>E020</b>	<b>20.0</b>	External RAM error	
	<b>20.1</b>	Watchdog	
	<b>20.2</b>	Stack overflow	
	<b>20.3</b>	Stack underflow	
	<b>20.4</b>	Undefined opcode	Error in the program execution as a result of electromagnetic interference
	<b>20.5</b>	Protected instruction	➤ Please verify observance of the 'wiring instructions' section 2.7
	<b>20.6</b>	Illegal word access	➤ Use additional external mains filter
	<b>20.7</b>	Illegal instruction access	➤ The inverter should be very effectively connected to earth
	<b>20.8</b>	EPROM error	
	<b>20.9</b>	Dual-port memory error	
	<b>21.0</b>	NMI (not used were hardware is concerned)	
	<b>21.1</b>	Wrong PLL	

## 7 Technical data

### 7.1 SK 250/1 FCT to SK 2200/1 FCT

NORDAC vector mc single-phase inverters for 230 V, with integrated line filter								
Inverter type	SK ... FCT	250/1	370/1	550/1	750/1	1100/1	1500/1	2200/1
Mains voltage		1 AC 230 V $\pm 15\%$ , 47 to 63 Hz						
Motor rating *	(kW)	0.25	0.37	0.55	0.75	1.1	1.5	2.2
	(hp)	$\frac{1}{3}$	$\frac{1}{2}$	$\frac{3}{4}$	1	$1\frac{1}{2}$	2	3
Inv. continuous output	at 230V	680 VA	780 VA	1.05 kVA	1.45 kVA	2.0 kVA	2.5 kVA	3.5 kVA
Nominal output current*	(A)	1.7	1.9	2.6	3.6	5.0	6.3	8.6
Max. contin. output current	(A)	1.9	2.1	2.9	4.0	5.5	6.4	9.5
Nominal (min.) brake resistance		180 $\Omega$ S3-40% (82 $\Omega$ , S3-20%), 2min.				82 $\Omega$ S3-20% (82 $\Omega$ S3-20%), 2min.		
Typ. input current (I rms)	(A)	3.3	4.5	6.2	8.2	10	13	18
Recommended line fuse	slow	10 A		16 A		16 A		25 A
North America: J-class fuse								
Connection cross section **	input	1.0 mm <sup>2</sup>		1.5 mm <sup>2</sup>		1.5 mm <sup>2</sup>		2.5 mm <sup>2</sup>
	output	1.0 mm <sup>2</sup>				1.5 mm <sup>2</sup>		
Ambient temperature		0°C to +50°C (see cf.7.3)						
Type of ventilation		convection cooling				fan cooling		
Dimensions (L x W x D)	(mm)	154 x 86 x 134				191 x 112 x 135		
Weight approx.	(kg / lb)	1.3 / 2.9				1.7 / 3.8		

\* Data relating to a 4-pole NORD motor or similar types

\*\* depending on the cable type and/or used cable sleeve

### 7.2 SK 750/3 FCT to SK 3000/3 FCT

NORDAC vector mc three-phase inverters for 380 - 460 V, with integrated line filter						
Inverter type	SK ... FCT	750/3	1100/3	1500/3	2200/3	3000/3
Mains voltage		3 AC 380 - 460 V -20% +10%, 47 to 63 Hz				
Motor rating *	(kW)	0.75	1.1	1.5	2.2	3.0
	(hp)	1	$1\frac{1}{2}$	2	3	4
Inv. continuous output	at 400V	1.5 kVA	2.0 kVA	2.5 kVA	3.6 kVA	4.8 kVA
Nominal output current *	(A)	2.2	3.0	3.7	5.5	7.0
Nominal (min.) brake resistance		120 $\Omega$ (90 $\Omega$ ) S3-50%, 2 min.			120 $\Omega$ (60 $\Omega$ ) S3-50%, 2 min.	
Typ. input current (I rms)	(A)	3.1	4.2	5.2	7.7	9.8
Recommended line fuse	slow	10 A			16 A	
North America: J-class fuse						
Connection cross section **	input	2.5 mm <sup>2</sup>				
	output	2.5 mm <sup>2</sup>				
Ambient temperature		0°C to +40°C (see cf. 7.3)				
Type of ventilation		fan cooling (9 - controlled)				
Dimensions (L x W x D)	(mm)	191 x 112 x 135				
Data relating to a	(kg / lb)	1,7 / 3,8				

\* Data relating to a 4-pole NORD motor or similar types

\*\* depending on the cable type and/or used cable sleeve

### 7.3 General technical data

Power factor:	$\lambda \geq 0.7$
Max. output frequency:	400 Hz
Resolution:	0.1 Hz
Typ. overload capacity:	150% for 30 s (related to the nominal current), see also P504!
Protective measures against:	Inverter overtemperature Over- and undervoltage Short-circuit, earth fault, overload, no-load
Types of control:	No-sensor vectorial current control, linear v/f characteristic
Analogue setpoint input/ PID input:	0 ... 10 V (recommended potentiometer 10 k $\Omega$ ), adjustable
Analogue setpoint resolution:	10-bit related to measuring range
Analogue output:	0 ... 10 V scalable, 5mA max.
Setpoint stability:	analogue < 1% digital < 0.02%
Motor temperature monitoring	PTC input
Ramp times:	0 - 99 s
Control outputs:	2 relays 230 V AC / 2 A (overvoltage cat.2); 28 V DC / 2 A <b>IMPORTANT:</b> external inductive loads must be adequately suppressed, e.g. by means of a free-wheeling diode or varistors
Interface:	RS 485 (standard) RS 232 (optional) Can Bus (optional) Profibus DP (optional)
Inverter efficiency:	approx. 95%
Ambient temperature:	0°C to +50°C, S1 mode for SK 250/1 FCT to SK 550/1 FCT 0°C to +50°C, S3-50% (5min.) for SK 750/1 FCT to SK 2200/1 FCT 0°C to +40°C, S1 operating mode for all NORDAC <i>vector mc</i> types The cooling medium must be free of moisture or aggressive gases. Protect the inverter against dirt (dust, fluffs, ...).
Storage and shipping temperature:	-40°C to +70°C, free of humidity and aggressive gases
Rel. humidity of the air:	90% without condensation
Place of installation altitude a.m.s.l.:	< 1000 m without the power being affected
Type of enclosure:	IP20
Electric isolation:	Control terminals (customer interface)
Maximum allowable mains connection frequency:	250 switching operations / h

## 8 Additional Information

### 8.1 Electromagnetic compatibility (EMC)

Since January 1996 all electrical, self-contained devices which can be used on their own and are marketed as individual units intended for operation by the final user, are required to satisfy the EEC/89/336 directive. Manufacturers may adopt any of the three different strategies described below to prove conformity with the said directive:

1. *EC conformity declaration*

This is a statement by which the manufacturer declares that the requirements of the European standards which are applicable to the electrical environment of the device are met. The manufacturer is not allowed to refer to standards other than those published in the official gazette of the European Community in his declaration.

2. *Technical documentation*

A technical documentation can be prepared in which the EMC properties of the device are described. This document must be licensed by a „Competent Authority“ appointed by the European government agency having jurisdiction in this domain. If this procedure is adopted it is possible to use standards which are still in a stage of preparation.

3. *EC type acceptance test certificate*

Application of this method is allowable for radio transmitters only

The NORDAC *vector mc* inverters have not got a function of their own unless they are connected to other units (e.g. to a motor). Hence the basic units cannot be provided with the CE marking which would certify conformity with the EMC directive. That is why the EMC properties of these products are described in greater detail below, while assuming that they have been installed in accordance with the instructions and recommendations mentioned in the present documentation.

#### **Class 1: General, for industrial environment**

In accordance with the EMC standard EN 61800-3 for power drives, for use in **secondary (industrial) environment** and provided that the devices **are not generally available**.

#### **Class 2: Interference-suppressed, for industrial environment (plants with supply transformers of their own)**

With this class of operation the manufacturer is allowed to certify himself that the EMC characteristics of his devices, when these are used in power drives, will indeed satisfy the requirements of the EMC directive for industrial environments. They are supposed to meet the limit values as defined in the basic standards EN 50081-2 and EN 50082-2 for interference emission and immunity in industrial environments.

#### **Class 3: Interference-suppressed, for residential areas, business and light industry environments**

With this class of operation the manufacturer is allowed to certify himself that the EMC characteristics of his devices, when these are used in power drives, will indeed satisfy the requirements of the EMC directive for residential, business and light industry environments. They are supposed to meet the limit values as defined in the basic standards EN 50081-1 and EN 50082-1 for interference emission and immunity.

**Note:** The NORDAC *vector mc* frequency inverters are intended **for industrial uses exclusively**. They are not subject therefore to Standard EN 61000-3-2 harmonics emission requirements.

## 8.2 EMC table:

Unit type	without add. line filter	with add. line filter		Line filter type
SK 250/1 FCT - SK 750/1 FCT	class 2	class 2	class 3	HFE 141 - 230/9
SK 1100/1 FCT - SK 2200/1 FCT	class 2	class 2	class 3	HFE 141 - 230/18
SK 750/3 FCT - SK 3000/3 FCT	class 2	class 2	class 3	HFD 141 - 400/10
Motor cable, shielded, max. length	15m (SK .../1 FCT) 10m (SK .../3 FCT)	50m	30m	

**NOTE:** Please keep in mind that meeting of the respective noise limit class requirements cannot be ensured unless the standard switching frequency (**6kHz** or less) is used and the length of the shielded motor cables will not exceed.

Wiring, too, must absolutely take EMC requirements into account.

Class 3 requirements can only be met provided that the inverter is built into an *interference-proof* switch-box (cabinet) along with the additional line filter!

The Motor cable screen must be connected at both ends (to the screen mounting bar on the inverter, the metal motor terminal box), and additionally to the cable entry into the control enclosure (to achieve class 3 [B]).

<i>Survey of the EN 50081; 50082 standard requirements which, according to EN 61800-3 (product standard for FI), must be and indeed are observed</i>			
	<b>Standard</b>	<b>Class of limiting values</b>	
<b>Interference emission</b>			
Noise emitted by the cabling	EN55011	"A"	"B" , if a filter is used
Interference produced by the device	EN55011	"A"	"B" , if unit is provided with a filter and installed in switch cabinet
<b>Immunity to interference</b>			
ESD	EN61000-4-2	8kV (AD&CD)	
Burst on control lines	EN61000-4-4	2kV	
Burst on supply and motor lines	EN61000-4-4	4kV	
Surge (phase-phase / -ground)	EN61000-4-5	1kV / 2kV	
EMF	EN61000-4-3	10V/m; 26-1000MHz	
Voltage fluctuations and dips	EN61000-2-1	+10%, -15%; 90%	
Voltage phase unbalances and frequency changes	EN61000-2-4	3%; 2%	



**Wiring recommendations to enable class 3 requirements to be observed**

**1-Phase power supply**

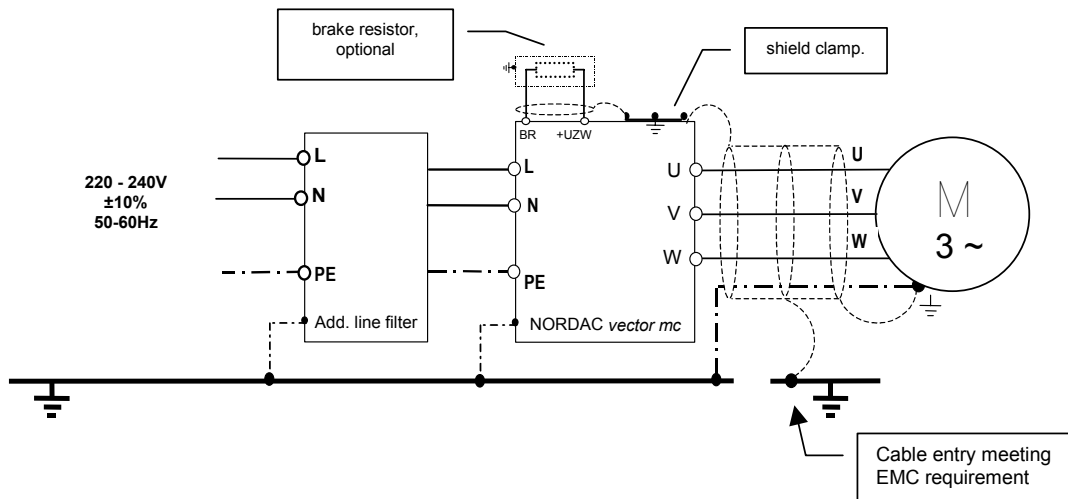

**3-Phase power supply**

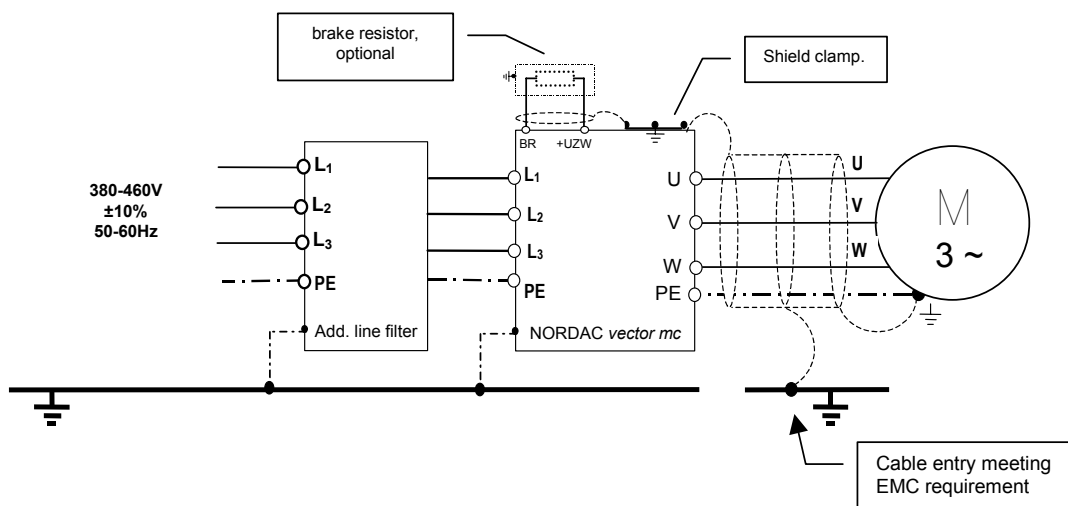

### 8.3 PID controller

With a PID controller the constancy of a process can be ensured (in accordance with a setpoint) provided that information on the variable to be controlled is fed back to the controller. If the job consists in keeping up a constant pressure value, a pressure sensor supplying a signal between 0 and 10 volts could for instance be used to return information on actual pressure values. In applications with a need for level control, actual levels can be detected by means of a potentiometer fixed to the dancer arm.

With the NORDAC *vector mc* , setpoint and actual values can be processed in a variety of ways.

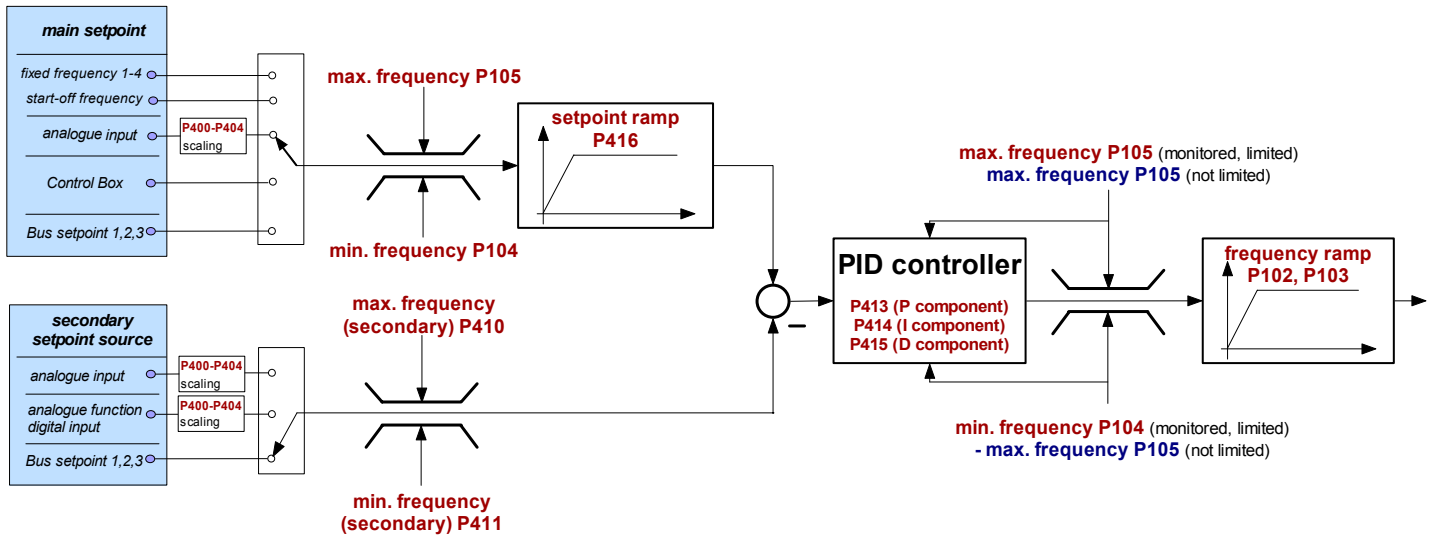

### 8.4 Process controller

The process controller is a PI controller extended to ensure the processing of a master setpoint and allowing for limitation of the controller output. By defining a master setpoint for a drive added on input or output side (with a variable motor or web speed) it is possible to vary the servodrive to be controlled. This servodrive is again readjusted by the PI controller.

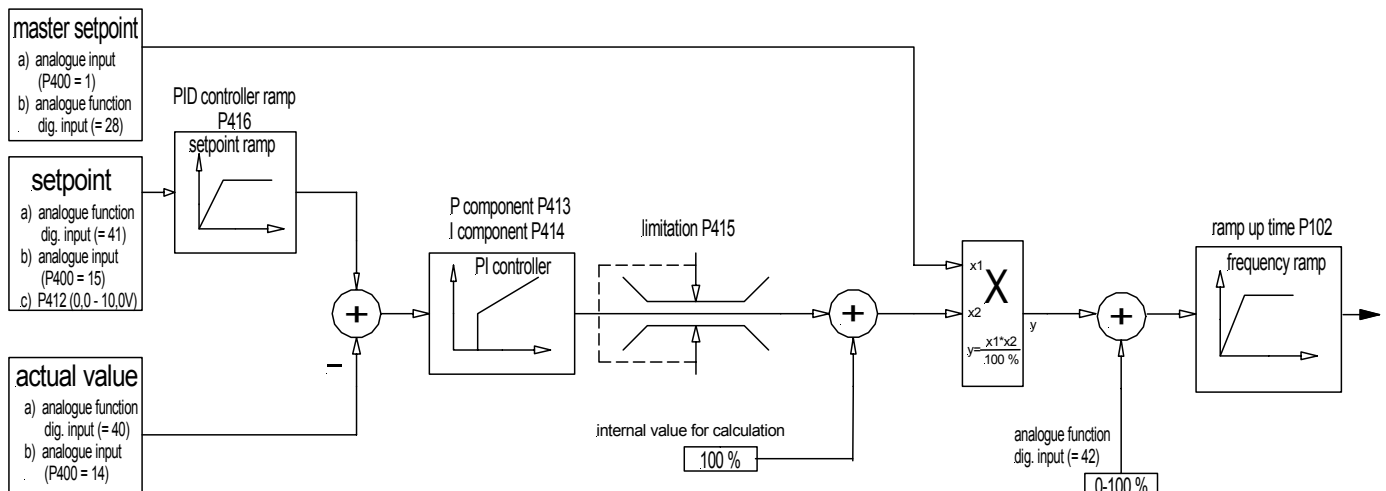

### 8.4.1 Typical use of a process controller

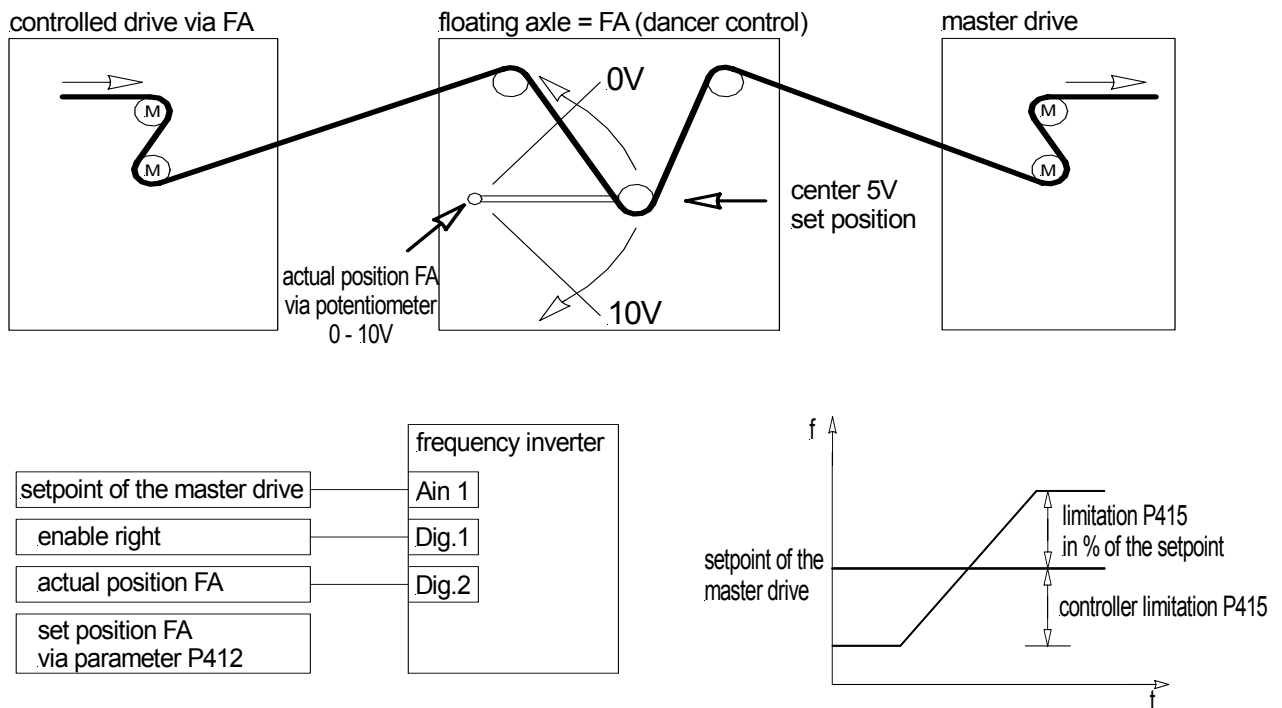

### 8.4.2 Parameter settings on the frequency inverter

(Example: setpoint frequency: 50 Hz, control limits: +/- 25%)

$$P105 \text{ (maximum frequency) [Hz]} : \geq Sollfrq.[Hz] + \left( \frac{Sollfrq.[Hz] \times P415[\%]}{100\%} \right)$$

$$: \text{ex. } \geq 50\text{Hz} + \frac{50\text{Hz} \times 25\%}{100\%} = \mathbf{62.5\text{ Hz}}$$

P400 (analogue input function) : **"4"** (frequency addition)

P411 (setpoint frequency) [Hz] : setpoint frequency with 10V at analogue input 1  
: e.g. **50 Hz**

P412 (process controller setpoint) : mid-position DR / factory setting **5 V** (adjust if necessary)

P413 (P controller) [%] : factory setting **10%** (adjust if necessary)

P414 (I controller) [% / ms] : recommended **0.1 %/ms**

P415 (limitation +/-) [%] : controller limitation (see above) e.g. **25%** of setpoint

P416 (ramp prior to controller) [s] : factory setting **2s** (align with control response if necessary)

P420 (function digital input 1) : **"1"** enable right

P421 (function digital input 2) : **"40"** PID process controller actual value

## 8.5 Recommendations for service and maintenance

NORDAC *vector mc* frequency inverters do not need any maintenance when operated according to instructions.

If the frequency inverter is operated in dust-laden air, the cooling surfaces must be regularly cleaned with compressed air. Likewise any air inlet filters provided in the switching cabinet must be cleaned or replaced at regular intervals.

If a repair is necessary please send the device to:

***your local NORD distribution agency***

Any information required concerning repair should be obtained from:

***your local NORD distribution agency***

If a frequency inverter is sent to the manufacturer for repair, no guarantee can be assumed for attachments such as line cables, potentiometers, external displays etc.!

Kindly remove from the inverter all parts which are not genuine.

## 8.6 Additional information

Apart from the present Operating Instructions we provide a comprehensive manual in German, English, and French on our site in the Internet.

<http://www.nord.com/>

If you prefer the manual being sent to you, call your local NORD distribution agency which will be glad to comply with your request.

## 8.7 UL/CUL certification

**For the North American market:** UL and CUL certification

File: E171342

“Suitable for connection to a mains supplying 230V (single-phase units) or 460V (three-phase units), with a short-circuit current of 5000amps max. balanced to earth and if protected by “J class fuses” as pointed out in Section 8.



- Tightening moments for field wiring terminals:
  - 5.3 pound-inches (0.6Nm): control terminals 1 to 4  
mains connection  
motor connection  
braking resistor connection
  - 2.2 pound-inches (0.25Nm): control terminals 5 to 18
- Overload protection of the motor not included as standard
- Overload protection of motor to be ensured by the owner of the plant
- Overspeed protection of the motor not included as standard
- Ambient temperature 40°C max.

## 9 Index

<b>+</b>		
+/- 10V setpoint board.....	18	
<b>A</b>		
Accessories available.....	5	
Additional parameters .....	43	
addresses.....	62	
analogue input.....	35	
<b>B</b>		
Basic parameters .....	29	
Basic settings.....	23	
Block diagram.....	13	
Brake resistors.....	11	
branches .....	62	
<b>C</b>		
cable length.....	15	
CAN bus module .....	22	
CANopen module .....	22	
CE.....	6	
characteristic curves.....	32	
characteristics.....	4	
Control box <i>mc</i> .....	19	
Control Box <i>mc</i> .....	19	
Control terminals.....	16, 35	
current setpoint .....	17	
<b>D</b>		
DC injection time .....	48	
default settings.....	45	
DeviceNet module .....	22	
digital input settings.....	39	
Dimensions.....	8	
DIN rail clip .....	9	
<b>E</b>		
EEC/89/336 directive.....	55	
electromagnetic brakes.....	31	
Electromagnetic compatibility.....	55	
electromagnetic interference.....	12	
EMC .....	55	
EN 61800-3 .....	56	
EN55011 .....	56	
Error signals .....	50	
European EMC Directive .....	6	
external brake.....	31	
<b>F</b>		
Features.....	4	
<b>H</b>		
HFD 141 .....	10	
HFE 141.....	10	
<b>I</b>		
I <sup>2</sup> t- motor.....	46	
Information.....	48	
Interference emission .....	56	
<b>L</b>		
LED.....	19	
lifting applications.....	31	
Line filters .....	10	
Linear v/f characteristic.....	34	
<b>M</b>		
Magnetisation time .....	48	
master function .....	43	
Menu group.....	25	
motor cable.....	15	
Motor connection.....	33	
motor data .....	23, 32	
Motor temperature sensor.....	17	
Mounting.....	7	
multiple-motor operation.....	15	
<b>N</b>		
nameplate.....	23	
<b>O</b>		
OFF .....	51	
Operating parameters.....	29	
Operation and display .....	19	
overload capacity (I <sup>2</sup> t) .....	43	
<b>P</b>		
Parameter description .....	29	
Parameterisation .....	25	
PID controller .....	58	
Power supply terminals .....	15	
Process controller .....	58	
Profibus module .....	22	
PTC resistor.....	17	
Pulse frequency .....	43	
<b>R</b>		
Relay 1 functions .....	41	
Relay 2 functions .....	42	
RS 232 Box.....	22	
<b>S</b>		
safety and installation.....	5	
screen supporting bar.....	9	
shield clamping device.....	14	
Stator resistance .....	33	
Subsidiaries .....	63	
Survey of parameters .....	26	
Systemfehler.....	52	
<b>T</b>		
Technical data .....	53	
<b>U</b>		
UL and CUL licenses .....	6	
UL certification.....	60	
USS Time Out .....	51	
<b>V</b>		
vectorial current control.....	34	
<b>W</b>		
Wiring instructions .....	12	

## 10 Subsidiaries and Branches

**We are always close at hand - world wide - **Getriebbau NORD****

### **Getriebbau NORD branches, in Germany:**

#### **Niederlassung Nord**

Getriebbau NORD GmbH & Co. KG  
Rudolf-Diesel-Str. 1  
22941 Bargteheide  
Tel. 04532 / 401 - 0  
Fax 04532 / 401 - 429

#### **Vertriebsbüro Bremen**

Getriebbau NORD GmbH & Co. KG  
Am Suletal 16  
27232 Sulingen  
Tel. 04271 / 9548 – 50  
Fax 04271 / 9548 – 51

#### **Niederlassung West**

Getriebbau NORD GmbH & Co. KG  
Großenbaumer Weg 10  
40472 Düsseldorf  
Tel. 0211 / 99 555 - 0  
Fax 0211 / 99 555 - 45

#### **Vertriebsbüro Butzbach**

Getriebbau NORD GmbH & Co. KG  
Marie-Curie-Str. 2  
35510 Butzbach  
Tel. 06033 / 9623 – 0  
Fax 06033 / 9623 – 30

#### **Niederlassung Süd**

Getriebbau NORD GmbH & Co. KG  
Katharinenstr. 2-6  
70794 Filderstadt-Sielmingen  
Tel. 07158 / 95608 - 0  
Fax 07158 / 95608 - 20

#### **Vertriebsbüro Nürnberg**

Getriebbau NORD GmbH & Co. KG  
Schillerstr. 3  
90547 Stein  
Tel. 0911 / 67 23 11  
Fax 0911 / 67 24 71

#### **Vertriebsbüro München**

Getriebbau NORD GmbH & Co. KG  
Untere Bahnhofstr. 29a  
82110 Germering  
Tel. 089 / 840 794 - 0  
Fax 089 / 840 794 - 20

#### **Niederlassung Ost**

Getriebbau NORD GmbH & Co. KG  
Leipzigerstr. 58  
09113 Chemnitz  
Tel. 0371 / 33 407 - 0  
Fax 0371 / 33 407 - 20

#### **Vertriebsbüro Berlin**

Getriebbau NORD GmbH & Co. KG  
Heinrich- Mann- Str. 8  
15566 Schöneiche  
Tel. 030 / 639 79 413  
Fax 030 / 639 79 414

#### **Vertretung:**

**Hans-Hermann Wohlers**  
Handelsgesellschaft mbH  
Ellerbuscher Str. 177a  
32584 Löhne  
Tel. 05732 / 4072  
Fax 05732 / 123 18

---

### **Headquarter Germany / Head Office Germany:**

Getriebbau NORD GmbH & Co. KG  
Rudolf- Diesel- Straße 1  
D – 22941 Bargteheide  
Tel. +49 / (0) 4532 / 401 – 0  
Fax +49 / (0) 4532 / 401 – 555

[Info@nord-de.com](mailto:Info@nord-de.com)

<http://www.nord.com>

**Getriebbau NORD Subsidiaries Worldwide:****Austria / Österreich**

Getriebbau NORD GmbH  
Deggendorfstr. 8  
A - 4030 Linz  
Tel.: +43-732-318 920  
Fax: +43-732-318 920 85

[info@nord-at.com](mailto:info@nord-at.com)

**Canada / Kanada**

NORD Gear Limited  
41, West Drive  
CDN - Brampton, Ontario, L6T 4A1  
Tel.: +1-905-796-3606  
Fax: +1-905-796-8130

[info@nord-ca.com](mailto:info@nord-ca.com)

**Denmark / Dänemark**

NORD Gear Danmark A/S  
Kliplev Erhvervspark 28 – Kliplev  
DK - 6200 Aabenraa  
Tel.: +45 73 68 78 00  
Fax: +45 73 68 78 10

[info@nord-dk.com](mailto:info@nord-dk.com)

**Great Britain / Großbritannien**

NORD Gear Limited  
11, Barton Lane  
Abingdon Science Park  
GB - Abingdon, Oxfordshire OX 14 3NB  
Tel.: +44-1235-5344 04  
Fax: +44-1235-5344 14

[info@nord-uk.com](mailto:info@nord-uk.com)

**Italy / Italien**

NORD Motoriduttori s.r.l.  
Via Modena 14  
I - 40019 Sant' Agata Bolognese (BO)  
Tel.: +39-051-6829711  
Fax: +39-051-957990

[info@nord-it.com](mailto:info@nord-it.com)

**P.R. China / V. R. China**

NORD (Beijing) Power Transmission Co.Ltd.  
No. 5 Tangjiacun,  
Guangqudonglu, Chaoyangqu  
Beijing 100022  
Tel.: +86-10-67704 -069 (-787)  
Fax: +86-10-67704 -330

[Fpan@nord-cn.com](mailto:Fpan@nord-cn.com)

**Slovakia / Slowakei**

NORD Pohony, s.r.o  
Stromová 13  
SK - 83101 Bratislava  
Tel.: +421-2-54791317  
Fax: +421-2-54791402

[info@nord-sl.com](mailto:info@nord-sl.com)

**Switzerland / Schweiz**

Getriebbau NORD AG  
Bächigenstr. 18  
CH - 9212 Arnegg  
Tel.: +41-71-388 99 11  
Fax: +41-71-388 99 15

[info@nord-ch.com](mailto:info@nord-ch.com)

**Belgium / Belgien**

NORD Aandrijvingen België N.V.  
Boutersem Dreef 24  
B - 2240 Zandhoven  
Tel.: +32-3-4845 921  
Fax: +32-3-4845 924

[info@nord-be.com](mailto:info@nord-be.com)

**Croatia / Kroatien**

NORD Pogoni d.o.o.  
Obrtnicka 9  
HR - 48260 Krizevci  
Tel.: +385-48 711 900  
Fax: +385-48 711 900

**Finland / Finnland**

NORD Gear Oy  
Aunankorvenkatu 7  
FIN - 33840 Tampere  
Tel.: +358-3-254 1800  
Fax: +358-3-254 1820

[info@nord-fi.com](mailto:info@nord-fi.com)

**Hungary / Ungarn**

NORD Hajtastechnika Kft.  
Törökkö u. 5-7  
H - 1037 Budapest  
Tel.: +36-1-437-0127  
Fax: +36-1-250-5549

[info@nord-hg.com](mailto:info@nord-hg.com)

**Netherlands / Niederlande**

NORD Aandrijvingen Nederland B.V.  
Voltstraat 12  
NL - 2181 HA Hillegom  
Tel.: +31-2525-29544  
Fax: +31-2525-22222

[info@nord-nl.com](mailto:info@nord-nl.com)

**Poland / Polen**

NORD Napedy Sp. z.o.o.  
Ul. Grottgera 30  
PL – 32-020 Wieliczka  
Tel.: +48-12-288 22 55  
Fax: +48-12-288 22 56

[biuro@nord.pl](mailto:biuro@nord.pl)

**Spain / Spanien**

NORD Motorreductores  
Ctra. de Sabadell a Prats de Llucanès  
Aptdo. de Correos 166  
E - 08200 Sabadell  
Tel.: +34-93-7235322  
Fax: +34-93-7233147

[info@nord-es.com](mailto:info@nord-es.com)

**Turkey / Türkei**

NORD-Remas Redüktör San. ve Tic. Ltd. Sti.  
Tepeören Köyü  
TR - 81700 Tuzla – Istandbul  
Tel.: +90-216-304 13 60  
Fax: +90-216-304 13 69

[info@nord-tr.com](mailto:info@nord-tr.com)

**Brazil / Brasilien**

NORD Motores do Brasil Ltda.  
Rua Epicuro, 128  
CEP: 02552 - 030 São Paulo SP  
Tel.: +55-11-3951 5855  
Fax: +55-11-3856 0822

[info@nord-br.com](mailto:info@nord-br.com)

**Czech Republic / Tschechien**

NORD Poháněci Technika s.r.o  
Palackého 359  
CZ - 50003 Hradec Králové  
Tel.: +420-495 5803 -10 (-11)  
Fax: +420-495 5803 -12

[hzubr@nord-cz.com](mailto:hzubr@nord-cz.com)

**France / Frankreich**

NORD Réducteurs sarl.  
17 Avenue Georges Clémenceau  
F - 93421 Villepinte Cedex  
Tel.: +33-1-49 63 01 89  
Fax: +33-1-49 63 08 11

[info@nord-fr.com](mailto:info@nord-fr.com)

**Indonesia / Indonesien**

PT NORD Indonesia  
Jln. Raya Serpong KM. 7  
Kompleks Rumah Multi Guna Blok D No. 1  
Pakulonan (Serpong) - Tangerang  
West Java - Indonesia

Tel.: +62-21-5312 2222  
Fax: +62-21-5312 2288

[info@nord-ri.com](mailto:info@nord-ri.com)

**Norway / Norwegen**

NORD Gear Norge A/S  
Vestre Haugen 21  
N - 1054 Furuset / Oslo  
Tel.: +47-23 33 90 10  
Fax: +47-23 33 90 15

[info@nord-no.com](mailto:info@nord-no.com)

**Singapore / Singapur**

NORD Gear Pte. Ltd.  
33 Kian Teck Drive, Jurong  
Singapore 628850  
Tel.: +65-6265 9118  
Fax: +65-6265 6841

[info@nord-sg.com](mailto:info@nord-sg.com)

**Sweden / Schweden**

NORD Drivsystem AB  
Ryttargatan 277 / Box 2097  
S - 19402 Upplands Väsby  
Tel.: +46-8-594 114 00  
Fax: +46-8-594 114 14

[info@nord-se.com](mailto:info@nord-se.com)

**United States / USA**

NORD Gear Corporation  
800 Nord Drive / P.O. Box 367  
USA - Waunakee, WI 53597-0367  
Tel.: +1-608-849 7300  
Fax: +1-608-849 7367

[info@nord-us.com](mailto:info@nord-us.com)

---

## **Getriebbau NORD**

GmbH & Co. KG  
Postfach 12 62  
22934 Bargteheide

