



Starting Lockout Function in TDM Servo Drive Modules

Applications manual

DOK-ANAX**-TDM*ANL*FKT-ANW1-EN-P



Title: Starting Lockout Function in TDM Servo Drive Modules

Type of Documentation: Application Manual

Doc. No.: 9.555.012.4-05 EN / 4/94

Internal File Ref.: File No. 4 / •startinglockout TDM EN

Replaces: 9.555.012.4-03 DE / 3/93

The purpose
of this document



This document serves:

- to define possible application and operating conditions
- to assist in project planning and installation
- the commissioning and monitoring of the starting lockout function

Copyright: Copying of this document, and giving it to others and the use or communication of the contents thereof without express authority are forbidden. Offenders are liable to the payment of damages. All rights are reserved in the event of the grant of a patent or the registration of a utility model or design.

Validity: We reserve the right to make changes to the documents and in product delivery.

| Table of Contents | Page |
|---|-------------|
| 1. Possible applications of the starting lockout | 7 |
| 1.1. A safe way to power down separate working areas in machinery or plant | 7 |
| 1.2. Operating individual axes during installation | 10 |
| 2. How the starting lockout works | 11 |
| 2.1. The function of the motor control | 11 |
| 2.2. Using the starting lockout signal to safely power down the motor | 11 |
| 3. Installation and operating guidelines | 14 |
| 3.1. Application guidelines for disconnecting the power mains, standstills and securing against unintentional start-ups ... | 14 |
| 3.1.1. Using the master switch to disconnect the mains | 14 |
| 3.1.2. Using the mains contactor to disconnect the mains | 14 |
| 3.1.3. Using the starting lockout to secure against intentional start ups | 14 |
| 3.2. Connecting terminals | 15 |
| 3.3. Sequence and procedures when using the starting lockout | 16 |
| 3.4. Testing | 19 |
| 3.5. Examples of applications | 19 |
| 4. Controller types and related plans | 23 |
| 4.1. Summary of the types of controllers | 23 |
| 4.2. Frontal view | 24 |
| 4.3. Dimensional data | 29 |
| 4.4. Installation dimensions | 31 |
| 4.5. Terminal interconnect diagrams | 34 |



Please note the guidelines outlined in Section 3 prior to commissioning the starting lockout!

1. Possible applications of the starting lockout

1.1. A safe way to power down separate working areas in machinery or plant

Production systems, transfer lines and machine tools often consist of spatially separated working areas, e.g., processing units, transport, handling and storage systems (see Figure 3).

It is frequently necessary for personnel to either work or access something in one working area while machinery is running in an adjacent working area. This means that the drive axes within an individual's working area must be **secured against any unintentional motions** so that an individual is not at risk from dangerous drive motions caused by a fault somewhere else in the facility.

If the drive axes in adjacent working areas and in the danger zone are centrally connected to the power mains by a supply unit (e.g., supply modules TVM, KDV, TVD, KVR), then each direct-drive motor must be individually secured against unintentional motions. The danger zone is the area in which the individual is working.

The starting lockout built into every INDRAMAT drive module makes it easy to safely power down the motor of each axis with a simple switch. This switch disconnects the output stage from the control electronics with the use of a relay in the hardware. The user gains the following advantages:

1. Savings in cost and space

A single power supply unit can feed the drive axes of several working areas. Individual power supply units are not needed for each drive axes in every spatially separated working area.

In several applications, a large three-phase motor contactor with one or two axes is built into the motor supply lines. The motor contactors make it possible to safely switch off these axis motors, and to use only one supply unit to operate all drives.

This function is now easy to perform without a power contactor on the drive module by controlling the starting lockout input. This represents a savings in cost and space in the control cabinet.

1. Applications

2. Increased safety and reliability:

Personnel safety and facility reliability are increased because a mains contactor is not needed to disconnect the motor from the drive module.

- Eliminated are breakdowns caused by frequent switching, gumming or burning of the contacts of this contactor due to high load currents.

The danger of damage to the motor mains contacts from improper handling or commissioning is eliminated.

- The motors no longer brake uncontrolled with a power failure.

A motor contactor without a mechanical locking mechanism is dropped in a power failure. This means the motor will idle and the DC bus energy cannot be used for braking.

- The existing mains contactor is presently used to secure against unintentional motions. It is switched on and off once during every duty cycle. With a starting lockout in an INDRAMAT drive module the mains contactor does not need to be frequently switched, i.e., with every cycle. It is only used with E-stops, for maintenance and inspection work throughout the plant, and with every total shut-down. There is less wear and tear, and failures occur less frequently.

- If two faults occur simultaneously, then a motor can run up uncontrolled if a motor contactor is used to secure against unintentional motions.

Example:

- speed command voltage at maximum due to fault in NC, and,
- the motor contactor fails.

In the unlikely event that two faults occur simultaneously in the power supply, then the motor will only jerk if an internal starting lockout is in the INDRAMAT drive amplifier.

The internal control circuits and the output stage control are internally locked for additional safety. An external motor contactor does not ensure an additional internal locking of the drive electronics.

1. Applications

- The drive is **secured** by **applying power** to the starting lockout input. This meets the following safety requirements:

I. Quickest possible standstill

The drives must be brought to a standstill „as quickly as possible“ in an emergency, in other words, in a dangerous situation (VDE Guidelines 0113/EN 60204, Part 1, Para. 5.6.1).

If an external voltage failure should occur in the control circuit of the AS starting lockout while the motor is rotating, then the drive is not switched off and cannot continue to run. If a drive is running or something is being processed at the time this happens, no tool or workpiece will be damaged once the drive is cleared.

There can be a controlled electrical shutdown of the drives via the NC and the drive module.

II. No automatic restarts

The drives cannot automatically restart when power is reapplied to the starting lockout input (VDE 0113/EN 60204, Part 1, Para. 5.4, VDI 2853, Sec. 3.1.2.3). The drives are blocked.

III. Remaining in a safe state with a fault

A drive will remain in a safe state even with a fault, e.g., the control voltage drops off at the lockout input. This is in accordance with the Guidelines VDE 0113/EN 60204, Part 1, Para. 5.7.2 („Special current circuits that serve safety purposes must take on their secure state in the event of a failure.“), and VDE 2853, Para. 3.1.2.1.1.

This condition is met because

- the controller enable signal and the command input keep the drive blocked, and,
- once the fault has occurred, the mains contactor immediately disconnects the power supply unit from the mains via the mains contactor by the acknowledgement contact on the drive controller. This completely switches all drives dead.

1.2. Operating individual axes during installation

Drives are frequently run individually during installation. In this case as well, personnel is often found within the danger zone. Generally, the acknowledgement switch is used to switch on the mains contactor to operate the axes. The mains contactor is then switched off again if unwanted movement occurs, or at the end of an operation.

The safety of personnel within a danger zone is increased, if the starting lockout is additionally built into INDRAMAT's drive modules. It helps to secure against unwanted starts during **installation**. This is possible because the internal, forcibly-connected contacts mean that the axes not being run can be additionally blocked.

In addition, using this relay to switch the motors on and off reduces wear and tear. In effect, it also increases reliability and safety.

2. How the Starting Lockout Works

2.1. Motor controller function

The power for motor current and thus the torque are advanced via the final output stage (driver) of the drive module. The extent of the current in the three phases of the three-phase motor is transmitted by the controller electronics to the final output stage in the form of a switch-mode pulse-width modulated signal.

In this case, the controller electronics serve the following purpose:

The greater the width of the pulse or the switch-mode ratio, the greater the motor current. The three currents in the three phases of the motor must additionally be adjusted, in terms of amount and phase position, to the rotor position given at that point in time, for sufficient torque to be produced.

There can be no motor revolutions at the motor shaft if there is no pulse-width modulated signal at the final output stage.

2.2. Using the starting lockout signal to secure power off

The signal at terminals AS1-AS2 of INDRAMAT's drive module activates an internal relay which has two forcibly-connected contacts (see Fig. 1). The relay has been quality controlled.

- The first contact of this relay separates the internal controller voltage of the final output stage in the hardware.
- The control and controller electronics are simultaneously and additionally blocked. This achieves double redundancy.
- The second contact (acknowledgement contact) signals the activation of the first contact to the outside.

A disconnection of the output stage controller is signalled via this additional acknowledgement contact (contact) ASQ-ASQ, to verify whether the relay has actually been activated or not. This contact is forcibly-connected to the primary contact.

A relay failure or a wire break in the conductors to the starting lockout inputs AS1-AS2 is immediately recognized by this zero-potential acknowledgement contact in the external control. The central mains contactor is then immediately disconnected.

This means it is not possible, in the event of a fault and given all conceivable possibilities, that a switch-mode motor current (alternating current) could be produced within the electrical facilities of the machine which could make the motor move.

It is also not possible for a current to flow through the motor even when a fault occurs in one of the six final output stages. The drive does not move. This fault is immediately acknowledged

- as soon as personnel has moved out of the danger zone,
- when the machine or sector of the facility has been properly reblocked.

2. How the Starting Lockout Works

and the drive is reactivated

- by disconnecting starting lockout inputs AS1-AS2,
- by electronically enabling the controller amplifier, and,
- by entering the speed set-point.

This fault causes an excessively high current which triggers a response from the fuses in the drive module. Then the mains contactor disconnects all drives from the mains. Message „BS“ on the defective drive module also displays the fault overcurrent.

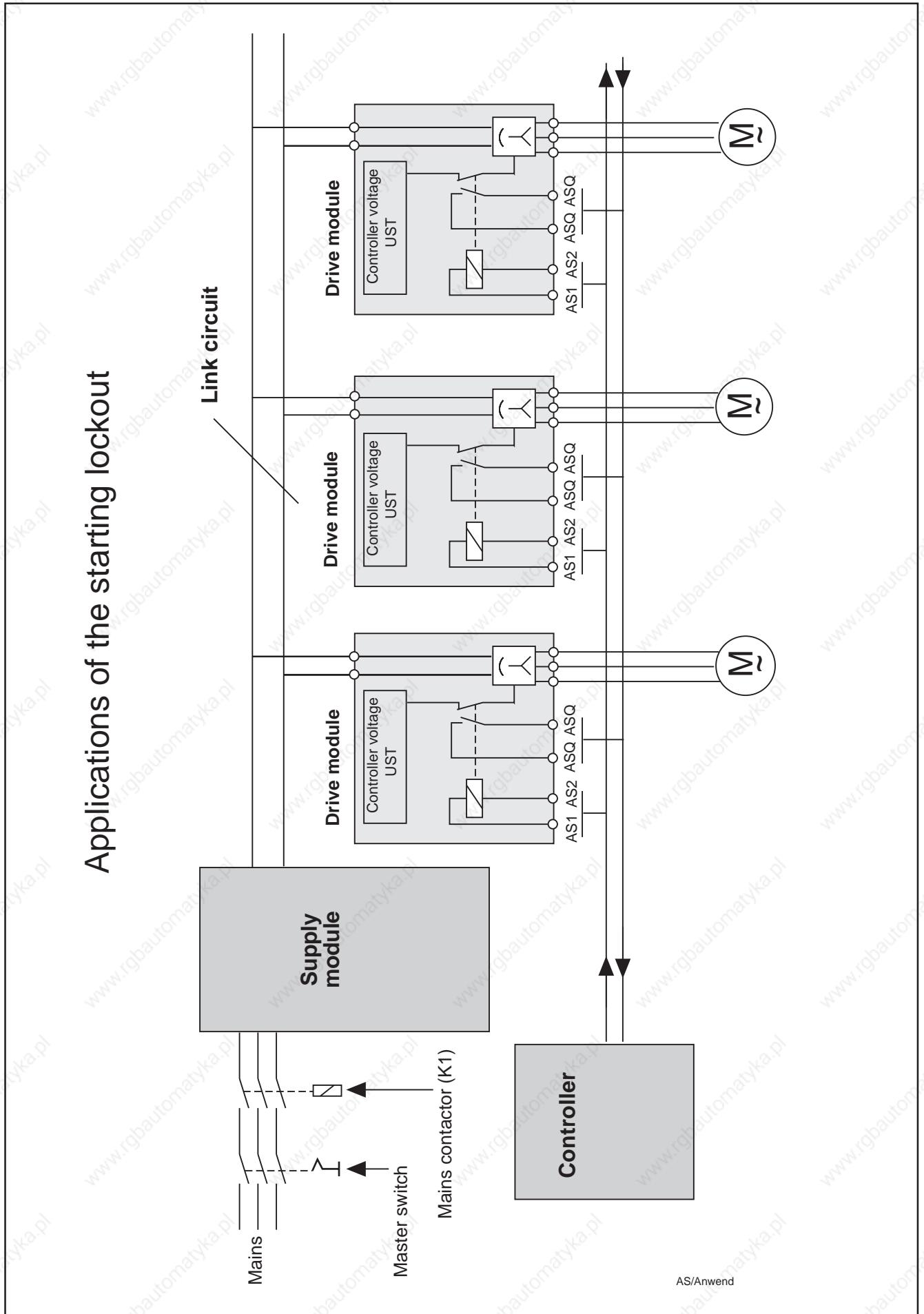

Figure 1: How the starting lockout works

3. Installation and Operating Guidelines

3.1. Guidelines for disconnecting the mains, for shutdowns and securing against unwanted starts

3.1.1. Using the master switch to disconnect the mains

The master switch must be used to disconnect all of the machine's electrical equipment from the mains in the following instances:

- when cleaning the machine
- for maintenance and repairs
- prior to long breaks in operation



It is not permitted in these cases to just disconnect the mains contactor or activate the starting lockout.

The master switch must adhere to the guidelines outlined in EN 60204/VDE 0113, Sec. 5.6.2. It is of extreme importance that it can be locked into an off position.

3.1.2. Using the mains contactor to disconnect the mains

In an emergency off/emergency stop situation the mains contactor must be disconnected directly so that all main current circuits are switched to zero potential. Those main current circuits that serve safety purposes must be disconnected first, but not until these measures have been concluded.

An emergency off situation is defined as danger to either personnel or machinery in the presence of several faults or problems.

3.1.3. Using the starting lockout to secure against unwanted starts

The starting lockout exclusively serves to secure the attached motors against unintentional starts caused by a fault. Activating it while the motor is running does not automatically guarantee that the drives will be safely shutdown.



The NC and the drive module cannot be used to operate the drives once the starting lockout has been activated. The motor is torque-free. A controlled operation of the axes is no longer possible.

During the planning stage and at that time when the machine is commissioned it should be determined that the starting lockout can only be activated when the motor is standing still. This applies to those cases where a torque-free operation of the drive can cause damage. It is therefore necessary with hanging axes to tightly clamp the axis before activating the mechanical brake.

3. Installation and Operating Guidelines

It is not possible to use (only) the starting lock in the following cases:

- for the purpose of electrically separating the motor from the power voltage of the drive module, e.g., when exchanging motors;
- for any other maintenance, repair or cleaning work on the machine.

A master switch is used to disconnect the mains (see Section 3.1.1).

3.2. Connecting Terminals

| Terminal designation | Function | Connected value |
|----------------------|--|--|
| AS1 - AS2 | Controller for activating the starting lockout. The red light-emitting diode „AS“ is lit up when the starting lockout is activated: | Voltage: 20...30 volts DC Current: 20 mA DC at 24 volts Power: 0,5 watts |
| ASQ - ASQ | Acknowledgement contact at zero potential (make contact). It acknowledges activation to an external controller/monitor. | Contact load: 24 volts, 1 amp. |
| TMI - TMI (1) | Motor thermostat contact connection. Evaluated in the servo drive module. | |
| TMO - TMO (1) | Output message „motor excess temperature“. Relay contact opens if motor temperature too high. | Contact load: 24 volts, 1 amp. |
| BRI+ - BRI- (1) | Input for controller voltage for motor blocking brake. | 24 Volt \pm 10% |
| BRO+ - BRO- (1) | Motor blocking brake connection, in acc. with connection plan. | |

1) Not in TDM 1.3.

3.3. Sequence and cycle when using the starting lockout

The function and reliability of the starting lockout in its interaction with all other system components of the machine or facility are only as good and as safe as the extent to which the following guidelines were taken into consideration during planning and were checked during the commissioning of the machine.

Figure 2 outlines the chronological sequence:

1. Shutdown drives:

The drives which are to be shutdown must first be brought to rest before the starting lockout can be activated.

The starting lockout can only be used where a torque-free slowing down can cause damage, and can only be activated when the motor is standing still. It is otherwise not possible to electrically shutdown a running drive with the use of a drive module.

A starting lockout should only be activated, even when the motor is running, if a safe slowing down without a brake via the drive module is guaranteed.

2. Drive electronically blocked:

The speed set-point input (terminals E1-E2, E3-OVM, E4-OVM) must be set to zero, and the controller enable input signal (terminal RF) of the drive amplifier must be connected to OVM. This increases both safety and redundancy.

3. Activating the starting lockout:

A voltage of 20 ... 30 volts must be placed between the input terminals AS1-AS2 to activate the starting lockout (0.5 watts at 24 volts of applied voltage).

The switching of the starting lockout relay in the drive amplifier is hereby confirmed to the external controller by closing the potential-free acknowledgement contact (output ASQ-ASQ).

The red diode „AS“ on the front plate lights up simultaneously.

4. Commissioning operation:

If one or several axes are to be operated during the commissioning operation with protective devices cancelled, then this should only be possible if qualified personnel enable this type of operation with a key switch.

All drives must otherwise be disconnected from the mains via the emergency off circuit, in this case automatically. The respective commissioning guidelines must be followed.

5. Cancelling the protective devices

The protective devices for the drive's defined danger zone can now be cancelled. Guard doors can, for example, be opened, locks and cutoffs for the danger zone can be cancelled.

3. Installation and Operating Guidelines

Once the protective devices have been cancelled, then the automatic emergency stop must be immediately activated if one of the following faults occur. All the drives connected to the central supply module are halted and hereby disconnected from the mains via the mains contactor:

- Activation of the starting lockout is not acknowledged. The acknowledgement contact (output ASQ-ASQ) remains open. The emergency off circuit must open because it is necessary for the external controller to definitely recognize this fault.
Possible causes: The controller signal does not arrive at input AS1-AS2 of the drive amplifier, or the internal starting lockout relay is defective.
- There is a fault in the acknowledgement line between output ASQ-ASQ and the external controller, which evaluates the acknowledgement via this acknowledgement contact. Or there is a fault in the controller itself.

6. Access ready:

Once all the preceding steps have been performed and checked, then all the drives in the disconnected working area have been secured against unwanted movement.

It is now possible for personnel to enter this zone and access the equipment.

3. Installation and Operating Guidelines

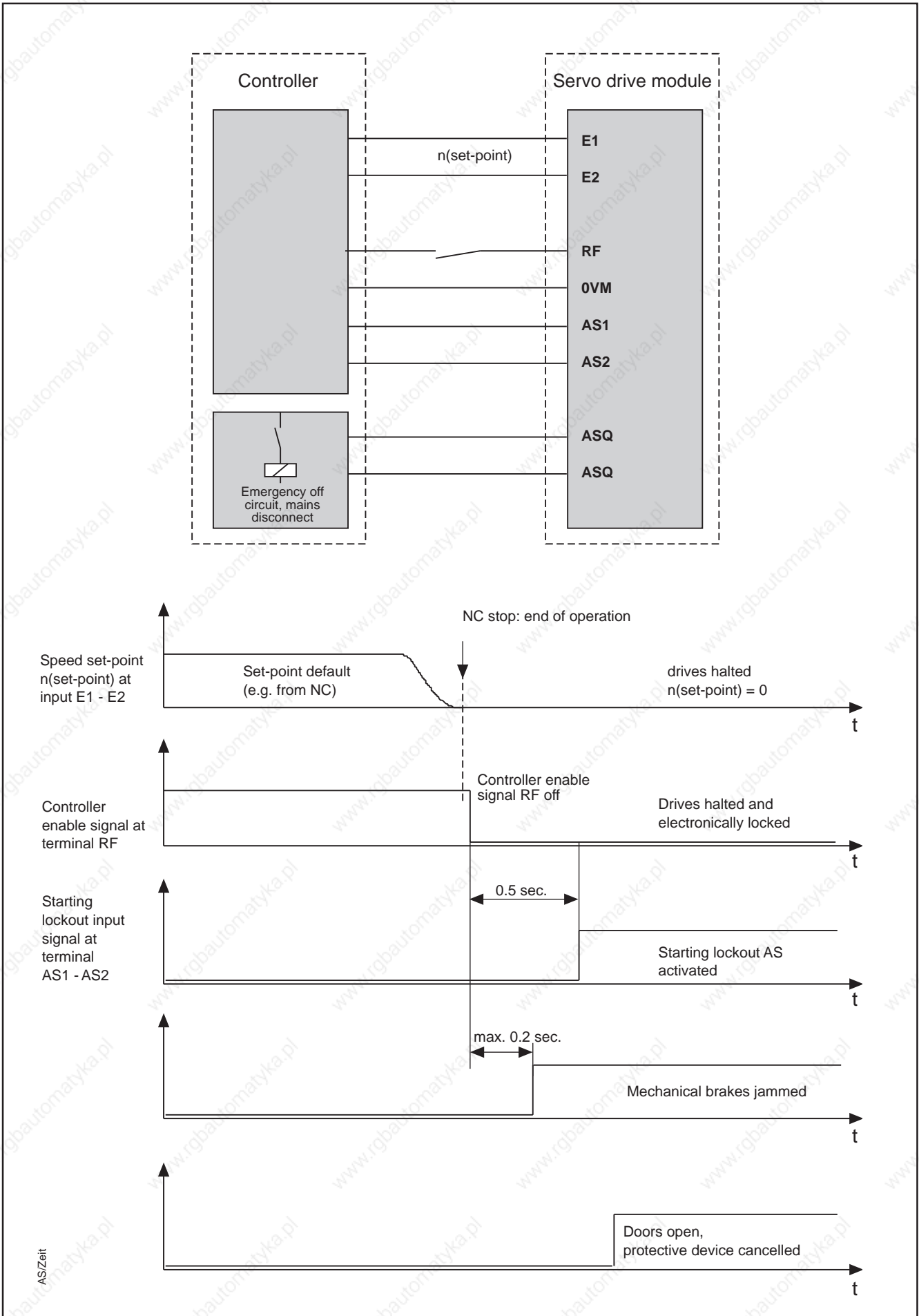

Figure 2: Chronological sequence when using the starting lockout

3.4. Test

The following tests should be performed on each drive in sequence after each initial commissioning and at set intervals during operation. No personnel should be within the danger zone during these tests.

1. Shutdown all drives.
2. The starting lockout is activated by supplying voltage to terminals AS1-AS2. Check whether the motor is now torque-free.
3. Cancel all protective devices, by opening the safety doors for example.
4. As a test, clamp off the line at input AS1.

In this case, the mains contactor must immediately disconnect the central supply module with its attached drives from the mains. This function is guaranteed by the control circuit foreseen in the design.

5. All possible faults which could occur should be simulated individually:
 - in the acknowledgement lines between input ASQ-ASQ and the external controller, and,
 - in the evaluation of this signal in this controller.

The following should be checked for each simulated fault: All drives running within the danger zone must be halted as quickly as possible, and the mains contact has to disconnect the central supply module with its attached drives from the mains.

In those cases where this does not happen when there is a fault, appropriate measures need to be taken to exclude these faults to the greatest possible extent, or trigger a sufficient emergency off release.

6. If it is possible to activate the starting lockout even with the drives running (for example, at the control panel), then it needs to be checked whether, by activating the starting lockout with running drives, a dangerous situation can develop if the drives run out torque-free in every operating state.

3.5. Application Examples

Figure 3 outlines two spatially separated working areas equipped with two or three drive axes.

Figure 4 demonstrates the controller circuit principle with minimum effort:

- Acknowledgement contact ASQ-ASQ has been, like the door contact, integrated into the control circuit for the emergency off sequence.
- Auxiliary contact K3 signals that the drives are ready to operate and ready for use.

3. Installation and Operating Guidelines

In accordance with VDE 0113/EN 60204, auxiliary contactor K4 is made up of a relay with multichannel design which assures that contact K4 will open even in the presence of a fault.

It is evident that the mains contactor drops off with a fault (=door contact and acknowledgement contact ASQ-ASQ open), and the drive package is disconnected from the mains.

The controller enable signal of the drive module and the set-point can hereby be simultaneously set to zero. The running drives will then brake and their energy will be fed into the d.c. voltage link circuit.

Additionally shown is the possibility of manual operations using the key and acknowledgement switches.

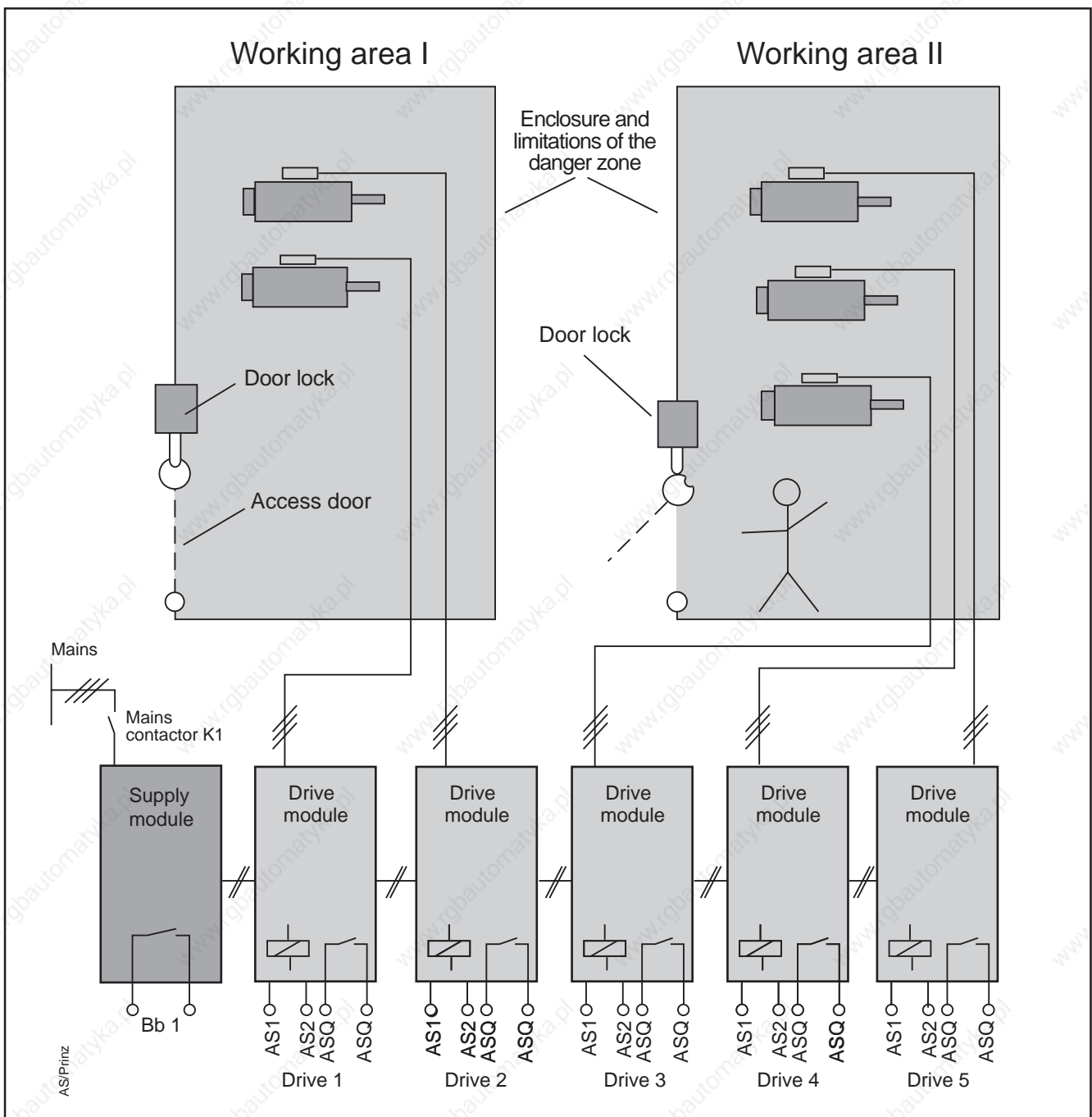

Figure 3: A sketch outlining the starting lockout applications using the example of separated working areas.

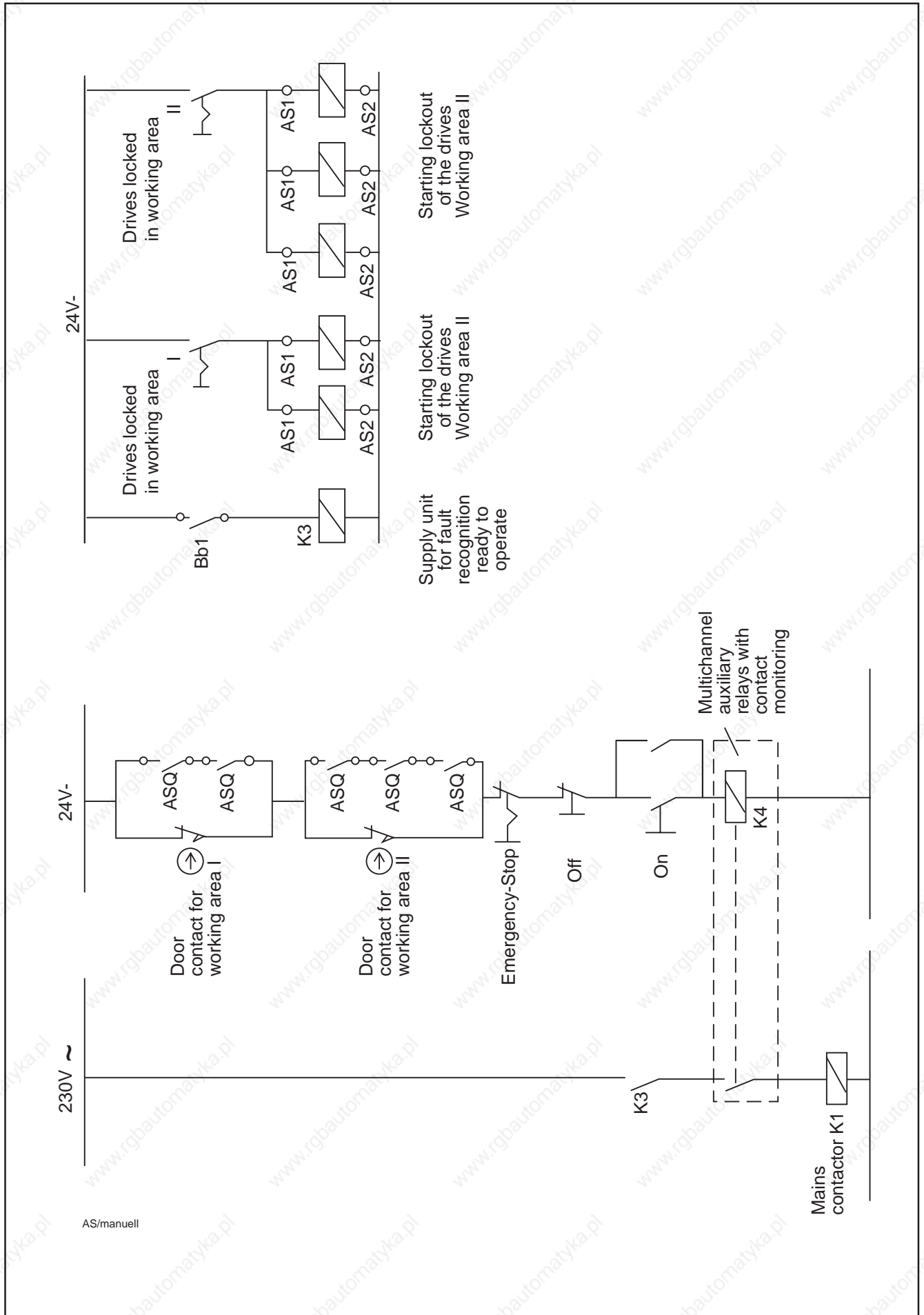

Figure 4: Examples of starting lockout applications: Controller circuitry of Fig. 3.

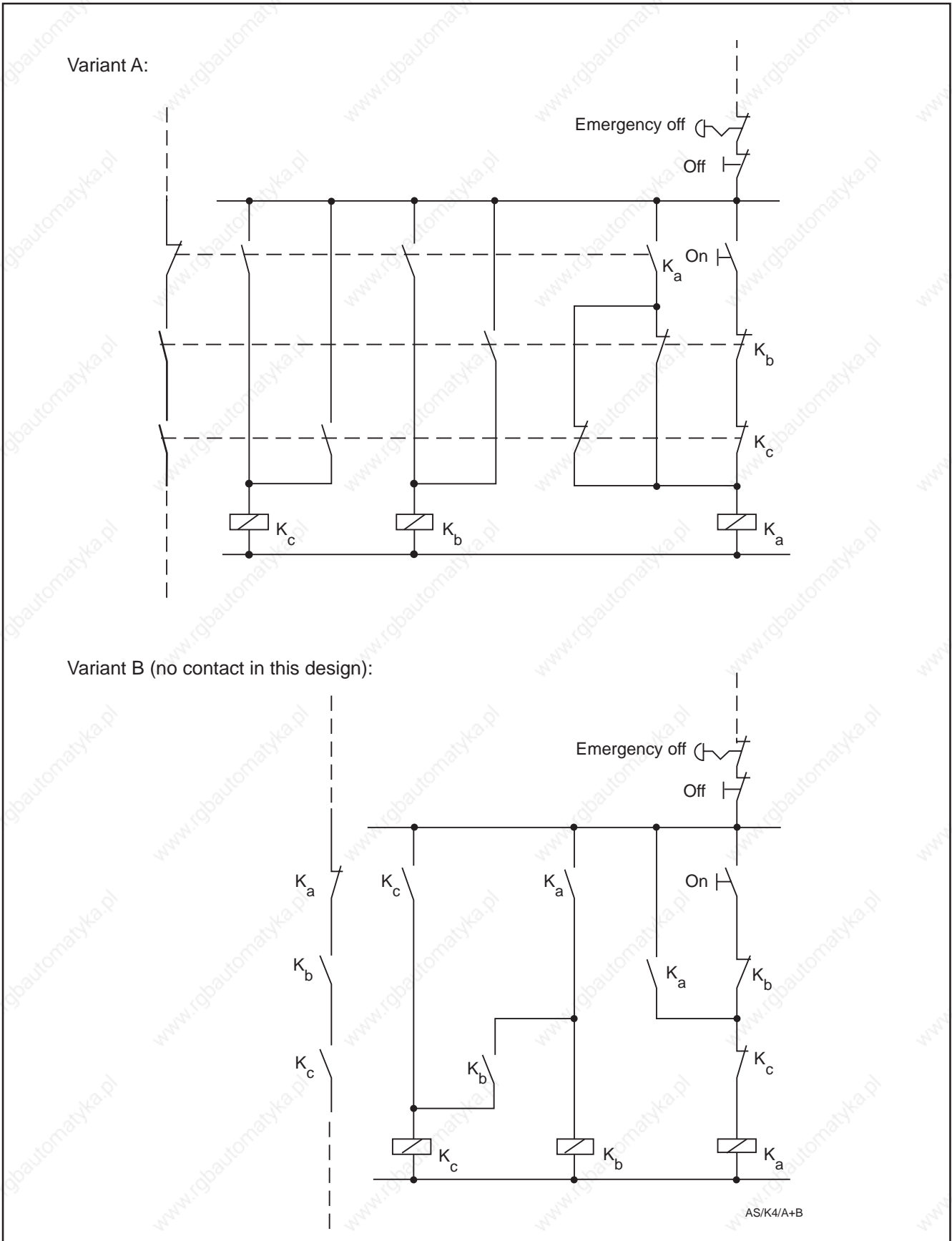

Figure 5: Examples of applications for the multichannel design of auxiliary relay K4 in Fig. 4.

4. Controller types and related plans

The following servo drive modules with starting lockout are available in addition to standard controllers (without starting lockout).

| Standard controller (without starting lockout) | Controller type with starting lockout |
|---|--|
| TDM 1 | TDM 1.3 (2) |
| TDM 3 | TDM 3.3(1) (2) |
| TDM 4 | TDM 4.3(1) (2) |
| ----- | TDM 6.1(1) |
| ----- | TDM 7.1(1) |

- (1) It is possible with these controllers to attach a motor thermostat contact and the controller for the blocking brake (see Chapter 3.2).
- (2) The additional plug-in terminal is plugged into the unit upon delivery and is, therefore, not a part of the connecting accessories E...-TDM. In other words, both the standard unit and the unit with starting lockout have the same connecting accessories.

Related plans

| Plan | Servo drive module with starting lockout | Figures |
|---------------------|--|---------|
| Front view | TDM 1.3 | Fig. 6 |
| | TDM 3.3 | Fig. 7 |
| | TDM 4.3 | Fig. 8 |
| | TDM 6.1 | Fig. 9 |
| | TDM 7.1 | Fig. 10 |
| Dimension sheet | TDM 1.3 | Fig. 11 |
| | TDM 3.3 | Fig. 12 |
| | TDM 4.3 | Fig. 12 |
| | TDM 6.1 | Fig. 12 |
| | TDM 7.1 | Fig. 12 |
| Mounting dimensions | TDM 1.3 | Fig. 13 |
| | TDM 3.3 | Fig. 14 |
| | TDM 4.3 | Fig. 14 |
| | TDM 6.1 | Fig. 14 |
| | TDM 7.1 | Fig. 14 |
| Fan dimensions for | TDM 3.3 | Fig. 15 |
| | TDM 4.3 | Fig. 15 |
| | TDM 6.1 | Fig. 15 |
| | TDM 7.1 | Fig. 15 |
| Connection plan | TDM 1.3 | Fig. 16 |
| | TDM 3.3 | Fig. 17 |
| | TDM 4.3 | Fig. 18 |
| | TDM 6.1 | Fig. 19 |
| | TDM 7.1 | Fig. 20 |

4. Controller types and related plans

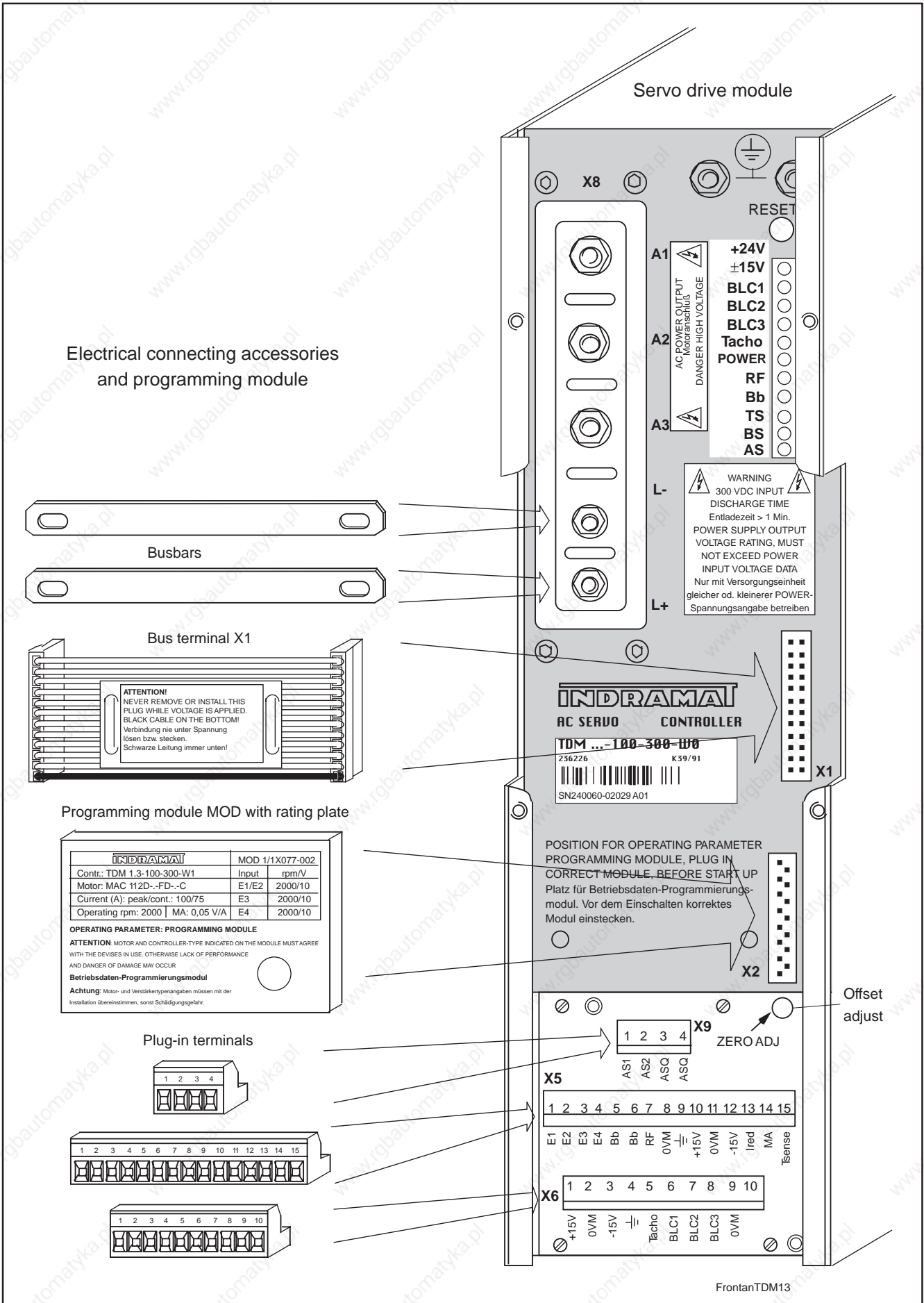

Figure 6: Front view of TDM 1.3

4. Controller types and related plans

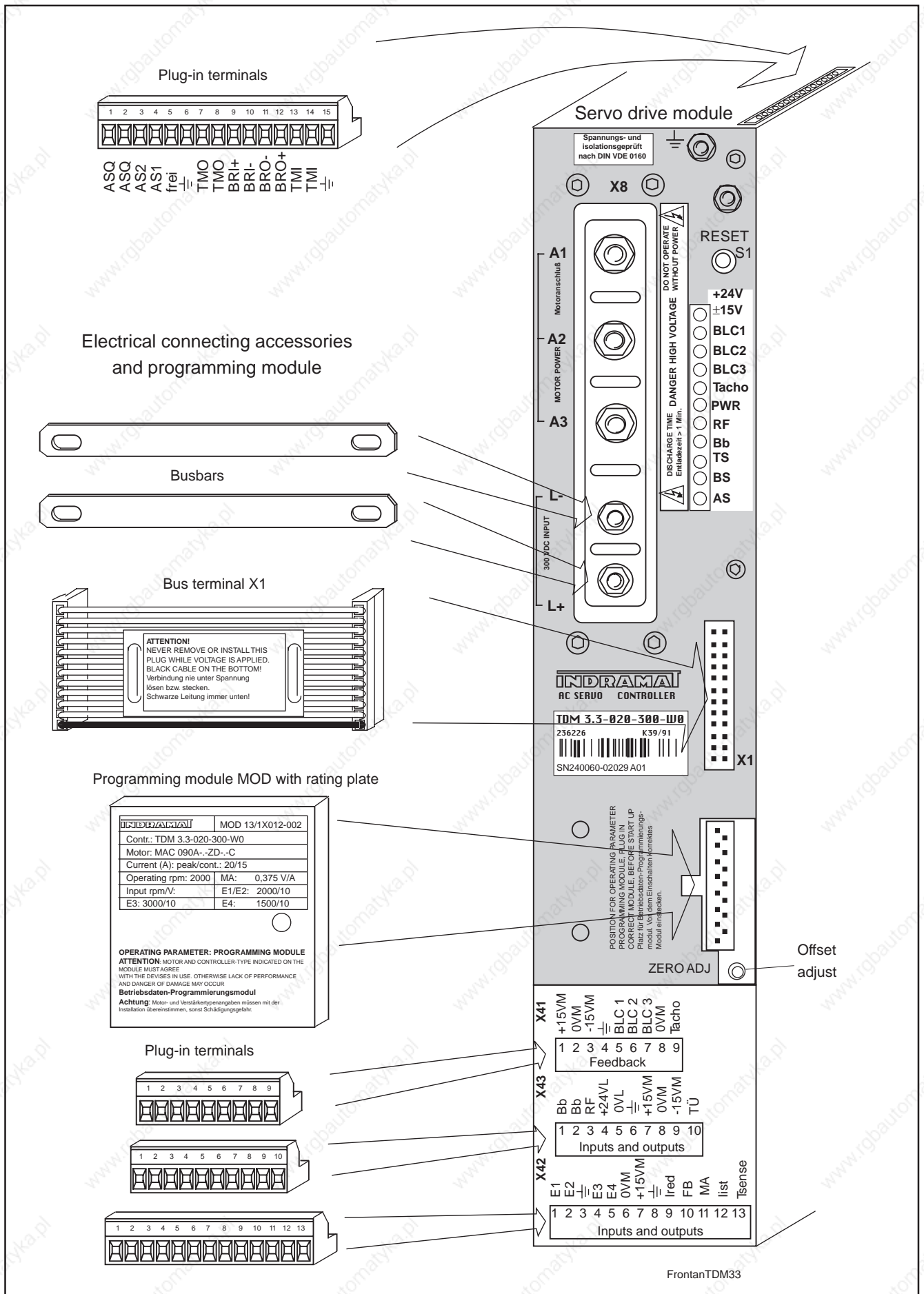

Figure 7: Front view of TDM 3.3

4. Controller types and related plans

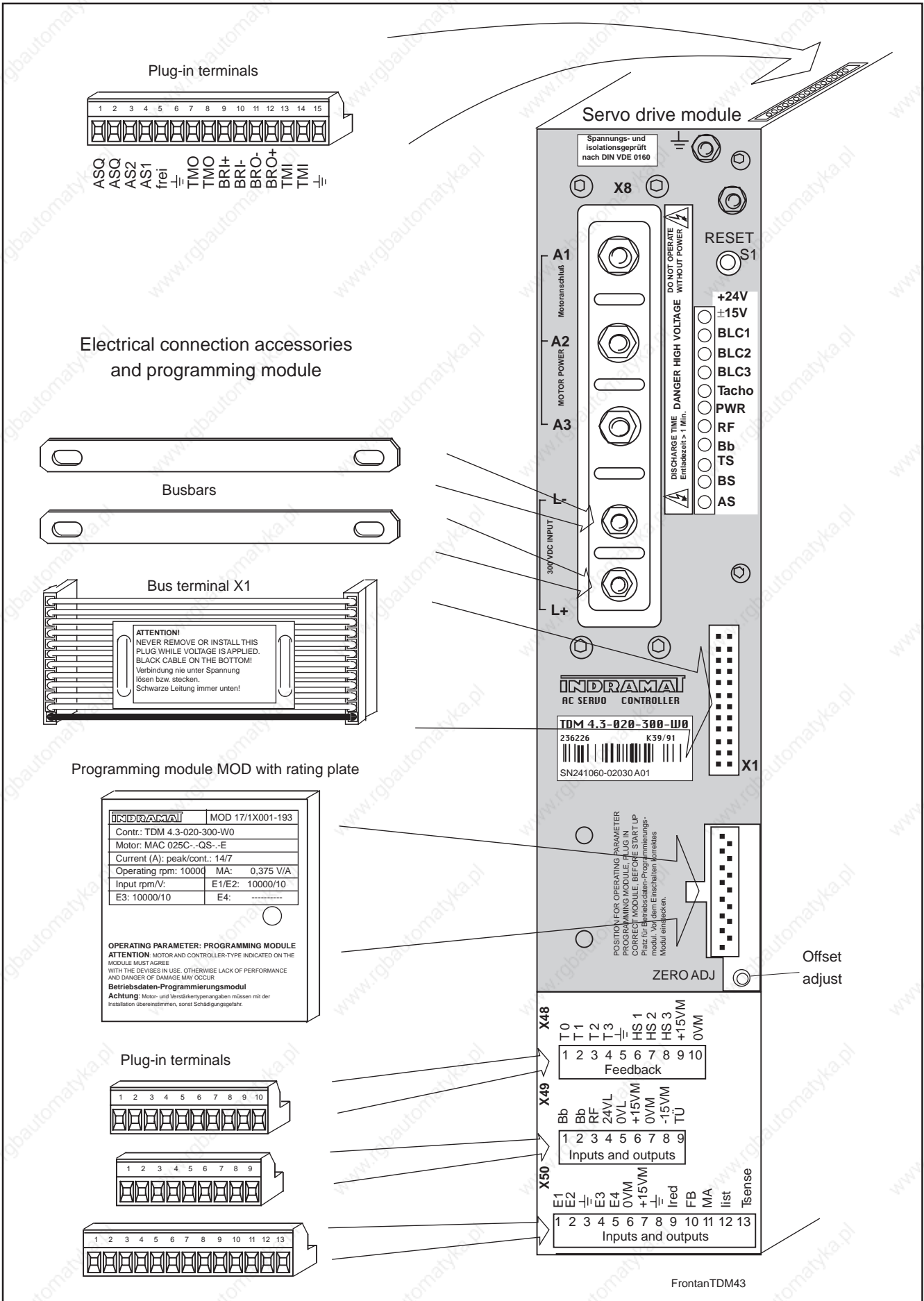

Figure 8: Front view of TDM 4.3

4. Controller types and related plans

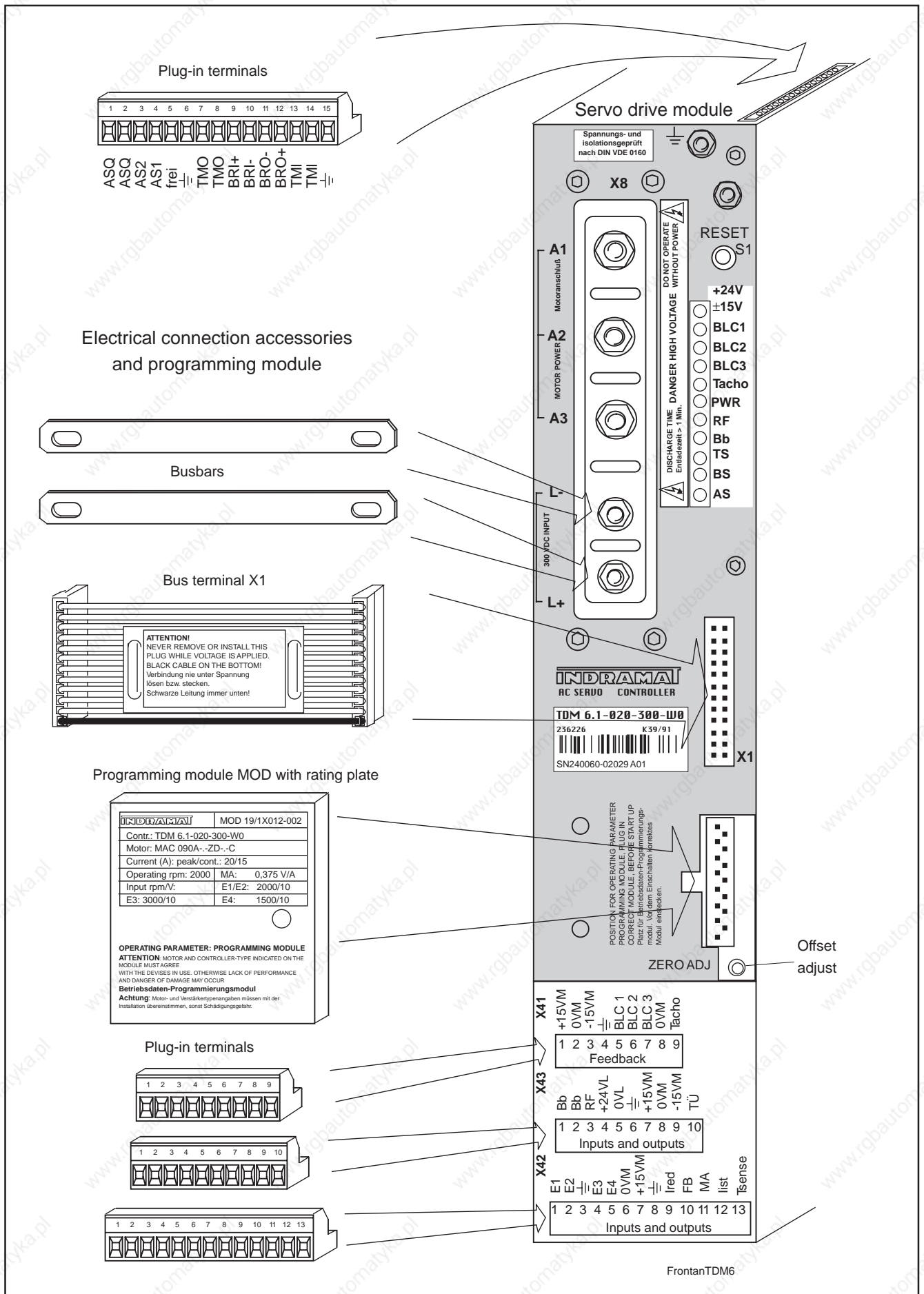

Figure 9: Front view of TDM 6.1

4. Controller types and related plans

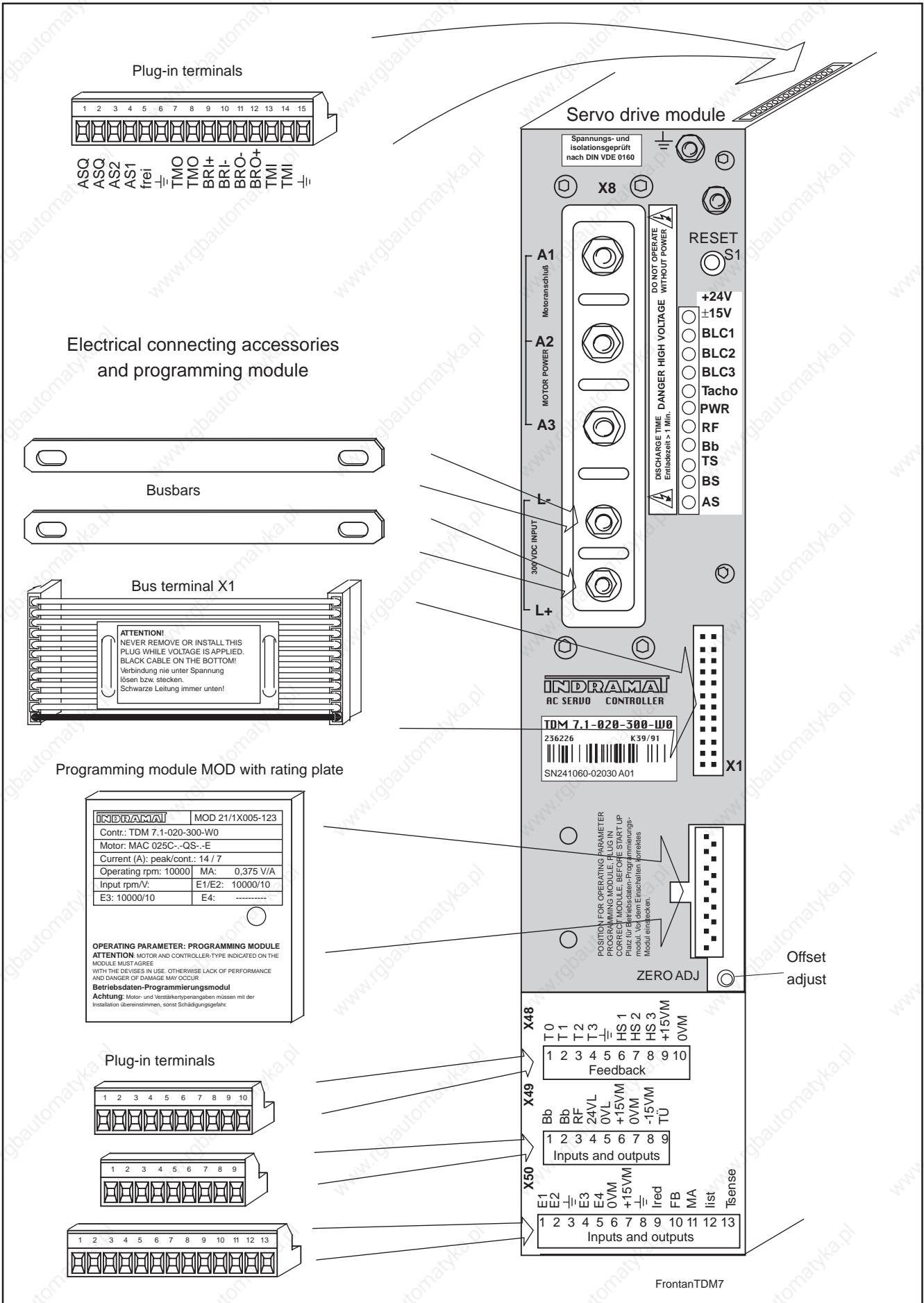

Figure 10: Front view of TDM 7.1

4. Controller types and related plans

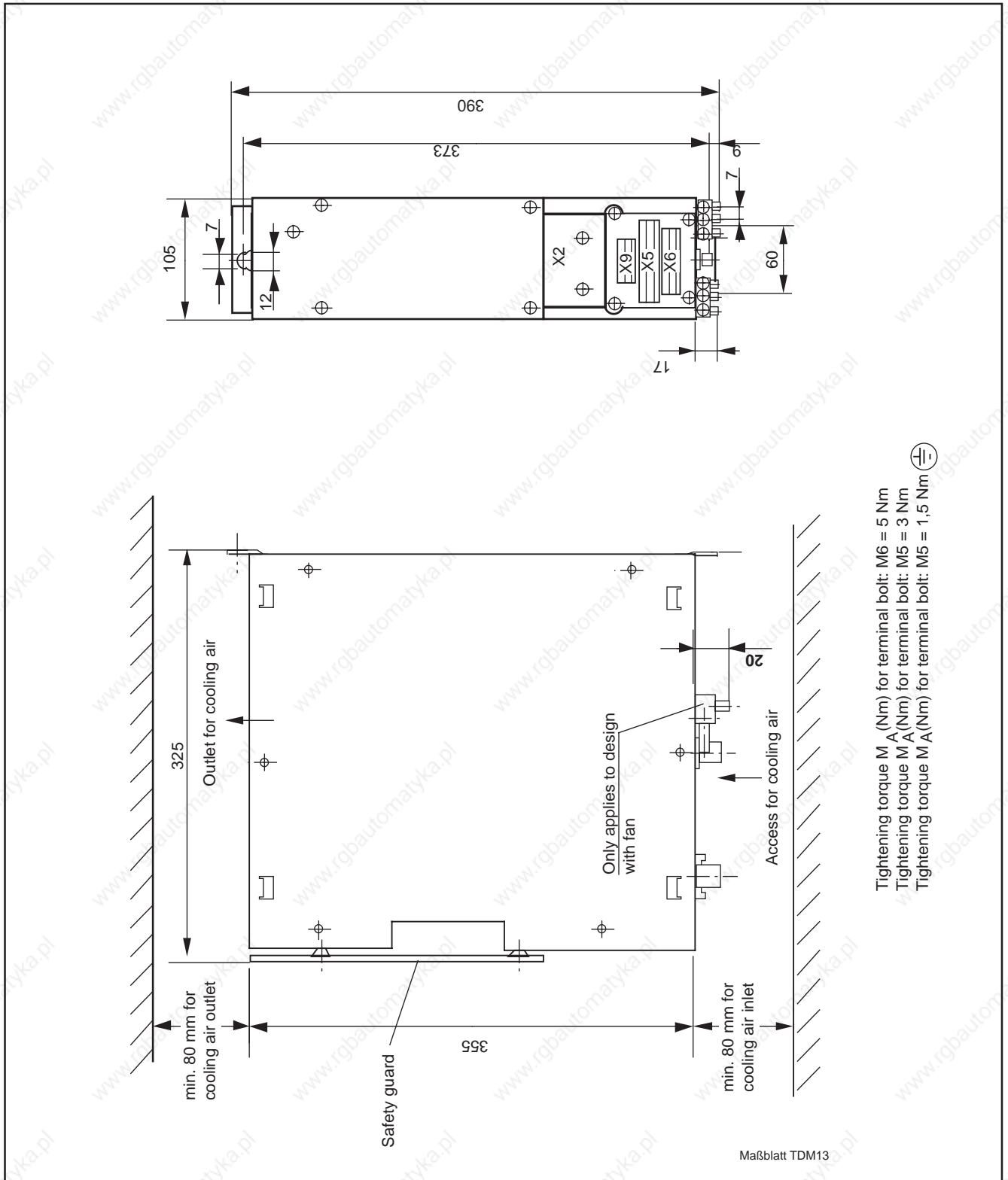

Figure 11: Dimension sheet for TDM 1.3

4. Controller types and related plans

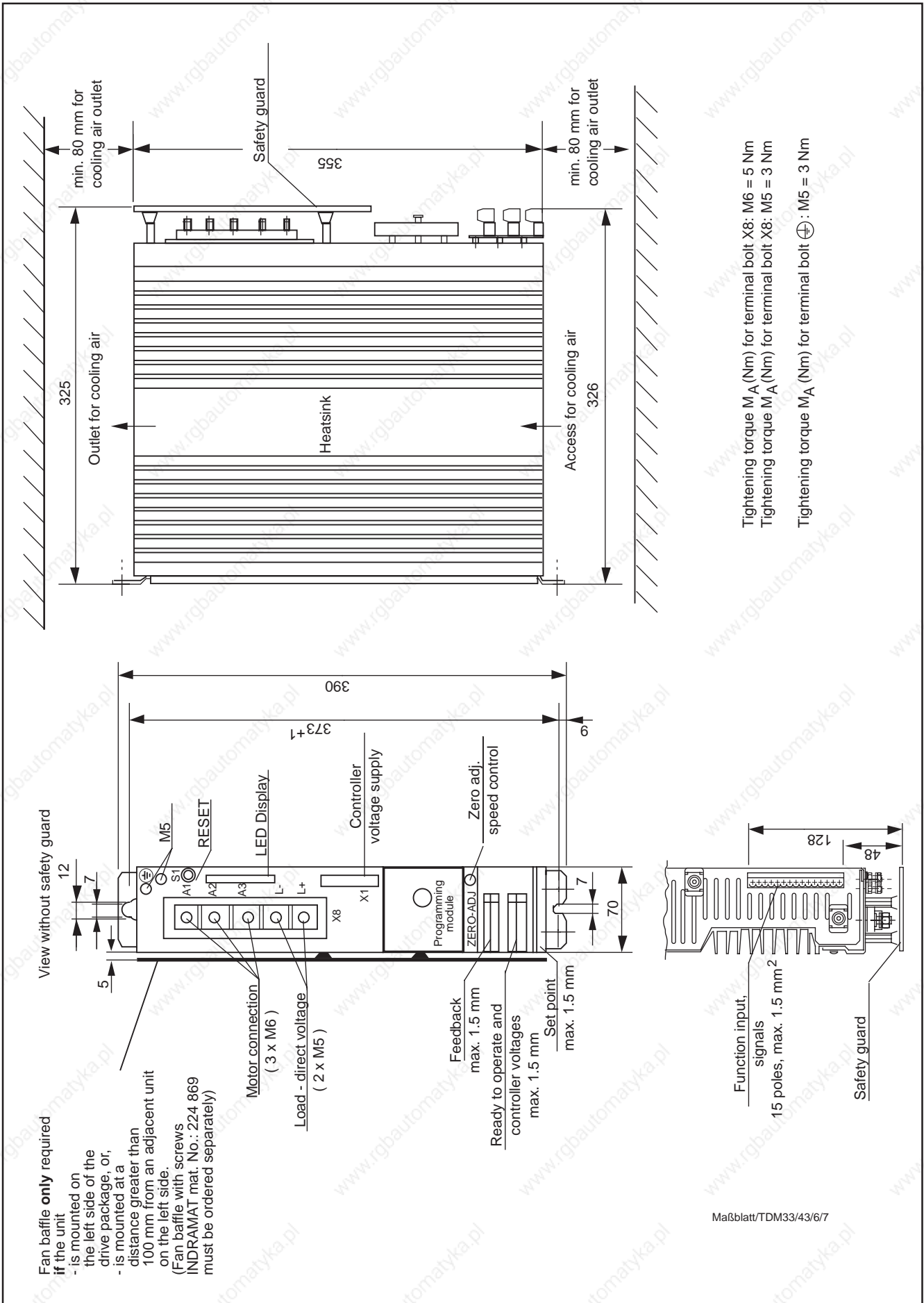

Figure 12: Dimension sheets for TDM 3.3, TDM 4.3, TDM 6.1 and TDM 7.1

4. Controller types and related plans

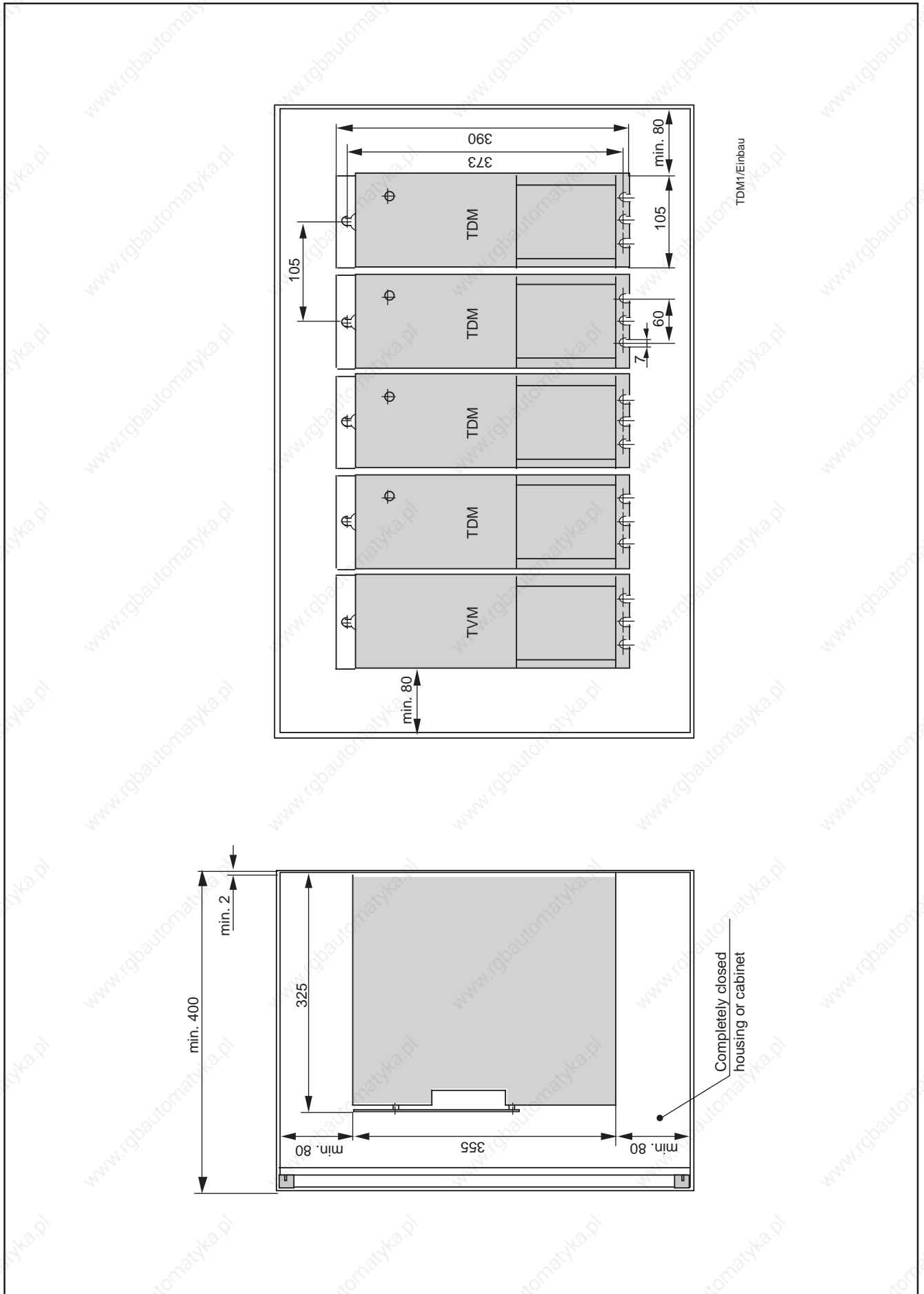

Figure 13: Mounting dimensions for TDM 1.3

4. Controller types and related plans

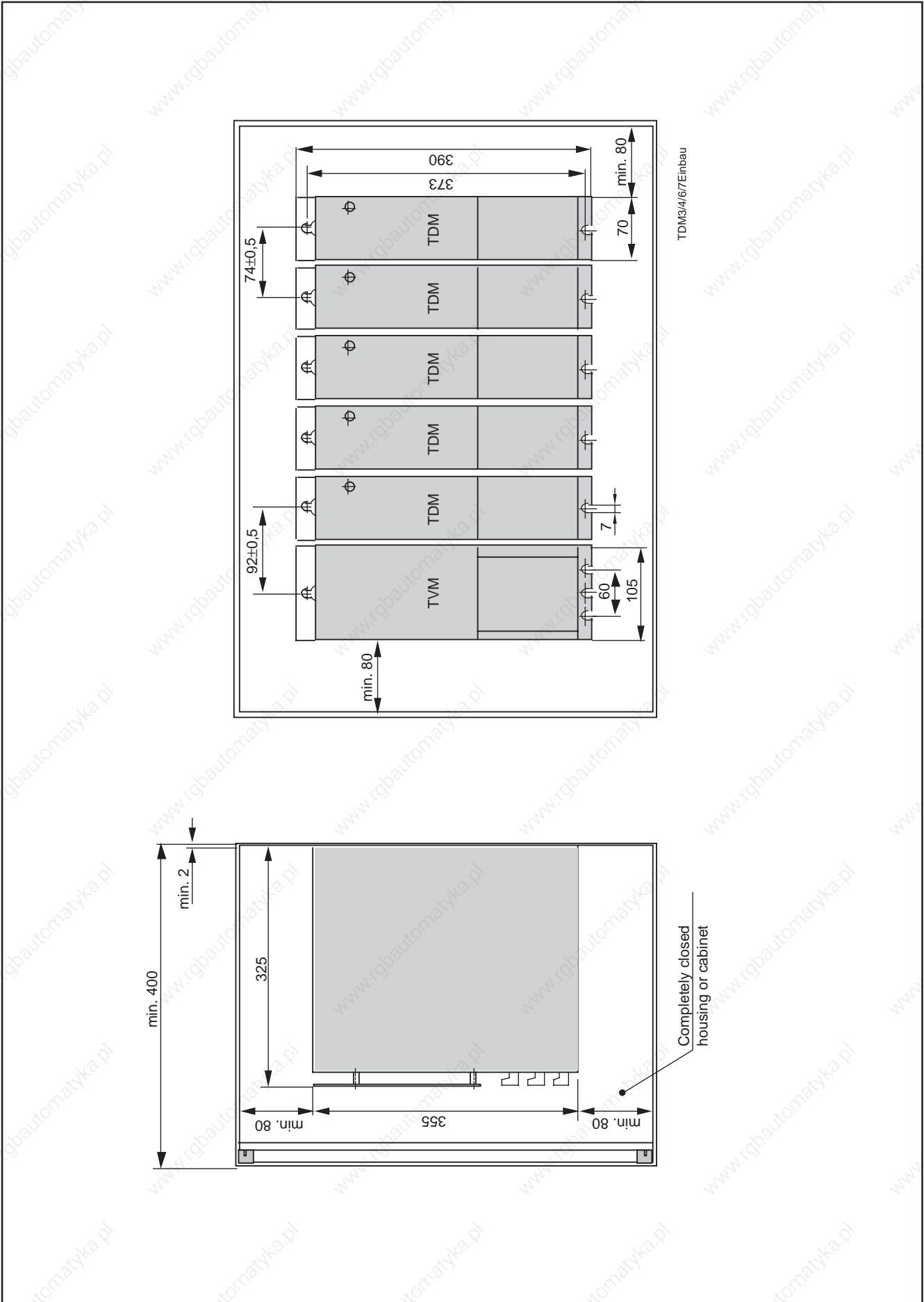

Figure 14: Mounting dimensions for TDM 3.3, TDM 4.3, TDM 6.1 and TDM 7.1

4. Controller types and related plans

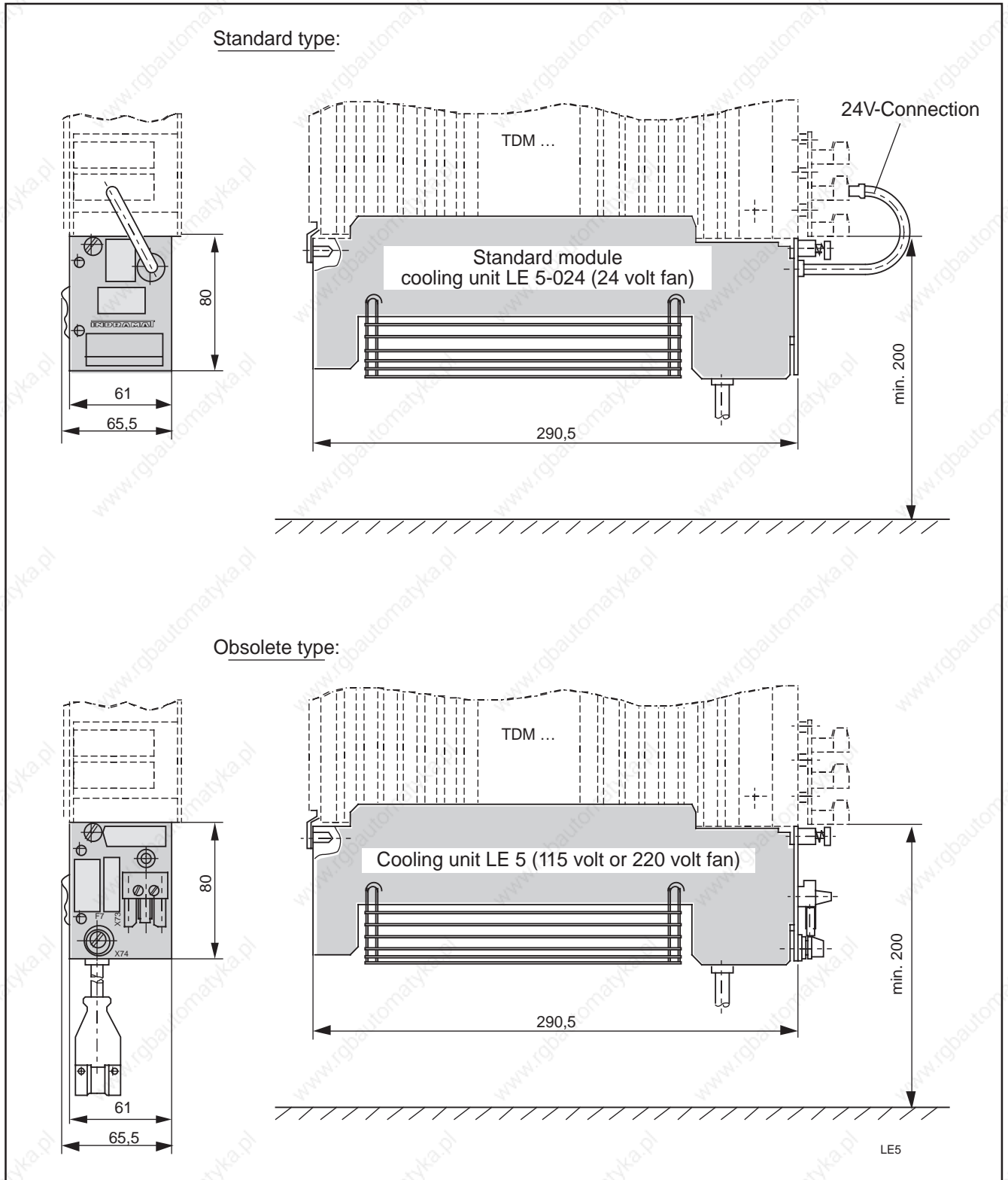

Figure 15: Fan dimensions for TDM 3.3, TDM 4.3, TDM 6.1 and TDM 7.1

4. Controller types and related plans

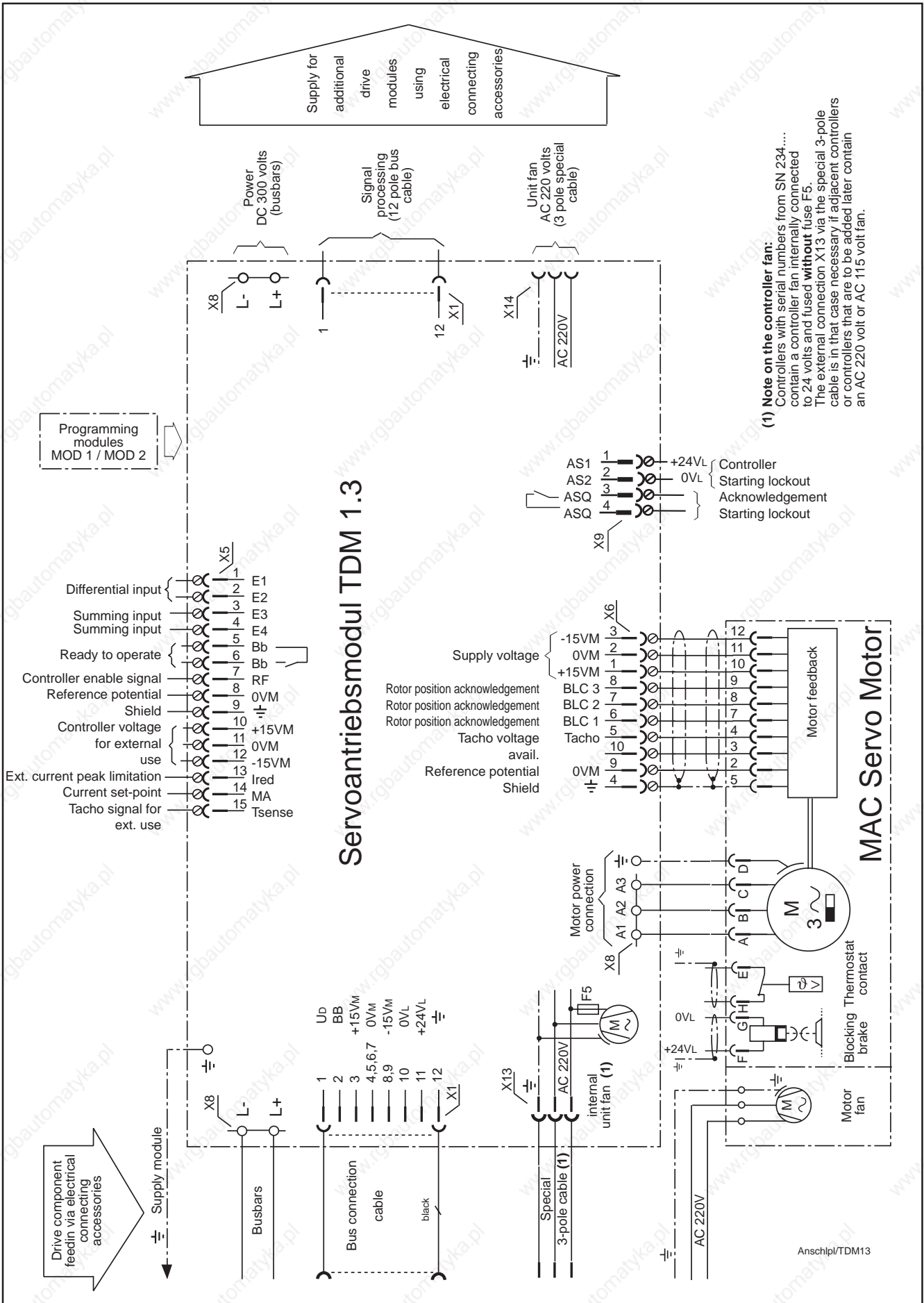

Figure 16: Connection plan for TDM 1.3

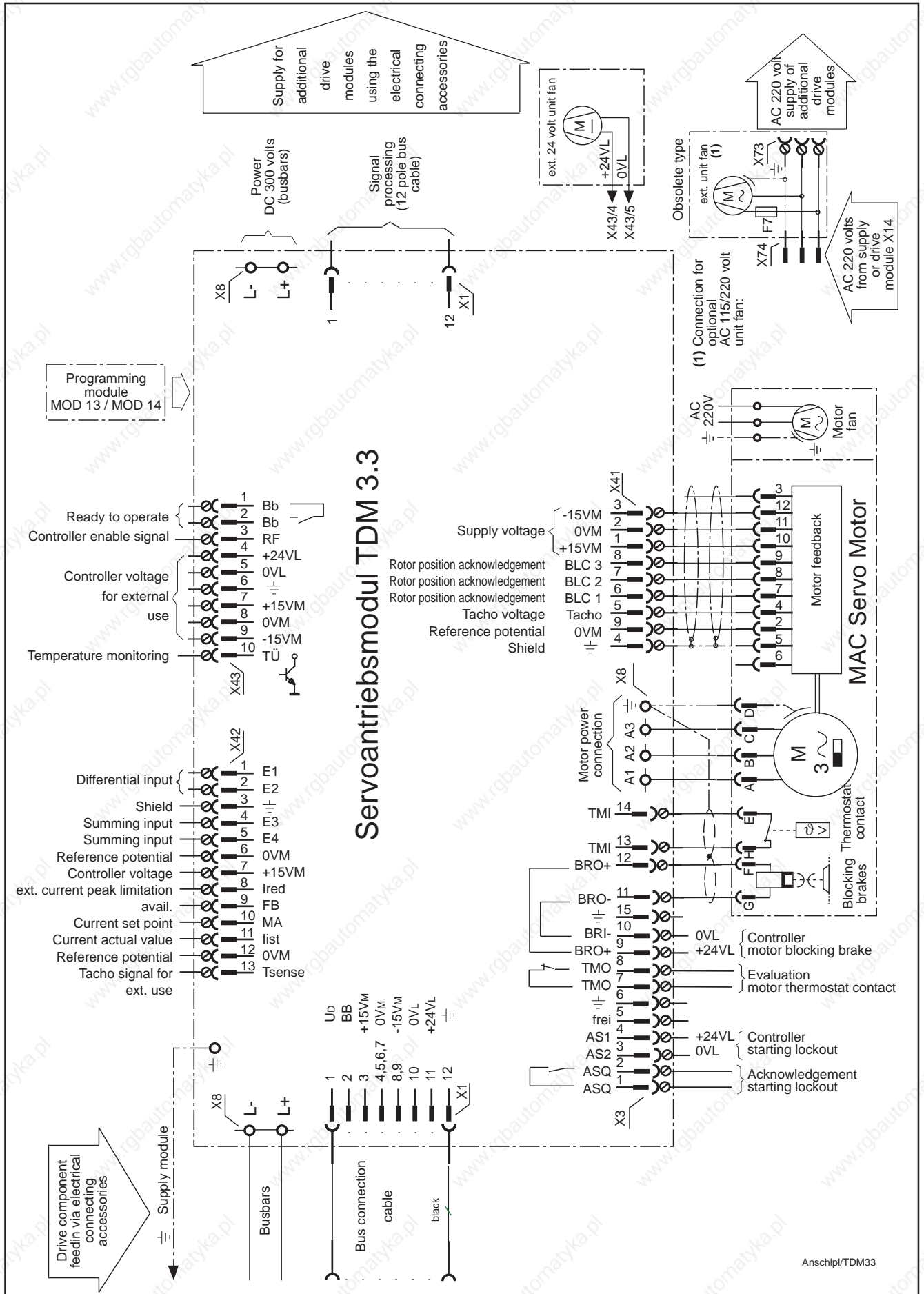

Figure 17: Connection plan for TDM 3.3

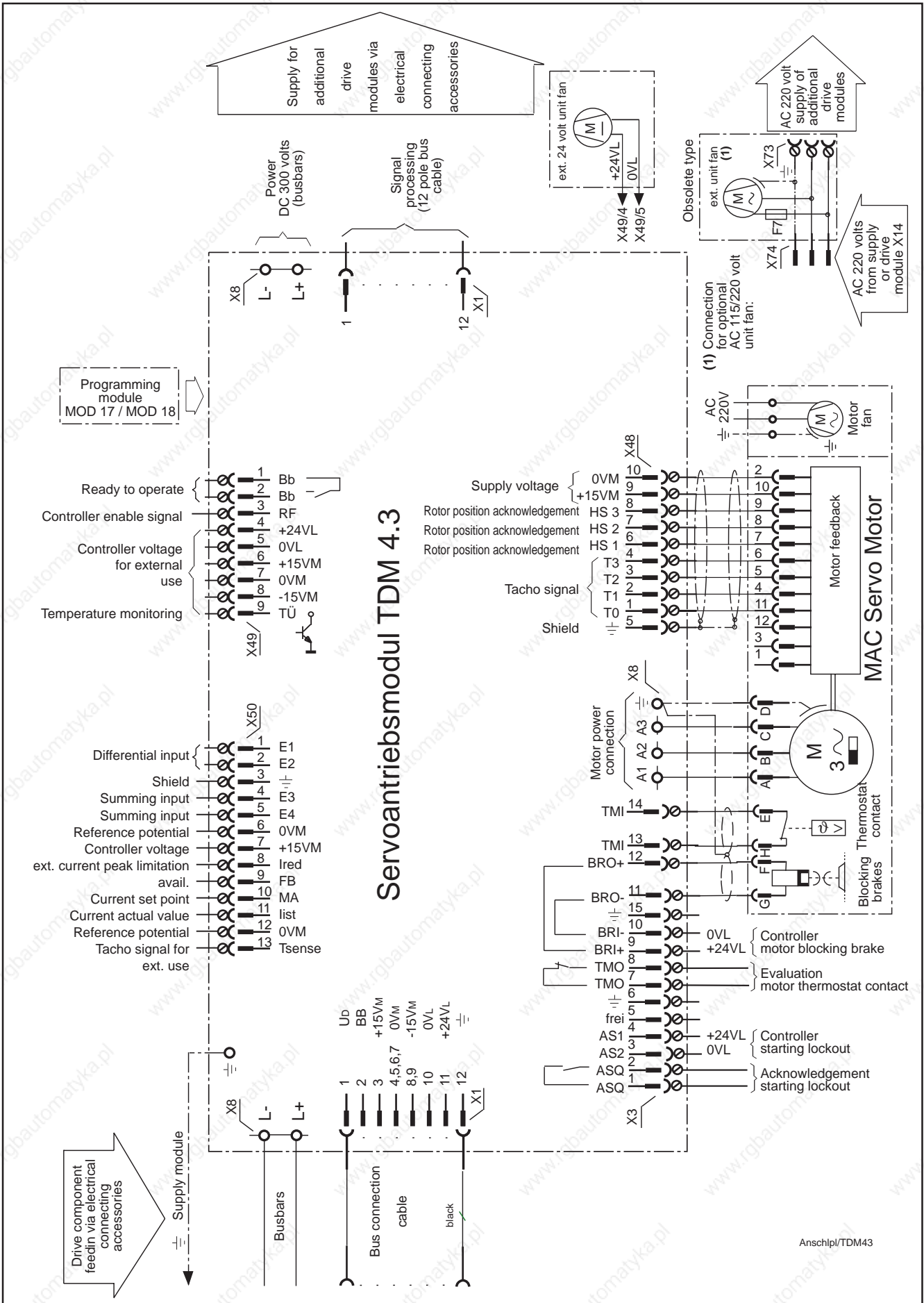

Figure 18: Connection plan for TDM 4.3

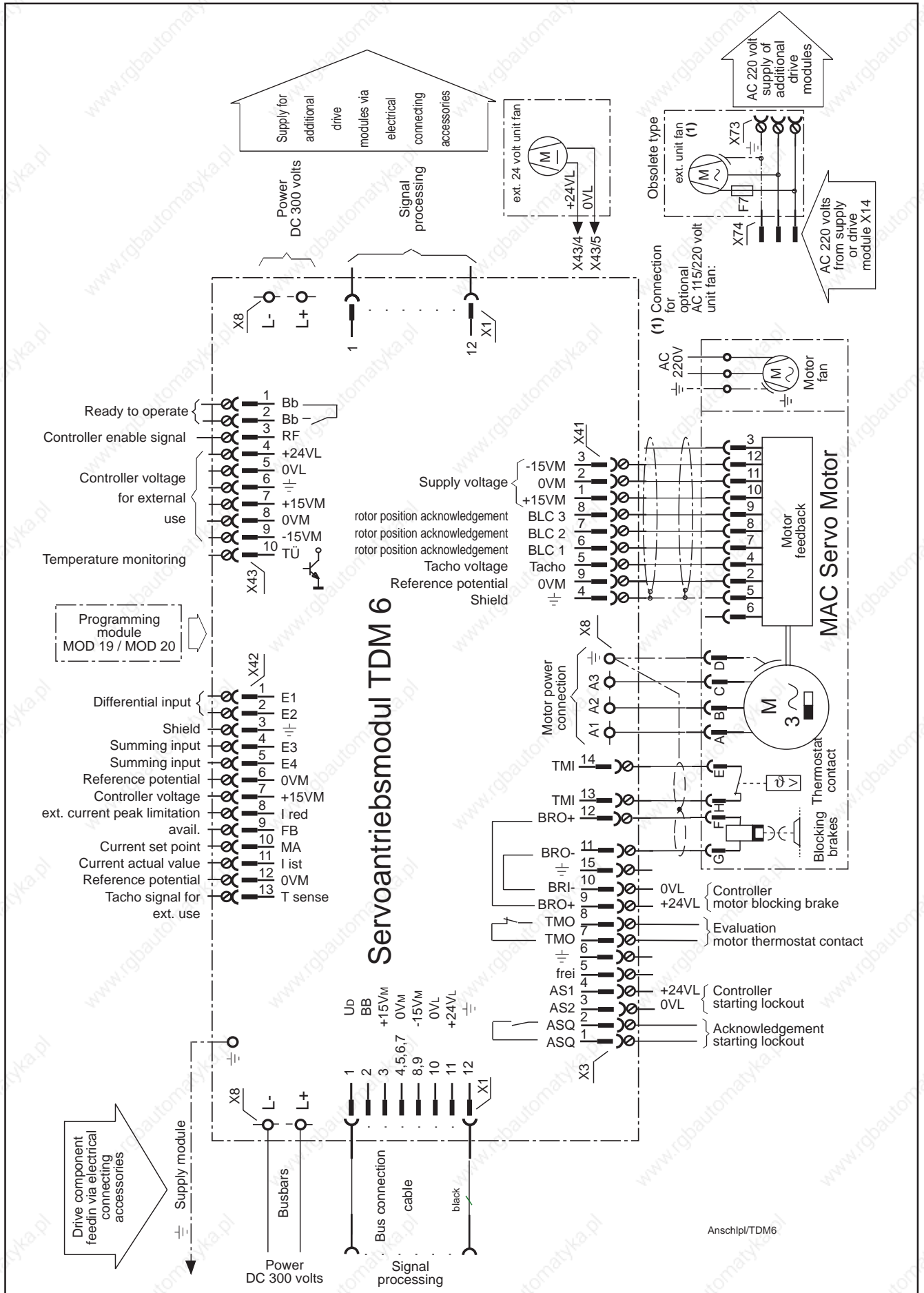

Figure 19: Connection plan for TDM 6.1

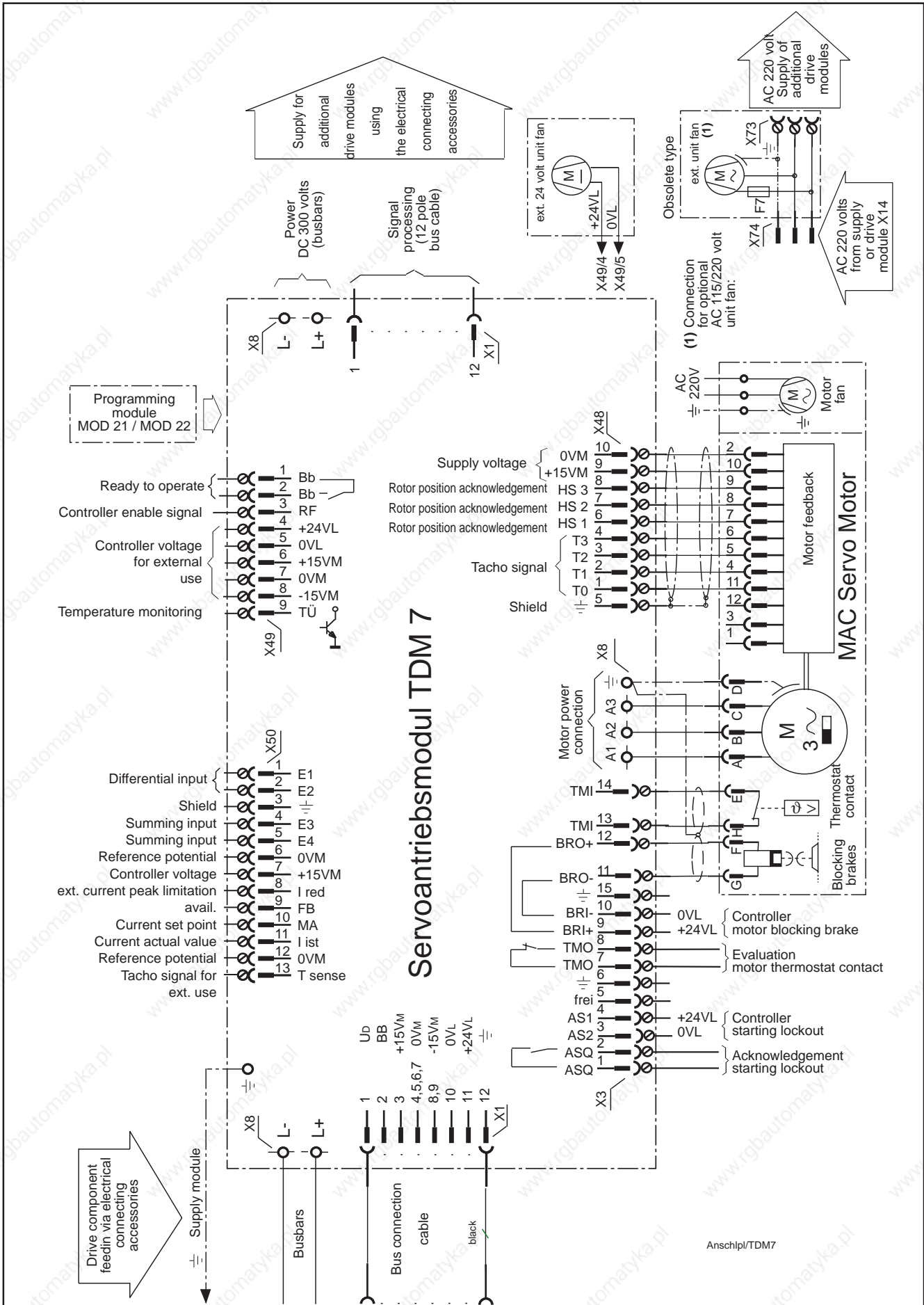

Figure 20: Connection plan for TDM 7.1

