

SIEMENS



DESIGO™ S7 **Touch Panel S7 TP177** **Operating instructions**

Contents

1	About this document	3
1.1	Revision history	3
1.2	Further documents	3
1.3	Before you start	3
1.3.1	Trademarks	3
1.3.2	Copyright	4
1.3.3	Quality assurance	4
1.3.4	Document use/ request to the reader	4
1.4	Target audience	5
1.5	Document conventions	5
2	Connect the S7 TP177	6
2.1	Power	6
2.2	Data connection	6
2.3	Switch on	7
2.4	Commissioning	7
3	Operate the S7 TP177	8
3.1	Operating elements and display	8
3.2	Menu	9
3.3	General system buttons	10
3.4	Enter login	11
3.5	Enter values	12
3.6	Limit value check for entries	14
3.7	Alarm handling	14
4	System functions	15
4.1	Start window	15
4.2	Date window	16
4.3	License window	16
4.4	Configuration	17
4.5	System	19
4.6	Language (menu)	20
4.7	Password and user administration	21
4.8	Plant overview window	23
4.9	Partial plant overview window	24
4.10	Block overview window	25
5	TP 177 error messages	26
6	Install DESIGO S7 firmware	27
6.1	Setup contents	27
6.2	Set up on your development machine	28
6.3	Load WinCCflexible project	28
6.4	Install DESIGO S7 firmware / upgrade TP 177B	29

1 About this document

1.1 Revision history

Version	Date	Changes	Section	Pages
_02	March 2012	Password security	4.7	22
_01	July.2009	First edition		

1.2 Further documents

Ref.	Document title	Document type	Document number
[1]	Standard device manual "Operator units TP177A, TP177B, OP177B (WinCC flexible)"	Device manual	6AV6991-1DG01-0AA0 (Siemens AI)
[2]	S7 Touch Panel TP177 6FLTPDS7-V1	Data sheet	CM1N9290

1.3 Before you start

1.3.1 Trademarks

The table below lists the third-party trademarks used in this document and their legal owners. The use of trademarks is subject to international and domestic provisions of the law.

Trademarks	Legal owner
Microsoft ...	Microsoft Corporation; see http://www.microsoft.com/TRADEMARKS/mark/nopermit.htm
Windows	Microsoft Corporation

All product names listed in the table are registered (®) or not registered (™) trademarks of the owner listed in the table. We forgo the labeling (e.g. using the symbols ® and ™) of trademarks for the purposes of legibility based on the reference in this section.

1.3.2 Copyright

This document may be duplicated and distributed only with the express permission of Siemens, and may be passed on only to authorized persons or companies with the required technical knowledge.

1.3.3 Quality assurance

These documents were prepared with great care.

- The contents of all documents are checked at regular intervals.
- All necessary corrections are included in subsequent versions.
- Documents are automatically amended as a consequence of modifications and corrections to the products described.

Please make sure that you are aware of the latest document revision date.

If you find any lack of clarity while using this document, or if you have any criticisms or suggestions, please contact the product manager in your nearest branch office.

Addresses for the Siemens Regional Companies are available at

www.buildingtechnologies.siemens.com.

1.3.4 Document use/ request to the reader

Before using our products, it is important that you read the documents supplied with or ordered at the same time as the products (equipment, applications, tools etc.) carefully and in full.

We assume that persons using our products and documents are authorized and properly trained and have the requisite technical knowledge to use our products as intended.

Additional information on products and applications is available:

- On the intranet (for Siemens employees only) at <https://workspace.sbt.siemens.com/content/00001123/default.aspx>
- At your next Siemens office www.buildingtechnologies.siemens.com or system supplier
- From the support team in the headquarters fieldsupport-zug.ch.sbt@siemens.com if no local POC is available.

Siemens assumes no liability to the extent allowed under the law for any losses resulting from a failure to comply with the aforementioned points or for the improper compliance of the same.

1.4 Target audience

This user's guide targets **plant users** and technical **service staff**. We assume that you have the required system and plant knowledge.

The following descriptions relate to commissioning, basic settings and use of S7 TP177.

A general description is not possible as individual plants and objects may differ greatly. During engineering, the objects and values to be integrated in the plant are determined in accordance to individual plant operator needs.

The following description are intended merely as examples explaining basic functions of the touch panel.

1.5 Document conventions

Display texts:

Texts in **bold print** appear as is on the display, e.g. **Config** or **System**.

2 Connect the S7 TP177

2.1 Power

Power supply: DC 24 V (between DC 18...30 V, protection against voltage reversal).

Power consumption:0.5 A.

2.2 Data connection

TP application range
(MPI/DP/TCP_IP)

The S7 TP177 can be connected to an MPI/DP network (CPU interface) as well as a TCP/IP network (Ethernet CP, CPU interface (PN)).

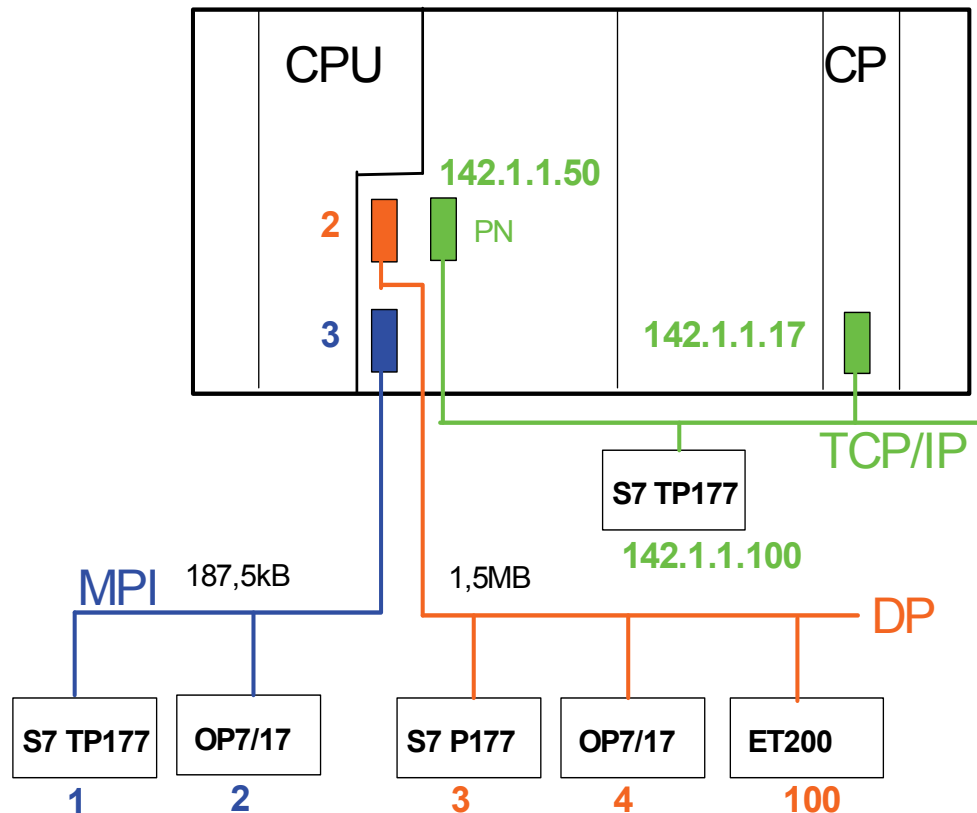

Default setting
(own address)

MPI	1
Baud rate	187.5 kbps
Highest station address	31
Transfer settings	ETHERNET
IP address	142.1.1.110
Subnet mask	255.255.0.0

When connected to a DP network, the S7 TP177's own DP address must be set via CONTROL PANEL→S7-Transfer Settings→MPI, rather than CONTROL PANEL→S7-Transfer Settings→DP.

Opening a connection automatically adjusts the baud rate.

2.3 Switch on

After switching on the S7 TP177, the DESIGO S7 start screen opens after a few seconds.

Touching **Exit** closes the start screen (and opens the Control Panel); touching **Start** reopens the start screen.

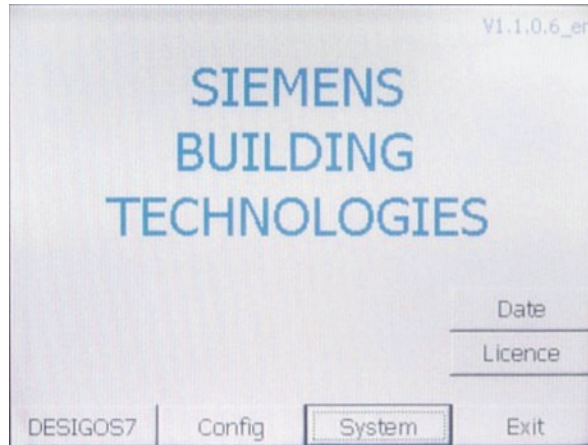

2.4 Commissioning

You must first parameterize the configuration mask to commission the S7 TP177. (Config menu, see 4.4)

Restart the device after each change to the AS software (Exit button or REBOTT in the Control Panel via commands OP > DEVICE > REBOOT).

Update and reaction times for touching depend on the CPU (faster with a CPU400 than a CPU300).

3 Operate the S7 TP177

3.1 Operating elements and display



- 1 Connection (terminals) to power (DC 24 V, 0.5 A).
- 2 Communications interface (RJ45).
- 3 Display.
- 4 MPI/DP connection.

3.2 Menu

Start window "DESIGO S7" (4.1)	Date window (4.2) (ADMIN only)	Time of day Date	Drop-down list box Drop-down list box			
		Home OK.	Return to Start window. Apply entry.			
	License window (4.3) (Admin only)	MM-ID / serial no. License string. Dispatch note no.	Complete with numeric keyboard (3.5). Complete with numeric keyboard (3.5). → License = SIMATIC CPU runtime protection license.			
	DESIGO S7 (4.8)	Plant, (4.8) e.g. "AHU 10" (scroll if plant has too many rows).	Partial plant (4.9), e.g. "Extract Air Fan" (scroll if partial plant has too many rows).	Data points (4.10), e.g. "Command".	Data point properties Examples: <ul style="list-style-type: none"> Alarm (disturbance) (5). Field in blue font. Locked field (gray). Text entry field. Numeric entry field. Selection entry field. 	<ul style="list-style-type: none"> "!!!" Designates faulty elements (with alarm). Value display; field cannot be edited. Login required (3.4); after using logout. Letter keyboard appears after touching (3.4). Numeric keyboard appears after touching (3.5). Dropdown list box appears (3.5).
	System (4.5)	Calibrate touch. System control. Contrast + / –	Touch crosses To Control Panel 0...100 in 10% increments			
		Home Reserve OK	Return to Start window. Reserve, no function. Confirm entry.			
	Config (4.4)	Communications Language User	Configure DE / EN / FR (system language) Manage passwords.		→ You can also query the firmware version in the "Language" window.	
		Home OK	Return to Start window . Apply entry.			
	Exit	Return to Control Panel (Windows CE level)				
Control Panel	Restart the S7 TP177 from here among other functions.					

The functions are described in detail in the following sections (refer to the section numbers in brackets).

3.3 General system buttons

OK.	Confirm and finish entry (numeric or selection).
ESC	The ESC button offers the following functions: <ul style="list-style-type: none">• Undo. Undoes field entries provided they have not yet been confirmed with OK. (Password entry and numeric entry).• Go back one level.
Scroll vertically	Scroll if the display is larger than the window.

3.4 Enter login

Enter login

The login dialog box opens when you touch **Config** in the Start window or **Log on** in the DESIGO S7 windows:

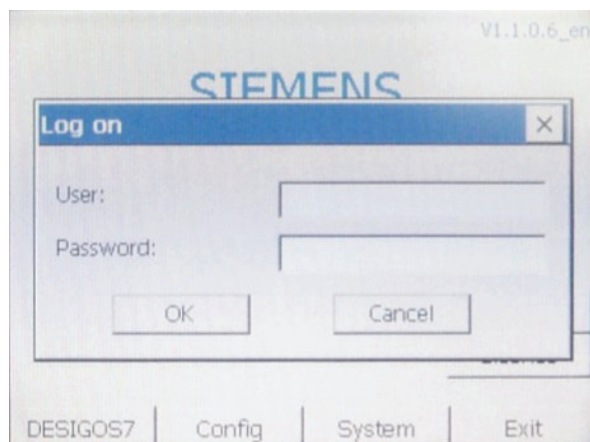

The following keyboard is displayed when you touch the **User** or **Password** entry fields:

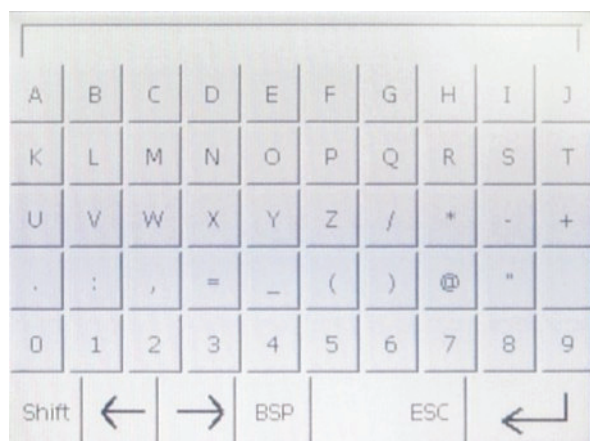

Enter user and password and apply using the bottom right arrow.
Touch **OK** to confirm the Login dialog box.

Correct your entry using the **BSP** button.
ESC allows you to return to the Login dialog box without entering any data.

Note:
Login locked

If you attempt to log in using the wrong password three times in a row, login is locked (user no longer is authorized).

This is a system function. If the Administrator user (DES7/999) is moved to group "Unauthorized", a second administrator (ADMIN/2008) may be used to reauthorized the user (see Section.4.6, "Password and user administration").

3.5 Enter values

General

You must first log in to be able to operate values:
Log in either via **Config** in the Start window or **Login** in the DESIGO S7 windows ("Release OP" Yes / No).

Procedure

You can enter TP values or states for control in the entry fields.

Proceed as follows:

- Login via the **Login** button as needed.
- Enter the corresponding value. After field engineering, enter values as:
 - Numeric entry (via displayed keyboard).
 - Value entry by selection (via dropdown list box).
- Click **OK** to confirm your entry.
- Cancel wrong entries via **ESC** (numeric entries only). The original value is then reentered automatically in the field. Repeat your entry using the correct value and confirm with **OK**.

Examples:

No operation possible
(gray fields, gray font)

If you are not logged in, the entry field (SETPOINT) is grayed. Operation is not possible.

Log in first and enter your user name and password.

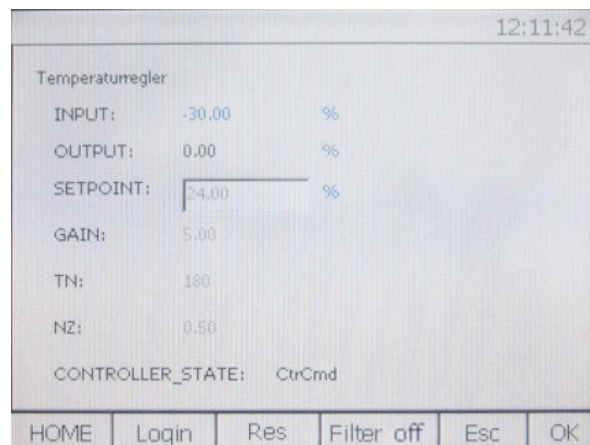

Operation possible

You are logged in, the **Login** button is now a **Logout** button. The entry field (SETPOINT) is brighter and can be operated.

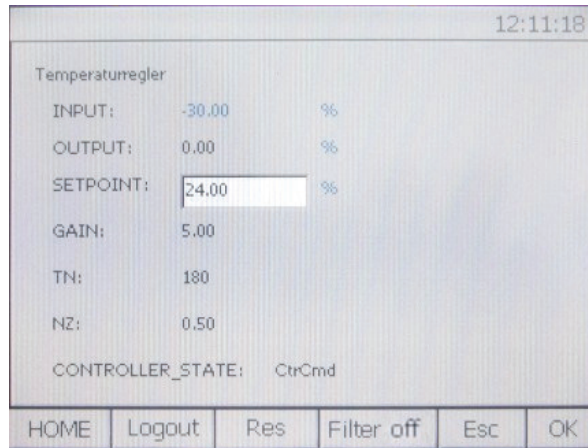

Enter numeric values (limits, setpoints, control parameters etc.)

When you touch a **numeric** entry field, e.g. upper limit of measured value (AI) ...

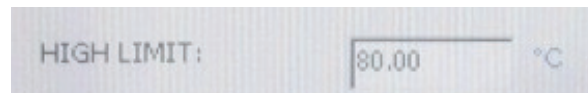

... the following keyboard opens.



Type in the value and apply using the bottom right arrow. Touch **OK** to confirm the entry.

Correct your entry using the **BSP** button.

ESC allows you to return to the data point dialog box without entering any data. **You must still confirm the window with OK.**

Enter selection values (desired stage, operating mode, ...)

When you touch a **symbol** entry field (arrow button right), a state text list opens: (Here **Manual operating mode**).

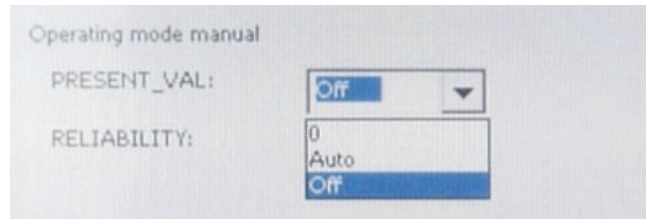

Select the desired text and confirm with **OK**.

When the state text list is open, **you must confirm the window with OK** even if you do not select a text.

3.6 Limit value check for entries

Numeric entry fields

Limit values can be set for numeric entry fields.

The entered values are applied only if they are within the set limits. The value in the field remains unchanged if you enter an illegal value.

If operating privileges are set, the privileges are checked and operation may be refused.

Limit value checks are not carried out on the measuring range of the data point.

Selection entry fields

No limit value check is carried out on selection entry fields.

A check is carried out, however, if operating privilege "Manual" is set.

The number of stages for switching commands may be limited in the selection list depending on the overall setup (Num of Stage).

3.7 Alarm handling

Proceed as follows if a plant is faulty (queued alarm, "!!!", or several alarms visible):

- Move down in the plant hierarchy (Plant > Partial Plant > Data point) to locate the faulty element.
- Remove the cause of the plant fault.
- Check to ensure the alarm message on the TP177 is gone.

Each partial plant (Typical) has a "Common Alarm" window with the following entry fields:

ACKNOWLEDGE	---/ Yes
RESET	---/ Yes

An "AckTra" is generated here (acknowledge transition).

The alarm can be acknowledged with YES or reset if the state is "---".

4 System functions

4.1 Start window

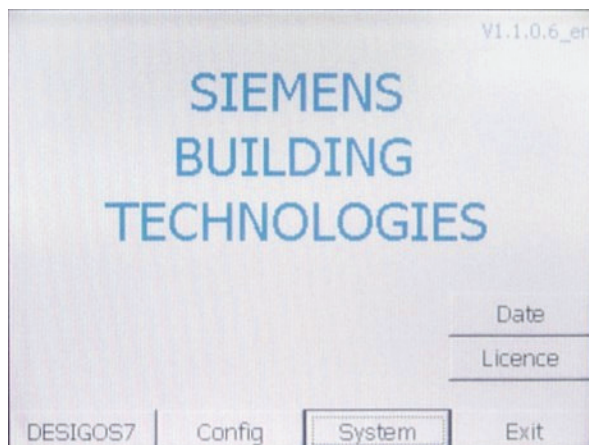

Config

"Administrator" password required

Use this button to open the dialog box to enter user name and password, language, and the MPI/DP/TCP address of the partner. (Section 4.4).

System

"Administrator" password required

Use this button to open the System window allowing you to enter other settings. (Section 4).
(Calibrate touch, Contrast, Date/Time of TP, Control Panel).

DESIGO S7

Use this button to open the window to operate the DESIGO S7 plants (plant overview).
No password required, the graphics can only be monitored. (Level 0) (Section 4.8).

Date window

"Administrator" password required

Use this button to open the window to operate the AS time and date. (Section 4.2).

License window

"Administrator" password required

Use this button to open the runtime protection Operation/Monitoring. (Section 4.3).

EXIT

Return to the standard Control Panel *) of the S7 TP177 and restart the panel. (You must restart after each change to the CPU).

ADMIN password The default "Administrator" password is **DES7/999**.
Can be changed. (Section 4.6).

*) As a rule, the system function (Control Panel, taskbar) of the DESIGO S7 TP177 corresponds to that of the Simatic TP177B. For this reason, please refer to the operating manual for the SIMATIC TP177B [1].

4.2 Date window

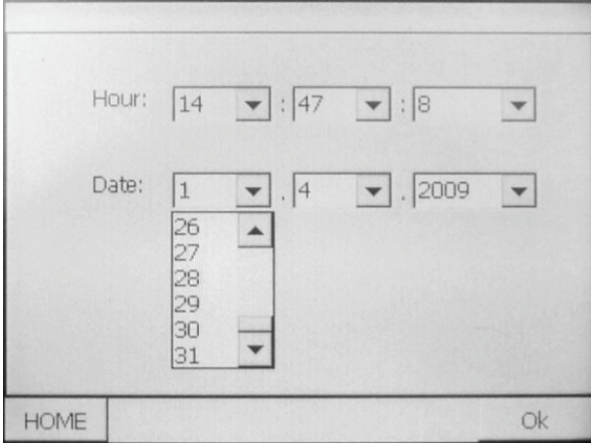

The screenshot shows a 'Date' window with three rows of dropdown menus. The first row is labeled 'Hour:' and contains three dropdowns with values 14, 47, and 8. The second row is labeled 'Date:' and contains three dropdowns with values 1, 4, and 2009. A third dropdown menu is open below the first date dropdown, showing a list of numbers from 26 to 31. At the bottom of the window are two buttons: 'HOME' on the left and 'Ok' on the right.

Set Hour / Date

"Administrator" password required

HOME

OK

Touch fields to operate, select values from list and confirm with OK.
This time of day / hour appears in all DESIGO S7 windows.

Return to the Start window.

Use this button to confirm and apply your entries.

4.3 License window

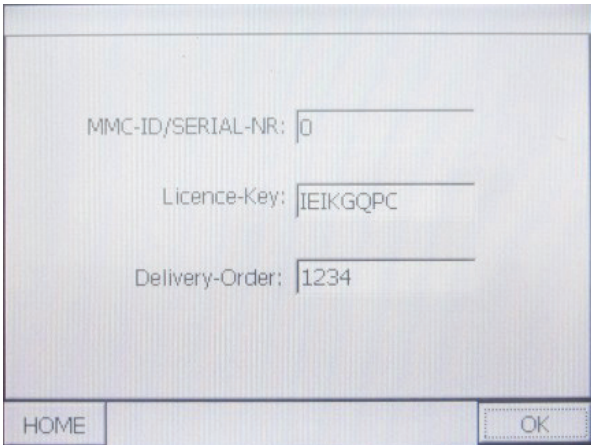

The screenshot shows a 'License' window with three input fields. The first field is labeled 'MMC-ID/SERIAL-NR:' and contains the value '0'. The second field is labeled 'Licence-Key:' and contains the value 'IEIKGQPC'. The third field is labeled 'Delivery-Order:' and contains the value '1234'. At the bottom of the window are two buttons: 'HOME' on the left and 'OK' on the right.

Enter license

"Administrator" password required

HOME

OK

Enter the runtime license protection for SIMATIC here.

Touch the fields to display a keyboard. Enter the values (dispatch note) or string (license key) and confirm with OK.

The MMC-ID or serial number is displayed.

Return to the Start window.

Use this button to confirm and apply your entries.

4.4 Configuration

Touch **Config** in the Start window to open the configuration window. (Provided you are logged in).

CPU No.1 and TCP/IP are selected per default.

Touch a numeric field to open the numeric keyboard:

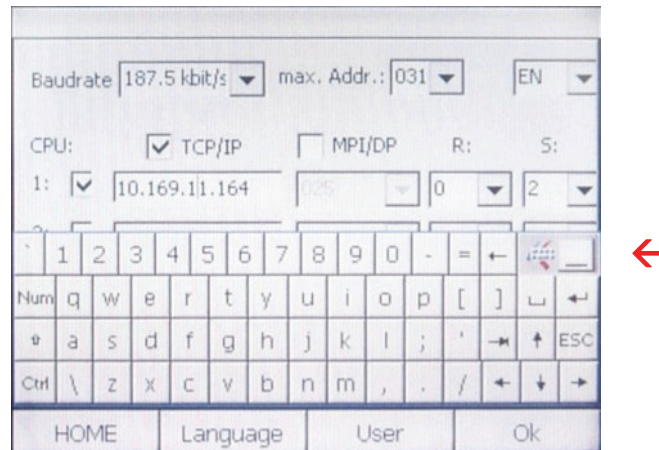

Enter address and rack number and confirm with **OK**.

Move up the keyboard to parameterize CPU 2,3,4 as needed.

Use this button to do this:



Set CPU parameters

You can parameterize up to four CPUs. Two communication protocols are possible (MPI/DP or TCP_IP). (No mixing please).

Procedure:

- Select protocol (MPI/DP or TCP/IP).
- Select one or several CPUs (1 2 3 4) (no gap).
- Set rack number (R) and slot number (S) of the CPUs.
- Enter the CPU address. (The keyboard is displayed as soon as you touch the fields).
- Set the baud rate and highest member address for MPI/DP.
- Select window language (should be the same as system language): (Section 4.6). DE: German; EN: English.
- Select OK to apply and save your configuration settings.

HOME

Return to the Start window.

Language

"Administrator" password required

Use this button to change to the system language window (menus). (See chapter 4.6)

User

"Administrator" password required

Use this button to open the window to enter user names and passwords. (Section 4.6).

OK

Use this button to apply your configuration entries.

Default configuration

Number of CPUs	1
MPI/DP	2
Rack	0
Slot	2
Baud rate	187.5 kbps
Highest station address	31
Language	German

4.5 System

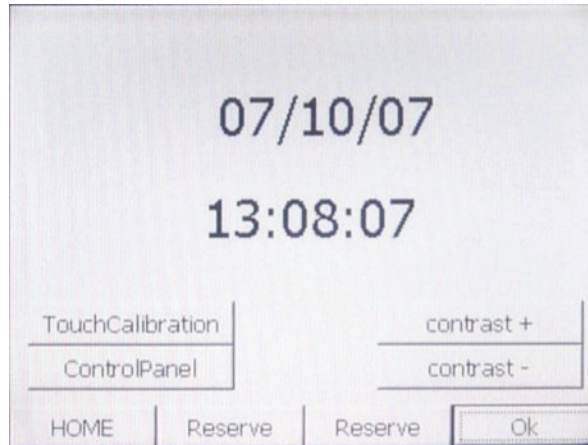

Touch Calibration

Select this button and touch cross five times (center and four corners), then touch the display to save the settings.

Calibration is needed if you want to operate very small fields.

This setting is lost after power failure.

Contrast +, Contrast -

Touch Contrast + or Contrast- as many times as needed until the desired contrast is achieved.

This setting survives power failure.

Control Panel

This button takes you to the Control Panel.

See standard device manual "Operator unit TP177A, TP177B, OP177B (WinCC flexible)" [1]. You can e.g. set the communications protocol and the TP's address with the "Transfer" button.

These settings survive power failure.

HOME

Return to the Start window.

Time/Date

Set the system time: **(Not AS Time/Date)**

- Touch Date and enter the date via the keyboard.
E.g. 12 February 2007 → 12.02.07
Apply with **Return** and save with **OK**.
- Touch Hour and enter the time via the keyboard.
E.g. 16 hours 52 minutes 22 seconds → 16:52:22
Apply with **Return** and save with **OK**.

These settings are lost after power failure.

OK

Use this button to apply and save date and time.

4.6 Language (menu)

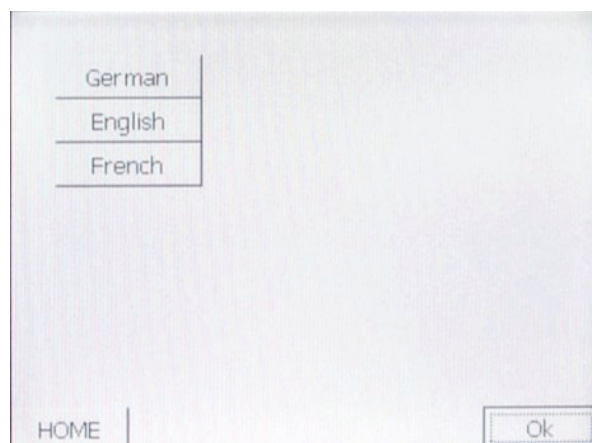

General

This setting is lost after power failure.

Default language: German.

Set Language

Touch the desired language and confirm with **OK**.

The system language should be the same as the configured language.

HOME

Return to the Start window.

OK

Use this button to apply the selected language.

4.7 Password and user administration

User	Password	Group	Rights
A		Group (1)	5
	*****	Group (0)	5
B	*****	Group (2)	5
C	*****	Group (3)	5
D	*****	Group (4)	5
E	*****	Group (5)	5

HOME Language Ok

General

A password, group and logout time are assigned to each user. Group9 (SICX and ADMIN) has the highest rights and Group1 the lowest. (See next page). Users "SICX/Group(9)" and "ADMIN/Group(9)" are administrators. Group(0) (view only) does not need to be parameterized. This is the default group, active after logout time is expired, if DESIGO S7 windows were opened without login, or if a user logs out via the **Logout** button. Groups (1) to (8) correspond to the different operating levels.

The user name can be between 1 and 40 characters.

The password must be between at least 3 and max. 24 characters. (No blanks).

SICX can reassign the user to his/her group if a user (A to H) was moved to group "Unauthorized" (see Section 2.4). (Group (1) to (8)).

If SICX was moved to group "Unauthorized", ADMIN can reassign the user (Group (9)).

If ADMIN is moved to "Unauthorized", ADMIN can no longer be reauthorized.

In this case, you must reload the firmware (WinCC flexible or memory card).

To operate fields:

Double-touch to display the keyboard or a selection list.

Enter values, numbers or assign a group and confirm with OK.

HOME

Return to the Start window.

Language

"Administrator" password required

Use this button to change to the system language window. (Section 4.6).

OK

Use this button to apply your entries to the user window.

Assign password level / operating privileges

The following password levels exist on the S7 TP177.

Group	User / Password	Privilege	Comments
0	Logout	View only.	Touch "Logout" in DESIGO S7 window
1	A/111	No parameter affected	
2	B/222	Release OP (AO,BO,MO,AV,BV,MV) Value OP (AO,BO,MO,AV,BV,MV) Acknowledge (CMN_ALM) Reset (CMN_ALM)	
3	C/333	Low Limit (AI,AO,AV) High Limit (AI,AO,AV) Neutral Zone (AI,AO,AV) Setpoint (CTR) Present Value (AVOP,BVOP,MVOP) SWI_2P (all R/W parameters) SWI_2PH (all R/W parameter) CHAR (all interpolation points) HCRV, HRA (all R/W parameters) KICKFNCT (all R/W parameters) CONT_4ST (all R/W parameters) EVT_DATE (all R/W parameters) EVT_WDAY (all R/W parameters)	
4	D/444	SP_SUPPLY (all R/W parameters) CAS_CONT (all R/W parameters)	
5	E/555	No parameter affected	
6	F/666	No parameter affected	
7	G/777	No parameter affected	
8	H/888	No parameter affected	
9	DES7/999	Operate all including system function (password, license, TP time, ...).	
9	ADMIN/2008	Same as DES7; used to reauthorize DES7 as needed.	Read-only group.

Note

All operating levels include the operating privileges of all lower levels.



Important

The above default passwords are assigned upon delivery.

As they appear in the documentation, they are unsecure and must therefore be changed during commissioning.

Your IT department sets the rules for secure passwords.

4.8 Plant overview window

General

The plant overview window displays all plants upon start (**DESIGO S7** in Start window). You can monitor and operate all plant objects from this window. In addition, communications problems and AS time are displayed in a message. AS time can be updated and aligned hourly upon each start of DESIGO S7 Control.

Design

Only the first 11 rows are displayed; any other lines must be operated by scrolling vertically.

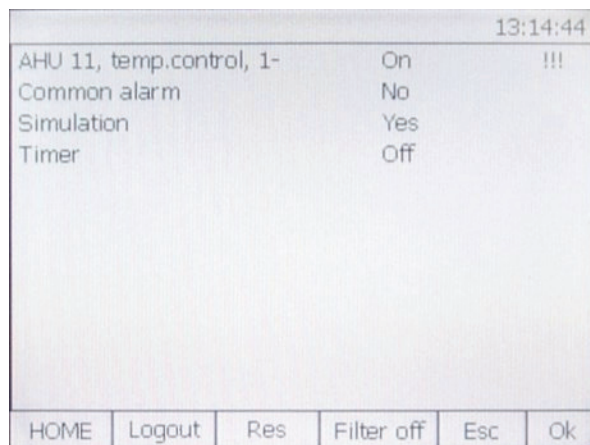

The screenshot shows a window titled "13:14:44" with a table of plant data. The table has three columns: Plant Name, Status, and Fault Identification. The data rows are:

Plant Name	Status	Fault Identification
AHU 11, temp.control, 1-	On	!!!
Common alarm	No	
Simulation	Yes	
Timer	Off	

At the bottom of the window is a navigation bar with buttons: HOME, Logout, Res, Filter off, Esc, and Ok.

General

The descriptions below apply to all DESIGO S7 windows.

Button **Filter off/on** is irrelevant for data point windows.

RW and **RO** mean:

Read-write and **read-only**.

Columns

Column 1: Plant name clear text.

Depends on the pixel size (max. 32 characters).

May be cropped.

Column 2: Setpoint or desired stage.

(Number of characters depends on pixel size; text may be cropped).

Column 3: Fault identification (!!!)

HOME

Return to the Start window.

Logout / Login

This button allows for changing the operating privileges to Group 0 (Logout) or Group 1 to 9 (Login).

If "Login" is displayed, a keyboard appears to enter user name and password.

After confirmation, the button label changes to "Logout". If "Logout" is displayed, touching changes the operator privilege to Group 0 and the button label returns to "Login".

Res

This is a Reserve button that opens an empty window if this type of window and link to WinCC was engineered flexibly and downloaded in the TP. This button can be used only **for one single window reference**.

Filter off/Filter on

This button allows you to select if all plants/levels should be displayed (Filter off) or only faulty ones (elements with queued alarm) (Filter on).

- ESC** This button allows you to return to the previous window.
There is no button to go to the plant overview
(you ARE in the plant overview).
- OK** Use this button to apply your entries.
- Help and Error Code** Use this button to change to the Help window. If communication between the TP and AS is faulty, or if the configuration window contains faulty parameters, an error ID is displayed. The ID's meaning is available in the Help window. (Section 5).
Button **Help** and Error ID appear in the message row only in the event of an error.

4.9 Partial plant overview window

General The partial plant overview window shows all partial plants of a plant.
You can monitor and operate all partial plants of this plant from this window.

Design Only 11 rows are displayed; any other rows must be operated by scrolling vertically.

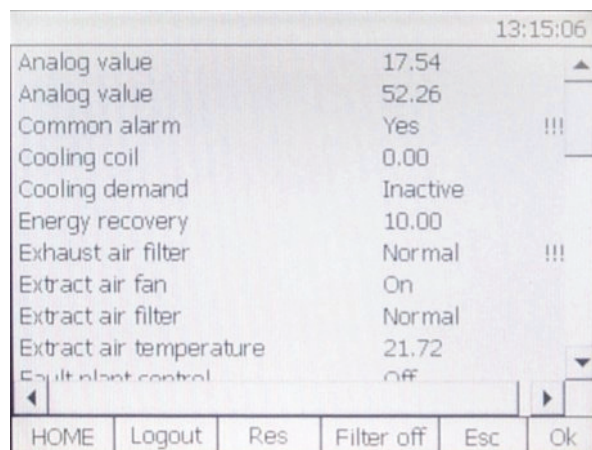

- Columns**
- Column 1: Partial plant name clear text.
(Depends on the pixel size (max. 24 characters).
May be cropped.
 - Column 2: Setpoint / Desired stage.
 - Column 3: Fault identification (!!!)

4.10 Block overview window

General

The block overview window shows all blocks of a partial plant.
You can monitor and operate all blocks of this partial plant from this window.

Design

Only 7 lines are displayed at a time.
Up to 11 lines can be displayed, the rest being accessible by means of a scrollbar.

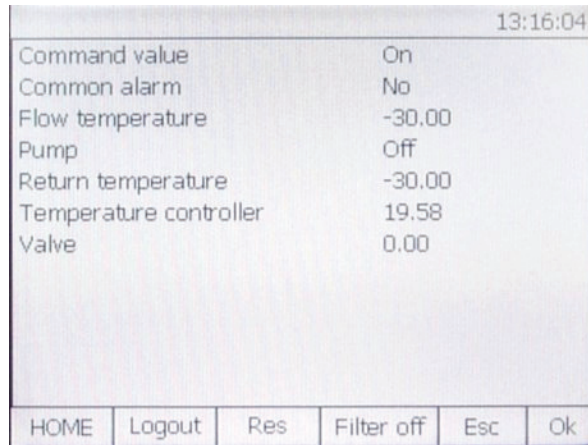

13:16:04	
Command value	On
Common alarm	No
Flow temperature	-30.00
Pump	Off
Return temperature	-30.00
Temperature controller	19.58
Valve	0.00

HOME Logout Res Filter off Esc Ok

Columns

- Column 1: Block name clear text.
(Depends on the pixel size (10 to 24 characters).
May be cropped.
- Column 2: Setpoint, actual value or desired stage.
(Number of characters depends on pixel size; text may be cropped).
- Column 3: Fault identification (!!!)

5 TP 177 error messages

General

The S7 TP177 is based on the SIMATIC TP177B; for this reason, standard system messages are not described here.

Technically specific error messages in excess of standard error message, however, are described here.

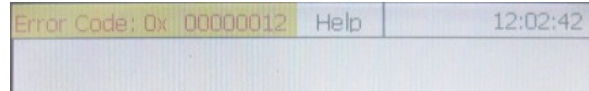

Column meaning

Error Code :
0x 00130012
Help

In the event of an error, an error ID appears in the message row for each configured CPU.

Use this button to change to the Help window.

Help is displayed only in the message row if there is an error.

Note

The most common error messages have ID **12** (faulty configuration or duplicate address in network) and **13** (DB not loaded or wrong DB).

Example : 0x 00130012 means

- CPU1 not configured correctly.
- DB1 or data point DB missing in CPU3.

Special feature

Communications errors are signaled only after ca. 1 minute due to the set "Time_out" of the TCP/IP protocol.

The same is true when you touch **Help**.

Help1

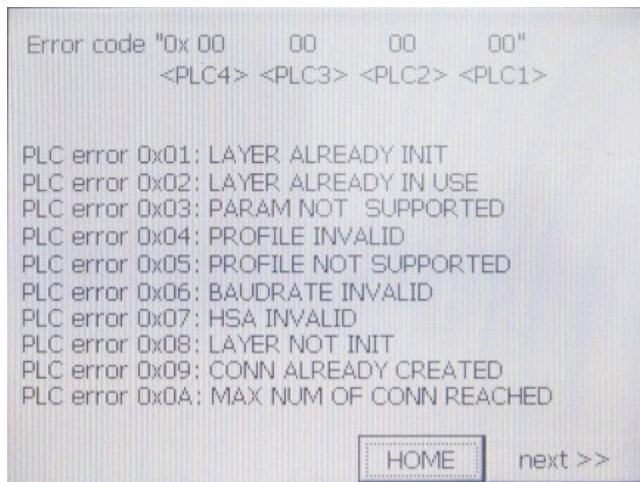

Help2

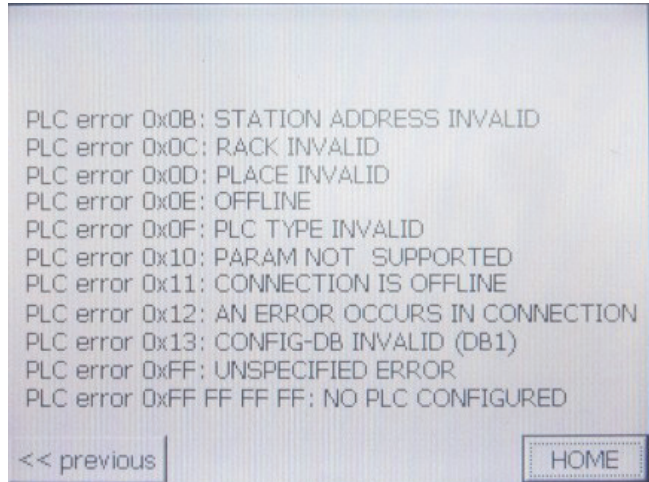

6 Install DESIGO S7 firmware

SIEMENS

Information sheet SBT DESIGO S7 X V1.2

You can extend the standard WinCC project of the DESIGO S7 TP177. (Free window, message protocols, etc.). To do this, you must install DESIGO S7 X firmware on the development machine. You can change the DESIGO S7 WinCC project and transfer to a DESIGO S7 TP177 after installing the firmware.

You can also upgrade the DESIGO S7 TP177 to the latest firmware version.

Important

You cannot convert *SIMATIC TP177B* to DESIGO S7 TP177.

You can load a DESIGO S7 WinCC project (standard or extended) to SIMATIC TP177B, but you cannot open the plant overview.

SIMATIC TP177B can be updated to DESIGO S7 TP177 only via the DESIGO S7 Hotline in Karlsruhe, Germany, or in Zug.

6.1 Setup contents

Extensions for WinCC flexible ES

Config Control
DESIGO S7 Control
Date/Time Control
License Control

Extensions for WinCC flexible Runtime

Config Control
DESIGO S7 Control
Date/Time Control
License Control
Modified S7Channel-DII for TP177

Extensions ProSave

Modified S7Channel-DII

Extract file **Lieferung_V1.2.zip** to the development machine.

The following folders and files are created:

SETUP (Setup Script)
FLEXIBEL_TEST_PROJEKT (WinCC project)
Information sheet_v1.2.0.0.doc

6.2 Set up on your development machine

Prerequisite:

- WinCC flexible 2008 + SP1 + Hotfix3 installed.

Start *Script Setup.exe* from `Lieferung_V1.2\Setup\Disk1`.

After the script is executed (a few seconds), all required dll and xml files are copied to the development machine at the following location:

`C:\Program Files\Siemens\SIMATIC WinCC flexible\WinCC flexible 2007\Transfer\1.3\XP177B`

You can now load the standard DESIGO S7 WinCC project or an extended project to the DESIGO S7 TP177.

6.3 Load WinCCflexible project

You can now extend project `DesigoS7_14.hmi` and transfer the data to S7 TP177.

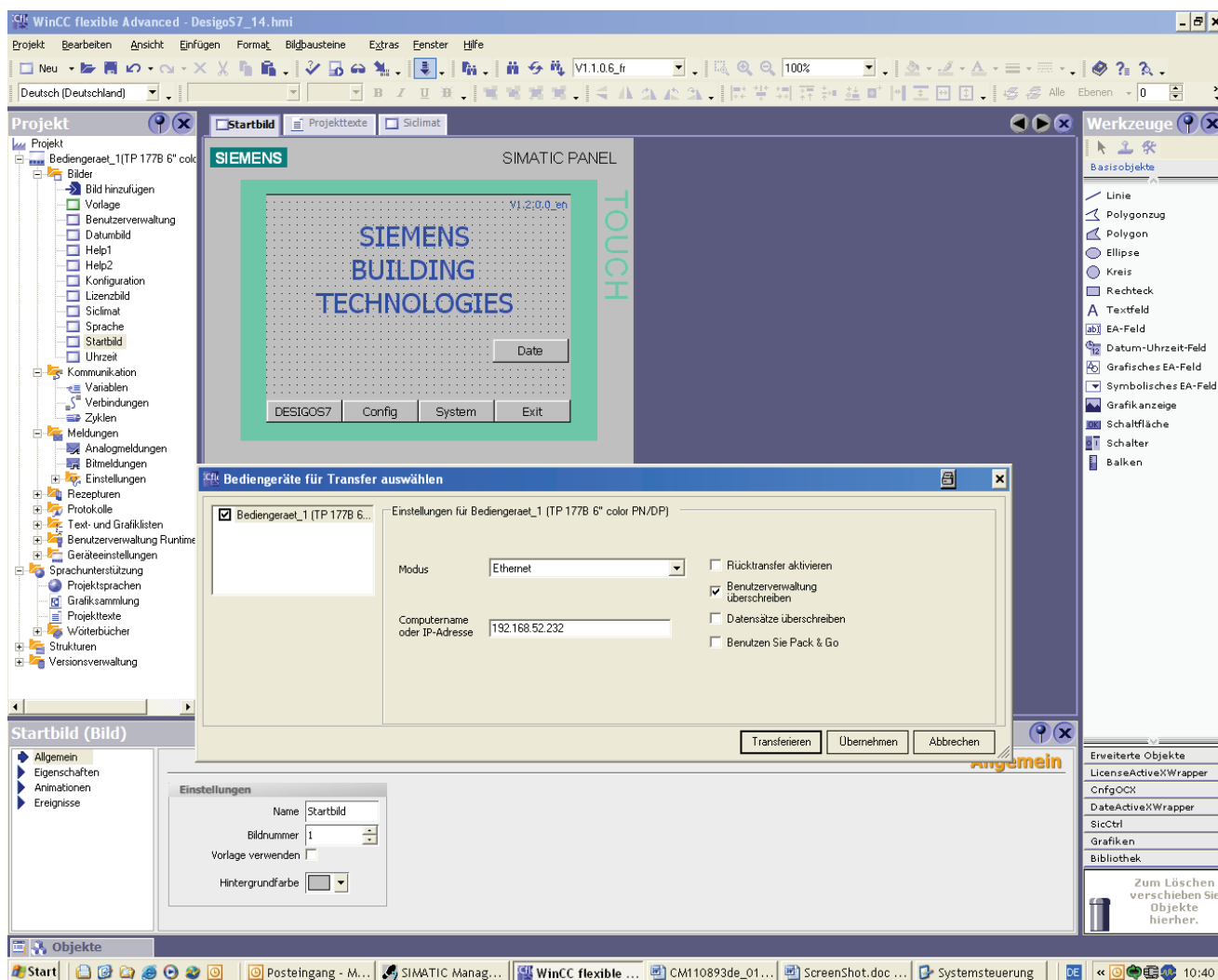

Important notes for reengineering:

If an engineered connection was loaded in an extended WinCC project, the S7 TP177 no longer works, if the WinCC project is transferred without connection. This is a system function.

Loading the standard DESIGO S7 WinCC project does not solve the problem.

The following solutions are available:

- Load the project with at least one connection.
- Execute "RESTORE".
- Clear/reset the S7 TP177, install the DESIGO S7 firmware on the S7 TP177, and reload the DESIGO S7 WinCC project.

6.4 Install DESIGO S7 firmware / upgrade TP 177B

You can upgrade a DESIGO S7 TP177 or repair it in some cases.

Prerequisites:

- WinCC flexible 2008 + SP1 installed.
- Setup of DESIGO S7 firmware started successfully. (Section 6.2).

Prepare the panel

- You must first upgrade storage memory on the device. To this via "Control Panel" → "System" → "Memory".
- Move the scrollbar so that ca. 4000 KB "total storage memory" is available.
- Then set the communications protocol via "Control Panel" → "Transfer". (Ethernet or MPI).

Installation using ProSave

In Windows: Start/Simatic/ProSave

The example below uses an MPI connection, but it also works on TCP/IP:

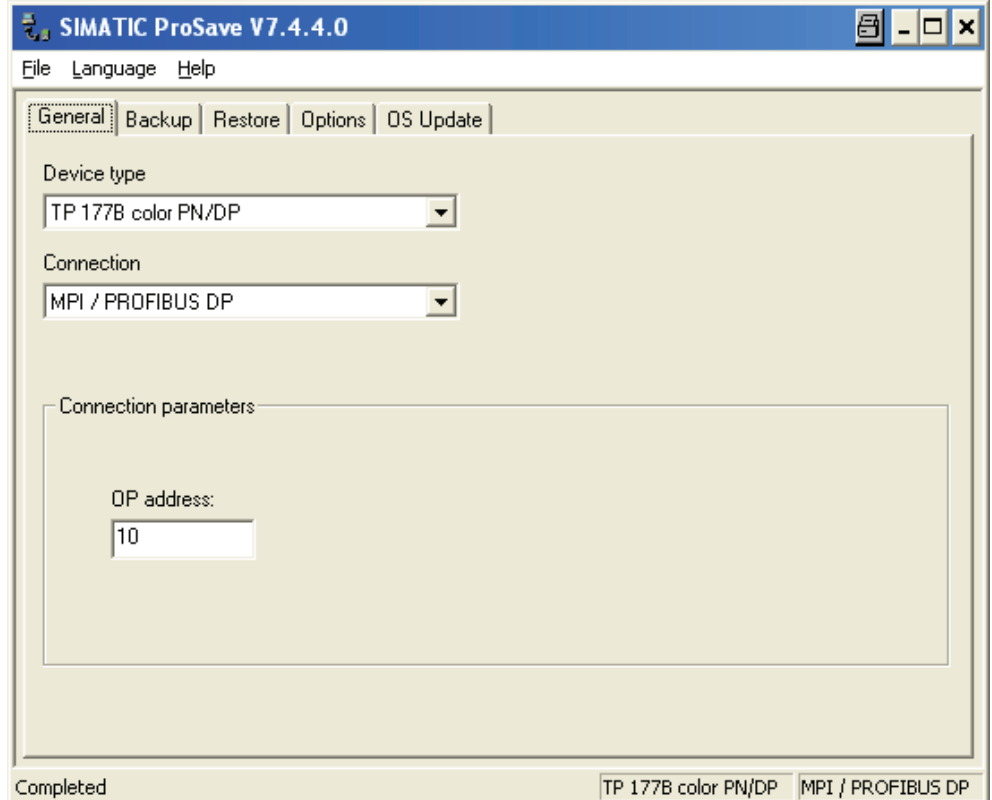

Example with TCP/IP:

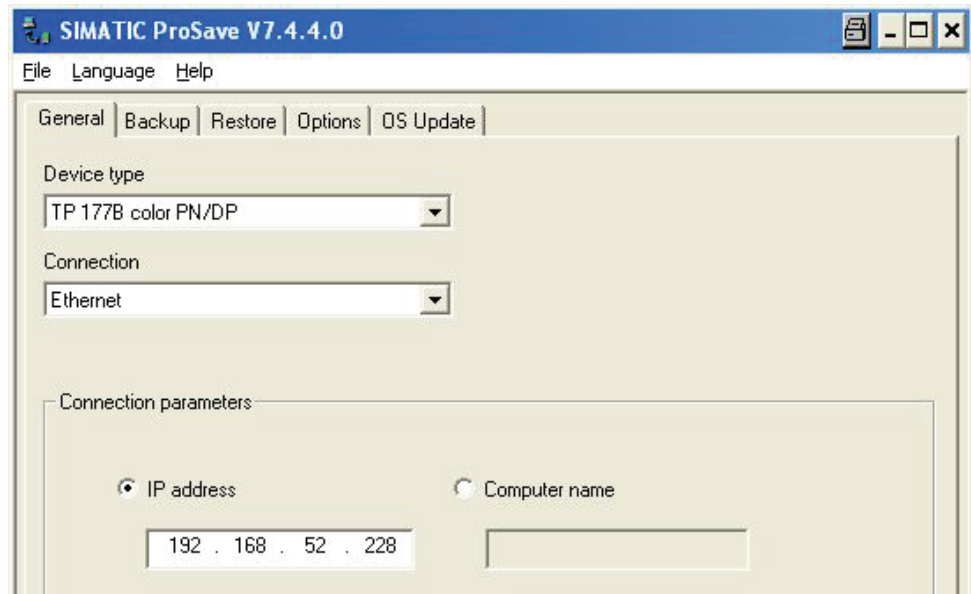

Check image

- Use "OS Update" and "Device Status" to check the **Image** version on the development machine:
The version must be **B 1.1.2.0** or higher.
- If not, install WinCC flexible 2008 + SP1 and execute "Update OS".
The S7 TP177 must be in mode "Transfer" "Connecting to host ...".

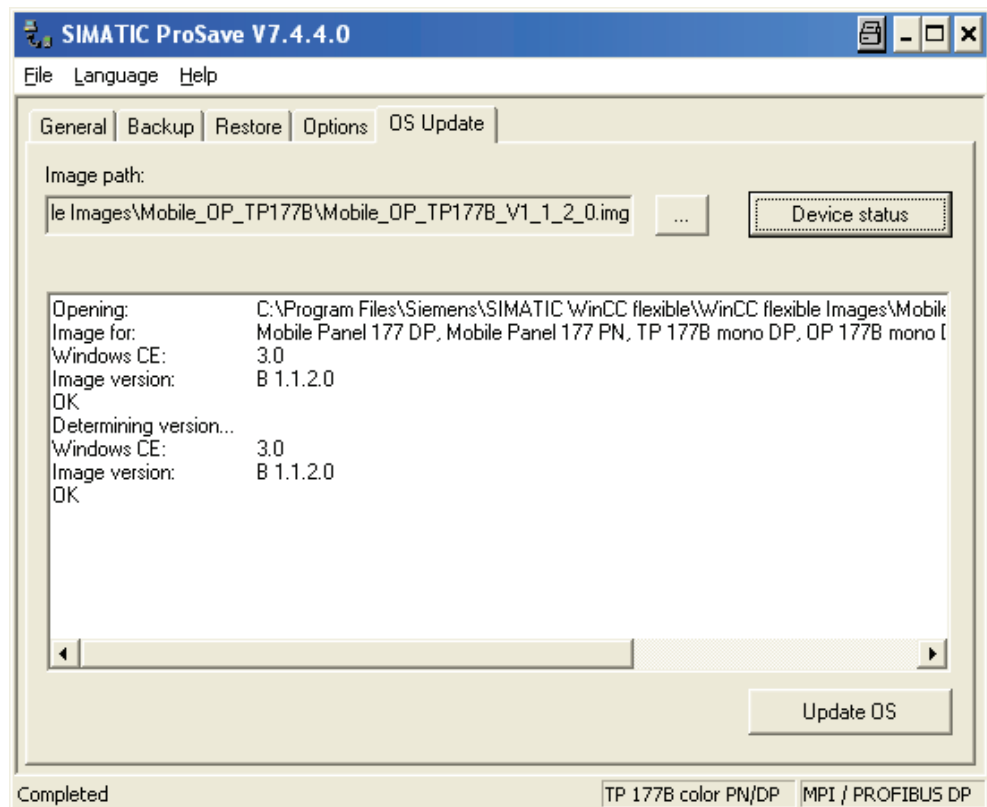

The figure shows that the development machine has the right image; the image on the S7 TP177 is old. Start Update OS.

After the OS is updated, re-upgrade the storage memory in DESIGO S7 TP177 and set the MPI or TCP address and communication protocol.

The DESIGO S7 AddOn can now be applied to the S7 TP177.

**Apply DESIGO S7
AddOn to TP 177B**

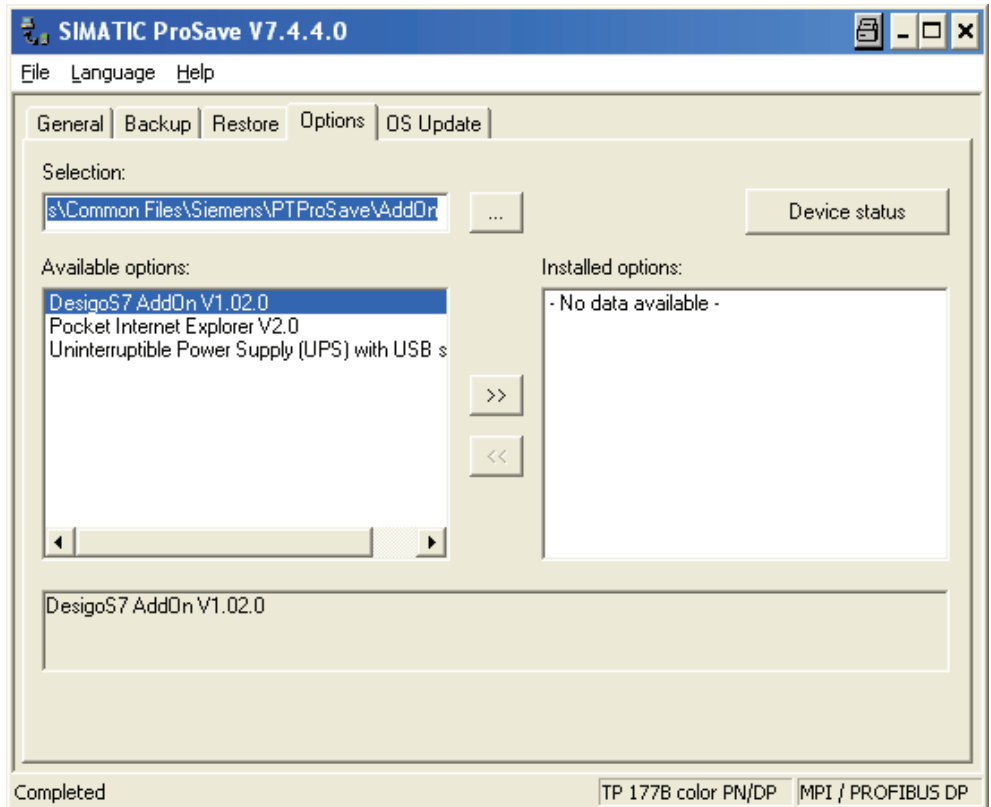

Transfer DesigoS7 AddOn V1.02.0 to the S7 TP177 via the "Options" menu.

Selection path:

C:\Program Files\Common Files\Siemens\PTProSave\AddOn

The S7 TP177 must be in mode "Transfer" "Connecting to host ...".

The following is displayed after a successful transfer:

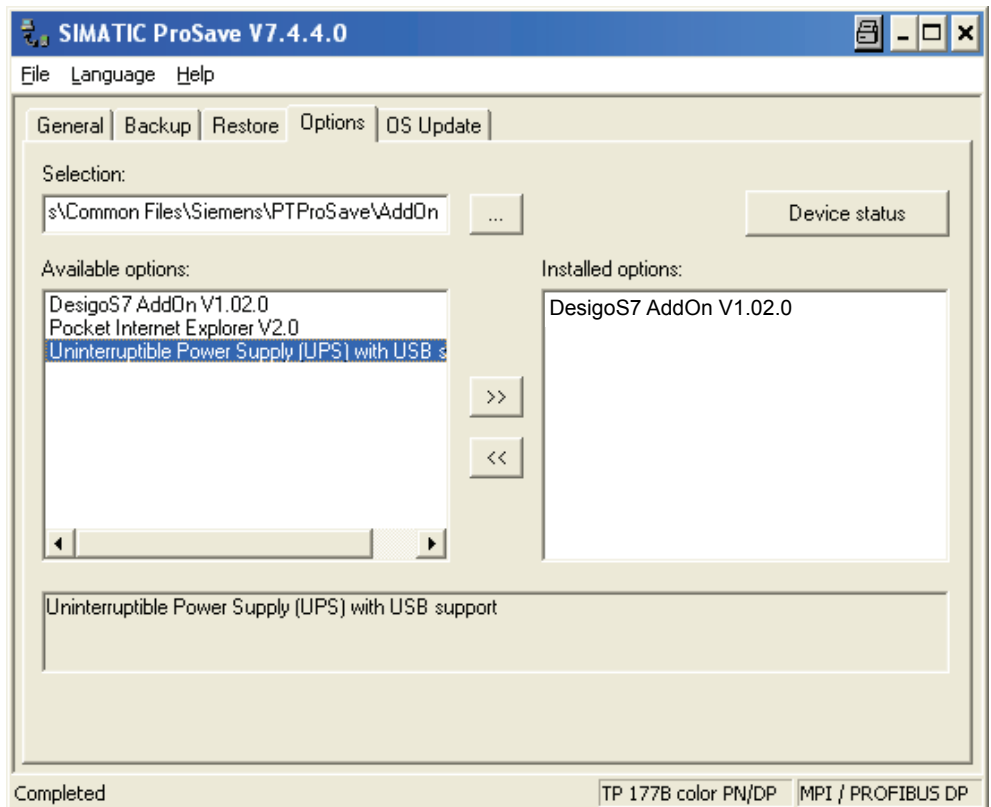

Project **DesigoS7_14.hmi** can be transferred to TP 177B.

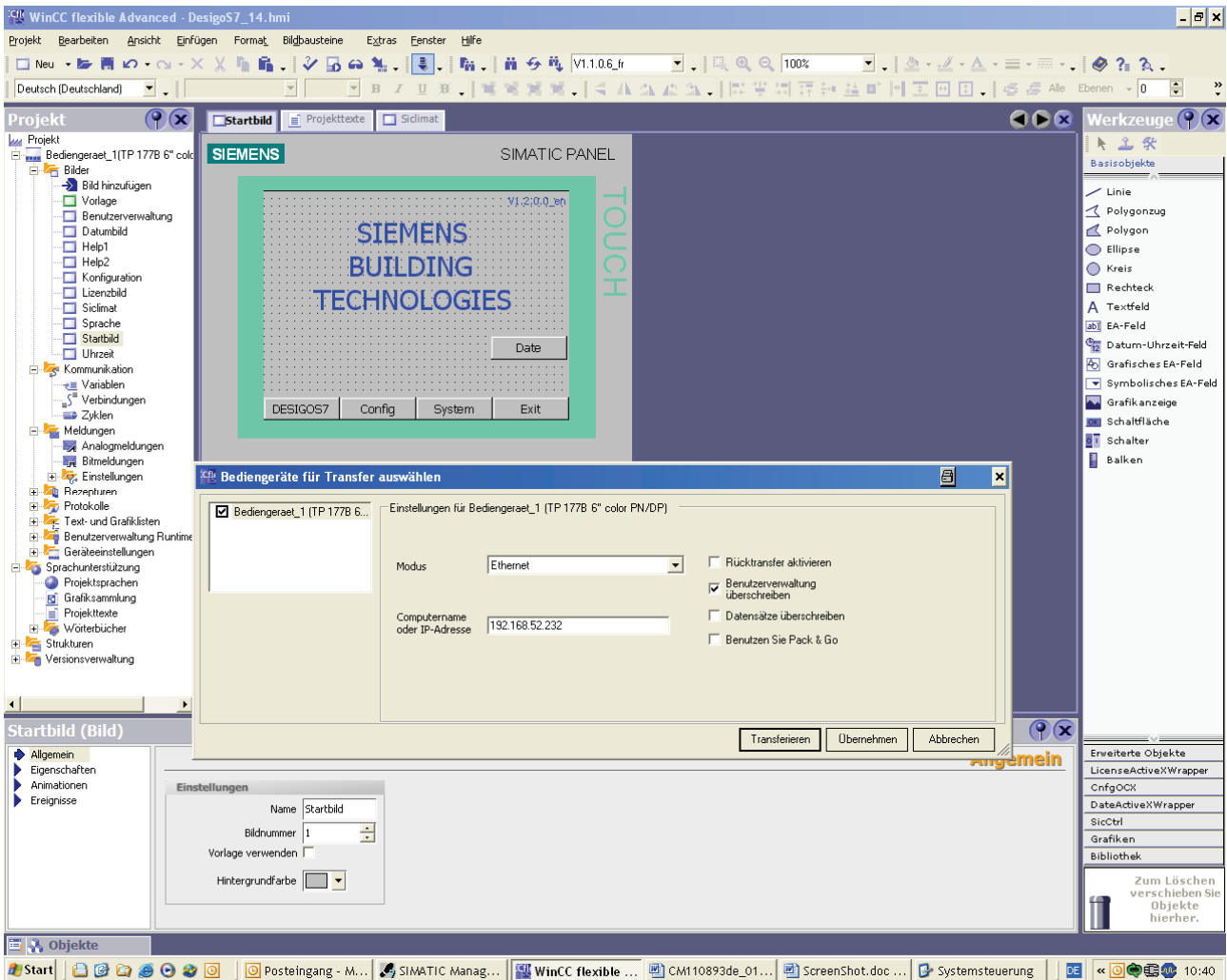

Upgrade or repair DESIGO S7 TP177 with the new firmware.

Save this status to a media card or to the development machine.
(See *Backup/Restore* in the Control Panel of the DESIGO S7 TP177B or in ProSave).

Siemens Switzerland Ltd
Building Technologies Division
International Headquarters
Gubelstrasse 22
CH-6301 Zug
Tel. +41 41-724 24 24
Fax +41 41-724 35 22
www.buildingtechnologies.siemens.com

© 2009 - 2012 Siemens Switzerland Ltd
Subject to change