

HYS72T64400HFD-[3S/3.7]-A
HYS72T128420HFD-[3S/3.7]-A
HYS72T256420HFD-[3S/3.7]-A

240-Pin Fully-Buffered DDR2 SDRAM Modules
DDR2 SDRAM
RoHS Compliant Products

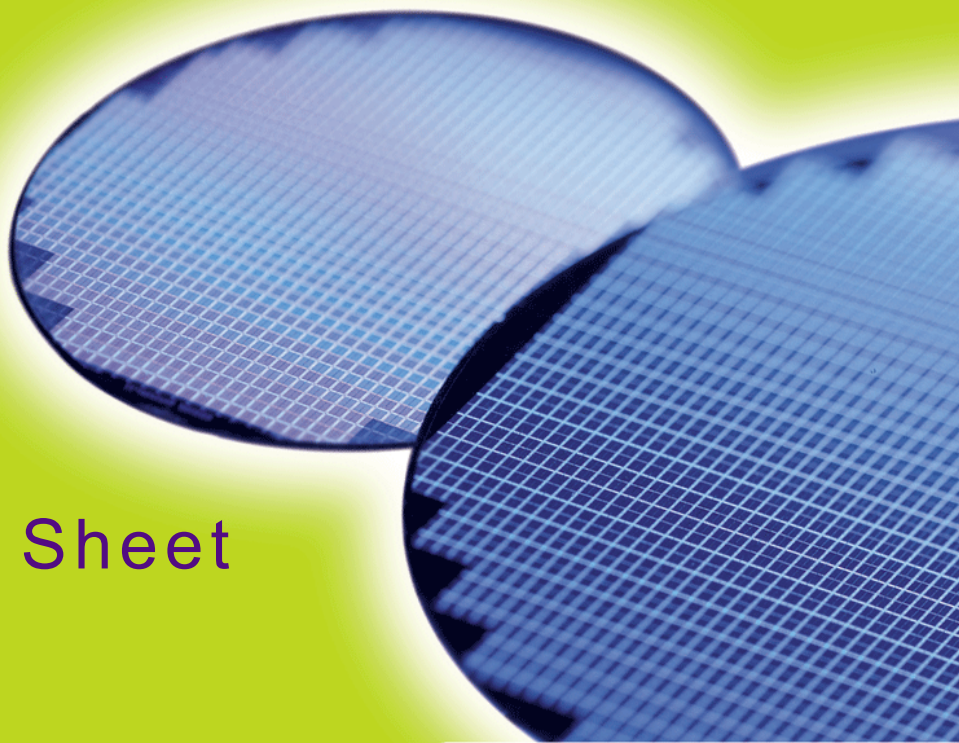

Internet Data Sheet

Rev. 1.2



Revision History: Rev. 1.2, 2006-11-27	
All	Adapted internet edition
Page 19	Updated “ Current Spec. and Conditions ” on Page 19
Previous Revision: Rev. 1.1, 2006-09-26	
All	Converted to qimonda template

We Listen to Your Comments

Any information within this document that you feel is wrong, unclear or missing at all?

Your feedback will help us to continuously improve the quality of this document.

Please send your proposal (including a reference to this document) to:

techdoc@qimonda.com



1 Overview

This chapter describes the main characteristics of the 240-Pin Fully-Buffered DDR2 SDRAM Modules product family.

1.1 Features

- 240-pin Fully-Buffered ECC Dual-In-Line DDR2 SDRAM Module for PC, Workstation and Server main memory applications.
- Module organisation one rank 64M ×72, one rank 128M ×72, two ranks 128M ×72, two ranks 256M ×72
- JEDEC Standard Double Data Rate 2 Synchronous DRAMs (DDR2 SDRAMs) with 1.8 V (± 0.1 V) power supply.
- Built with 512Mb DDR2 SDRAMs in 60-ball FBGA Chipsize Packages.
- Re-drive and re-sync of all address, command, clock and data signals using AMB (Advanced Memory Buffer).
- High-Speed Differential Point-to-Point Link Interface at 1.5 V (Jedec standard pending).
- Host Interface and AMB component industry standard compliant.
- Supports SMBus protocol interface for access to the AMB configuration registers.
- Detects errors on the channel and reports them to the host memory controller.
- Automatic DDR2 DRAM Bus Calibration.
- Automatic Channel Calibration.
- Full Host Control of the DDR2 DRAMs.
- Over-Temperature Detection and Alert.
- Hot Add-on and Hot Remove Capability.
- MBIST and IBIST Test Functions.
- Transparent Mode for DRAM Test Support.
- Low profile: 133.35mm × 30.35 mm
- 240 Pin gold plated card connector with 1.00mm contact centers (JEDEC standard pending).
- Based on JEDEC standard reference card designs (Jedec standard pending).
- SPD (Serial Presence Detect) with 256 Byte serial E²PROM.Performance:
- RoHS Compliant Products¹⁾

TABLE 1
Performance for DDR2-667 and DDR2-533

Product Type Speed Code			-3S	-3.7	Unit
Speed Grade			PC2-5300 5-5-5	PC2-4200 4-4-4	—
max. Clock Frequency	@CL5	f_{CK5}	333	266	MHz
	@CL4	f_{CK4}	266	266	MHz
	@CL3	f_{CK3}	200	200	MHz
min. RAS-CAS-Delay		t_{RCD}	15	15	ns
min. Row Precharge Time		t_{RP}	15	15	ns
min. Row Active Time		t_{RAS}	45	45	ns
min. Row Cycle Time		t_{RC}	60	60	ns

1) RoHS Compliant Product: Restriction of the use of certain hazardous substances (RoHS) in electrical and electronic equipment as defined in the directive 2002/95/EC issued by the European Parliament and of the Council of 27 January 2003. These substances include mercury, lead, cadmium, hexavalent chromium, polybrominated biphenyls and polybrominated biphenyl ethers.



1.2 Description

This document describes the electrical and mechanical features of a 240-pin, PC2-4200F, PC2-5300F ECC type, Fully Buffered Double-Data-Rate Two Synchronous DRAM Dual In-Line Memory Modules (DDR2 SDRAM FB-DIMMs). Fully Buffered DIMMs use commodity DRAMs isolated from the memory channel behind a buffer on the DIMM. They are intended for use as main memory when installed in systems such as servers and workstations. PC2-4200, PC2-5300 refers to the DIMM naming convention indicating the DDR2 SDRAMs running at 266, 333 MHz clock speed and offering 4200, 5300 MB/s peak bandwidth. FB-DIMM features a novel architecture including the Advanced Memory Buffer. This single chip component, located in the center of each DIMM, acts as a repeater and buffer for all signals and commands which are exchanged between the host controller and the DDR2 SDRAMs including data in- and output. The AMB communicates with the host controller and / or the adjacent

DIMMs on a system board using an Industry Standard High-Speed Differential Point-to-Point Link Interface at 1.5 V.

The Advanced Memory Buffer also allows buffering of memory traffic to support large memory capacities. All memory control for the DRAM resides in the host, including memory request initiation, timing, refresh, scrubbing, sparing, configuration access, and power management. The Advanced Memory Buffer interface is responsible for handling channel and memory requests to and from the local DIMM and for forwarding requests to other DIMMs on the memory channel. Fully Buffered DIMM provides a high memory bandwidth, large capacity channel solution that has a narrow host interface. The maximum memory capacity is 288 DDR2 SDRAM devices per channel or 8 DIMMs.



TABLE 2
Ordering Information (Pb-free components and assembly)

Product Type ¹⁾	Compliance Code ²⁾	Description	SDRAM Technology
PC2-4200F (DDR2-533):			
HYS72T64400HFD-3.7-A	512MB 1R×8 PC2-4200F-444-11-A	1 Rank, FB-DIMM	512 Mbit (×8)
HYS72T128420HFD-3.7-A	1GB 2R×8 PC2-4200F-444-11-B	2 Ranks, FB-DIMM	512 Mbit (×8)
HYS72T256420HFD-3.7-A	2GB 2R×4 PC2-4200F-444-11-H	2 Ranks, FB-DIMM	512 Mbit (×4)
PC2-5300F (DDR2-667):			
HYS72T64400HFD-3S-A	512MB 1R×8 PC2-4200F-444-11-A	1 Rank, FB-DIMM	512 Mbit (×8)
HYS72T128420HFD-3S-A	PC2-4200F-444-11-B	2 Ranks, FB-DIMM	512 Mbit (×8)
HYS72T256420HFD-3S-A	2GB 2R×4 PC2-4200F-444-11-H	2 Ranks, FB-DIMM	512 Mbit (×4)

- 1) All product types end with a place code, designating the silicon die revision. Example: HYS 72T64000HFA-3.7-A, indicating Rev. A dice are used for DDR2 SDRAM components. To learn more on QIMONDA DDR2 module and component nomenclature see section 8 of this datasheet.
- 2) The Compliance Code is printed on the module label and describes the speed grade, e.g. "PC2-4200F-444-11-A", where 4200F means Fully Buffered DIMM with 4.26 GB/sec. Module Bandwidth and "444-11" means CAS latency = 4, t_{rdd} latency = 4 and t_{rp} latency = 4 using JEDEC SPD Revision 1.1 and assembled on Raw Card "A".



HYS72T[64/128/256]4[00/20]HFD-[3S/3.7]-A

TABLE 3
Address Format

DIMM Density	Module Organization	Memory Ranks	ECC/ Non-ECC	# of SDRAMs	# of row/bank/columns bits	Raw Card
512 MB	64M ×72	1	ECC	9	13/2/10	A
1 GB	128M ×72	2	ECC	18	13/2/10	B
2 GB	256M ×72	2	ECC	36	13/2/11	H

TABLE 4
Components on Modules

Product Type	DRAM components ¹⁾	DRAM Density	DRAM Organisation	Note ²⁾
HYS72T64000HF	HYB18T512800AF	512 Mbit	64M ×8	
HYS72T128020HF	HYB18T512800AF	512 Mbit	64M ×8	
HYS72T256020HF	HYB18T512400AF	512 Mbit	128M ×4	

1) Green Product

2) For a detailed description of all functionalities of the DRAM components on these modules see the component datasheet.



2 Pin Configuration

The pin configuration of the DDR2 SDRAM DIMM is listed by function in **Table 5** (240 pins). The abbreviations used in columns Pin and Buffer Type are explained in **Table 6** and **Table 7** respectively. The pin numbering is depicted in **Figure 1**.

TABLE 5
Pin Configuration of FB-DIMM

Pin#	Name	Pin Type	Buffer Type	Function
Clock Signals				
228	SCK	I	HSDL_15	System Clock Input, positive line
229	$\overline{\text{SCK}}$	I	HSDL_15	System Clock Input, negative line
Control Signals				
17	$\overline{\text{RESET}}$	I	LV-CMOS	AMB reset signal
Northbound				
22	PN0	O	HSDL_15	Primary Northbound Data, positive lines
25	PN1	O	HSDL_15	
28	PN2	O	HSDL_15	
31	PN3	O	HSDL_15	
34	PN4	O	HSDL_15	
37	PN5	O	HSDL_15	
51	PN6	O	HSDL_15	
54	PN7	O	HSDL_15	
57	PN8	O	HSDL_15	
60	PN9	O	HSDL_15	
63	PN10	O	HSDL_15	
66	PN11	O	HSDL_15	
48	PN12	O	HSDL_15	
40	PN13	O	HSDL_15	
23	$\overline{\text{PN0}}$	O	HSDL_15	
26	$\overline{\text{PN1}}$	O	HSDL_15	
29	$\overline{\text{PN2}}$	O	HSDL_15	
32	$\overline{\text{PN3}}$	O	HSDL_15	
35	$\overline{\text{PN4}}$	O	HSDL_15	
38	$\overline{\text{PN5}}$	O	HSDL_15	
52	$\overline{\text{PN6}}$	O	HSDL_15	
55	$\overline{\text{PN7}}$	O	HSDL_15	
58	$\overline{\text{PN8}}$	O	HSDL_15	
61	$\overline{\text{PN9}}$	O	HSDL_15	
64	$\overline{\text{PN10}}$	O	HSDL_15	



HYS72T[64/128/256]4[00/20]HFD-[3S/3.7]-A

Pin#	Name	Pin Type	Buffer Type	Function
67	PN11	O	HSDL_15	
49	PN12	O	HSDL_15	
41	PN13	O	HSDL_15	
142	SN0	I	HSDL_15	Secondary Northbound Data, positive lines
145	SN1	I	HSDL_15	
148	SN2	I	HSDL_15	
151	SN3	I	HSDL_15	
154	SN4	I	HSDL_15	
157	SN5	I	HSDL_15	
171	SN6	I	HSDL_15	
174	SN7	I	HSDL_15	
177	SN8	I	HSDL_15	
180	SN9	I	HSDL_15	
183	SN10	I	HSDL_15	
186	SN11	I	HSDL_15	
168	SN12	I	HSDL_15	
160	SN13	I	HSDL_15	
143	SN0	I	HSDL_15	
146	SN1	I	HSDL_15	
149	SN2	I	HSDL_15	
152	SN3	I	HSDL_15	
155	SN4	I	HSDL_15	
158	SN5	I	HSDL_15	
172	SN6	I	HSDL_15	
175	SN7	I	HSDL_15	
178	SN8	I	HSDL_15	
181	SN9	I	HSDL_15	
184	SN10	I	HSDL_15	
187	SN11	I	HSDL_15	
169	SN12	I	HSDL_15	
161	SN13	I	HSDL_15	
Southbound				
70	PS0	I	HSDL_15	Primary Southbound Data, positive lines
73	PS1	I	HSDL_15	
76	PS2	I	HSDL_15	
79	PS3	I	HSDL_15	
82	PS4	I	HSDL_15	
93	PS5	I	HSDL_15	
96	PS6	I	HSDL_15	
99	PS7	I	HSDL_15	



Pin#	Name	Pin Type	Buffer Type	Function
102	PS8	I	HSDL_15	Primary Southbound Data, negative lines
90	PS9	I	HSDL_15	
71	PS0	I	HSDL_15	
74	PS1	I	HSDL_15	
77	PS2	I	HSDL_15	
80	PS3	I	HSDL_15	
83	PS4	I	HSDL_15	
94	PS5	I	HSDL_15	
97	PS6	I	HSDL_15	
100	PS7	I	HSDL_15	
103	PS8	I	HSDL_15	
91	PS9	I	HSDL_15	
190	SS0	O	HSDL_15	Secondary Southbound data, positive lines
193	SS1	O	HSDL_15	
196	SS2	O	HSDL_15	
199	SS3	O	HSDL_15	
202	SS4	O	HSDL_15	
213	SS5	O	HSDL_15	
216	SS6	O	HSDL_15	
219	SS7	O	HSDL_15	
222	SS8	O	HSDL_15	
210	SS9	O	HSDL_15	Secondary Southbound data, negative lines
191	SS0	O	HSDL_15	
194	SS1	O	HSDL_15	
197	SS2	O	HSDL_15	
200	SS3	O	HSDL_15	
203	SS4	O	HSDL_15	
214	SS5	O	HSDL_15	
217	SS6	O	HSDL_15	
220	SS7	O	HSDL_15	
223	SS8	O	HSDL_15	
211	SS9	O	HSDL_15	
EEPROM				
120	SCL	I	CMOS	Serial Bus Clock
119	SDA	I/O	OD	Serial Bus Data
239	SA0	I	CMOS	Serial Address Select Bus 2:0
240	SA1	I	CMOS	
118	SA2	I	CMOS	



Pin#	Name	Pin Type	Buffer Type	Function
Power Supplies				
238	V _{DDSPD}	PWR	–	EEPROM Power Supply
9,10,12,13,129,130,132,133	V _{CC}	PWR	–	AMB Core Power / Channel Interface Power
15,117,135,237	V _{TT}	PWR	–	Address/Command/Clock Termination Power
1,2,3,5,6,7,108,109,111,112,113,115,116,121,122,123,125,126,127,231,232,233,235,236	V _{DD}	PWR	–	Power Supply
4,8,11,14,18,21,24,27,30,33,36,39,42,43,46,47,50,53,56,59,62,65,68,69,72,75,78,81,84,85,88,89,92,95,98,101,104,107,110,114,124,128,131,134,138,141,144,147,150,153,156,159,162,163,166,167,170,173,176,179,182,185,188,189,192,195,198,201,204,205,208,209,212,215,218,221,224,227,230,234	V _{SS}	GND	–	Ground Plane
Other Pins				
19,20,44,45,86,87,105,106,139,140,164,165,206,207,225,226	RFU	NC	–	Not connected
136	VID0	–	–	Voltage ID
16	VID1	–	–	
137	Test	AI	–	VREF

TABLE 6
Abbreviations for Buffer Type

Abbreviation	Description
HSDL_15	High-Speed Differential Point-to-Point Link Interface at 1.5 V
LV-CMOS	Low Voltage CMOS
CMOS	CMOS Levels
OD	Open Drain. The corresponding pin has 2 operational states, active low and tristate, and allows multiple devices to share as a wire-OR.



HYS72T[64/128/256]4[00/20]HFD-[3S/3.7]-A

TABLE 7
Abbreviations for Pin Type

Abbreviation	Description
I	Standard input-only pin. Digital levels.
O	Output. Digital levels.
I/O	I/O is a bidirectional input/output signal.
AI	Input. Analog levels.
PWR	Power
GND	Ground
NU	Not Usable
NC	Not Connected



FIGURE 1
Pin Configuration for FB-DIMM (240 pin)

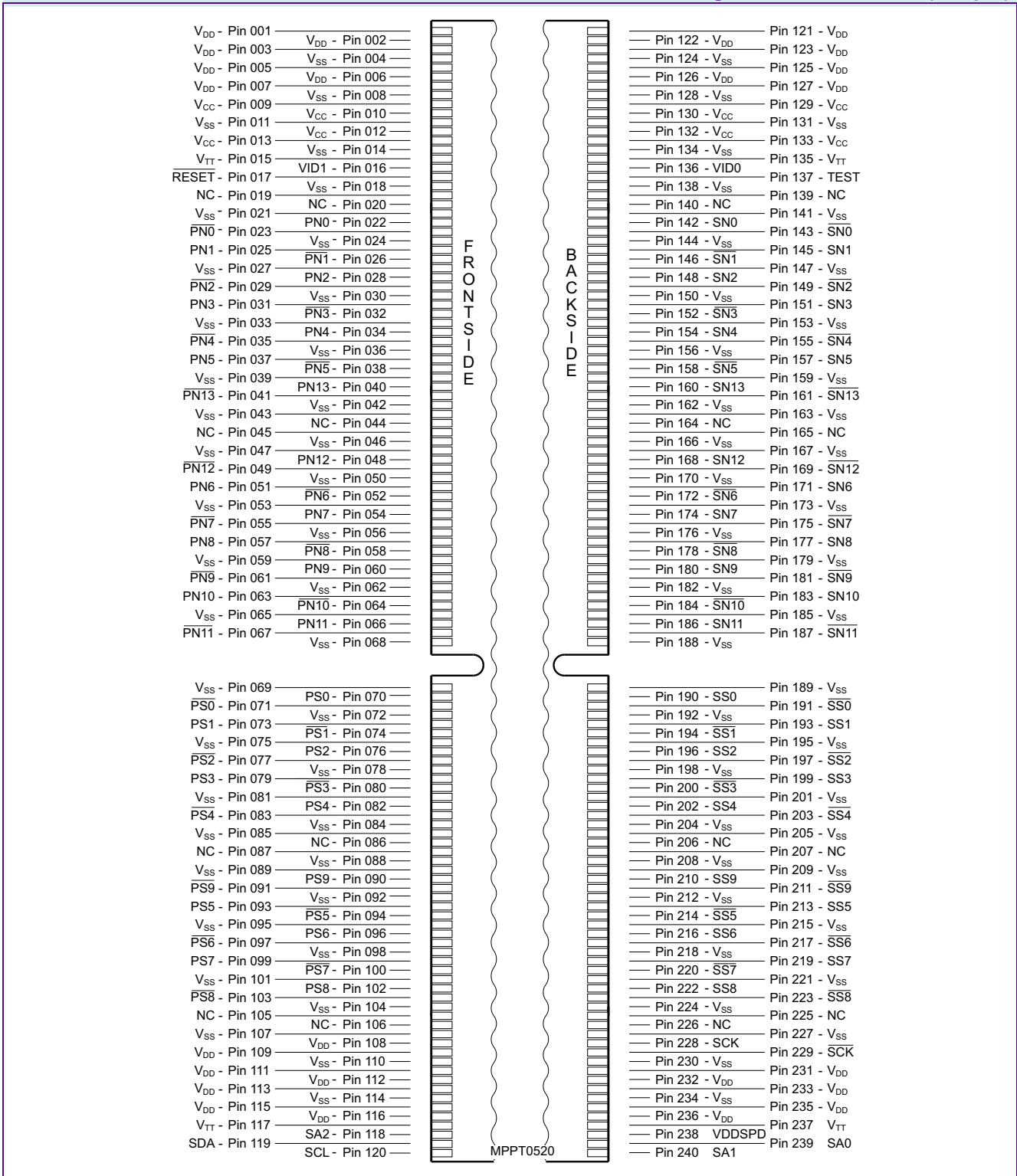



3 Basic Functionality

The Advanced Memory Buffer (AMB) reference design complies with the FB-DIMM Architecture and Protocol Specification.

3.1 Advanced Memory Buffer Functionality

The Advanced Memory Buffer will perform the following FB-DIMM channel functions:

- Supports channel initialization procedures as defined in the initialization chapter of the FB-DIMM Architecture and Protocol Specification to align the clocks and the frame boundaries, verify channel connectivity, and identify AMB DIMM position.
- Supports the forwarding of southbound and northbound frames, servicing requests directed to a specific AMB or DIMM, as defined in the protocol chapter, and merging the return data into the northbound frames.
- If the AMB resides on the last DIMM in the channel, the AMB initializes northbound frames.
- Detects errors on the channel and reports them to the host memory controller.
- Support the FB-DIMM configuration register set as defined in the register chapters.
- Acts as DRAM memory buffer for all read, write, and configuration accesses addressed to the DIMM.
- Provides a read buffer FIFO and a write buffer FIFO.
- Supports an SMBus protocol interface for access to the AMB configuration registers.
- Provides logic to support MEMBIST and IBIST Design for Test functions.
- Provides a register interface for the thermal sensor and status indicator.
- Functions as a repeater to extend the maximum length of FB-DIMM Links.

Transparent Mode for DRAM Test Support

In this mode, the Advanced Memory Buffer will provide lower speed tester access to DRAM pins through the FB-DIMM I/O pins. This allows the tester to send an arbitrary test pattern to the DRAMs. Transparent mode only supports a maximum DRAM frequency equivalent to DDR2 400. Transparent mode functionality:

- Reconfigures FB-DIMM inputs from differential high speed link receivers to two single ended lower speed receivers (~200 MHz)
- These inputs directly control DDR2 Command/Address and input data that is replicated to all DRAMs
- Uses low speed direct drive FB-DIMM outputs to bypass high speed Parallel/Serial circuitry and provide test results back to tester

DDR2 SDRAM Interface

- Supports DDR2 at speeds of 533, 667MT/s
- Supports 256Mb, 512Mb and 1Gb devices in x4 and x8 configurations
- 72-bit DDR2 SDRAM memory array

3.2 Interfaces

Figure 2 illustrates the Advanced Memory Buffer and all of its interfaces. They consist of two FB-DIMM links, one DDR2 channel and an SMBus interface. Each FB-DIMM link connects the Advanced Memory Buffer to a host memory

controller or an adjacent FB-DIMM. The DDR2 channel supports direct connection to the DDR2 SDRAMs on a Fully Buffered DIMM.



FIGURE 2

Block Diagram Advanced Memory Buffer Interface

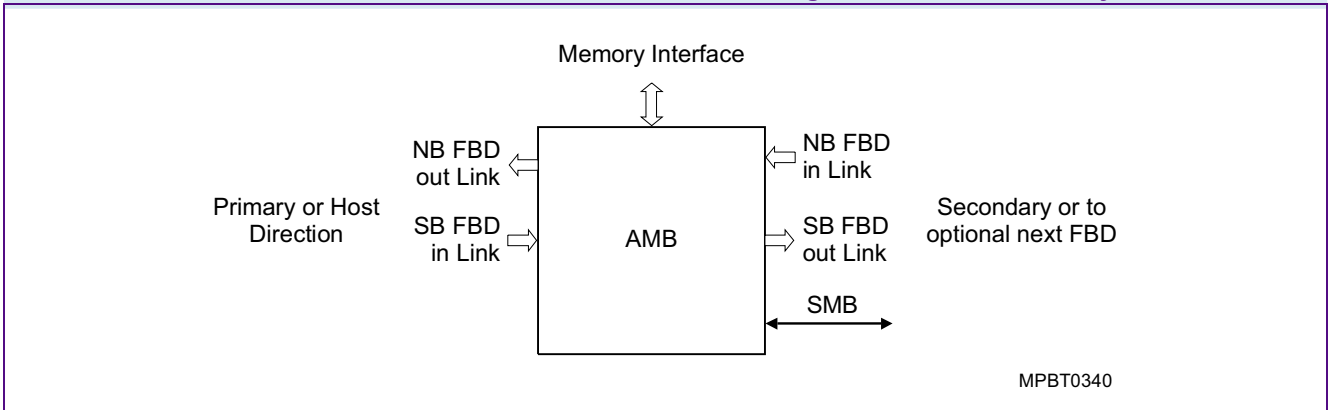

Interface Topology

The FB-DIMM channel uses a daisy-chain topology to provide expansion from a single DIMM per channel to up to 8 DIMMs per channel. The host sends data on the southbound link to the first DIMM where it is received and redriven to the second DIMM. On the southbound data path each DIMM receives the data and again re-drives the data to the next DIMM until the

last DIMM receives the data. The last DIMM in the chain initiates the transmission of data in the direction of the host (a.k.a. northbound). On the northbound data path each DIMM receives the data and re-drives the data to the next DIMM until the host is reached.

FIGURE 3

Block Diagram of Channel Southbound and Northbound Paths

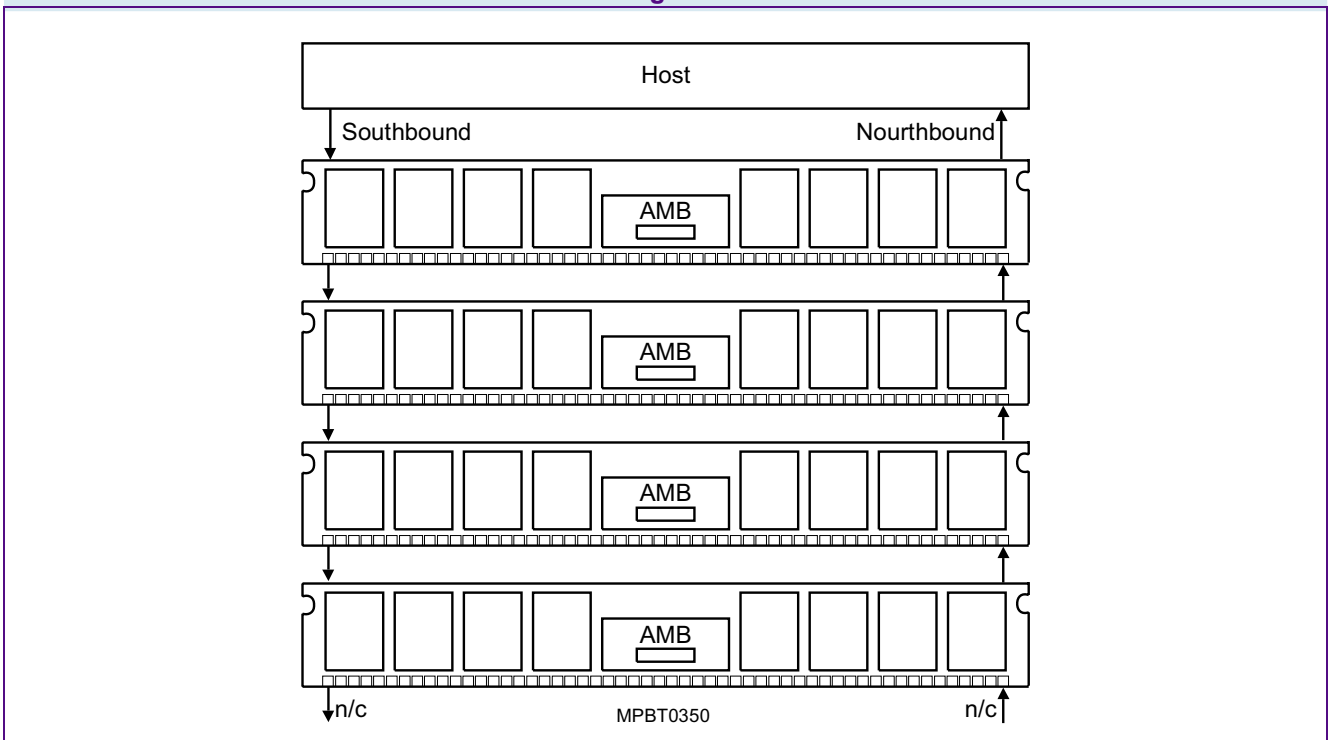



3.3 High-Speed Differential Point-to-Point Link (at 1.5 V) Interfaces

The Advanced Memory Buffer supports one FB-DIMM Channel consisting of two bidirectional link interfaces using highspeed differential point-to-point electrical signaling. The southbound input link is 10 lanes wide and carries commands and write data from the host memory controller or the adjacent DIMM in the host direction. The southbound output link forwards this same data to the next FB-DIMM. The northbound input link is 14 lanes wide and carries read return data or status information from the next FB-DIMM in the chain back towards the host. The northbound output link forwards this information back towards the host and multiplexes in any

read return data or status information that is generated internally. Data and commands sent to the DRAMs travel southbound on 10 primary differential signal line pairs. Data received from the DRAMs and status information travel northbound on 14 primary differential pairs. Data and commands sent to the adjacent DIMM upstream are repeated and travel further southbound on 10 secondary differential pairs. Data and status information received from the adjacent DIMM upstream travel further northbound on 14 secondary differential pairs.

3.3.1 DDR2 Channel

The DDR2 channel on the Advanced Memory Buffer supports direct connection to DDR2 SDRAMs. The DDR2 channel supports two ranks of eight banks with 16 row/column request, 64 data, and eight check-bit signals. There are two copies of address and command signals to support DIMM routing and electrical requirements. Four transfer bursts are driven on the data and check-bit lines at 800 MHz.

Propagation delays between read data/check-bit strobe lanes on a given channel can differ. Each strobe can be calibrated by hardware state machines using write/read trial and error. Hardware aligns the read data and check-bits to a single core clock. The Advanced Memory Buffer provides four copies of the command clock phase references (CLK[3:0]) and write data/check-bit strobes (DQSs) for each DRAM nibble.

3.3.2 SMBus Slave Interface

The Advanced Memory Buffer supports an SMBus interface to allow system access to configuration registers independent of the FB-DIMM link. The Advanced Memory Buffer will never be a master on the SMBus, only a slave. Serial SMBus data transfer is supported at 100 kHz. SMBus access to the Advanced Memory Buffer may be a requirement to boot and

to set link strength, frequency and other parameters needed to insure robust configurations. It is also required for diagnostic support when the link is down. The SMBus address straps located on the DIMM connector are used by the unique ID.

3.3.3 Channel Latency

FB-DIMM channel latency is measured from the time a read request is driven on the FB-DIMM channel pins to the time when the first 16 bytes (2nd chunk) of read completion data is sampled by the memory controller. When not using the Variable Read Latency capability, the latency for a specific DIMM on a channel is always equal to the latency for any other DIMM on that channel. However, the latency for each DIMM in a specific configuration with some number of DIMMs installed may not be equal to the latency for each FB-DIMM in a configuration with some different number of DIMMs installed. As more DIMMs are added to the channel, additional latency is required to read from each DIMM on the

channel. Because the channel is based on the point-to-point interconnection of buffer components between DIMMs, memory requests are required to travel through N-1 buffers before reaching the Nth buffer. The result is that a 4 DIMM channel configuration will have greater idle read latency compared to a 1 DIMM channel configuration. The Variable Read Latency capability can be used to reduce latency for DIMMs closer to the host. The idle latencies listed in this section are representative of what might be achieved in typical AMB designs. Actual implementations with latencies less than the values listed will have higher application performance and vice versa.



3.3.4 Peak Theoretical Channel Throughput

An FB-DIMM channel transfers read completion data on the Northbound data connection. 144 bits of data are transferred for every Northbound data frame. This matches the 18-byte data transfer of an ECC DDR DRAM in a single DRAM command clock. A DRAM burst of 8 from a single channel or a DRAM burst of four from two lock stepped channels provides a total of 72 bytes of data (64 bytes plus 8 bytes ECC). The FB-DIMM frame rate matches the DRAM command clock because of the fixed 6:1 ratio of the FB-DIMM channel clock to the DRAM command clock. Therefore, the Northbound data connection will exhibit the same peak theoretical throughput as a single DRAM channel. For example, when using DDR2 533 DRAMs, the peak theoretical bandwidth of the Northbound data connection is 4.267 GB/sec. Write data is transferred on the Southbound command and data connection, via Command+Wdata frames. 72 bits of data are transferred for every Command+Wdata frame. Two Command+Wdata frames match the 18-byte data transfer of an ECC DDR DRAM in a single DRAM command clock. A DRAM burst of 8 transfers

from a single channel, or a burst of 4 from two lock-step channels provides a total of 72 bytes of data (64 bytes plus 8 bytes ECC). When the frame rate matches the DRAM command clock, the Southbound command and data connection will exhibit one half the peak theoretical throughput of a single DRAM channel. For example, when using DDR2 533 DRAMs, the peak theoretical bandwidth of the Southbound command and data connection is 2.133 GB/sec. The total peak theoretical throughput for a single FB-DIMM channel is defined as the sum of the peak theoretical throughput of the Northbound data connection and the Southbound command and data connection. When the frame rate matches the DRAM command clock, this is equal to 1.5 times the peak theoretical throughput of a single DRAM channel. For example, when using DDR2 533 DRAMs, the peak theoretical throughput of a single DDR2-533 channel would be 4.267 GB/sec., while the peak theoretical throughput of the entire FB-DIMM PC4200F channel would be 6.4GB/sec.

3.4 Hot-add

The FB-DIMM channel does not provide a mechanism to automatically detect and report the addition of a new DIMM south of the currently active last DIMM. It is assumed the system will be notified through some means of the addition of one or more new DIMMs so that specific commands can be sent to the host controller to initialize the newly added

DIMM(s) and perform a Hot-Add Reset to bring them into the channel timing domain. It should be noted that the power to the DIMM socket must be removed before a “hot-add” DIMM is inserted or removed. Applying or removing the power to a DIMM socket is a system platform function.

3.5 Hot-remove

In order to accomplish removal of DIMMs the host must perform a Fast Reset sequence targeted at the last DIMM that will be retained on the channel. The Fast Reset re-establish the appropriate last DIMM so that the Southbound Tx outputs of the last active DIMM and the Southbound and Northbound outputs of the DIMMs beyond the last active DIMM are disabled. Once the appropriate outputs are disabled the

system can coordinate the procedure to remove power in preparation for physical removal of the DIMM if needed. It should be noted that the power to the DIMM socket must be removed before a “hot-add” DIMM is inserted or removed. Applying or removing the power to a DIMM socket is a system platform function.

3.6 Hot-replace

Hot replace of DIMM is accomplished through combining the Hot-Remove and Hot-Add process.



4 Electrical Characteristics

4.1 Operating Conditions

TABLE 8
Absolute Maximum Ratings

Symbol	Parameter	Rating		Unit	Note
		Min.	Max.		
V_{DD}	Voltage on V_{DD} pin relative to V_{SS}	-0.5	+2.3	V	1)
V_{CC}	Voltage on V_{CC} pin relative to V_{SS}	-0.3	1.75	V	
V_{DDQ}	Voltage on V_{DDQ} pin relative to V_{SS}	-0.5	+2.3	V	1)2)
V_{DDL}	Voltage on V_{DDL} pin relative to V_{SS}	-0.5	+2.3	V	1)2)
V_{IN}, V_{OUT}	Voltage on any pin relative to V_{SS}	-0.3	+1.75	V	1)
T_{STG}	Storage Temperature	-55	+100	°C	1)2)
V_{TT}	Voltage on V_{TT} pin relative to V_{SS}	-0.5	2.3	V	

1) When V_{DD} and V_{DDQ} and V_{DDL} are less than 500 mV; V_{REF} may be equal to or less than 300 mV.

2) Storage Temperature is the case surface temperature on the center/top side of the DRAM.

Attention: Stresses greater than those listed under “Absolute Maximum Ratings” may cause permanent damage to the device. This is a stress rating only and functional operation of the device at these or any other conditions above those indicated in the operational sections of this specification is not implied. Exposure to absolute maximum rating conditions for extended periods may affect reliability.

TABLE 9
Operating Temperature Range

Symbol	Parameter	Values		Unit	Note
		Min.	Max.		
T_{CASE}	DRAM Component Case Temperature Range	0	+95	°C	1)2)3)
T_{CASE}	AMB Component Case Temperature Range	0	+110	°C	1)

1) Within the DRAM Component Case Temperature range all DRAM specification will be supported.

2) Self-Refresh period is hard-coded in the DRAMs and therefore it is imperative that the system ensures the DRAM is below 85 °C case temperature before initiating self-refresh operation.

3) Above 85 °C DRAM case temperature the Auto-Refresh command interval has to be reduced to $tREFI = 3.9 \mu s$.



TABLE 10
Supply Voltage Levels and DC Operating Conditions

Parameter	Symbol	Limit Values			Unit	Note
		Min.	Nom.	Max.		
AMB Supply Voltage	V_{CC}	1.455	1.5	1.575	V	
DRAM Supply Voltage	V_{DD}	1.7	1.8	1.9	V	
Termination Voltage	V_{TT}	$0.48 \times V_{DD}$	$0.50 \times V_{DD}$	$0.52 \times V_{DD}$	V	
EEPROM Supply Voltage	V_{DDSPD}	3.0	3.3	3.6	V	
DC Input Logic High (SPD)	$V_{IH(DC)}$	2.1	—	V_{DDSPD}	V	1)
DC Input Logic Low (SPD)	$V_{IL(DC)}$	—	—	0.8	V	1)
DC Input Logic High (RESET)	$V_{IH(DC)}$	1.0	—	—	V	2)
DC Input Logic Low (RESET)	$V_{IL(DC)}$	—	—	+0.5	V	1)
Leakage Current (RESET)	I_L	-90	—	+90	μA	2)
Leakage Current (Link)	I_L	-5	—	+5	μA	3)

- 1) applies for SMB and SPD Bus Signals.
- 2) applies for AMB CMOS Signal RESET.
- 3) for all other AMB related DC parameters, please refer to the High Speed Differential Link Interface Specifications.

TABLE 11
Timing Parameters

Parameter	Symbol	Min.	Typ.	Max.	Units	Note
EI Assertion Pass-Thru Timing	$t_{EI \text{ Propagate}}^t$	—	—	4	clks	
EI Deassertion Pass-Thru Timing	t_{EID}	—	—	Bitlock	clks	2)
EI Assertion Duration	t_{EI}	100	—	—	clks	1)2)
FBD Cmd to DDR Clk out that latches Cmd	—	—	8.1	—	ns	3)
FBD Cmd to DDR Write	—	—	TBD	—	ns	
DDR Read to FBD (last DIMM)	—	—	5.0	—	ns	4)
Resample Pass-Thru time	—	—	1.075	—	ns	
Resynch Pass-Thru time	—	—	2.075	—	ns	
Bit Lock Interval	$t_{BitLock}$	—	—	119	frames	1)
Frame Lock Interval	$t_{FrameLock}$	—	—	154	frames	1)

- 1) Defined in FB-DIMM Architecture and Protocol Spec
- 2) Clocks defined as core clocks = 2x SCK input
- 3) @ DDR2-667 - measured from beginning of frame at southbound input to DDR clock output that latches the first command of a frame to the DRAMs
- 4) @ DDR2-667 - measured from latest DQS input to AMB to start of matching data frame at northbound FB-DIMM outputs



HYS72T[64/128/256]4[00/20]HFD-[3S/3.7]-A

TABLE 12
Environmental Parameters

Parameter	Symbol	Rating	Units	Note
Operating Temperature	T _{OPR}	See Note	—	1)
Operating Humidity (relative)	H _{OPR}	10 to 90	%	2)
Storage Temperature	T _{STG}	-50 to +100	°C	2)
Storage Humidity (without condensation)	H _{STG}	5 to 95	%	2)
Barometric pressure (operating)	P _{BAR}	3050	m	2)
Barometric pressure (storage)	P _{BAR}	14240	m	2)

- 1) The designer must meet the case temperature specifications for individual module components.
- 2) Stresses greater than those listed may cause permanent damage to the device. This is a stress rating only and the device functional operation at or above the conditions indicated is not implied. Exposure to absolute maximum rating conditions for extended periods may affect reliability.



5 Current Spec. and Conditions

The following table provides an overview of the measurement conditions.

TABLE 13
 I_{DD} Measurement Conditions

Parameter	Symbol
Idle Current, single or last DIMM L0 state, idle (0 BW) Primary channel enabled, Secondary channel disabled CKE high. Command and address lines stable. DRAM clock active	$I_{CC_Idle_0}$ $I_{DD_Idle_0}$
Idle Current, first DIMM L0 state, idle (0 BW) Primary and Secondary channels enabled. CKE high. Command and address lines stable. DRAM clock active	$I_{CC_Idle_1}$ $I_{DD_Idle_1}$
Active Power L0 state 50% DRAM BW, 67% read, 33% write. Primary and Secondary channels enabled. DRAM clock active, CKE high.	$I_{CC_Active_1}$ $I_{DD_Active_1}$
Active Power, data pass through L0 state 50% DRAM BW to downstream DIMM, 67% read, 33% write. Primary and Secondary channels enabled. CKE high. Command and address lines stable. DRAM clock active.	$I_{CC_Active_2}$ $I_{DD_Active_2}$
Training Primary and Secondary channels enabled. 100% toggle on all channels lanes. DRAMs idle (0 BW). CKE high. Command and address lines stable. DRAM clock active.	$I_{CC_Training}$ $I_{DD_Training}$
IBIST Over all IBIST modes DRAM Idle (0 BW) Primary channel Enabled Secondary channel Enabled CKE high. Command and Address lines stable DRAM clock active	I_{CC_IBIST} I_{DD_IBIST}



Parameter	Symbol
MemBIST Over all MemBIST modes >50% DRAM BW (as dictated by the AMB) Primary channel Enabled Secondary channel Enabled CKE high. Command and Address lines stable DRAM clock active	$I_{CC_MEMBIST}$ $I_{DD_MEMBIST}$
Electrical Idle DRAM Idle (0 BW) Primary channel Disabled Secondary channel Disabled CKE low. Command and Address lines Floated DRAM clock active, ODT and CKE driven low	I_{CC_EI} I_{DD_EI}

Notes

1. Primary channel Drive strength at 100 % with De-emphasis at -6.5 dB
2. Secondary channel drive strength at 60 % with De-emphasis at -3 dB when enabled.
3. Address and Data fields provide a 50 % toggle rate on DRAM data and link lanes.
4. Burst Length = 4.
5. 10 lanes southbound and 14 lanes northbound are enabled and active (12 lanes NB if non-ECC DIMM).
6. Modeled with 27 Ω termination for command, address, and clocks, and 47 Ω termination for control.
7. Termination is referenced to $V_{TT} = V_{DD} / 2$.



5.1 I_{CC}/I_{DD} Conditions

In the following table you can find the Measurement Conditions and Power Supply Currents¹⁾²⁾

TABLE 14

I_{CC}/I_{DD} Specification for PC2-5300F

Product Type	HYS72T64400HFD-3S-A	HYS72T128420HFD-3S-A	HYS72T256420HFD-3S-A	Unit	Note
Speed Grade	PC2-5300F	PC2-5300F	PC2-5300F		
Symbol	Max.	Max.	Max.		
ICC_Idle_0	2.09	2.91	2.09	A	
PCC_Idle_0	3.09	4.28	3.09	W	
IDD_Idle_0	0.73	0.97	1.69	A	
PDD_Idle_0	1.3	1.73	3.02	W	
ITOT_Idle_0	2.81	3.88	3.78	A	
PTOT_Idle_0	4.38	6.01	6.11	W	
ICC_Idle_1	2.94	2.9	2.94	A	
PCC_Idle_1	4.3	4.25	4.31	W	
IDD_Idle_1	0.72	0.96	1.67	A	
PDD_Idle_1	1.29	1.72	2.97	W	
ITOT_Idle_1	3.66	3.86	4.61	A	
PTOT_Idle_1	5.59	5.96	7.27	W	
ICC_Active_1	3.08	3.38	3.1	A	
PCC_Active_1	4.5	4.44	4.53	W	
IDD_Active_1	2	0.94	3.56	A	
PDD_Active_1	3.56	4.09	6.3	W	
ITOT_Active_1	5.07	4.32	6.66	A	
PTOT_Active_1	8.05	8.53	10.81	W	
ICC_Active_2	3	3	3.06	A	
PCC_Active_2	4.48	4.49	4.57	W	
IDD_Active_2	0.69	0.69	1.96	A	
PDD_Active_2	1.22	1.22	3.45	W	

1) Measured currents on raw card A/B/H/D according to the INTEL/ JEDEC specification. The measurements are done in a INTEL Blackford system.

2) The Power is calculated as follows: $P_{cc} = V_{cc} \times I_{cc}$ where $V_{cc} = 1.5 V$



HYS72T[64/128/256]4[00/20]HFD-[3S/3.7]-A

Product Type	HYS72T64400HFD-3S-A	HYS72T128420HFD-3S-A	HYS72T256420HFD-3S-A	Unit	Note
Speed Grade	PC2-5300F	PC2-5300F	PC2-5300F		
Symbol	Max.	Max.	Max.		
ITOT_Active_2	3.75	3.75	5.09	A	
PTOT_Active_2	5.76	5.75	8.08	W	
ICC_IBIST	3.43	2.1	3.44	A	
PCC_IBIST	5.01	4.94	5.01	W	
IDD_IBIST	0.69	0.17	1.59	A	
PDD_IBIST	1.23	1.67	2.83	W	
ITOT_IBIST	4.11	2.26	5.02	A	
PTOT_IBIST	6.23	6.61	7.84	W	
ICC_Training	2.99	3.04	2.98	A	
PCC_Training	4.37	4.32	4.35	W	
IDD_Trainig	0.69	2.3	1.61	A	
PDD_Training	1.23	1.68	2.88	W	
ITOT_Trainig	3.67	5.33	4.59	A	
PTOT_Training	5.59	5.98	7.22	W	
ICC_EI	2.13	3.02	2.12	A	
PCC_EI	3.13	3.09	3.11	W	
IDD_EI	0.14	0.69	0.24	A	
PDD_EI	0.25	0.29	0.43	W	
ITOT_EI	2.26	3.71	2.35	A	
PTOT_EI	3.37	3.38	3.53	W	
ICC_MEMBIST	2.96	2.92	2.98	A	
PCC_MEMBIS T	4.33	4.28	4.35	W	
IDD_MEMBIST	1.96	2.2	3.58	A	
PDD_MEMBIS T	3.49	3.92	6.35	W	
ITOT_MEMBIS T	4.91	5.12	6.56	A	
PTOT_MEMBI ST	7.81	8.19	10.69	W	



TABLE 15

I_{CC}/I_{DD} Specification for PC2-4200F

Product Type	HYS72T64400HFD-3.7-A	HYS72T128420HFD-3.7-A	HYS72T256420HFD-3.7-A	Unit	Note
Speed Grade	PC2-4200F	PC2-4200F	PC2-4200F		
Symbol	Max.	Max.	Max.		
ICC_Idle_0	1.78	1.75	1.78	A	
PCC_Idle_0	2.63	2.59	2.63	W	
IDD_Idle_0	0.69	0.91	1.58	A	
PDD_Idle_0	1.24	1.62	2.82	W	
ITOT_Idle_0	2.46	2.65	3.35	A	
PTOT_Idle_0	3.86	4.2	5.44	W	
ICC_Idle_1	2.51	2.49	2.52	A	
PCC_Idle_1	3.69	3.65	3.7	W	
IDD_Idle_1	0.69	0.9	1.55	A	
PDD_Idle_1	1.23	1.61	2.76	W	
ITOT_Idle_1	3.19	3.38	4.06	A	
PTOT_Idle_1	4.91	5.25	6.45	W	
ICC_Active_1	2.65	2.88	2.66	A	
PCC_Active_1	3.89	3.83	3.91	W	
IDD_Active_1	2.09	0.87	3.64	A	
PDD_Active_1	3.71	4.16	6.44	W	
ITOT_Active_1	4.73	3.75	6.3	A	
PTOT_Active_1	7.59	7.97	10.33	W	
ICC_Active_2	2.59	2.59	2.62	A	
PCC_Active_2	3.88	3.88	3.94	W	
IDD_Active_2	0.65	0.65	2.02	A	
PDD_Active_2	1.16	1.15	3.55	W	
ITOT_Active_2	3.31	3.33	4.74	A	
PTOT_Active_2	5.1	5.11	7.58	W	
ICC_IBIST	2.92	1.69	2.92	A	
PCC_IBIST	4.28	4.22	4.28	W	
IDD_IBIST	0.65	0.17	1.47	A	



HYS72T[64/128/256]4[00/20]HFD-[3S/3.7]-A

Product Type	HYS72T64400HFD-3.7-A	HYS72T128420HFD-3.7-A	HYS72T256420HFD-3.7-A	Unit	Note
Speed Grade	PC2-4200F	PC2-4200F	PC2-4200F		
Symbol	Max.	Max.	Max.		
PDD_IBIST	1.16	1.56	2.61	W	
ITOT_IBIST	3.57	1.85	4.38	A	
PTOT_IBIST	5.44	5.78	6.89	W	
ICC_Training	2.56	2.61	2.56	A	
PCC_Training	3.76	3.71	3.76	W	
IDD_Trainig	0.65	2.34	1.47	A	
PDD_Training	1.16	1.56	2.62	W	
ITOT_Trainig	3.21	4.94	4.03	A	
PTOT_Training	4.92	5.27	6.38	W	
ICC_EI	1.71	2.61	1.71	A	
PCC_EI	2.53	2.5	2.52	W	
IDD_EI	0.14	0.66	0.24	A	
PDD_EI	0.24	0.29	0.43	W	
ITOT_EI	1.85	3.26	1.94	A	
PTOT_EI	2.77	2.78	2.95	W	
ICC_MEMBIST	2.54	2.51	2.54	A	
PCC_MEMBIS T	3.72	3.68	3.73	W	
IDD_MEMBIST	1.95	2.2	3.4	A	
PDD_MEMBIS T	3.47	3.91	6.03	W	
ITOT_MEMBIS T	4.48	4.7	5.93	A	
PTOT_MEMBI ST	7.18	7.58	9.74	W	



6 SPD Codes

This chapter lists all hexadecimal byte values stored in the EEPROM of the products described in this data sheet. SPD stands for serial presence detect. All values with XX in the table are module specific bytes which are defined during production.

List of SPD Code Tables

- Table 16 “PC2-5300F-555” on Page 25
- Table 17 “PC2-4200F-444” on Page 30

TABLE 16
PC2-5300F-555

Product Type		HYS72T64400HFD-3S-A	HYS72T128420HFD-3S-A	HYS72T256420HFD-3S-A
Organization		512MB	1 GByte	2 GByte
		×72	×72	×72
		1 Rank (×8)	2 Ranks (×8)	2 Ranks (×4)
Label Code		PC2-5300F-555	PC2-5300F-555	PC2-5300F-555
JEDEC SPD Revision		Rev. 1.1	Rev. 1.1	Rev. 1.1
Byte#	Description	HEX	HEX	HEX
0	SPD Size CRC / Total / Used	92	92	92
1	SPD Revision	11	11	11
2	Key Byte / DRAM Device Type	09	09	09
3	Voltage Level of this Assembly	12	12	12
4	SDRAM Addressing	44	44	48
5	Module Physical Attributes	23	23	23
6	Module Type	07	07	07
7	Module Organization	09	11	10
8	Fine Timebase (FTB) Dividend and Divisor	00	00	00
9	Medium Timebase (MTB) Dividend	01	01	01
10	Medium Timebase (MTB) Divisor	04	04	04
11	$t_{CK,MIN}$ (min. SDRAM Cycle Time)	0C	0C	0C
12	$t_{CK,MAX}$ (max. SDRAM Cycle Time)	20	20	20
13	CAS Latencies Supported	33	33	33



HYS72T[64/128/256]4[00/20]HFD-[3S/3.7]-A

Product Type		HYS72T64400HFD-3S-A	HYS72T128420HFD-3S-A	HYS72T256420HFD-3S-A
Organization		512MB	1 GByte	2 GByte
		×72	×72	×72
		1 Rank (×8)	2 Ranks (×8)	2 Ranks (×4)
Label Code		PC2-5300F-555	PC2-5300F-555	PC2-5300F-555
JEDEC SPD Revision		Rev. 1.1	Rev. 1.1	Rev. 1.1
Byte#	Description	HEX	HEX	HEX
14	$t_{CAS.MIN}$ (min. CAS Latency Time)	3C	3C	3C
15	Write Recovery Values Supported (WR)	42	42	42
16	$t_{WR.MIN}$ (Write Recovery Time)	3C	3C	3C
17	Write Latency Times Supported	72	72	72
18	Additive Latency Times Supported	50	50	50
19	$t_{RCD.MIN}$ (min. RAS# to CAS# Delay)	3C	3C	3C
20	$t_{RRD.MIN}$ (min. Row Active to Row Active Delay)	1E	1E	1E
21	$t_{RP.MIN}$ (min. Row Precharge Time)	3C	3C	3C
22	t_{RAS} and t_{RC} Extension	00	00	00
23	$t_{RAS.MIN}$ (min. Active to Precharge Time)	B4	B4	B4
24	$t_{RC.MIN}$ (min. Active to Active / Refresh Time)	F0	F0	F0
25	$t_{RFC.MIN}$ LSB (min. Refresh Recovery Time Delay)	A4	A4	A4
26	$t_{RFC.MIN}$ MSB (min. Refresh Recovery Time Delay)	01	01	01
27	$t_{WTR.MIN}$ (min. Internal Write to Read Cmd Delay)	1E	1E	1E
28	$t_{RTP.MIN}$ (min. Internal Read to Precharge Cmd Delay)	1E	1E	1E
29	Burst Lengths Supported	03	03	03
30	Terminations Supported	07	07	07
31	Drive Strength Supported	01	01	01
32	t_{REFI} (avg. SDRAM Refresh Period)	C2	C2	C2
33	$T_{CASE.MAX}$ Delta / ΔT_{4R4W} Delta	53	53	53
34	Psi(T-A) DRAM	78	78	78
35	ΔT_0 (DT0) DRAM	48	48	48
36	ΔT_{2Q} (DT2Q) DRAM	2E	2E	2E
37	ΔT_{2P} (DT2P) DRAM	26	26	26
38	ΔT_{3N} (DT3N) DRAM	26	26	26
39	ΔT_{4R} (DT4R) / ΔT_{4R4W} Sign (DT4R4W) DRAM	4A	4A	4A



HYS72T[64/128/256]4[00/20]HFD-[3S/3.7]-A

Product Type		HYS72T64400HFD-3S-A	HYS72T128420HFD-3S-A	HYS72T256420HFD-3S-A
Organization		512MB	1 GByte	2 GByte
		×72	×72	×72
		1 Rank (×8)	2 Ranks (×8)	2 Ranks (×4)
Label Code		PC2-5300F-555	PC2-5300F-555	PC2-5300F-555
JEDEC SPD Revision		Rev. 1.1	Rev. 1.1	Rev. 1.1
Byte#	Description	HEX	HEX	HEX
40	ΔT_{5B} (DT5B) DRAM	20	20	20
41	ΔT_7 (DT7) DRAM	22	22	22
42 - 78	Not used	00	00	00
79	FBDIMM ODT Values	01	22	22
80	Not used	00	00	00
81	Channel Protocols Supported LSB	02	02	02
82	Channel Protocols Supported MSB	00	00	00
83	Back-to-Back Access Turnaround Time	00	00	00
84	AMB Read Access Delay for DDR2-800	36	36	36
85	AMB Read Access Delay for DDR2-667	36	36	36
86	AMB Read Access Delay for DDR2-533	34	34	34
87	Psi(T-A) AMB	2A	2A	2A
88	ΔT_{Idle_0} (DT Idle_0) AMB	56	56	62
89	ΔT_{Idle_1} (DT Idle_1) AMB	6B	6B	77
90	ΔT_{Idle_2} (DT Idle_2) AMB	5C	5C	61
91	ΔT_{Active_1} (DT Active_1) AMB	91	91	9F
92	ΔT_{Active_2} (DT Active_2) AMB	76	76	84
93	ΔT_{L0s} (DT L0s) AMB	00	00	00
94 - 97	Not used	00	00	00
98	AMB Junction Temperature Maximum (T_{jmax})	1F	1F	1F
99	Category Byte	CA	CA	CA
100	Not used	00	00	00
101	AMB Personality Bytes: Pre-initialization (1)	40	40	40
102	AMB Personality Bytes: Pre-initialization (2)	C0	C0	C0
103	AMB Personality Bytes: Pre-initialization (3)	12	12	12
104	AMB Personality Bytes: Pre-initialization (4)	44	44	44



HYS72T[64/128/256]4[00/20]HFD-[3S/3.7]-A

Product Type		HYS72T64400HFD-3S-A	HYS72T128420HFD-3S-A	HYS72T256420HFD-3S-A
Organization		512MB	1 GByte	2 GByte
		×72	×72	×72
		1 Rank (×8)	2 Ranks (×8)	2 Ranks (×4)
Label Code		PC2-5300F-555	PC2-5300F-555	PC2-5300F-555
JEDEC SPD Revision		Rev. 1.1	Rev. 1.1	Rev. 1.1
Byte#	Description	HEX	HEX	HEX
105	AMB Personality Bytes: Pre-initialization (5)	9C	9C	9C
106	AMB Personality Bytes: Pre-initialization (6)	30	30	30
107	AMB Personality Bytes: Post-initialization (1)	60	60	60
108	AMB Personality Bytes: Post-initialization (2)	33	33	33
109	AMB Personality Bytes: Post-initialization (3)	60	60	60
110	AMB Personality Bytes: Post-initialization (4)	1B	1B	1B
111	AMB Personality Bytes: Post-initialization (5)	60	60	60
112	AMB Personality Bytes: Post-initialization (6)	1B	1B	1B
113	AMB Personality Bytes: Post-initialization (7)	60	60	60
114	AMB Personality Bytes: Post-initialization (8)	1B	1B	1B
115	AMB Manufacturers JEDEC ID Code LSB	80	80	80
116	AMB Manufacturers JEDEC ID Code MSB	B3	B3	B3
117	DIMM Manufacturers JEDEC ID Code LSB	85	85	85
118	DIMM Manufacturers JEDEC ID Code MSB	51	51	51
119	Module Manufacturing Location	xx	xx	xx
120	Module Manufacturing Date Year	xx	xx	xx
121	Module Manufacturing Date Week	xx	xx	xx
122 - 125	Module Serial Number	xx	xx	xx
126	Cyclical Redundancy Code LSB	EC	D0	09
127	Cyclical Redundancy Code MSB	D5	DD	68
128	Module Product Type, Char #1	37	37	37
129	Module Product Type, Char #2	32	32	32
130	Module Product Type, Char #3	54	54	54
131	Module Product Type, Char #4	36	31	32
132	Module Product Type, Char #5	34	32	35



HYS72T[64/128/256]4[00/20]HFD-[3S/3.7]-A

Product Type		HYS72T64400HFD-3S-A	HYS72T128420HFD-3S-A	HYS72T256420HFD-3S-A
Organization		512MB	1 GByte	2 GByte
		×72	×72	×72
		1 Rank (×8)	2 Ranks (×8)	2 Ranks (×4)
Label Code		PC2-5300F-555	PC2-5300F-555	PC2-5300F-555
JEDEC SPD Revision		Rev. 1.1	Rev. 1.1	Rev. 1.1
Byte#	Description	HEX	HEX	HEX
133	Module Product Type, Char #6	34	38	36
134	Module Product Type, Char #7	30	34	34
135	Module Product Type, Char #8	30	32	32
136	Module Product Type, Char #9	48	30	30
137	Module Product Type, Char #10	46	48	48
138	Module Product Type, Char #11	44	46	46
139	Module Product Type, Char #12	33	44	44
140	Module Product Type, Char #13	53	33	33
141	Module Product Type, Char #14	41	53	53
142	Module Product Type, Char #15	20	41	41
143	Module Product Type, Char #16	20	20	20
144	Module Product Type, Char #17	20	20	20
145	Module Product Type, Char #18	20	20	20
146	Module Revision Code	7x	7x	7x
147	Test Program Revision Code	xx	xx	xx
148	DRAM Manufacturers JEDEC ID Code LSB	85	85	85
149	DRAM Manufacturers JEDEC ID Code MSB	51	51	51
150	informal AMB content revision tag (MSB)	01	01	01
151	informal AMB content revision tag (LSB)	05	05	05
152 - 175	Not used	00	00	00
176 - 255	Blank for customer use	FF	FF	FF



TABLE 17
PC2-4200F-444

Product Type		HYS72T64400HFD-3.7-A	HYS72T128420HFD-3.7-A	HYS72T256420HFD-3.7-A
Organization		512MB	1 GByte	2 GByte
		×72	×72	×72
		1 Rank (×8)	2 Ranks (×8)	2 Ranks (×4)
Label Code		PC2-4200F-444	PC2-4200F-444	PC2-4200F-444
JEDEC SPD Revision		Rev. 1.1	Rev. 1.1	Rev. 1.1
Byte#	Description	HEX	HEX	HEX
0	SPD Size CRC / Total / Used	92	92	92
1	SPD Revision	11	11	11
2	Key Byte / DRAM Device Type	09	09	09
3	Voltage Level of this Assembly	12	12	12
4	SDRAM Addressing	44	44	48
5	Module Physical Attributes	23	23	23
6	Module Type	07	07	07
7	Module Organization	09	11	10
8	Fine Timebase (FTB) Dividend and Divisor	00	00	00
9	Medium Timebase (MTB) Dividend	01	01	01
10	Medium Timebase (MTB) Divisor	04	04	04
11	$t_{CK,MIN}$ (min. SDRAM Cycle Time)	0F	0F	0F
12	$t_{CK,MAX}$ (max. SDRAM Cycle Time)	20	20	20
13	CAS Latencies Supported	33	33	33
14	$t_{CAS,MIN}$ (min. CAS Latency Time)	3C	3C	3C
15	Write Recovery Values Supported (WR)	32	32	32
16	$t_{WR,MIN}$ (Write Recovery Time)	3C	3C	3C
17	Write Latency Times Supported	72	72	72
18	Additive Latency Times Supported	50	50	50
19	$t_{RCD,MIN}$ (min. RAS# to CAS# Delay)	3C	3C	3C
20	$t_{RRD,MIN}$ (min. Row Active to Row Active Delay)	1E	1E	1E
21	$t_{RP,MIN}$ (min. Row Precharge Time)	3C	3C	3C
22	t_{RAS} and t_{RC} Extension	00	00	00



HYS72T[64/128/256]4[00/20]HFD-[3S/3.7]-A

Product Type		HYS72T64400HFD-3.7-A	HYS72T128420HFD-3.7-A	HYS72T256420HFD-3.7-A
Organization		512MB	1 GByte	2 GByte
		×72	×72	×72
		1 Rank (×8)	2 Ranks (×8)	2 Ranks (×4)
Label Code		PC2-4200F-444	PC2-4200F-444	PC2-4200F-444
JEDEC SPD Revision		Rev. 1.1	Rev. 1.1	Rev. 1.1
Byte#	Description	HEX	HEX	HEX
23	$t_{RAS,MIN}$ (min. Active to Precharge Time)	B4	B4	B4
24	$t_{RC,MIN}$ (min. Active to Active / Refresh Time)	F0	F0	F0
25	$t_{RFC,MIN}$ LSB (min. Refresh Recovery Time Delay)	A4	A4	A4
26	$t_{RFC,MIN}$ MSB (min. Refresh Recovery Time Delay)	01	01	01
27	$t_{WTR,MIN}$ (min. Internal Write to Read Cmd Delay)	1E	1E	1E
28	$t_{RTP,MIN}$ (min. Internal Read to Precharge Cmd Delay)	1E	1E	1E
29	Burst Lengths Supported	03	03	03
30	Terminations Supported	07	07	07
31	Drive Strength Supported	01	01	01
32	t_{REFI} (avg. SDRAM Refresh Period)	C2	C2	C2
33	$T_{CASE,MAX}$ Delta / ΔT_{4R4W} Delta	51	51	51
34	Psi(T-A) DRAM	78	78	78
35	ΔT_0 (DT0) DRAM	3C	3C	3C
36	ΔT_{2Q} (DT2Q) DRAM	22	22	22
37	ΔT_{2P} (DT2P) DRAM	1E	1E	1E
38	ΔT_{3N} (DT3N) DRAM	1E	1E	1E
39	ΔT_{4R} (DT4R) / ΔT_{4R4W} Sign (DT4R4W) DRAM	34	34	34
40	ΔT_{5B} (DT5B) DRAM	1E	1E	1E
41	ΔT_7 (DT7) DRAM	20	20	20
42 - 78	Not used	00	00	00
79	FBDIMM ODT Values	01	22	22
80	Not used	00	00	00
81	Channel Protocols Supported LSB	02	02	02
82	Channel Protocols Supported MSB	00	00	00
83	Back-to-Back Access Turnaround Time	00	00	00
84	AMB Read Access Delay for DDR2-800	36	36	36



HYS72T[64/128/256]4[00/20]HFD-[3S/3.7]-A

Product Type		HYS72T64400HFD-3.7-A	HYS72T128420HFD-3.7-A	HYS72T256420HFD-3.7-A
Organization		512MB	1 GByte	2 GByte
		×72	×72	×72
		1 Rank (×8)	2 Ranks (×8)	2 Ranks (×4)
Label Code		PC2-4200F-444	PC2-4200F-444	PC2-4200F-444
JEDEC SPD Revision		Rev. 1.1	Rev. 1.1	Rev. 1.1
Byte#	Description	HEX	HEX	HEX
85	AMB Read Access Delay for DDR2-667	36	36	36
86	AMB Read Access Delay for DDR2-533	34	34	34
87	Psi(T-A) AMB	2A	2A	2A
88	ΔT_{Idle_0} (DT Idle_0) AMB	4C	4C	58
89	ΔT_{Idle_1} (DT Idle_1) AMB	61	61	6B
90	ΔT_{Idle_2} (DT Idle_2) AMB	50	50	54
91	ΔT_{Active_1} (DT Active_1) AMB	82	82	91
92	ΔT_{Active_2} (DT Active_2) AMB	69	69	78
93	ΔT_{LOs} (DT L0s) AMB	00	00	00
94 - 97	Not used	00	00	00
98	AMB Junction Temperature Maximum (T_{jmax})	1F	1F	1F
99	Category Byte	CA	CA	CA
100	Not used	00	00	00
101	AMB Personality Bytes: Pre-initialization (1)	40	40	40
102	AMB Personality Bytes: Pre-initialization (2)	C0	C0	C0
103	AMB Personality Bytes: Pre-initialization (3)	12	12	12
104	AMB Personality Bytes: Pre-initialization (4)	44	44	44
105	AMB Personality Bytes: Pre-initialization (5)	9C	9C	9C
106	AMB Personality Bytes: Pre-initialization (6)	30	30	30
107	AMB Personality Bytes: Post-initialization (1)	60	60	60
108	AMB Personality Bytes: Post-initialization (2)	33	33	33
109	AMB Personality Bytes: Post-initialization (3)	60	60	60
110	AMB Personality Bytes: Post-initialization (4)	1B	1B	1B
111	AMB Personality Bytes: Post-initialization (5)	60	60	60
112	AMB Personality Bytes: Post-initialization (6)	1B	1B	1B
113	AMB Personality Bytes: Post-initialization (7)	60	60	60



HYS72T[64/128/256]4[00/20]HFD-[3S/3.7]-A

Product Type		HYS72T64400HFD-3.7-A	HYS72T128420HFD-3.7-A	HYS72T256420HFD-3.7-A
Organization		512MB	1 GByte	2 GByte
		×72	×72	×72
		1 Rank (×8)	2 Ranks (×8)	2 Ranks (×4)
Label Code		PC2-4200F-444	PC2-4200F-444	PC2-4200F-444
JEDEC SPD Revision		Rev. 1.1	Rev. 1.1	Rev. 1.1
Byte#	Description	HEX	HEX	HEX
114	AMB Personality Bytes: Post-initialization (8)	1B	1B	1B
115	AMB Manufacturers JEDEC ID Code LSB	80	80	80
116	AMB Manufacturers JEDEC ID Code MSB	B3	B3	B3
117	DIMM Manufacturers JEDEC ID Code LSB	85	85	85
118	DIMM Manufacturers JEDEC ID Code MSB	51	51	51
119	Module Manufacturing Location	xx	xx	xx
120	Module Manufacturing Date Year	xx	xx	xx
121	Module Manufacturing Date Week	xx	xx	xx
122 - 125	Module Serial Number	xx	xx	xx
126	Cyclical Redundancy Code LSB	F8	C4	F9
127	Cyclical Redundancy Code MSB	A6	AE	13
128	Module Product Type, Char #1	37	37	37
129	Module Product Type, Char #2	32	32	32
130	Module Product Type, Char #3	54	54	54
131	Module Product Type, Char #4	36	31	32
132	Module Product Type, Char #5	34	32	35
133	Module Product Type, Char #6	34	38	36
134	Module Product Type, Char #7	30	34	34
135	Module Product Type, Char #8	30	32	32
136	Module Product Type, Char #9	48	30	30
137	Module Product Type, Char #10	46	48	48
138	Module Product Type, Char #11	44	46	46
139	Module Product Type, Char #12	33	44	44
140	Module Product Type, Char #13	2E	33	33
141	Module Product Type, Char #14	37	2E	2E



HYS72T[64/128/256]4[00/20]HFD-[3S/3.7]-A

Product Type		HYS72T64400HFD-3.7-A	HYS72T128420HFD-3.7-A	HYS72T256420HFD-3.7-A
Organization		512MB	1 GByte	2 GByte
		×72	×72	×72
		1 Rank (×8)	2 Ranks (×8)	2 Ranks (×4)
Label Code		PC2-4200F-444	PC2-4200F-444	PC2-4200F-444
JEDEC SPD Revision		Rev. 1.1	Rev. 1.1	Rev. 1.1
Byte#	Description	HEX	HEX	HEX
142	Module Product Type, Char #15	41	37	37
143	Module Product Type, Char #16	20	41	41
144	Module Product Type, Char #17	20	20	20
145	Module Product Type, Char #18	20	20	20
146	Module Revision Code	7x	7x	7x
147	Test Program Revision Code	xx	xx	xx
148	DRAM Manufacturers JEDEC ID Code LSB	85	85	85
149	DRAM Manufacturers JEDEC ID Code MSB	51	51	51
150	informal AMB content revision tag (MSB)	01	01	01
151	informal AMB content revision tag (LSB)	05	05	05
152 - 175	Not used	00	00	00
176 - 255	Blank for customer use	FF	FF	FF



7 Package Outline

All Components are surface mounted on one or both sides of the PCB and positioned on the PCB to meet the minimum and maximum trace lengths required for DDR2 SDRAM signals. Bypass capacitors for DDR2 SDRAM devices are located

near the device power pins. The AMB device in the center of the DIMM has a metal Heat Sink. The FB-DIMM mechanical outlines are consistent with JEDEC MO-256.

TABLE 18
Raw Card Reference

JEDEC Raw Card	PCB		Dimensions			
			Width [mm]	Height [mm]	Thickness [mm]	Note
R/C A	L-DIM-240-21	Figure 4	133.35	30.35	8.2	1)
R/C B	L-DIM-240-22	Figure 5	133.35	30.35	8.2	1)
R/C H	L-DIM-240-25	Figure 6	133.35	30.35	8.2	1)

1) Thickness includes Qimonda Heat Sink. Some early production modules with Jedec Heatspreader may be thicker up to 8.2mm.

Attention: Heat Sink heat up during operation. When unplugging a DIMM from a system direct skin contact should be avoided until the Heat Sink has reached room temperature.

Attention: The Heat Sink is mechanically loaded. Do not remove. Removal of the clip may cause injuries.

Attention: Any mechanical stress on the Heat Sink should be avoided. Touching the Heat Sink while plugging or unplugging the module may permanently damage the DIMM.



FIGURE 4

Package Outline L-DIM-240-21 with Full Heat Sink

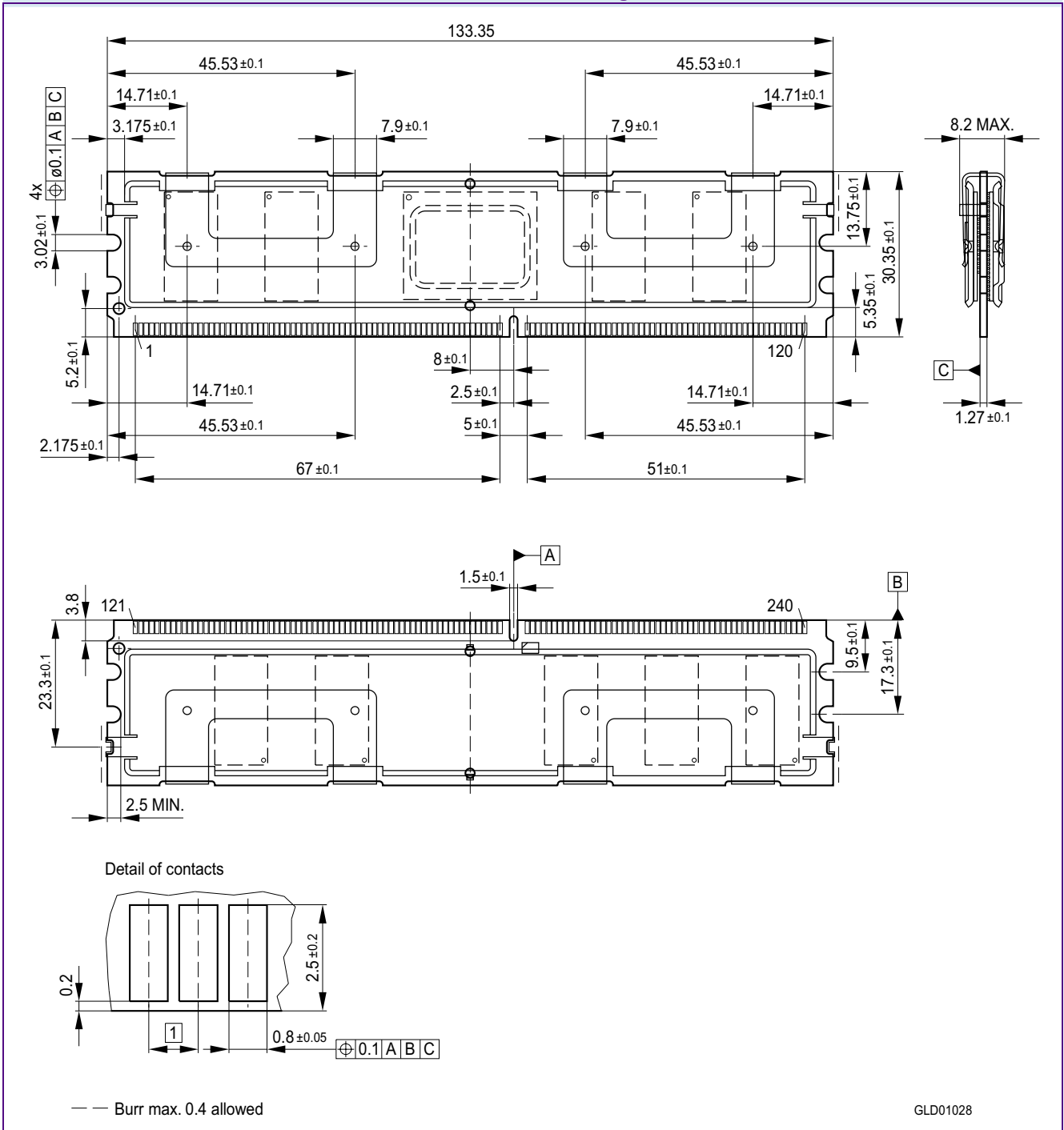

Notes

- 1. Please contact your sales or marketing representative for more details on package dimensions.
- 2. Drawing according to ISO 8015
- 3. Dimensions in mm
- 4. General tolerances +/- 0.15



FIGURE 5

Package Outline L-DIM-240-22 with Full Heat Sink

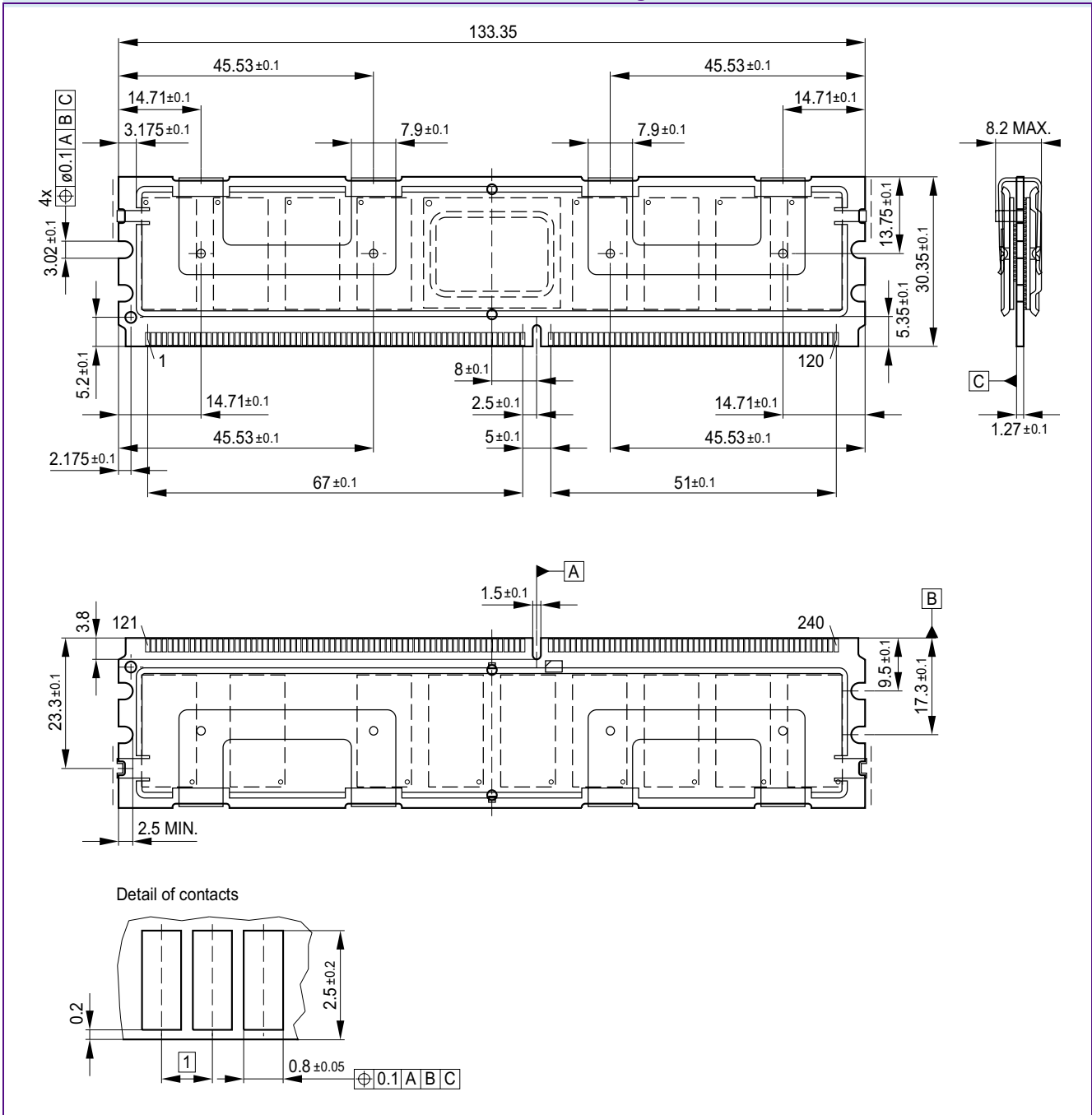

Notes

1. Please contact your sales or marketing representative for more details on package dimensions.

2. Drawing according to ISO 8015

3. Dimensions in mm

4. General tolerances +/- 0.15



FIGURE 6

Package Outline L-DIM-240-25 with Full Heat Sink

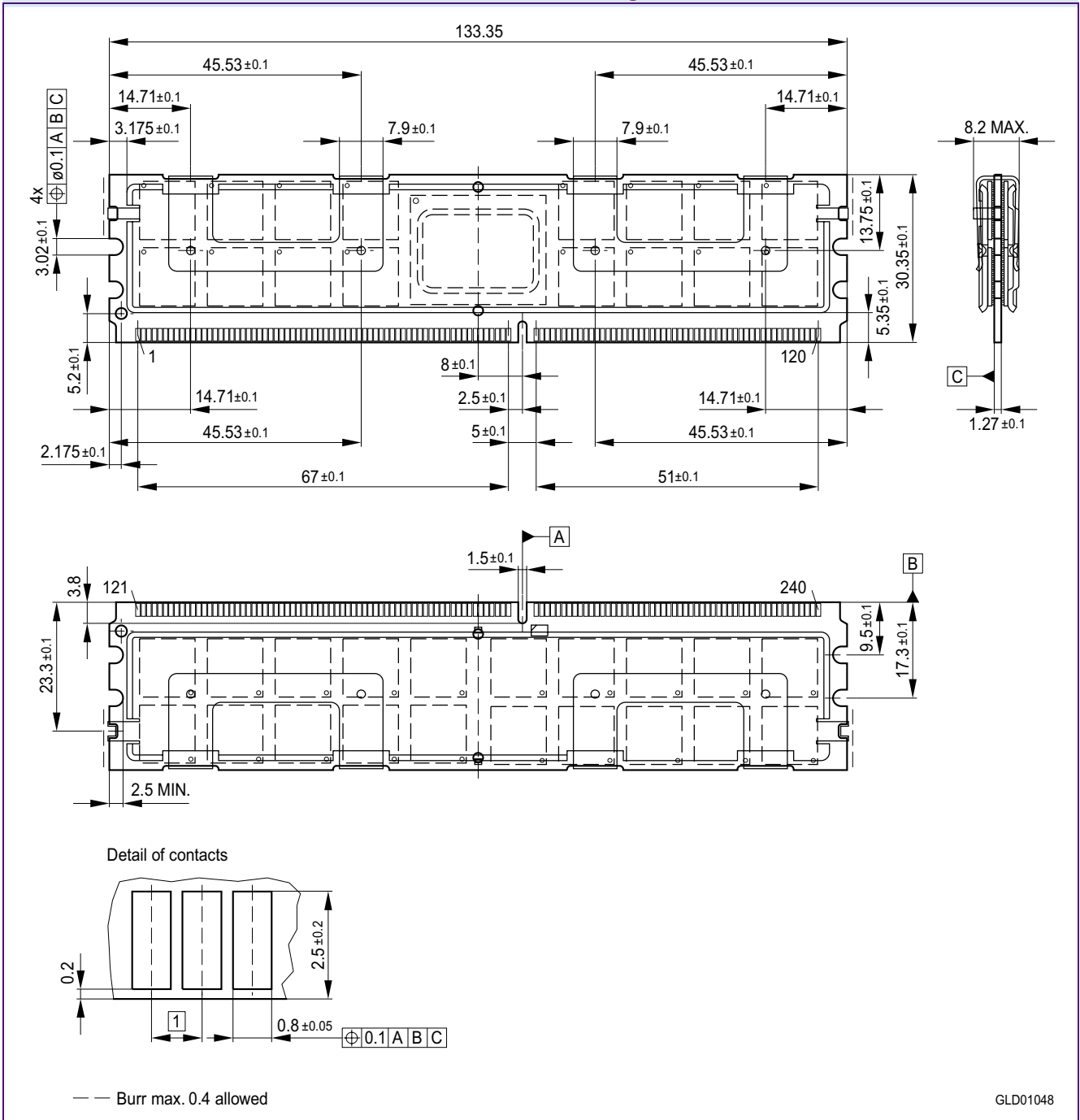

Notes

1. Please contact your sales or marketing representative for more details on package dimensions.
2. Drawing according to ISO 8015
3. Dimensions in mm
4. General tolerances +/- 0.15



8 DDR2 Nomenclature

TABLE 19
Nomenclature Fields and Examples

Example for	Field Number										
	1	2	3	4	5	6	7	8	9	10	11
Micro-DIMM	HYS	64	T	64128	0	2	0	K	M	-5	-A
DDR2 DRAM	HYB	18	T	5121G	16		0	A	C	-5	—

TABLE 20
DDR2 DIMM Nomenclature

Field	Description	Values	Coding
1	Module Prefix	HYS	Constant
2	Module Data Width [bit]	64	Non-ECC
		72	ECC
3	DRAM Technology	T	DDR2
4	Memory Density per I/O [Mbit]; Module Density ¹⁾	32	256 MByte
		64	512 MByte
		128	1 GByte
		256	2 GByte
		512	4 GByte
5	Raw Card Generation	0 .. 9	Look up table
6	Number of Module Ranks	0, 2, 4	1, 2, 4
7	Product Variations	0 .. 9	Look up table
8	Package, Lead-Free Status	A .. Z	Look up table
9	Module Type	D	SO-DIMM
		M	Micro-DIMM
		R	Registered
		U	Unbuffered
		F	Fully Buffered
10	Speed Grade	-2.5	PC2-6400 6-6-6
		-3	PC2-5300 4-4-4
		-3S	PC2-5300 5-5-5
		-3.7	PC2-4200 4-4-4
		-5	PC2-3200 3-3-3



HYS72T[64/128/256]4[00/20]HFD-[3S/3.7]-A

Field	Description	Values	Coding
11	Die Revision	-A	First
		-B	Second

1) Multiplying “Memory Density per I/O” with “Module Data Width” and dividing by 8 for Non-ECC and 9 for ECC modules gives the overall module memory density in MBytes as listed in column “Coding”.

TABLE 21
DDR2 DRAM Nomenclature

Field	Description	Values	Coding
1	Component Prefix	HYB	Constant
2	Interface Voltage [V]	18	SSTL_18
3	DRAM Technology	T	DDR2
4	Component Density [Mbit]	256	256 Mbit
		512	512 Mbit
		1G	1 Gbit
		2G	2 Gbit
5+6	Number of I/Os	40	×4
		80	×8
		16	×16
7	Product Variations	0 .. 9	Look up table
8	Die Revision	A	First
		B	Second
9	Package, Lead-Free Status	C	FBGA, lead-containing
		F	FBGA, lead-free
10	Speed Grade	-2.5	DDR2-800 6-6-6
		-3	DDR2-667 4-4-4
		-3S	DDR2-667 5-5-5
		-3.7	DDR2-533 4-4-4
		-5	DDR2-400 3-3-3



Table of Contents

1	Overview	3
1.1	Features	3
1.2	Description	4
2	Pin Configuration	6
3	Basic Functionality	12
3.1	Advanced Memory Buffer Functionality	12
3.2	Interfaces	12
3.3	High-Speed Differential Point-to-Point Link (at 1.5 V) Interfaces	14
3.3.1	DDR2 Channel	14
3.3.2	SMBus Slave Interface	14
3.3.3	Channel Latency	14
3.3.4	Peak Theoretical Channel Throughput	15
3.4	Hot-add	15
3.5	Hot-remove	15
3.6	Hot-replace	15
4	Electrical Characteristics	16
4.1	Operating Conditions	16
5	Current Spec. and Conditions	19
5.1	I_{CC}/I_{DD} Conditions	21
6	SPD Codes	25
7	Package Outline	35
8	DDR2 Nomenclature	39
	Table of Contents	41

Edition 2006-11
Published by Qimonda AG
Gustav-Heinemann-Ring 212
D-81739 München, Germany
© Qimonda AG 2006.
All Rights Reserved.

Legal Disclaimer

The information given in this Internet Data Sheet shall in no event be regarded as a guarantee of conditions or characteristics ("Beschaffenheitsgarantie"). With respect to any examples or hints given herein, any typical values stated herein and/or any information regarding the application of the device, Qimonda hereby disclaims any and all warranties and liabilities of any kind, including without limitation warranties of non-infringement of intellectual property rights of any third party.

Information

For further information on technology, delivery terms and conditions and prices please contact your nearest Qimonda Office.

Warnings

Due to technical requirements components may contain dangerous substances. For information on the types in question please contact your nearest Qimonda Office.

Qimonda Components may only be used in life-support devices or systems with the express written approval of Qimonda, if a failure of such components can reasonably be expected to cause the failure of that life-support device or system, or to affect the safety or effectiveness of that device or system. Life support devices or systems are intended to be implanted in the human body, or to support and/or maintain and sustain and/or protect human life. If they fail, it is reasonable to assume that the health of the user or other persons may be endangered.