LinMot®

Documentation for installing the following Drives:

- E1100-CO (-HC, -XC)
- E1100-DN (-HC, -XC)
- E1100-RS (-HC, -XC)
- E1130-DP (-HC, -XC)
- E1100-GP (-HC, -XC)



Drive Data Sheet & Installation Guide

*Eine Deutsche Version kann unter <http://www.linmot.com> bezogen werden!
Please visit <http://www.linmot.com> to check for the latest version of this document!*

© 2014 NTI AG

This work is protected by copyright.

Under the copyright laws, this publication may not be reproduced or transmitted in any form, electronic or mechanical, including photocopying, recording, microfilm, storing in an information retrieval system, not even for didactical use, or translating, in whole or in part, without the prior written consent of NTI AG.

LinMot® is a registered trademark of NTI AG.

Note

The information in this documentation reflects the stage of development at the time of press and is therefore without obligation. NTI AG reserves itself the right to make changes at any time and without notice to reflect further technical advance or product improvement.

Document version 3.19a / FM,Ro / March 2014

Table of Content

IMPORTANT SAFETY NOTES FOR E1100 DRIVES.....	4
SYSTEM OVERVIEW.....	5
E1100 INTERFACES.....	6
E1100-GP (-LC/HC/XC).....	6
E1100-CO/DN/RS (-LC/HC/XC).....	7
E1130-DP (-LC/HC/XC).....	8
FUNCTIONALITY.....	9
E1130-DP(-HC, -XC) FUNCTIONS AND WIRING.....	10
E1100-GP (-HC, -XC) FUNCTIONS AND WIRING.....	11
E1100-CO (-HC, -XC), -DN (-HC, -XC), -RS (-HC, -XC) FUNCTIONS AND WIRING.....	12
POWER SUPPLY AND GROUNDING.....	13
DESCRIPTION OF THE CONNECTORS / INTERFACES.....	14
ERROR CODES.....	21
PHYSICAL DIMENSION.....	22
POWER SUPPLY REQUIREMENT.....	23
REGENERATION OF POWER / REGENERATION RESISTOR.....	23
ORDERING INFORMATION.....	24
INTERNATIONAL CERTIFICATIONS.....	24
SAFETY NOTES FOR THE INSTALLATION ACCORDING TO UL.....	25
DRIVE CLASSIFICATION ACCORDANCE WITH THE NEW.....	25
MACHINERY DIRECTIVE EN ISO 13849-1.....	25
DECLARATION OF CONFORMITY CE-MARKING.....	26
CONTACT ADDRESSES.....	27

Important Safety Notes for E1100 Drives

CAUTION!

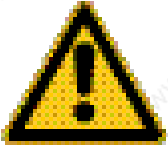

In order to assure a safe and error free operation, and to avoid severe damage to system components, all system components must be directly attached to a single ground bus that is earth or utility grounded (see chapter Power Supply and Grounding).



Each system component should be tied directly to the ground bus (star pattern), rather than daisy chaining from component to component. (LinMot motors are properly grounded through their power cables when connected to LinMot drives) (see chapter Power Supply and Grounding).



All connectors must not be connected or disconnected while DC voltage is present. Do not disconnect system components until all LinMot drive LEDs have turned off. (Capacitors in the power supply may not fully discharge for several minutes after input voltage has been disconnected). Failure to observe these precautions may result in severe damage to electronic components in LinMot motors and/or drives.

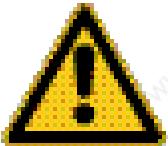

Do not switch Power Supply DC Voltage. All power supply switching and E-Stop breaks should be done to the AC supply voltage of the power supply.



Do not connect or disconnect the motors from drives with voltage present. Wait to connect or disconnect motors until all LinMot drive's LEDs have turned off. (Capacitors may not fully discharge for several minutes after power has been turned off).

Failure to observe these precautions may result in severe damage to electronic components in LinMot motors and/or drives.

System Overview

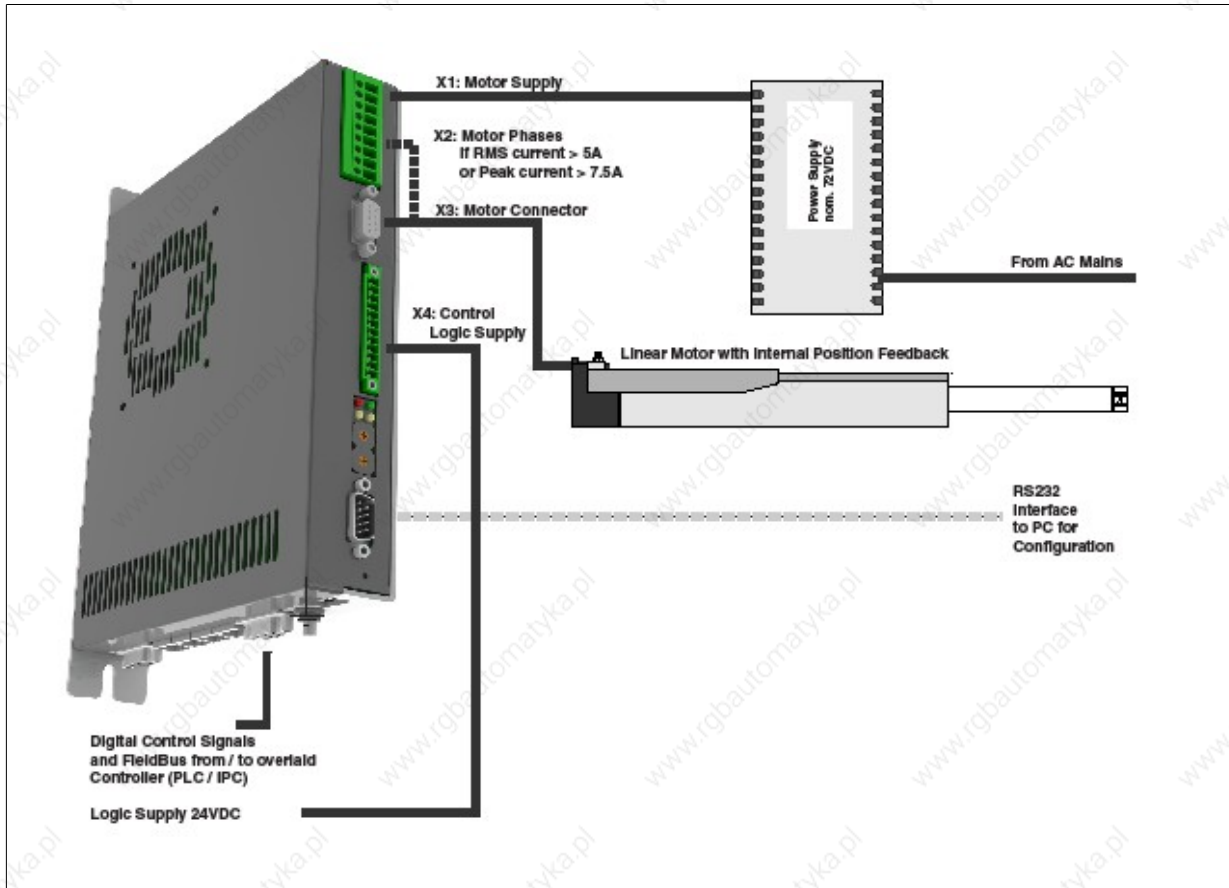

Typical Servo System E1100-XX: Drive, Linear Motor and Power Supply.

E1100 Interfaces

E1100-GP (-LC/HC/XC)

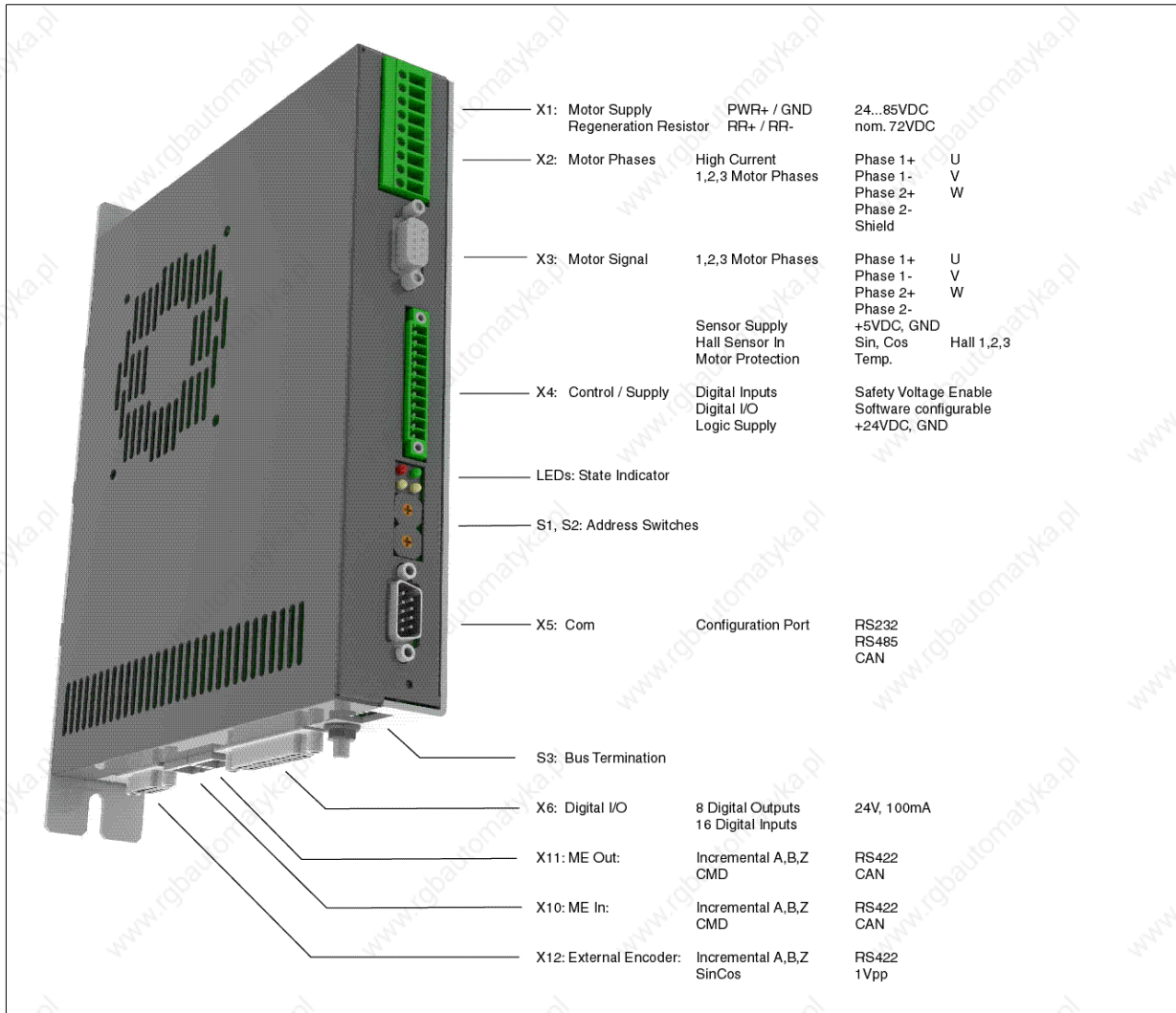

E1100-CO/DN/RS (-LC/HC/XC)

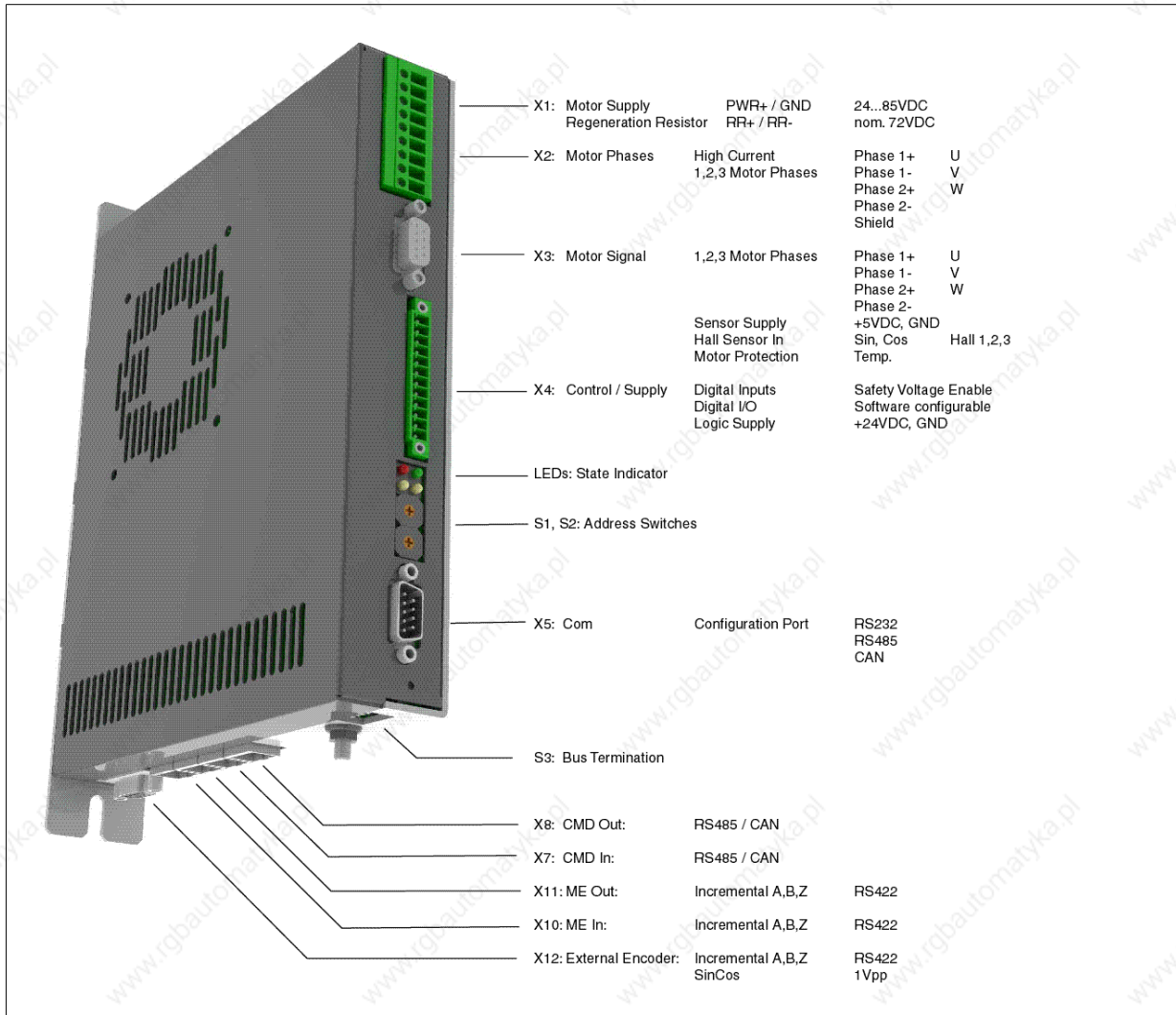

E1130-DP (-LC/HC/XC)

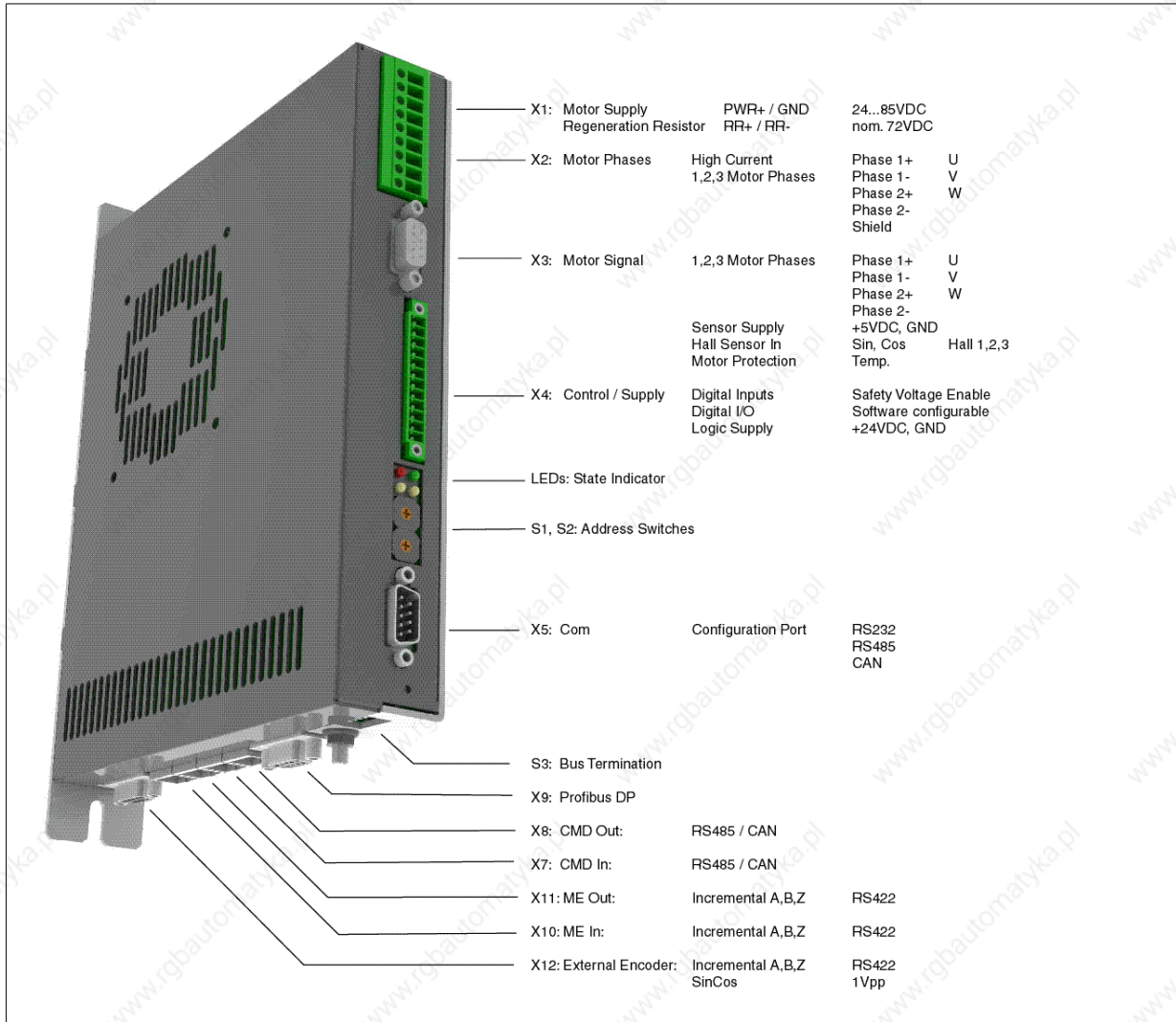

Functionality

	E1100-RS	E1100-RS-HC	E1100-RS-XC	E1100-CO	E1100-CO-HC	E1100-CO-XC	E1100-DN	E1100-DN-HC	E1100-DN-XC	E1130-DP	E1130-DP-HC	E1130-DP-XC	E1100-GP	E1100-GP-HC	E1100-GP-XC	
Supply Voltage																
Motor Supply 72VDC (24...85VDC) (30...85VDC for UL)	•	•	•	•	•	•	•	•	•	•	•	•	•	•	•	•
Logic Supply 24VDC (22...26VDC)	•	•	•	•	•	•	•	•	•	•	•	•	•	•	•	•
Motor Phase Current																
8A _{peak} / 6A _{rms}	•			•			•			•			•			•
15A _{peak} / 9A _{rms}		•			•			•			•			•		
25A _{peak} / 12A _{rms}			•			•			•			•			•	
Controllable Motors																
LinMot P01-23x...	•	•	•	•	•	•	•	•	•	•	•	•	•	•	•	•
P01-37x...	•	•	•	•	•	•	•	•	•	•	•	•	•	•	•	•
P01-48x...	•	•	•	•	•	•	•	•	•	•	•	•	•	•	•	•
DC Motors	•	•	•	•	•	•	•	•	•	•	•	•	•	•	•	•
Brushless DC / EC Motors	•	•	•	•	•	•	•	•	•	•	•	•	•	•	•	•
Command Interface																
Easy Step Application Layer (X4-IOs)	•	•	•	•	•	•	•	•	•	•	•	•	•	•	•	•
Cmd Tab IO Interface (X6-IOs)													•	•	•	•
RS232 up to 115.2 kBaud	•	•	•	•	•	•	•	•	•	•	•	•	•	•	•	•
RS485 up to 115.2 kBaud	•	•	•	•	•	•	•	•	•	•	•	•	•	•	•	•
CANOpen up to 1MBaud				•	•	•	•	•	•	•	•	•	•	•	•	•
DeviceNet 125, 250, 500 kBaud							•	•	•	•	•	•	•	•	•	•
PROFIBUS DP up to 12 MBaud										•	•	•				
Programmable Motion Profiles (Curves)																
Up to 99 Motion Profiles Up to 8110 Curve Points	•	•	•	•	•	•	•	•	•	•	•	•	•	•	•	•
Programmable Command Table																
Command Table with up to 255 entries	•	•	•	•	•	•	•	•	•	•	•	•	•	•	•	•
External Position Sensor																
Incremental RS422 up to 2 MHz	•	•	•	•	•	•	•	•	•	•	•	•	•	•	•	•
Sin/Cos 1Vpp up to 10 kHz	•	•	•	•	•	•	•	•	•	•	•	•	•	•	•	•
Synchronisation																
Master Encoder In/Out RS422 up to 2 MHz	•	•	•	•	•	•	•	•	•	•	•	•	•	•	•	•
Configuration																
RS232 Configuration	•	•	•	•	•	•	•	•	•	•	•	•	•	•	•	•
CAN Multi Axes Configuration	•	•	•	•	•	•	•	•	•	•	•	•	•	•	•	•

E1130-DP(-HC, -XC) Functions and Wiring

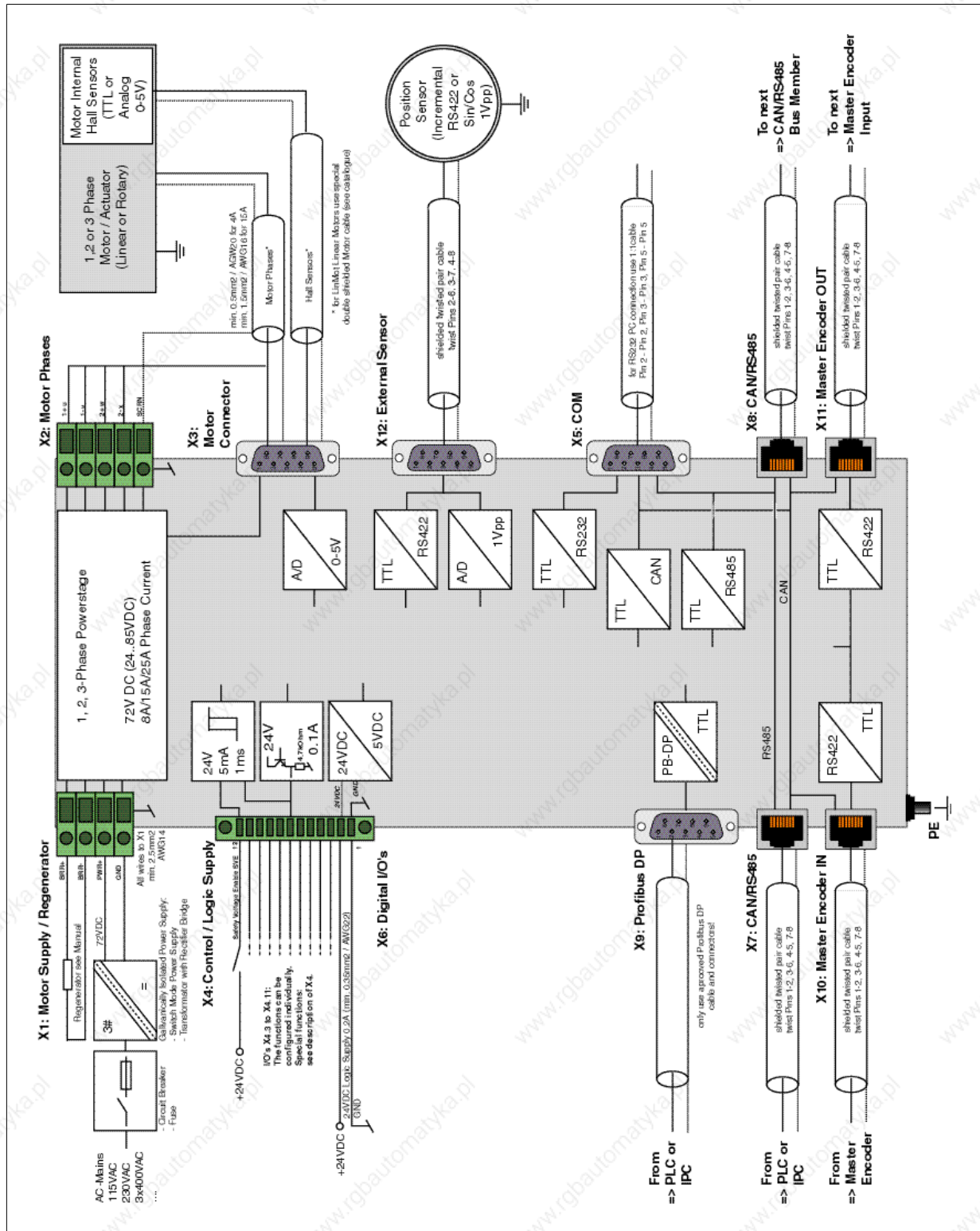

E1100-GP (-HC, -XC) Functions and Wiring

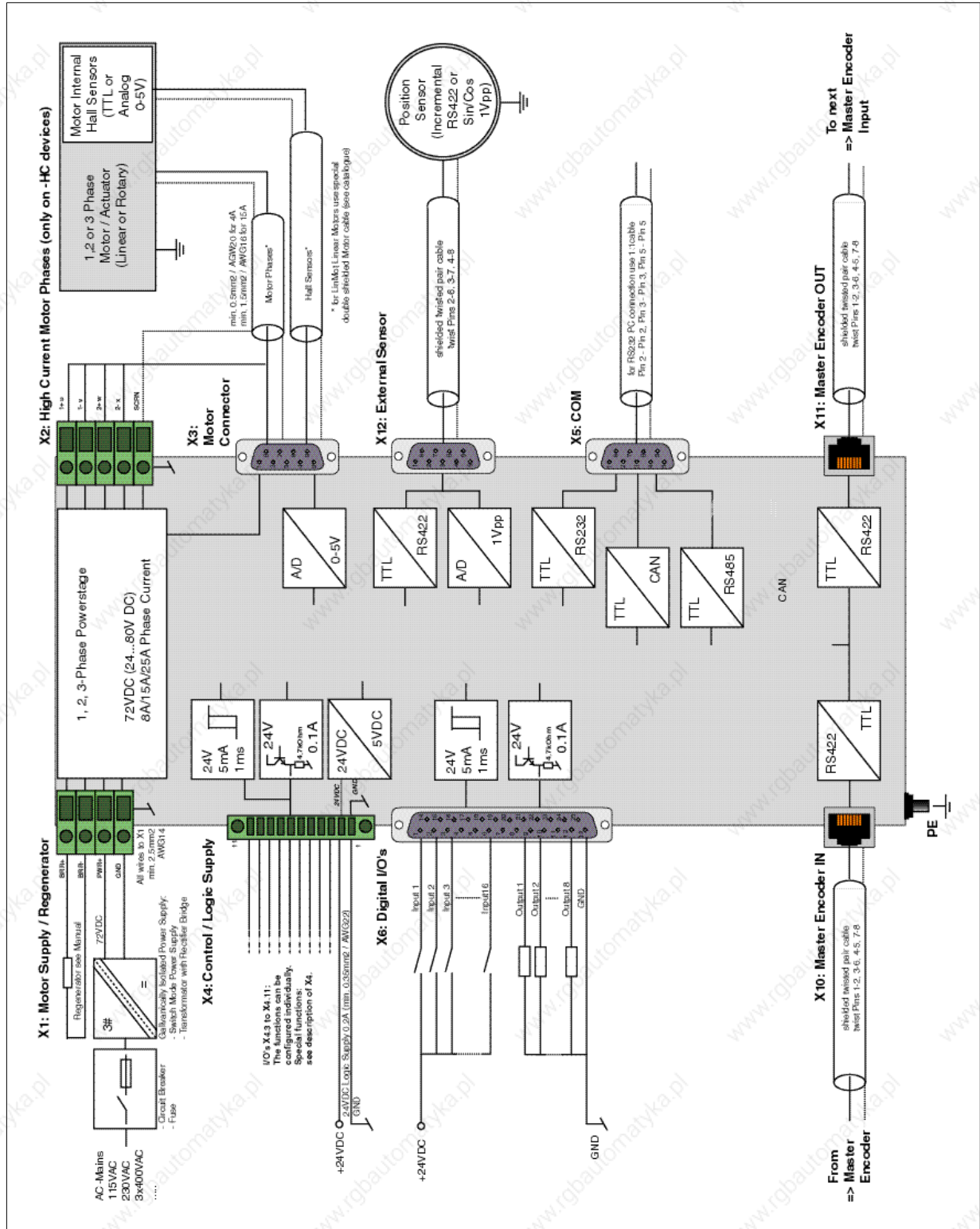

E1100-CO (-HC, -XC), -DN (-HC, -XC), -RS (-HC, -XC) Functions and Wiring

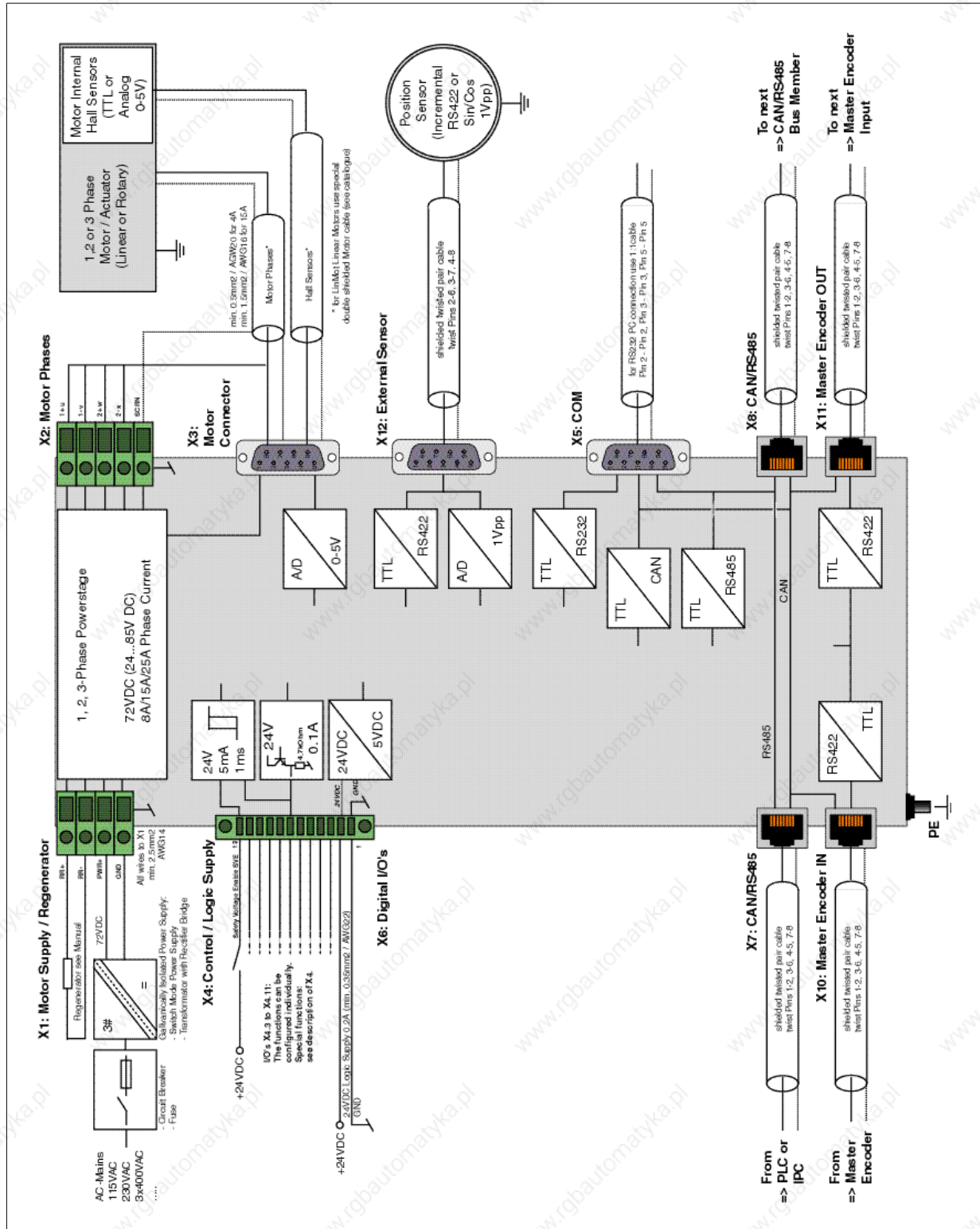

Power Supply and Grounding

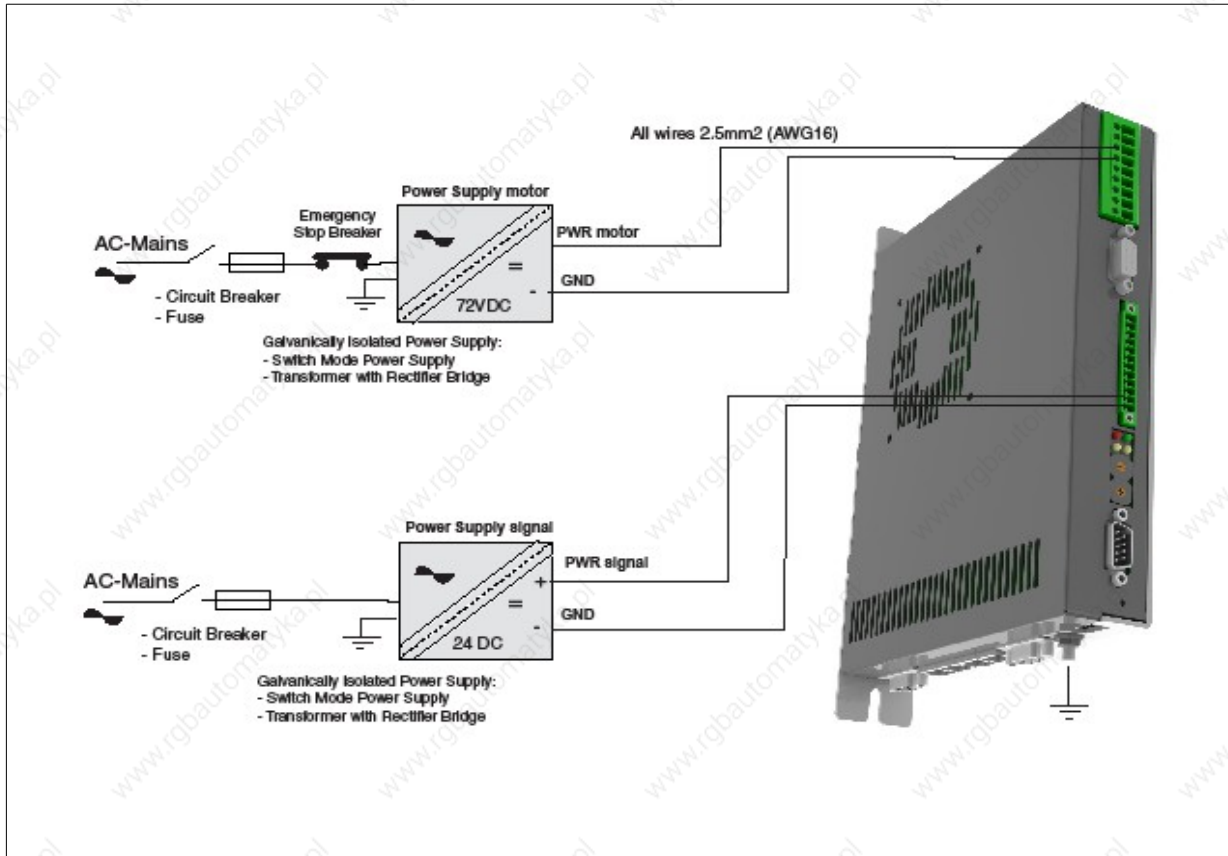

*Inside of the E1100 drive the *PWR motor GND* and *PWR signal GND* is connected together and to the GND of the drive housing. It is recommended that the *PWR motor GND* is NOT grounded at another place than inside of the drive to reduce circular currents.



In order to assure a safe and error free operation, and to avoid severe damage to system components, **all system components* must be well grounded to either a single earth or utility ground.** This includes both LinMot and all other control system components to the same ground bus.



Each system component* should be tied directly to the ground bus (**star pattern**), rather than daisy chaining from component to component. (LinMot motors are properly grounded through their power cables when connected to LinMot drives.)



Power supply connectors must not be connected or disconnected while DC voltage is present. Do not disconnect system components until all LinMot drive LEDs have turned off. (Capacitors in the power supply may not fully discharge for several minutes after input voltage has been disconnected). Failure to observe these precautions may result in severe damage to electronic components in LinMot motors and/or drives.



Do not switch Power Supply DC Voltage. All power supply switching and E-Stop breaks should be done to the AC supply voltage of the power supply. Failure to observe these precautions may result in severe damage to drive.

Description of the connectors / Interfaces

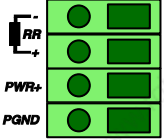
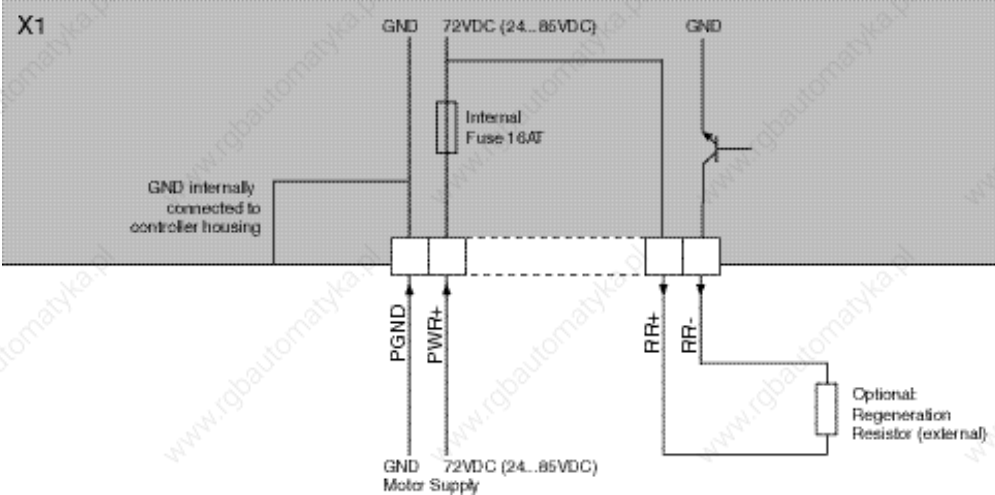
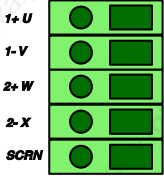
X1:	Motor Supply / Regeneration Resistor														
	 <p>For UL applications RR+ and RR- of terminal X1 must not be connected!</p> <p>Internal Fuse (F300): 16AT (slow blow, Schurter SMD-SPT, 0001.2716.xx, UL File Number: E41599) The fuse is directly soldered onto the PCB. Replacement is only possible by qualified personnel with appropriate equipment. CAUTION: For continued protection against risk of fire, replace only with same type and rating of fuse.</p>														
Screw Terminals	<p>External Regeneration Resistor (RR01-10/60, Art. Nr. 0150-3088) For UL applications RR+ and RR- of terminal X1 must not be connected!</p> <p>Motor Supply nominal 72VDC (24...85VDC) (for UL 30...85VDC) Absolute max. Rating 72VDC +20%.</p> <p>If motor supply voltage is exceeds 90VDC, the drive will go into error state.</p> <ul style="list-style-type: none"> - Tightening torque: 0.5Nm (4.5 lb-in) - Screw thread: M 2,5 - Use 60/75°C copper conductors only - Conductor cross-section: use only 2.5mm² (AWG 14) - Max. length: 4m 														
X2:	Motor Phases														
	<p>PH1+ /U PH1- /V PH2+ /W PH2- SCRN</p>	<p>LinMot Motor:</p> <table border="0"> <tr> <td>Motor Phase 1+</td> <td>red</td> </tr> <tr> <td>Motor Phase 1-</td> <td>pink</td> </tr> <tr> <td>Motor Phase 2+</td> <td>blue</td> </tr> <tr> <td>Motor Phase 2-</td> <td>grey</td> </tr> <tr> <td>Shield</td> <td></td> </tr> </table> <p>3-phase EC-Motor:</p> <table border="0"> <tr> <td>Motor Phase U</td> </tr> <tr> <td>Motor Phase V</td> </tr> <tr> <td>Motor Phase W</td> </tr> </table>	Motor Phase 1+	red	Motor Phase 1-	pink	Motor Phase 2+	blue	Motor Phase 2-	grey	Shield		Motor Phase U	Motor Phase V	Motor Phase W
Motor Phase 1+	red														
Motor Phase 1-	pink														
Motor Phase 2+	blue														
Motor Phase 2-	grey														
Shield															
Motor Phase U															
Motor Phase V															
Motor Phase W															
Screw Terminals	<p>The motor phases are present at X2 and X3. For any application it is recommended to use X2. It is only allowed to use X3 for connecting the motor phases if RMS current is below 5A and peak current is below 7.5A. For UL applications the motor phases must be wired on X2. Never connect motor phases on X2 and X3!</p> <ul style="list-style-type: none"> - Tightening torque: 0.5Nm (4.5 lb-in) - Screw thread: M 2,5 - Use 60/75°C copper conductors only - Conductor cross-section max. 2.5mm² (AWG 14) 														

X3:	Motor
	<p>LinMot Motor:</p> <ul style="list-style-type: none"> 1 Motor Phase 1+ 2 Motor Phase 2+ 3 +5VDC 4 Sensor Sine 5 Temp. In 6 Motor Phase 1- 7 Motor Phase 2- 8 AGND 9 Sensor Cosine case Shield
	<p>3-phase EC-Motor:</p> <ul style="list-style-type: none"> +5VDC (Hall Supply) Hall 1 Hall 3 AGND (Hall Supply) Hall 2
<p>For UL applications the motor phases must be wired on X2 and not on X3!</p>	
<p>DSUB-9 (f)</p>	<p>Note: Use +5V (X3.3) and AGND (X3.8) only for motor internal Hall Sensor supply (max. 100mA).</p> <p>Caution: Do NOT connect AGND (X3.8) to ground or earth! It is only allowed to use X3 for connecting the motor phases if RMS current is below 5A and peak current is below 7.5A.</p>

Motor Wiring for Phase Currents above 5A RMS 7.5A peak (recommended general wiring)

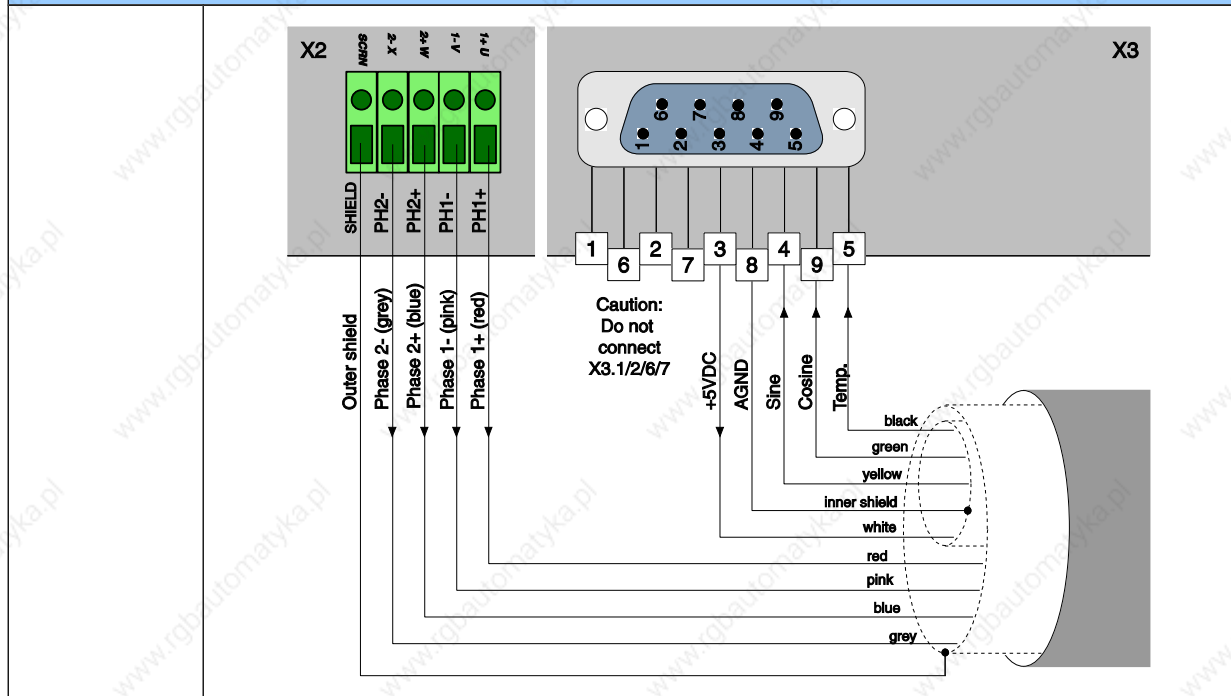

Important:
If motor phase current exceeds 5A_{RMS} or 7.5A_{peak}, motor phases must be wired to X2.
For UL applications the motor phases have to be wired on X2 and not on X3!

Motor wiring for Phase Currents below 5A RMS 7.5A peak

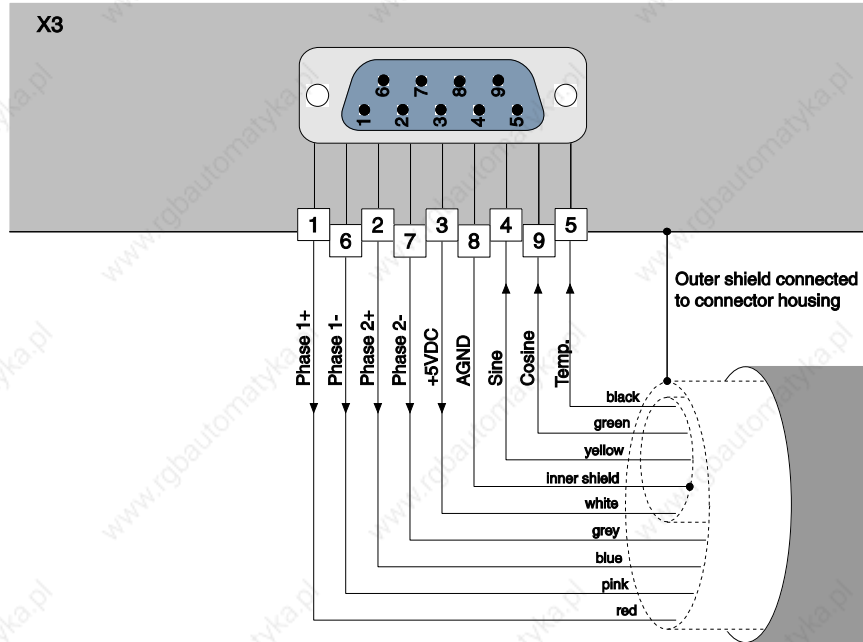

Important:
 Motor phases may only be connected to X3 if RMS current is below 5A and peak current is below 7.5A. For UL applications the motor phases have to be wired on X2 and not on X3!

X4: 12pin Control/Supply (E1130-DP(-HC,-XC), E1100-CO(-HC,-XC), E1100-DN(-HC,-XC), E1100-RS(-HC,-XC))

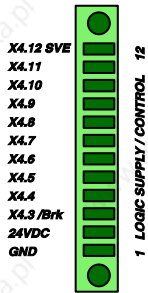

12	Input	Safety Voltage Enable	Power Stage Enable (HW Enable)
11	I/O	X4.11	Configurable IO, PTC2 Input
10	I/O	X4.10	Configurable IO, PTC1 Input
9	I/O	X4.9	Configurable IO
8	I/O	X4.8	Configurable IO
7	I/O	X4.7	Configurable IO, Analog Input for EasySteps
6	I/O	X4.6	Configurable IO, Trigger Input
5	I/O	X4.5	Configurable IO
4	I/O	X4.4	Configurable IO, Analog Input
3	I/O	X4.3/Brk	Configurable IO, Brake Driver 1A
2	+24VDC	Supply	Logic Supply 22-26 VDC
1	GND	Supply	Ground

Phoenix
 MC1,5/12-STF-
 3,5

Inputs (X4.3 .. X4.12): 24V / 5mA (Low Level: -0.5 to 5VDC, High Level: 15 to 30VDC)
 Outputs (X4.4 .. X4.11): 24V / max.100mA, Peak 370mA (will shut down if exceeds)
 Brake Output (X4.3): 24V / max.1.0A



Input X4.12: SVE (Safety Voltage Enable) must be high for enabling the power stage. If it goes low for more than 0.5ms the PWM generation of the power stage is disabled by hardware.
 Supply 24V / typ. 400mA / max. 2.1A (if all outputs "on" with max. load.)

- Tightening torque: 0.22 - 0.44Nm (2 - 4 lb-in)
- Screw thread: M2
- Use 60/75 °C copper conductors only
- Conductor cross-section: 0.5 - 1.5mm² (AWG 21 - 14)

Internal Fuse (F2): 3AT (slow blow, Schurter OMT125, 3404.0118.xx, UL File Number: E41599)
 The fuse is directly soldered onto the PWB. Replacement is only possible by qualified personnel with appropriate equipment.

CAUTION: For continued protection against risk of fire, replace only with same type and rating of fuse.

X4: 11pin		Control / Supply (E1100-GP(-HC, -XC))																																					
	11	I/O	X4.11	Configurable IO, PTC2 Input																																			
	10	I/O	X4.10	Configurable IO, PTC1 Input																																			
	9	I/O	X4.9	Configurable IO																																			
	8	I/O	X4.8	Configurable IO																																			
	7	I/O	X4.7	Configurable IO																																			
	6	I/O	X4.6	Configurable IO, Trigger																																			
	5	I/O	X4.5	Configurable IO																																			
	4	I/O	X4.4	Configurable IO, Analog Input																																			
	3	I/O	X4.3/Brk	Configurable IO, Brake Driver 1A																																			
	2		+24VDC Supply	Logic Supply 22-26 VDC																																			
	1		GND Supply	Ground																																			
Phoenix MC1,5/11-STF-3,5	Inputs (X4.3 .. X4.11): 24V / 5mA (Low Level: -0.5 to 5VDC, High Level: 15 to 30VDC) Outputs (X4.4 .. X4.11): 24V / max.100mA, Peak 370mA (will shut down if exceeds) Brake Output (X4.3): 24V / max. 1.0A Supply 24V / typ. 400mA / max. 3.0A (if all outputs "on" with max. load.) - Tightening torque: 0.22 - 0.44Nm (2 - 4 lb-in) - Screw thread: M2 - Use 60/75 °C copper conductors only - Conductor cross-section: 0.5 - 1.5mm ² (AWG 21 - 14) Internal Fuse (F2): 3AT (slow blow, Schurter OMT125, 3404.0118.xx, UL File Number: E41599) The fuse is directly soldered onto the PWB. Replacement is only possible by qualified personnel with appropriate equipment. CAUTION: For continued protection against risk of fire, replace only with same type and rating of fuse.																																						
LEDs		State Display																																					
	Green	24V Logic Supply OK																																					
	Yellow	Motor Enabled / Error Code Low Nibble																																					
Yellow	Warning / Error Code High Nibble																																						
Red	Error																																						
S1, S2:		Baud Rate / Address Selectors																																					
	S1	Bus ID High / Baud Rate	(0...F)																																				
	S2	Bus ID Low	(0...F)																																				
The switches S1 and S2 define the baud rate and MAC ID depending on the interface and parameter settings. The following description is only valid for default configurations, otherwise see in the interface specific documentation for more information.																																							
S1: Baud Rate selector for CO, DN and RS interface:																																							
<table border="1"> <thead> <tr> <th>S1 Pos</th> <th>CO:</th> <th>DN:</th> <th>RS:</th> </tr> </thead> <tbody> <tr> <td>0:</td> <td>undefined</td> <td>undefined</td> <td>undefined</td> </tr> <tr> <td>1:</td> <td>125 kBit/s</td> <td>125 kBit/s</td> <td>4800 Bit/s</td> </tr> <tr> <td>2:</td> <td>250 kBit/s</td> <td>250 kBit/s</td> <td>9600 Bit/s</td> </tr> <tr> <td>3:</td> <td>500 kBit/s</td> <td>500 kBit/s</td> <td>19200 Bit/s</td> </tr> <tr> <td>4:</td> <td>1 MBit/s</td> <td>undefined</td> <td>38400 Bit/s</td> </tr> <tr> <td>5:</td> <td>undefined</td> <td>undefined</td> <td>57600 Bit/s</td> </tr> <tr> <td>6:</td> <td>undefined</td> <td>undefined</td> <td>115200 Bit/s</td> </tr> <tr> <td>7..F:</td> <td>undefined</td> <td>undefined</td> <td>undefined</td> </tr> </tbody> </table>				S1 Pos	CO:	DN:	RS:	0:	undefined	undefined	undefined	1:	125 kBit/s	125 kBit/s	4800 Bit/s	2:	250 kBit/s	250 kBit/s	9600 Bit/s	3:	500 kBit/s	500 kBit/s	19200 Bit/s	4:	1 MBit/s	undefined	38400 Bit/s	5:	undefined	undefined	57600 Bit/s	6:	undefined	undefined	115200 Bit/s	7..F:	undefined	undefined	undefined
S1 Pos	CO:	DN:	RS:																																				
0:	undefined	undefined	undefined																																				
1:	125 kBit/s	125 kBit/s	4800 Bit/s																																				
2:	250 kBit/s	250 kBit/s	9600 Bit/s																																				
3:	500 kBit/s	500 kBit/s	19200 Bit/s																																				
4:	1 MBit/s	undefined	38400 Bit/s																																				
5:	undefined	undefined	57600 Bit/s																																				
6:	undefined	undefined	115200 Bit/s																																				
7..F:	undefined	undefined	undefined																																				
S2: MACID for CO, DN, RS interface and CANTalk ¹⁾ : Position value is equal to MACID (e.g. position 7 → MACID 0x07h)																																							
In case of Profibus DP the switches S1 and S2 define the node address, whereas S1 is the high nibble and S2 the low nibble.																																							
NOTE: The baud rate and MACID will only be set if the interface switch S3.4 is set to "on". In case of CO or DN interfaces, the OS (operating system) sets up the CAN bus baud rate according to the interface settings, but only if the interface is activated (S3.4). Otherwise the baud rate will be set to 500kbaud. The CAN-Talk ID is always taken from both switches S1 and S2.																																							

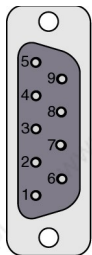
S3:		Bus Termination	
	S3	Switch 4: Interface on/off (All field bus interfaces) Switch 3: Termination CAN on/off Switch 2: Termination RS485 on/off Switch 1: RS232 (switch "off" / RS485 "on") Select serial RS232 or RS485 Factory setting: all switches "off"	
		To use field bus functionality the switch S3.4 has to be set to position "on"! In position "off" the field bus is deactivated.	
X5:		COM	
	1 2 3 4 5 6 7 8 9 case	RS485_Tx+ RS232_Tx RS232_Rx RS485_Rx+ GND RS485_Rx- RS485_Tx- CAN_L CAN_H Shield	Y A B Z
DSUB-9 (m)	<u>RS232:</u>	Configuration on all drives: use 1:1 connection cable to PC with only pins 2, 3 and 5 connected. Use LinMot RS configuration cable (Art.-No. 0150-3307). Cable length < 30m	

<p>X6:</p>	<p>Digital I/O (only available on E1100-GP (-HC, -XC))</p>																															
<p>DSUB-25 (f)</p>	<p>All Inputs: Direct interfacing to digital 24VDC PLC outputs. Input Current: 1mA Sample Rate: 1ms Low Level: -30 to 8.5VDC High Level: 20.5 to 30VDC</p> <p>All Outputs: Short circuit and overload protected high side switches Voltage: 24VDC Update Rate: 1ms Max. Current: 100mA Peak Current: 370mA (will shut down if exceeds)</p> <p>Outputs may directly drive inductive loads. Do not connect any capacity because of the peak current!</p>																															
<p>X7 - X8 RS485/CAN</p>																																
	<table border="0"> <tr> <td>1</td> <td>RS485_Rx+</td> <td>A</td> </tr> <tr> <td>2</td> <td>RS485_Rx-</td> <td>B</td> </tr> <tr> <td>3</td> <td>RS485_Tx+</td> <td>Y</td> </tr> <tr> <td>4</td> <td>GND</td> <td></td> </tr> <tr> <td>5</td> <td>GND</td> <td></td> </tr> <tr> <td>6</td> <td>RS485_Tx-</td> <td>Z</td> </tr> <tr> <td>7</td> <td>CAN_H</td> <td></td> </tr> <tr> <td>8</td> <td>CAN_L</td> <td></td> </tr> <tr> <td>case</td> <td>Shield</td> <td></td> </tr> </table>		1	RS485_Rx+	A	2	RS485_Rx-	B	3	RS485_Tx+	Y	4	GND		5	GND		6	RS485_Tx-	Z	7	CAN_H		8	CAN_L		case	Shield				
1	RS485_Rx+	A																														
2	RS485_Rx-	B																														
3	RS485_Tx+	Y																														
4	GND																															
5	GND																															
6	RS485_Tx-	Z																														
7	CAN_H																															
8	CAN_L																															
case	Shield																															
<p>RJ-45</p>	<p>Use twisted pair (1-2, 3-6, 4-5, 7-8) cable for wiring. The built in CAN and RS485 terminations can be activated by S3.2 and S3.3. X7 is internally connected to X8 (1:1 connection)</p>																															
<p>X9: Profibus DP (only available on E1130-DP (-HC, -XC))</p>																																
	<table border="0"> <tr> <td>1</td> <td>Not connected</td> <td></td> </tr> <tr> <td>2</td> <td>Not connected</td> <td></td> </tr> <tr> <td>3</td> <td>RxD/TxD-P</td> <td></td> </tr> <tr> <td>4</td> <td>CNTR-P</td> <td></td> </tr> <tr> <td>5</td> <td>GND</td> <td>(isolated)</td> </tr> <tr> <td>6</td> <td>+5V</td> <td>(isolated)</td> </tr> <tr> <td>7</td> <td>Not connected</td> <td></td> </tr> <tr> <td>8</td> <td>RxD/TxD-N</td> <td></td> </tr> <tr> <td>9</td> <td>Not connected</td> <td></td> </tr> <tr> <td>case</td> <td>Shield</td> <td></td> </tr> </table>		1	Not connected		2	Not connected		3	RxD/TxD-P		4	CNTR-P		5	GND	(isolated)	6	+5V	(isolated)	7	Not connected		8	RxD/TxD-N		9	Not connected		case	Shield	
1	Not connected																															
2	Not connected																															
3	RxD/TxD-P																															
4	CNTR-P																															
5	GND	(isolated)																														
6	+5V	(isolated)																														
7	Not connected																															
8	RxD/TxD-N																															
9	Not connected																															
case	Shield																															

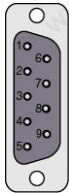
DSUB-9 (f)	Max. Baud rate: 12Mbaud																																								
X10 / X11	Master Encoder IN (X10) / Master Encoder OUT (X11)																																								
	<table border="1"> <thead> <tr> <th></th> <th><u>Incremental:</u></th> <th><u>Step/Direction:</u></th> <th><u>EIA/TIA 568A colors:</u></th> </tr> </thead> <tbody> <tr> <td>1</td> <td>A+</td> <td>Step+</td> <td>Green/White</td> </tr> <tr> <td>2</td> <td>A-</td> <td>Step-</td> <td>Green</td> </tr> <tr> <td>3</td> <td>B+</td> <td>Direction+</td> <td>Orange/White</td> </tr> <tr> <td>4</td> <td>Z+</td> <td>Zero+</td> <td>Blue</td> </tr> <tr> <td>5</td> <td>Z-</td> <td>Zero-</td> <td>Blue/White</td> </tr> <tr> <td>6</td> <td>B-</td> <td>Direction-</td> <td>Orange</td> </tr> <tr> <td>7</td> <td>CAN_H (GP)</td> <td>CAN_H (GP)</td> <td>Brown/White</td> </tr> <tr> <td>8</td> <td>CAN_L (GP)</td> <td>CAN_L (GP)</td> <td>Brown</td> </tr> <tr> <td>case</td> <td>Shield</td> <td>Shield</td> <td></td> </tr> </tbody> </table>		<u>Incremental:</u>	<u>Step/Direction:</u>	<u>EIA/TIA 568A colors:</u>	1	A+	Step+	Green/White	2	A-	Step-	Green	3	B+	Direction+	Orange/White	4	Z+	Zero+	Blue	5	Z-	Zero-	Blue/White	6	B-	Direction-	Orange	7	CAN_H (GP)	CAN_H (GP)	Brown/White	8	CAN_L (GP)	CAN_L (GP)	Brown	case	Shield	Shield	
	<u>Incremental:</u>	<u>Step/Direction:</u>	<u>EIA/TIA 568A colors:</u>																																						
1	A+	Step+	Green/White																																						
2	A-	Step-	Green																																						
3	B+	Direction+	Orange/White																																						
4	Z+	Zero+	Blue																																						
5	Z-	Zero-	Blue/White																																						
6	B-	Direction-	Orange																																						
7	CAN_H (GP)	CAN_H (GP)	Brown/White																																						
8	CAN_L (GP)	CAN_L (GP)	Brown																																						
case	Shield	Shield																																							
RJ-45	<p>Use twisted pair (1-2, 3-6, 4-5, 7-8) cable for wiring.</p> <p><u>Master Encoder Inputs:</u> Differential RS422, max. Input Frequency 2MHz, 240ns edge separation</p> <p><u>Master Encoder Outputs:</u> Amplified RS422 differential signals from Master Encoder IN (X10)</p> <p>CAN internally connected to X7, X8</p> <p>The CAN signals on X10/X11 are only available on GP drives. With the -DP, -RS, -DN and CO drives use X7/X8 for connection the CAN bus instead.</p> <p>All devices, which are connected to X10/X11 must be referenced to the same ground.</p>																																								
X12 :	External Position Sensor																																								
	<table border="1"> <thead> <tr> <th></th> <th><u>Incremental:</u></th> <th><u>Sin/Cos:</u></th> </tr> </thead> <tbody> <tr> <td>1</td> <td>+5V DC</td> <td>+5V DC</td> </tr> <tr> <td>2</td> <td>A-</td> <td>SIN-</td> </tr> <tr> <td>3</td> <td>B-</td> <td>COS-</td> </tr> <tr> <td>4</td> <td>Z-</td> <td>ZERO-</td> </tr> <tr> <td>5</td> <td>GND</td> <td>GND</td> </tr> <tr> <td>6</td> <td>A+</td> <td>SIN+</td> </tr> <tr> <td>7</td> <td>B+</td> <td>COS+</td> </tr> <tr> <td>8</td> <td>Z+</td> <td>ZERO+</td> </tr> <tr> <td>9</td> <td>Enc. Alarm</td> <td>Enc. Alarm</td> </tr> <tr> <td>case</td> <td>Shield</td> <td>Shield</td> </tr> </tbody> </table>		<u>Incremental:</u>	<u>Sin/Cos:</u>	1	+5V DC	+5V DC	2	A-	SIN-	3	B-	COS-	4	Z-	ZERO-	5	GND	GND	6	A+	SIN+	7	B+	COS+	8	Z+	ZERO+	9	Enc. Alarm	Enc. Alarm	case	Shield	Shield							
	<u>Incremental:</u>	<u>Sin/Cos:</u>																																							
1	+5V DC	+5V DC																																							
2	A-	SIN-																																							
3	B-	COS-																																							
4	Z-	ZERO-																																							
5	GND	GND																																							
6	A+	SIN+																																							
7	B+	COS+																																							
8	Z+	ZERO+																																							
9	Enc. Alarm	Enc. Alarm																																							
case	Shield	Shield																																							
DSUB-9 (f)	<p>Max. Input Frequency: 2MHz (Incremental RS422), 240ns edge separation 10kHz (Analog 1Vpp), 10Bit AD converted</p> <p>Sensor Supply (max. 100mA)</p> <p>Encoder Inputs: - Incremental: RS422 - Sin/Cos: 1Vpp</p> <p>Enc. Alarm In: 5V / 1mA</p>																																								

Error Codes

			Description
ERROR	WARN	EN	
OFF	Warning	Operation Enabled	Normal Operation. Warnings and Operation Enabled are displayed
On	<ul style="list-style-type: none"> ● ~ 2Hz 0..15 x Error Code High Nibble 	<ul style="list-style-type: none"> ● ~ 2Hz 0..15 x Error Code Low Nibble 	Error: The Error Code is shown by a blink code with "WARN" and "EN". The Error Byte is divided into Low and High Nibble. "WARN" and "EN" are blinking together. The error can be acknowledged. (ex.: WARN blinks 3x, EN blinks 2x; Error Code = 32h)
<ul style="list-style-type: none"> ● ~ 2Hz 	<ul style="list-style-type: none"> ● ~ 2Hz 0..15 x Error Code High Nibble 	<ul style="list-style-type: none"> ● ~ 2Hz 0..15 x Error Code Low Nibble 	Fatal Error: The Error Code is shown by a blink code with "WARN" and "EN". The Error Byte is divided into Low and High Nibble. "WARN" and "EN" are blinking together. Fatal Errors can only be acknowledged by a reset or power cycle (ex.: WARN blinks 3x, EN blinks 2x; Error Code = 32h)
<ul style="list-style-type: none"> ● ~ 4Hz 	<ul style="list-style-type: none"> ● ~ 2Hz 0..15 x Error Code High Nibble 	<ul style="list-style-type: none"> ● ~ 2Hz 0..15 x Error Code Low Nibble 	System Error. Please reinstall firmware or contact support.
<ul style="list-style-type: none"> ● ~ 0.5Hz 	<ul style="list-style-type: none"> ● ~ 0.5Hz 	On	Signal Supply 24V too low: The error and warn LEDs blink alternating if the signal supply +24V (X4.2) is less than 18VDC.

The meaning of the Error Codes can be found in the Usermanual_MotionCtrl_Software_E1100 and the user manual of the loaded interface software. These documents are provided together with LinMot-Talk configuration software and can be downloaded from www.linmot.com.

Physical Dimension

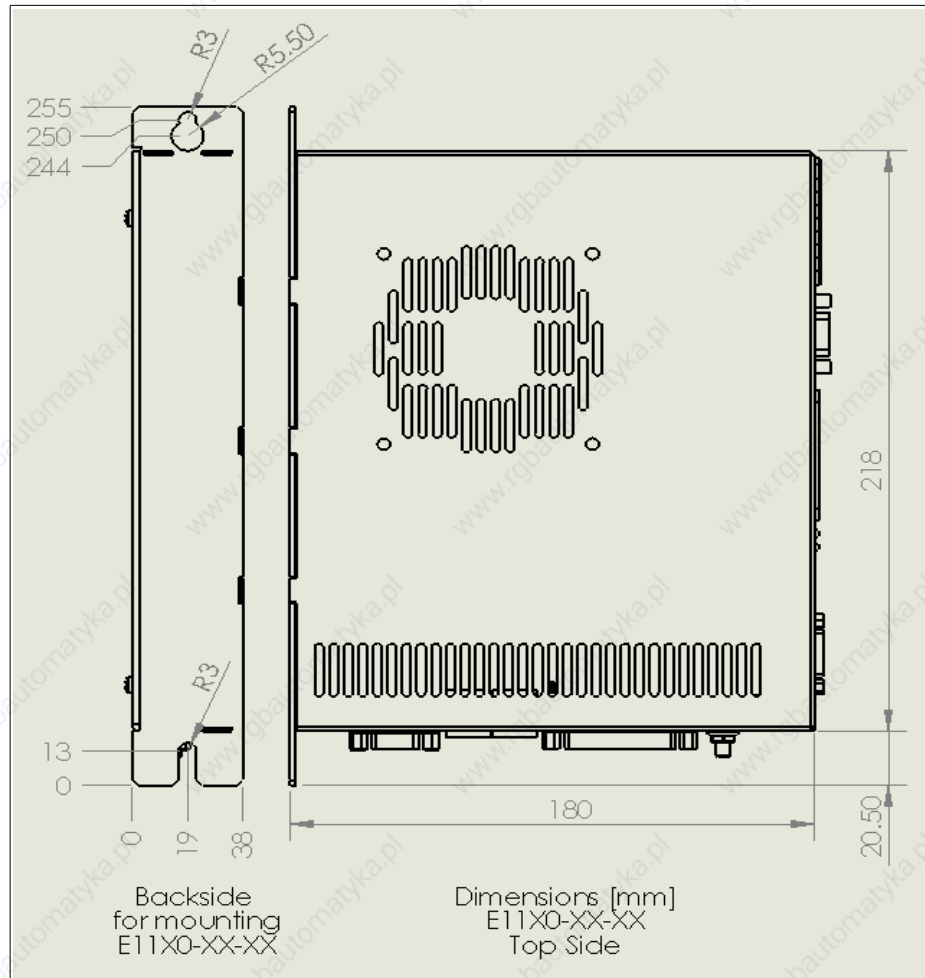

E1100 Single axes drive		
Width	mm (in)	40 (1.6)
Height	mm (in)	250 (9.9)
Height without fixings	mm (in)	218 (8.6)
Depth	mm (in)	180 (7.1)
Weight	Kg (lb)	1.5 (3.3)
Mounting Screws		2 x M5
Mounting Distance	mm (in)	237 (9.33)
Case	IP	20
Storage Temperature	°C	-25...40
Transport Temperature	°C	-25...70
Operating Temperature	°C	0...40 at rated data (UL) 40...50 with power derating
Relative humidity		95% (non-condensing)
Max. Case Temperature	°C	65
Max. Power Dissipation	W	30
Distance between Drives	mm (in)	20 (0.8) left/right 50 (2) top/bottom

() dimensions in inch

Power Supply Requirement

Motor Power Supply

The calculation of the needed power for the Motor supply is depending on the application and the used motor. The nominal supply voltage is 72 VDC. The possible range is from 24 to 85VDC, for UL from 30 to 85 VDC.

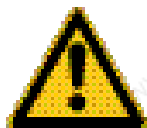

ATTENTION: The motor supply can rise up to 95 VDC when braking. This means that everything connected to that power supply needs a voltage rating of 100 VDC. (Additional capacitors, etc...). Due to high braking voltage and sudden load variations of linear motor applications, **only specially designed power supplies can be used.**

Recommended Power supplies:

Item	Description	Art. No.
T01-72/420	72VDC, 15A peak, 420VA, 3x400VAC	0150-1966
T01-72/420-US	72VDC, 15A peak, 420VA, 3x230VAC	0150-1967
T01-72/900	72VDC, 30A peak, 900VA, 3x400VAC	0150-1842
T01-72/900-US	72VDC, 30A peak, 900VA, 3x230VAC	0150-1843
T01-72/1500	72VDC, 2x30A peak, 1500VA, 3x400VAC	0150-1844
T01-72/1500-US	72VDC, 2x30A peak, 1500VA, 3x230VAC	0150-1845
S01-72/1000	72VDC, 27A peak, 1000VA, 3x340-550VAC	0150-1872
S01-72/500	72VDC, 10A peak, 500VA, 1x120/230VAC	0150-1874

Signal Power Supply

The logic supply needs a regulated power supply of a nominal voltage of 24 VDC. The voltage must be between 22 and 26 VDC.

Current consumption: min. 200mA (no load on the outputs)
 typ. 1.1A (all 10 outputs "on" with 100mA load and /Break with no load)
 max. 2.1A (all 10 outputs "on" with 100mA load and /Break with 1A load)

Regeneration of Power / Regeneration Resistor

There are two possibilities to deal with power regeneration:

Option A: Connect an additional capacitor to the motor power supply. It is recommended to use a capacitor $\geq 10'000 \mu\text{F}$ (install capacitor close to the power supply!)

Option B: Install a Regeneration Resistor to X1 (RR+ and RR-). The threshold value of the voltage depends on the used motor voltage power supply. The max. threshold value must not exceed 88 VDC.



For UL applications, use option A.

Item	Description	Art. No.
Capacitor	Capacitor 10'000 μF / 100 V	0150-3075
Regeneration Resistor	RR01-10/60 (10 Ohm, 60 W)	0150-3088
Regeneration Resistor	RR01-10/150 (10 Ohm, 150 W)	0150-3090

Ordering Information

Drive	Description	Art. No.
E1130-DP	Profibus Servo Drive, 72VDC/8A	0150-1667
E1130-DP-HC	Profibus Servo Drive, 72VDC/15A	0150-1668
E1130-DP-XC	Profibus Servo Drive, 72VDC/25A	0150-1861
E1100-RS	RS232/485 Drive, 72VDC/8A	0150-1677
E1100-RS-HC	RS232/485 Drive, 72VDC/15A	0150-1678
E1100-RS-XC	RS232/485 Drive, 72VDC/25A	0150-1862
E1100-CO	CANopen Drive, 72VDC/8A	0150-1681
E1100-CO-HC	CANopen Drive, 72VDC/15A	0150-1682
E1100-CO-XC	CANopen Drive, 72VDC/25A	0150-1683
E1100-DN	DeviceNet Drive, 72VDC/8A	0150-1679
E1100-DN-HC	DeviceNet Drive, 72VDC/15A	0150-1680
E1100-DN-XC	DeviceNet Drive, 72VDC/25A	0150-1863
E1100-GP	General Purpose, 72VDC/8A	0150-1665
E1100-GP-HC	General Purpose, 72VDC/15A	0150-1666
E1100-GP-XC	General Purpose, 72VDC/25A	0150-1864

International Certifications

Certifications	
USA and Canada 	All products marked with this symbol are tested and listed by Underwriters Laboratories and are checked quarterly by an UL inspector. This mark is valid for the USA and Canada and eases certification of your machines and systems in these areas. The E1100 series drives are listed under UL file number E316095.
Europe 	See chapter "declaration of conformity CE-Marking".

Safety notes for the installation according to UL

Markings:

- Use 60/75 °C or 75 °C copper wire only.
- Maximum ambient temperature 40°C.
- Suitable for use on a circuit capable of delivering not more than 5kA RMS symmetrical amperes, 85VDC Maximum.
- Motor over temperature sensing must be provided externally in the end-use

Terminal tightening torque:

- X1, X2: 0.5Nm (4.5 lb-in), Screw thread: M2.5
- X4: 0.22 - 0.44Nm (2 - 4 lb-in), Screw thread: M2

Wiring diagram conductor cross-section:

- X1: 2.5mm² (AWG 14)
- X4: 0.5 - 1.5mm² (AWG 21 – 14)

Ground terminal:

- Threaded Grounding Bolt: M5 (located on the lower side of the housing). Marked with 

Fuse Replacement:

CAUTION: For continued protection against risk of fire, replace only with same type and rating of fuse!

The fuses are directly soldered onto the PWB. Replacement is only possible by qualified personnel with appropriate equipment.

- Internal Fuse F2: 3AT (slow blow, Schurter OMT125, 3404.0118.xx, UL File Number: E41599)
- Internal Fuse F300: 16AT (slow blow, Schurter SMD-SPT, 0001.2716.xx, UL File Number: E41599)

Branch circuit protection of the motor power supply must be provided externally with a UL listed JDDZ RK-5 class fuse (Fusetron FRN-R-20, 20A, 125VDC, UL File E4273).

Motor Phase Wiring:

For UL applications the motor phases have to be wired on X2 and not on X3!

Regeneration Resistor:

For UL applications pins RR+ and RR- of terminal X1 must not be connected!

In case of over voltage see chapter "Regeneration of Power / Regeneration Resistor" Option A.

Drive Classification Accordance with the new Machinery Directive EN ISO 13849-1

The safety function SVE ("Safety Voltage Enable") on the LinMot drive series E1100 (on X4.12, not present on GP(-HC, -XC) drives), which is to provide the safe stop, fulfills the following criteria of the new machinery directive EN ISO 13849-1:

Category	cat = 3
Performance Level	PL = d
Diagnostic Coverage	CD = medium
Mean time to hazardous failure of one channel	MTTFd = 49.8 Years

Declaration of Conformity CE-Marking

Manufacturer: NTI AG
 LinMot®
 Haerdlistrasse 15
 8957 Spreitenbach
 Switzerland
 Tel.: +41 (0)56 419 91 91
 Fax: +41 (0)56 419 91 92

Products: LinMot® Drives

Type	Art.-No.	Type	Art.-No.	Type	Art.-No.
E1130-DP	0150-1667	E1100-DN	0150-1679		
E1130-DP-HC	0150-1668	E1100-DN-HC	0150-1680		
E1100-GP	0150-1665	E1130-DP-XC	0150-1861		
E1100-GP-HC	0150-1666	E1100-CO-XC	0150-1683		
E1100-RS	0150-1677	E1100-DN-XC	0150-1863		
E1100-RS-HC	0150-1678	E1100-RS-XC	0150-1862		
E1100-CO	0150-1681	E1100-GP-XC	0150-1864		
E1100-CO-HC	0150-1682				

The product must be mounted and used in strict accordance with the installation instruction contained within the User's Manual, a copy of which may be obtained from NTI AG.

I declare that as the authorized representative, the above information in relation to the supply/manufacture of this product is in conformity with the stated standards and other related documents in compliance with the protection requirements of the Electromagnetic Compatibility (EMC) Directive 2004/108/EC.

Standards Complied with:

EN 61000-6-2		Compliance Criteria	Immunity for industrial environment
	EN 61000-4-2	B	Electrostatic discharge immunity (ESD)
	EN 61000-4-3	A	Radiated electromagnetic field immunity
	EN 61000-4-4	B	Fast transients / burst immunity (EFT)
	EN 61000-4-5	B	Slow transients immunity (Surges)
	EN 61000-4-6	A	Conducted radio frequency immunity
EN 61000-6-4		Class	Emission for industrial environment
	EN 55022	A	Radiated Emission

Company
 NTI AG
 Spreitenbach, October 13, 2010



 Dr. Ronald Rohner / CEO NTI AG

Contact Addresses

SWITZERLAND

NTI AG
Haerdlistr. 15
CH-8957 Spreitenbach

Sales and Administration: +41-(0)56-419 91 91
office@linmot.com

Tech. Support: +41-(0)56-544 71 00
support@linmot.com

Tech. Support (Skype) : skype:support.linmot

Fax: +41-(0)56-419 91 92
Web: www.linmot.com

USA

LinMot USA Inc.
204 E Morrissey Dr.
Elkhorn, WI 53121

Sales and Administration: 877-546-3270
262-743-2555

Tech. Support: 877-804-0718
262-743-1284

Fax: 800-463-8708
262-723-6688

E-Mail: usasales@linmot.com
Web: http://www.linmotusa.com/

Please visit <http://www.linmot.com/> to find the distribution near you.

Smart solutions are...

