Synchronous Servomotors

Series GOLDLINE™ BH

Already published editions

Edition	Comments
09 / 98	First edition
03 / 99	Completion of the motor series

**Technical changes to improve the performance of the equipment
may be made without prior notice!**

Printed in the Federal Republic of Germany 03/99

Mat.No.: 91678



All rights reserved. No part of this work may be reproduced in any form (by printing, photocopying, microfilm or any other method) or stored, processed, copied or distributed by electronic means without the written permission of Seidel Corporation.

Contents	Drawing	Page
Contents		3
Safety Notes		4
Important Notes		5
Manufacturer Declaration		6
I General		
I.1 About this manual		7
I.2 Prescribed usage of the motors		7
I.3 Design of the motors		8
I.4 General technical data		8
I.5 Standard features		9
I.5.1 Style		9
I.5.2 Shaft end, A-side		9
I.5.3 Flange		9
I.5.4 Protection class		9
I.5.5 Protective device	- E.4.929.4/9	9
I.5.6 Insulation material class		10
I.5.7 Vibration class		10
I.5.8 Connection method		10
I.5.9 Resolver		10
I.5.10 Holding brake	- A.4.031.1/35	10
I.6 Options	- A.4.033.4/7	11
I.7 Selection criteria		11
I.8 Technical data		12
I.8.1 Definitions		12
I.8.2 Technical data GOLDLINE™ BH		13
II Installation and Commissioning		
II.1 Important notes		15
II.2 Assembly and Wiring		16
II.2.1 Connection methods		18
II.3 Commissioning		19
III Drawings		
III.1 Motors with Sockets		21
III.1.1 Dimensions GOLDLINE™ BH-1xx..4xx		21
III.1.2 Radial-/Axial Forces at the shaft end	- A.4.033.3/1, 4/5	21
III.1.3 Wiring GOLDLINE™ BH-1xx..4xx	- A.4.033.4/3	22
III.1.4 Performance curve GOLDLINE™ BH-122-A		23
III.1.5 Performance curve GOLDLINE™ BH-124-B	- A.4.033.3/35, 36	23
III.1.6 Performance curve GOLDLINE™ BH-126-B		24
III.1.7 Performance curve GOLDLINE™ BH-222-B	- A.4.033.3/37, 38	24
III.1.8 Performance curve GOLDLINE™ BH-224-B		25
III.1.9 Performance curve GOLDLINE™ BH-226-C	- A.4.033.3/26, 39	25
III.1.10 Performance curve GOLDLINE™ BH-226-E		26
III.1.11 Performance curve GOLDLINE™ BH-422-D	- A.4.033.3/40, 41	26
III.1.12 Performance curve GOLDLINE™ BH-424-B		27
III.1.13 Performance curve GOLDLINE™ BH-424-D	- A.4.033.3/27, 42	27
III.1.14 Performance curve GOLDLINE™ BH-426-B		28
III.1.15 Performance curve GOLDLINE™ BH-426-D	- A.4.033.3/30, 43	28
III.2 Motors with terminal box		29
III.2.1 Dimensions GOLDLINE™ BH-6xx..8xx		29
III.2.2 Radial-/Axial forces at the shaft end	- A.4.033.3/2, 4/6	29
III.2.3 Wiring GOLDLINE™ BH-6xx..8xx	- A.4.033.4/4	30
III.2.4 Performance curve GOLDLINE™ BH-622-B		31
III.2.5 Performance curve GOLDLINE™ BH-624-C	- A.4.033.3/28, 44	31
III.2.6 Performance curve GOLDLINE™ BH-624-D		32
III.2.7 Performance curve GOLDLINE™ BH-626-E	- A.4.033.3/29, 34	32
III.2.8 Performance curve GOLDLINE™ BH-822-D		33
III.2.9 Performance curve GOLDLINE™ BH-824-A	- A.4.033.3/45, 46	33
III.2.10 Performance curve GOLDLINE™ BH-824-D		34
III.2.11 Performance curve GOLDLINE™ BH-826-C	- A.4.033.3/31, 47	34
III.2.12 Performance curve GOLDLINE™ BH-826-D		35
III.2.13 Performance curve GOLDLINE™ BH-828-B	- A.4.033.3/48, 49	35
IV Appendix		
IV.1 Delivery package, transport, storage, maintenance, disposal		37
IV.2 Fault-finding		38
IV.3 Index		39

Safety Notes

- Only properly qualified personnel are permitted to perform such tasks as transport, assembly, commissioning and maintenance. Properly qualified personnel are persons who are familiar with the transport, assembly, installation, commissioning and operation of motors, and who have the appropriate qualifications for their jobs. The qualified personnel must know and observe the following standards and regulations:
 IEC 364 resp. CENELEC HD 384 or DIN VDE 0100
 IEC report 664 or DIN VDE 0110
 national regulations for safety and accident prevention or VBG 4
- Read the available documentation before assembly and commissioning. Incorrect handling of the motors can result in injury and damage to persons and machinery. Keep strictly to the technical data and the information on the connection requirements (nameplate and documentation).
- It is vital that you ensure that the motor housing is safely earthed to the PE(protective earth) busbar in the switch cabinet. Electrical safety is impossible without a low-resistance earth connection.
- Do not unplug any connectors during operation. This creates the danger of death, severe injury, or extensive material damage.
- Power connections may be live even when the motor is not rotating. Never disconnect the power connections of the motor while the equipment is energised. This can cause flashovers with resulting injuries to persons and damage to the contacts.
- After disconnecting the servo-amplifier from the supply voltage, wait at least five minutes before touching any components which are normally live (e.g. contacts, screw connections) or opening any connections. The capacitors in the servo-amplifier can still carry a dangerous voltage up to five minutes after switching off the supply voltages. To be quite safe, measure the DC-link voltage and wait until the voltage has fallen below 40V.
- The surfaces of the motors can be very hot in operation, according to their protection category. The surface temperature can reach 100°C. Measure the temperature, and wait until the motor has cooled down below 40°C before touching it.
- Remove any fitted key (if present) from the shaft before letting the motor run independently, to avoid the dangerous results of the key being thrown out by centrifugal forces.

Symbols used in this manual

	Danger to personnel from electricity and its effects		General warning general instructions mechanical hazard
⇒	See chapter (cross-reference)	●	Special emphasis

Important Notes

- **Servomotors are precision equipment. The flange and shaft are especially vulnerable during storage and assembly — so avoid brute force. Precision requires delicacy. It is important to use the locking thread which is provided to tighten up couplings, gear wheels or pulley wheels and warm up the drive components, where possible. Blows or the use of force will lead to damage to the bearings and the shaft.**

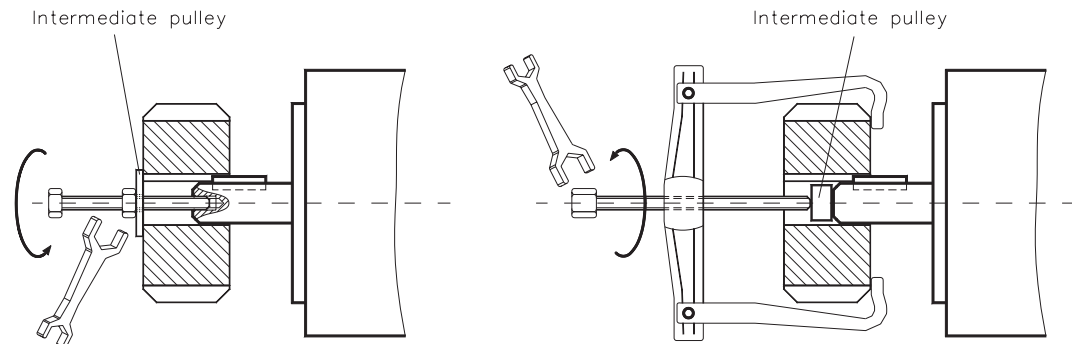

- **Wherever possible, use only backlash-free, frictionally-locking collets or couplings, e.g. from the manufacturers Baumann & Cie, Gerwah, Jacob, KTR or Ringspann. Ensure correct alignment of the couplings. A displacement will cause unacceptable vibration and the destruction of the bearings and the coupling.**
- **For toothed belts, it is vital to observe the permissible radial forces. An excessive radial load on the shaft will significantly shorten the life of the motor.**
- **Avoid axial loads on the motor shaft, as far as possible. Axial loading significantly shortens the life of the motor.**
- **In all cases, do not create a mechanically constrained motor shaft mounting by using a rigid coupling with additional external bearings (e.g. in a gearbox).**
- **For mounting style V3 (shaft end upwards), make sure that no liquid can enter the upper bearing.**
- **Take note of the no. of motor poles and the no. of resolver poles and ensure that the correct setting is made in the servo-amplifier which is used. An incorrect setting can lead to the destruction of the motor, especially with small motors.**

Manufacturer Declaration

According to the EG-Machine-guideline 89/392/EWG, appendix II B

we, the company

Seidel Servo Drives GmbH
 Wacholderstraße 40-42
 40489 Düsseldorf

declare, that the product

Motor series GOLDLINE™ BH

is intended exclusively, in its standard version, for installation in another machine and that its commissioning is forbidden until it has been established that the machine into which this product is to be installed conforms to the provisions of the EC Directive in its version 89/392/EEC.

We confirm that the above-mentioned product conforms to the following standards:

73/23/EWG	Low voltage directive
VDE 0530 / DIN 57530	Provisions for rotating machinery
DIN 42950	Design
DIN 748	Cylindrical shaft ends
DIN 6885	Fitted key
DIN 42955	True running, coaxiality and concentricity
DIN ISO 2373	Vibration class

Issued by: Management

R.Seidel

This Declaration does not contain any assurance of properties. The notes on safety and protection in the operating instructions must always be observed.

I General

I.1 About this manual

This manual describes the **GOLDLINE™** BH series of synchronous servomotors.

The manual is divided into 4 chapters:

- Description of the motors, technical data Chapter I
- Installation, commissioning of the motors Chapter II
- Dimensions, Wiring diagrams and performance curves Chapter III
- Transport, storage, maintenance, disposal of the motors Chapter IV



This Manual is intended for the use of qualified staff with professional knowledge of electrical and mechanical engineering .

The motors are operated in drive systems together with servo-amplifiers from the **SERVOSTAR™** 600 family. Please observe the entire system documentation, consisting of:

- Installation and commissioning instructions for the servo-amplifier
- Installation and commissioning instructions for any expansion card which is connected
- Operating manual for the Operator Software of the servo-amplifier
- Technical description of the **GOLDLINE™** BH series of motors

I.2 Prescribed usage of the motors

The **GOLDLINE™** BH series of synchronous servomotors is designed especially for drives for industrial robots, machine tools, textile and packing machinery and similar with high requirements for dynamics.

The user is **only** permitted to operate the motors under the ambient conditions which are defined in this documentation.

The **GOLDLINE™** BH series of motors is **exclusively** intended to be driven by servo-amplifiers from the **SERVOSTAR™** 600 series under speed and / or torque control.

The motors are installed as components in electrical apparatus or machines and can only be commissioned and put into operation as integral components of such apparatus or machines.

The motors must never be connected directly to the mains supply.

The thermal contact which is integrated in the motor windings must be observed and evaluated.

The conformity of the servo-system to the standards mentioned in the manufacturers declaration on page 6 is only guaranteed when the components (servo-amplifier, motor, leads etc.) that are used have been supplied by us.

I.3 Design of the motors

Synchronous servomotors in the **GOLDLINE™** BH series are brushless DC motors for demanding servo applications. When combined with our digital servo-amplifiers they are especially suited for positioning tasks in industrial robots, machine tools, transfer lines etc. with high requirements for dynamics and stability.

The servomotors have permanent magnets in the rotor. The rare earth neodymium-iron-boron magnetic material is an important factor in making it possible to drive these motors in a highly dynamic fashion. A three-phase winding which is driven by the servo-amplifier is integrated into the stator. The motor does not have any brushes since commutation is performed electronically by the servo-amplifier.

The temperature of the winding is monitored by temperature sensors in the stator windings and is signalled via an electrically isolated contact (normally closed).

A **resolver** is built into the motors as a feedback element. The servo-amplifiers in the **SERVOSTAR™** 600 series evaluate the resolver (hence rotor) position and supply sinusoidal currents to the motors.

The motors can be delivered with or without a built-in holding brake. Retrofitting of the brake is not possible.

The motors are enamelled in matt black (RAL 9005). This finish is not resistant against solvents (e.g. trichlorethylene, nitro-thinners, or similar).

I.4 General technical data

Climate category	3K3 to EN 50178
Ambient temperature (at rated values)	5...+40°C for site altitude up to 1000m amsl It is vital to consult our applications department for ambient temperatures above 40°C and encapsulated mounting of the motors.
Permissible humidity (at rated values)	85% rel. humidity, no condensation
Power derating (currents and torques)	1% / K in range 40°C...50°C up to 1000m amsl for site altitude above 1000m amsl and 40°C 6% up to 2000m amsl 17% up to 3000m amsl 30% up to 4000m amsl 55% up to 5000m amsl No derating for site altitudes above 1000m amsl with temperature reduction of 10K / 1000m
Max. permissible flange temperature	65°C ± 10% at rated values
Ball-bearing life	≥ 20.000 operating hours
Technical data	⇒ I.8
Storage data	⇒ IV.1

I.5 Standard features

I.5.1 Style

The basic style for the **GOLDLINE™** BH synchronous motors is style IM B5 according to DIN42950. The permitted mounting positions may be read from the technical data of the motor series.

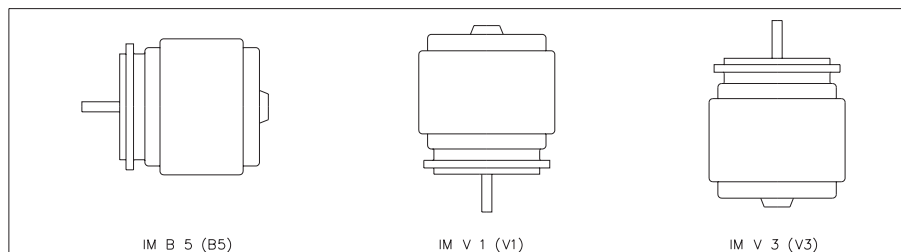

I.5.2 Shaft end, A-side

Power transmission is made through the cylindrical shaft end A (fit k6) to DIN 748, with a locking thread and with a fitted keyway according to DIN6885, shape A.

If the motors drive via pinions or toothed belts, then high radial forces will occur. The permissible values at the end of the shaft may be read from the diagram in chapter III.1.2 and III.2.2. The maximum values at rated speed you will find at the technical data. Power take-off from the middle of the free end of the shaft allows a 10% increase in F_R .

The curves are based on a bearing life of 20.000 operating hours.

The axial force F_A must not exceed $F_R/3$.

Double-coned collets have proved to be ideal zero-backlash coupling devices, combined, if required, with metal bellows couplings.

I.5.3 Flange

Flange dimensions to IEC standard, fit j6, accuracy according to DIN 42955.

Tolerance class : N

I.5.4 Protection class

Standard version	IP65
Standard shaft bushing	IP64
Shaft bushing with shaft-sealing ring (Option -J-)	IP65

I.5.5 Protective device

The standard version of each motor is fitted with a thermostat (electrically isolated, normally closed). You will find the switching point at the technical data. The thermostat does **not** provide any protection against short, heavy overloading. Provided that our preassembled resolver cable is used, the thermostat contact is integrated into the monitoring system of the digital servo-amplifier **SERVOSTAR™ 600**.

The flange temperature must not exceed 65°C in rated operation.

I.5.6 Insulation material class

You will find the insulation material class according to DIN 57530 at the technical data.

I.5.7 Vibration class

The motors are made to vibration class N according to DIN ISO 2373 .

I.5.8 Connection method

<u>Motorseries</u>	<u>Resolver</u>	<u>Power</u>
BH-1xx-x...4xx-x	connector	connector
BH-6xx-x...8xx-x	connector	terminal box

The mating connectors are not part of the delivery package. We can supply preassembled resolver and power leads (⇒ II.2.1).

I.5.9 Resolver

The motors are equipped with two-pole hollow-shaft resolvers.

I.5.10 Holding brake

The motors are optionally available with a holding brake mounted.

Type designation : BH-xxx-x-G

A permanent magnet brake (24V DC) is integrated into the G-motors. When this brake is de-energized it blocks the rotor. **The holding brakes are designed as standstill brakes** and are not suited for repeated operational braking. If the brake is released then the rotor can be moved without a remanent torque, the operation is not free from backlash! The motorlength increases when a holding brake is mounted.

The holding brake can be controlled directly by and SERVOSTAR™ 600-servo-amplifier (no personal safety !), the winding is suppressed in the servo-amplifier — additional circuitry is not required..

If the holding brake is not controlled directly by the servo-amplifier, an additional wiring (e.g. varistor) is required. Consult our applications department beforehand.

A personal safe operation of the holding brake requires an additional contact (normally opened) in the braking circuit and an anti-surge-device (e.g. Varistor) for the brake.

Wiring example for SERVOSTAR™ 600:

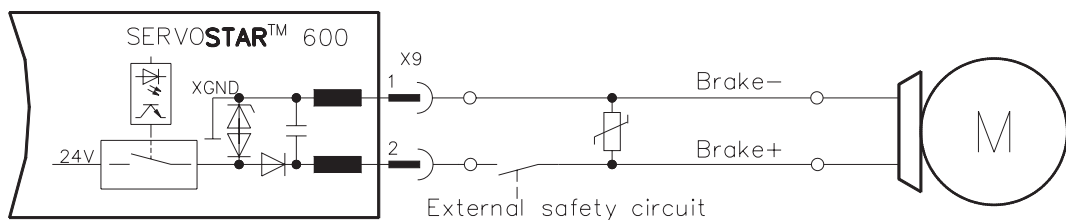

I.6 Options

- 09- Special flanges and shafts are possible, we invite inquiries.
- G- Motor holding brake (24V), mounted.
The motor length does not increase with a mounted brake.
- J- Radial shaft-sealing rings:
A radial shaft-sealing ring can be supplied at extra charge to seal against oil mist and oil spray. This increases the protection rating of the shaft bushing to IP65. The sealing ring is not suitable for dry running.
- 426- encoder adaptor for ROD426/ROQ425 with coupling (6mm shaft diameter) and excentric washers

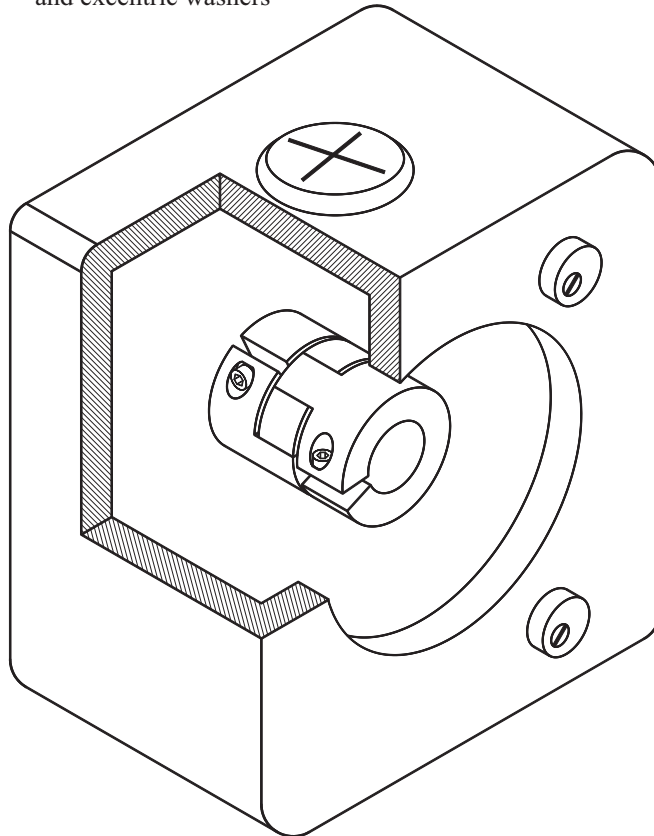

I.7 Selection criteria

The three-phase servomotors are designed to operate with Seidel servo-amplifiers from the SERVOSTAR™ 600 series. Together, both units form a closed speed or torque control loop.

The most important selection criteria are:

- | | | |
|---------------------------------------|-----------|----------------------|
| — Standstill torque | M_0 | [Nm] |
| — Rated speed | n_n | [min ⁻¹] |
| — Moment of inertia of motor and load | J | [kgcm ²] |
| — Effective torque (calculated) | M_{rms} | [Nm] |

When calculating the motors and servo-amplifiers which are required, take account of the static load **and** the dynamic load (acceleration/braking). Collected formulae and examples of the calculations are available from our applications department.

I.8 Technical data

I.8.1 Definitions

Standstill torque M_0 [Nm]

The standstill torque can be maintained indefinitely at a speed $n=0 \text{ min}^{-1}$ and rated ambient conditions.

Rated torque M_n [Nm]

The rated torque is produced when the motor is drawing the rated current at the rated speed. The rated torque can be produced indefinitely at the rated speed in continuous operation (S1).

Standstill $I_{0\text{rms}}$ [A]

The standstill current is the effective sinusoidal current which the motor draws during standstill to produce the standstill torque.

Rated current I_{nrms} [A]

The rated current is the effective sinusoidal current which the motor draws at the rated speed in order to produce the rated torque.

Peak current (pulse current) $I_{0\text{max}}$ [A]

The peak current (effective sinusoidal value) should not exceed 3.5-times the rated current. The actual value is determined by the peak current of the servo-amplifier which is used.

Torque constant K_{Trms} [Nm/A]

The torque constant defines how much torque in Nm is produced by the motor with 1A r.m.s. current. The relationship is $M=I \times K_T$

Voltage constant K_{Erms} [V/1000min⁻¹]

The voltage constant defines the induced motor EMF, as an rms value between two terminals, per 1000 r.p.m.

Rotor moment of inertia J [kgcm²]

The constant J is a measure of the acceleration capability of the motor. For instance, at I_0 the acceleration time t_b from 0 to 3000 r.p.m. is given as:

$$t_b [s] = \frac{3000 \times 2\pi \times m^2}{M_0 \times 60s \times 10^4 \times cm^2} \times J \quad \text{with } M_0 \text{ in Nm and } J \text{ in kgcm}^2$$

Thermal time constant t_{th} [min]

The constant t_{th} defines the time for the cold motor, under a load of I_0 , to heat up to an overtemperature of 0.63×115 Kelvin. This temperature rise happens in a much shorter time when the motor is loaded with the rated current.

Release delay time t_{BRH} [ms] / Application delay time t_{BRL} [ms] of the brake

These constants define the response times of the holding brake when operated with the rated voltage from the digifas™ or the SERVOSTAR™ 600 servo-amplifier.

I.8.2 Technical data GOLDLINE™ BH

Data	Sym	Dim	GOLDLINE™ BH-122-A	GOLDLINE™ BH-124-B	GOLDLINE™ BH-126-B	GOLDLINE™ BH-222-B	GOLDLINE™ BH-224-B	GOLDLINE™ BH-226-C	GOLDLINE™ BH-226-E	GOLDLINE™ BH-422-D	GOLDLINE™ BH-424-B	GOLDLINE™ BH-424-D	GOLDLINE™ BH-426-B	
Standstill torque	M_0	Nm	0,7	1,3	1,9	2,1	3,8	5,5	5,6	5,8	11,3	11,1	15,8	
Standstill current	I_{0rms}	A	1,0	1,8	2,6	1,3	2,2	4,4	3,0	4,0	4,2	6,3	8,1	
Rated speed at 400V	n_n	min ⁻¹	6000	6000	6000	3000	3000	4000	2500	3600	2000	3000	2500	
Torque constant	K_{Trms}	Nm/A	0,70	0,74	0,74	1,62	1,70	1,25	1,86	1,45	2,69	1,75	1,95	
Voltage constant	K_{Erms}	mV/min ⁻¹	42,6	44,9	44,9	98	103	75,4	112	87,4	162	106	118	
Mains voltage	U_n	V	400 / 480											
Rated torque at 400V	M_n	Nm	0,6	1,2	1,7	2,0	3,5	4,8	3,9	5,2	10,8	10	14,4	
Rated current	I_n	A	0,85	1,6	2,3	1,2	2	3,8	2,6	3,4	4	5,6	7,2	
Rated power	P_n	kW	0,38	0,76	1,1	0,63	1,1	2,0	1,3	1,9	2,2	3,1	4,4	
Peak current	I_{0max}	A	3,6	6,3	9	4,6	8	16	11,5	14,4	14	22,5	27	
Motorpolzahl	p_{Mot}	-	4											
Motor pole no.	p_{Res}	-	2											
Winding resistance Phase-Phase	R_{20}	Ω	34,9	12,4	8,2	35,4	12,5	3,9	8,5	6,1	6,3	3,3	2,1	
Winding inductance Phase-Phase	L	mH	120	58	38	272	152	44	92	89	134	60	48	
Insulation class	-	-	H (DIN 57530)											
Switch point thermal contact	-	°C	170±5											
Mechanics (Dimensions ⇒ III.1.1)														
Design	-	-	IM B5(V1,V3), (DIN 42950)											
Rotor moment of inertia	J	kgcm ²	0,3	0,46	0,76	1,0	1,7	2,5	2,5	3,2	7	6,6	10	
Static friction torque	M_R	Nm	0,04	0,05	0,07	0,08	0,09	0,1	0,1	0,24	0,26	0,26	0,29	
Radial load permitted at shaft end with n_n	F_R	N	200			260	280			300	400	500	400	500
Axial load permitted at shaft end with n_n	F_A	N	70			100				170				
Tolerance class flange	-	-	N (DIN 42955)											
Vibration class	-	-	N (DIN ISO2373)											
Thermal time constant	t_{TH}	min	10	11	12	18	20	20	21	22	25	25	28	
Weight standard	G	kg	2,5	3,2	3,9	4,1	6,2	7,6	7,6	8,4	12,5	12,5	16	
Order number standard	-	-	91452	91454	91456	91458	91460	89130	91463	91465	90684	91468	89128	
Connectors														
EMV-RES connector	-	-	Socket, 12 poles											
RES cable, shielded	-	mm ²	4 x 2 x 0,25											
Power connection	-	-	Socket, 8 poles											
Motor cable, shielded	-	mm ²	4x1...4x1,5 (+ 2x0,75 for brake)											
Holding brake														
Holding torque	M_{BR}	Nm	2,3			6				8				
Operating voltage	U_{BR}	V=	24											
electrical power	P_{BR}	W	20			30				22				
Moment of inertia	J_{BR}	kgcm ²	0,02			0,02				0,59				
Release delay time	t_{BRH}	ms	200			250				250				
Application delay time	t_{BRL}	ms	100			100				100				
Weight of the brake	G_{BR}	kg	1,1			1,6				2,4				
Order number with -G-	-	-	91453	91455	91457	91459	91461	91462	91464	91466	91467	91469	91471	
max. Ø of the motor cable	-	mm	13,5											

Data	Sym	Dim	GOLDLINE™ BH-426-D	GOLDLINE™ BH-622-B	GOLDLINE™ BH-624-D	GOLDLINE™ BH-624-C	GOLDLINE™ BH-626-E	GOLDLINE™ BH-822-D	GOLDLINE™ BH-824-D	GOLDLINE™ BH-824-A	GOLDLINE™ BH-826-C	GOLDLINE™ BH-826-D	GOLDLINE™ BH-828-B	
Standstill torque	M_0	Nm	15,5	14,9	25,8	27,6	35,4	34,7	66	66	93	93	124	
Standstill current	I_{0rms}	A	9,7	8,4	12,4	19	20	18,1	32	37	39,7	52	50	
Rated speed at 400V	n_n	min ⁻¹	3000	3000	2500	3600	3000	3000	2500	3000	2500	3000	2500	
Torque constant	K_{Trms}	Nm/A	1,6	1,77	2,07	1,48	1,8	1,92	2,08	1,8	2,34	1,8	2,5	
Voltage constant	K_{Erms}	mV/min ⁻¹	96	107	125	90	108	116	126	108	141	103	150	
Mains voltage	U_n	V	400 / 480											
Rated torque at 400V	M_n	Nm	13,5	12,7	23,7	18,4	24,9	30	48,1	43,9	55,1	47,5	75,7	
Rated current	I_n	A	9,5	6,7	11,1	12,2	14,4	15,1	23	22,5	20,3	24	35	
Rated power	P_n	kW	4,1	3,7	7,2	7,5	8,2	9,1	12,3	12	12,4	12,8	17,2	
Peak current	I_{0max}	A	32	37,7	44	62	74	66,8	118	137	145	200	175	
Motor pole no.	p_{Mot}	-	4	6										
Resolver pole no.	p_{Res}	-	2											
Winding resistance Phase-Phase	R_{20}	Ω	1,45	1,91	1,01	0,53	0,43	0,583	0,233	0,155	0,167	0,088	0,112	
Winding inductance Phase-Phase	L	mH	33	32	23	10	10,7	20,8	11	7,3	9	4,7	4,7	
Insulation class	-	-	H (DIN 57530)											
Switch point thermal contact	-	°C	170±5											
Mechanics (Dimensions ⇒ III.1.1 and III.2.1)														
Design	-	-	IM B5(V1, V3), (DIN 42950)											
Rotor moment of inertia	J	kgcm ²	10	10,3	20,3	20,3	30,4	48,8	84	84	126	126	168	
Static friction torque	M_R	Nm	0,29	0,49	0,52	0,52	0,9	0,64	0,9	0,9	1,38	1,4	1,8	
Radial load permitted at shaft end with n_n	F_R	N	400	650				870				1050		
Axial load permitted at shaft end with n_n	F_A	N	170	210				290				330		
Tolerance class flange	-	-	N (DIN 42955)											
Vibration class	-	-	N (DIN ISO 2373)											
Thermal time constant	t_{TH}	min	18	28	33	33	38	40	48	48	55	55	57	
Weight standard	G	kg	16	16,8	23	23	30	35,8	51	51	67	67	82	
Order number standard	-	-	91472	91474	90685	90299	90301	91479	90525	90687	91483	90688	90689	
Connectors														
EMV-RES connector	-	-	Socket, 12 poles											
RES cable, shielded	-	mm ²	4 x 2 x 0,25											
Power connection	-	-	Sock.	Screw M4, in terminal box				Screw M5, in terminal box						
Motor cable, shielded	-	mm ²	4x1,5	4x2,5 (+ 2x1 for brake)				4x10		4x16				
Holding brake														
Holding torque	M_{BR}	Nm	8	48										
Operating voltage	U_{BR}	V=	24											
electrical power	P_{BR}	W	22,3	30										
Moment of inertia	J_{BR}	kgcm ²	0,59	1,27										
Release delay time	t_{BRH}	ms	250	250										
Application delay time	t_{BRL}	ms	100	100										
Weight of the brake	G_{BR}	kg	2,4	4,4				4,7						
Order number with -G-	-	-	91473	91475	91477	91476	91478	91480	91482	91481	91484	91485	91486	
max. Ø of the motor cable	-	mm	16,5 / PG21						35 / PG36					

II Installation and Commissioning

II.1 Important notes

- Check that the servo-amplifier and motor match each other. Compare the rated voltage and rated current of the unit. Carry out the wiring according to the wiring diagram in the Installation and Commissioning Instructions for the servo-amplifier. The connections to the motor are shown in the chapters III.1.3 and III.2.3. Notes on the connection methods can be found in chapter II.2.1 .
- Ensure that there is proper earthing of the servo-amplifier and the motor.
- Route the power and control cables as separately as possible from one another (separation > 20 cm). This will improve the immunity of the system to electromagnetic interference. If a motor power cable is used which includes integral brake control leads, then these brake control leads must be shielded. The shielding must be connected at both ends (see under Installation Instructions for the servo-amplifier).
- Install all cables carrying a heavy current with an adequate cross-section, as per EN 60204. The recommended cross-section can be found in the Technical data.



Caution !

If a servo-amplifier of the series SERVOSTAR™ 600 is used and the motor cable exceeds 25m, a boxed choke (type 3YL-xx, manufactured by Seidel) and motor leads with the following diameters must be used :

Servo-amplifier	chokebox	Max. cable diameter
SERVOSTAR™ 601...606	3YL-06	4 x 1mm ²
SERVOSTAR™ 610	3YL-10	4 x 1,5mm ²
SERVOSTAR™ 614	3YL-20	4 x 2,5 mm ²
SERVOSTAR™ 620	3YL-20	4 x 2,5 mm ²
SERVOSTAR™ 640	inapplicable	4 x 10 mm ²
SERVOSTAR™ 670	inapplicable	4 x 16 mm ²

- Connect up all shielding via a wide surface-area contact (low impedance) and metallized connector housings or EMC-PG glands.
- Check the compliance to the permitted radial and axial forces F_R and F_A . When you use a toothed belt drive, the **minimal** permitted diameter of the pinion e.g. follows from the equation: $d_{\min} \geq \frac{M_o}{F_R} \times 2$.
- Ensure that there is adequate heat transfer in the surroundings and the motor flange, so that the maximum permissible flange temperature of 65°C is not exceeded in S1 operation.



Caution!

Never undo the electrical connections to the motor while it is energised. A dangerous voltage, resulting from residual charge, can be still present on the capacitors up to 300 seconds after switch-off of the mains supply.

Measure the DC-link voltage and wait until it has fallen below 40V.

Even when the motor is not rotating, control and power leads may be live.

II.2 Assembly and Wiring

Only qualified staff with knowledge of mechanical engineering are permitted to assemble the motor.

Only staff qualified and trained in electrical engineering are allowed to wire up the motor.

The procedure is described as an example. A different method may be appropriate or necessary, depending on the application of the equipment.



Warning !

Protect the motor from unacceptable stresses.

Take care, especially during transport and handling, that components are not bent and that insulation clearances are not altered.

Always make sure that the motors are de-energized during assembly and wiring, i.e. No voltage may be switched on for any piece of equipment which is to be connected. Ensure that the switch cabinet remains turned off (barrier, warning signs etc.). The individual voltages will only be turned on again during commissioning



Note !

The ground symbol |||| , which you will find in the wiring diagrams, indicates that you must provide an electrical connection, with as large a surface area as possible, between the unit indicated and the mounting plate in the switch cabinet. This connection is to suppress HF interference and must not be confused with the PE (protective earth) symbol (protective measure to EN 60204).

To wire up the motor, use the wiring diagrams in the Installation and Commissioning Instructions of the SERVOSTAR™ 600 servo-amplifier which is used.

The following notes should help you to carry out the assembly and wiring in an appropriate sequence, without overlooking anything.

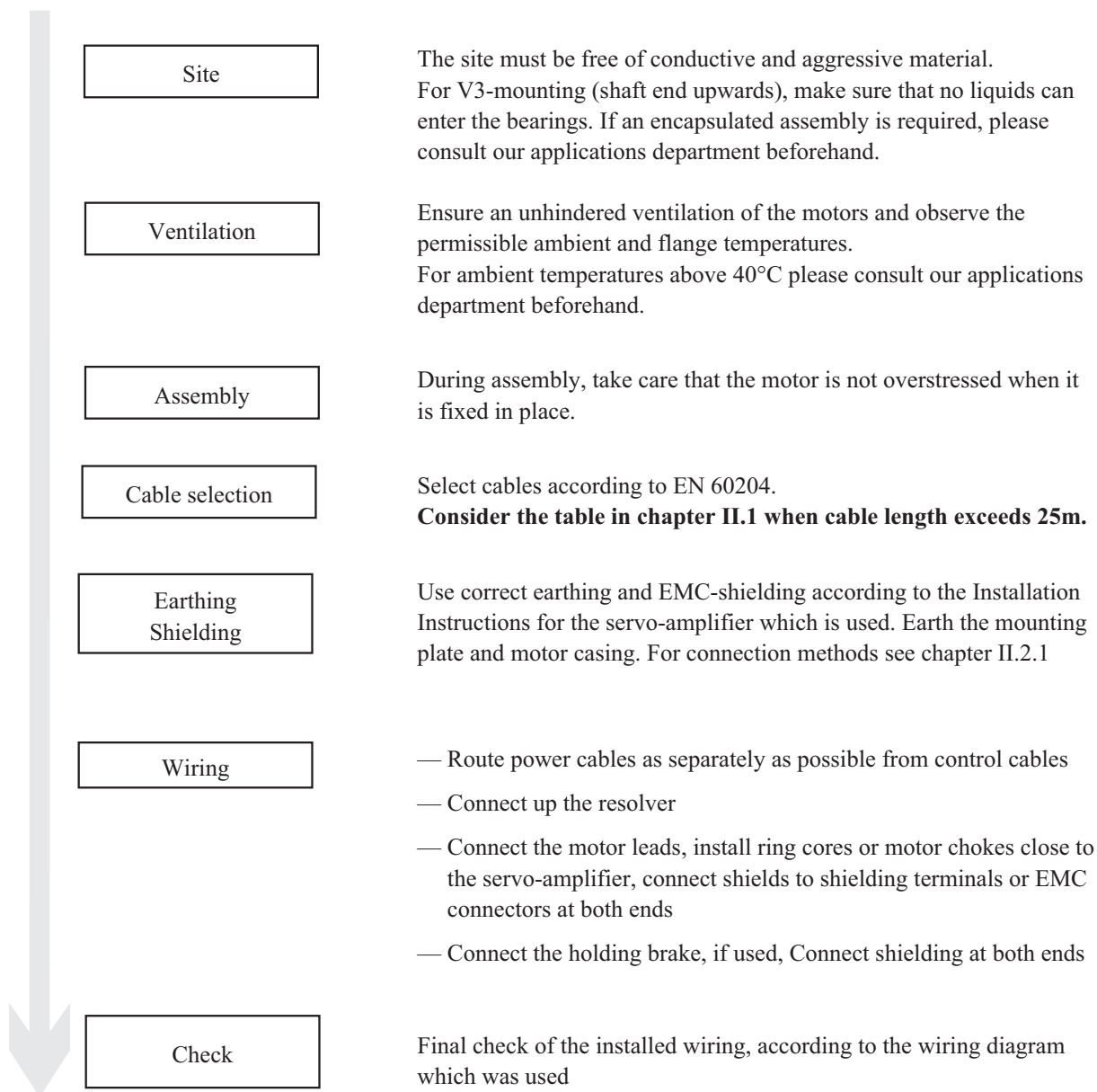

II.2.1 Connection methods

- Carry out the wiring in accordance with the valid standards and regulations.
- Only use our pre-confectioned shielded leads for the resolver and power connections.

Capacity :

- Motor lead - less than 150 pF/m
- Resolver lead - less than 120 pF/m

- Connect up the shielding according to the wiring diagrams in the Installation Instructions for the servo-amplifier.
- Incorrectly installed shielding inevitably leads to EMC interference.

In the table below you find all leads supplied by us. Further information referring to chemical, mechanical and electrical qualities can be received from our applications department.

Insulating material

- Sheathing - PUR (Polyurethane, identification 11Y)
- core insulation - PETP (Polyesteraphtalate, identification 12Y)

Capacity

- Motor lead - less than 150 pF/m
- Resolver lead - less than 120 pF/m

Techn. Data

- All leads are suitable for trailing.
- Technical data refer to mobile usage of leads.
Life time : 1 Million bending cycles
- The temperature range refers to the operation temperature.
- Identification :
 - N = numbered cores
 - F = cores with colour code according to DIN 47100
 - B = cores with letter identification
 - () = shielding

Cores [mm²]	identification	Temperature-range [°C]	Cable diameter [mm]	Bending radius [mm]	Remarks
(4x1,0)	F	-30 / +80	10	100	Motor lead
(4x1,5)	B	-30 / +80	10,5	105	
(4x2,5)	N	-5 / +70	12,6	125	
(4x4)	N	-5 / +70	12,8	130	
(4x6)	N	-5 / +70	16,1	160	
(4x10)	N	-5 / +70	19,0	190	
(4x16)	N	-5 / +70	23,3	230	
(4x1,0+(2x0,75))	F	-30 / +80	10,5	100	Motor lead with integral brake control leads
(4x1,5+(2x0,75))	B	-10 / +80	11,5	120	
(4x2,5+(2x1))	B	-30 / +80	12,5	125	
(4x2x0,25)	F	-30 / +80	6,9	60	Resolver lead

II.3 Commissioning

The procedure for commissioning is described as an example. A different method may be appropriate or necessary, depending on the application of the equipment.

Only specialist personnel with extensive knowledge in the areas of electrical engineering / drive technology are allowed to commission the drive unit of servo-amplifier and motor.



Caution !

Check that all live connection points (terminal boxes) are safe against accidental contact. Deadly voltages can occur, up to 900V.

Never undo the electrical connections to the motor when it is live. The residual charge in the capacitors of the servo-amplifier can produce dangerous voltages up to 300 seconds after the mains supply has been switched off.

The surface temperature of the motor can reach 100°C in operation. Check (measure) the temperature of the motor.

Wait until the motor has cooled down below 40°C before touching it.

Make sure that, even if the drive starts to move unintentionally, no danger can result for personnel or machinery.

Remove or fix any fitted key (if present) from the shaft before letting the motor run independently, to avoid the dangerous results of the key being thrown out by centrifugal forces, and injuring personnel./

- 
- Check the assembly and orientation of the motor.
 - Check the drive components (clutch, gear unit, belt pulley) for the correct seating and setting (observe the permissible radial and axial forces).
 - Check the wiring and connections to the motor and the servo-amplifier. Check that the earthing is correct.
 - Test the function of the holding brake, if used. (apply 24V, the brake must be released).
 - Check whether the rotor of the motor revolves freely (release the brake, if necessary). Listen out for grinding noises.
 - Check that all the required measures against accidental contact with live and moving parts have been carried out.
 - Carry out any further tests which are specifically required for your system.
 - Now commission the drive according to the commissioning instructions for the servo-amplifier.
 - In multi-axis systems, individually commission each drive unit (servo-amplifier + motor).

This page is deliberately left blank.

III Drawings

III.1 Motors with Sockets

III.1.1 Dimensions GOLDLINE™ BH-1xx..4xx

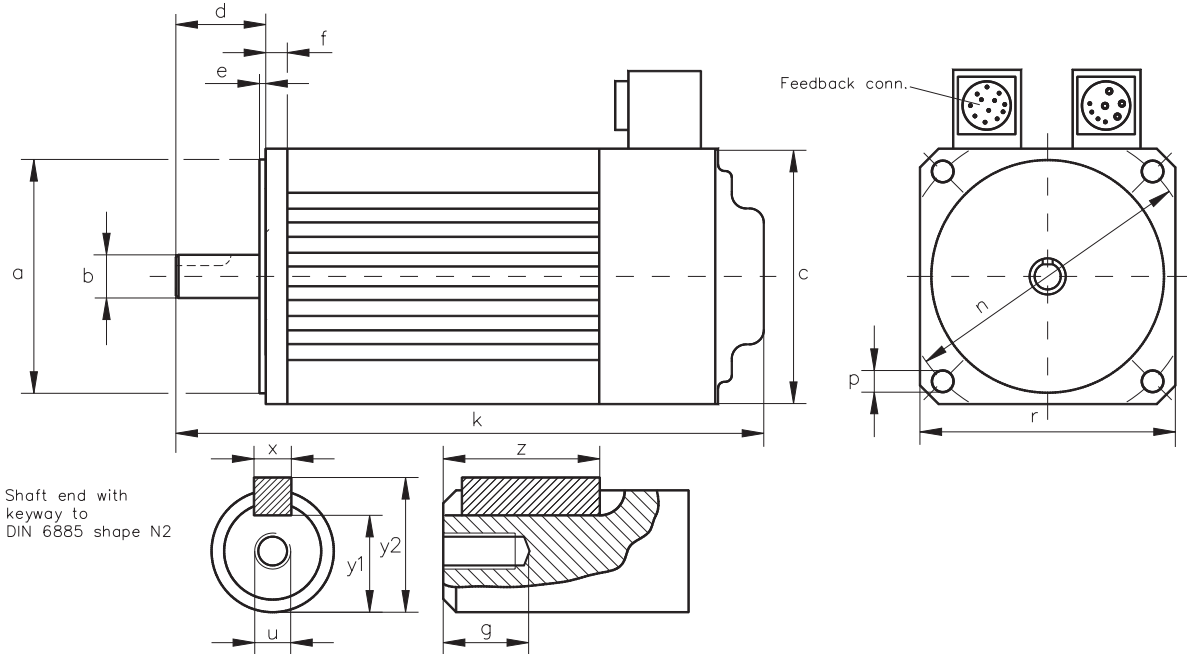

	a_{j6}	b	c	d	e	f	g	k	n	p	r	u	x	y1	y2	z
	mm	mm	mm	mm	mm	mm	mm	mm	mm	mm	mm		mm	mm	mm	mm
BH-122-A	60	11 _{j6}	70	23	2,36	9,54	10	228	75	5,8	70	M4	4	8,5	12,5	14
BH-124-B		14 _{j6}		30	2,36	9,54	17	264				M5	5	11	16	19,8
BH-126-B		14 _{j6}		30	2,36	9,54	17	295				M5	5	11	16	19,8
BH-222-B	80	14 _{j6}	92	30	3	11,2	17	266	100	7	92	M5	5	11	16	19,8
BH-224-B								306								
BH-226-C/-E								345								
BH-422-D	110	24 _{j6}	115	50	3,5	12,5	27	315	130	9	115	M8	8	20	27	37
BH-424-B/-D								369								
BH-426-B/-D								422								

III.1.2 Radial-/Axial Forces at the shaft end

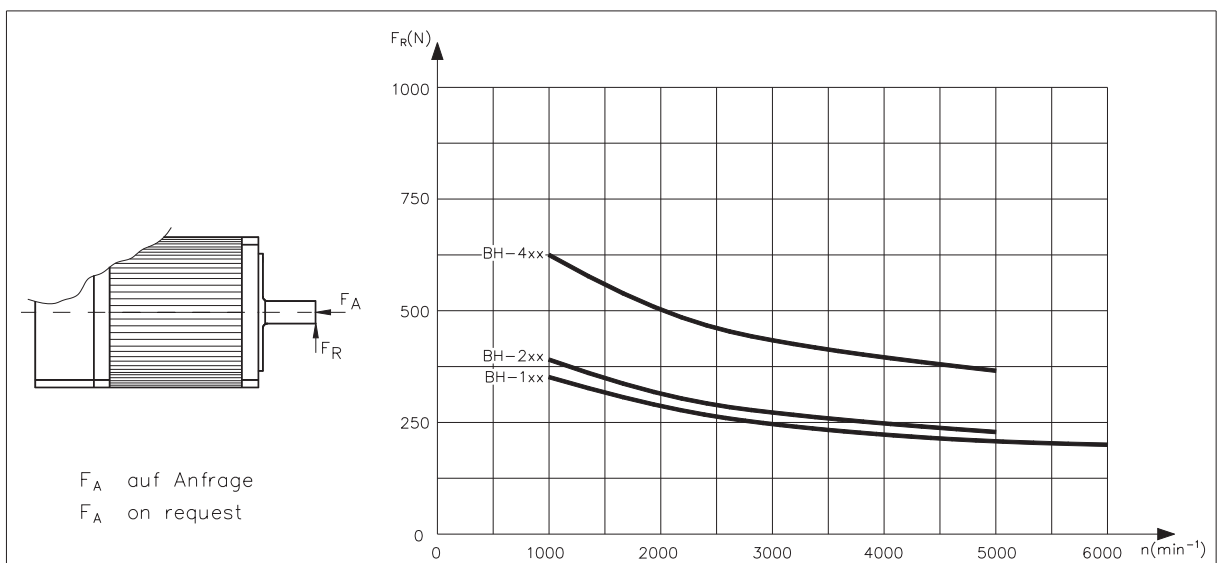

III.1.3 Wiring GOLDLINE™ BH-1xx..4xx

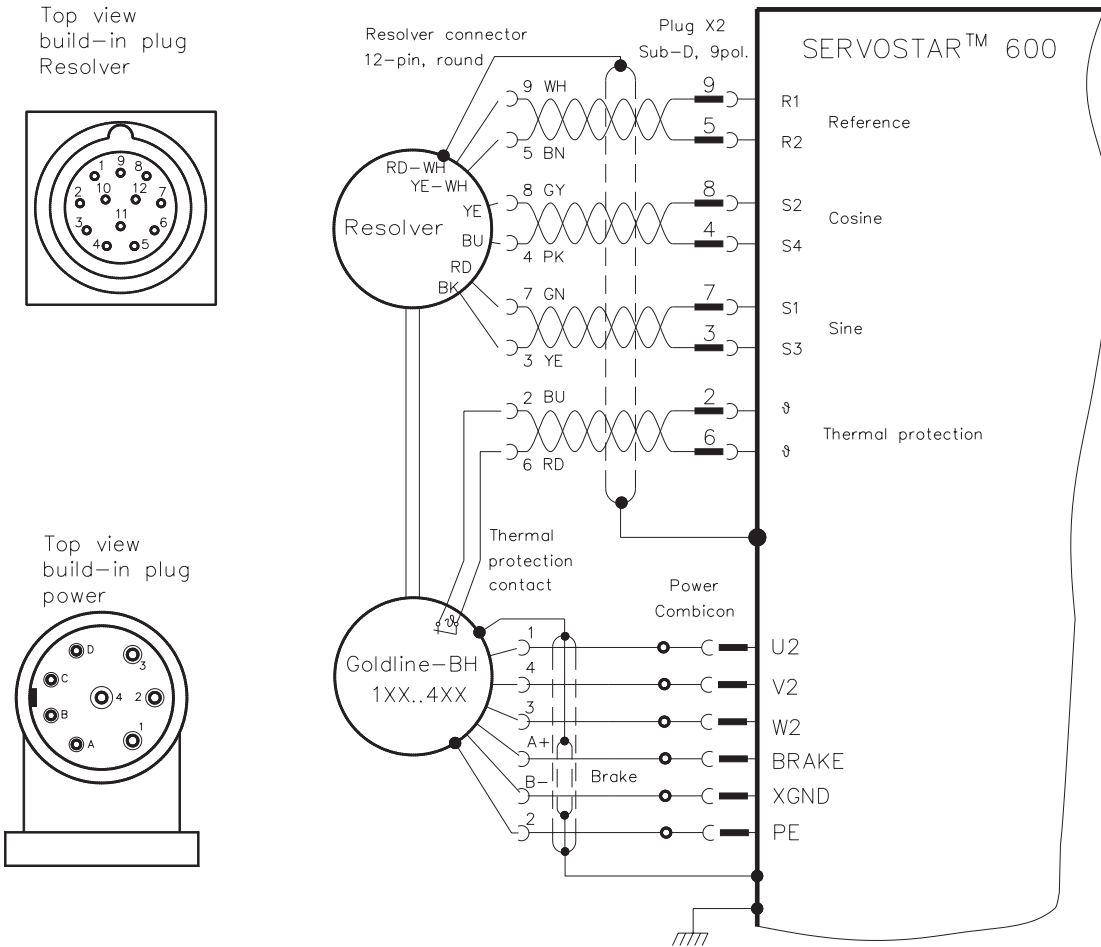

Top view build-in plug Resolver

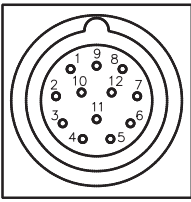

Top view build-in plug power

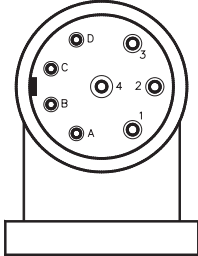

connector round, 8-poles

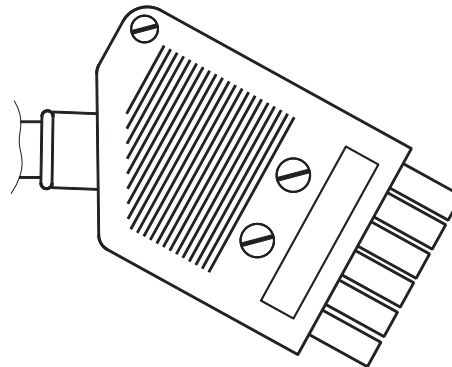
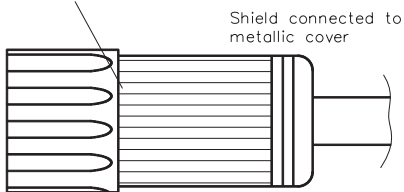

∅ (mm ²)	Mat.No.
4x1	90083
4x1+G	90088
4x1,5	89918
4x1,5+G	89957

Motor cable with conn. 5m, lead lengths up to 100m on request

connector round, 12-poles

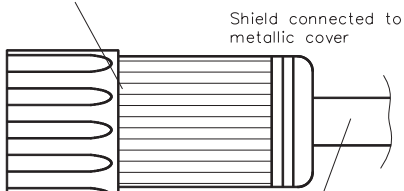

Sub-D connector 9-poles

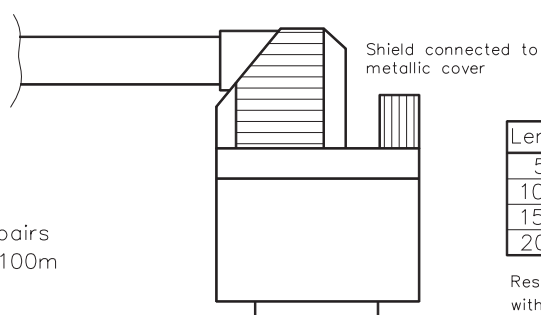

4 x 2 x 0,25 shielded, twisted pairs on request max. 100m

Length	Mat.No.
5m	84972
10m	84973
15m	84974
20m	84975

Resolver cable with connector

colour coding acc. to IEC 757

III.1.4 Performance curve GOLDLINE™ BH-122-A

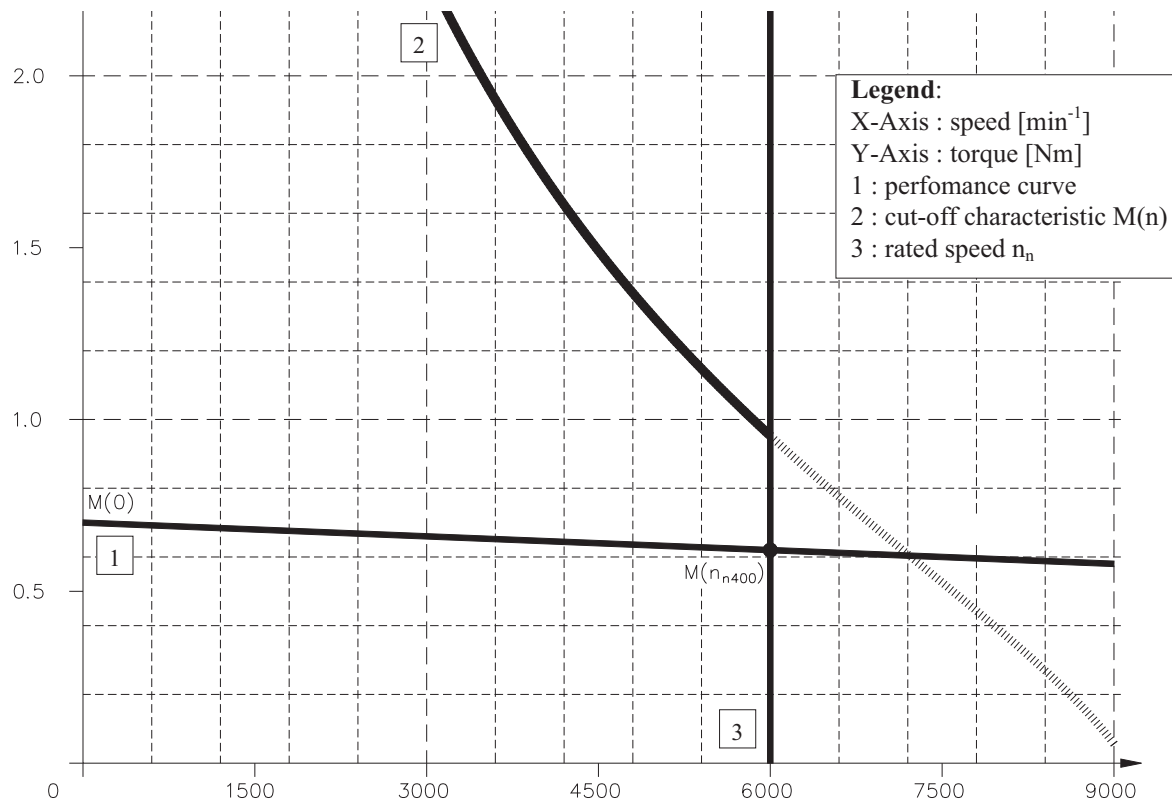

III.1.5 Performance curve GOLDLINE™ BH-124-B

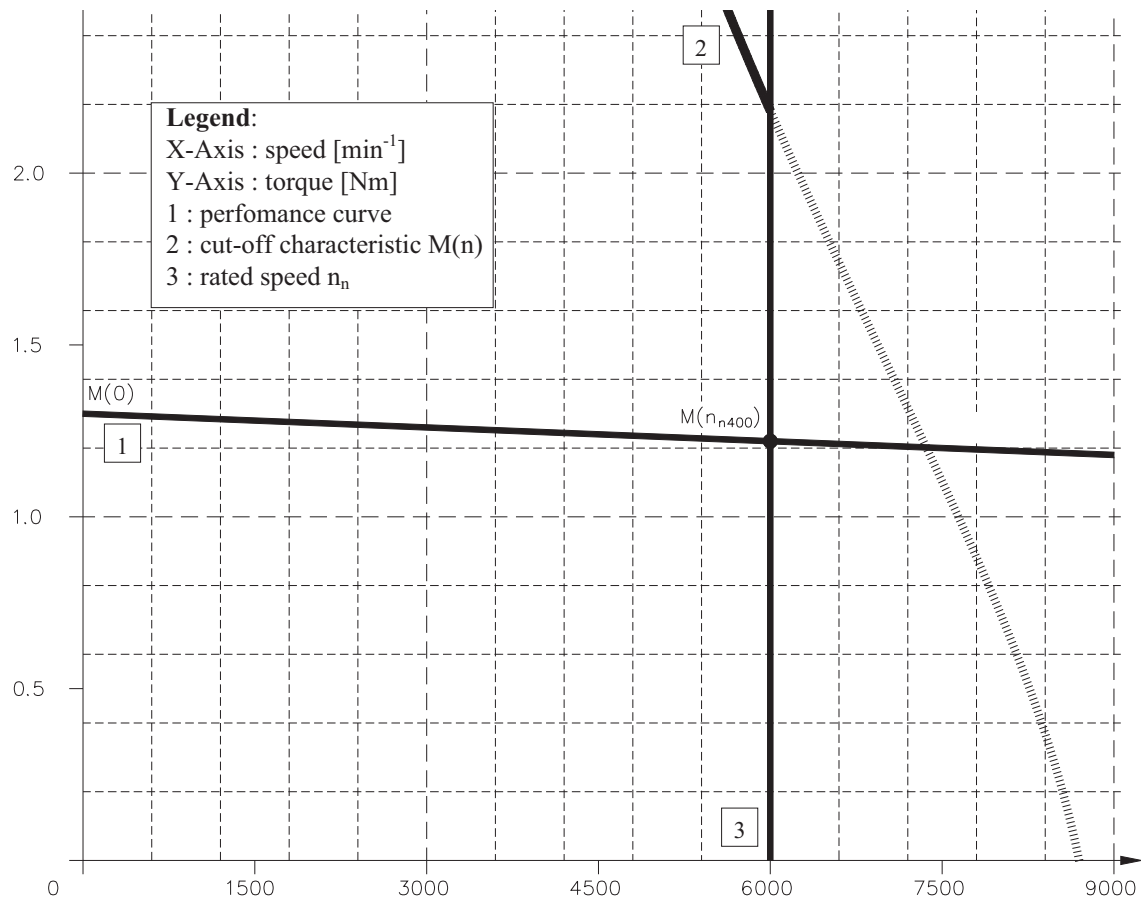

III.1.6 Performance curve GOLDLINE™ BH-126-B

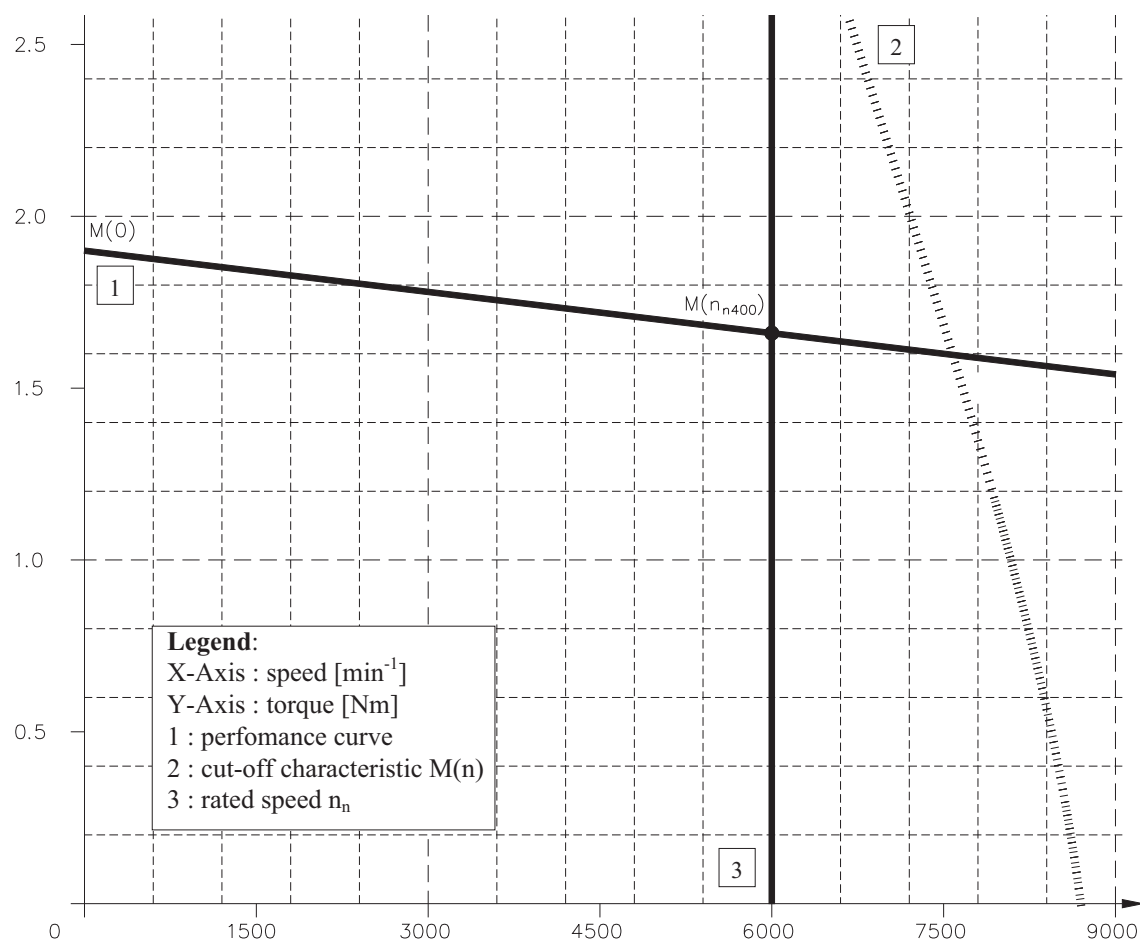

III.1.7 Performance curve GOLDLINE™ BH-222-B

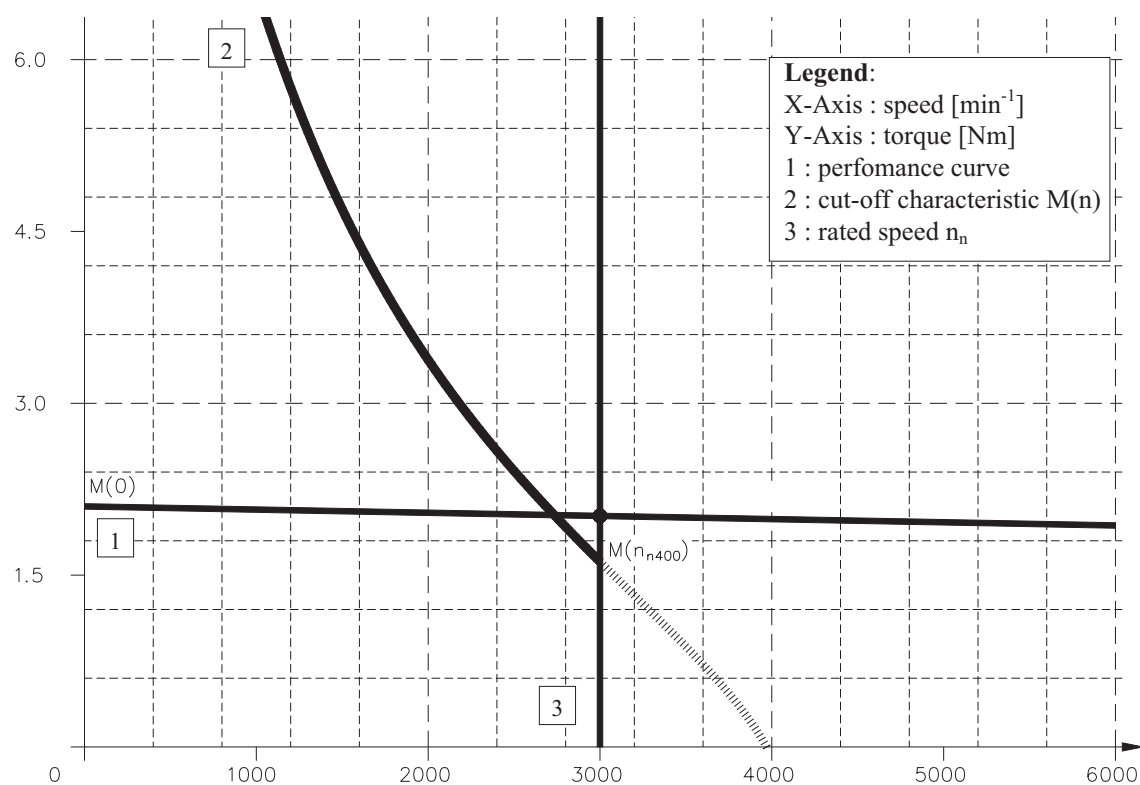

III.1.8 Performance curve GOLDLINE™ BH-224-B

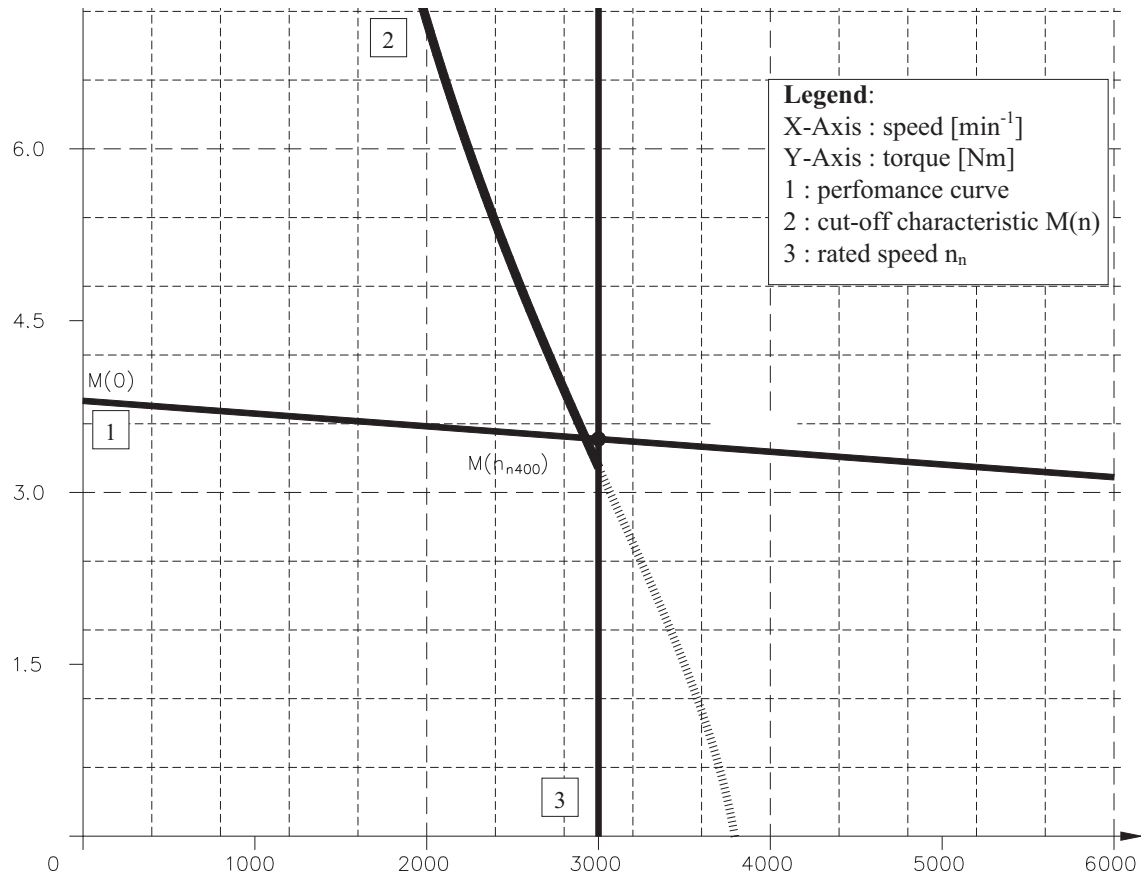

III.1.9 Performance curve GOLDLINE™ BH-226-C

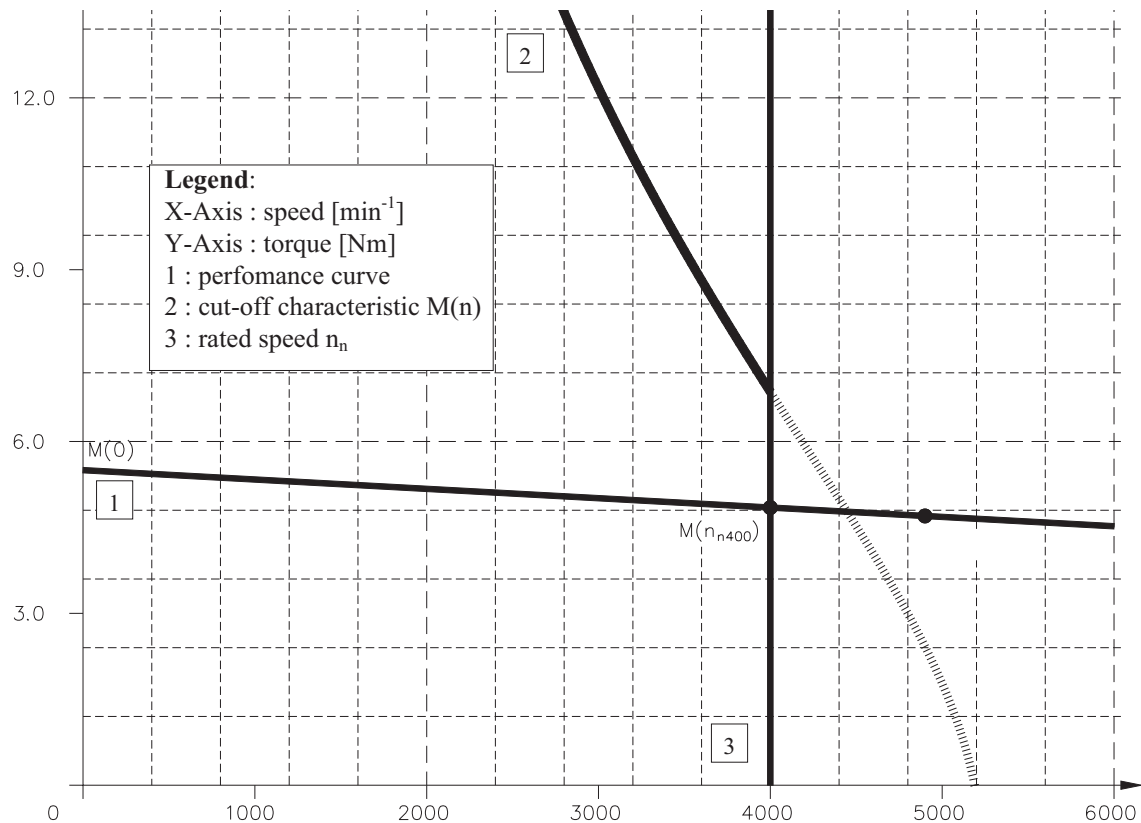

III.1.10 Performance curve GOLDLINE™ BH-226-E

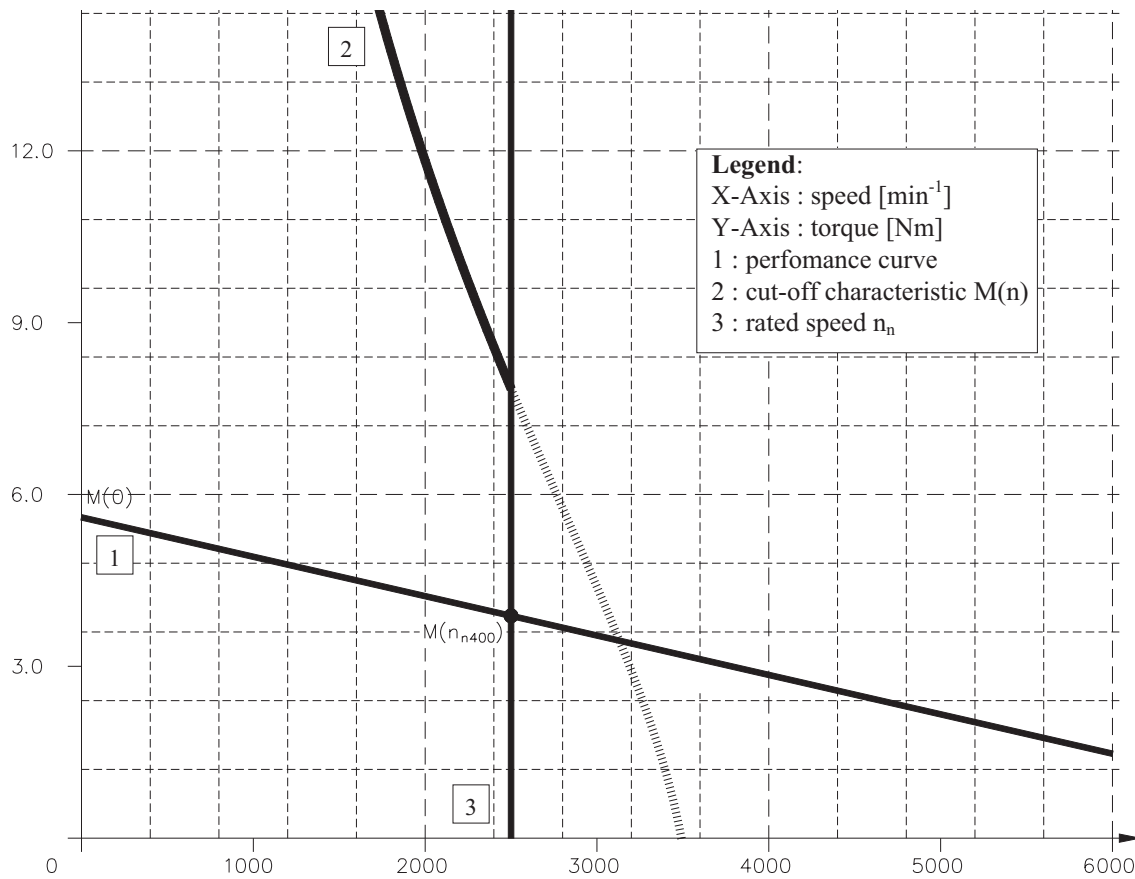

III.1.11 Performance curve GOLDLINE™ BH-422-D

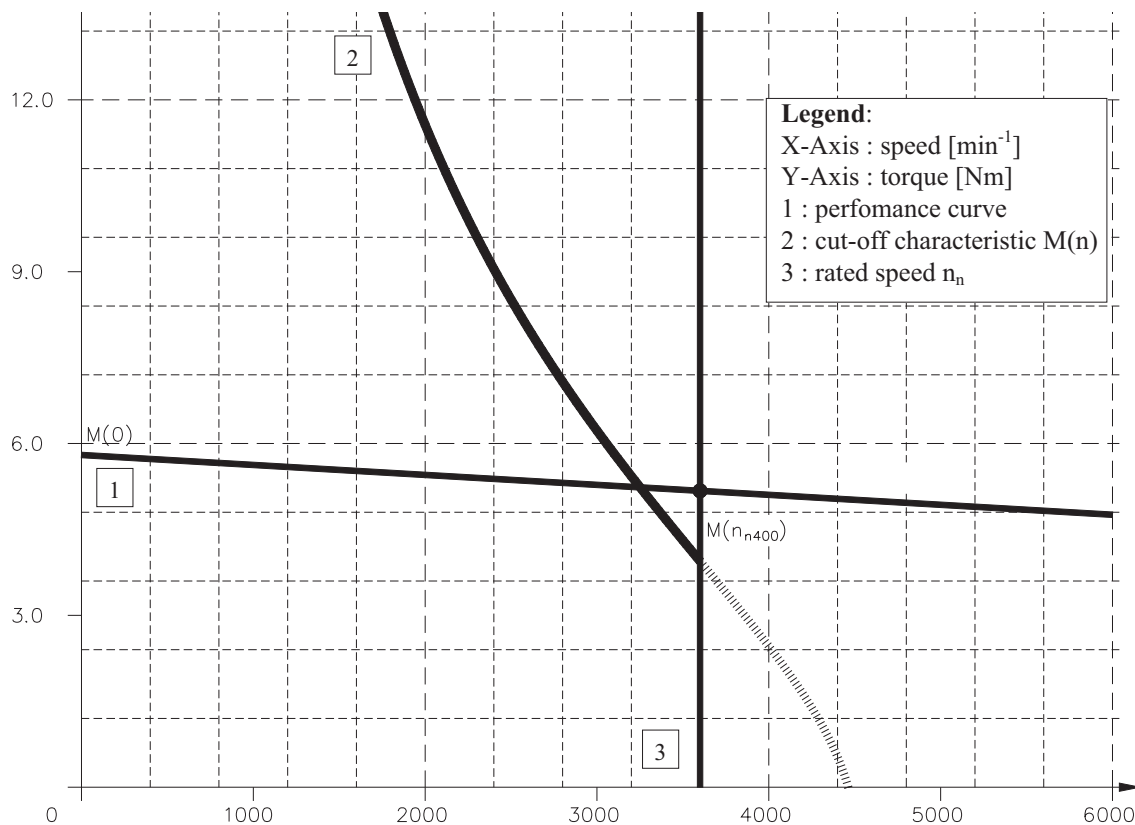

III.1.12 Performance curve GOLDLINE™ BH-424-B

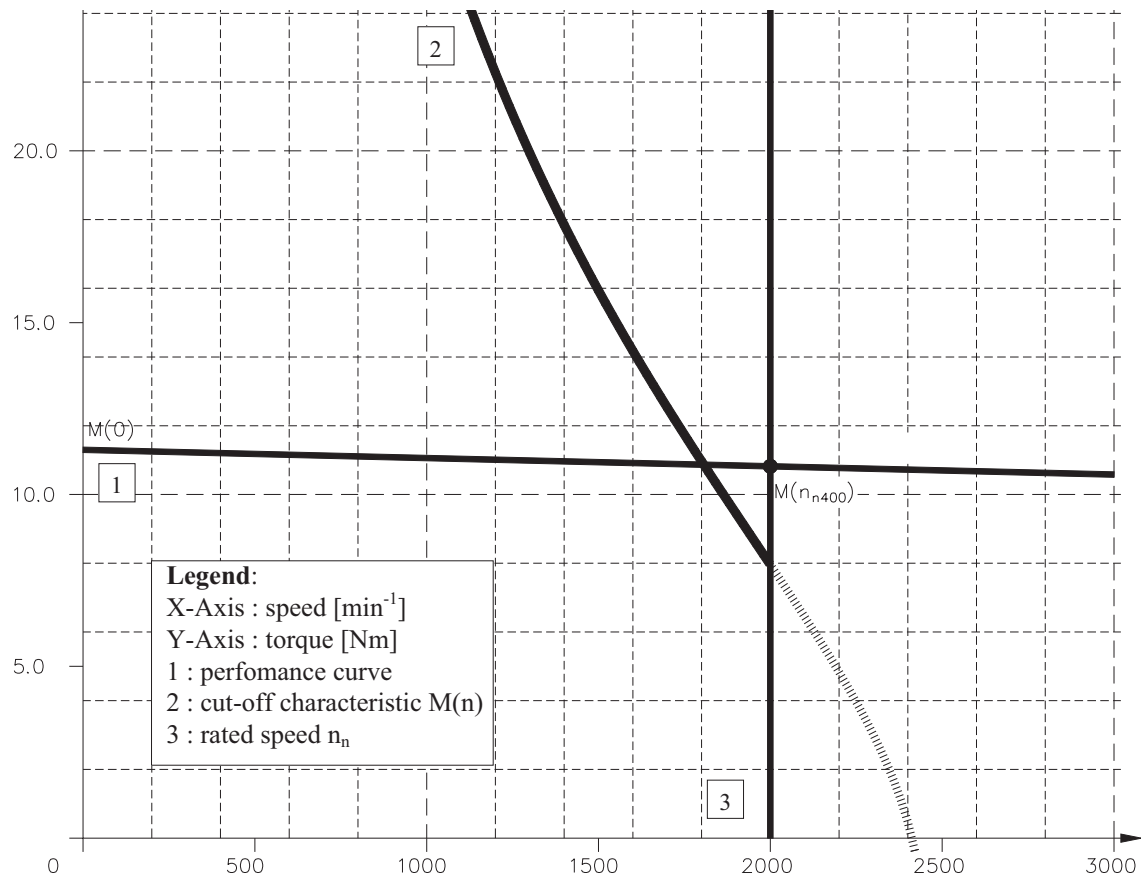

III.1.13 Performance curve GOLDLINE™ BH-424-D

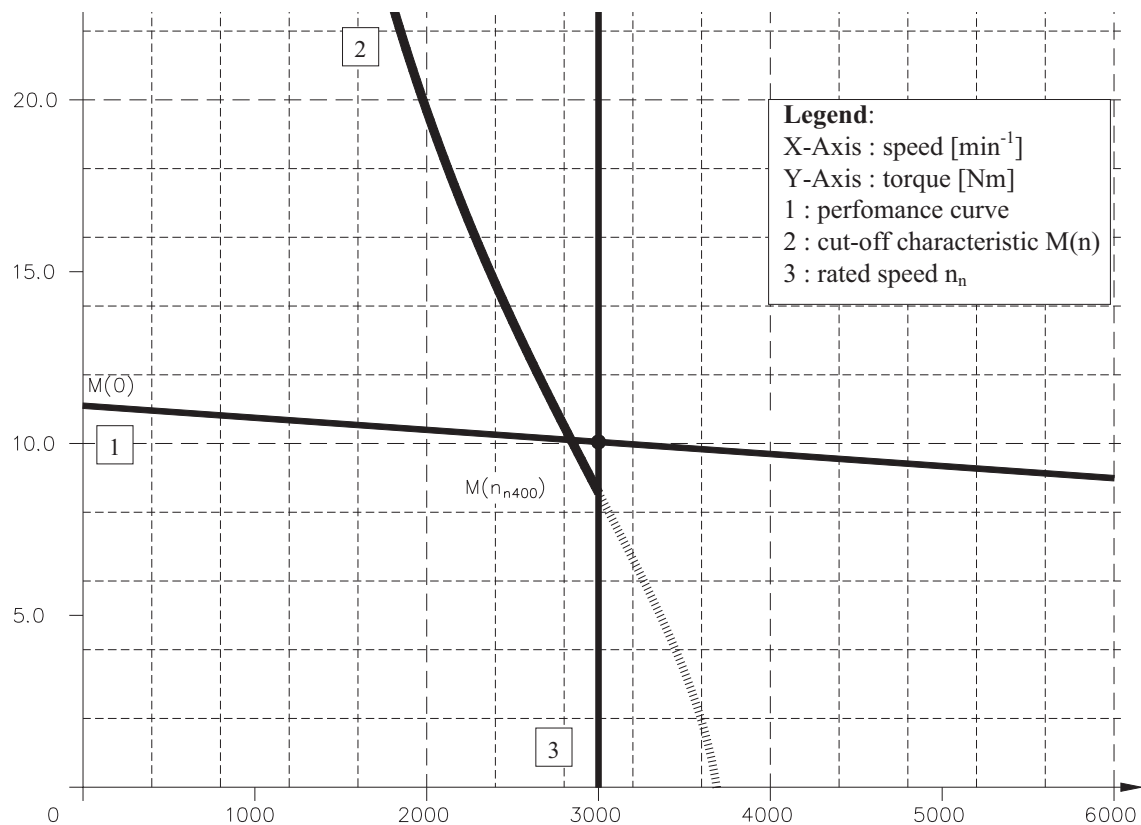

III.1.14 Performance curve GOLDLINE™ BH-426-B

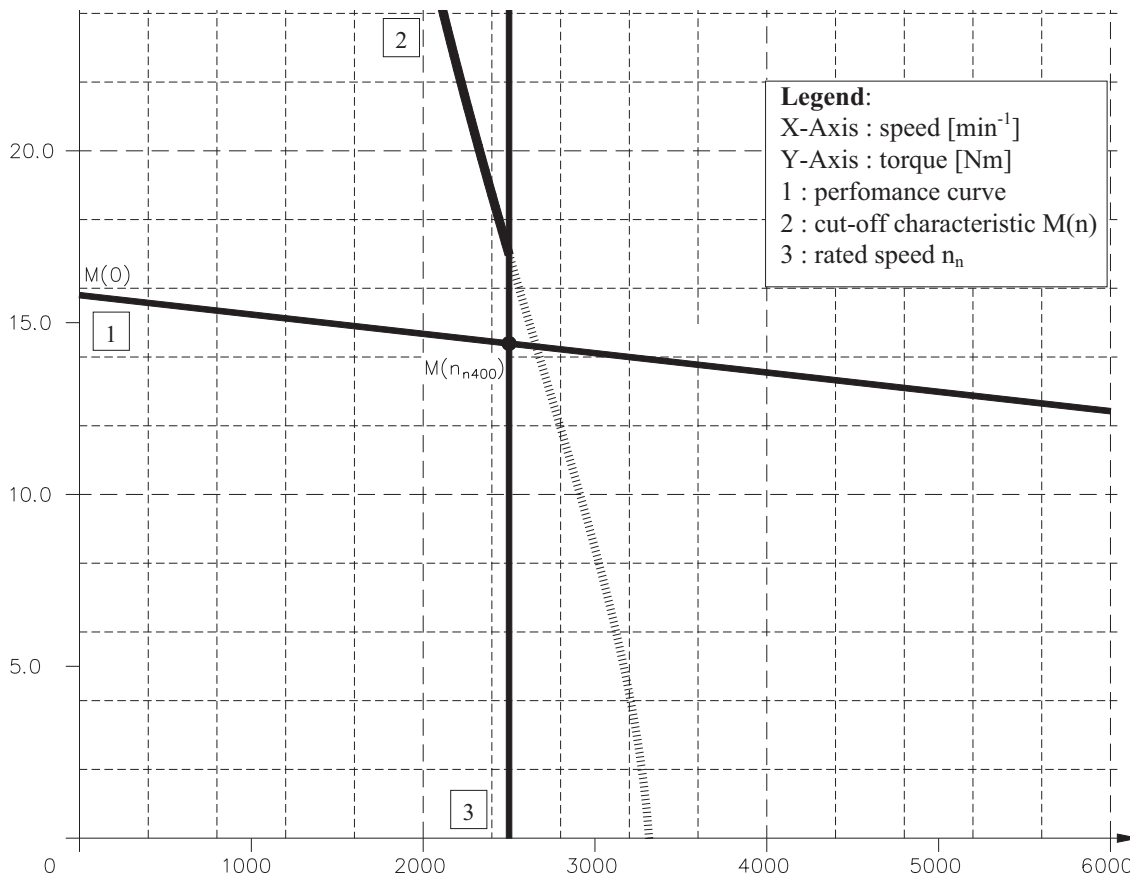

III.1.15 Performance curve GOLDLINE™ BH-426-D

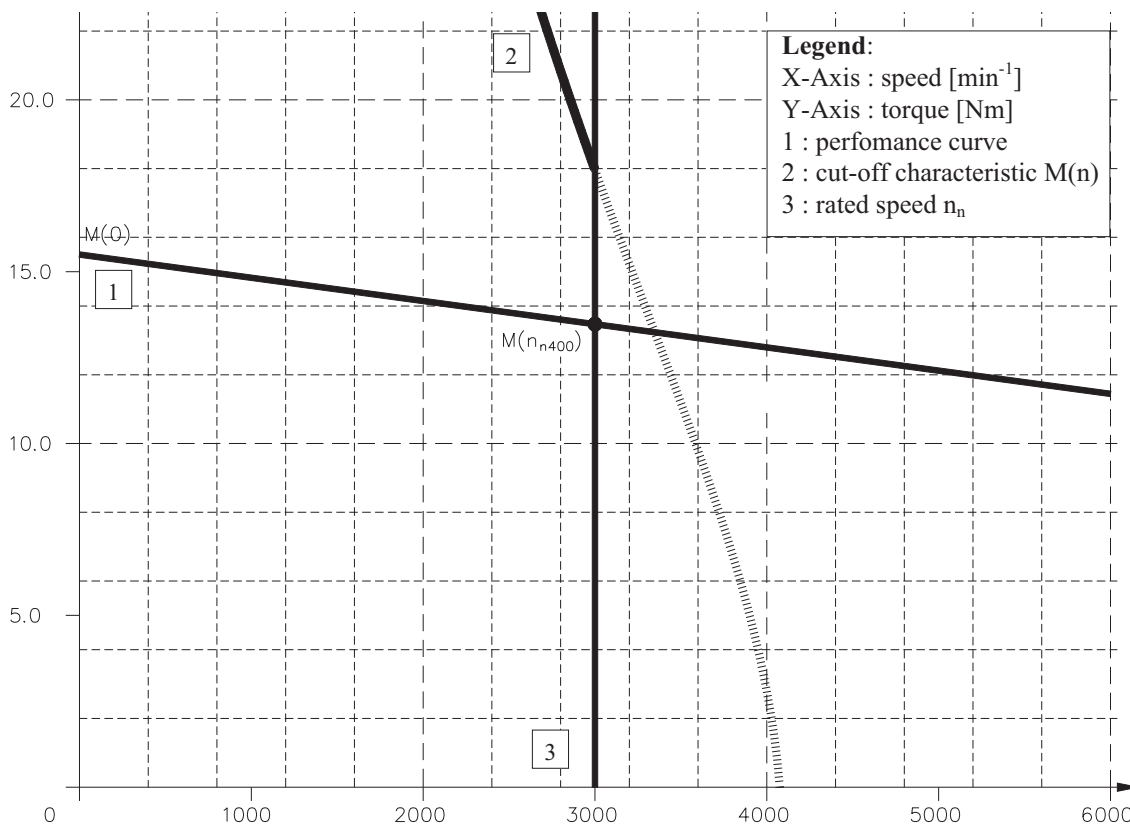

III.2 Motors with terminal box

III.2.1 Dimensions GOLDLINE™ BH-6xx..8xx

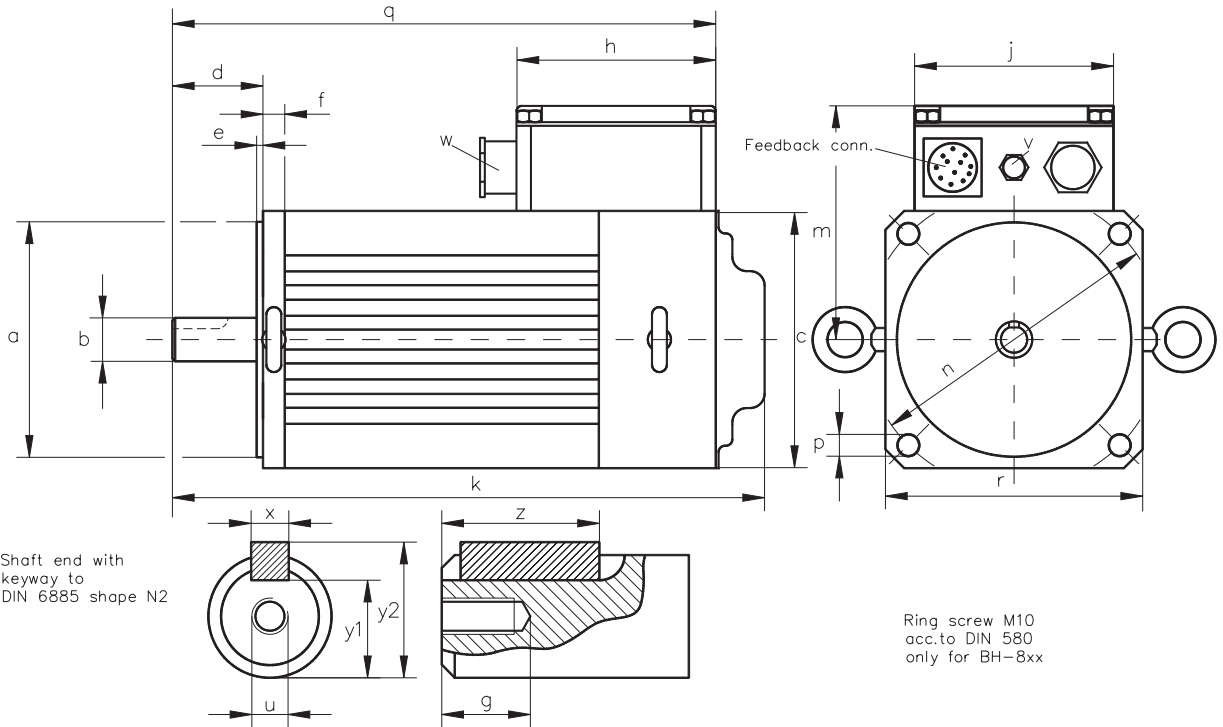

	a _{j6}	b	c	d	e	f	g	h	j	k	m	n	p	q	r	u	v	w	x	y1	y2	z
	mm	mm	mm	mm	mm	mm	mm	mm	mm	mm	mm	mm	mm	mm	mm		PG	PG	mm	mm	mm	mm
BH-622-B		24 _{j6}		50			27			350				332		M8			8	20	27	37
BH-624-C/-D	130	24 _{j6}	142	50	3,5	18	27	160	160	418	161	165	11	400	142	M8	11	21	8	20	27	37
BH-626-E		32 _{k6}		50			42			486				468		M12			10	27	35	39
BH-822-D		32 _{j6}		58						418				400					10	27	35	39
BH-824-A/-D		32 _{k6}		58						508				490					10	27	35	39
BH-826-C/-D	180	48 _{k6}	190	82	4	19	42	160	160	621	185	215	14	603	190	M12	11	36	14	42,5	51,5	60
BH-828-B		48 _{k6}		82						742				724					14	42,5	51,5	60

III.2.2 Radial-/Axial forces at the shaft end

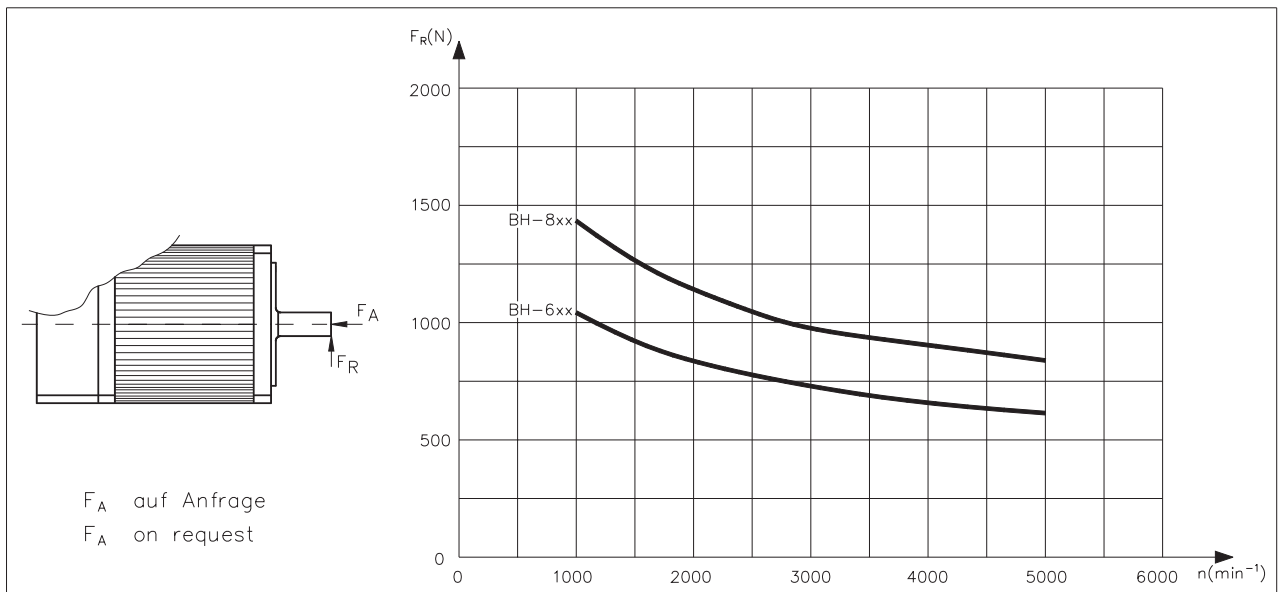

III.2.3 Wiring GOLDLINE™ BH-6xx..8xx

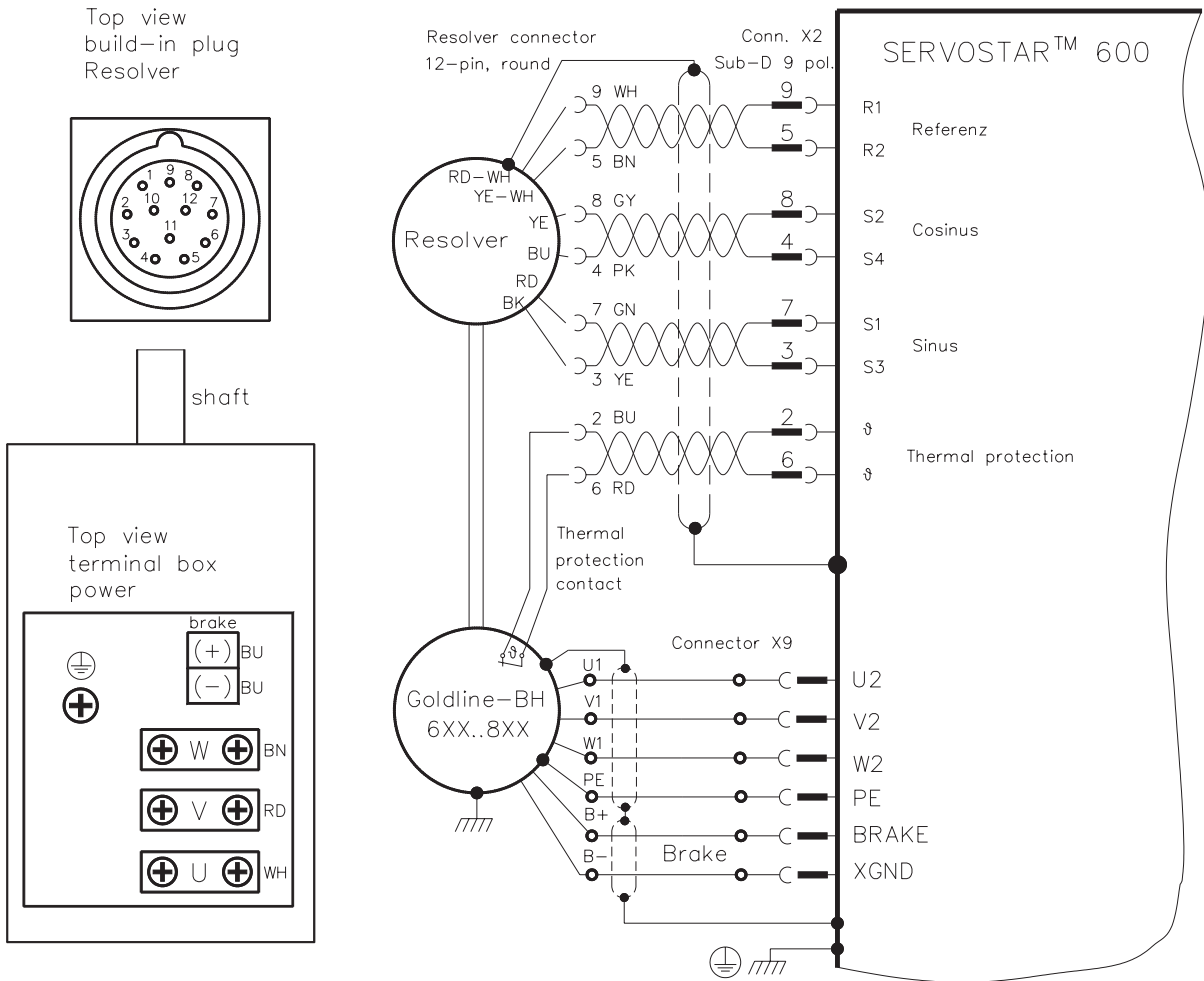

□ (mm ²)	Mat.No.
4x2,5	84942
4x10	84957
4x16	84962

Motor cable w/o conn.
Lead lengths up to 100m on request

connector round, 12-poles

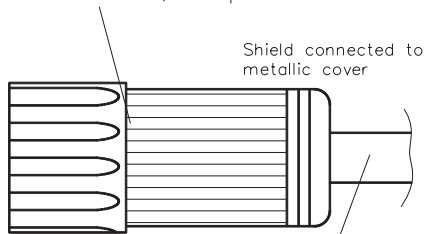

4 x 2 x 0,25 shielded, twisted pairs on request max. 100m

Sub-D connector 9-poles

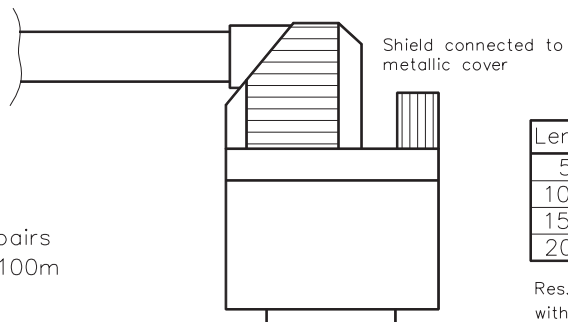

Length	Mat.No.
5m	84972
10m	84973
15m	84974
20m	84975

Res. cable f. 6SM with connector

colour coding acc. to IEC 757

III.2.4 Performance curve GOLDLINE™ BH-622-B

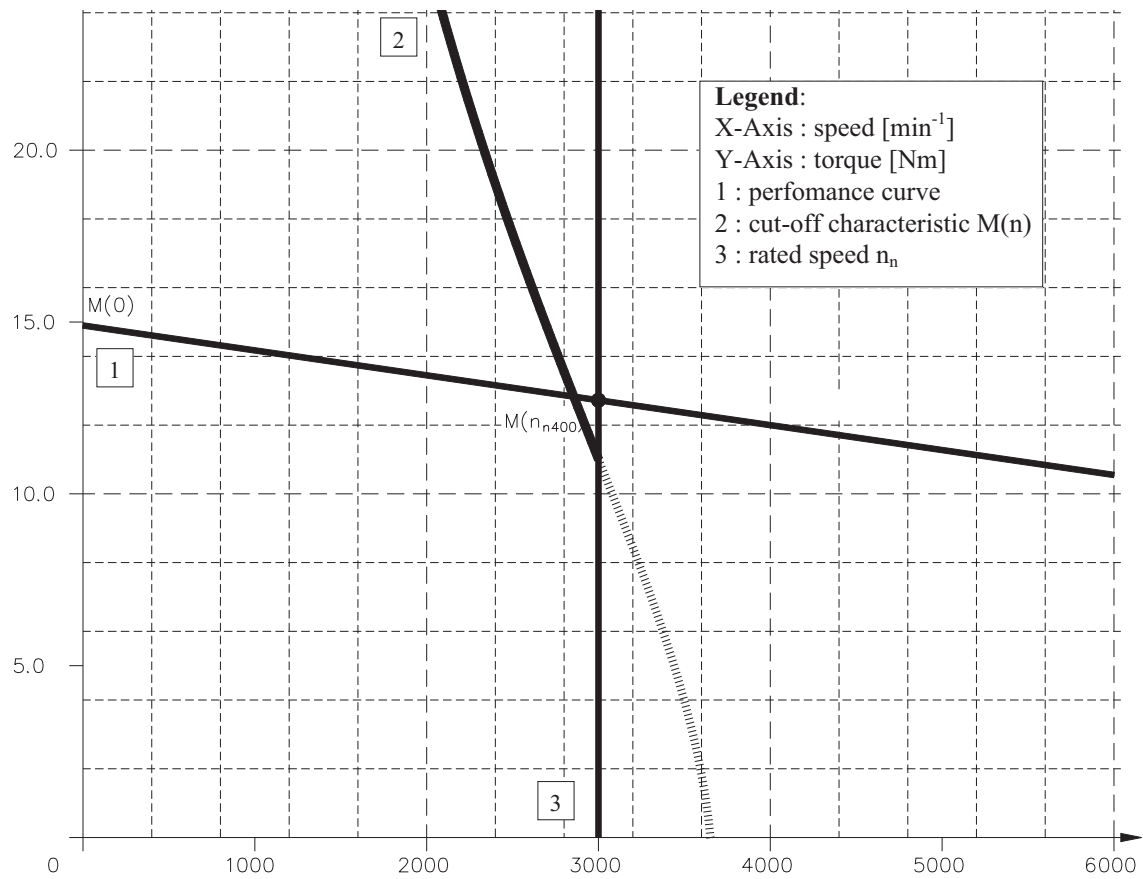

III.2.5 Performance curve GOLDLINE™ BH-624-C

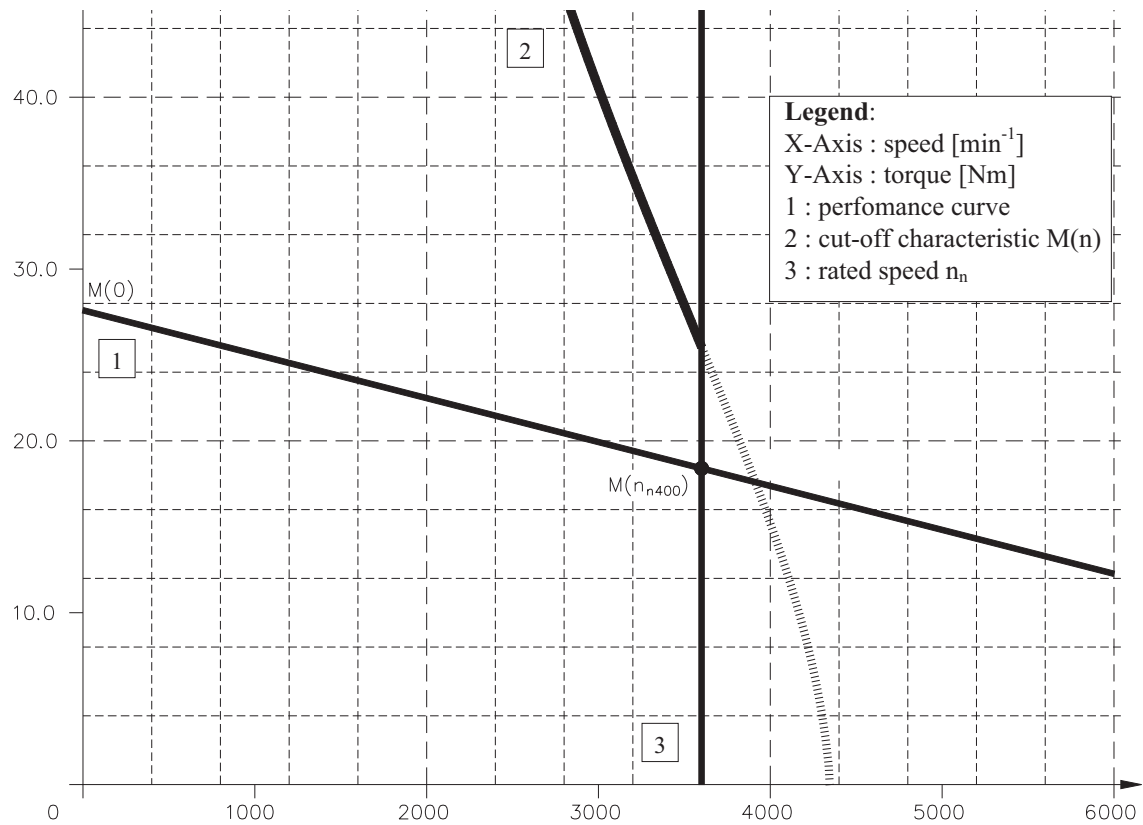

III.2.6 Performance curve GOLDLINE™ BH-624-D

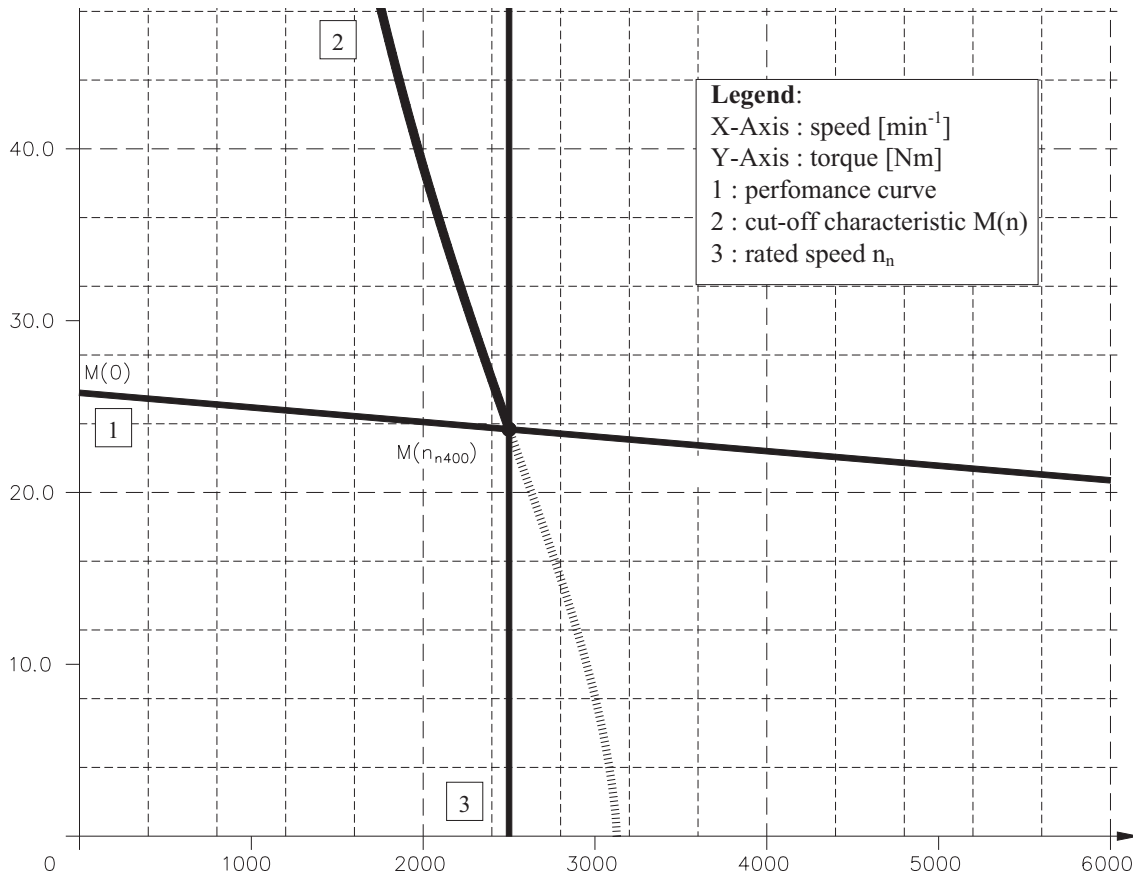

III.2.7 Performance curve GOLDLINE™ BH-626-E

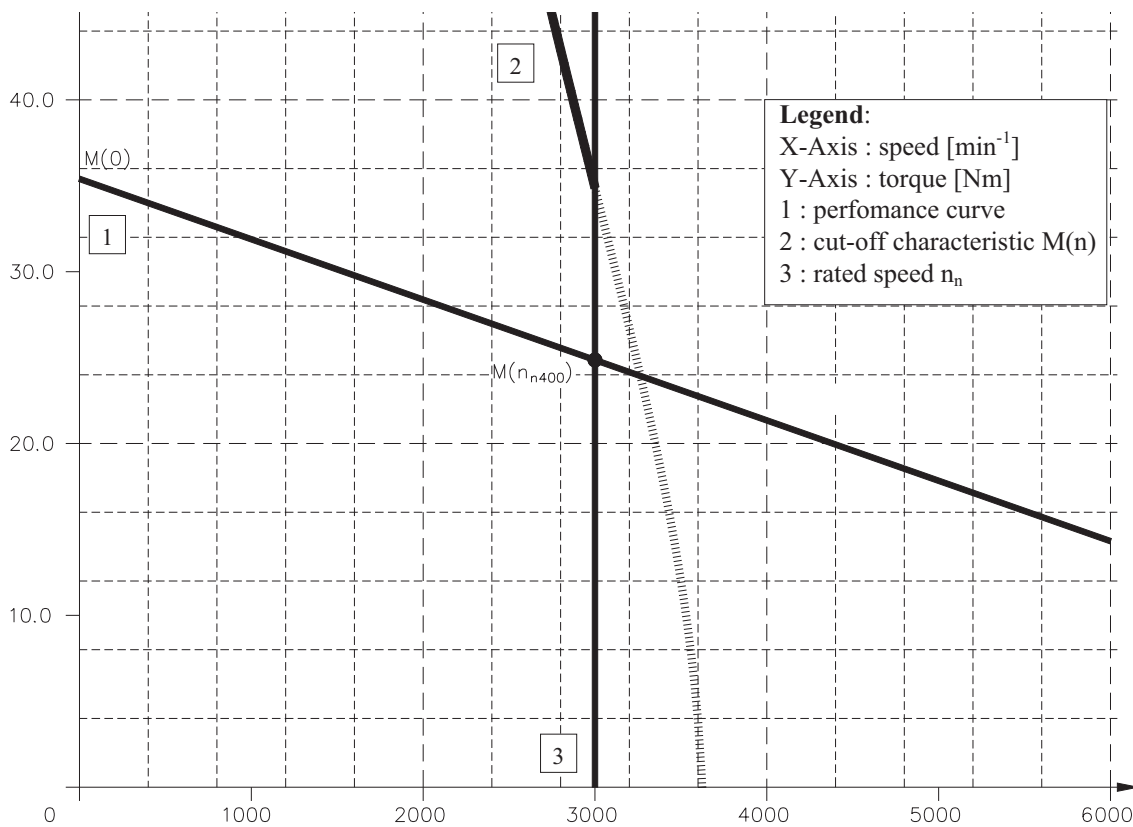

III.2.8 Performance curve GOLDLINE™ BH-822-D

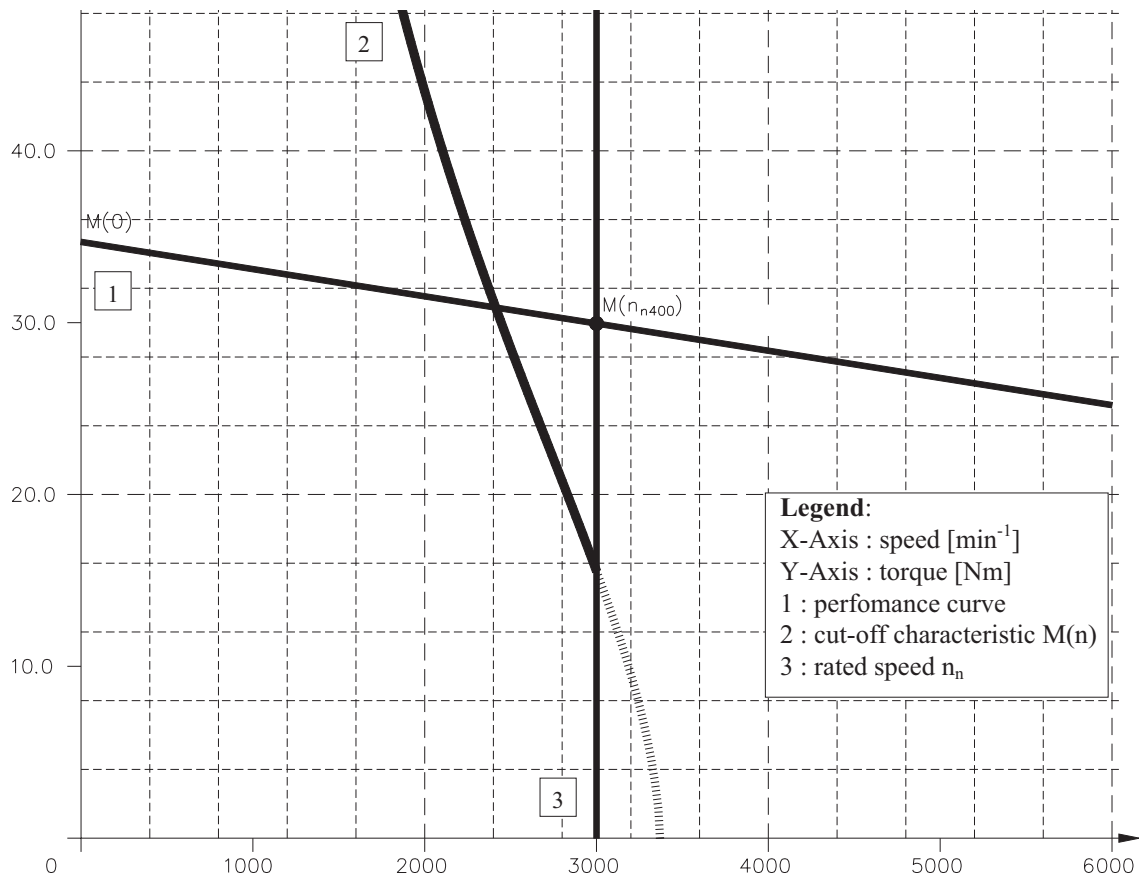

III.2.9 Performance curve GOLDLINE™ BH-824-A

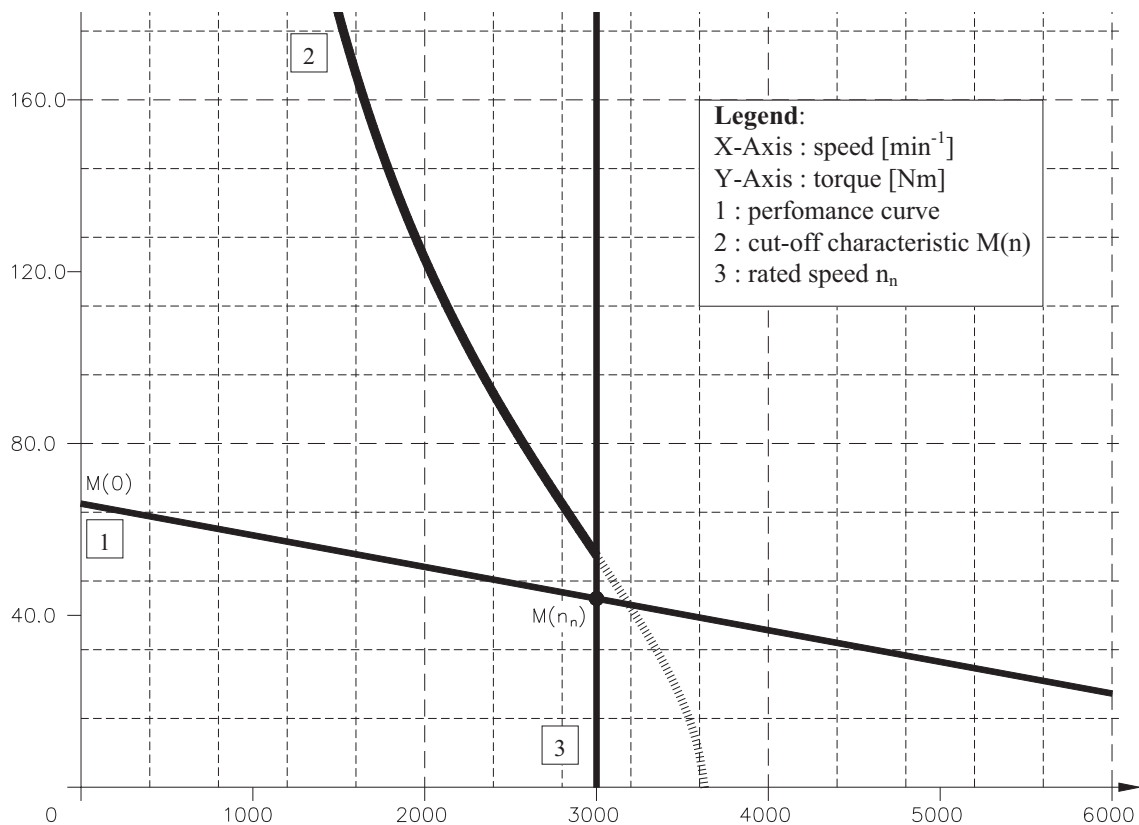

III.2.10 Performance curve GOLDLINE™ BH-824-D

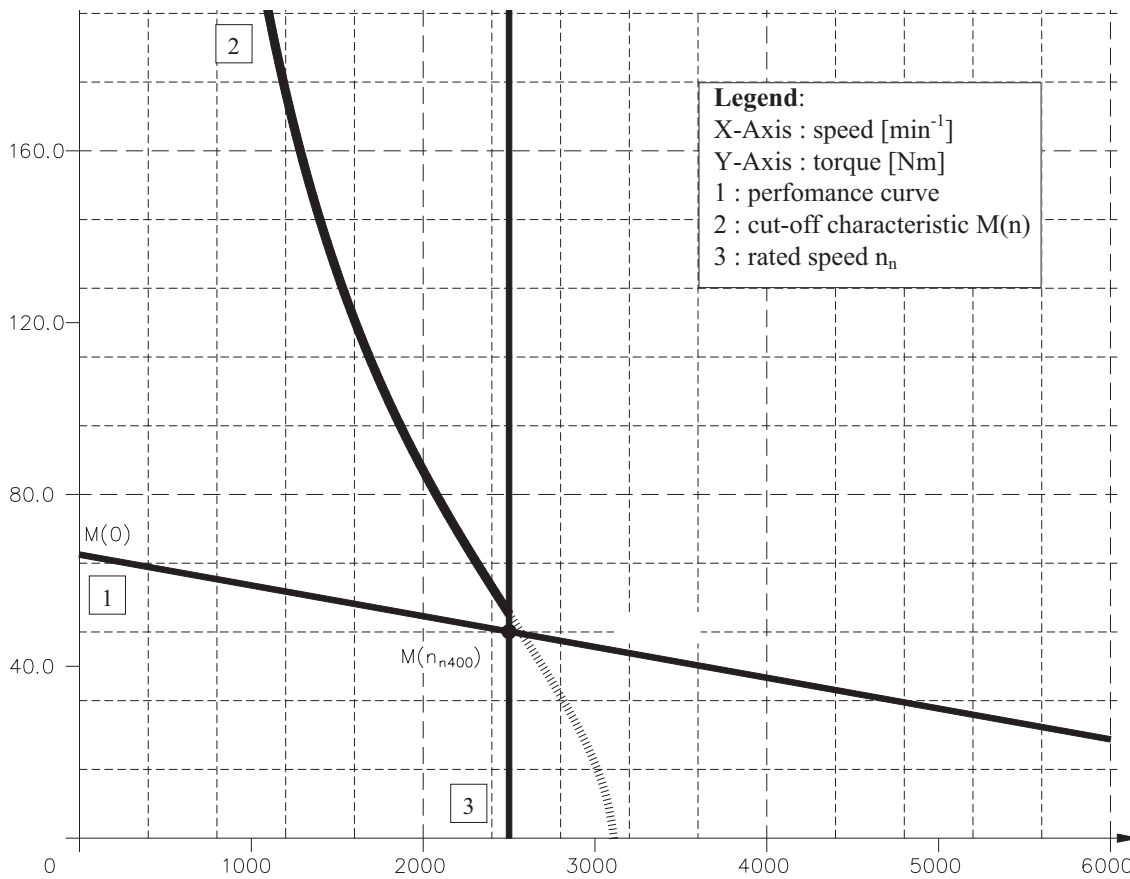

III.2.11 Performance curve GOLDLINE™ BH-826-C

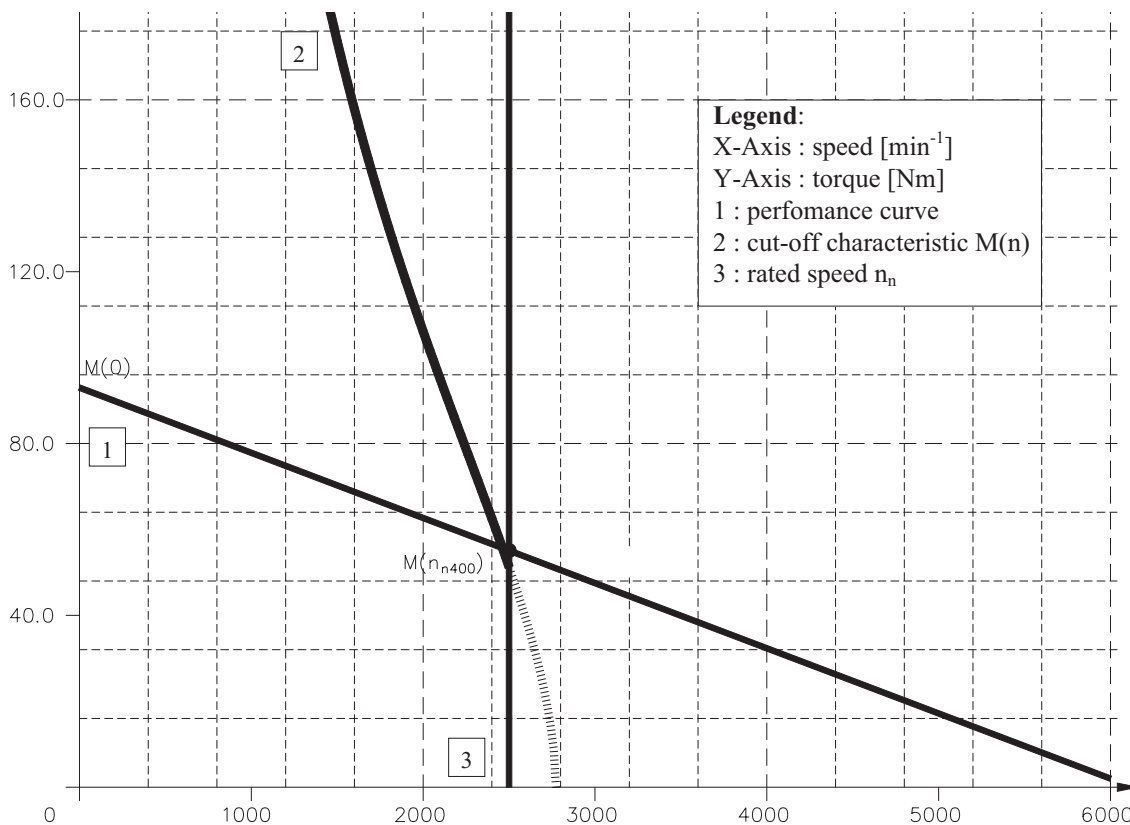

III.2.12 Performance curve GOLDLINE™ BH-826-D

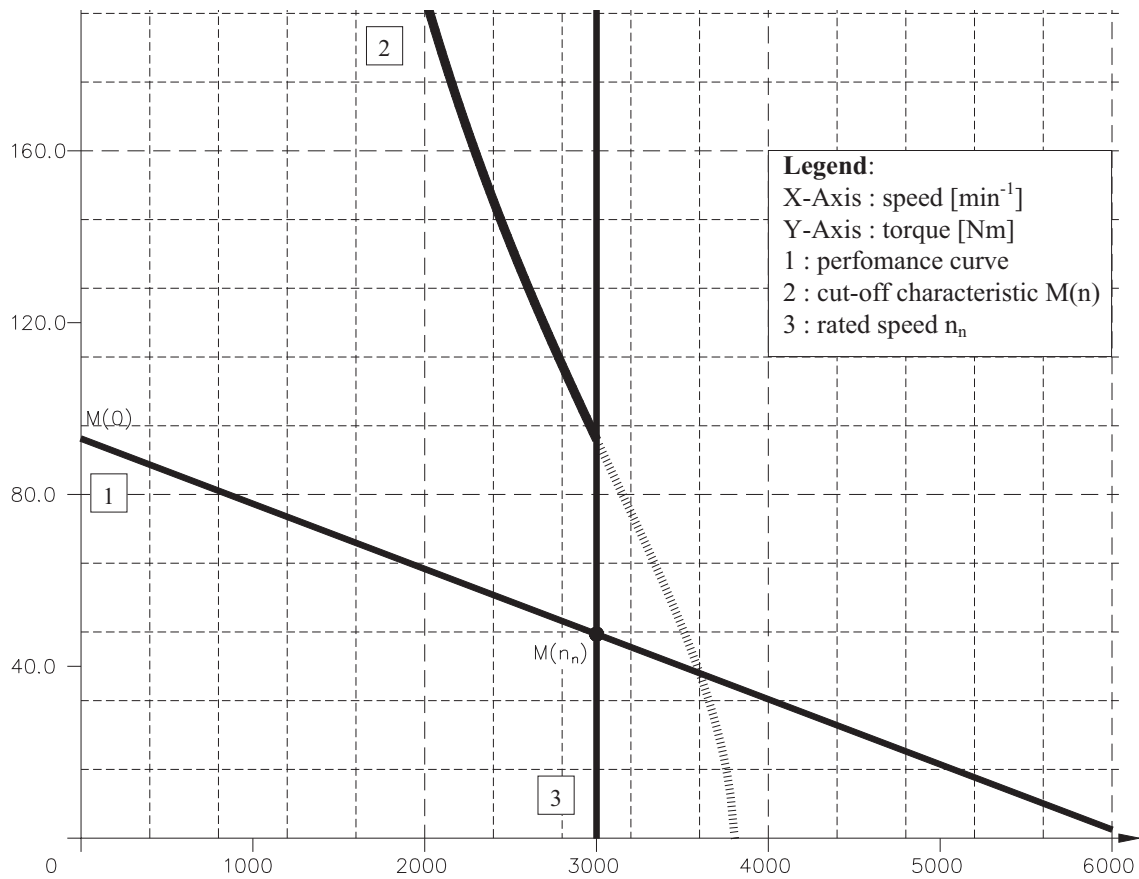

III.2.13 Performance curve GOLDLINE™ BH-828-B

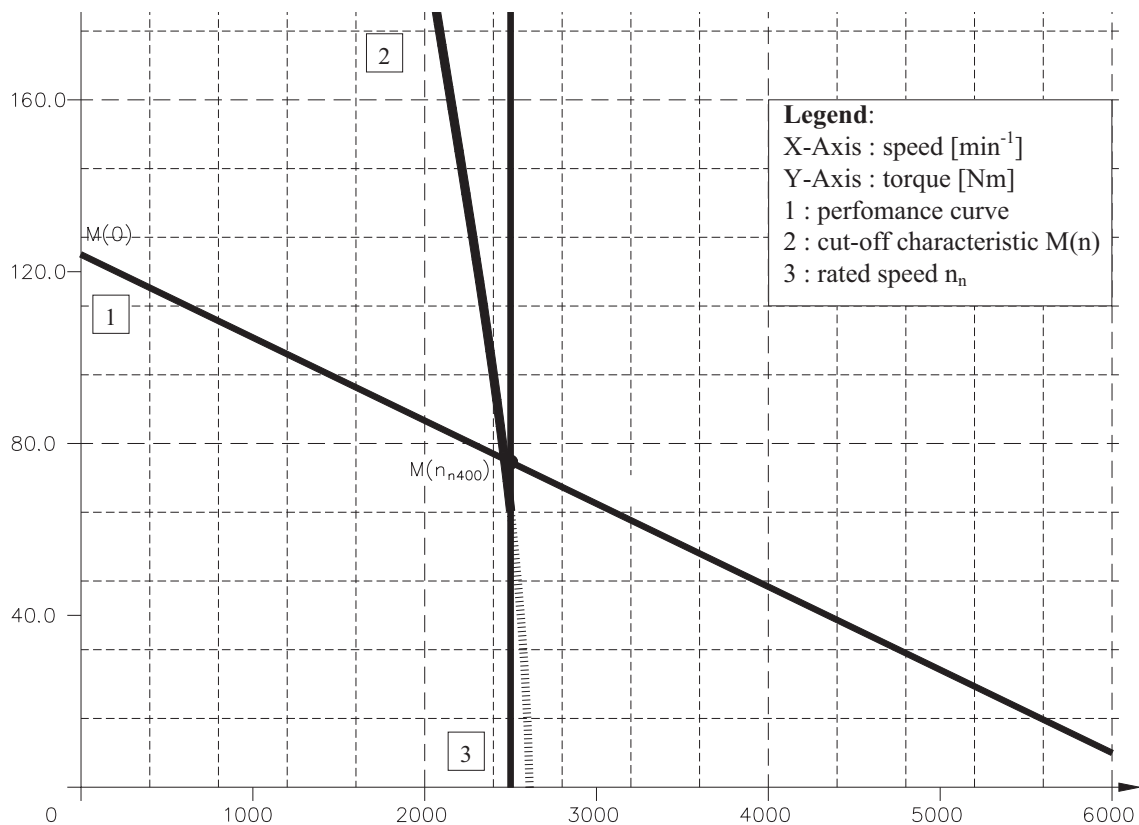

This page is deliberately left blank.

IV

Appendix

IV.1

Delivery package, transport, storage, maintenance, disposal

- Delivery package:** — Motor from the **GOLDLINE™** BH series
— Technical description (documentation), 1 copy per delivery
— Motor package leaflet (short info)

- Transport :** — Climate category 2K3 to EN 50178
Transport temperature —25...+70°C, max. 20K/hr change
Transport humidity rel. humidity 5% - 95% , no condensation
— only by qualified personnel
— only in the manufacturer's original recyclable packaging
— avoid shocks, especially on the shaft end
— if the packaging is damaged, check the motor for visible damage.
Inform the carrier and, if appropriate, the manufacturer.

Packaging :

Motor type	Carton	Palett or skeleton box	Max.stackingheight
BH-1xx	X		4
BH-2xx	X		4
BH-4xx	X		3
BH-6xx	X		2
BH-8xx		X	1

- Storage :** — Climate category 1K4 to EN 50178
Storage temperature —25...+55°C, max. variation 20K/hr.
Humidity rel. humidity 5% - 95%, no condensation
— only in the manufacturer's original recyclable packaging
— max. stacking height see table under Packaging
— Storage time unlimited

- Maintenance :** — Only by qualified personnel
— The ball bearings have a grease packing which is adequate for 20,000 hours of operation under normal conditions. The bearings should be replaced after 20,000 hours of operation under rated conditions.
— Check the motor for bearing noise every 2500 operating hours, respectively each year. If any noises are heard, then the operation of the motor must stop, the bearings must be replaced.
— Opening the motor invalidates the warranty.

- Cleaning :** — If the housing is dirty: clean with Isopropanol or similar.
do not immerse or spray

- Disposal :** — The disposal should be carried out by a certified disposal company.
Ask us for addresses.

IV.2 Fault-finding

The following table is to be seen as a “First Aid” box. There can be a large number of different reasons for a fault, depending on the particular conditions in your system. The fault causes described below are mostly those which directly influence the motor. Peculiarities which show up in the control loop behaviour can usually be traced back to an error in the parameterization of the servo-amplifier. The documentation for the servo-amplifier and the operator software provides information on these matters.

For multi-axis systems there may be further hidden reasons for faults.

Our applications department can give you further help with your problems.

Fault	Possible cause	Measures to remove the cause of the fault
Motor doesn't rotate	<ul style="list-style-type: none"> — Servo-amplifier not enabled — Break in setpoint lead — Motor phases in wrong sequence — Brake not released — Drive is mechanically blocked 	<ul style="list-style-type: none"> — Supply ENABLE signal — Check setpoint lead — Correct the phase sequence — Check brake controls — Check mechanism
Motor runs away	<ul style="list-style-type: none"> — Motor phases in wrong sequence — Wrong resolver adjustment 	<ul style="list-style-type: none"> — Correct the phase sequence — Check the resolver offset and adjust it correctly
Motor oscillates	<ul style="list-style-type: none"> — Break in the shielding of the resolver cable — amplifier gain too high 	<ul style="list-style-type: none"> — Replace resolver cable — use motor default values
Error message: brake	<ul style="list-style-type: none"> — Short-circuit in the supply voltage lead to the motor holding brake — Faulty motor holding brake 	<ul style="list-style-type: none"> — Remove the short-circuit — Replace motor
Error message: output stage fault	<ul style="list-style-type: none"> — Motor cable has short-circuit or earth short — Motor has short-circuit or earth short 	<ul style="list-style-type: none"> — Replace cable — Replace motor
Error message: resolver	<ul style="list-style-type: none"> — Resolver connector is not properly plugged in — Break in resolver cable, cable crushed or similar 	<ul style="list-style-type: none"> — Check connector — Check cables
Error message: motor temperature	<ul style="list-style-type: none"> — Motor thermostat has switched — Loose resolver connector or break in resolver cable 	<ul style="list-style-type: none"> — Wait until the motor has cooled down. Then investigate why the motor becomes so hot. — Check connector, replace resolver cable if necessary
Brake does not grip	<ul style="list-style-type: none"> — Required holding torque too high — Brake faulty — Motor shaft axially overloaded 	<ul style="list-style-type: none"> — Check the dimensioning — Replace motor — Check the axial load, reduce it. Replace motor, since the bearings have been damaged

IV.3 Index

<u>Text</u>	<u>Page</u>	<u>Text</u>	<u>Page</u>
A Ambient temperature	8	S Safety notes	4
Assembly	17	Servo amplifier	8
Axial force	9	Shielding	17
Axial forces		Site	17
GOLDLINE™ BH 1xx..4xx	21	Standstill current	12
GOLDLINE™ BH 6xx..8xx	29	Standstill torque	12
B Break response times	12	Storage	37
C Commissioning	19	Storage humidity	37
Connection method	10	Storage temperature	37
Contents	3	Storage time	37
Coupling	9	Style	9
D Delivery package	37	Symbols.	4
Dimensions		T Technical data	13
GOLDLINE™ BH 1xx..4xx	21	Thermal time constant.	12
GOLDLINE™ BH 6xx..8xx	29	Thermostat	9
Disposal	37	Torque constant	12
E Earthing	17	Transport	37
F Flange temperature	8	V Ventilation.	17
G Ground symbol	16	Vibration class	10
H Holding brake	10	Voltage constant.	12
I Insulation material class.	10	W Wiring.	17
M Maintenance.	37	GOLDLINE™ BH 1xx..4xx	22
Manufacturer declaration.	6	GOLDLINE™ BH 6xx..8xx	30
Motor lead.	18		
O Options	11		
P Peak current	12		
Power derating	8		
Protection class	9		
Protective device	9		
R Radial force.	9		
Radial forces			
GOLDLINE™ BH 1xx..4xx	21		
GOLDLINE™ BH 6xx..8xx	29		
Rated current	12		
Rated torque.	12		
Resolver	10		
Resolver lead	18		
Rotor moment of inertia.	12		

Vertrieb und Service / Sales and Service / Agence et Services

Bundesrepublik Deutschland/ Germany/Allemagne

Seidel Servo Drives GmbH
Verkaufsniederlassung Nord
Dasselsbrucher Str. 49a
D-29227 Celle
Tel.: +49(0)5141 - 98 10 40
Fax: +49(0)5141 - 98 10 41

Seidel Servo Drives GmbH
Verkaufsniederlassung West
Wacholderstr. 40-42
D-40489 Düsseldorf
Tel.: +49(0)203 - 99 79 - 180
Fax: +49(0)203 - 99 79 - 118

Seidel Servo Drives GmbH
Verkaufsniederlassung Süd-West
Bruchsaler Str. 3
D-76646 Bruchsal-Untergrombach
Tel.: +49(0)7257 - 9 23 07
Fax: +49(0)7257 - 9 23 08

Seidel Servo Drives GmbH
Verkaufsniederlassung Süd-Ost
Landsbergerstr. 17
D-86947 Weil
Tel.: +49(0)8195 - 99 92 50
Fax: +49(0)8195 - 99 92 33

Servo-Dyn
Technik GmbH
Münzgasse 10
D-01067 Dresden
Tel.: +49(0)351 - 49 05 793
Fax: +49(0)351 - 49 05 794

Dänemark/ Denmark/Danemark

DIGIMATIC
Ormhøjgaardvej 12-14
DK-8700 Horsens
Tel.: +45 - 76 26 12 00
Fax: +45 - 76 26 12 12

Finnland/ Finland/Finlande

Drivematic OY
Hevosenkentä 4
FIN-28430 Pori
Tel.: +358 - 2 - 61 00 33 11
Fax: +358 - 2 - 61 00 33 50

Frankreich/ France/France

Seidel Servo Drives GmbH
Parc technologique St.Jacques
2 rue Pierre et Marie Curie
F-54320 Maxéville
Tel.: +33(0)3 83 95 44 80
Fax: +33(0)3 83 95 44 81

Großbritannien/ Great Britain/Royaume-Uni

Kollmorgen
PO Box 147, KEIGHLEY
West Yorkshire, BD21 3XE
Tel.: +44(0)15 35 - 60 76 88
Fax: +44(0)15 35 - 68 05 20
Heason Technologies Group
Claremont Lodge
Fontwell Avenue
Eastergate Chichester PO20 6RY
Tel.: +44(0)12 43 - 54 54 00
Fax: +44(0)12 43 - 54 45 90

Italien/ Italy/Italie

M.C.A. s.r.l.
Via f. Turati 21
I-20016 Pero (MI)
Tel.: +39(0)2 - 33 91 04 50
Fax: +39(0)2 - 33 90 85 8

Niederlande/ Netherlands/Pays-Bas

Dynamic Drives
Jan van der Heydenstraat 24a
NL-2665 JA Bleiswijk
Tel.: +31(0)10 - 52 15 490
Fax: +31(0)10 - 52 18 994

Schweden/ Sweden/Suède

S D T AB
SE-25467 Helsingborg
Tel.: +46(0)42 - 380 800
Fax: +46(0)42 - 380 813
Stockholm
SE-12030 Stockholm
Tel.: +46(0)8 - 640 77 30
Fax: +46(0)8 - 641 09 15
Göteborg
SE-42671 Västra Frölunda
Tel.: +46(0)31 - 69 62 60
Fax: +46(0)31 - 69 62 69

Schweiz/ Switzerland/Suisse

Seidel Servo Drives GmbH
Eggbühlstr. 14
CH-8050 Zürich
Tel.: +41(0)1 - 300 29 65
Fax: +41(0)1 - 300 29 66

Spanien/ Spain/Espagne

Comercial BROTOMATIC, S.L.
San Miguel de Acha, 2 Pab.3
E-01010 Vitoria
Tel.: +34 945 - 24 94 11
Fax: +34 945 - 22 78 32

Systempartner / System partners / Partenaires du syst me

Bundesrepublik Deutschland/ Germany/Allemagne

Werner P. Hermes
Ingenieurbüro
Turmstr. 23
40750 Langenfeld
Tel.: +49(0)212 - 65 10 55
Fax: +49(0)212 - 65 10 57

EAT GmbH
Elektronische Antriebstechnik
Hanferstraße 23
79108 Freiburg
Tel.: +49(0)761 - 13 03 50
Fax: +49(0)761 - 13 03 555

IBK Ingenieurbüro Keßler GmbH
Dachtrisser Str. 10
21394 Kirchgellersen
Tel.: +49(0)4135 - 12 88
Fax: +49(0)4135 - 14 33

Großbritannien/ Great Britain/Royaume-Uni

Motor Technology Ltd.
Unit 1
Chadkirk Industrial Estate
Otterspool Road
Romiley, Stockport
GB-Cheshire SK6 3LE
Tel.: +44(0)161 - 42 73 641
Fax: +44(0)161 - 42 71 306

Schweiz/Switzerland/Suisse

Boby Servo Electronic AG
Zentralstr. 6
CH-6030 Ebikon
Tel.: +41(0)41 - 440 - 77 22
Fax: +41(0)41 - 440 - 69 43

Niederlande/ Netherlands/Pays-Bas

Kiwiet
Ingenieurbüro
Helenaveenseweg 35
NL-5985 NK Panningen (Grashoek)
Tel.: +31(0)77 - 30 76 661
Fax: +31(0)77 - 30 76 646

Italien/Italy/Italie

Servo Tecnica
Viale Lombardia 20
I-20095 Cusano Milanino (MI)
Tel.: +39(0)2 - 66 42 01
Fax: +39(0)2 - 66 40 10 20

Australien/Australia/Australie

FCR Motion Technology PTY. Ltd.
23 Mac Arthurs Road
Altona North, 3025
Melbourne/Australia
Tel.: +61 393 99 15 11
Fax: +61 393 99 14 31

Seidel Servo Drives GmbH

Hausanschrift

Wacholderstr. 40-42
D - 40489 Düsseldorf
Tel.: 49 0 203 - 99 79 - 0
Fax: 49 0 203 - 99 79 - 155
Internet : <http://www.seidelservodrive.de>

Postanschrift

Postfach 34 01 61
D-40440 Düsseldorf

Kollmorgen

201 ock oad
adford, VA 24141
Tel.: 1 540 - 639 - 24 95
Fax: 1 540 - 731 - 08 47
Internet : <http://www.kollmorgen.com>