

SANMOTION

AC SERVO SYSTEMS

R

TYPE S

Analogue / Pulse Input Type

For Rotary Motor

Instruction Manual

SANYO DENKI



ENGLISH

Preface

This product corresponds with the shipping regulations given in the Export Trade Control Ordinance (Table 1, item 16) and the Foreign Exchange Ordinance (Table 1, item 16). When these products are exported by customers, and when exported including the other freight or together with other freight, it is recommended to fulfill the requirements related to Security Export Control with the relevant authorities, including "Information Requirements" and "Objective Requirements".

This manual outlines the functions, wiring, installation, operations, maintenance, specifications, etc. of the AC servo amplifier "R" Series Type S. The "R" Series Type S AC servo amplifier system is compatible with a wide variety of various applications requiring low, medium or high capacity, high efficiency, reduced footprint, and excellent cost performance.

This product was developed to offer a series of servo motors that are easy to use and offer excellent functionality in an AC servo motor. It fulfills various needs, such as the downsizing of the control panel, and offers compatibility for a wide range of applications requiring a servo motor.

★Precautions related to this Instruction Manual

- In order to fully understand the functions of AC servo amplifier "R" Series Type S, please read this instruction manual thoroughly before using it.
- After reading this manual thoroughly, please keep it handy for reference.
- Please contact the dealer or sales representative if there are defects such as nonconsecutive pages, missing pages or if the manual is lost or damaged.
- Carefully and completely follow the safety instructions outlined in this manual. Please note that safety is not guaranteed for usage methods other than those specified in this manual or usage methods intended for the original product.
- The contents of this manual may be modified without prior notice, as revisions or additions are made in the usage method of this product. Modifications are performed per the revisions of this manual.
- Permission is granted to reproduce or omit part of the attached figures (as abstracts) for use.
- Although the manufacturer has taken all possible measures to ensure the veracity of the contents of this manual, if you should notice any error or omission, please notify the dealer or sales office of the finding.

【Safety Precautions】

This chapter is a summary of the safety precautions regarding the use of the R-series type-S amplifier. Please read this entire manual carefully prior to installing, operating, performing maintenance or inspecting this device to ensure proper use.

Use this device only after learning about its operation, safety information, and the precautions related to its use. After reading the User Manual, keep it in a location where it is always available to the user for easy reference.

The R-series servo amplifiers and servo motors were designed for use with general industrial equipment. The following instructions should be followed:

Read the User Manual carefully before any installation or assembly work to ensure proper use.

Do not perform any retrofitting or modification of the product.

Consult with your sales representatives or a trained professional technician regarding the installation and maintenance of these devices.

Special consideration, such as redundant services or an emergency generator, is required when operating, maintaining and controlling devices in certain applications related to human safety or public functions. Contact your distributor or sales office if you intend to use these devices in applications such as;

In medical instruments or systems used for life support;

With control systems for trains or elevators, the failure of which could cause bodily injury;

In computer systems of social or public importance;

In other equipment or systems related to human safety or public infrastructure.





Additionally, please contact your distributor or sales office if the device is to be used in an environment where vibration is present, such as in-vehicle or transport applications.

Safety Precautions









[Make sure to follow.]

This documentation uses the following annotation. Make sure to strictly follow these safety precautions.





There are four precaution levels.

 Danger	Denotes immediate hazards which WILL probably cause severe bodily injury or death as a result of incorrect operation.
 Caution	Denotes hazards which COULD cause bodily injury and product or property damage as a result of incorrect operation.
	 Even those hazards denoted by this symbol could lead to a serious accident.
 Prohibited	Indicates actions that must be carried out (mandatory actions).
 Mandatory	Indicates actions that must not be allowed to occur prohibited actions.

There are eight graphic symbols.

Type	Sample symbols
Danger symbols	 Danger /Injury  Electric shock
Caution symbols	 Caution  Fire  Burn
Prohibition symbols	 Prohibited  Disassembly prohibited
Mandatory symbol	 Mandatory







Danger

<p>Do not use this device in explosive environment.</p> <p> Injury or fire could otherwise result.</p>	<p>Do not touch the inside of the amplifier.</p> <p> Electric shock could otherwise result.</p>
<p>Do not perform any wiring, maintenance or inspection when the device is hot-wired. After switching the power off, wait at least 5 minutes before performing these tasks.</p> <p> Electric shock could otherwise result.</p>	<p>Only technically qualified personnel should transport, install, wire, operate, or perform maintenance and inspection on this device.</p> <p> Electric shock, injury or fire could otherwise result.</p>







Safety Precautions

[Make sure to follow.]

Danger

<p>The protective ground terminal (⊕) should always be grounded. The ground terminal of the motor should always be connected to the protective ground terminal (⊕) of the amplifier.</p> <p> Electric shock could otherwise result.</p>	<p>Do not damage the cable, do not apply unreasonable stress to it, do not place heavy items on it, and do not insert it in between objects.</p> <p> Electric shock could otherwise result.</p>
<p>Wiring should be done based on the wiring diagram or the user manual.</p> <p> Electric shock or fire could otherwise result.</p>	<p>Do not touch the rotating part of the motor during operation.</p> <p> Bodily injury could otherwise result.</p>
<p>Do not touch or get close to the terminal while the device is powered up.</p> <p> Electric shock could otherwise result.</p>	<p>Do not unplug the connector while the device is powered up.</p> <p> Electric shock could otherwise result.</p>















Caution

<p>Please read the User Manual carefully before installation, operation, maintenance or inspection, and perform these tasks according to the instructions.</p> <p> Electric shock, injury or fire could otherwise result.</p>	<p>Do not use the amplifier or the motor outside their specifications.</p> <p> Electric shock, injury or damage to the device could otherwise result.</p>
<p>Do not use a defective amplifier or motor.</p> <p> Injury or fire could otherwise result.</p>	<p>Use the amplifier and motor together in the specified combination.</p> <p> Fire or damage to the device could otherwise result.</p>
<p>Be careful of the high temperatures generated by the amplifier/motor and the peripherals.</p> <p> Burn could otherwise result.</p>	<p>Open the box only after checking its top and bottom location.</p> <p> Bodily injury could otherwise result.</p>

Safety Precautions

[Make sure to follow.]













Caution

<p>Verify that the products correspond to the order sheet/packing list. If the wrong product is installed, injury or damage could result.</p> <p> Injury or damage could result.</p>	<p>Keep the motor's sensor terminals away from static electricity.</p> <p> Damage to the device could otherwise result.</p>
<p>Do not measure the insulation resistance and the pressure resistance.</p> <p> Damage to the device could otherwise result.</p>	<p>Wiring should follow electric equipment technical standards and indoor wiring regulations.</p> <p> An electrical short or fire could otherwise result.</p>
<p>Wiring connections must be secure.</p> <p> Motor interruption or bodily injury could otherwise result.</p>	<p>Keep static electricity and high voltage away from the sensor terminals of the motor.</p> <p> Damage to the device could otherwise result.</p>
<p>Do not stand on the device or place heavy objects on top of it.</p> <p> Bodily injury could otherwise result..</p>	<p>Do not obstruct the air intake and exhaust vents, and keep them free of debris and foreign matter.</p> <p> Fire could otherwise result.</p>
<p>Make sure the mounting orientation is correct.</p> <p> Fire or damage to the device could otherwise result.</p>	<p>Consult the User Manual regarding the required distance between the amplifier, the control panel interior, and other devices.</p> <p> Damage to the device could otherwise result.</p>
<p>Do not subject the device to excessive shock or vibration.</p> <p> Damage to the device could otherwise result.</p>	<p>Secure the device against falling, overturning, or shifting inadvertently during installation.</p> <p> Use the hardware supplied with the motor (if applicable).</p>
<p>Do not expose the device to water, corrosive or flammable gases, or any flammable material.</p> <p> Fire or damage to the device could otherwise result.</p>	<p>Install the device on a metal or other non-flammable support.</p> <p> Fire could otherwise result.</p>

Safety Precautions

[Make sure to follow.]





Caution

<p>There is no safeguard on the motor. Use an over-voltage safeguard, short-circuit breaker, overheating safeguard, and emergency stop to ensure safe operation.</p> <p> Injury or fire could otherwise result.</p>	<p>Do not touch the radiation fin of the amplifier, the regenerative resistor, or the motor while the device is powered up, or immediately after switching the power off, as these parts generate excessive heat.</p> <p> Burn could otherwise result.</p>
<p>In the case of any irregular operation, stop the device immediately.</p> <p> Electric shock, injury or fire could otherwise result.</p>	<p>Do not perform extensive adjustments to the device as they may result in unstable operation.</p> <p> Bodily injury could otherwise result.</p>
<p>Trial runs should be performed with the motor in a fixed position, separated from the mechanism. After verifying successful operation, install the motor on the mechanism.</p> <p> Bodily injury could otherwise result.</p>	<p>The securing brake is not to be used as a safety stop for the mechanism. Install a safety stop device on the mechanism.</p> <p> Bodily injury could otherwise result.</p>
<p>In the case of an alarm, first remove the cause of the alarm, and then verify safety. Next, reset the alarm and restart the device.</p> <p> Bodily injury could otherwise result.</p>	<p>Verify that the power specifications are normal.</p> <p> Damage to the device could otherwise result</p>
<p>Avoid getting close to the device, as a momentary power outage could cause it to suddenly restart (although it is designed to be safe even in the case of a sudden restart).</p> <p> Bodily injury could otherwise result.</p>	<p>Standard specification servo amplifiers have a dynamic brake resistor. Do not rotate the motor continuously from the outside when the amplifier is not powered on, because the dynamic brake resistor will heat up, and can be dangerous.</p> <p> Fire or burn could otherwise result.</p>
<p>Be careful during maintenance and inspection, as the body of the amplifier becomes hot.</p> <p> Burn could otherwise result.</p>	<p>It is recommended to replace the electrolytic capacitors in the amplifier after 5 years, if used at an average temperature of 40°C year round. The expected life of the cooling fan motor is 10 years, if used at an average temperature of 40°C year round. Regular replacement is recommended.</p> <p> Damage to the device could otherwise result.</p>





Safety Precautions

[Make sure to follow.]



Caution

<p>Please contact your distributor or sales office if repairs are necessary. Disassembly could render the device inoperative.</p> <p> Damage to the device could otherwise result.</p>	<p>Make sure the device does not fall, overturn, or move inadvertently during transportation.</p> <p> Bodily injury could otherwise result.</p>
<p>Do not hold the device by the cables or the shaft while handling it.</p> <p> Damage to the device or bodily injury could otherwise result.</p>	<p>If the amplifier or the motor is no longer in use, it should be discarded as general industrial waste.</p> <p></p>





Prohibited

<p>Do not store the device where it could be exposed to rain, water, toxic gases or other liquids.</p> <p> Damage to the device could otherwise result.</p>	<p>The built-in brake is intended to secure the motor; do not use it for regular control. Damage to the brake could otherwise result.</p> <p> Damage to the device could otherwise result.</p>
<p>Do not overhaul the device.</p> <p> Fire or electric shock could otherwise result.</p>	<p>Do not remove the nameplate cover attached to the device.</p> <p></p>

Mandatory

<p>Store the device where it is not exposed to direct sunlight, and within the specified temperature and humidity ranges { - 20°C to + 65°C , below 90% RH (non-condensing)}.</p> <p></p>	<p>Please contact our office if the amplifier is to be stored for a period of 3 years or longer. The capacity of the electrolytic capacitors decreases during long-term storage, and could cause damage to the device.</p> <p> Damage to the device could otherwise result.</p>
--	--

Mandatory

<p>Install an external emergency stop circuit that can stop the device and cut off the power instantaneously. Install an external protective circuit to the amplifier to cut off the power from the main circuit in the case of an alarm. Motor interruption, bodily injury, burnout, fire and secondary damages could otherwise result.</p> <p> </p>	<p>Operate within the specified temperature and humidity range {Amplifier: Temperature 0°C to 55°C, Humidity below 90% RH (non-condensing); Motor: Temperature 0°C to 40°C, Humidity below 90% RH (non-condensing)}.</p> <p> Burnout or damage to the device could otherwise result.</p>
<p>Follow the directions written on the outside box. Excess stacking could result in collapse.</p> <p> Bodily injury could otherwise result.</p>	<p>The motor angling bolts are used for transporting the motor itself; do not use them for transporting the machinery, etc.</p> <p> Damage to the device or bodily injury could otherwise result.</p>

[Table of Contents]

[1 Prior to use]

Product Verification	1-1
Servo Motor Model Number	1-2
Servo Amplifier Model Number	1-3
Servo Amplifier Part Names	1-7
Servo Motor Part Names	1-9

[2 Installation]

Servo Amplifier	2-1
Mounting Direction and Location	2-3
Arrangement within the Machine	2-3
Servo Motor	2-5
Waterproofing and Dust Proofing	2-5
Protective Cover Installation	2-5
Gear Installation	2-6
Integration with the Target Machinery	2-6
Allowable Bearing Load	2-8

[3 Wiring]

Packaged Wiring Diagram	3-1
High Voltage Circuit / Name • Function • Terminal Number	3-5
Tightening Torque of High Voltage Circuit Terminal	3-6
Wiring Example of High Voltage Circuit • Protective Circuit	3-7
Description of CN Terminal / Low Voltage Circuit	3-9
Description of CN 1 Terminal / Low Voltage Circuit	3-10
Overall Wiring Diagram of CN1/Low Voltage Circuit	3-11
Wiring Example of CN1 Input Circuit/Low Voltage Circuit	3-12
Wiring Example of CN1 Output Circuit/Low Voltage Circuit	3-15
Wiring of CN2/Low Voltage Circuit	3-17
Power Source • Peripherals • Cable Diameter	3-19

[4 Digital operator]

Names and Functions	4-1
Various Modes	4-2
Changing Modes	4-3
Monitor Mode Operations and Display	4-4
Basic Mode Operations and Display	4-7
General Parameter Mode Operations and Display	4-9
Auto-adjustment Mode Operations and Display	4-11
Test Run Mode Operations and Display	4-12
System Parameter Mode Operations and Display	4-14
Alarm Trace/CPU_VER Operations and Display	4-15
Password Setting	4-16

[5 Description of parameters]

Parameter List	5-1
Parameter Setting Value 【Group0】 【Group1】	5-7
Parameter Setting Value 【Group2】	5-9
Parameter Setting Value 【Group3】	5-10
Parameter Setting Value 【Group4】	5-12
Parameter Setting Value 【Group8】	5-13
Parameter Setting Value 【Group9】	5-18
Parameter Setting Value 【GroupA】	5-20
Parameter Setting Value 【GroupB】	5-23
Parameter Setting Value 【GroupC】	5-26
System Parameter Setting Value	5-28

[6 Operations]

Procedure Prior to Operation	6-1
Confirmation of Installation and Wiring	6-3
Confirmation & Change of Servo Amplifier Specification	6-4
Confirmation & Change of Servo Motor Encoder Specification	6-5
Confirmation & Change of Servo Motor Model Number	6-6
JOG Operation	6-7
Confirmation of I/O Signal	6-8
Confirmation of Device Operation	6-9
Operation Sequence	6-10

[7 Adjustment • Functions]

Servo Gain Tuning	7-1
Functions of G r o u p 8	7-7
Functions of G r o u p 9	7-25
Functions of G r o u p B	7-31
Functions of G r o u p C	7-36
Functions of Monitors	7-39

[8 Maintenance]

Trouble Shooting	8-1
Alarm List	8-3
Trouble shooting when the Alarm Occurs	8-5
Inspection/Parts Overhaul	8-25

[9 Specifications]

Servo amplifier	9-1
Pulse output	9-4
Serial output	9-5
General servo motor	9-23
Rotation Direction Specifications	9-23
Mechanical specifications	9-24
Holding brake specifications	9-26

[Materials]

[Selection Details]

Acceleration time / Moderation time / Allowable repetition frequency	1
Loading Precautions	3
Dynamic brake	4
Regenerative treatment / Regenerative electric power calculation / Confirmation of regenerative electric power	6
External regenerative resistor / Dimension	11

[International standards]

International standard conformity · Certificate number	18
Compliance with E C directives · Recommended prevention components	20

[Dimension]

Servo amplifier	24
Servo motor	30

[Servo motor data sheet]

Characteristics table	34
Velocity - Torque characteristics	38

[Options]

Connector · Communication cable	43
Metal mounting fittings	44
Monitor box	47
Lithium battery · E M C kit	48

[Encoder clear]

Clear · Reset method	49
----------------------	----

[Electronic gear]

Usage	50
-------	----

[Shortened model number]

Set-up contents	51
-----------------	----

[Prior to Use]

- ◆ Product verification 1-1
- ◆ Servo motor model number 1-2
- ◆ Servo amplifier model number 1-3
- ◆ Servo amplifier part names 1-7
- ◆ Servo motor part names 1-9

1. Prior to Use

[Product verification]

Verify the followings when the product arrives. If you find any discrepancy, contact your distributor or sales office.

Verify that the model number of the servo motor or servo amplifier is the same as ordered.
(The model number is located on the main name plate, following the word "MODEL".)

Verify that there are no abnormalities, such as damages to the exterior of the device, or missing accessories.

Verify that there are no loose screws on the servo motor or servo amplifier.

Servo motor

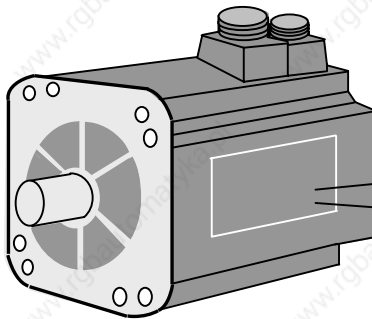

Servo motor main nameplate

AC SERVO SYSTEMS	Q
MODEL Q2AA04006DXS21	Model No
60W AC200V 0.53A	
3000min ⁻¹ 3 - - C.I.F IP40	
SER No.090206001	Serial No
SANYO DENKI MADE IN JAPAN 00482921-01	

Servo amplifier

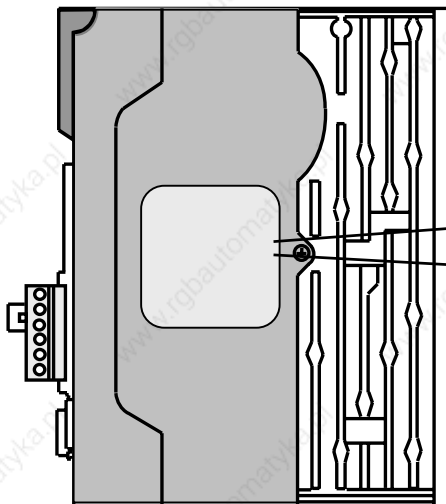

Servo amp main nameplate

SANMOTION	R
AC SERVO SYSTEMS	
MODEL RS1A10AA03E01P00	Model No.
INPUT	
OUTPUT	
SER No.0505120600	Serial No
CE TUV cULus	
SANYO DENKI MADE IN JAPAN 00579700	

Interpretation of the serial number

Month (2 digits) + Year (2 digits) + Day (2 digits)+
Serial number (4 digits) + Revision ("A" is abbreviated)

1. Prior to Use

[Servo motor model number]

Interpretation of servo motor model number

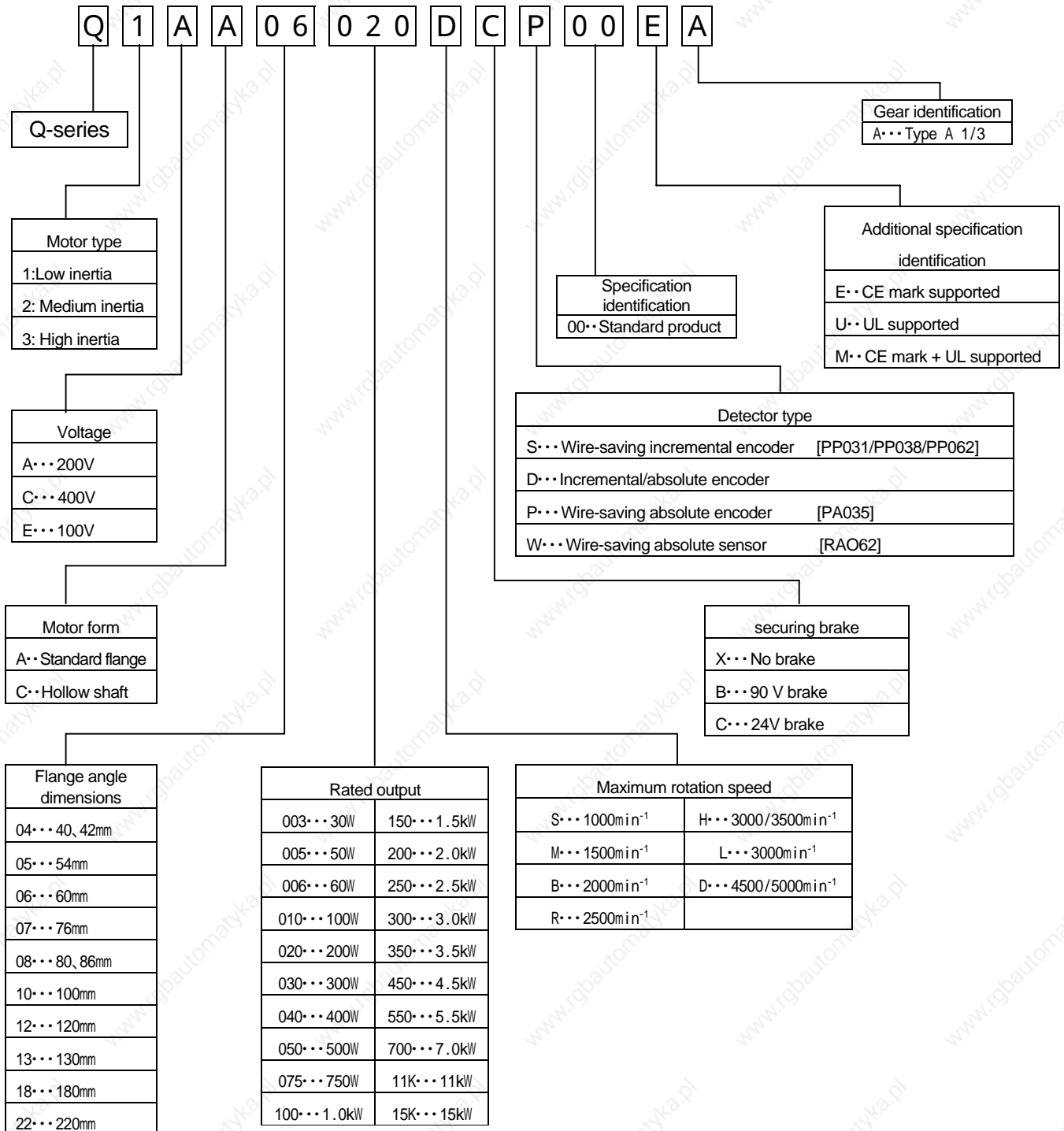

The design order is noted by alphabetical characters at the end of the Lot Number on the nameplate.

1. Prior to Use [Servo amplifier model number]

Interpretation of servo amplifier model number (Full number)

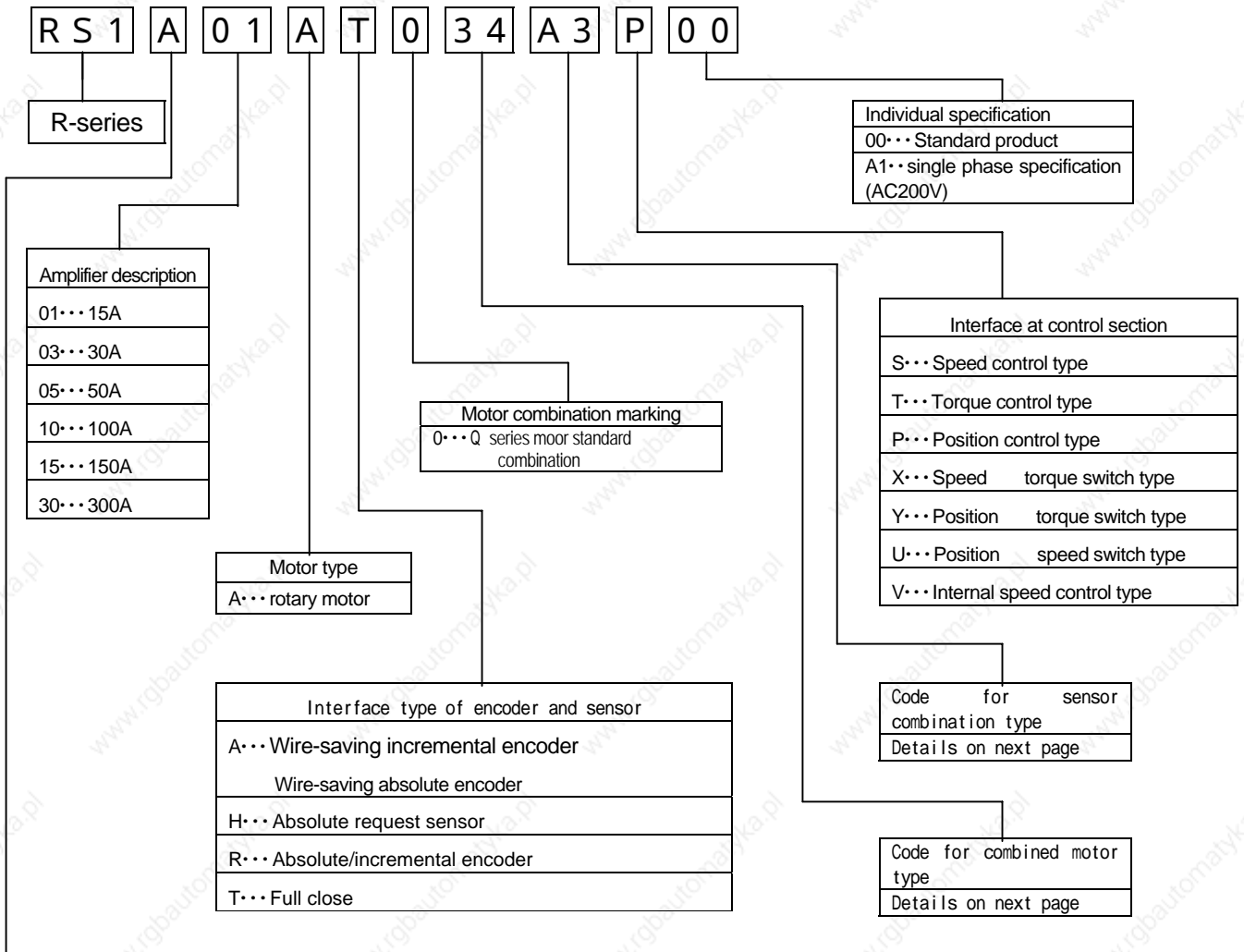

Power input, power part details			Model numbers by amplifier capacity		
Input voltage	Regenerative resistor	DB	15A...RS1 01 30A...RS1 03	50A...RS1 05 100A...RS1 10 150A...RS1 15	300A...RS1 30
AC200V	Built-in	W	L	A	-
		W/O	M	B	-
		W	A	L	A
		W/O	B	M	B
AC100V	Built-in	W	N	-	-
		W/O	P	-	-
		W	E	-	-
		W/O	F	-	-

The design order is noted by alphabetical characters at the end of the Lot Number on the name plate.

1. Prior to Use [Servo amplifier model number]

Interpretation of servo amplifier model number (Abbreviated number)

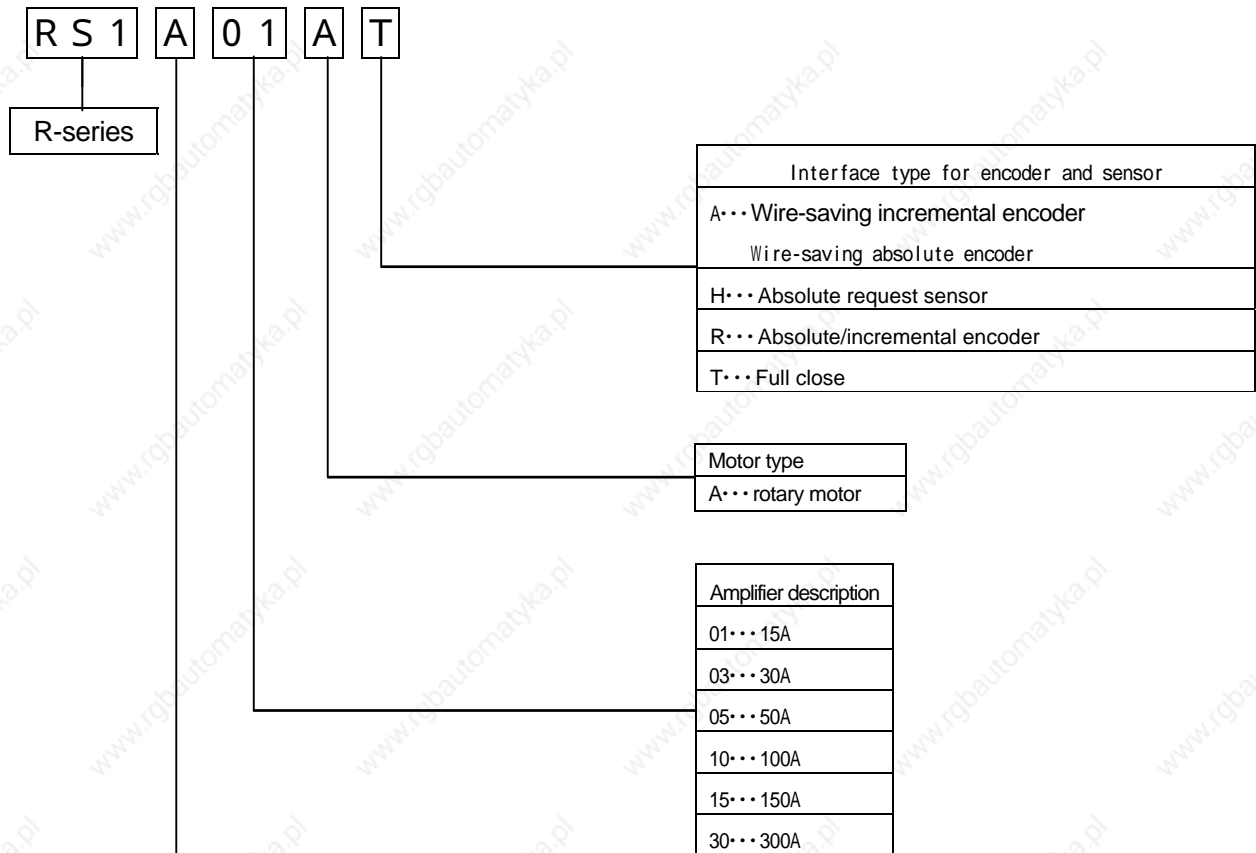

Power input, power part details			Model numbers by amplifier capacity		
Input voltage	Regenerative resistor	DB	15A...RS1 01 30A...RS1 03	50A...RS1 05 100A...RS1 10 150A...RS1 15	300A...RS1 30
AC200V	Built-in	W	L	A	-
		W/O	M	B	-
		W	A	L	A
		W/O	B	M	B
AC100V	Built-in	W	N	-	-
		W/O	P	-	-
		W	E	-	-
		W/O	F	-	-

Refer to Chapters 5 and 6 for how to set parameters which have been set at the time of shipment, and to page 50 of the attached data for setting contents.

The design order is noted by alphabetical characters at the end of the Lot Number on the name plate.

1. Prior to Use [Servo amplifier model number]

Motor setting and sensor type of abbreviated model numbers

Servo amplifier model number	Servo motor model number	Sensor
RS1 01AA	P50B03003D	Standard I/F such as a wire-saving incremental encoder or wire-saving absolute encoder 2000P/R
RS1 03AA	P50B07040D	
RS1 05AA	P50B08075D	
RS1 10AA	P60B13200H	
RS1 15AA	P80B22350H	
RS1 30AA	P60B18750R	
RS1 01AH	P50B03003D	Absolute request sensor 15bit
RS1 03AH	P50B07040D	
RS1 05AH	P50B08075D	
RS1 10AH	P60B13200H	
RS1 15AH	P80B22350H	
RS1 30AH	P60B18750R	
RS1 01AR	P50B03003D	Absolute/incremental encoder 2048P/R
RS1 03AR	P50B07040D	
RS1 05AR	P50B08075D	
RS1 10AR	P60B13200H	
RS1 15AR	P80B22350H	
RS1 30AR	P60B18750R	
RS1 01AT	P50B03003D	Standard I/F such as a wire-saving incremental encoder or wire-saving absolute encoder 2000P/R
RS1 03AT	P50B07040D	
RS1 05AT	P50B08075D	
RS1 10AT	P60B13200H	
RS1 15AT	P80B22350H	
RS1 30AT	P60B18750R	

: Depends on input power voltage, regeneration resistance and dynamic brake resistance.
 In case of 200VAC input voltage, A, B, L and M will be filled in.
 In case of 100VAC input voltage, E, F, N and P will be filled in. (However, there are only RS1 01、RS1 03.)

1. Prior to Use

[Servo amplifier part names]

RS1 01A / RS1 03A

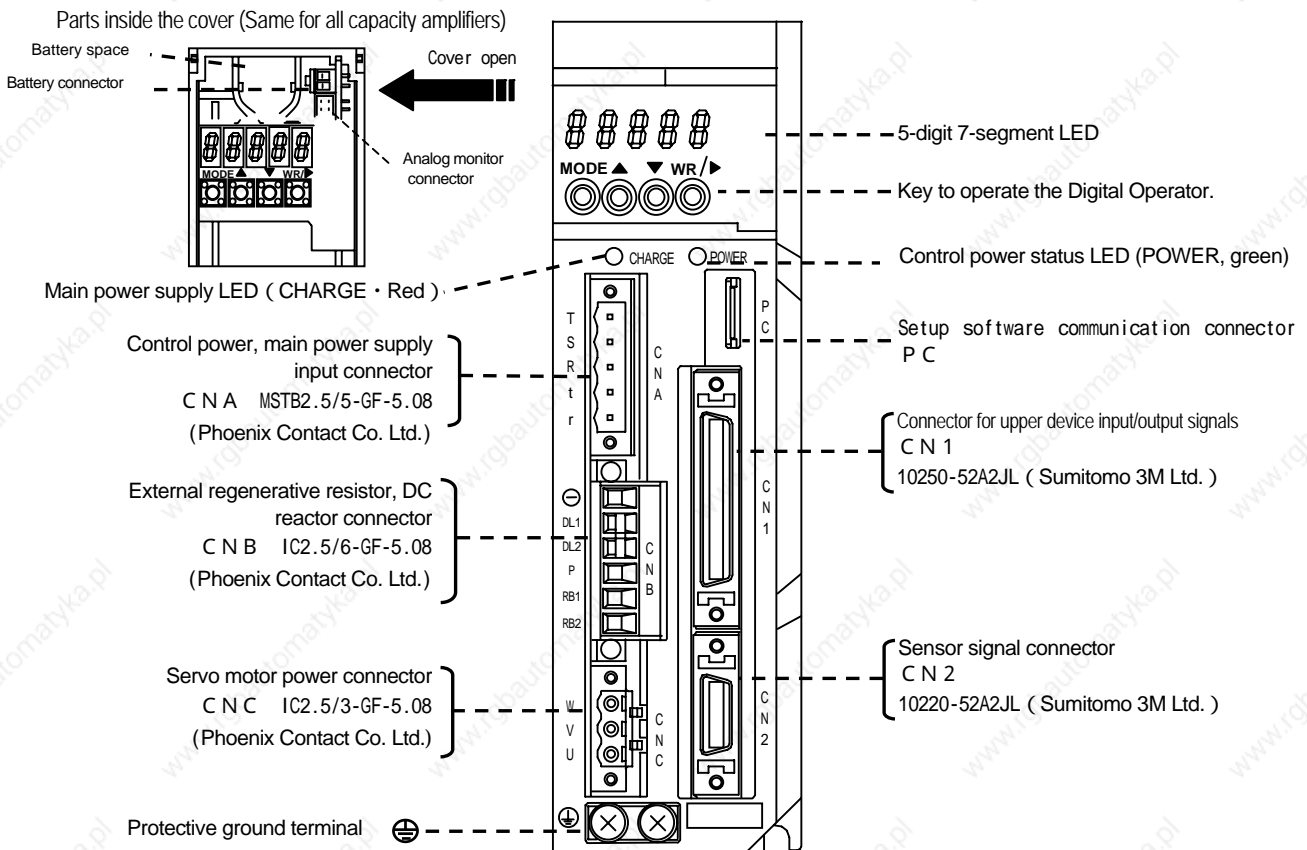

RS1 05A

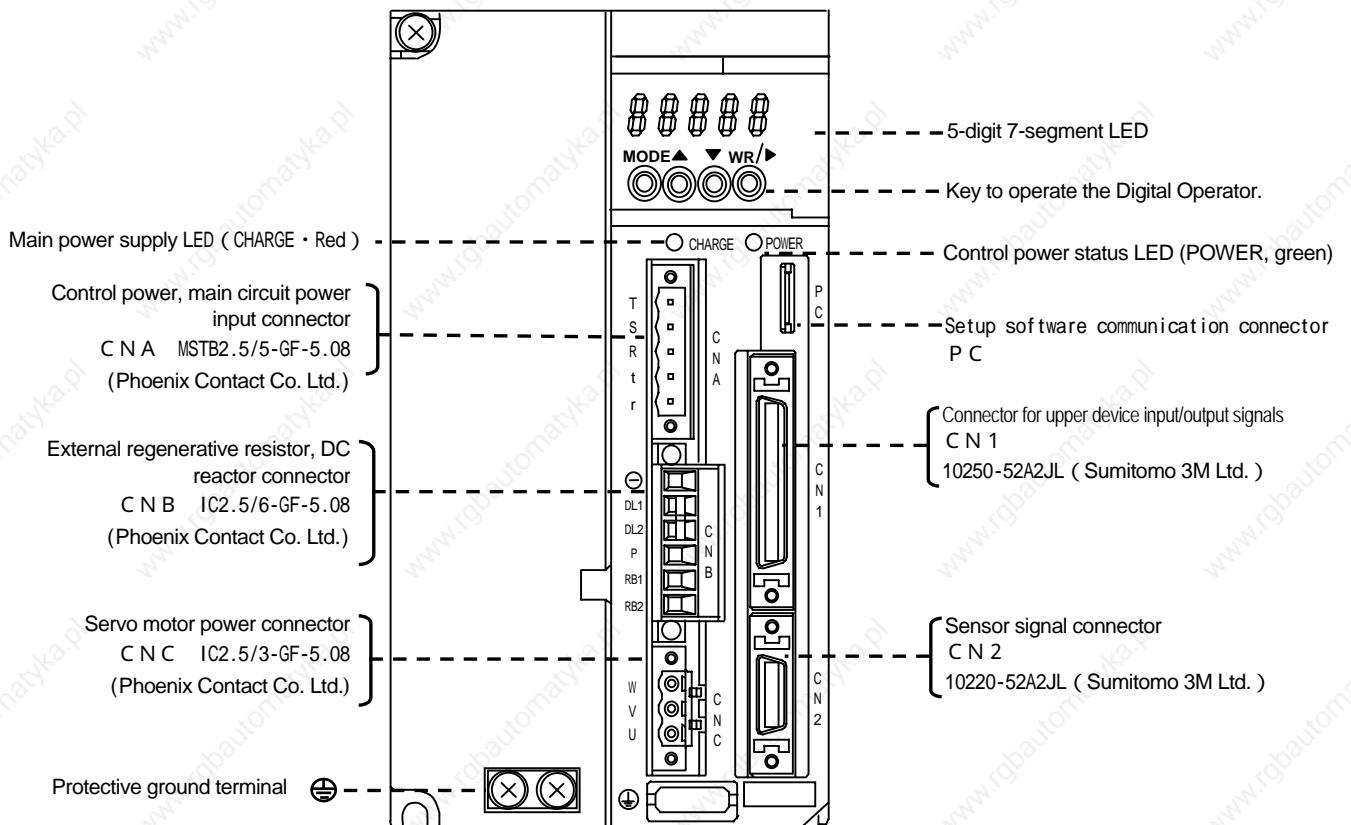

1. Prior to Use

[Servo amplifier part names]

RS1 10A / RS1 15A

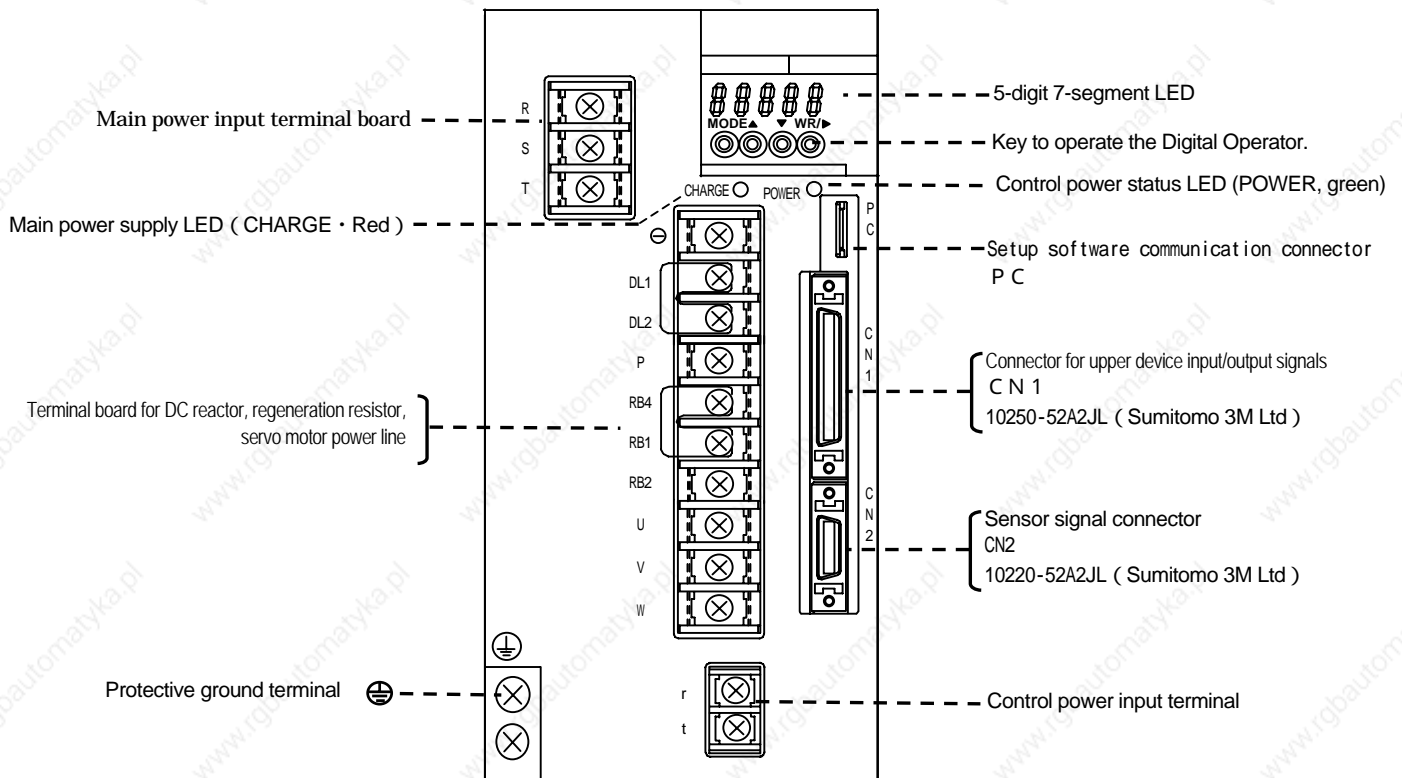

RS1 30A

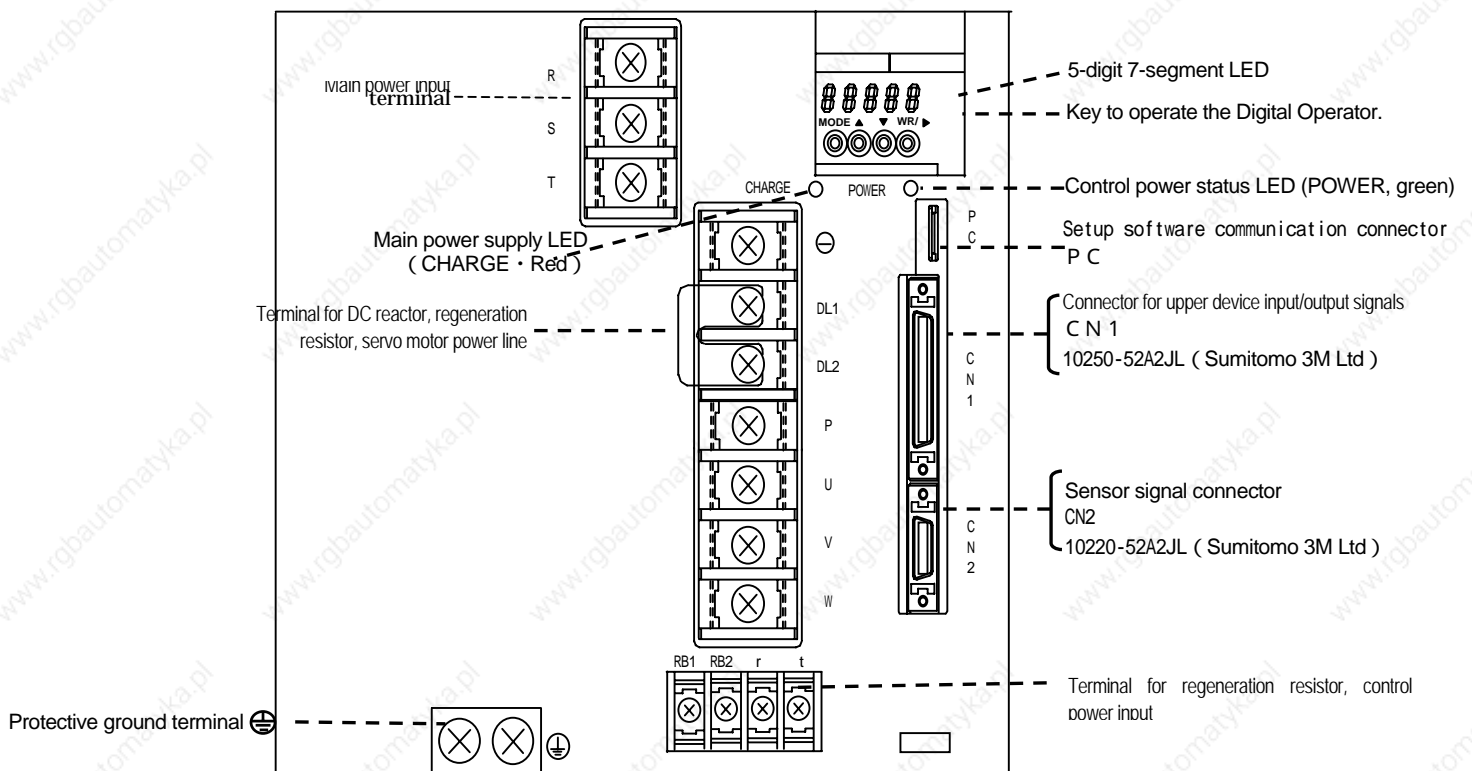

1. Prior to Use

[Servo motor part names]

Lead wire types

- Q1AA04
- Q1AA06
- Q1AA07
- Q2AA04
- Q2AA05
- Q2AA07
- Q2AA08

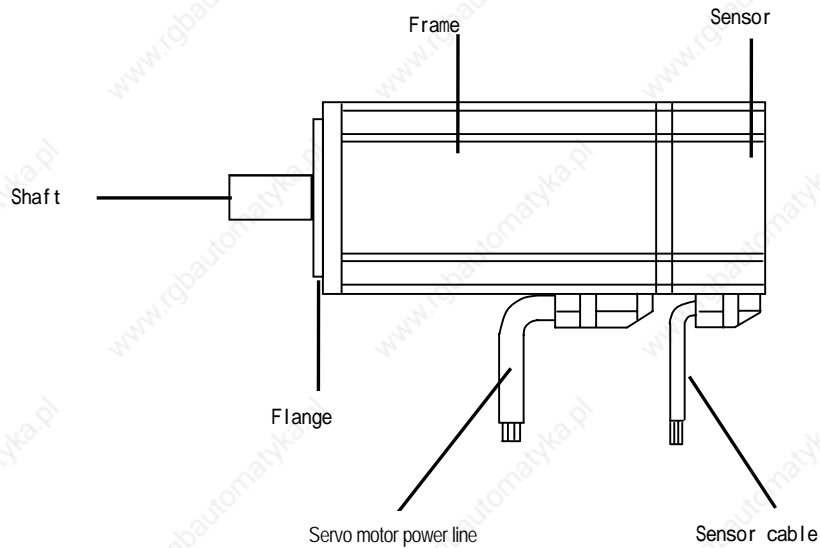

Cannon plug type

- Q1AA10
- Q1AA12
- Q1AA13
- Q1AA18
- Q2AA10
- Q2AA13
- Q2AA18
- Q2AA22

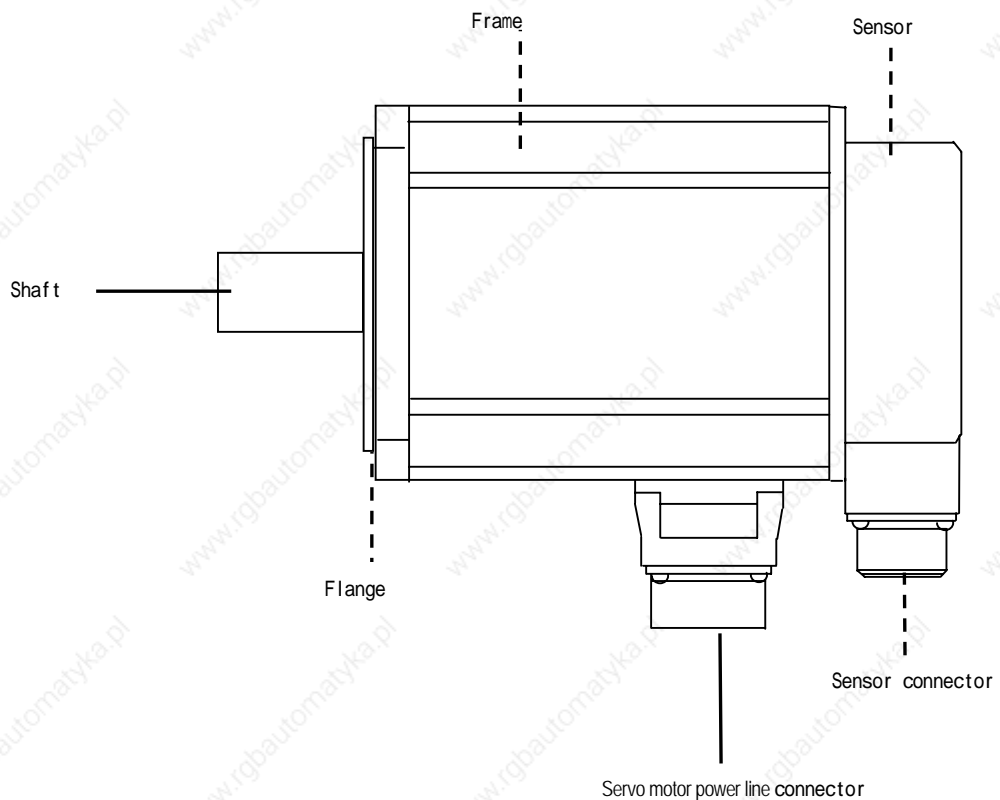

[Installation]

◆	Servo amplifier	2-1
	Mounting direction and location	2-3
	Arrangement within the machine	2-3
◆	Servo motor	2-5
	Waterproofing and dust proofing	2-5
	Protective cover installation	2-5
	Gear installation	2-6
	Integration with the target machinery	2-6
	Allowable bearing load	2-8

2. Installation

[Servo amplifier]

Please note the following points regarding the servo amplifier installation location and mounting method.

Various precautions



The device should be installed on non-flammable surfaces only. Installation on or near flammable materials can cause fire.	Do not stand, put or drop heavy items on the servo amplifier.
Operate the device within the specified environmental conditions.	Do not drop the device or subject it to excessive shock.
Do not install or operate a damaged device, or one with damaged parts; return it for repair.	Make sure no screws or other conductive or flammable materials get inside the servo amplifier.
Contact your distributor or sales office if the servo amplifier was stored or out of use for an extended period of time.	

If enclosed in a cabinet



The temperature inside the cabinet can exceed the external temperature depending on the power consumption of the device and the size of the cabinet. Consider the cabinet size, cooling, and placement, and make sure the temperature around the servo amplifier does not exceed 55°C. For longevity and reliability purposes it is recommended to keep the temperature below 40°C.

If there is a vibration source nearby



Protect the servo amplifier from vibration by installing it on a base with a shock absorber.

If there is a heat generator nearby



If the ambient temperature may increase due to convection or radiation, make sure the temperature near the servo amplifier does not exceed 55°C.

If corrosive gas is present



Long-term use may cause contact failure on the connectors and connecting parts.
Never use the device where it may be exposed to corrosive gas.

2. Installation

[Servo amplifier]

If explosive or combustible gas is present

Never use the device where explosive or combustible gas is present. The device's relays and contacts, regenerative resistors and other parts can arc (spark) and can cause fire or explosion.

If dust or oil mist is present

The device cannot be used where dust or oil mist is present. If dust or oil mist accumulates on the device, it can cause insulation deterioration or leakage between the conductive parts, and damage the servo amplifier.

If a large noise source is present

If inductive noise enters the input signals or the power circuit, it can cause a malfunction. If there is a possibility of noise, inspect the line wiring and take appropriate noise prevention measures. A noise filter should be installed to protect the servo amplifier.

2. Installation

[Servo amplifier]

Mounting direction and location

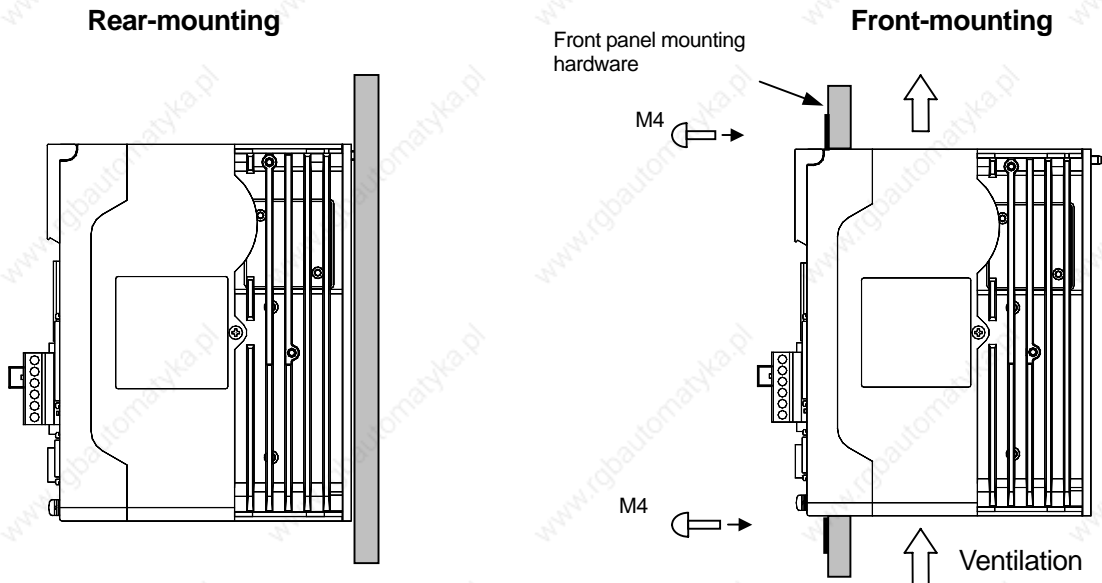

For metal fittings for front/rear mounting, refer to options (compatible with PY2 mounting).

Arrangement within the machine

Leave at least 10 mm space above and below the servo amplifier to ensure unobstructed airflow from the inside of the servo amplifier and the radiator. If heat gets trapped above the servo amplifier, use a fan to create airflow.

Leave at least 10 mm space on both sides of the servo amplifier to ensure unobstructed airflow from the heat-sinks on the side and from the inside of the servo amplifier.

If the Q-series servo amplifier is installed on its side, make sure that the ambient temperature does not exceed 50°C, and mount the back panel to a metal plate at least 2mm thick.

For RS1 03 · RS1 05, a fan is attached at the side. Therefore, it is recommended that the servo amplifier be mounted in an arrangement as shown below.

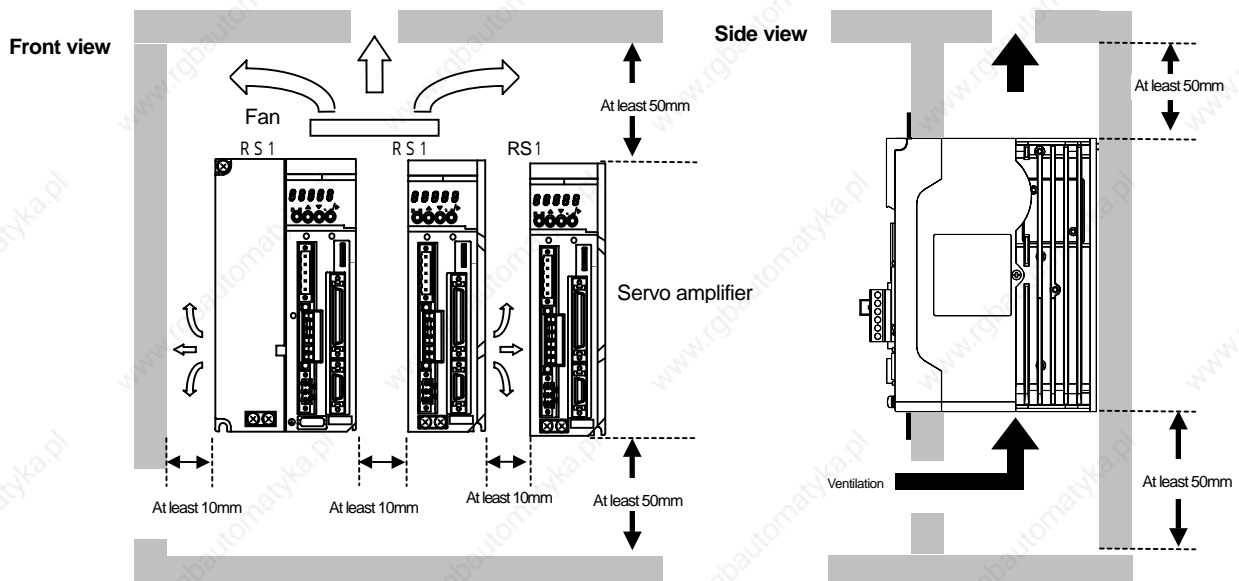

2. Installation

[Servo motor]

Please note the following regarding the installation location and mounting method for the servo motor.

The servo motor is designed for indoor use. Make sure to Install it indoors.	
Do not use the device in locations where the oil seal lip is continuously exposed to oil, or where the device is exposed to large quantities of water, oil drops, or cutting fluid. The motor is designed to withstand only small amounts of moisture spray.	
Ambient temperature: 0 to 40°C Storage temperature: -20 to 65°C Ambient humidity: 20 to 90%	Good ventilation, no corrosive or explosive gases present. No dust or dirt accumulation in the environment. Easy access for inspection and cleaning.

Mounting method

Mounting in several orientations - horizontal, or with the shaft on top or bottom- is acceptable.

If the output shaft is used in reduction devices that use grease, oil, or other lubricants, or in mechanisms exposed to liquids, the motor should be installed in a perfectly horizontal or downward position.

In some models, there is an oil-seal attached to the output shaft. If the shaft is facing upwards and the seal lip is continuously exposed to oil, oil can enter inside the motor and cause damage, as a result of wear and degradation of the oil seal. In such cases an oil-seal should be used on the load-side as well. Contact your distributor or sales office if the device is to be used in such conditions.

The motor connector and cable outlet should be installed facing downwards, as nearly vertical as possible.

In vertical installation, create a cable trap to prevent oily water from getting into the motor.

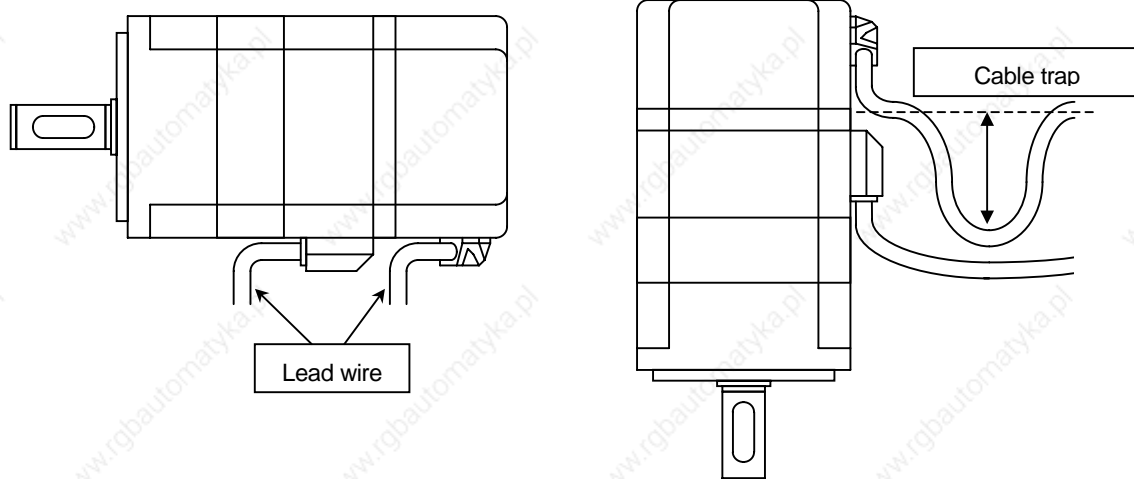

2. Installation

[Servo motor]

Waterproofing and dust proofing

The protection inside the motor conforms to IEC standards (IEC34-5). However, such protection is suitable only for short-term use. For regular use, additional sealing measures are required.

Be sure to handle the connector carefully, as damage to the exterior of the connector (painted surface) can reduce its waterproofing capability.

The motor waterproofing is of IPX 7 class level, but still requires careful handling. If the motor is continuously wet, due to the respiratory effect of the motor, liquid may penetrate inside the motor.

Install a protective cover to prevent corrosion of the coating and the sealing material, which can be caused by certain types of coolants (especially water soluble types).

Q1- and Q2-series motors with canon plugs are only IP67 rated if waterproof connectors and/or conduits are used on the matching canon connectors.

Q1-series motors (with all flange sizes) and Q2-series motors (with the 42mm flange size) are IP40 rated, but IP67 rated waterproofing is also available as an option. Q2-series motors with flange sizes of 54mm, 76mm and 86mm have IP67 rated waterproofing.

Protective cover installation

Install a protective cover (as described below) for motors continuously subjected to liquids.

Turn the connectors (lead outlets) downwards within the angle range shown in the picture below.

Install the cover on the side where the water or oil would drip.

Install the cover at an angle (for runoff), to prevent water or oil from collecting.

Make sure that the cable does not get soaked in water or oil.

Create a sag in the cable outside the cover, to make sure water or oil does not penetrate to the motor.

If it is not possible to install the connectors (lead outlets) facing downwards, create a sag in the cable to prevent water or oil from entering the motor.

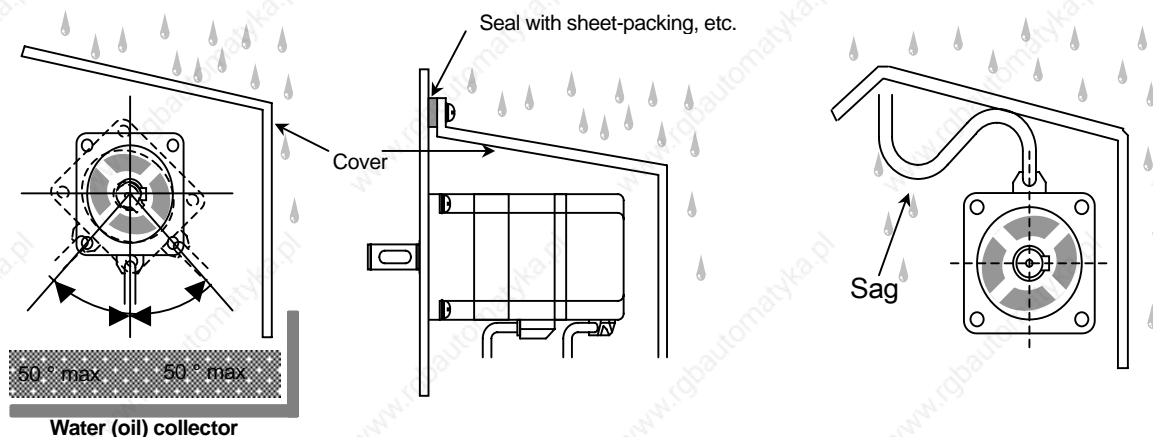

2. Installation

[Servo motor]

Gear installation

The oil level of the gear box should be below the oil seal lip, for a slight spraying effect on the lip.

Create a hole to prevent pressure build-up inside the gear box, as pressure can cause water or oil to penetrate the oil seal and enter inside the motor.

If the motor is used with the shaft facing upwards, an oil seal should be used on the opposite side of the mechanism as well. In addition, install a drain to expel the water or oil that may penetrate through this oil seal.

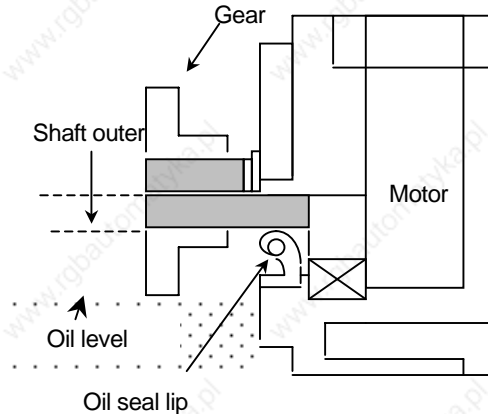

Integration with the target machinery

Refer to the drawing below for correct centering of the motor shaft and the target machinery. Please note when using a rigid coupling that even a slight mistake in centering can damage the output shaft.

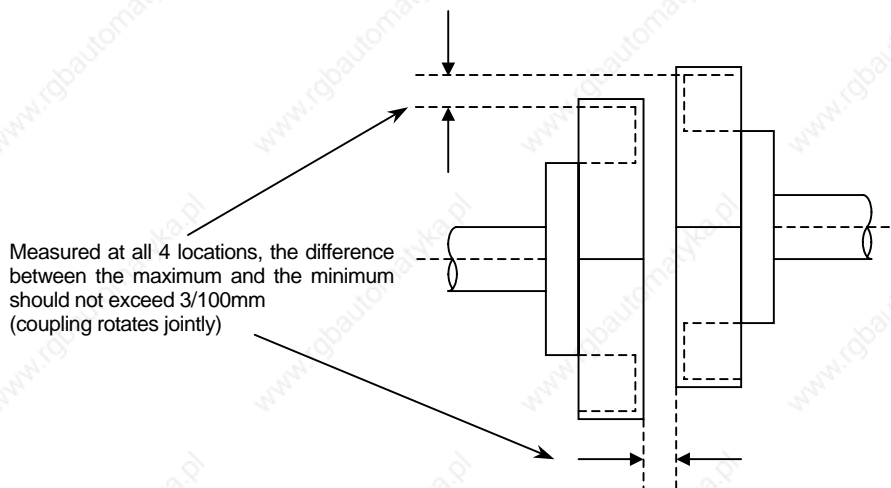

2. Installation

[Servo motor]

Do not subject the motor shaft to shock, as the precision encoder is directly connected to it. If it is absolutely necessary to hit the motor for position adjustment or other reasons, use a rubber or plastic hammer and hit the front flange area.

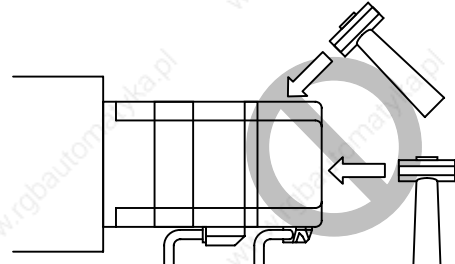
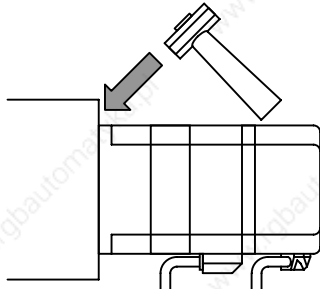

If mounting to a machine, create enough mounting holes for smooth coupling of the motor flange rabbet.

The mounting surface should be flat, otherwise damage to the shaft or the load may occur.

Use the screw at the end of the shaft for installing parts such as the gear, pulley, or coupling, to avoid shock.

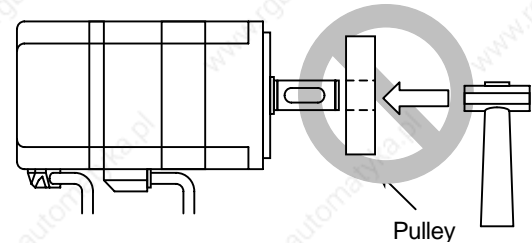
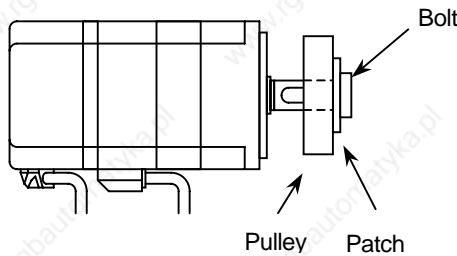

Tapered motor shafts transmit the torque via the tapered surface. Make sure the key fits without rattling. The tapered surface contact should be no less than 70%.

Use a special tool for removing the gear, pulley, etc.

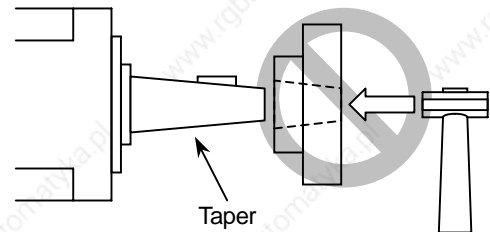
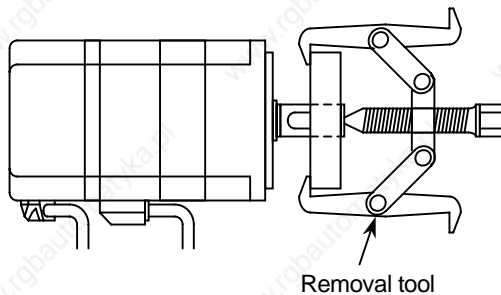

2. Installation

[Servo motor]

Allowable bearing load

The table below shows the allowable bearing load of the servo motors. Do not apply excessive thrust load or radial load. In case of belt driving, make sure that the shaft converted value of belt tension does not exceed the allowable values shown below. The thrust load and radial load tolerance values assume individual application to the shaft.

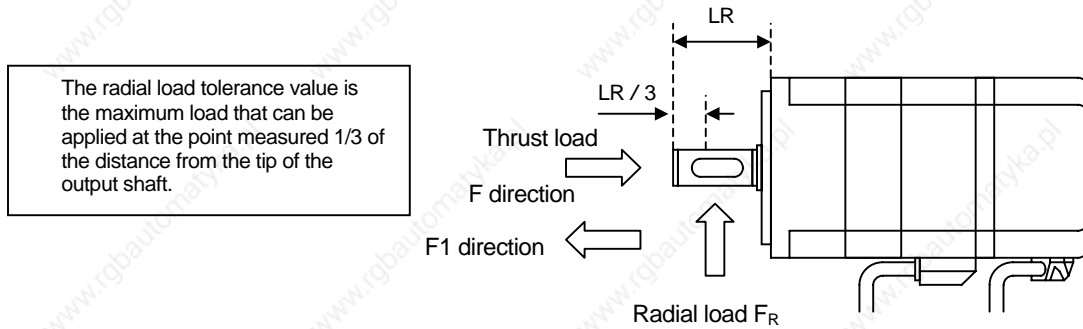

	Model	Assembly			Operation		
		Radial load (N)s	Thrust load (N)		Radial load (N)	Thrust load (N)	
		F_R	F direction	F1 direction	F_R	F direction	F1 direction
Q1	Q1AA04003	98	78	78	49	29	29
	Q1AA04005	150	98	98	98	29	29
	Q1AA04010	150	98	98	98	29	29
	Q1AA06020	390	200	200	200	78	78
	Q1AA06040	390	200	200	250	98	98
	Q1AA07075	590	390	390	340	200	200
	Q1AA10100	980	290	290	690	200	200
	Q1AA10150	980	290	290	690	200	200
	Q1AA10200	980	290	290	690	200	200
	Q1AA10250	980	290	290	690	200	200
	Q1AA12100	980	290	290	690	290	290
	Q1AA12200	980	290	290	690	290	290
	Q1AA12300	980	290	290	690	290	290
	Q1AA13300	2000	390	390	980	390	390
	Q1AA13400	2000	390	390	1200	390	390
Q1AA13500	2000	390	390	1200	390	390	
Q1AA18450	2300	1900	1900	1500	490	490	
Q1AA18750	3900	2000	2000	1800	590	590	
Q2	Q2AA04006	150	98	98	98	29	29
	Q2AA04010	150	98	98	98	29	29
	Q2AA05005	200	200	150	150	78	78
	Q2AA05010	200	200	150	150	78	78
	Q2AA05020	250	200	150	200	78	78
	Q2AA07020	250	490	200	200	98	98
	Q2AA07030	250	490	200	200	98	98
	Q2AA07040	250	490	200	250	98	98
	Q2AA07050	250	490	200	250	98	98
	Q2AA08050	590	780	290	340	200	200
	Q2AA08075	590	780	290	340	200	200
	Q2AA08100	590	780	290	340	200	200
	Q2AA10100	980	290	290	690	200	200
	Q2AA10150	980	290	290	690	200	200
	Q2AA13050	1700	1300	1300	490	290	290
	Q2AA13100	1700	1300	1300	690	290	290
	Q2AA13150	1700	1300	1300	690	290	290
	Q2AA13200	1700	1300	1300	690	290	290
Q2AA18200	2300	1900	1900	1500	490	490	

2. Installation

[Servo motor]

	Model	Assembly			Operation		
		Radial load (N)s	Thrust load (N)		Radial load (N)	Thrust load (N)	
		F _R	F direction	F1 direction	F _R	F direction	F1 direction
Q2	Q2AA22350	2300	1900	1900	1500	490	490
	Q2AA22450	2300	1900	1900	1500	490	490
	Q2AA22550	3900	2000	2000	1800	590	590
	Q2AA22700	3900	2000	2000	2500	1100	1100
	Q2AA2211K	3900	2000	2000	2700	1500	1500
	Q2AA2215K	3900	2000	2000	2300	1500	1500

Cable installation considerations

Make sure that no stress is applied to the cable and that it is undamaged.

If the servo motor is installed in a moving location, make sure that no excessive stress is applied to the cable, by allowing a large bending radius.

Avoid pulling the cable over sharp objects such as cutting scrap that can damage its exterior. Make sure the cable is not touching any machinery, and that it is out of the path of people and machines.

Prevent bending or additional weight stress on the cable connection by clamping the cable to the machinery.

In applications where the motor or the cable is moving using a cable bear, the bending radius should be based on the required cable-life and the type of cable used.

Install the cables of moving parts in a manner that permits easy regular replacement.

Consult with your distributor or sales office for recommendations, if you use cables for moving parts.

[Wiring]

- ◆ Packaged Wiring Diagram 3-1
- ◆ High Voltage Circuit/Name • Function • Terminal Number 3-5
- ◆ Tightening Torque of High Voltage Circuit Terminal 3-6
- ◆ Wiring Example of High Voltage Circuit • Protective Circuit 3-7
- ◆ Description of CN Terminal/Low Voltage Circuit 3-9
- ◆ Description of CN1 Terminal/Low Voltage Circuit 3-10
- ◆ Overall Wiring Diagram of CN1/Low Voltage Circuit 3-11
- ◆ Wiring Example of CN1 Input Circuit/Low Voltage Circuit 3-12
- ◆ Wiring Example of CN1 Output Circuit/Low Voltage Circuit 3-15
- ◆ Wiring of CN2/Low Voltage Circuit 3-17
- ◆ Power Source • Peripherals • Cable Diameter 3-19

3. Wiring

[Packaged Wiring Diagram R S 1 0 1/R S 1 0 3/R S 1 0 5]

Packaged wiring diagram

Do not connect S-phase terminal in the usage of AC200V single phase input.

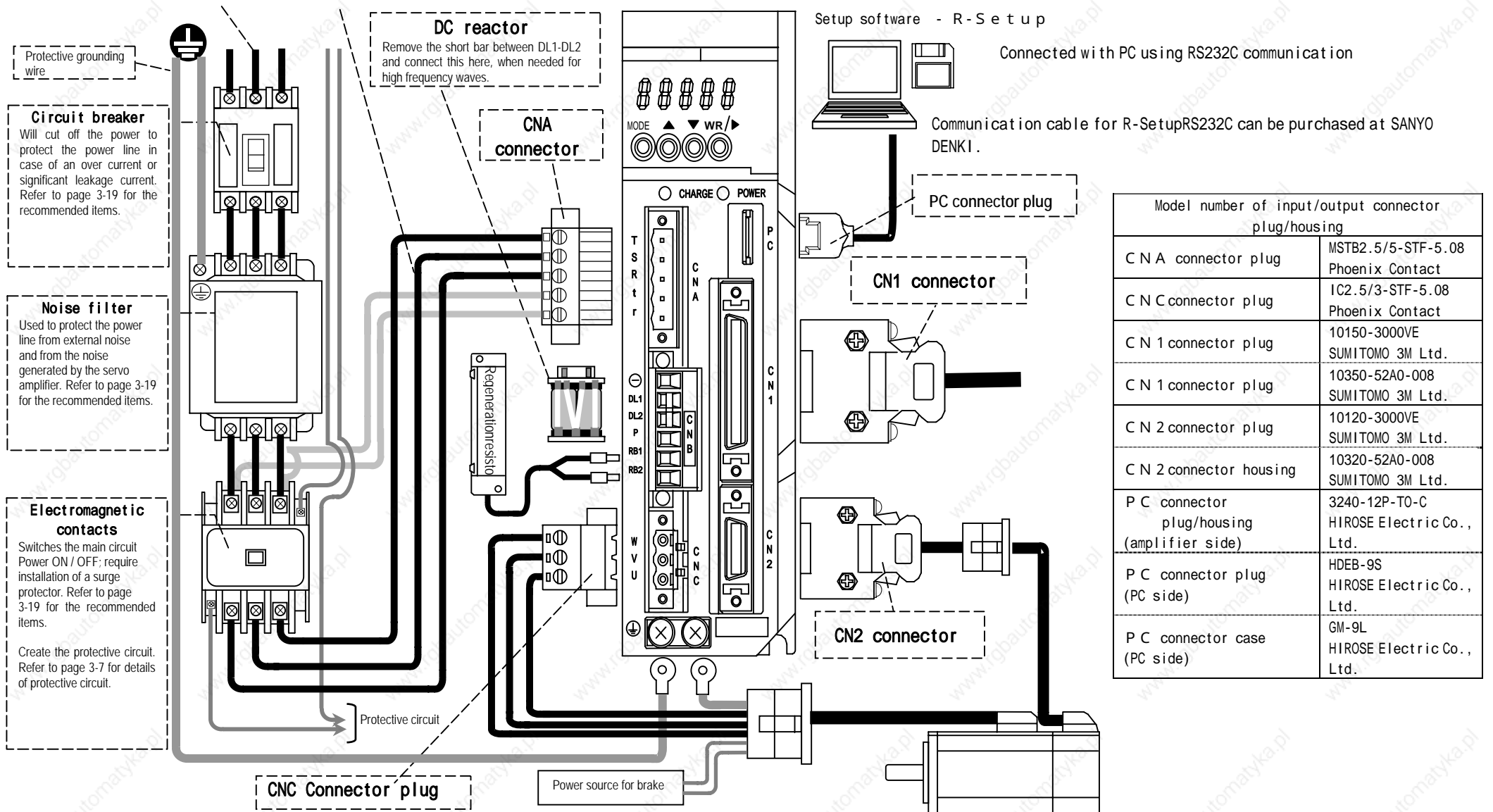

Model number of input/output connector plug/housing	
C N A connector plug	MSTB2.5/5-STF-5.08 Phoenix Contact
C N C connector plug	IC2.5/3-STF-5.08 Phoenix Contact
C N 1 connector plug	10150-3000VE SUMITOMO 3M Ltd.
C N 1 connector plug	10350-52A0-008 SUMITOMO 3M Ltd.
C N 2 connector plug	10120-3000VE SUMITOMO 3M Ltd.
C N 2 connector housing	10320-52A0-008 SUMITOMO 3M Ltd.
P C connector plug/housing (amplifier side)	3240-12P-T0-C HIROSE Electric Co., Ltd.
P C connector plug (PC side)	HDEB-9S HIROSE Electric Co., Ltd.
P C connector case (PC side)	GM-9L HIROSE Electric Co., Ltd.

3. Wiring

[Packaged Wiring Diagram RS1 01/RS1 03]

Packaged wiring diagram AC 100 V input type RS1 01A / RS1 03A

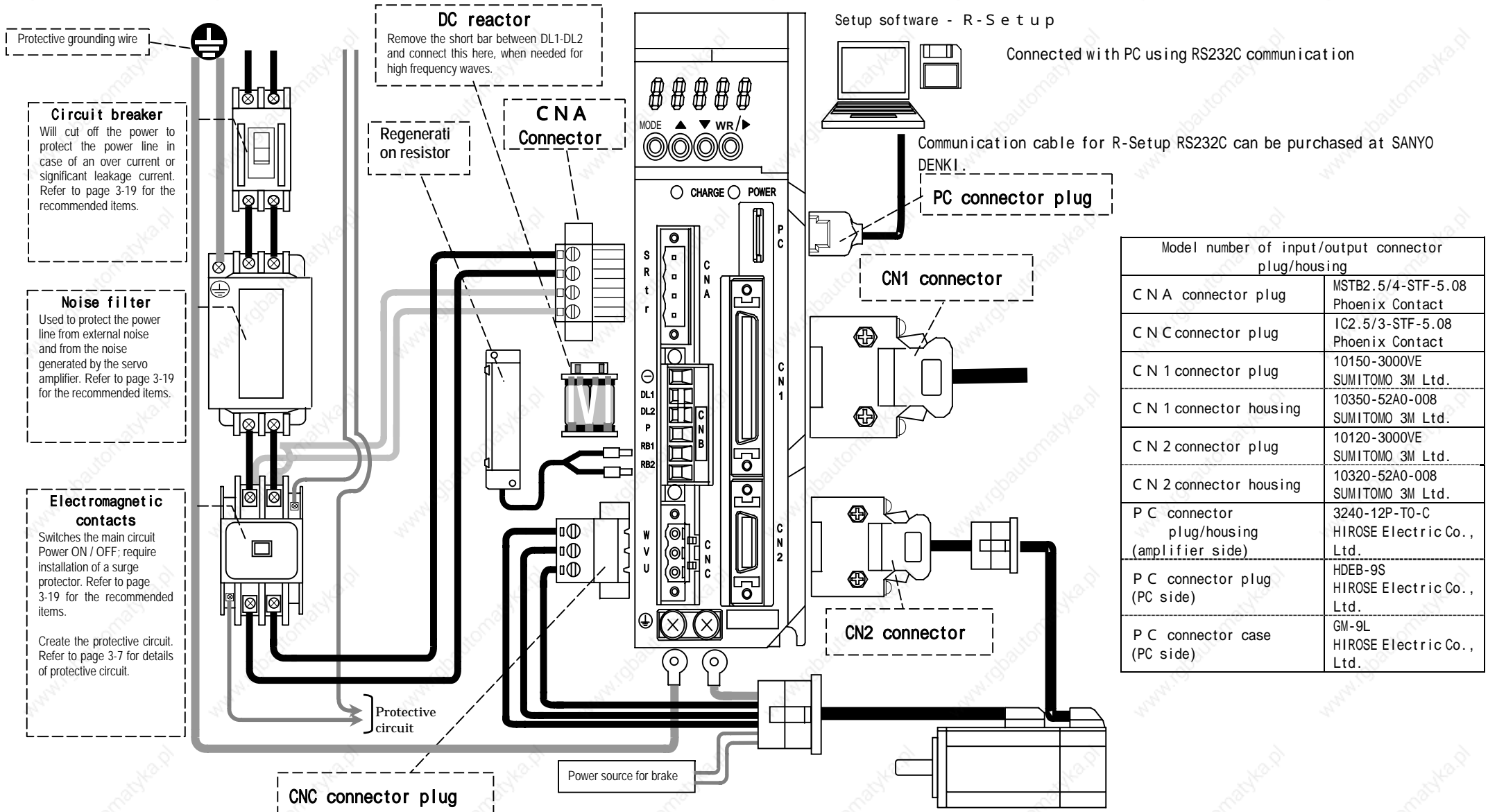

Model number of input/output connector plug/housing	
CNA connector plug	MSTB2.5/4-STF-5.08 Phoenix Contact
CNC connector plug	IC2.5/3-STF-5.08 Phoenix Contact
CN1 connector plug	10150-3000VE SUMITOMO 3M Ltd.
CN1 connector housing	10350-52A0-008 SUMITOMO 3M Ltd.
CN2 connector plug	10120-3000VE SUMITOMO 3M Ltd.
CN2 connector housing	10320-52A0-008 SUMITOMO 3M Ltd.
PC connector plug/housing (amplifier side)	3240-12P-T0-C HIROSE Electric Co., Ltd.
PC connector plug (PC side)	HDEB-9S HIROSE Electric Co., Ltd.
PC connector case (PC side)	GM-9L HIROSE Electric Co., Ltd.

3. Wiring

[Packaged Wiring Diagram RS1 10 / RS1 15]

Packaged wiring diagram AC 200 V input type RS1 10 A / RS1 15 A

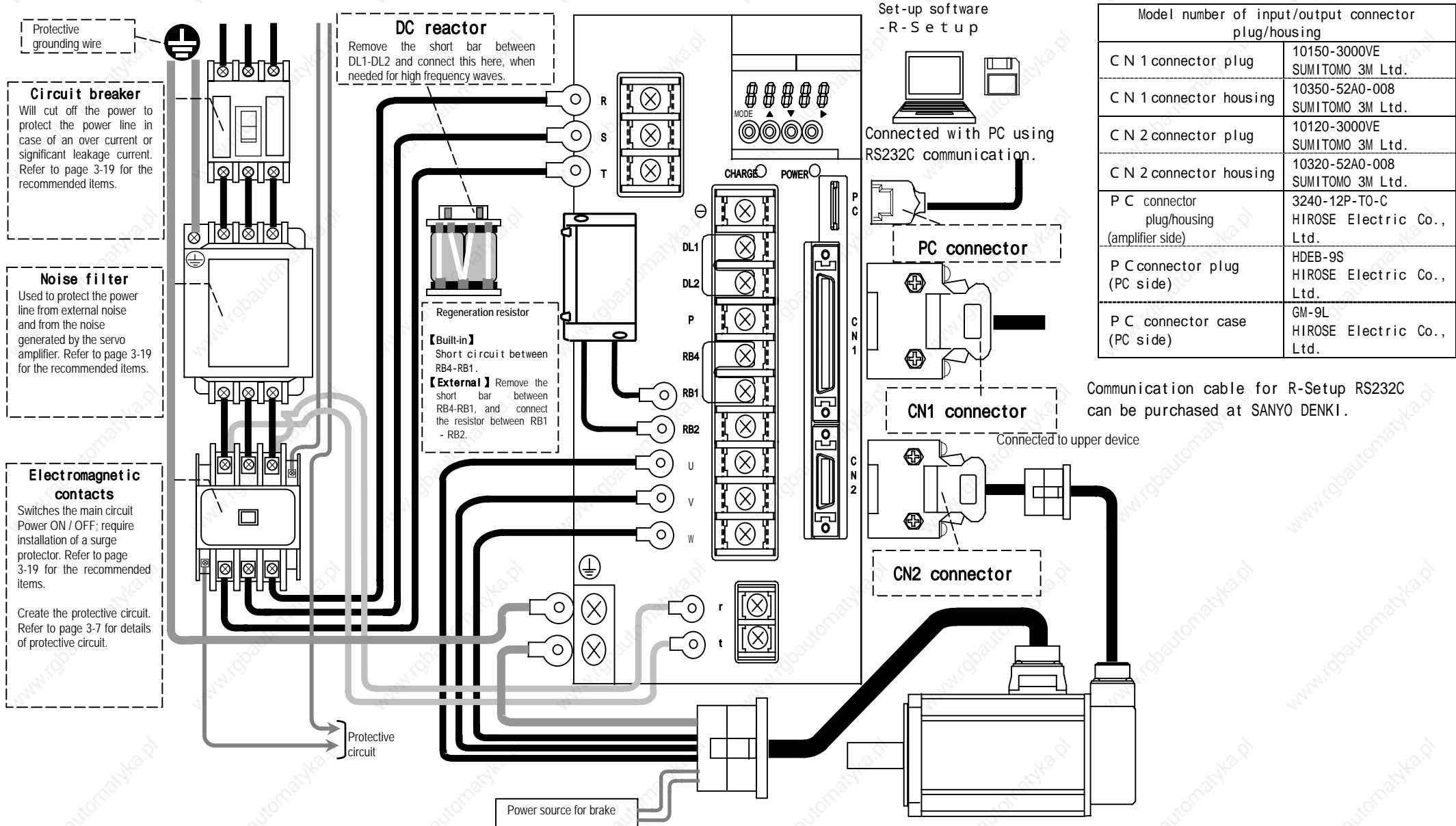

3. Wiring

[Packaged Wiring Diagram R S 1 3 0]

Packaged wiring diagram AC 200 V input type /RS 1 3 0 A

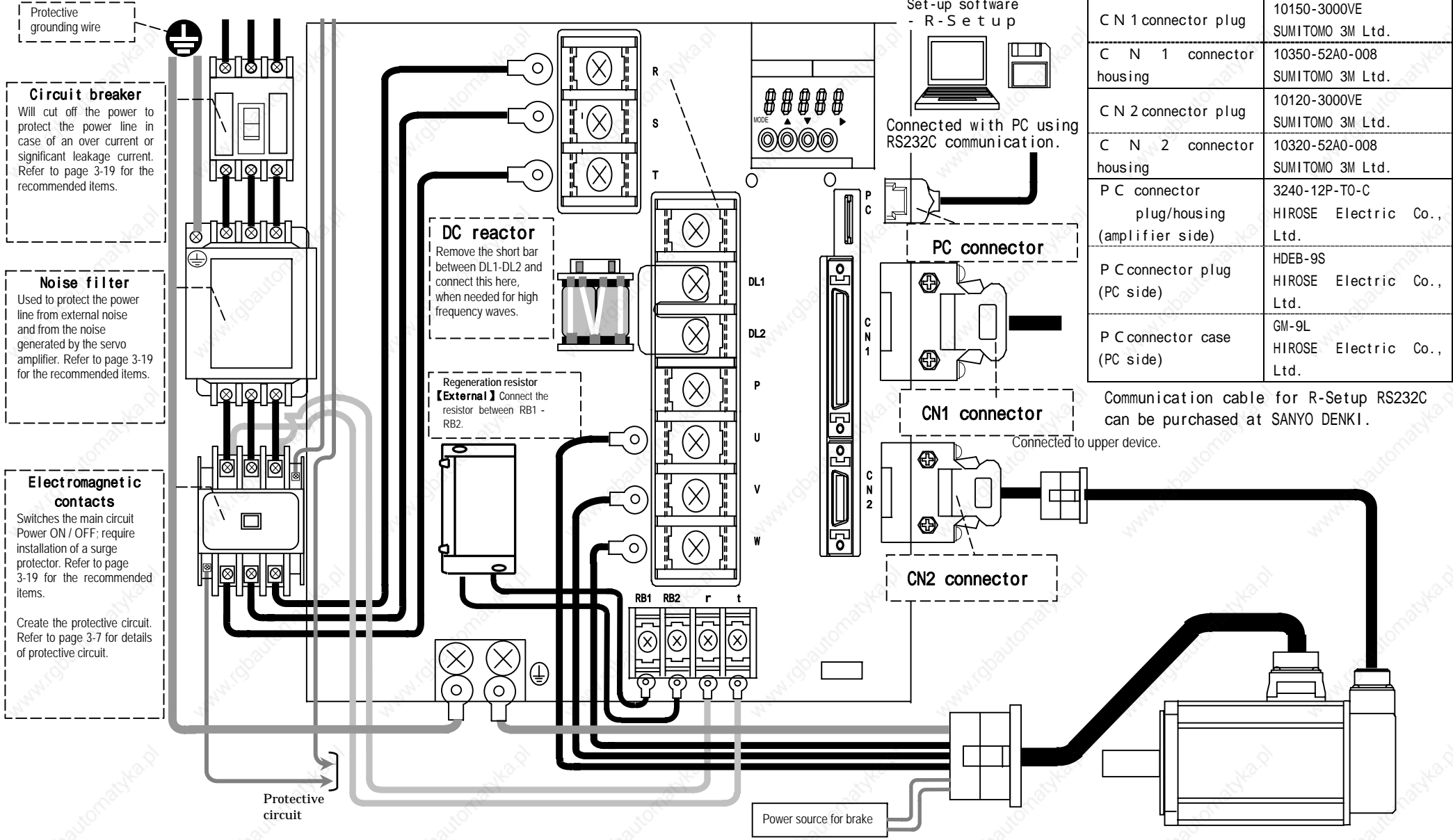



Model number of input/output connector plug/housing	
C N 1 connector plug	10150-3000VE SUMITOMO 3M Ltd.
C N 1 connector housing	10350-52A0-008 SUMITOMO 3M Ltd.
C N 2 connector plug	10120-3000VE SUMITOMO 3M Ltd.
C N 2 connector housing	10320-52A0-008 SUMITOMO 3M Ltd.
P C connector plug/housing (amplifier side)	3240-12P-T0-C HIROSE Electric Co., Ltd.
P C connector plug (PC side)	HDEB-9S HIROSE Electric Co., Ltd.
P C connector case (PC side)	GM-9L HIROSE Electric Co., Ltd.

Communication cable for R-Setup RS232C can be purchased at SANYO DENKI.

3. Wiring [High Voltage Circuit; Terminal Name and Function]

High voltage circuit; terminal name and functions

Terminal name	Connector marking	Remarks	
Main power source	R · T	Single phase AC100 ~ 115V +10%, -15% 50/60Hz ± 3%	
	or	Single phase AC200 ~ 230V +10%, -15% 50/60Hz ± 3%	
	R · S · T	Three phase AC200 ~ 230V +10%, -15% 50/60Hz ± 3%	
Control power source	r · t	Single phase AC100 ~ 115V +10%, -15% 50/60Hz ± 3%	
		Single phase AC200 ~ 230V +10%, -15% 50/60Hz ± 3%	
Servo motor connector	U · V · W	Connected with servo motor	
Safeguard connector		Connected with grounding wire of power source and of servo motor.	
Regeneration resistance connector	RB1 · RB2 RB4	RS1 01AA RS1 03AA RS1 05AA RS1 30AA	Regeneration resistance will be connected to RB1 · RB2. If it is built-in, regeneration resistance has been connected at the time of shipment. In case of short regeneration power, an external regeneration resistance is connected to RB1 · RB2. There is no terminal RB4.
		RS1 10AA RS1 15AA	In case of a built-in regeneration resistance, RB1 · RB4 are short circuited by a short bar at the time of shipment. If regeneration power is short, remove the short bar between RB1 · RB4 (open) and connect an external regeneration resistance at RB1 · RB2.
DC reactor connector	DL1 · DL2	Short circuited at the time of shipment. If high frequency waves need to be controlled, remove the short bar between DL1 · DL2 and connect a DC reactor between DL1 · DL2.	
Maker maintenance	P · 	For maker maintenance. Do not connect anything.	

How to insert high voltage circuit connector

Insert the wire into ferrule, and use a special tool to crimp it in.

Insert the ferrule deep into the connector, and tighten it with a special minus screw driver or something.

The recommended torque is 0.5 ~ 0.6 N·m.

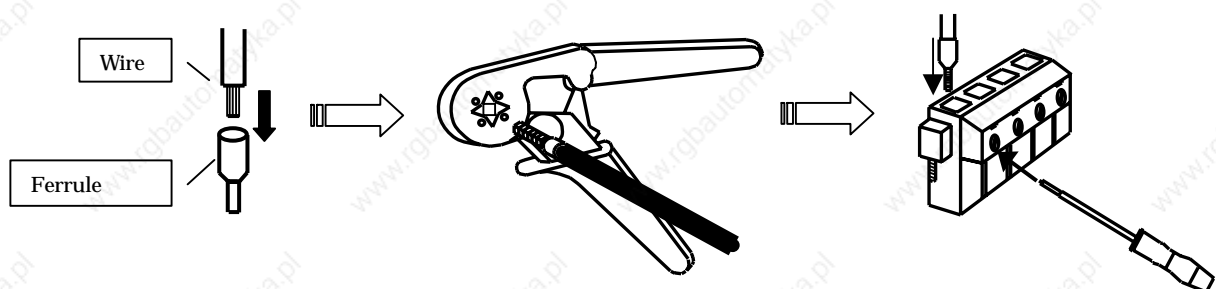

3. Wiring [High Voltage Circuit; Terminal Name and Function]

Model number of recommended ferrules and crimping tools for various wire sizes (Manufactured by Phoenix Contact.)

mm ²	AWG	Model number		
		1Pcs/Pkt	1000Pcs/Pkt	Taped components
0.75 mm ²	18	A10.75-8GY	A10.75-8GY-1000	A10.75-8GY-B (1000Pcs/Pkt)
1.0 mm ²	18	A11-8RD	A11-8RD-1000	A11-8RD-B (1000Pcs/Pkt)
1.5 mm ²	16	A11.5-8BK	A11.5-8BK-1000	A11.5-8BK-B (1000Pcs/Pkt)
2.5 mm ²	14	A12.5-8BU	A12.5-8BU-1000	A12.5-8BU-B (500Pcs/Pkt)

Note) GY : Gray, RD : Red, BK : Black, BU : Blue

Crimping tool model number : 0.25mm²~6mm² : CRIMPFOX UD 6-4, 0.75mm²~10mm² : CRIMPFOX UD 10-4

High voltage circuit terminal; tightening torque

Amplifier type	Terminal marking				⊕
	CNA	CNB	CNC		
RS1 01	[0.5~0.6 N·m]			[1.18 N·m] M4 (screw size)	
RS1 03					
RS1 05					

Amplifier type	Terminal marking																⊕
	R	S	T	⊖	DL1	DL2	P	RB4	RB1	RB2	U	V	W	r	t		
RS1 10	[1.18 N·m] M4 (screw size)																
RS1 15																	

Amplifier type	Terminal marking															⊕
	R	S	T	⊖	DL1	DL2	P	U	V	W	⊕	RB1	RB2	r	t	
RS1 30	[3.73 N·m] M6 (screw size)										[1.18 N·m] M4 (screw size)					

3. Wiring

[Wiring Example of High Voltage/Protective Circuit]

Three phase 200V RS1 01A · RS1 03A · RS1 05A · RS1 30A

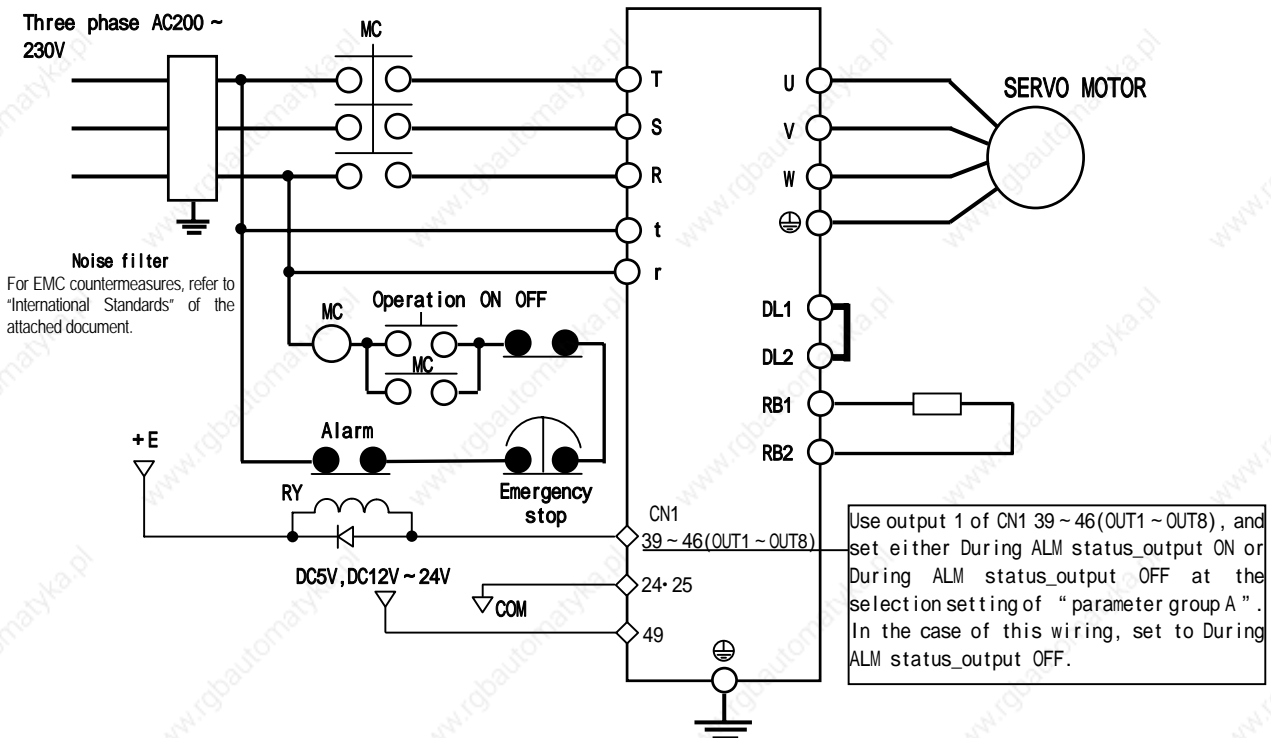

Single phase 200V RS1 01A · RS1 03A · RS1 05A

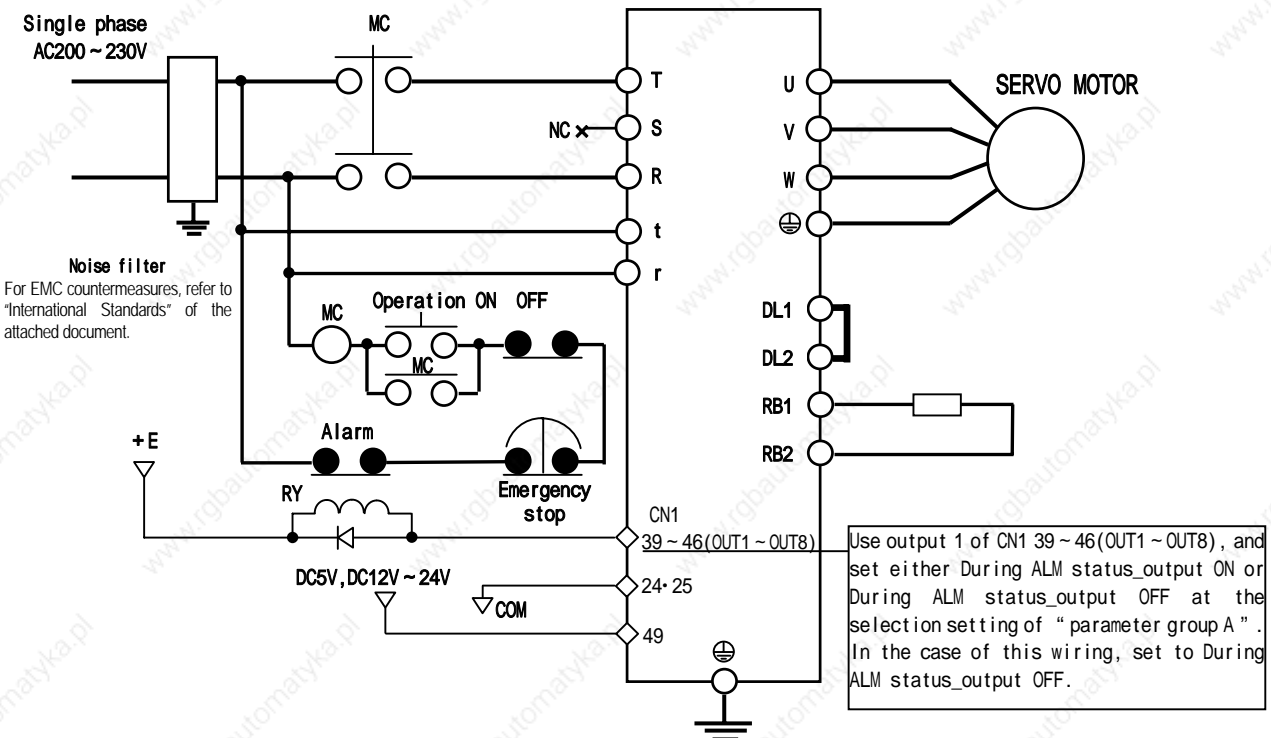

3. Wiring

[Wiring Example of High Voltage/Protective Circuit]

Three phase 200V RS1 10A · RS1 15A

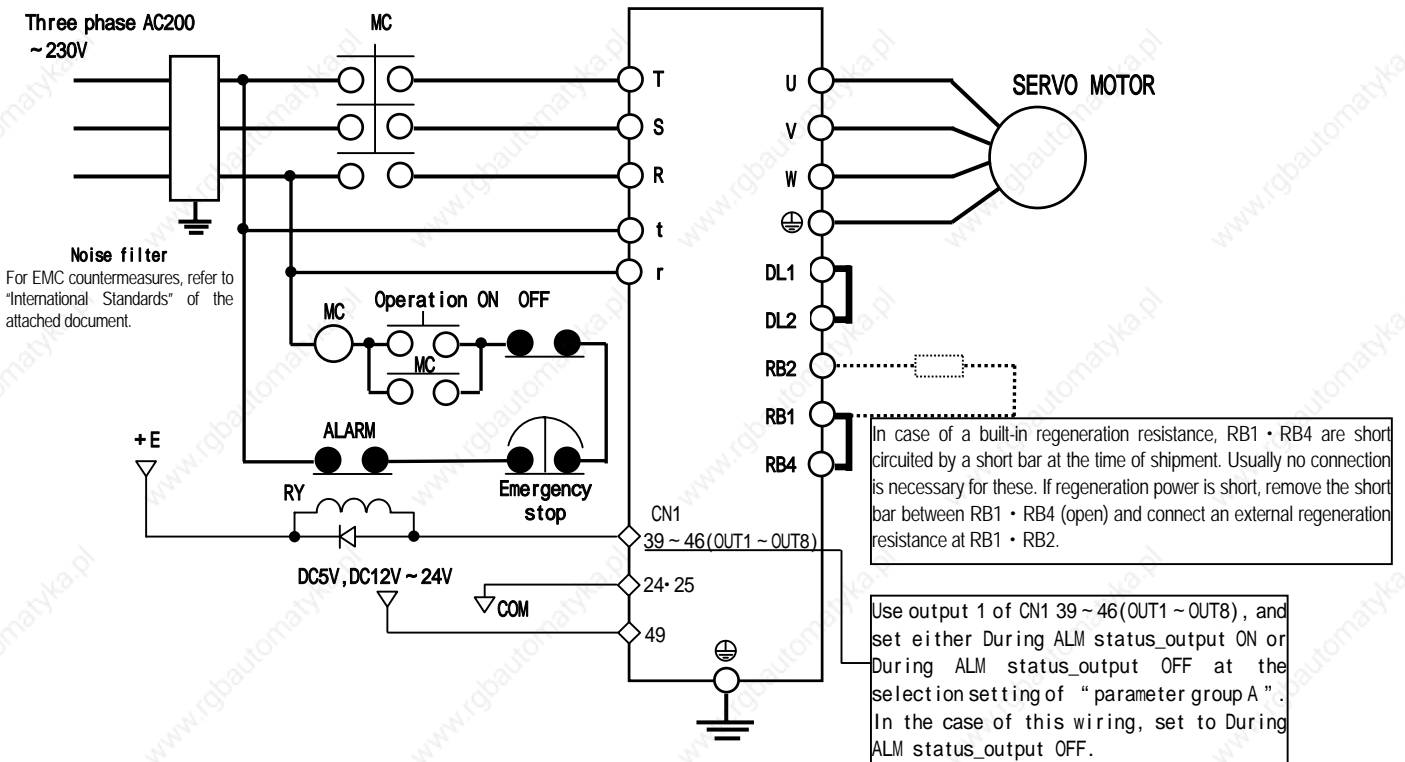

Single phase 100V RS1 01A · RS1 03A

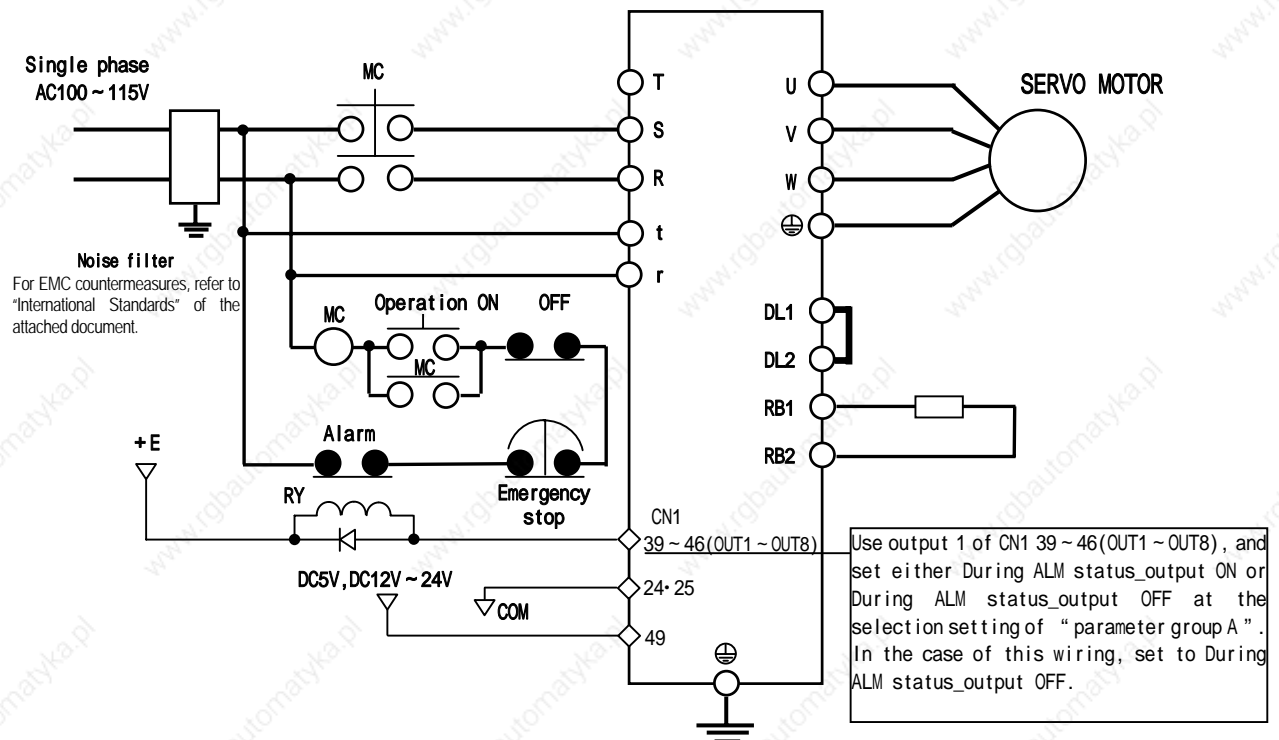

3. Wiring

[Low Voltage Circuit/Description of CN Terminal]

Low voltage circuit; terminal name and functions

Terminal name	Terminal symbol	Description
Upper device input/output signal connector	CN1	Connects the input/output circuit between upper device (upper controller) and the Servo amplifier.
Sensor/encoder connector	CN2	Connects the sensor/encoder circuit of the servo motor.

Connector terminal number

CN1 10150-3000VE (Soldered side)

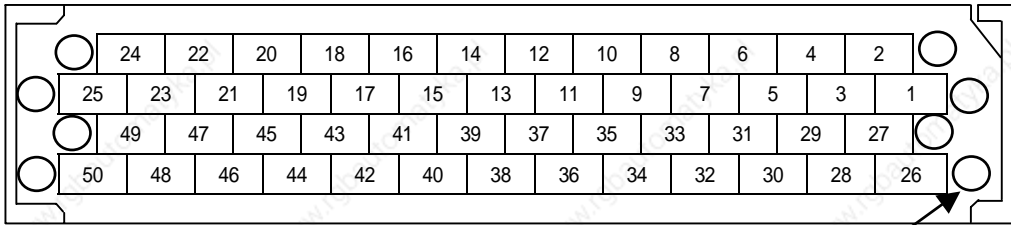

CN2 10120-3000VE (Soldered side)

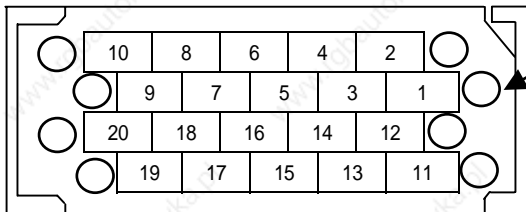

Pin number is written here.

3. Wiring

[Low Voltage Circuit/Description of CN1 terminal]

CN1 connector terminal layout

24	22	20	18	16	14	12	10	8	6	4	2	
OUT-COM	T-COMP	SG	F-TLA	CONT8	CONT7	SG	PS	Z0	B0	A0	BTN-1	
25	23	21	19	17	15	13	11	9	7	5	3	1
OUT-COM	SG	V/T-REF	R-TLA	SG	CONT8	CONT7	ZOP	PS	Z0	B0	A0	BTP-1
49	47	45	43	41	39	37	35	33	31	29	27	
OUT-PWR	SG	OUT7	OUT5	OUT3	OUT1	CONT1	CONT3	CONT5	SG	R-PC	F-PC	
50	48	46	44	42	40	38	36	34	32	30	28	26
IN-COM	SG	OUT8	OUT6	OUT4	OUT2	SG	CONT2	CONT4	CONT6	MON1	R-PC	F-PC

CN1 terminal name

Terminal number	Signal name	
1	BTP-1	Battery minus
2	BTN-1	Battery plus
3	A0	A phase position signal output
4	A0	/A phase position signal output
5	B0	B phase position signal output
6	B0	/B phase position signal output
7	Z0	Z phase position signal output
8	Z0	/Z phase position signal output
9	PS	Position data output
10	PS	Position data output
11	ZOP	Z phase Position data output
12	SG	Common for pins 3~11
17	SG	Common for pins 18~19
18	F-TLA	Analog current limit input
19	R-TLA	Analog current limit input
20	SG	Common for pin 21
21	V-REF	Speed command input
	T-REF	Torque command input
22	T-COMP	Torque compensation input
23	SG	2Common for pin 22
26	F-PC	Command pulse input
27	F-PC	Command pulse input
28	R-PC	Command pulse input
29	R-PC	Command pulse input
47	SG	Common for pins 26~27
48	SG	Common for pins 28~29

Terminal number	Signal name	
30	MON1	Analog monitor output
31	SG	Common for pin 30
13	CONT7	Generic input
14	CONT7	Generic input
15	CONT8	Generic input
16	CONT8	Generic input
38	SG	Common for pins 13~16
32	CONT6	Generic input
33	CONT5	Generic input
34	CONT4	Generic input
35	CONT3	Generic input
36	CONT2	Generic input
37	CONT1	Generic input
50	CONT-COM	Generic input power source
39	OUT1	Generic output
40	OUT2	Generic output
41	OUT3	Generic output
42	OUT4	Generic output
43	OUT5	Generic output
44	OUT6	Generic output
45	OUT7	Generic output
46	OUT8	Generic output
49	OUT-PWR	Generic output power source
24	OUT-COM	Generic output Common
25	OUT-COM	Generic output Common

3. Wiring

[Low Voltage Circuit/CN1 Overall Wiring]

CN1 Connector terminal layout

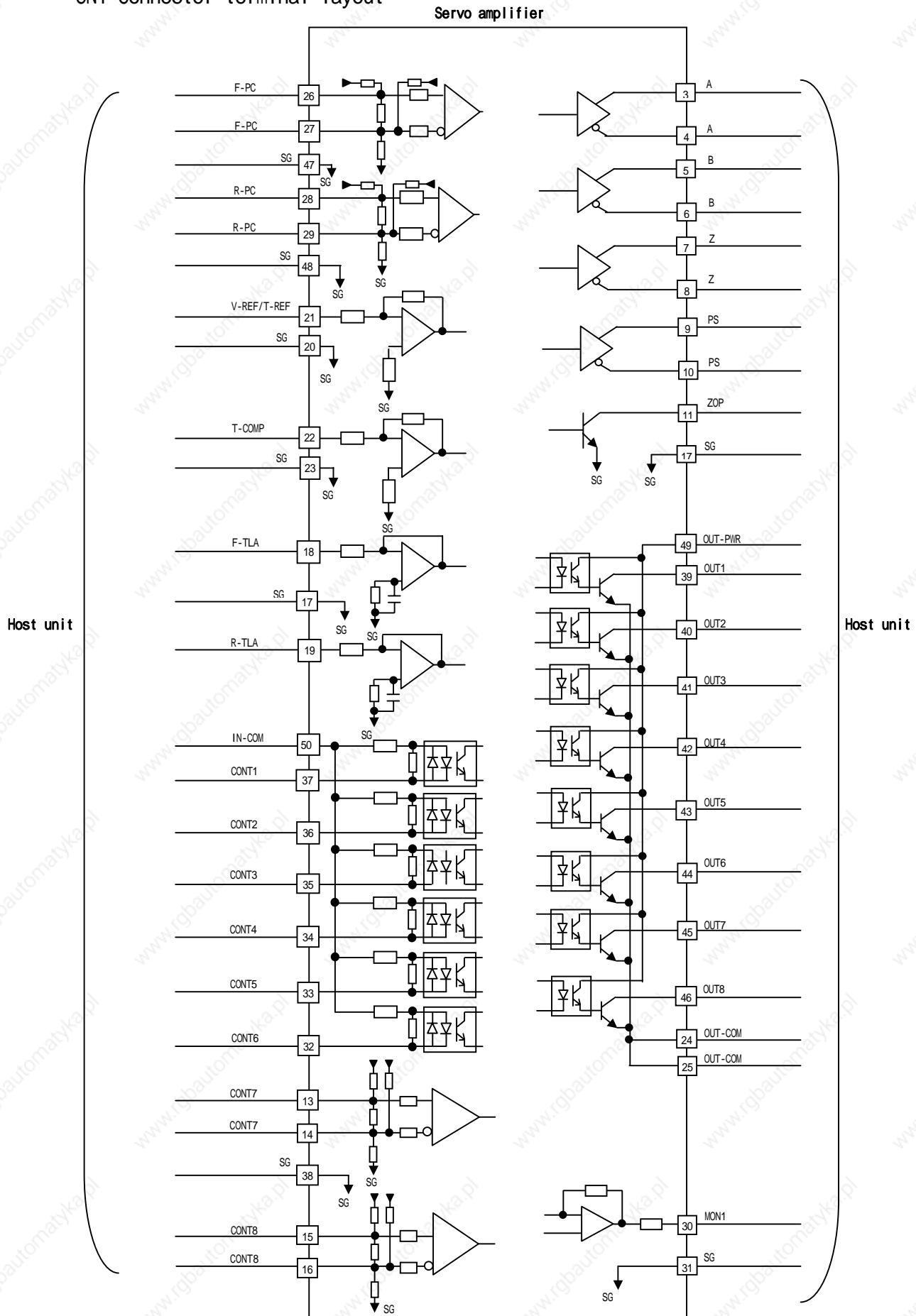

3. Wiring [Low Voltage Circuit/Wiring Example of CN1 Input Circuit]

Connection example with analog input circuit

Analog input circuit

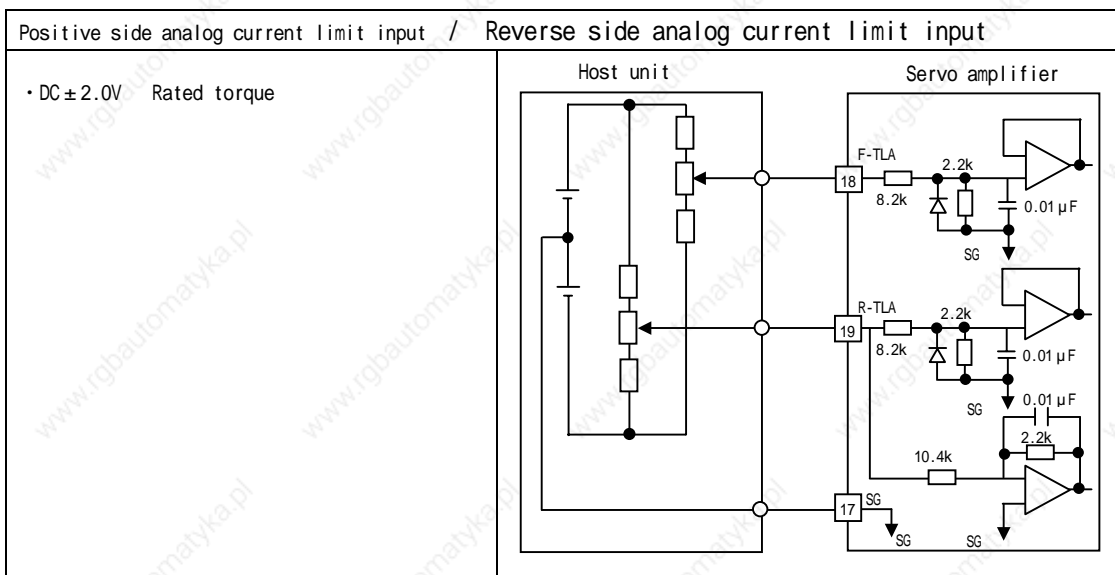
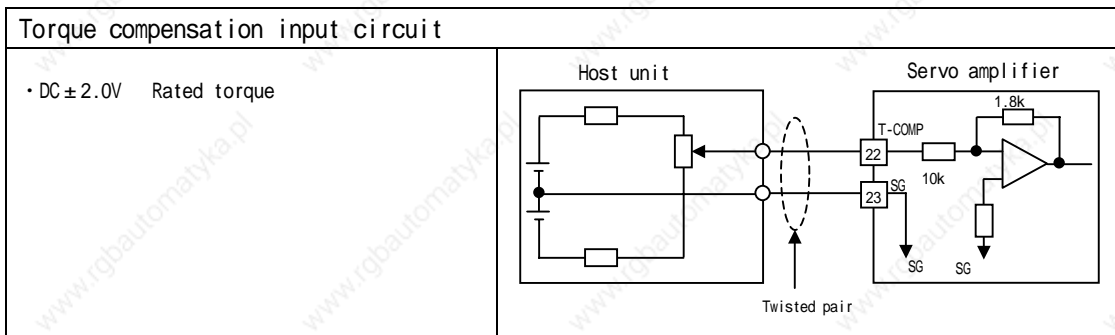
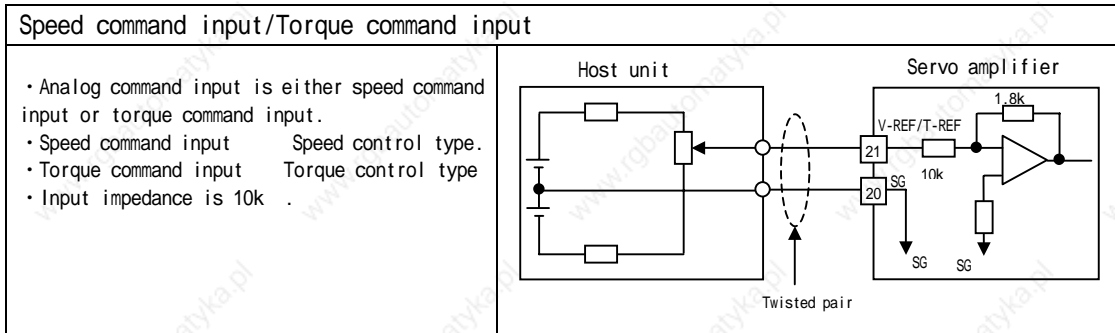

3. Wiring [Low Voltage Circuit/Wiring Example of CN1 Input Circuit]

Position command input circuit

[Input circuit : Line receiver]

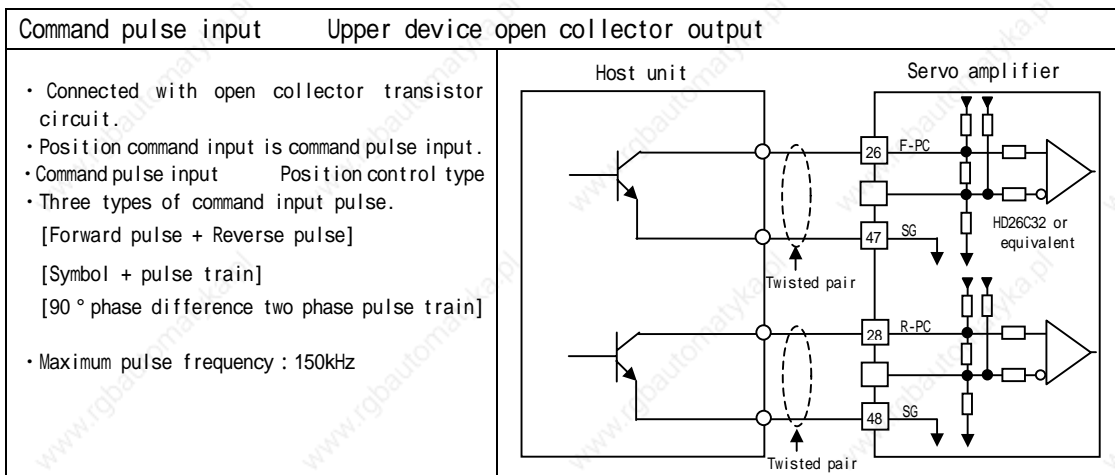
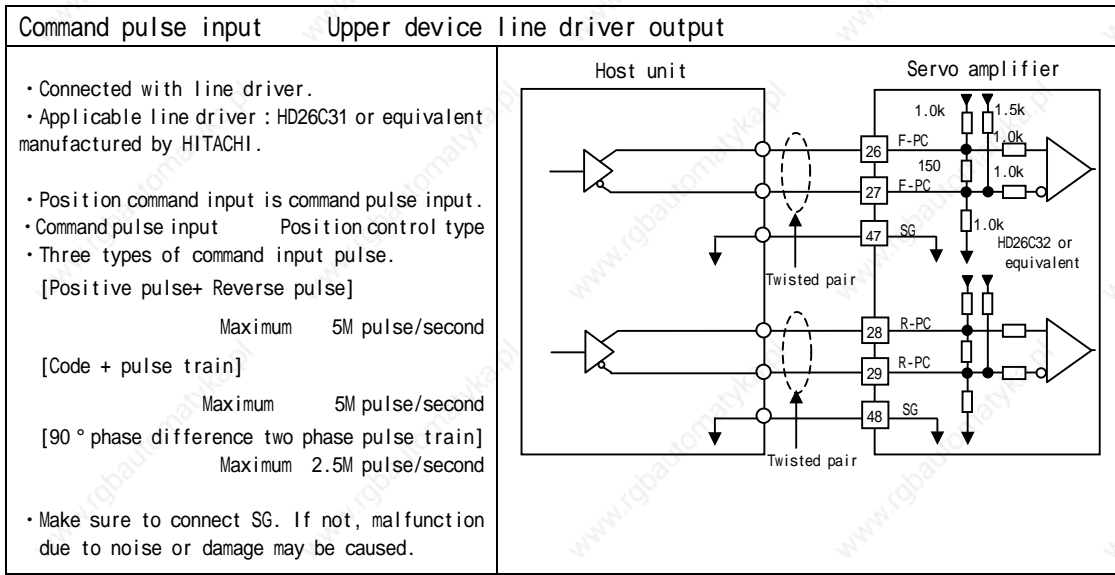

Battery input circuit

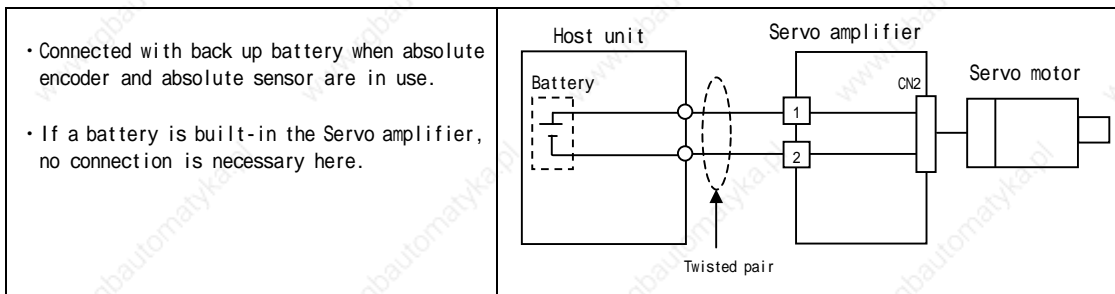

3. Wiring [Low Voltage Circuit/Wiring Example of CN1 Input Circuit]

Connection example with generic input circuit

Generic input circuit CONT1~CONT6

[Input circuit : Bi-directional photo coupler]

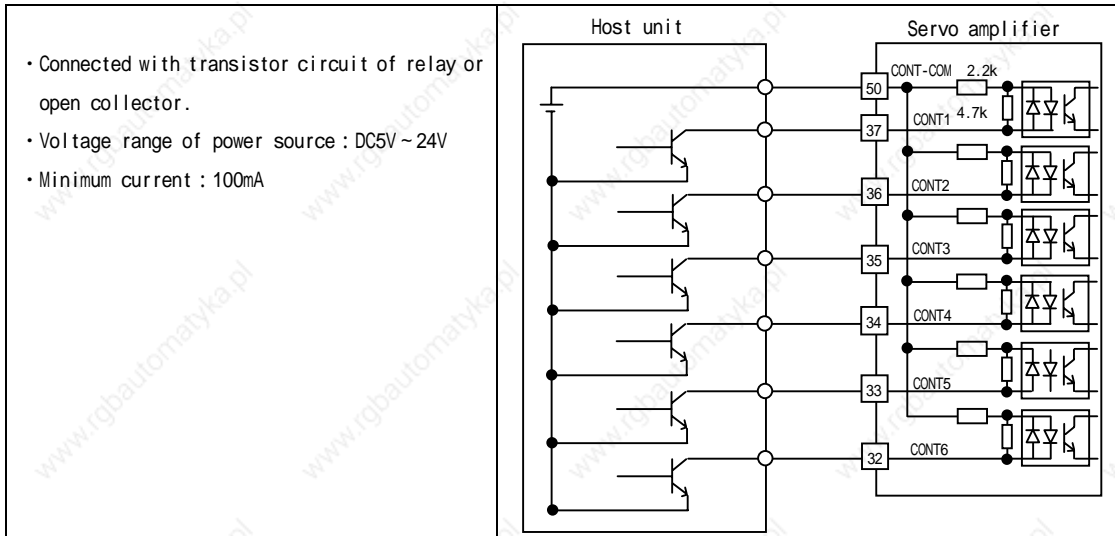

Generic input circuit CONT7・CONT8

[Input circuit : Line receiver]

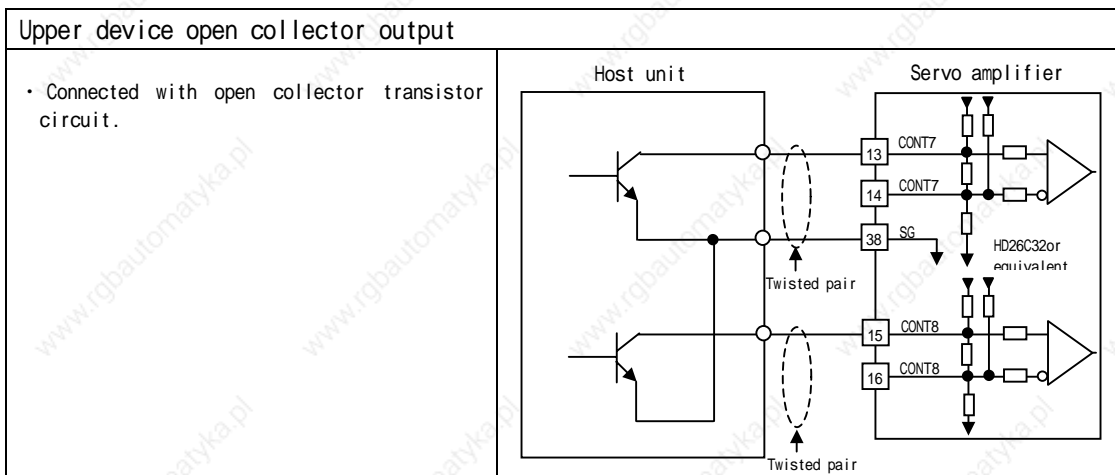
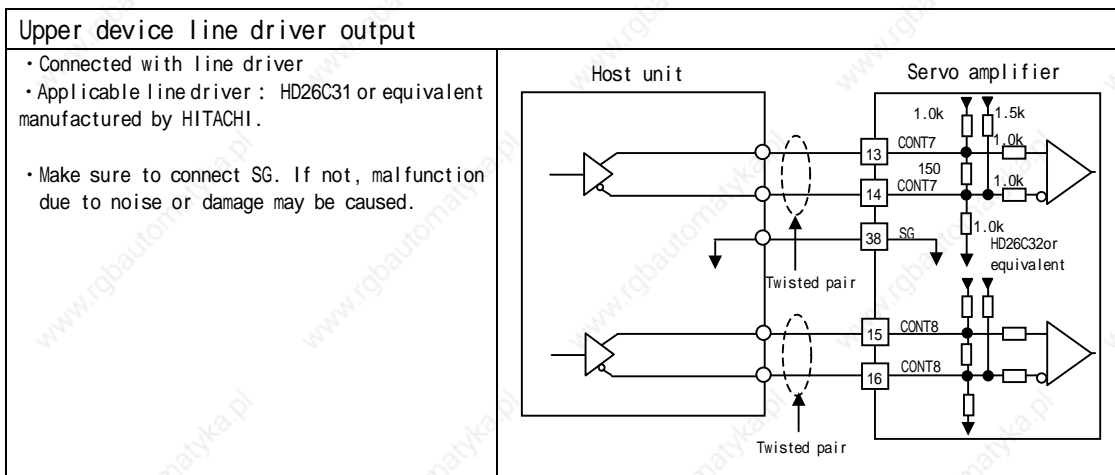

3. Wiring [Low Voltage Circuit/Wiring Example of CN1 output Circuit]

Connection example with position signal output circuit

Incremental pulse signal output circuit

[output circuit : line driver]

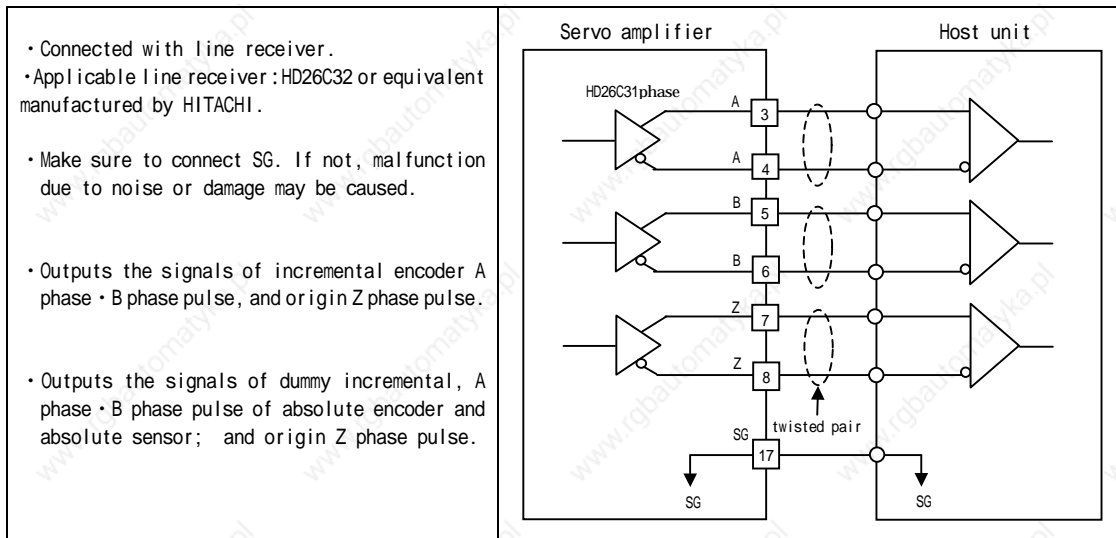

Absolute position data output circuit

[output circuit : line driver]

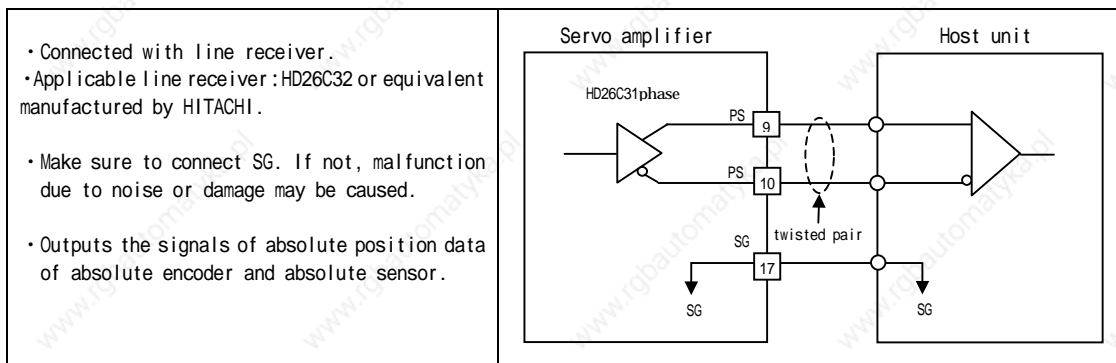

Origin Z phase output circuit

[output circuit : open collector]

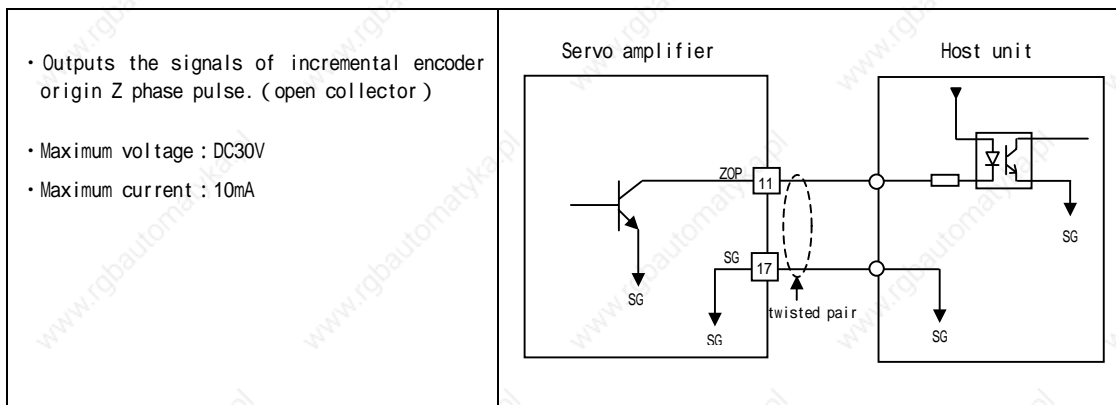

3. Wiring [Low Voltage Circuit/Wiring Example of CN1 output Circuit]

Connection example with generic output circuit

Generic output circuit OUT1~OUT8

[output circuit : open collector]

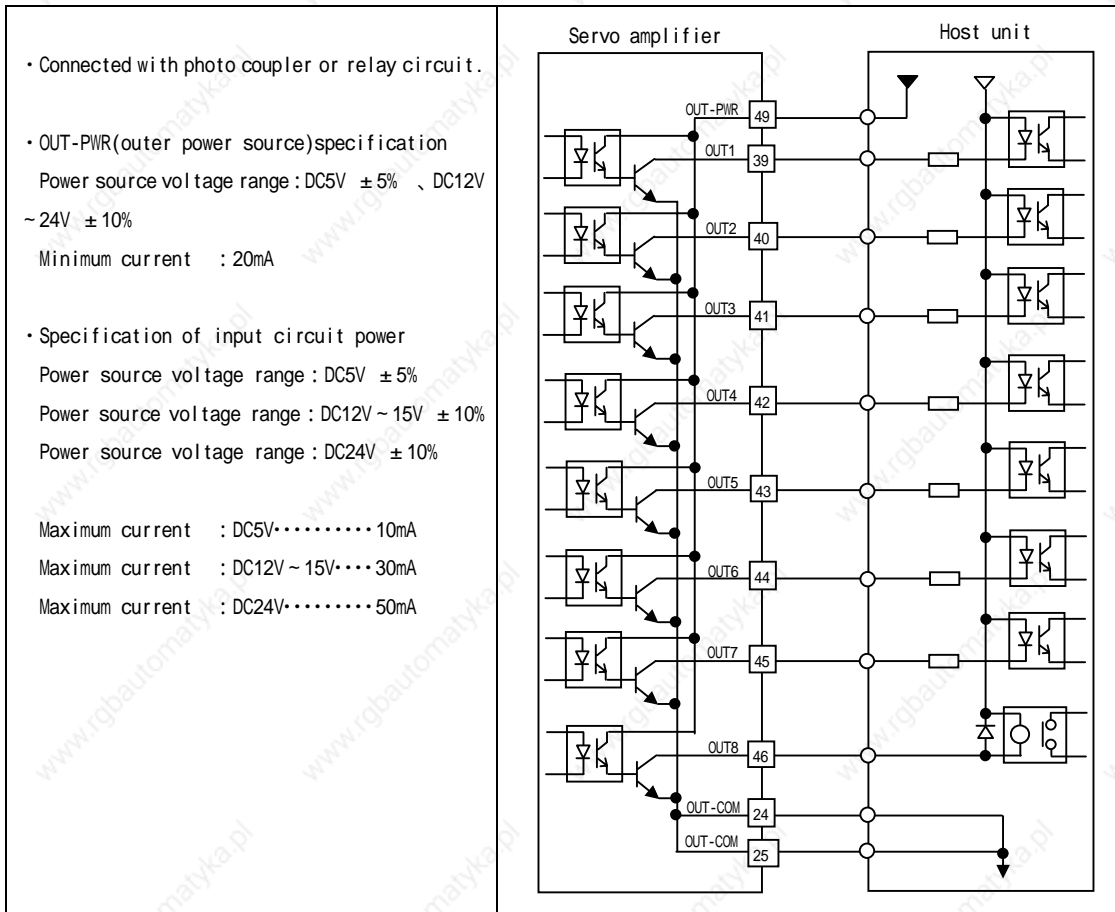

Connection example with analog output circuit

Analog monitor output circuit

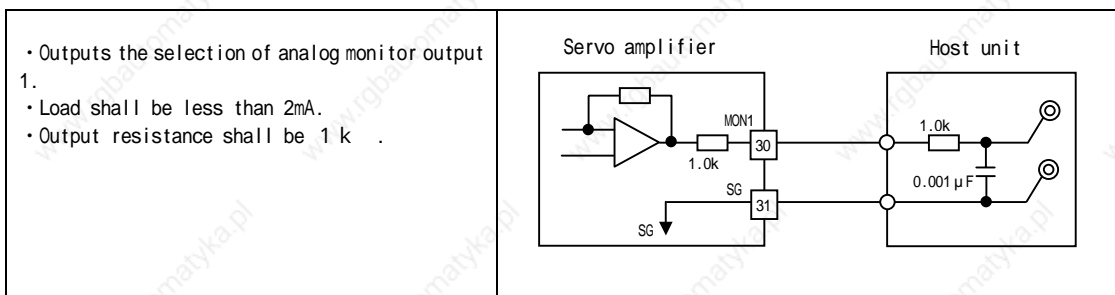

3. Wiring

[Low Voltage circuit/CN2 Wiring]

CN2 terminal layout

10	8	6	4	2
	9	7	5	3
20	18	16	14	12
	19	17	15	13

Servo motor encoder at semi-closed control

Incremental encoder		
Terminal No.	Signal name	Description
1	-	-
2	-	-
3	A0	A phase position signal output
4	A0	
5	B0	B phase position signal output
6	B0	
7	Z0	Z phase position signal output
8	Z0	
9	5V	5V power source
10	SG	5V power source common
11	SG	5V power source common
12	5V	5V power source
13	-	-
14	-	-
15	-	-
16	SG	5V power source common
17	5V	5V power source
18	SG	5V power source common
19	5V	5V power source
20	SG	5V power source common

Wire-saving absolute sensor (Optical)		
Terminal No.	Signal name	Description
1	BAT+	Battery
2	BAT-	
3	-	-
4	-	-
5	-	-
6	-	-
7	-	-
8	-	-
9	5V	5V power source
10	SG	5V power source common
11	SG	5V power source common
12	5V	5V power source
13	ES	Position data output
14	ES	
15	-	-
16	SG	5V power source common
17	5V	5V power source
18	SG	5V power source common
19	5V	5V power source
20	SG	5V power source common

Wire-saving absolute sensor (Resolver)		
Terminal No.	Signal name	Description
1	-	-
2	-	-
3	-	-
4	-	-
5	-	-
6	-	-
7	-	-
8	-	-
9	5V	5V power source
10	SG	5V power source common
11	SG	5V power source common
12	5V	5V power source
13	ES	Position data output
14	ES	
15	-	-
16	SG	5V power source common
17	5V	5V power source
18	SG	5V power source common
19	5V	5V power source
20	SG	5V power source common

Absolute encoder with Incremental signal		
Terminal No.	Signal name	Description
1	BAT+	Battery
2	BAT-	
3	A0	A phase position signal output
4	A0	
5	B0	B phase position signal output
6	B0	
7	Z0	Z phase position signal output
8	Z0	
9	5V	5V power source
10	SG	5V power source common
11	SG	5V power source common
12	5V	5V power source
13	PS	Position data output
14	PS	
15	ECLR	Clear signal
16	SG	5V power source common
17	5V	5V power source
18	SG	5V power source common
19	5V	5V power source
20	SG	5V power source common

Absolute sensor with request signal (optical)		
Terminal No.	Signal name	Description
1	BAT+	Battery
2	BAT-	
3	REQ+	Request signal
4	REQ-	
5	-	-
6	-	-
7	-	-
8	-	-
9	5V	5V power source
10	SG	5V power source common
11	SG	5V power source common
12	5V	5V power source
13	PS	Position data output
14	PS	
15	ECLR	Clear signal
16	SG	5V power source common
17	5V	5V power source
18	SG	5V power source common
19	5V	5V power source
20	SG	5V power source common

Absolute sensor with request signal (Resolver)		
Terminal No.	Signal name	Description
1	-	-
2	-	-
3	REQ+	Request signal
4	REQ-	
5	-	-
6	-	-
7	-	-
8	-	-
9	5V	5V power source
10	SG	5V power source common
11	SG	5V power source common
12	5V	5V power source
13	PS	Position data output
14	PS	
15	ECLR	Clear signal
16	SG	5V power source common
17	5V	5V power source
18	SG	5V power source common
19	5V	5V power source
20	SG	5V power source common

3. Wiring

[Low Voltage circuit/CN2 Wiring]

Wiring between servo motor encoder and external sensor at full-closed control

Wire-saving absolute sensor (Optical)		
Terminal No.	Signal name	Description
1	BAT+	Battery
2	BAT-	
9	5V	5V power source
10	SG	5V power source common
11	SG	5V power source common
12	5V	5V power source
13	ES	Position data output
14	ES	
15	-	-
16	SG	5V power source common
17	5V	5V power source
18	SG	5V power source common
19	5V	5V power source
20	SG	5V power source common
Terminal No.	Signal name	External sensor signal
3	A	A phase position signal output
4	A	
5	B	B phase position signal output
6	B	
7	Z	Z phase position signal output
8	Z	

Wire-saving absolute sensor (Resolver)		
Terminal No.	Signal name	Description
1	-	-
2	-	-
9	5V	5V power source
10	SG	5V power source common
11	SG	5V power source common
12	5V	5V power source
13	ES	Position data output
14	ES	
15	-	-
16	SG	5V power source common
17	5V	5V power source
18	SG	5V power source common
19	5V	5V power source
20	SG	5V power source common
Terminal No.	Signal name	External sensor signal
3	A	A phase position signal output
4	A	
5	B	B phase position signal output
6	B	
7	Z	Z phase position signal output
8	Z	

Users must prepare the power supply for external sensor signals.

Incremental encoder		
Terminal No.	Signal name	Description
1	-	-
2	-	-
3	A0	A phase position signal output
4	A0	
5	B0	B phase position signal output
6	B0	
7	Z0	Z phase position signal output
8	Z0	
11	SG	5V power source common
12	5V	5V power source
17	5V	5V power source
18	SG	5V power source common
19	5V	5V power source
20	SG	5V power source common
Terminal No.	Signal name	External sensor signal
9	A	A phase position signal output
10	A	
13	B	B phase position signal output
14	B	
15	Z	Z phase position signal output
16	Z	

Users must prepare the power supply for external sensor signals.

3. Wiring [Power Supply • Peripherals • Wire Diameter]

Power Capacity • Peripherals • Wire Diameter Examples

Input voltage	Servo amplifier capacity RS1* A	Servo motor model number	Rated Output (W)	Main circuit power supply (KVA)	Power supply control (VA)	Circuit breaker	Noise filter (EMC Corresponding time)	electromagnetism contactor	Main power wire diameter R-S-T	Control power wire diameter t	Servo motor power line diameter U-V-W	Protective grounding wire diameter 	Regeneration resistance wire diameter RB
AC 200V	01	Q1AA04003D	30	0.2	40	NF30 shape 10A Manufactured by Mitsubishi Ltd.	RF3010-DLC Manufactured by RASMI	S-N10 Manufactured by Mitsubishi Ltd.	AWG16 or equivalent	AWG16 or equivalent	AWG16 or equivalent	AW16 or equivalent	
		Q1AA04005D	50	0.2									
		Q1AA04010D	100	0.3									
		Q1AA06020D	200	0.5									
		Q2AA04006D	60	0.3									
		Q2AA04010D	100	0.4									
		Q2AA05005D	50	0.3									
		Q2AA05010D	100	0.4									
		Q2AA05020D	200	0.8									
	Q2AA07020D	200	0.8										
	Q2AA07030D	300	1.0										
	03	Q1AA06040D	400	1.0		NF30 shape 10A Manufactured by Mitsubishi Ltd.							
		Q1AA07075d	750	1.7									
		Q2AA07040D	400	1.3									
		Q2AA07050D	500	1.5									
		Q2AA08050D	500	1.5									
	05	Q2AA13050H	500	1.4									
		Q1AA10100D	1000	2.5		NF30 shape 15A Manufactured by Mitsubishi Ltd.							
		Q1AA10150D	1500	3.0									
		Q1AA12100D	1000	2.5									
		Q2AA08075D	750	2.0									
		Q2AA08100D	1000	2.5									
	Q2AA10100H	1000	2.5										
	10	Q2AA10150H	1500	3.0									
		Q2AA13100D	1000	2.5									
		Q2AA13150D	1500	3.0									
		Q1AA10200D	2000	4.0		NF50 shape 30A Manufactured by Mitsubishi Ltd.							
		Q1AA10250D	2500	4.2									
		Q1AA12200D	2000	4.0									
		Q1AA12300D	3000	5.0									
	Q1AA13300D	3000	5.0										
	Q2AA13200H	2000	5.0										
	Q2AA18200H	2000	5.0										
	15	Q2AA22250H	2500	5.9									
		Q1AA13400D	4000	6.7		NF50 shape 50A Manufactured by Mitsubishi Ltd.							
		Q1AA13500D	5000	8.3									
		Q1AA18450M	4500	7.4									
		Q2AA18350H	3500	6.9									
		Q2AA18450H	4500	7.4									
		Q2AA18550H	5500	8.4									
Q2AA22350H		3500	7.4										
Q2AA22450R		4500	8.4										
Q2AA22550B		5500	10.1										
Q2AA22700S	7000	12.2	NF100 shape 75A Manufactured by Mitsubishi Ltd.										
30	Q1AA18750H	7500	12.6	NF100 shape 100A Manufactured by Mitsubishi Ltd.									
	Q2AA18550H	5500	10.1										
	Q2AA18750L	7500	12.6										
	Q2AA2211KV	11000	15.7										
	Q2AA2215KV	15000	21.4										
AC 100V	01	Q1EA04003D	30	0.2	NF30 shape 10A Manufactured by Mitsubishi Ltd.	RF3010-DLC Manufactured by RASMI	S-N10 Manufactured by Mitsubishi Ltd.	AWG16 or equivalent	AWG16 or equivalent	AWG16 or equivalent	AW16 or equivalent		
		Q1EA04005D	50	0.3									
		Q1EA04010D	100	0.5									
		Q2EA04006D	60	0.3									
		Q2EA04010D	100	0.5									
		Q2EA05005D	50	0.3									
	Q2EA05010D	100	0.5										
03	Q1EA06020D	200	0.5		AWG14 or equivalent	AWG14 or equivalent	AW16 or equivalent						

AWG 24 or equivalent for CN1 • CN2.

Recommended surge protector : R•A•V-781BXZ-2A Okaya Electric Industries Co., Ltd.

3. Wiring [Power Supply • Peripherals • Wire Diameter]

The information in this table is based on rated current flowing at three bundled lead wires in ambient temperature of 40 °C.

When wires are bundled or put into a wire-duct, take the allowable current reduction ratio into account.

If ambient temperature is high, service life of the wires becomes shorter due to heat-related deterioration. In this case, use heat-resistant vinyl wires.

Depending on the servo motor capacity, thinner electric wires than indicated in the table can be used for the main circuit power input connector and the motor connector. (Choose appropriate size of wires in accordance with the power capacity.)

Connector

	name	SANYO DENKI Model No.	Model No. of applicable amplifier	Name	Manufacturer's model No.	Manufacturer
	CN1	AL-00385594	All	Plug	10150-3000VE	Sumitomo 3M Ltd.
				Shell kit	10350-52A0-008	
	CN2	AL-00385596	All	Plug	10120-3000VE	
				Shell kit	10320-52A0-008	
	CNA	AL-00329461-01	RS1 01 ~ RS1 05 (200V input only)	Plug	MSTB2.5/5-STF-5.08	Phoenix Contact Ltd.
	CNA	AL-00329461-02	RS1 01 ~ RS1 03 (100V input only)	Plug	MSTB2.5/4-STF-5.08	
	CNB	AL-Y0000988-01	RS1 01 ~ RS1 05 (for both 100V·200V)	Plug	IC2.5/6-STF-5.08	
	CNC	AL-00329458-01	RS1 01 ~ RS1 05 (for both 100V·200V)	Plug	IC2.5/3-STF-5.08	
	PC	AL-00490833-01	All	Communication cable for Set-up software— [®] R-Setup _α		

Combination	SANYO DENKI Model No.	Model No. of applicable amplifier
Set of +	AL-00292309	All
Set of +	AL-00416792	RS1 01 ~ RS1 05 (200V input only)
Set of + + +	AL-00393603	RS1 01 ~ RS1 05 (200V input only)
Set of + + +	AL-00393603	RS1 01 ~ RS1 03 (100V input only)

The recommended tightening torque of CNA~C is 0.5~0.6N·m.

If it is necessary to have an insulation distance between the main circuit wires and between the main circuit and the signal circuit wires, pole terminals with insulation sleeves should be used. (If the wire in use is thicker than AWG12, these cannot be used.)

The recommended tightening torque for the jack-screws of the CN1, CN2 shell kit is 0.196 ± 0.049N·m.

[Digital operator]

◆	Names and Functions	4-1
◆	Various Modes	4-2
◆	Changing Modes	4-3
◆	Monitor Mode Operations and Display	4-4
◆	Basic Mode Operations and Display	4-7
◆	General Parameter Mode Operations and Display ..	4-9
◆	Auto-adjustment Mode Operations and Display ...	4-11
◆	Test Run Mode Operations and Display	4-12
◆	System Parameter Mode Operations and Display ·	4-14
◆	Alarm Trace/CPU_VER Operations and Display ..	4-15
◆	Password Setting	4-16

4. Digital Operator

[Various Modes]

■ Digital Operator

- It is possible to change or set the parameters and to confirm the status display, monitor display, test operation and alarm history with the built-in digital operator.

■ Digital operator name and functions

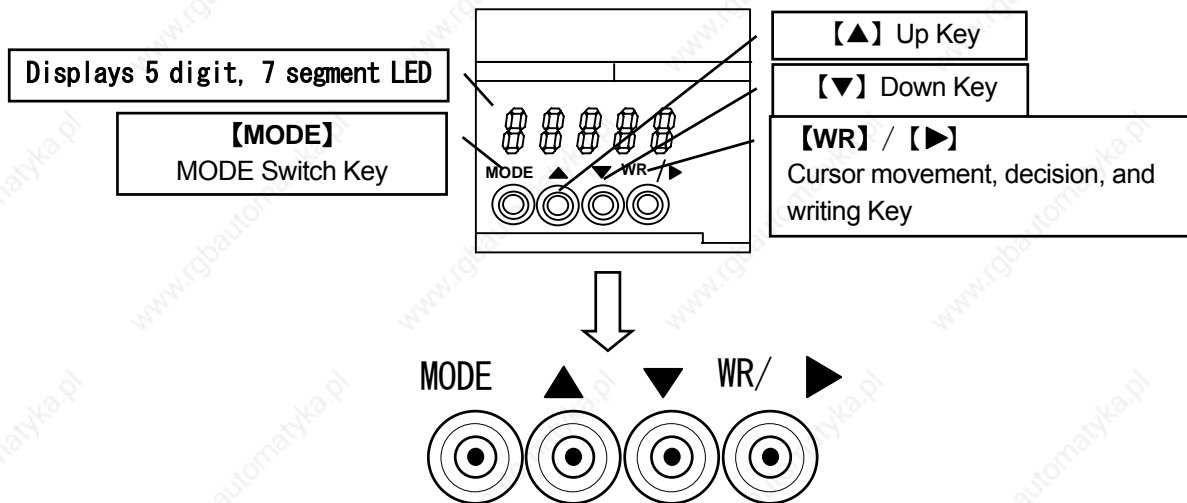

Display	Function	Input time
Digital display	Displays monitor value or parameter setting value in five digits.	—
WR	To input selections and write edited data.	More than 1second
MODE	Changes the Mode.	Less than 1 second
▶	Cursor Key. Changes the cursor position when editing.	Less than 1 second
▲ ▼	Up/Down key. Changes the numeric value.	Less than 1 second

■ Displays by Cursor key and Up/Down key

- Up and Down from “1 to 9”
Press the Up key, and the blinking numeric value of LED display will increase. Press the Down key, and the numeric value decreases.
- Up from “9”
Press the Up key, and the numeric value at cursor position increases and shifts to the left digit.
- Down from “0”
Press the Down key, and the numeric value at cursor position decreases and the numeric values in the left of cursor position shift to the right.
If there is no numeric value in the left of cursor position, all the left digits from cursor position show 9 with a right shift.
- Up/Down of “Symbol”
When the display is “0”, “+ data” will be displayed by pressing the Up key and “- data” by the Down key, regardless of the cursor position. When the display is other than “0”, there will be a left shift or right shift as usual.
(Display of “0” = “ 0 0 0 0 ” , “ 0 0 0 ” , “ 0 0 ”)

The [+data] has no light on the furthest left digit, and the [-data] has a symbol of [-] on the furthest left digit.

4. Digital Operator

[Various Modes]

■ Various modes

- It is possible to display the status, to change or set the parameters, to automatically set the notch filter, and to confirm test operation, alarm history and monitor display with the built-in digital operator.

Mode	Contents																						
Status Display	Displays the establishment of control or main power supply, Servo ON, over travel, warning and alarm status. [Page 4 – 3]																						
[b A] Basic parameter	Parameters necessary for test operations by JOG and auto-tuning. Can be set at generic parameter mode. [Page 4 – 7]																						
[G r] Generic parameter	Settings can be made suitable for machines and equipment. Parameters for adjusting servo gain can be changed. Classified into 10 groups according to the functions. [Page 4 – 9]																						
	<table border="1"> <thead> <tr> <th>Group</th> <th>Description of Group</th> </tr> </thead> <tbody> <tr> <td>Group0</td> <td>Settings of tuning mode.</td> </tr> <tr> <td>Group1</td> <td>Settings of basic control parameters.</td> </tr> <tr> <td>Group2</td> <td>Settings of damping control/notch filter/disturbance observer</td> </tr> <tr> <td>Group3</td> <td>Settings of gain switching control/damping frequency switching</td> </tr> <tr> <td>Group4</td> <td>To set high setting control.</td> </tr> <tr> <td>Group8</td> <td>Settings related to system control</td> </tr> <tr> <td>Group9</td> <td>Settings related to generic input signals/function condition setting</td> </tr> <tr> <td>GroupA</td> <td>Settings related to generic output signals/monitor output signals/set-up software</td> </tr> <tr> <td>GroupB</td> <td>Settings related to system sequence/warnings or alarms.</td> </tr> <tr> <td>GroupC</td> <td>Settings related to servo motor encoder.</td> </tr> </tbody> </table>	Group	Description of Group	Group0	Settings of tuning mode.	Group1	Settings of basic control parameters.	Group2	Settings of damping control/notch filter/disturbance observer	Group3	Settings of gain switching control/damping frequency switching	Group4	To set high setting control.	Group8	Settings related to system control	Group9	Settings related to generic input signals/function condition setting	GroupA	Settings related to generic output signals/monitor output signals/set-up software	GroupB	Settings related to system sequence/warnings or alarms.	GroupC	Settings related to servo motor encoder.
	Group	Description of Group																					
	Group0	Settings of tuning mode.																					
	Group1	Settings of basic control parameters.																					
	Group2	Settings of damping control/notch filter/disturbance observer																					
	Group3	Settings of gain switching control/damping frequency switching																					
	Group4	To set high setting control.																					
	Group8	Settings related to system control																					
	Group9	Settings related to generic input signals/function condition setting																					
	GroupA	Settings related to generic output signals/monitor output signals/set-up software																					
GroupB	Settings related to system sequence/warnings or alarms.																						
GroupC	Settings related to servo motor encoder.																						
[A u] Automatic adjustment	Enables automatic adjustment for torque command notch filter A, damping frequency and offset of analog speed/torque/torque addition command. [Page 4 – 1 1]																						
[A d] Test operation	Enables JOG operation, alarm reset, writing of auto-tuning result, encoder clear and alarm history clear. [Page 4 – 1 2]																						
[S y] System Parameter	Sets the parameters related to servo amplifier - servo motor combination and specifications. [Page 4 – 1 4]																						
[A L] Alarm history, software version	Displays the latest 7 alarm events, as well as the servo amplifier CPU software version. [Page 4 – 1 5]																						
[o b] Monitor	Displays the servo amplifier status such as speed, speed command, torque, torque command, position deviation and servo adjustment gain when using auto-tuning. [Page 4 – 5]																						

4. Digital Operator

[Changing Modes]

■ How to change the modes

- Change the modes in the order as shown below by pressing the **MODE** key for changing the settings or for test operation.

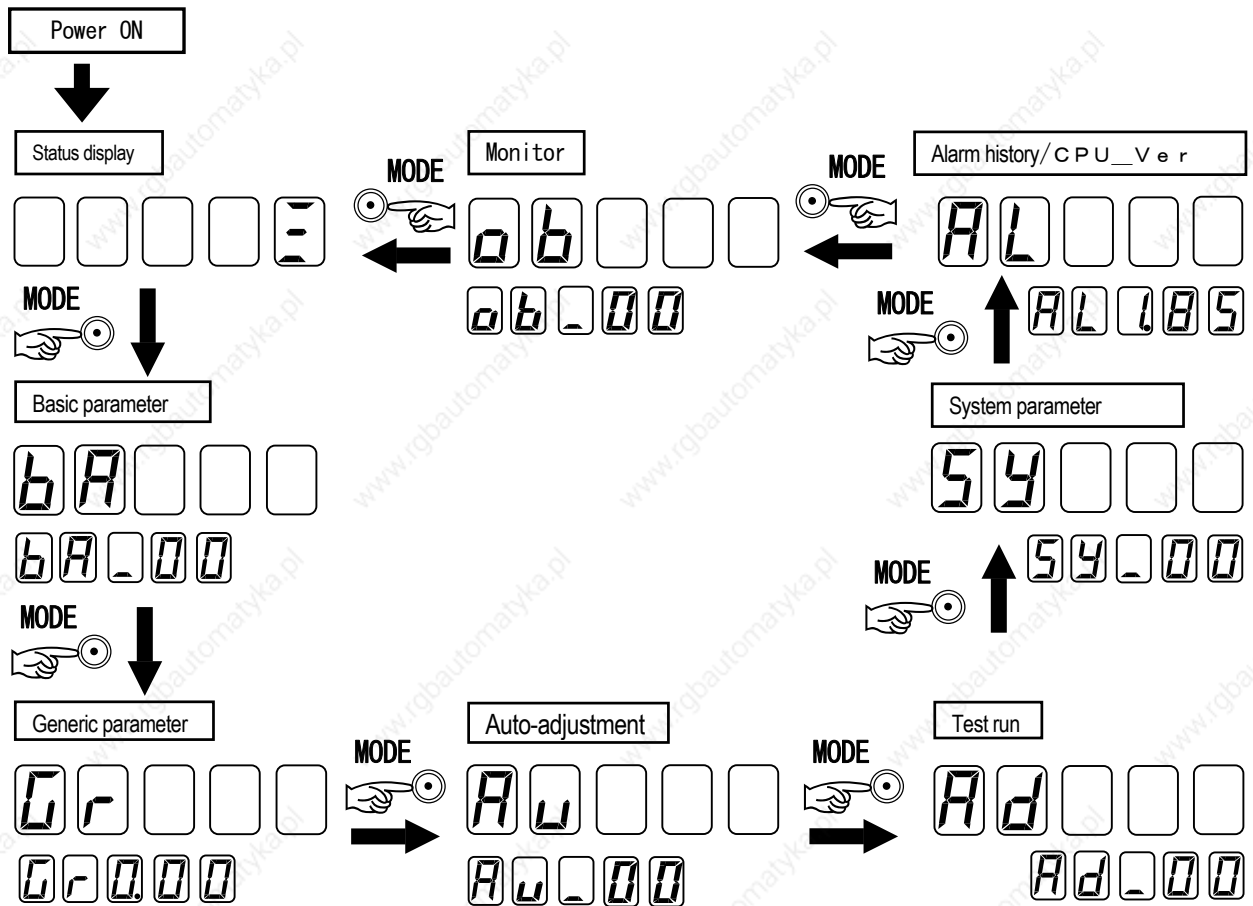

■ Status Display mode

- In the Status Display mode, various conditions are displayed according to the status of servo amplifier as shown in the following table.

Servo amplifier status	Marking
Control power supply established Control power supply (r,t) is established and amplifier (RDY) is ON.	□□□□-
Main power supply being established Main power supply (R,S,T) is ON or is established, but Operation Preparation Completion signal is OFF.	□□□□□
Main power supply established Main power supply (R,S,T) is established and Operation Preparation Completion signal is ON.	□□□□E
Servo is ON. Rotates after drawing the character "8"	□□□□8
Over travel status at normal rotation Forward rotation is in 'Over-Travel' status in position and speed control type.	□□□□7
Over travel status at reverse rotation Reverse rotation is in 'Over-Travel' status in position and speed control type.	□□□□f

4. Digital Operator

[Monitor mode operations and display]

Overload warning status If operation is kept on, alarm may be issued.	
Regenerative overload warning status If operation is kept on, alarm may be issued.	
Battery warning status Replace the battery.	
Alarm display When an alarm rings, take corrective actions as instructed in "Chapter 8, Maintenance".	



- In addition to the above, warning functions include "excessive deviation warning" and "amplifier temperature warning", which can be confirmed at monitor mode.
- There is a possibility that an overload warning will be detected when the control power is supplied, if the overload warning level is set below 75% (generic parameter GroupB Page22), because a rated load of 75% (hot start) has been assumed for the overload detection process when control power is supplied.

■ Description of monitor mode

- Various contents can be monitored as shown below at each page of monitor mode.

Page	Name	Contents	Unit	Display form
00	Servo amplifier status	Main circuit power supply status. Operation preparation status. Servo ON status: Servo ON Displays the status of servo amplifier, as mentioned above.	---	Code
01	Warning status 1	Displays warning status.	---	Bit
02	Warning status 2	Displays warning status.	---	
03	General input CONT8~1 monitor	Displays the status of the general input terminal.	---	
04	General output OUT8~1 monitor	Displays status of general output terminal.	---	
05	Velocity monitor	Displays number of motor rotations.	min ⁻¹	Decimal
06	Velocity command monitor	Displays velocity command value.	min ⁻¹	
07	Torque monitor	Displays output torque of motor.	%	
08	Torque command monitor	Displays torque command value.	%	
09	Position deviation monitor	Displays position deviation value.	Pulse	32 bit data Hexadecimal
0A	Current position monitor (Motor encoder)	Displays the current position assumed that the position at the time of control power turn-ON is origin. This is a free run counter, therefore, if the current position exceeds the displayed range, the maximum value of reverse polarity will be displayed.	Pulse	
0B	Current position monitor (External encoder)			
0C	Command position monitor			
0D	Analog velocity command / analog torque command input voltage	Displays entered command voltage.	mV	Decimal
0E	Position command pulse monitor (Position command pulse input frequency)	Displays entered command pulse frequency.	k Pulse /s	
0F	U-phase electric angle monitor	Always displays U-phase electric angle, excluding encoder(sensor) errors.	deg	
10	Absolute encoder PS data (Upper)	Displays position data PS of absolute encoder.	x2^32 P	32 bit data Hexadecimal
11	Absolute encoder PS data (Lower)	Displays position data PS of absolute encoder.	Pulse	
12	Regenerative resistance run rate	Displays run rate of regenerative resistance.	%	Decimal
13	Motor usage ratio monitor	Displays the accurate value, however, it may sometimes take several hours for the value to become stable depending on the operation pattern.	%	
14	Motor usage ratio monitor (Estimated value)	Displays estimated value of the servo motor usage ratio. Estimated from brief operation. In an application where the same operation pattern repeats in a short time, the usage ratio can be confirmed soon.	%	

4. Digital Operator

[Monitor mode operations and display]

15	Load inertia moment ratio monitor	Values can be confirmed when gain switching and auto-tuning functions are used.	%	Decimal
16	Position loop ratio gain monitor		1/s	
17	Constant monitor at the time of position loop integration	Values can be confirmed when gain switching function is used.	ms	
18	Speed loop ratio gain monitor		Hz	
19	Constant monitor at the time of speed loop integration		ms	
1A	Torque command filter monitor	Displays CN2 incremental signals.	Hz	Bit
1B	Incremental encoder signal monitor		----	
1C	Load torque monitor (Estimate)	Displays load torque.	%	Decimal
1D	Main circuit DC voltage monitor	Displays the main circuit DC voltage.	V	
1E	Amplifier operating time	Counted during control power is being turned ON. The time is displayed value×2 (hours).	×2 hour	

■ How to operate the monitor mode

- See the followings for how to operate the monitor mode and how to interpret the displayed data.

Step	Key	Description	Display status
1	MODE	Press the MODE key to display monitor mode.	ob
2	—	Displays the page automatically. After the power supply is turned ON, "Page 00" is displayed. Then, the previously displayed page is displayed.	ob 00
3	▶	Pressing the cursor key makes the blinking LED move. Move the blinking LED to the desired page to be changed.	ob 00
4	▲ ▼	Pressing the UP key increases the blinking numeric value and the Down key decreases.	ob 01
5	WR	On the page to be monitored, press the WR key to display the data.	Refer to display form.
6	MODE	Pressing the MODE key returns to step 2.	ob 00
7	MODE	Pressing the MODE key again returns to status display.	
		When the pages not allocated are set, the display is as shown in the right.	no.dAt
Page	Name	Display form: Code	
00	Servo amplifier status	Control power established	<input type="text" value="00"/> Main power established <input type="text" value="04"/>
		Main power being established	<input type="text" value="02"/> Servo ON status <input type="text" value="08"/>
Page	Name	Display form: Bit	
01	Warning status 1	Display	
02	Warning status2	LED 1 beginning from right	
03	Generic input CONT8~1 monitor	Warning status 1	4 3 2 1 ← [LED] ↑ With warning
04	Generic output OUT8~1 monitor	Warning status 2	<input type="text" value="11111111"/> Bit ↓ Without warning
1B	Incremental encoder signal monitor	LED 1 beginning from right	
		Generic input	4 3 2 1 ← [LED] ↑ ↑ With warning
		Generic output Incremental signal	<input type="text" value="11111111"/> Bit ↓ Input photo coupler ON Output transistor ON Signal level H Input photo coupler OFF Output transistor OFF Signal level L

4. Digital Operator

[Monitor mode operations and display]

Name	Corresponding bits							
	7	6	5	4	3	2	1	0
Warning status 1	Excessive deviation warning	—	Speed limit operation running	Torque limit operation running	Regeneration overload warning	Overload warning	—	Amplifier temperature warning
Warning status 2	—	Low battery warning	—	—	Reverse over travel	Forward over travel	—	Main circuit power being charged
Generic input CONT8~1	CONT8	CONT7	CONT6	CONT5	CONT4	CONT3	CONT2	CONT1
Generic output OUT 8~1	OUT8	OUT7	OUT6	OUT5	OUT4	OUT3	OUT2	OUT1
Incremental signal	—	External sensor Z phase signal	External sensor B phase signal	External sensor A phase signal	—	Servo motor encoder Z phase signal	Servo motor encoder B phase signal	Servo motor encoder A phase signal

Page	Name	Displayed form: Decimal									
05	Speed monitor	<table border="1"> <tr> <th>Display of “-” data</th> <th>Display of “+” data</th> </tr> <tr> <td></td> <td></td> </tr> <tr> <td></td> <td></td> </tr> </table> <p> The “+” data is displayed without the mark “+” on LED .</p>	Display of “-” data	Display of “+” data							
Display of “-” data	Display of “+” data										
06	Speed command monitor										
07	Torque monitor										
08	Torque command monitor										
0E	Position pulse monitor (Position command pulse input frequency)										
0F	U phase electric angle monitor										
13	Motor usage ratio monitor										
14	Motor usage ratio monitor (estimated value)										
15	Load inertia moment ratio monitor										
16	Position loop proportional gain monitor										
18	Speed loop proportional gain monitor										
1A	Torque command filter monitor										
1C	Load torque monitor (estimated value)										
1D	Main circuit DC voltage monitor										
1E	Amplifier operation time										

Display range			
Name	Maximum	Minimum	Unit
Speed monitor / speed command monitor	±9999	0	min ⁻¹
torque monitor / torque command monitor	±499	0	%
position command pulse monitor (position command pulse input frequency)	±6000	0	k Pulse/s
U phase electric angle monitor	359	0	deg
Motor usage ratio monitor / motor usage ratio monitor (estimated value)	499	0	%
Load inertia moment ratio monitor	15000	0	%
Position loop proportional gain monitor	3000	1	1/s
Speed loop proportional gain monitor	2000	1	Hz
Torque command filter monitor	2000	1	Hz
Load torque monitor (estimated value)	±499	0	%
Main circuit DC voltage monitor	1000	0	V
Amplifier operation time	—	—	×2 hour

Page	Name	Display form: 32 bit data displayed in hexadecimal			
09	Position deviation monitor				
0A	Current position monitor (motor encoder)	Bit data display “3 1” - “1 6”		Bit data display “1 5” - “0”	
0B	Current position monitor (External encoder)				
0C	Command position monitor				
10	Absolute encoder P S data (upper)				
11	Absolute encoder P S data (lower)				

Display range			
Name	Maximum	Minimum	Unit
Position deviation monitor / current position monitor / Command position monitor	7FFF-FFFF	8000-0000	Pulse
Absolute encoder P S data upper/lower	FFFF-FFFF	0000-0000	Pulse

Pressing the ▲ key displays “H” data, and ▼ key displays “L” data.

Page	Name	Display form : Decimal point							
0D	Analog speed /torque command input voltage	<table border="1"> <tr> <th>Decimal point “-” data display</th> <th>Decimal point “+” data display</th> </tr> <tr> <td></td> <td></td> </tr> </table> <p> The “+” data is displayed without the mark “+” on LED .</p>		Decimal point “-” data display	Decimal point “+” data display				
Decimal point “-” data display	Decimal point “+” data display								
12	Regeneration resistance run rate								
17	Position loop integral time constant monitor	<table border="1"> <tr> <th>Data display of “1 decimal place”</th> <th>Data display of “2 decimal places”</th> </tr> <tr> <td></td> <td></td> </tr> </table>		Data display of “1 decimal place”	Data display of “2 decimal places”				
Data display of “1 decimal place”	Data display of “2 decimal places”								
19	Speed loop integral time constant monitor								

Display range			
Name	Maximum	Minimum	Unit
Regeneration resistance run rate	99.99	0.00	%
Position loop integral time constant monitor	1000.0	0.5	msec
Speed loop integral time constant monitor	1000.0	0.5	msec

4. Digital Operator

[Basic Mode Operations and Display]

■ Description of basic mode

- The following parameters can be set and changed at each page of the basic mode.

These parameters are necessary when test run by JOG operation and real time auto-tuning are used.

MODE	Page	Name	Contents	Group and Page
b A	00	Axis number for Setup software communication	Selects the axis number when communicating with PC.	GroupA 20
	01	Baud rate for Setup software communication	Selection of Baud rate when communicating with PC.	GroupA 21
	02	Tuning mode	Tuning mode selection	Group0 00
	03	Auto-tuning response	Response when auto-tuning is used.	Group0 02
	04	Position command filter	Sets the low pass filter of position command pulse	Group1 01
	05	Electric gear 1	Sets the electric gear for position command pulse	Group8 15
	06	Positioning completion range	Range setting for positioning complete signal output	Group8 41
	07	Forward over travel	Condition selection to enable forward over travel function	Group9 00
	08	Reverse over travel	Condition selection to enable reverse over travel function	Group9 01
	09	Alarm resetting function	Condition selection to enable alarm resetting function	Group9 02
	0A	Absolute encoder clearing function	Condition selection to enable encoder clearing function	Group9 03
	0B	Deviation clearing function	Condition selection to enable deviation clearing function	Group9 04
	0C	Servo ON function	Condition selection to enable servo ON function	Group9 05
	0D	Torque limiting function	Condition selection to enable torque limiting function	Group9 32
	0E	JOG speed command	Sets the speed command at JOG operation.	GroupB 00
0F	Dividing ratio of Encoder pulse dividing output	Setting of encoder pulse dividing output	GroupC 05	
10	Analog speed command offset	Manual offset adjustment of analog speed command	----	

See "Chapter 5, Parameter" for details of parameters.

■ How to set the basic mode

- See the followings for how to operate and set the basic mode.

Step	Key	Description	Display status
1	MODE	Press the MODE key to display basic mode.	bA
2	—	Displays the page automatically. After the power supply is turned ON, "Page 00" is displayed. Then, the previously displayed page is displayed.	bA 00
3		Pressing the cursor key makes the blinking LED move. Move the blinking LED to the page to be changed.	bA 00
4		Pressing the UP key increases the blinking value and the Down key decreases.	bA 03
5	WR	On the page to be changed, press the WR key to display the data.	Refer to display form
6		Pressing the cursor key makes the blinking LED move. Move the blinking LED to the desired value to be changed.	0d
7		Pressing the UP key increases the blinking value and the Down key decreases.	00
8	WR	Press the WR key, and the display will blink 3 times to write. If writing is impossible, the numeric value is out of setting range. Check the setting value again.	00
9	MODE	Pressing the MODE key returns to step 2.	bA 00
10	MODE	Pressing the MODE key again returns to status display.	
	When the pages not allocated are set, the display is as shown in the right.		no.dAt

For setting the dividing ratio of dividing output, different procedure is taken at step 5. Refer to page 4-8 for how to set fractions.

4. Digital Operator

[Basic Mode Operations and Display]

Page	Name	Display form: decimal																																																						
00	Setup software Communication axis number	Data display 00																																																						
01	Setup software Communication Baud rate																																																							
02	Tuning mode																																																							
03	Auto-tuning response																																																							
06	Positioning completion range																																																							
07	Forward over travel function																																																							
08	Reverse over travel function																																																							
09	Alarm resetting function																																																							
0A	Absolute encoder clearing function																																																							
0B	Deviation clearing function																																																							
0C	Servo ON function																																																							
0D	Torque limiting function																																																							
0E	JOG speed command																																																							
		<table border="1"> <thead> <tr> <th>Name</th> <th>Standard setting</th> <th>Unit</th> <th>Setting range</th> </tr> </thead> <tbody> <tr> <td>Communication axis number of Setup software</td> <td>01</td> <td>---</td> <td>01~0F</td> </tr> <tr> <td>communication baud rate of Setup software</td> <td>05</td> <td>---</td> <td>00~05</td> </tr> <tr> <td>Tuning mode</td> <td>00</td> <td>---</td> <td>00~02</td> </tr> <tr> <td>Auto-tuning response</td> <td>5</td> <td>---</td> <td>1~30</td> </tr> <tr> <td>Positioning complete range</td> <td>100</td> <td>Pulse</td> <td>1~65535</td> </tr> <tr> <td>Forward over travel function</td> <td>0D</td> <td>---</td> <td rowspan="8">00~27</td> </tr> <tr> <td>Reverse over travel function</td> <td>0B</td> <td>---</td> </tr> <tr> <td>Alarm resetting function</td> <td>10</td> <td>---</td> </tr> <tr> <td>Absolute encoder clearing function</td> <td>06</td> <td>---</td> </tr> <tr> <td>Deviation clearing function</td> <td>08</td> <td>---</td> </tr> <tr> <td>Servo ON function</td> <td>02</td> <td>---</td> </tr> <tr> <td>Torque limiting function</td> <td>0E</td> <td>---</td> </tr> <tr> <td>JOG speed command</td> <td>50</td> <td>min⁻¹</td> <td>0~32767</td> </tr> <tr> <td>Dividing ratio of encoder pulse dividing output</td> <td>1/1</td> <td>---</td> <td>1/8192~1/1</td> </tr> </tbody> </table>	Name	Standard setting	Unit	Setting range	Communication axis number of Setup software	01	---	01~0F	communication baud rate of Setup software	05	---	00~05	Tuning mode	00	---	00~02	Auto-tuning response	5	---	1~30	Positioning complete range	100	Pulse	1~65535	Forward over travel function	0D	---	00~27	Reverse over travel function	0B	---	Alarm resetting function	10	---	Absolute encoder clearing function	06	---	Deviation clearing function	08	---	Servo ON function	02	---	Torque limiting function	0E	---	JOG speed command	50	min ⁻¹	0~32767	Dividing ratio of encoder pulse dividing output	1/1	---	1/8192~1/1
Name	Standard setting	Unit	Setting range																																																					
Communication axis number of Setup software	01	---	01~0F																																																					
communication baud rate of Setup software	05	---	00~05																																																					
Tuning mode	00	---	00~02																																																					
Auto-tuning response	5	---	1~30																																																					
Positioning complete range	100	Pulse	1~65535																																																					
Forward over travel function	0D	---	00~27																																																					
Reverse over travel function	0B	---																																																						
Alarm resetting function	10	---																																																						
Absolute encoder clearing function	06	---																																																						
Deviation clearing function	08	---																																																						
Servo ON function	02	---																																																						
Torque limiting function	0E	---																																																						
JOG speed command	50	min ⁻¹		0~32767																																																				
Dividing ratio of encoder pulse dividing output	1/1	---	1/8192~1/1																																																					
Page	Name	Display form: decimal point																																																						
04	Position command filter Data display of "decimal point 1" 0.1	<table border="1"> <thead> <tr> <th>Name</th> <th>Standard setting</th> <th>Unit</th> <th>Setting range</th> </tr> </thead> <tbody> <tr> <td>position command filter</td> <td>0.0</td> <td>ms</td> <td>0.0~2000.0</td> </tr> </tbody> </table>	Name	Standard setting	Unit	Setting range	position command filter	0.0	ms	0.0~2000.0																																														
Name	Standard setting	Unit	Setting range																																																					
position command filter	0.0	ms	0.0~2000.0																																																					
Page	Name	Display form: fraction																																																						
10	analog speed command offset Display of "-" data: -1000 Display of "+" data: 1000	<table border="1"> <thead> <tr> <th>Standard setting value</th> <th>Unit</th> <th>Setting range</th> </tr> </thead> <tbody> <tr> <td>0</td> <td>---</td> <td>-9999~+9999</td> </tr> </tbody> </table>	Standard setting value	Unit	Setting range	0	---	-9999~+9999																																																
Standard setting value	Unit	Setting range																																																						
0	---	-9999~+9999																																																						
Page	Name	Display form : fraction																																																						
05 OF	Electronic gear Dividing ratio of encoder pulse dividing output Data display of numerator: 1 Data display of denominator: 1 Denominator is displayed with a dot at its right.	<table border="1"> <thead> <tr> <th>Name</th> <th>Standard setting value</th> <th>Unit</th> <th>Setting range</th> </tr> </thead> <tbody> <tr> <td>Electronic gear</td> <td>1/1</td> <td></td> <td>1/32767~32767/1</td> </tr> <tr> <td>Dividing ratio of encoder pulse dividing output</td> <td>1/1</td> <td>---</td> <td>1/8192~1/1</td> </tr> </tbody> </table>	Name	Standard setting value	Unit	Setting range	Electronic gear	1/1		1/32767~32767/1	Dividing ratio of encoder pulse dividing output	1/1	---	1/8192~1/1																																										
Name	Standard setting value	Unit	Setting range																																																					
Electronic gear	1/1		1/32767~32767/1																																																					
Dividing ratio of encoder pulse dividing output	1/1	---	1/8192~1/1																																																					
How to set fractional data. [different from step 5 of the basic mode setting procedure]																																																								
The following example is when the data needs to be changed to 2/64 from the set value of 1/1.																																																								
5	WR	Press the WR key on the page to be changed, and the numerator data will be displayed.	1																																																					
		Pressing the cursor key makes the blinking LED move. Move the blinking LED to the page to be changed.	1																																																					
		Pressing the UP key increases the blinking numeric value and the Down key decreases.	2																																																					
	WR	Press the WR key, and the display will blink 3 times to write. If writing is impossible, the numeric value is out of setting range. Check the setting value again.	2																																																					
		Press the Down key, and denominator data will be displayed. Denominator is displayed with a dot at its right.	1.																																																					
		Pressing the cursor key makes the blinking LED move. Move the blinking to the numeric value to be changed.	1.																																																					
		Pressing the UP key increases the blinking numeric value and the Down key decreases.	64.																																																					
	WR	Press the WR key, and the display will blink 3 times to write. If writing is impossible, the numeric value is out of setting range. Check the setting value again.	64.																																																					
9	Return to step 9 of the basic mode setting procedure.																																																							

4. Digital Operator

[Basic Mode Operations and Display]

■ Description of general parameter mode

- The following parameters can be set and changed at each page of general parameter mode. Settings can be made suitable for machines and equipment. Parameters for adjusting servo gain can be changed. Classified into 10 groups according to their functions.

Group	Description Group
Group0	Tuning mode setting
Group1	Settings of basic control parameters
Group2	Settings of damping control/notch filter/disturbance observer
Group3	Settings of gain switching control/damping frequency switching
Group4	To set high setting control
Group8	Settings related to system control
Group9	Settings related to general input signals/function condition setting
GroupA	Settings related to general output signals/monitor output signals/Setup software
GroupB	Settings related to system sequence/warning and alarms
GroupC	Settings related to servo motor encoder



Refer to “Chapter5, Parameter” for details of parameters.

■ How to set the general parameter mode

- See the followings for operations and setting method of general parameters.

Step	Input key	Description	Display status
1	MODE	Press the MODE key to display basic mode.	Gr
2	—	Page is automatically displayed. Once power is turned ON, [group 0] is displayed and then the previously displayed group and page are displayed. Group No. _____ Parameter Page No. _____	Gr 0. 00
3	▶	Pressing the cursor key makes the blinking LED move. Move the blinking LED to the group or page to be changed.	Gr 0. 00
4	▲ ▼	Pressing the UP key increases the blinking numeric value and the Down key decreases. \uparrow	Gr 0. 00
5	WR	On the desired group or page, press the WR key to display the data.	Refer to _____ Display form _____
6	▶	Pressing the cursor key makes the blinking LED move. Move the blinking LED to the numeric value to be changed.	Od
7	▲ ▼	Pressing the UP key increases the blinking numeric value and the Down key decreases.	00
8	WR	Press the WR key, and the display will blink 3 times to write the data. If writing is impossible, the numeric value is out of setting range. Check the setting value again.	00
9	MODE	Pressing the MODE key returns to step 2.	Gr 0. 00
10	MODE	Pressing the MODE key again, returns to status display.	
		When the pages not allocated are set, the display is as shown in the right.	no. dAt



For setting the dividing ratio of encoder pulse dividing output and electronic gear 1, 2, different procedure is taken at step 5. Refer to page 4-10 for how to set fractions.

4. Digital Operator

[General parameter mode operations and display]

Display form : integer

Display of “-” data	Display of “+” data	“The +” data is displayed without the mark “+” on LED. The setting ranges of the table below are displayed as shown in the left.
- 1 0 0 0	1 0 0 0	
	1 5 0 0 0	

Name	Setting range	Unit
Position loop proportional gain	1~3000	1/s
Load inertia moment ratio(load mass ratio)	0~15000	%
Acceleration feed back gain	-1000~+1000	0.1%
Torque command filter	1~2000	Hz
Torque command filter number	1~3	
Acceleration compensation	-9999~+9999	Pulse

The above parameters are examples. Refer to “Chapter 5, Parameter” for parameter list.

Display form: decimal point

Display of “decimal point ” data	The setting ranges of the table below are displayed as shown in the left.
1 2 . 0 0	

Name	Setting range	Unit
Position command filter	0.0~2000.0	ms
Speed loop integral time constant	0.5~1000.0	ms

The above parameters are examples. Refer to “Chapter 5, Parameter” for the parameter list.

Display form: fraction

Data display of numerator	Data display of denominator	Denominator is displayed with a dot at its right. The setting ranges of the table below are displayed as shown in the left.
1	1.	

Name	Setting range
Dividing ratio of encoder pulse dividing output	1/8192~1/1
Electronic gear 1	1/32767~32767/1
Electronic gear 2	1/32767~32767/1

How to set fractional data. [different from step 5 of general parameter mode setting procedure.

The following example is when the data needs to be changed to 2/64 from the set value of 1 / 1

5	WR	On the page to be changed, press the WR key to display the numerator data.	1
	▶	Pressing the cursor key makes the blinking LED move. Move the blinking LED to the page to be changed.	1
	▲ ▼	Pressing the UP key increases the blinking numeric value and the Down key decreases.	2
	WR	Press the WR key, and the display will blink 3 times to write the data. If writing is impossible, the numeric value is out of setting range. Check the setting value again.	2
	▼	Press the Down key to display denominator data. Denominator is displayed with a dot at its right.	1.
	▶	Pressing the cursor key makes the blinking LED move. Move the blinking LED to the numeric value to be changed.	1.
	▲ ▼	Pressing the UP key increases the blinking numeric value and the Down key decreases.	64.
	WR	Press the WR key, and the display will blink 3 times to write the data. If writing is impossible, the numeric value is out of setting range. Check the setting value again.	64.
9		Return to step 9 of the general parameter mode setting procedure.	

4. Digital Operator

[Auto-adjustment mode operations and display]

■ Description of auto-adjustment mode

- Automatic notch frequency tuning, automatic damping frequency tuning, automatic offset of analog speed and torque command, and analog torque addition command auto-offset can be executed.

MODE	Page	Name
A u	00	Execution of automatic notch frequency tuning. Note 2)
	01	Execution of automatic damping frequency tuning Note 2)
	02	Analog speed /torque command auto-offset
	03	Analog torque addition command auto-offset

■ How to set the automatic mode

- See the followings for how to operate and set the test run mode.

Step	Input key	Description	Display status
1	MODE	Press the MODE key to display test run mode.	Au
2	—	Page is displayed automatically. Once the power is turned ON, [Page 00] is displayed then the previously displayed page is displayed.	Au 00
3	▶	Pressing the cursor key makes the blinking LED move. Move the blinking LED to the page to be changed.	Au 00
4	▲ ▼	Pressing the UP key increases the blinking numeric value and the Down key decreases.	Au 01
5	WR	On the page to be changed, press the WR key to display execution confirmation.	—y_n—
6	▲	Press the ▲ key for execution.	Proceed to step 7
	▼	Press the ▼ key for cancellation and to return to step 3.	Au 01
7	---	"r d y" is displayed when execution is possible. Move to step 8. Note 1)	rdy
	---	"n o . r d y" is displayed when execution is impossible. Press the MODE key to return to step 3.	no.rdy
8	MODE	Press the MODE key for cancellation, and move to step 11 for auto-notch and auto-damping. For analog speed /torque command auto-offset, analog torque addition command auto-offset, return to step 3.	
	WR	Press the WR key for execution. Display is as shown in the right while auto-notch and auto-damping are being executed.	r . u . n . . 8
9		When completed normally, "— E n d —" is displayed. "— E r r —" is displayed in case of an error.	—End—
10	MODE	Pressing the MODE key returns to step 7 for auto-notch and auto-damping. For analog speed /torque command offset and analog torque addition command auto-offset, returns to step 3.	
11		Completes with the display of "A L _ d F".	AL dF
 For auto-damping, pressing the MODE key during execution of step 8 cancels the execution and moves to step 11.			

Note 1) At the time of automatic notch frequency and automatic damping frequency tuning, if the main circuit power is shut off in this status, make sure to turn On the main power source again or turn OFF and ON the control power.

Note 2) If the control mode switching type is in use, it may not be possible to use this. Switch the control mode at the base side [03 : _Velo—Torq] to Velo (speed control) to use this.

4. Digital Operator

[Test run mode operations and display]









■ Description of test run mode

- J O G operation, alarm reset, encoder clear, alarm history clear, and writing of auto-tuning result can be executed.

MODE	Page	Name
A d	00	Execution of JOG operation Note 2)
	01	Execution of alarm reset
	02	Writing of auto-tuning result
	03	Execution of encoder clear
	04	Execution of alarm history clear

■ How to set the test run mode

- See the followings for how to operate and set the test run mode.

Step	Input key	Description	Display status
1	MODE	Press the MODE key to display test run mode.	Ad
2	---	Page is automatically displayed. Once the power source is turned ON, [Page 00] is displayed then the previously displayed page is displayed.	Ad 00
3		Pressing the cursor key makes the blinking LED move. Move the blinking LED to the page to be changed.	Ad 00
4	 	Pressing the UP key increases the blinking numeric value and the Down key decreases.	Ad 01
5	WR	On the page to be changed, press the WR key to display confirmation.	-y_n-
6		Press the  key for execution.	Proceed to step 7
		Press the  key for cancellation and to return to step 3.	Ad 01
7	---	"r d y" is displayed when execution is possible. Move to step 8. Note 1)	rdy
	---	"n o . r d y" is displayed when execution is impossible. Press the MODE key to return to step 3.	no.rdy
 On and after step 8, the display and operations differ depending on the function in use. See the following pages for display and operations described separately for each function.			

Note 1) At the time of JOG operation, if the main circuit power is shut off in this status, press the MODE key or turn ON the main power source again or turn OFF and ON the control power.

4. Digital Operator

[Test run mode operations and display]

- See the followings for how to operate and set JOG operation.

Step	Input key	Description	Display status
8	MODE	Press the MODE key for cancellation and to proceed to step 10.	AL dF
	WR	Pressing the WR key displays a number of '8' in servo ON status. Note 2)	8
9	▲	Press the ▲ key, and the motor shaft rotates to CCW direction. (Dot moves.) Note 2)	r . u . n . . 8
	▼	Press the ▼ key, and the motor shaft rotates to CW direction. (Dot moves.) Note 2)	r . u . n . . 8
<p> Command speed at the time of JOG operation shall be set at "general parameter, GroupB_00". If not changed, the rotation will be "50min⁻¹" which was set at the time of shipment.</p>			
10	MODE	Press the MODE key, and JOG operation will end. The display shows 「AL_dF」, which is not an error.	AL dF

Digital operator cannot perform JOG operation from servo ON status. Servo ON signal from upper device shall be turned OFF. When general parameter "group 9_05" is set to [01:_Always_ON], set this to [00:_Always_OFF] to execute JOG operation.

Note1) If the control mode switching type is in use, it may not be possible to use this. Switch the control mode at the base side [03 : _Velo-Torq] to Velo (speed control) to use this.

Note2) At the time of JOG operation, if the main circuit power is shut off, press the MODE key.

- See the followings for how to operate alarm reset.

Step	Input key	Description	Display status
8	MODE	Press the MODE key for cancellation and to return to step 3.	Ad 01
	WR	Press the WR key to reset the alarm and "—End—" will be displayed. While "—Err—" is displayed, alarm cause is not yet eliminated. Take the corrective actions as instructed in "Chapter 8, Maintenance".	—End— —Err—
9	MODE	Press the MODE key to return to step 3.	Ad 01

- See the followings for how to operate auto-tuning result writing / encoder clear / alarm history clear.

Step	Input key	Description	Display status
8	MODE	Press the MODE key for cancellation and to return to step 3.	Ad_02
	WR	Press the WR key, and "r u n"(while execution) will be displayed in case of encoder clear, and dot moves to right and left.	r . u . n . .
9		When completed normally, "—End—" is displayed. If not, "—Err—" is displayed.	—End— —Err—
	MODE	Pressing the MODE key returns to step 7.	Ad_02

When "Auto-tuning result writing" is used at digital operator, it is impossible to write after monitoring the tuning result.

4. Digital Operator [System parameter mode operations and display]

■ Description of system parameter mode







- On each page of the system parameter mode, parameters are set related to combinations and specifications of servo amplifier and servo motor as shown below.

MODE	Page	Name	Setting range
S y	00	Main circuit power supply input type	2 ways (1way)
	01	Motor encoder (sensor)type	2ways
	02	Incremental encoder function selection	2ways(10 ways)
	03	Incremental encoder resolution	500P/R ~ 65535P/R
	04	Absolute encoder function selection	8ways
	05	Absolute encoder resolution	11ways
	06	Servo amplifier information [editing disabled]	---
	07	Combined motor code [editing disabled]	---
	08	Control mode	6ways
	09	Position loop control · position loop encoder selection	3ways
	0A	External encoder resolution	500P/R ~ 65535P/R
	0B	Regeneration resistance selection	3ways

 Refer to “Chapter 5, Parameter” for details of parameters

■ How to set the system parameter mode

- See the followings for how to operate and set the system parameter mode.

Step	Input key	Description	Display status
1	MODE	Press the MODE key to display system parameter mode.	Sy
2	—	Page is automatically displayed. Once the power source is turned ON, [Page 00] is displayed then the previously displayed page is displayed.	Sy 00
3		Pressing the cursor key makes the blinking LED move. Move the blinking LED to the page to be changed.	Sy 00
4	 	Pressing the UP key increases the blinking numeric value and the Down key decreases.	Sy 0b
5	WR	On the page to be changed, press the WR key to display the data.	01
6		Pressing the cursor key makes the blinking LED move. Move the blinking LED to the numeric value to be changed.	01
7	 	Pressing the UP key increases the blinking numeric value and the Down key decreases.	02
8	WR	Press the WR key, and the display will blink 3 times to write the data. If writing is impossible, the numeric value is out of setting range. Check the setting value again.	02
9	MODE	Pressing the MODE key returns to step 2.	Sy 0b
10	MODE	Pressing the MODE key again returns to status display.	
		When the pages not allocated are set, the display is as shown in the right.	no.dAt

4. Digital Operator [Alarm trace/C P U V e r mode operations and display]

■ Description of Alarm trace/C P U__V e r mode

- It is possible to confirm the latest 7 alarms and the software version of servo amplifier C P U.

MODE	Page	Name
A L	1	1st latest alarm
	2	2nd latest alarm
	3	3 rd latest alarm
	4	4 th latest alarm
	5	5 th latest alarm
	6	6 th latest alarm
	7	7 th latest alarm
		C P U software version



Refer to “Chapter 8, Maintenance” for details of alarms.

■ How to display the alarm trace mode

- See the followings for how to operate and display the alarm trace.

Step	Input key	Description	Display status
1	MODE	Press the M O D E key to display system parameter mode.	AL
2	—	Page is automatically displayed. Once the power source is turned ON, [1 st latest alarm] is displayed then the previously displayed page is displayed.	AL 1. 85
3	▲ ▼	Pressing the UP key increases the blinking numeric value and the Down key decreases. The blinking number shows the alarm history.	

■ How to display C P U software version.

- See the followings for how to display the C P U software version.

Step	Input key	Description	Display status
1	MODE	Press the M O D E key to display system parameter mode.	AL
2	—	Page is automatically displayed. Once the power source is turned ON, [1 st latest alarm] is displayed then the previously displayed page is displayed.	AL 1. 85
3	▲ ▼	Press the Up/Down key, and the display as shown in the right appears.	CPu. no
4	WR	Press the W R key to display the version.	**.*.*
5	MODE	Press the M O D E key to return to step 3.	CPu. no

4. Digital Operator

[Password setting]

■ Description of password function

- The password function allows selection of a password and protection against unauthorized parameter changes. Once a password has been set, "status mode" and "monitor mode" can only be used. Utilize this function to avoid operational mistakes.

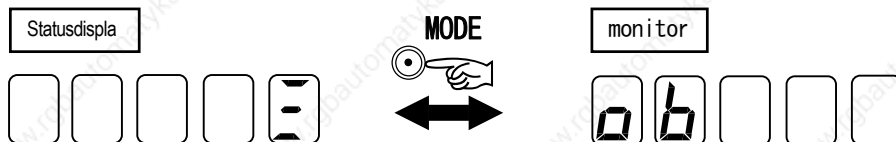

■ How to set and release password

Step	Input key	Description	Status display
1	MODE	Turn ON the power source or press the MODE key to display the status display mode.	
2	▲	Press the Up key, and the display shown in the right appears.	-PAS-
		Display starts blinking : password not yet set → password setting	-PAS-
		Display turns ON : Password has been set. → Password release	-PAS-
4	WR	Press the WR key to display " 0 0 0 0".	0000
5	▲ ▼	Pressing the UP key increases the blinking numeric value and the Down key decreases.	
		For password setting, use a combination of 4 digit numeric values and alphabets in hexadecimal. To release the password, input the previously set 4 digit password.	1000
6	WR	Press the WR key, and the display blinks 3 times to write or release the password.	1000
		When writing is disabled, " - E r r - " shows that this is out of setting range. " 0 0 0 0 " and " F F F F " are invalid.	-E r r-
		When release is disabled, " - E r r - " shows that this is a wrong password.	
7	MODE	Press the MODE key to return to step 1.	

- ✎ For password setting, it is important to make a note of the password and remember it for future reference. Without the password, it is impossible to release the lock function.
- The password function is enabled or disabled by turning OFF the control power and then once again switching it ON. The possible values for a password is a combination of 4 digits from 0 to 9 and A to F. " 0 0 0 0 " and " F F F F " are invalid. Setting and release of a password cannot be performed by "Setup software - R-S e t u p". Once a password has been set, parameters cannot be changed via "Setup software - R-S e t u p". If parameters are changed via "Setup software - R-S e t u p", "communication establishment" will be disconnected.

[Parameter]

◆	Parameter List.....	5-1
◆	Parameter setting value 【Group0】 【Group1】 ...	5-7
◆	Parameter setting value 【Group2】	5-9
◆	Parameter setting value 【Group3】	5-10
◆	Parameter setting value 【Group4】	5-12
◆	Parameter setting value 【Group8】	5-13
◆	Parameter setting value 【Group9】	5-18
◆	Parameter setting value 【GroupA】	5-20
◆	Parameter setting value 【GroupB】	5-23
◆	Parameter setting value 【GroupC】	5-26
◆	System parameter setting value.....	5-28

5. Parameter

[Parameter List]

■ General Parameter Group 0 [Auto-tuning setting]

Page	Name	Standard Value	Unit	Display Range	Reference page	level
00	Tuning mode	00:_AutoTun	—	00~02	5-7	Ba
01	Automatic Tuning Characteristic	00:_Positioning1	—	00~04	5-7	Ad
02	Automatic Tuning Response	5	—	1~30	5-7	Ba
03	Automatic Tuning, Automatic Parameter Saving	00:_Auto_Saving	—	00~01	5-7	Ad
10	Automatic Notch Filter Tuning, Torque Command	50	%	10~100	5-7	Ad
20	Automatic Vibration Suppressor Frequency Tuning, Torque Command	25	%	10~100	5-7	Ad
21	Automatic Vibration Suppressor Frequency Tuning, Friction Compensation Value	5	%	0~50	5-7	Ad

■ General Parameter Group 1 [Basic controlling parameter setting]

Page	Name	Standard Value	Unit	Display Range	Reference page	level
01	Position command filter	0.0	ms	0.0~2000.0	5-7	Ba
02	Position Loop Proportional Gain 1	30	1/s	1~3000	5-7	Ad
03	Position Loop Integral Time Constant 1	1000.0	ms	0.5~1000.0	5-7	Ad
04	Higher Tracking Control, Position Compensation Gain	0	%	0~100	5-8	Ad
05	Feed Forward Gain	0	%	0~100	5-8	Ad
08	Feed Forward Filter	2000	Hz	1~2000	5-8	Ad
10	Velocity Command Filter	2000	Hz	1~2000	5-8	Ad
12	Velocity Feedback Filter	1500	Hz	1~2000	5-8	Ad
13	Velocity Loop Proportional Gain 1	50	Hz	1~2000	5-8	Ad
14	Velocity Loop Integral Time Constant 1	20.0	ms	0.5~1000.0	5-8	Ad
15	Load Inertia Ratio (Load Mass Ratio) 1	100	%	0~15000	5-8	Ad
16	Higher Tracking Control, Velocity Compensation Gain	0	%	0~100	5-8	Ad
17	Acceleration Feedback Gain	0.0	%	-100.0~100.0	5-8	Ad
18	Acceleration Feedback Filter	500	Hz	1~2000	5-8	Ad
20	Torque Command Filter 1	600	Hz	1~2000	5-8	Ad
21	Torque Command Filter Order	2	Order	1~3	5-8	Ad

■ General Parameter Group 2 [Vibration suppressing control/Notch filter/Disturbance observer setting]

Page	Name	Standard Value	Unit	Display Range	Reference page	Level
00	Vibration Suppressor Frequency 1	500	Hz	5~500	5-9	Ad
01	Vibration Suppressor Level Selection	00	—	00~03	5-9	Ad
10	Velocity Command, Notch Filter	500	Hz	50~500	5-9	Ad
20	Torque Command, Notch Filter A	2000	Hz	100~2000	5-9	Ad
21	TCNFILA, Low Frequency Phase Delay Improvement	00	—	00~02	5-9	Ad
22	Torque Command, Notch Filter B	2000	Hz	100~2000	5-9	Ad
23	TCNFILB, Depth Selection	00	—	00~03	5-9	Ad
24	Torque Command, Notch Filter C	2000	Hz	100~2000	5-9	Ad
25	TCNFILC, Depth Selection	00	—	00~03	5-9	Ad
26	Torque Command, Notch Filter D	2000	Hz	100~2000	5-9	Ad
27	TCNFILD, Depth Selection	00	—	00~03	5-10	Ad
30	Observer characteristic	00:_Low	—	00~01	5-10	Ad
31	Observer Compensation Gain	0	%	0~100	5-10	Ad
32	Observer Output, Low Pass Filter	50	Hz	1~2000	5-10	Ad
33	Observer Output, Notch Filter	2000	Hz	100~2000	5-10	Ad

5. Parameter

[Parameter List]

■ General Parameter Group 3 [Setting for gain switching control/vibration suppressing frequency switching]

Page	Name	Standard Value	Unit	Display Range	Reference page	level
00	Position Loop Proportional Gain 2	30	1/s	1~3000	5-10	Ad
01	Position Loop Integral Time Constant 2	1000.0	ms	0.5~1000.0	5-10	Ad
02	Velocity Loop Proportional Gain 2	50	Hz	1~2000	5-10	Ad
03	Velocity Loop Integral Time Constant 2	20.0	ms	0.5~1000.0	5-10	Ad
04	Load Inertia Ratio (Load Mass Ratio) 2	100	%	0~15000	5-10	Ad
05	Torque Command Filter 2	600	Hz	1~2000	5-10	Ad
10	Position Loop Proportional Gain 3	30	1/s	1~3000	5-11	Ad
11	Position Loop Integral Time Constant 3	1000.0	ms	0.5~1000.0	5-11	Ad
12	Velocity Loop Proportional Gain 3	50	Hz	1~2000	5-11	Ad
13	Velocity Loop Integral Time Constant 3	20.0	ms	0.5~1000.0	5-11	Ad
14	Load Inertia Ratio (Load Mass Ratio) 3	100	%	0~15000	5-11	Ad
15	Torque Command Filter 3	600	Hz	1~2000	5-11	Ad
20	Position Loop Proportional Gain 4	30	1/s	1~3000	5-11	Ad
21	Position Loop Integral Time Constant 4	1000.0	ms	0.5~1000.0	5-11	Ad
22	Velocity Loop Proportional Gain 4	50	Hz	1~2000	5-11	Ad
23	Velocity Loop Integral Time Constant 4	20.0	ms	0.5~1000.0	5-11	Ad
24	Load Inertia Ratio (Load Mass Ratio) 4	100	%	0~15000	5-11	Ad
25	Torque Command Filter 4	600	Hz	1~2000	5-11	Ad
30	Low Pass Filter of Gain Switching	0	ms	0~100	5-11	Ad
40	Vibration Suppressor Frequency 2	500	Hz	5~500	5-12	Ad
41	Vibration Suppressor Frequency 3	500	Hz	5~500	5-12	Ad
42	Vibration Suppressor Frequency 4	500	Hz	5~500	5-12	Ad

■ General Parameter Group 4 [To set high setting control]

Page	Name	Standard Value	Unit	Display Range	Reference page	level
00	Command Velocity, Low Pass Filter	1000	Hz	1~2000	5-12	Ad
01	Command Velocity Threshold	20	min ⁻¹	0~65535	5-12	Ad
02	Acceleration Compensation	0	× 50 Pulse	-9999~+9999	5-12	Ad
03	Deceleration Compensation	0	× 50 Pulse	-9999~+9999	5-12	Ad

5. Parameter

[Parameter List]

■ General Parameter Group 8 [Control system setting]

Page	Name	Standard Value	Unit	Display Range	Reference page	level
00	Command Input Polarity	00:_PC+_VC+_TC+	—	00~07	5-13	Ad
01	Analog Input Dead Band	00:_Disabled	—	00~01	5-13	Ad
11	Position Command Pulse, Form Selection	00:_F-PC_R-PC	—	00~02	5-13	Ad
12	Position Command Pulse, Count Polarity	00:_Type1	—	00~03	5-13	Ad
13	Position Command Pulse, Digital Filter	00:_834nsec	—	00~07	5-14	Ad
14	Position Command, Pulse Multiplier	1	—	1~63	5-14	Ad
15	Electric Gear Ratio 1	1/1	—	1/32767~32767/1	5-14	Ba
16	Electric Gear Ratio 2	1/1	—	1/32767~32767/1	5-14	Ad
17	Positioning method	00:_Pulse_Interval	—	00~01	5-14	Ad
18	Inposition / Position Deviation Monitor	00:_After_Filter	—	00~01	5-14	Ad
19	Deviation Clear Selection	00:_Type1	—	00~03	5-14	Ad
20	Preset Velocity Command 1	100	min ⁻¹	0~32767	5-15	Ad
21	Preset Velocity Command 2	200	min ⁻¹	0~32767	5-15	Ad
22	Preset Velocity Command 3	300	min ⁻¹	0~32767	5-15	Ad
23	Velocity Compensation Command, Input Selection	02:_VCOMP	—	01~02	5-15	Ad
24	Preset Velocity Compensation Command	0	min ⁻¹	-9999~+9999	5-15	Ad
25	Analog Velocity Command, Reference (Analog Velocity Compensation Command, Ref.)	500	min ⁻¹ /V	0~4000	5-15	Ad
26	Velocity Command, Acceleration Time Constant	0	ms	0~16000	5-15	Ad
27	Velocity Command, Deceleration Time Constant	0	ms	0~16000	5-15	Ad
28	Velocity Limit	65535	min ⁻¹	1~65535	5-15	Ad
30	Torque Compensation Command, Input Selection	02:_TCOMP	—	01~02	5-15	Ad
31	Preset Torque Compensation Command 1	0	%	-500~500	5-16	Ad
32	Preset Torque Compensation Command 2	0	%	-500~500	5-16	Ad
33	Analog Torque Command, Reference	50	%/V	0~500	5-16	Ad
34	Analog Torque Compensation Command, Reference	50	%/V	0~500	5-16	Ad
35	Torque Limit, Input Selection	00:_TCLM	—	00~03	5-16	Ad
36	Internal Torque Limit	100	%	10~500	5-16	Ad
37	Torque Limit at Sequence Operation	120	%	10~500	5-16	Ad
40	In-Position Near Range	500	Pulse	1~65535	5-17	Ad
41	In-Position Window	100	Pulse	1~65535	5-17	Ba
42	Speed Zero Range	50	min ⁻¹	50~500	5-17	Ad
43	Low Speed Range	50	min ⁻¹	0~65535	5-17	Ad
44	Speed Matching Width	50	min ⁻¹	0~65535	5-17	Ad
45	High Speed Range	1000	min ⁻¹	0~65535	5-17	Ad

5. Parameter

[Parameter List]

■ General Parameter Group 9 [Function enabling condition setting]

Page	Name	Standard Value	Display Range	Reference page	level
00	Positive Over-Travel Function	0D:_CONT6_OFF	00~27	5-18,19	Ba
01	Negative Over-Travel Function	0B:_CONT5_OFF	00~27	5-18,19	Ba
02	Alarm Reset Function	10:_CONT8_ON	00~27	5-18,19	Ba
03	Absolute Encoder Clear Function	06:_CONT3_ON	00~27	5-18,19	Ba
04	Deviation Clear Function	08:_CONT4_ON	00~27	5-18,19	Ba
05	SERVO-ON Function	02:_CONT1_ON	00~27	5-18,19	Ba
10	Control Mode Switching Function	00:_Always_Disable	00~27	5-18,19	Ad
11	Position Command Pulse Inhibit Function and Velocity Command Zero Clamp Function	00:_Always_Disable	00~27	5-18,19	Ad
12	Electric Gear Switching Function	00:_Always_Disable	00~27	5-18,19	Ad
13	Gain Switching Function, Select Input 1	00:_Always_Disable	00~27	5-18,19	Ad
14	Gain Switching Function, Select Input 2	00:_Always_Disable	00~27	5-18,19	Ad
15	Vibration Suppressor Frequency, Select Input 1	00:_Always_Disable	00~27	5-18,19	Ad
16	Vibration Suppressor Frequency, Select Input 2	00:_Always_Disable	00~27	5-18,19	Ad
17	Position Loop Proportional Control, Switching Function	01:_Always_Enable	00~27	5-18,19	Ad
20	Preset Velocity Command, Select Input 1	00:_Always_Disable	00~27	5-18,19	Ad
21	Preset Velocity Command, Select Input 2	00:_Always_Disable	00~27	5-18,19	Ad
22	Preset Velocity Command, Direction of Move	00:_Always_Disable	00~27	5-18,19	Ad
23	Preset Velocity Command, Operation Start Signal Input	00:_Always_Disable	00~27	5-18,19	Ad
24	Preset Velocity Command, Positive Move Signal Input	00:_Always_Disable	00~27	5-18,19	Ad
25	Preset Velocity Command, Negative Move Signal Input	00:_Always_Disable	00~27	5-18,19	Ad
26	Velocity Loop Proportional Control, Switching Function	04:_CONT2_ON	00~27	5-18,19	Ba
27	Velocity Compensation Function, Select Input	00:_Always_Disable	00~27	5-18,19	Ad
30	Torque Compensation Function, Select Input 1	00:_Always_Disable	00~27	5-18,19	Ad
31	Torque Compensation Function, Select Input 2	00:_Always_Disable	00~27	5-18,19	Ad
32	Torque Limit, Input Selection	0E:_CONT7_ON	00~27	5-18,19	Ba
33	Disturbance Observer	00:_Always_Disable	00~27	5-18,19	Ad
40	External Error Input	00:_Always_Disable	00~27	5-18,19	Ad
41	Main Power Discharge Function	01:_Always_Enable	00~27	5-18,19	Ad
42	Emergency Stop Function	00:_Always_Disable	00~27	5-18,19	Ad

■ General Parameter Group A [Setting for output condition of general output terminal/monitor output selection/setup software]

Page	Name	Standard Value	Display Range	Reference page	level
00	General Purpose Output 1	18:_INP_ON	00~5B	5-20,21	Ad
01	General Purpose Output 2	0C:_TLC_ON	00~5B	5-20,21	Ad
02	General Purpose Output 3	02:_S-RDY_ON	00~5B	5-20,21	Ad
03	General Purpose Output 4	0A:_MBR_ON	00~5B	5-20,21	Ad
04	General Purpose Output 5	33:_ALM5_OFF	00~5B	5-20,21	Ad
05	General Purpose Output 6	35:_ALM6_OFF	00~5B	5-20,21	Ad
06	General Purpose Output 7	37:_ALM7_OFF	00~5B	5-20,21	Ad
07	General Purpose Output 8	39:_ALM_OFF	00~5B	5-20,21	Ad
10	Digital Monitor, Output Signal Selection	00:Always_OFF	00~5B	5-20,21	Ad
11	Analog Monitor 1, Output Signal Selection	05:VMON_2mV/ min ⁻¹	00~15	5-20	Ad
12	Analog Monitor 2, Output Signal Selection	02:TCMON_2V/TR	00~15	5-20	Ad
13	Analog monitor output polarity	00:_MON1+_MON2+	00~08	5-22	Ad
20	Setup Software, Communication Axis Number	01:_#1	01~0F	5-22	Ba
21	Setup Software, Communication Baud Rate	05:_38400bps	00~05	5-22	Ba

5. Parameter

[Parameter List]

■ General Parameter Group B [Setting related to sequence/alarms]

Page	Name	Standard Value	Unit	Display Range	Reference page	Level
00	JOG Velocity Command	50	min ⁻¹	0~32767	5-23	Ba
10	Dynamic Brake Action Selection	04:_SB__Free	—	00~05	5-23	Ad
11	Over-Travel Action Selection	00:_CMDINH_SB_SON	—	00~06	5-23	Ad
12	Emergency Stop Operation	00:_SERVO-BRAKE	—	00~01	5-23	Ad
13	Delay Time of Engaging Holding Brake (holding brake holding delay time)	300	ms	0~1000	5-24	Ad
14	Delay Time of Releasing Holding Brake (holding brake release delay time)	300	ms	0~1000	5-24	Ad
15	Brake Operation Beginning Time	0	ms	0~65535	5-24	Ad
16	Power Failure Detection Delay Time	32	ms	20~1000	5-24	Ad
20	Following Error Warning Level	65535	X1024 pulse	1~65535	5-24	Ad
21	Following Error Limit	500	X1024 pulse	1~65535	5-24	Ad
22	Overload Warning Level	90	%	20~100	5-25	Ad
23	Speed Feedback Error (ALM_C3) Detection	01:_Enabled	—	00~01	5-25	Ad
24	Speed Control Error (ALM_C2) Detection	00:_Disabled	—	00~01	5-25	Ad

■ General Parameter Group C [Encoder related setting]

Page	Name	Standard Value	Unit	Display Range	Reference page	Level
00	Position detection system choice	00:_Absolute	--	00~01	5-26	Ad
01	Motor Incremental Encoder, Digital Filter	01:_220nsec	—	00~07	5-26	Ad
02	External Incremental Encoder, Digital Filter	01:_220nsec	—	00~07	5-26	Ad
03	External Encoder Polarity Invert	00:_Type1	—	00~07	5-26	Ad
04	Encoder Pulse Divided Output, Selection	00:_Motor_Enc.	—	00~01	5-27	Ad
05	Encoder Output Pulse, Divide Ratio	1/1	—	1/8192~1/1	5-27	Ba
06	Encoder Pulse Divided output, Polarity	00:_Type1	—	00~03	5-27	Ad
07	Encoder Signal Output (PS), Format	00:_Binary	—	00~02	5-27	Ad
08	Abbsolute Encoder Clear Function Selection	00:_Status_MultiTurn	—	00~01	5-27	Ad

5. Parameter

[Parameter List]

■ General Parameter [Digital operator basic mode]

Page	Name	Group and Page	Standard Value	Display Range	Reference page
00	Setup Software, Communication Axis Number	GroupA 20	01:_#1	01~0F	5-22
01	Setup Software, Communication Baud Rate	GroupA 21	05:_38400bps	00~05	5-22
02	Tuning Mode	Group0 00	00:_AutoTun	00~02	5-7
03	Automatic Tuning Response	Group0 02	5	1~30	5-7
04	Position Command Filter [ms]	Group1 01	0.0	0.0~2000.0	5-7
05	Electric Gear Ratio 1	Group8 15	1/1	1/32767~32767/1	5-14
06	In-Position Window [pulse]	Group8 41	100	1~65535	5-17
07	Positive Over-Travel Function	Group9 00	0D:_CONT6_OFF	00~27	5-18,19
08	Negative Over-Travel Function	Group9 01	0B:_CONT5_OFF		5-18,19
09	Alarm Reset Function	Group9 02	10:_CONT8_ON		5-18,19
0A	Absolute Encoder Clear Function	Group9 03	06:_CONT3_ON		5-18,19
0B	Deviation Clear Function	Group9 04	08:_CONT4_ON		5-18,19
0C	SERVO-ON Function	Group9 05	02:_CONT1_ON		5-18,19
0D	Torque Limit, Input Selection	Group9 32	0E:_CONT7_ON		5-18,19
0E	JOG Velocity Command	GroupB 00	50		0~32767
0F	Encoder Output Pulse, Divide Ratio	GroupC 05	1/1	1/8192~1/1	5-27
10	Analog Velocity Command Offset	----	0	-9999~9999	---

■ System parameter [for Setup software - R-Setup]

Page	Name	Display Range	Reference page
00	Main Power, Input Type	2 ways (depending on the hardware type)	5-28
01	Motor Encoder Type	2 ways (depending on the hardware type)	5-28
02	Incremental Encoder, Function Setting	2 ways (depending on the hardware type)	5-28
03	Incremental Encoder, Resolution Setting	500P/R ~ 65535P/R	5-28
04	Absolute Encoder, Function Setting	4 ways (depending on the hardware type)	5-28
05	Absolute Encoder, Resolution Setting	11 ways	5-28
06	Motor Type	—	5-29
08	Control Mode	6 ways	5-29
09	Position Loop Control and Position Loop Encoder Selection	2ways (depending on the hardware type)	5-29
0A	External Encoder, Resolution Setting	500P/R ~ 65535P/R	5-29
0B	Regenerative Resistor Selection	3ways	5-29

■ System parameter [for digital operator]

Page	Name	Display Range	Reference page
00	Main Power, Input Type	2 ways (depending on the hardware type)	5-28
01	Motor Encoder Type	2ways (depending on the hardware type)	5-28
02	Incremental Encoder, Function Setting	2ways (depending on the hardware type)	5-28
03	Incremental Encoder, Resolution Setting	500P/R ~ 65535P/R	5-28
04	Absolute Encoder, Function Setting	4ways (depending on the hardware type)	5-28
05	Absolute Encoder, Resolution Setting	11 ways	5-28
06	Information of Servo Amplifier	[for maker maintenance]	5-29
07	Servo Motor Code	—	5-29
08	Control Mode	6ways	5-29
09	Position Loop Control and Position Loop Encoder Selection	2ways (depending on the hardware type)	5-29
0A	External Encoder, Resolution Setting	500P/R ~ 65535P/R	5-29
0B	Regenerative Resistor Selection	3ways	5-29

5. Parameter [Parameter setting value【Group0】 【Group1】]

■ General parameter Group 0 [Auto-tuning settings]

Page	Contents																		
00	Tuning mode [TUNMODE]																		
	<table border="1"> <thead> <tr> <th>Setting range</th> <th>Unit</th> <th>Standard value</th> </tr> </thead> <tbody> <tr> <td>00~02</td> <td>—</td> <td>00:_AutoTun</td> </tr> </tbody> </table>	Setting range	Unit	Standard value	00~02	—	00:_AutoTun	<table border="1"> <thead> <tr> <th>Selection</th> <th>Contents</th> </tr> </thead> <tbody> <tr> <td>00:_AutoTun</td> <td>Automatic Tuning</td> </tr> <tr> <td>01:_AutoTun_JRAT-Fix</td> <td>Automatic Tuning (JRAT Fixed)</td> </tr> <tr> <td>02:_ManualTun</td> <td>Manual Tuning</td> </tr> </tbody> </table>	Selection	Contents	00:_AutoTun	Automatic Tuning	01:_AutoTun_JRAT-Fix	Automatic Tuning (JRAT Fixed)	02:_ManualTun	Manual Tuning			
Setting range	Unit	Standard value																	
00~02	—	00:_AutoTun																	
Selection	Contents																		
00:_AutoTun	Automatic Tuning																		
01:_AutoTun_JRAT-Fix	Automatic Tuning (JRAT Fixed)																		
02:_ManualTun	Manual Tuning																		
01	Automatic Tuning Characteristic [ATCHA]																		
	<table border="1"> <thead> <tr> <th>Setting range</th> <th>Unit</th> <th>Standard value</th> </tr> </thead> <tbody> <tr> <td>00~04</td> <td>—</td> <td>00:_Positioning1</td> </tr> </tbody> </table>	Setting range	Unit	Standard value	00~04	—	00:_Positioning1	<table border="1"> <thead> <tr> <th>Selection</th> <th>Contents</th> </tr> </thead> <tbody> <tr> <td>00:_Positioning1</td> <td>Positioning Control 1</td> </tr> <tr> <td>01:_Positioning2</td> <td>Positioning Control 2</td> </tr> <tr> <td>02:_Positioning3</td> <td>Positioning Control 3</td> </tr> <tr> <td>03:_Trajectory1</td> <td>Trajectory Control</td> </tr> <tr> <td>04:_Trajectory2</td> <td>Trajectory Control (KP Fixed)</td> </tr> </tbody> </table>	Selection	Contents	00:_Positioning1	Positioning Control 1	01:_Positioning2	Positioning Control 2	02:_Positioning3	Positioning Control 3	03:_Trajectory1	Trajectory Control	04:_Trajectory2
Setting range	Unit	Standard value																	
00~04	—	00:_Positioning1																	
Selection	Contents																		
00:_Positioning1	Positioning Control 1																		
01:_Positioning2	Positioning Control 2																		
02:_Positioning3	Positioning Control 3																		
03:_Trajectory1	Trajectory Control																		
04:_Trajectory2	Trajectory Control (KP Fixed)																		
02	Automatic Tuning Response [ATRES]																		
	<table border="1"> <thead> <tr> <th>Setting range</th> <th>Unit</th> <th>Standard value</th> </tr> </thead> <tbody> <tr> <td>1~30</td> <td>—</td> <td>5</td> </tr> </tbody> </table>	Setting range	Unit	Standard value	1~30	—	5	Sets the auto-tuning response. The larger the set value, the higher the response. Make the setting suitable for rigidity of the device.											
Setting range	Unit	Standard value																	
1~30	—	5																	
03	Automatic Tuning, Automatic Parameter Saving [ATSAVE]																		
	<table border="1"> <thead> <tr> <th>Setting range</th> <th>Unit</th> <th>Standard value</th> </tr> </thead> <tbody> <tr> <td>00~01</td> <td>—</td> <td>00:_Auto_Saving</td> </tr> </tbody> </table>	Setting range	Unit	Standard value	00~01	—	00:_Auto_Saving	<p>The parameter (JRAT) obtained from auto-tuning result is automatically saved.</p> <table border="1"> <thead> <tr> <th>Selection</th> <th>Contents</th> </tr> </thead> <tbody> <tr> <td>00:_Auto_Saving</td> <td>Saves Parameter Automatically in JRAT1.</td> </tr> <tr> <td>01:_No_Saving</td> <td>Automatic Saving is Invalidity</td> </tr> </tbody> </table>	Selection	Contents	00:_Auto_Saving	Saves Parameter Automatically in JRAT1.	01:_No_Saving	Automatic Saving is Invalidity					
Setting range	Unit	Standard value																	
00~01	—	00:_Auto_Saving																	
Selection	Contents																		
00:_Auto_Saving	Saves Parameter Automatically in JRAT1.																		
01:_No_Saving	Automatic Saving is Invalidity																		
10	Automatic Notch Filter Tuning, Torque Command [ANFILTC]																		
	<table border="1"> <thead> <tr> <th>Setting range</th> <th>Unit</th> <th>Standard value</th> </tr> </thead> <tbody> <tr> <td>10~100</td> <td>%</td> <td>50</td> </tr> </tbody> </table>	Setting range	Unit	Standard value	10~100	%	50	Sets the torque command value applied to the motor at the time of auto-notch filter tuning. Larger value makes the tuning more accurate; however, note that it also makes the move of the machine larger.											
Setting range	Unit	Standard value																	
10~100	%	50																	
20	Automatic Vibration Suppressor Frequency Tuning, Torque Command [ASUPTC]																		
	<table border="1"> <thead> <tr> <th>Setting range</th> <th>Unit</th> <th>Standard value</th> </tr> </thead> <tbody> <tr> <td>10~100</td> <td>%</td> <td>25</td> </tr> </tbody> </table>	Setting range	Unit	Standard value	10~100	%	25	Sets the torque command value applied to the motor at the time of auto-vibration suppressing frequency tuning. Larger value makes the tuning more accurate, however, note that it also makes the move of the machine larger.											
Setting range	Unit	Standard value																	
10~100	%	25																	
21	Automatic Vibration Suppressor Frequency Tuning, Friction Compensation Value [ASUPFC]																		
	<table border="1"> <thead> <tr> <th>Setting range</th> <th>Unit</th> <th>Standard value</th> </tr> </thead> <tbody> <tr> <td>0~50</td> <td>%</td> <td>5</td> </tr> </tbody> </table>	Setting range	Unit	Standard value	0~50	%	5	Sets the friction torque compensation added to the motor torque at the time of auto-vibration suppressing frequency tuning. Set this value close to actual friction torque, and vibration suppressing frequency tuning will be more accurate.											
Setting range	Unit	Standard value																	
0~50	%	5																	

■ General parameter Group 1 [Basic control parameter setting]

Page	Contents						
01	Position command filter [PCFIL]						
	<table border="1"> <thead> <tr> <th>Setting range</th> <th>Unit</th> <th>Standard value</th> </tr> </thead> <tbody> <tr> <td>0.0~2000.0</td> <td>ms</td> <td>0.0</td> </tr> </tbody> </table>	Setting range	Unit	Standard value	0.0~2000.0	ms	0.0
Setting range	Unit	Standard value					
0.0~2000.0	ms	0.0					
02	Position Loop Proportional Gain 1 [KP1]						
	<table border="1"> <thead> <tr> <th>Setting range</th> <th>Unit</th> <th>Standard value</th> </tr> </thead> <tbody> <tr> <td>1~3000</td> <td>1/s</td> <td>30</td> </tr> </tbody> </table>	Setting range	Unit	Standard value	1~3000	1/s	30
Setting range	Unit	Standard value					
1~3000	1/s	30					
03	Position Loop Integral Time Constant 1 [TPI1]						
	<table border="1"> <thead> <tr> <th>Setting range</th> <th>Unit</th> <th>Standard value</th> </tr> </thead> <tbody> <tr> <td>0.5~1000.0</td> <td>ms</td> <td>1000.0</td> </tr> </tbody> </table>	Setting range	Unit	Standard value	0.5~1000.0	ms	1000.0
Setting range	Unit	Standard value					
0.5~1000.0	ms	1000.0					

5. Parameter

[Parameter setting value [Group1]]

Page	Contents		
04	Higher Tracking Control, Position Compensation Gain [TRCPGN]		
	Setting range	Unit	Standard value
	0~100	%	0
05	Feed Forward Gain [FFGN]		
	Setting range	Unit	Standard value
	0~100	%	0
08	Feed Forward Filter [FFFIL]		
	Setting range	Unit	Standard value
	1~2000	Hz	2000
10	Velocity Command Filter [VCFIL]		
	Setting range	Unit	Standard value
	1~2000	Hz	2000
12	Velocity Feedback Filter [VDFIL]		
	Setting range	Unit	Standard value
	1~2000	Hz	1500
13	Velocity Loop Proportional Gain 1 [KVP1]		
	Setting range	Unit	Standard value
	1~2000	Hz	50
14	Velocity Loop Integral Time Constant 1 [TVI1]		
	Setting range	Unit	Standard value
	0.5~1000.0	ms	20.0
15	Load Inertia Ratio (Load Mass Ratio) 1 [JRAT1]		
	Setting range	Unit	Standard value
	0~15000	%	100
16	Higher Tracking Control, Velocity Compensation Gain [TRCVGN]		
	Setting range	Unit	Standard value
	0~100	%	0
17	Acceleration Feedback Gain [AFBK]		
	Setting range	Unit	Standard value
	-100.0~100.0	%	0.0
18	Acceleration Feedback Filter [AFBFIL]		
	Setting range	Unit	Standard value
	1~2000	Hz	500
20	Torque Command Filter 1 [TCFIL1]		
	Setting range	Unit	Standard value
	1~2000	Hz	600
21	Torque Command Filter Order [TCFILOR]		
	Setting range	Unit	Standard value
	1~3	Order	2

5. Parameter

[Parameter setting value【Group2】]

■ General parameter Group 2 [vibration suppressing control / notch filter / disturbance observer settings]

Page	Contents							
00	Vibration Suppressor Frequency 1 [SUPFRQ1]							
	<table border="1"> <thead> <tr> <th>Setting range</th> <th>Unit</th> <th>Standard value</th> </tr> </thead> <tbody> <tr> <td>5~500</td> <td>Hz</td> <td>500</td> </tr> </tbody> </table>	Setting range	Unit	Standard value	5~500	Hz	500	<p>Parameter to set the frequency of restricting vibration. Inside the servo amplifier, vibration suppressing frequency from 5~99Hz is treated by 1HzUnit, and that from 100~500Hz is by 10HzUnit. Even when set by lower unit than these, operations do not change. Vibration suppressing control is disabled with the set value of 500Hz. When auto-frequency tuning is executed, the tuning result is automatically saved in this parameter. Change this while the motor stops.</p>
Setting range	Unit	Standard value						
5~500	Hz	500						
01	Vibration Suppressor Level Selection [SUPLV]							
	<table border="1"> <thead> <tr> <th>Setting range</th> <th>Unit</th> <th>Standard value</th> </tr> </thead> <tbody> <tr> <td>00~03</td> <td>—</td> <td>00</td> </tr> </tbody> </table>	Setting range	Unit	Standard value	00~03	—	00	<p>Parameter to set the size of vibration suppressing control effect. The smaller the value is, the greater the effect will be. Change this while the motor stops.</p>
Setting range	Unit	Standard value						
00~03	—	00						
10	Velocity Command,Notch Filter [VCNFIL]							
	<table border="1"> <thead> <tr> <th>Setting range</th> <th>Unit</th> <th>Standard value</th> </tr> </thead> <tbody> <tr> <td>50~500</td> <td>Hz</td> <td>500</td> </tr> </tbody> </table>	Setting range	Unit	Standard value	50~500	Hz	500	<p>Parameter to set notch filter to velocity command. Sets the center frequency. Inside the servo amplifier, the center frequency from 50~99Hz is treated by 1HzUnit and that from 100~500Hz is by 10HzUnit. Even when set by lower unit than these, operations do not change. Filter is disabled with the set value of 500Hz.</p>
Setting range	Unit	Standard value						
50~500	Hz	500						
20	Torque Command,Notch Filter A [TCNFILA]							
	<table border="1"> <thead> <tr> <th>Setting range</th> <th>Unit</th> <th>Standard value</th> </tr> </thead> <tbody> <tr> <td>100~2000</td> <td>Hz</td> <td>2000</td> </tr> </tbody> </table>	Setting range	Unit	Standard value	100~2000	Hz	2000	<p>Parameter to set notch filter to torque command. Sets the center frequency. Inside the servo amplifier, the center frequency is treated by 10HzUnit. Even when set by lower unit than 1HzUnit, operations do not change. Filter is disabled with the set value of 2000Hz. When auto-notch filter tuning is executed, the tuning result is automatically saved in this parameter.</p>
Setting range	Unit	Standard value						
100~2000	Hz	2000						
21	TCNFILA, Low Frequency Phase Delay Improvement [TCNFPA]							
	<table border="1"> <thead> <tr> <th>Setting range</th> <th>Unit</th> <th>Standard value</th> </tr> </thead> <tbody> <tr> <td>00~02</td> <td>—</td> <td>00</td> </tr> </tbody> </table>	Setting range	Unit	Standard value	00~02	—	00	<p>Parameter to improve phase delay at lower frequency than center frequency of torque command notch filter A. The larger the value is, the greater the effect is. Same characteristics as the standard notch filter with the set value of 0.</p>
Setting range	Unit	Standard value						
00~02	—	00						
22	Torque Command,Notch Filter B [TCNFILB]							
	<table border="1"> <thead> <tr> <th>Setting range</th> <th>Unit</th> <th>Standard value</th> </tr> </thead> <tbody> <tr> <td>100~2000</td> <td>Hz</td> <td>2000</td> </tr> </tbody> </table>	Setting range	Unit	Standard value	100~2000	Hz	2000	<p>Parameter to set notch filter to torque command. Sets the center frequency. Inside the servo amplifier, the center frequency is treated by 10HzUnit. Even when set by 1HzUnit, operations do not change. Filter is disabled with the set value of 2000Hz.</p>
Setting range	Unit	Standard value						
100~2000	Hz	2000						
23	TCNFILB, Depth Selection [TCNFDB]							
	<table border="1"> <thead> <tr> <th>Setting range</th> <th>Unit</th> <th>Standard value</th> </tr> </thead> <tbody> <tr> <td>00~03</td> <td>—</td> <td>00</td> </tr> </tbody> </table>	Setting range	Unit	Standard value	00~03	—	00	<p>Parameter to set the depth of torque command notch filter B. The larger the value is, the shallower.</p>
Setting range	Unit	Standard value						
00~03	—	00						
24	Torque Command, Notch Filter C [TCNFILC]							
	<table border="1"> <thead> <tr> <th>Setting range</th> <th>Unit</th> <th>Standard value</th> </tr> </thead> <tbody> <tr> <td>100~2000</td> <td>Hz</td> <td>2000</td> </tr> </tbody> </table>	Setting range	Unit	Standard value	100~2000	Hz	2000	<p>Parameter to set notch filter to torque command. Sets the center frequency. Inside the servo amplifier, the center frequency is treated by 10HzUnit. Even when set by 1HzUnit, operations do not change. Filter is disabled with the set value of 2000Hz.</p>
Setting range	Unit	Standard value						
100~2000	Hz	2000						
25	TCNFILC, Depth Selection [TCNFDC]							
	<table border="1"> <thead> <tr> <th>Setting range</th> <th>Unit</th> <th>Standard value</th> </tr> </thead> <tbody> <tr> <td>00~03</td> <td>—</td> <td>00</td> </tr> </tbody> </table>	Setting range	Unit	Standard value	00~03	—	00	<p>Parameter to set the depth of torque command notch filter C. The larger the value is, the shallower.</p>
Setting range	Unit	Standard value						
00~03	—	00						
26	Torque Command,Notch Filter D [TCNFILD]							
	<table border="1"> <thead> <tr> <th>Setting range</th> <th>Unit</th> <th>Standard value</th> </tr> </thead> <tbody> <tr> <td>100~2000</td> <td>Hz</td> <td>2000</td> </tr> </tbody> </table>	Setting range	Unit	Standard value	100~2000	Hz	2000	<p>Parameter to set notch filter to torque command. Sets the center frequency. Inside the servo amplifier, the center frequency is treated by 10HzUnit. Even when set by 1HzUnit, operations do not change. Filter is disabled with the set value of 2000Hz.</p>
Setting range	Unit	Standard value						
100~2000	Hz	2000						

5. Parameter

[Parameter setting value【Group2】 【Group3】]

Page	Contents		
27	TCNFILd, Depth Selection [TCNFDD]		
	Setting range	Unit	Standard value
	00~03	—	00
Parameter to set the depth of torque command notch filter D. The greater the value is, the shallower the depth will be.			
30	Observer characteristic [OBCHA]		
	Setting range	Unit	Standard value
	00~01	—	00:_Low
Selects the observer characteristics.			
	Selection	Contents	
	00:_Low	For Low Cycle	
	01:_Middle	For Middle Cycle	
31	Observer Compensation Gain [OBG]		
	Setting range	Unit	Standard value
	0~100	%	0
Observer compensation gain. The larger the value is, the higher the suppression characteristics will be. However, if this is too large, oscillation may sometimes occur.			
32	Observer Output, Low Pass Filter [OBLPF]		
	Setting range	Unit	Standard value
	1~2000	Hz	50
Sets the cut off frequency of observer output low pass filter. Filter is disabled with the set value of 2000Hz. When the observer characteristics are "01: Middle (For Middle Cycle)", the function is disabled.			
33	Observer Output, Notch Filter [OBNFIL]		
	Setting range	Unit	Standard value
	100~2000	Hz	2000
Sets the center frequency of observer output notch filter. Inside the servo amplifier, the center frequency is treated by 10HzUnit. Even when set by 1HzUnit, operations do not change. Filter is disabled with the set value of 2000Hz.			

■ General parameter Group 3 [Gain switching control / vibration suppressing frequency switching settings]

Page	Contents		
00	Position Loop Proportional Gain 2 [KP2]		
	Setting range	Unit	Standard value
	1~3000	1/s	30
Proportional gain for position controller.			
01	Position Loop Integral Time Constant 2 [TPI2]		
	Setting range	Unit	Standard value
	0.5~1000.0	ms	1000.0
Integral time constant for position controller. Integral term is disabled (proportional control) with the set value of 1000.0ms.			
 Cannot be used when the position loop proportional control switching function is enabled.			
02	Velocity Loop Proportional Gain 2 [KVP2]		
	Setting range	Unit	Standard value
	1~2000	Hz	50
Proportional gain for velocity controller. When load inertia is the one set by load inertia moment ratio (load mass ratio) 2, the response is this set value.			
03	Velocity Loop Integral Time Constant 2 [TVI2]		
	Setting range	Unit	Standard value
	0.5~1000.0	ms	20.0
Integral time constant for velocity controller. Enabled when velocity loop proportional control switching function is disabled. Integral term is disabled (proportional control) with the set value of 1000.0ms.			
04	Load Inertia Ratio (Load Mass Ratio) 2 [JRAT2]		
	Setting range	Unit	Standard value
	0~15000	%	100
Sets the inertia moment of load device to the motor inertia moment. Set value=JL/JM × 100% JL : Load inertia moment JM : Motor inertia moment			
05	Torque Command Filter 2 [TCFIL2]		
	Setting range	Unit	Standard value
	1~2000	Hz	600
Parameter to set low pass filter to torque command. Sets the cut off frequency.			

5. Parameter

[Parameter setting value【Group3】]

Page	Contents		
10	Position Loop Proportional Gain 3 [KP3]		
	Setting range	Unit	Standard value
	1~3000	1/s	30
	Proportional gain for position controller.		
11	Position Loop Integral Time Constant 3 [TPI3]		
	Setting range	Unit	Standard value
	0.5~1000.0	ms	1000.0
	Integral time constant for position controller. Integral term is disabled (proportional control) with the set value of 1000.0ms.		
	✎ Cannot be used when position loop proportional control switching function is enabled.		
12	Velocity Loop Proportional Gain 3 [KVP3]		
	Setting range	Unit	Standard value
	1~2000	Hz	50
	Proportional gain for velocity controller. When load inertia is the one set by load inertia moment ratio (load mass ratio) 2, the response is this set value.		
13	Velocity Loop Integral Time Constant 3 [TVI3]		
	Setting range	Unit	Standard value
	0.5~1000.0	ms	20.0
	Integral time constant for velocity controller. This setting is enabled when velocity loop proportional control switching function is disabled. Integral term is disabled (proportional control) with the set value of 1000.0ms.		
14	Load Inertia Ratio (Load Mass Ratio) 3 [JRAT3]		
	Setting range	Unit	Standard value
	0~15000	%	100
	Sets the inertia moment of load device to the motor inertia moment. Set value=JL/JM × 100% JL : Load inertia moment JM : Motor inertia moment		
15	Torque Command Filter 3 [TCFIL3]		
	Setting range	Unit	Standard value
	1~2000	%	600
	Parameter to set low pass filter to torque command. Sets the cut off frequency.		
20	Position Loop Proportional Gain 4 [KP4]		
	Setting range	Unit	Standard value
	1~3000	1/s	30
	Proportional gain for position controller.		
21	Position Loop Integral Time Constant 4 [TPI4]		
	Setting range	Unit	Standard value
	0.5~1000.0	ms	1000.0
	Integral time constant for position controller. Integral term is disabled (proportional control) with the set value of 1000.0ms.		
	✎ Cannot be used when position loop proportional control switching function is enabled.		
22	Velocity Loop Proportional Gain 4 [KVP4]		
	Setting range	Unit	Standard value
	1~2000	Hz	50
	Proportional gain for velocity controller. When load inertia is the one set by load inertia moment ratio (load mass ratio) 2, the response is this set value.		
23	Velocity Loop Integral Time Constant 4 [TVI4]		
	Setting range	Unit	Standard value
	0.5~1000.0	ms	20.0
	Integral time constant for velocity controller. This setting is enabled when velocity loop proportional control switching function is disabled. Integral term is disabled (proportional control) with the set value of 1000.0ms.		
24	Load Inertia Ratio (Load Mass Ratio) 4 [JRAT4]		
	Setting range	Unit	Standard value
	0~15000	%	100
	Sets the inertia moment of load device to the motor inertia moment. Set value=JL/JM × 100% JL : Load inertia moment JM : Motor inertia moment		
25	Torque Command Filter 4 [TCFIL4]		
	Setting range	Unit	Standard value
	1~2000	%	600
	Parameter to set low pass filter to torque command. Sets the cut off frequency.		
30	Low Pass Filter of Gain Switching [GCFIL]		
	Setting range	Unit	Standard value
	0~100	ms	0
	Parameter to set time constant for gain switching. The larger the value is, the gentler the switching is.		

5. Parameter

[Parameter setting value【Group3】 【Group4】]

Page	Contents						
40	Vibration Suppressor Frequency 2 [SUPFRQ2]						
	<table border="1"> <thead> <tr> <th>Setting range</th> <th>Unit</th> <th>Standard value</th> </tr> </thead> <tbody> <tr> <td>5~500</td> <td>Hz</td> <td>500</td> </tr> </tbody> </table>	Setting range	Unit	Standard value	5~500	Hz	500
Setting range	Unit	Standard value					
5~500	Hz	500					
41	Vibration Suppressor Frequency 3 [SUPFRQ3]						
	<table border="1"> <thead> <tr> <th>Setting range</th> <th>Unit</th> <th>Standard value</th> </tr> </thead> <tbody> <tr> <td>5~500</td> <td>Hz</td> <td>500</td> </tr> </tbody> </table>	Setting range	Unit	Standard value	5~500	Hz	500
Setting range	Unit	Standard value					
5~500	Hz	500					
42	Vibration Suppressor Frequency 4 [SUPFRQ4]						
	<table border="1"> <thead> <tr> <th>Setting range</th> <th>Unit</th> <th>Standard value</th> </tr> </thead> <tbody> <tr> <td>5~500</td> <td>Hz</td> <td>500</td> </tr> </tbody> </table>	Setting range	Unit	Standard value	5~500	Hz	500
Setting range	Unit	Standard value					
5~500	Hz	500					



■ General parameter Group 4 [High setting control settings]

Page	Contents						
00	Command Velocity, Low Pass Filter [CVFIL]						
	<table border="1"> <thead> <tr> <th>Setting range</th> <th>Unit</th> <th>Standard value</th> </tr> </thead> <tbody> <tr> <td>1~2000</td> <td>Hz</td> <td>1000</td> </tr> </tbody> </table>	Setting range	Unit	Standard value	1~2000	Hz	1000
Setting range	Unit	Standard value					
1~2000	Hz	1000					
01	Command Velocity Threshold [CVTH]						
	<table border="1"> <thead> <tr> <th>Setting range</th> <th>Unit</th> <th>Standard value</th> </tr> </thead> <tbody> <tr> <td>0~65535</td> <td>min⁻¹</td> <td>20</td> </tr> </tbody> </table>	Setting range	Unit	Standard value	0~65535	min ⁻¹	20
Setting range	Unit	Standard value					
0~65535	min ⁻¹	20					
02	Acceleration Compensation [ACCCO]						
	<table border="1"> <thead> <tr> <th>Setting range</th> <th>Unit</th> <th>Standard value</th> </tr> </thead> <tbody> <tr> <td>-9999~+9999</td> <td>× 50 Pulse</td> <td>0</td> </tr> </tbody> </table>	Setting range	Unit	Standard value	-9999~+9999	× 50 Pulse	0
Setting range	Unit	Standard value					
-9999~+9999	× 50 Pulse	0					
03	Deceleration Compensation [DECCO]						
	<table border="1"> <thead> <tr> <th>Setting range</th> <th>Unit</th> <th>Standard value</th> </tr> </thead> <tbody> <tr> <td>-9999~+9999</td> <td>× 50 Pulse</td> <td>0</td> </tr> </tbody> </table>	Setting range	Unit	Standard value	-9999~+9999	× 50 Pulse	0
Setting range	Unit	Standard value					
-9999~+9999	× 50 Pulse	0					

5. Parameter

[Parameter setting value【Group8】]

■ General parameter Group 8 [Settings for control system]

Page	Contents																																		
00	Command Input Polarity [CMDPOL]																																		
	<table border="1"> <thead> <tr> <th>Setting range</th> <th>Unit</th> <th>Standard value</th> </tr> </thead> <tbody> <tr> <td>00~07</td> <td>—</td> <td>00:_PC+_VC+_TC+</td> </tr> </tbody> </table>	Setting range	Unit	Standard value	00~07	—	00:_PC+_VC+_TC+	Select the command polarity from the contents blow.																											
	Setting range	Unit	Standard value																																
	00~07	—	00:_PC+_VC+_TC+																																
	<table border="1"> <thead> <tr> <th>Input command</th> <th>Command polarity</th> <th>Rotation direction</th> <th>Selection</th> </tr> </thead> <tbody> <tr> <td>position command</td> <td>+</td> <td>Forward</td> <td rowspan="4">00:_PC+_VC+_TC+</td> </tr> <tr> <td>Velocity command</td> <td>+</td> <td>Forward</td> </tr> <tr> <td>Torque command</td> <td>+</td> <td>Forward</td> </tr> <tr> <td></td> <td></td> <td></td> </tr> </tbody> </table>	Input command	Command polarity	Rotation direction	Selection	position command	+	Forward	00:_PC+_VC+_TC+	Velocity command	+	Forward	Torque command	+	Forward				<table border="1"> <thead> <tr> <th>Input command</th> <th>Command polarity</th> <th>Rotation direction</th> <th>Selection</th> </tr> </thead> <tbody> <tr> <td>Position command</td> <td>+</td> <td>Reverse</td> <td rowspan="4">04:_PC-_VC+_TC+</td> </tr> <tr> <td>Velocity command</td> <td>+</td> <td>Forward</td> </tr> <tr> <td>Torque command</td> <td>+</td> <td>Forward</td> </tr> <tr> <td></td> <td></td> <td></td> </tr> </tbody> </table>	Input command	Command polarity	Rotation direction	Selection	Position command	+	Reverse	04:_PC-_VC+_TC+	Velocity command	+	Forward	Torque command	+	Forward		
Input command	Command polarity	Rotation direction	Selection																																
position command	+	Forward	00:_PC+_VC+_TC+																																
Velocity command	+	Forward																																	
Torque command	+	Forward																																	
Input command	Command polarity	Rotation direction	Selection																																
Position command	+	Reverse	04:_PC-_VC+_TC+																																
Velocity command	+	Forward																																	
Torque command	+	Forward																																	
<table border="1"> <thead> <tr> <th>Input command</th> <th>Command polarity</th> <th>Rotation direction</th> <th>Selection</th> </tr> </thead> <tbody> <tr> <td>position command</td> <td>+</td> <td>Forward</td> <td rowspan="4">01:_PC+_VC+_TC-</td> </tr> <tr> <td>Velocity command</td> <td>+</td> <td>Forward</td> </tr> <tr> <td>torque command</td> <td>+</td> <td>Reverse</td> </tr> <tr> <td></td> <td></td> <td></td> </tr> </tbody> </table>	Input command	Command polarity	Rotation direction	Selection	position command	+	Forward	01:_PC+_VC+_TC-	Velocity command	+	Forward	torque command	+	Reverse				<table border="1"> <thead> <tr> <th>Input command</th> <th>Command polarity</th> <th>Rotation direction</th> <th>Selection</th> </tr> </thead> <tbody> <tr> <td>position command</td> <td>+</td> <td>Reverse</td> <td rowspan="4">05:_PC-_VC+_TC-</td> </tr> <tr> <td>V velocity command</td> <td>+</td> <td>Forward</td> </tr> <tr> <td>Torque command</td> <td>+</td> <td>Reverse</td> </tr> <tr> <td></td> <td></td> <td></td> </tr> </tbody> </table>	Input command	Command polarity	Rotation direction	Selection	position command	+	Reverse	05:_PC-_VC+_TC-	V velocity command	+	Forward	Torque command	+	Reverse			
Input command	Command polarity	Rotation direction	Selection																																
position command	+	Forward	01:_PC+_VC+_TC-																																
Velocity command	+	Forward																																	
torque command	+	Reverse																																	
Input command	Command polarity	Rotation direction	Selection																																
position command	+	Reverse	05:_PC-_VC+_TC-																																
V velocity command	+	Forward																																	
Torque command	+	Reverse																																	
<table border="1"> <thead> <tr> <th>Input command</th> <th>Command polarity</th> <th>Rotation direction</th> <th>Selection</th> </tr> </thead> <tbody> <tr> <td>position command</td> <td>+</td> <td>Forward</td> <td rowspan="4">02:_PC+_VC-_TC+</td> </tr> <tr> <td>Velocity command</td> <td>+</td> <td>Reverse</td> </tr> <tr> <td>Torque command</td> <td>+</td> <td>Forward</td> </tr> <tr> <td></td> <td></td> <td></td> </tr> </tbody> </table>	Input command	Command polarity	Rotation direction	Selection	position command	+	Forward	02:_PC+_VC-_TC+	Velocity command	+	Reverse	Torque command	+	Forward				<table border="1"> <thead> <tr> <th>Input command</th> <th>Command polarity</th> <th>Rotation direction</th> <th>Selection</th> </tr> </thead> <tbody> <tr> <td>position command</td> <td>+</td> <td>Reverse</td> <td rowspan="4">06:_PC-_VC-_TC+</td> </tr> <tr> <td>Velocity command</td> <td>+</td> <td>Reverse</td> </tr> <tr> <td>torque command</td> <td>+</td> <td>Forward</td> </tr> <tr> <td></td> <td></td> <td></td> </tr> </tbody> </table>	Input command	Command polarity	Rotation direction	Selection	position command	+	Reverse	06:_PC-_VC-_TC+	Velocity command	+	Reverse	torque command	+	Forward			
Input command	Command polarity	Rotation direction	Selection																																
position command	+	Forward	02:_PC+_VC-_TC+																																
Velocity command	+	Reverse																																	
Torque command	+	Forward																																	
Input command	Command polarity	Rotation direction	Selection																																
position command	+	Reverse	06:_PC-_VC-_TC+																																
Velocity command	+	Reverse																																	
torque command	+	Forward																																	
<table border="1"> <thead> <tr> <th>Input command</th> <th>Command polarity</th> <th>Rotation direction</th> <th>Selection</th> </tr> </thead> <tbody> <tr> <td>Position command</td> <td>+</td> <td>Forward</td> <td rowspan="4">03:_PC+_VC-_TC-</td> </tr> <tr> <td>Velocity command</td> <td>+</td> <td>Reverse</td> </tr> <tr> <td>Torque command</td> <td>+</td> <td>Reverse</td> </tr> <tr> <td></td> <td></td> <td></td> </tr> </tbody> </table>	Input command	Command polarity	Rotation direction	Selection	Position command	+	Forward	03:_PC+_VC-_TC-	Velocity command	+	Reverse	Torque command	+	Reverse				<table border="1"> <thead> <tr> <th>Input command</th> <th>Command polarity</th> <th>Rotation direction</th> <th>Selection</th> </tr> </thead> <tbody> <tr> <td>position command</td> <td>+</td> <td>Reverse</td> <td rowspan="4">07:_PC-_VC-_TC-</td> </tr> <tr> <td>Velocity command</td> <td>+</td> <td>Reverse</td> </tr> <tr> <td>torque command</td> <td>+</td> <td>Reverse</td> </tr> <tr> <td></td> <td></td> <td></td> </tr> </tbody> </table>	Input command	Command polarity	Rotation direction	Selection	position command	+	Reverse	07:_PC-_VC-_TC-	Velocity command	+	Reverse	torque command	+	Reverse			
Input command	Command polarity	Rotation direction	Selection																																
Position command	+	Forward	03:_PC+_VC-_TC-																																
Velocity command	+	Reverse																																	
Torque command	+	Reverse																																	
Input command	Command polarity	Rotation direction	Selection																																
position command	+	Reverse	07:_PC-_VC-_TC-																																
Velocity command	+	Reverse																																	
torque command	+	Reverse																																	
01	Analog Input Dead Band [VC/TC-DB]																																		
	<table border="1"> <thead> <tr> <th>Setting range</th> <th>Unit</th> <th>Standard value</th> </tr> </thead> <tbody> <tr> <td>00~01</td> <td>—</td> <td>00:_Disabled</td> </tr> </tbody> </table>	Setting range	Unit	Standard value	00~01	—	00:_Disabled	Select enabled/disabled of analog input dead zone. <table border="1"> <thead> <tr> <th>Selection</th> <th>Contents</th> </tr> </thead> <tbody> <tr> <td>00:_Disabled</td> <td>Disabled</td> </tr> <tr> <td>01:_Enabled</td> <td>Enabled</td> </tr> </tbody> </table>	Selection	Contents	00:_Disabled	Disabled	01:_Enabled	Enabled																					
Setting range	Unit	Standard value																																	
00~01	—	00:_Disabled																																	
Selection	Contents																																		
00:_Disabled	Disabled																																		
01:_Enabled	Enabled																																		
11	Position Command Pulse, Form Selection [PCPTYP]																																		
	<table border="1"> <thead> <tr> <th>Setting range</th> <th>Unit</th> <th>Standard value</th> </tr> </thead> <tbody> <tr> <td>00~02</td> <td>—</td> <td>00:_F-PC_R-PC</td> </tr> </tbody> </table>	Setting range	Unit	Standard value	00~02	—	00:_F-PC_R-PC	Select the position command pulse type from the contents below. <table border="1"> <thead> <tr> <th>Selection</th> <th>Contents</th> </tr> </thead> <tbody> <tr> <td>00:_F-PC_R-PC</td> <td>Positive Move Pulse + Negative Move Pulse</td> </tr> <tr> <td>01:_2PhasePuls e</td> <td>Two-Phase Pulse Train of 90 Degrees Phase Difference</td> </tr> <tr> <td>02:_CODE_PC</td> <td>Code + Pulse Train</td> </tr> </tbody> </table> <p> The set value is enabled after control power is turned ON again.</p>	Selection	Contents	00:_F-PC_R-PC	Positive Move Pulse + Negative Move Pulse	01:_2PhasePuls e	Two-Phase Pulse Train of 90 Degrees Phase Difference	02:_CODE_PC	Code + Pulse Train																			
Setting range	Unit	Standard value																																	
00~02	—	00:_F-PC_R-PC																																	
Selection	Contents																																		
00:_F-PC_R-PC	Positive Move Pulse + Negative Move Pulse																																		
01:_2PhasePuls e	Two-Phase Pulse Train of 90 Degrees Phase Difference																																		
02:_CODE_PC	Code + Pulse Train																																		
12	Position Command Pulse, Count Polarity [PCPPOL]																																		
	<table border="1"> <thead> <tr> <th>Setting range</th> <th>Unit</th> <th>Standard value</th> </tr> </thead> <tbody> <tr> <td>00~03</td> <td>—</td> <td>00:_Type1</td> </tr> </tbody> </table>	Setting range	Unit	Standard value	00~03	—	00:_Type1	Select the position command pulse count polarity from the contents below.																											
Setting range	Unit	Standard value																																	
00~03	—	00:_Type1																																	
	<table border="1"> <thead> <tr> <th>Selection</th> <th>Contents</th> </tr> </thead> <tbody> <tr> <td>00:_Type1</td> <td>F-PC/ Count at the Rising Edge : R-PC/ Count at the Rising Edge</td> </tr> <tr> <td>01:_Type2</td> <td>F-PC/ Count at the Falling Edge : R-PC/ Count at the Rising Edge</td> </tr> <tr> <td>02:_Type3</td> <td>F-PC/ Count at the Rising Edge : R-PC/ Count at the Falling Edge</td> </tr> <tr> <td>03:_Type4</td> <td>F-PC/ Count at the Falling Edge : R-PC/ Count at the Falling Edge</td> </tr> </tbody> </table> <p> The set value is enabled after control power is turned ON again.</p>	Selection	Contents	00:_Type1	F-PC/ Count at the Rising Edge : R-PC/ Count at the Rising Edge	01:_Type2	F-PC/ Count at the Falling Edge : R-PC/ Count at the Rising Edge	02:_Type3	F-PC/ Count at the Rising Edge : R-PC/ Count at the Falling Edge	03:_Type4	F-PC/ Count at the Falling Edge : R-PC/ Count at the Falling Edge																								
Selection	Contents																																		
00:_Type1	F-PC/ Count at the Rising Edge : R-PC/ Count at the Rising Edge																																		
01:_Type2	F-PC/ Count at the Falling Edge : R-PC/ Count at the Rising Edge																																		
02:_Type3	F-PC/ Count at the Rising Edge : R-PC/ Count at the Falling Edge																																		
03:_Type4	F-PC/ Count at the Falling Edge : R-PC/ Count at the Falling Edge																																		

5. Parameter

[Parameter setting value【Group8】]

Page	Contents																	
13	Position Command Pulse, Digital Filter [PCPFIL]																	
	<table border="1"> <thead> <tr> <th>Setting range</th> <th>Unit</th> <th>Standard value</th> </tr> </thead> <tbody> <tr> <td>00~07</td> <td>—</td> <td>00:_834nsec</td> </tr> </tbody> </table>	Setting range	Unit	Standard value	00~07	—	00:_834nsec	Select the setting of position command pulse digital filter from the contents below. As timing for command direction, observe the specifications of position command. When the pulse command form is "Two-Phase Pulse Train of 90 Degrees Phase Difference", observe the specifications of position command.										
Setting range	Unit	Standard value																
00~07	—	00:_834nsec																
14	Position Command, Pulse Multiplier [PCPMUL]																	
	<table border="1"> <thead> <tr> <th>Setting range</th> <th>Unit</th> <th>Standard value</th> </tr> </thead> <tbody> <tr> <td>1~63</td> <td>—</td> <td>1</td> </tr> </tbody> </table>	Setting range	Unit	Standard value	1~63	—	1	Parameter to multiply the command pulse by $\times 1 \sim \times 63$. Values from 1 to 63 are set, which are always enabled.										
Setting range	Unit	Standard value																
1~63	—	1																
15	Electric Gear Ratio 1 [GER1]																	
	<table border="1"> <thead> <tr> <th>Setting range</th> <th>Unit</th> <th>Standard value</th> </tr> </thead> <tbody> <tr> <td>1/32767~32767/1</td> <td>—</td> <td>1/1</td> </tr> </tbody> </table>	Setting range	Unit	Standard value	1/32767~32767/1	—	1/1	Setting of electronic gear to position command pulse.										
Setting range	Unit	Standard value																
1/32767~32767/1	—	1/1																
16	Electric Gear Ratio 2 [GER2]																	
	<table border="1"> <thead> <tr> <th>Setting range</th> <th>Unit</th> <th>Standard value</th> </tr> </thead> <tbody> <tr> <td>1/32767~32767/1</td> <td>—</td> <td>1/1</td> </tr> </tbody> </table>	Setting range	Unit	Standard value	1/32767~32767/1	—	1/1	$f1 \rightarrow \frac{N(1 \sim 32767)}{D(1 \sim 32767)} \rightarrow f2 (f2 = f1 \times N/D)$ <div style="display: flex; justify-content: space-around; width: 100%;"> 1/32767 N/D 32767 </div>										
Setting range	Unit	Standard value																
1/32767~32767/1	—	1/1																
17	Positioning method [EDGEPOS]																	
	<table border="1"> <thead> <tr> <th>Setting range</th> <th>Unit</th> <th>Standard value</th> </tr> </thead> <tbody> <tr> <td>00~01</td> <td>—</td> <td>00:_Pulse_Interval</td> </tr> </tbody> </table>	Setting range	Unit	Standard value	00~01	—	00:_Pulse_Interval	Select the encoder pulse positioning from the contents below.										
Setting range	Unit	Standard value																
00~01	—	00:_Pulse_Interval																
18	Inposition / Position Deviation Monitor [PDEVMON]																	
	<table border="1"> <thead> <tr> <th>Setting range</th> <th>Unit</th> <th>Standard value</th> </tr> </thead> <tbody> <tr> <td>00~01</td> <td>—</td> <td>00:_After_Filter</td> </tr> </tbody> </table>	Setting range	Unit	Standard value	00~01	—	00:_After_Filter	Select the positioning complete signal (I N P) and position deviation monitor from the contents below.										
Setting range	Unit	Standard value																
00~01	—	00:_After_Filter																
19	Deviation Clear Selection [CLR]																	
	<table border="1"> <thead> <tr> <th>Setting range</th> <th>Unit</th> <th>Standard value</th> </tr> </thead> <tbody> <tr> <td>00~03</td> <td>—</td> <td>00:_Type1</td> </tr> </tbody> </table>	Setting range	Unit	Standard value	00~03	—	00:_Type1	Select the position deviation clearing method from the contents below.										
Setting range	Unit	Standard value																
00~03	—	00:_Type1																
<table border="1"> <thead> <tr> <th>Selection</th> <th colspan="2">Contents</th> </tr> </thead> <tbody> <tr> <td>00:_Type1</td> <td>When SERVO-OFF/ Clear Deviation : Deviation Clear Input/ Level Detection</td> <td>During servo OFF, deviation clear is always executed. While deviation clear input is ON, deviation clear is always executed.</td> </tr> <tr> <td>01:_Type2</td> <td>When SERVO-OFF/ Clear Deviation : Deviation Clear Input/ Edge Detection</td> <td>At the edge of OFF→ON of deviation clear input, deviation clear is executed.</td> </tr> <tr> <td>02:_Type3</td> <td>When SERVO-OFF/ Not Clear Deviation : Deviation Clear Input/ Level Detection</td> <td>During servo OFF, deviation clear is not executed. (After servo ON, the motor may operate suddenly.)</td> </tr> <tr> <td>03:_Type4</td> <td>When SERVO-OFF/ Not Clear Deviation : Deviation Clear Input/ Edge Detection</td> <td>During servo OFF, deviation clear is not executed. (After servo ON, the motor may operate suddenly.)</td> </tr> </tbody> </table>				Selection	Contents		00:_Type1	When SERVO-OFF/ Clear Deviation : Deviation Clear Input/ Level Detection	During servo OFF, deviation clear is always executed. While deviation clear input is ON, deviation clear is always executed.	01:_Type2	When SERVO-OFF/ Clear Deviation : Deviation Clear Input/ Edge Detection	At the edge of OFF→ON of deviation clear input, deviation clear is executed.	02:_Type3	When SERVO-OFF/ Not Clear Deviation : Deviation Clear Input/ Level Detection	During servo OFF, deviation clear is not executed. (After servo ON, the motor may operate suddenly.)	03:_Type4	When SERVO-OFF/ Not Clear Deviation : Deviation Clear Input/ Edge Detection	During servo OFF, deviation clear is not executed. (After servo ON, the motor may operate suddenly.)
Selection	Contents																	
00:_Type1	When SERVO-OFF/ Clear Deviation : Deviation Clear Input/ Level Detection	During servo OFF, deviation clear is always executed. While deviation clear input is ON, deviation clear is always executed.																
01:_Type2	When SERVO-OFF/ Clear Deviation : Deviation Clear Input/ Edge Detection	At the edge of OFF→ON of deviation clear input, deviation clear is executed.																
02:_Type3	When SERVO-OFF/ Not Clear Deviation : Deviation Clear Input/ Level Detection	During servo OFF, deviation clear is not executed. (After servo ON, the motor may operate suddenly.)																
03:_Type4	When SERVO-OFF/ Not Clear Deviation : Deviation Clear Input/ Edge Detection	During servo OFF, deviation clear is not executed. (After servo ON, the motor may operate suddenly.)																

5. Parameter

[Parameter setting value【Group8】]

Page	Contents		
20	Preset Velocity Command 1 [VC1] Refer to "Chapter 7. Adjustment · Functions Internal velocity command".		
	Setting range	Unit	Standard value
	0~32767	min ⁻¹	100
21	Preset Velocity Command 2 [VC2] Refer to "Chapter 7. Adjustment · Functions Internal velocity command".		
	Setting range	Unit	Standard value
	0~32767	min ⁻¹	200
22	Preset Velocity Command 3 [VC3] Refer to "Chapter 7. Adjustment · Functions Internal velocity command".		
	Setting range	Unit	Standard value
	0~32767	min ⁻¹	300
23	Velocity Compensation Command, Input Selection [VCOMSEL]		
	Setting range	Unit	Standard value
	01~02	—	02:_VCOMP
	Selection	Contents	
	01:_Analog_Input	Apply Analog Velocity Compensation Command	When velocity addition function is valid, analog velocity addition command value is used.
	02:_VCOMP	Apply Preset Velocity Compensation Command	When velocity addition function is valid, internal velocity addition command value id used.
24	Preset Velocity Compensation Command [VCOMP]		
	Setting range	Unit	Standard value
	-9999~+9999	min ⁻¹	0
25	Analog Velocity Command, Reference (Analog Velocity Compensation Command, Ref.) [VCGN]		
	Setting range	Unit	Standard value
	0~4000	min ⁻¹ /V	500
26	Velocity Command, Acceleration Time Constant [TVACC]		
	Setting range	Unit	Standard value
	0~16000	ms	0
27	Velocity Command, Deceleration Time Constant [TVDEC]		
	Setting range	Unit	Standard value
	0~16000	ms	0
28	Velocity Limit [VCLM]		
	Setting range	Unit	Standard value
	1~65535	min ⁻¹	65535
30	Torque Compensation Command, Input Selection [TCOMSEL]		
	Setting range	Unit	Standard value
	01~02	—	02:_TCOMP
	Selection	Contents	
	01:_Analog_Input	When torque addition function is valid, analog torque addition command value is used.	
	02:_TCOMP	When torque addition function is valid, internal torque addition command value is used.	

5. Parameter

[Parameter setting value【Group8】]

Page	Contents																
31	Preset Torque Compensation Command 1 [TCOMP1]																
	<table border="1"> <tr> <th>Setting range</th> <th>Unit</th> <th>Standard value</th> </tr> <tr> <td>-500~+500</td> <td>%</td> <td>0</td> </tr> </table>	Setting range	Unit	Standard value	-500~+500	%	0	Parameter for using torque addition command in a fixed value, when torque addition function is used.									
Setting range	Unit	Standard value															
-500~+500	%	0															
32	Preset Torque Compensation Command 2 [TCOMP2]																
	<table border="1"> <tr> <th>Setting range</th> <th>Unit</th> <th>Standard value</th> </tr> <tr> <td>-500~+500</td> <td>%</td> <td>0</td> </tr> </table>	Setting range	Unit	Standard value	-500~+500	%	0	Parameter for using torque addition command in a fixed value, when torque addition function is used.									
Setting range	Unit	Standard value															
-500~+500	%	0															
33	Analog Torque Command, Reference [TCGN]																
	<table border="1"> <tr> <th>Setting range</th> <th>Unit</th> <th>Standard value</th> </tr> <tr> <td>0~500</td> <td>%V</td> <td>50</td> </tr> </table>	Setting range	Unit	Standard value	0~500	%V	50	Parameter for setting analog torque command scaling.									
Setting range	Unit	Standard value															
0~500	%V	50															
34	Analog Torque Compensation Command, Reference [TCOMPGN]																
	<table border="1"> <tr> <th>Setting range</th> <th>Unit</th> <th>Standard value</th> </tr> <tr> <td>0~500</td> <td>%V</td> <td>50</td> </tr> </table>	Setting range	Unit	Standard value	0~500	%V	50	Parameter for adjusting torque addition command input scaling.									
Setting range	Unit	Standard value															
0~500	%V	50															
35	Torque Limit, Input Selection [TLSEL]																
	<table border="1"> <tr> <th>Setting range</th> <th>Unit</th> <th>Standard value</th> </tr> <tr> <td>00~03</td> <td>—</td> <td>00:_TCLM</td> </tr> </table>	Setting range	Unit	Standard value	00~03	—	00:_TCLM	Select the torque command limiting method from the contents below. The selection of limit is when torque command limit function is valid.									
	Setting range	Unit	Standard value														
	00~03	—	00:_TCLM														
	<table border="1"> <thead> <tr> <th>Selection</th> <th></th> <th>Contents</th> </tr> </thead> <tbody> <tr> <td>00:_TCLM</td> <td>Internal torque limit value (TCLM) is used.</td> <td>Forward side(forward direction) : limited at internal set value. Reverse side (reverse direction) : limited at internal set value.</td> </tr> <tr> <td>01:_Analog_1</td> <td>External torque limit input is used. Forward side/F-TLA, Reverse side/R-TLA(-voltage input)</td> <td>Forward side(forward direction) : limited at + voltage input at F-TLA. Reverse side (reverse direction) : limited at - voltage input at R-TLA.</td> </tr> <tr> <td>02:_Analog_2</td> <td>External torque limit input is used. Forward side/F-TLA, Reverse side/R-TLA(+ voltage input)</td> <td>Forward side (forward direction) : limited at + voltage input at F-TLA. Reverse side (reverse direction) : limited at + voltage input at R-TLA.</td> </tr> <tr> <td>03:_Analog_3</td> <td>External torque limit input is used. Forward side/F-TLA Reverse side/F-TLA</td> <td>Forward (forward direction)side : limited at + voltage input at F-TLA. Reverse (reverse direction)side : limited at + voltage input at F-TLA.</td> </tr> </tbody> </table>	Selection		Contents	00:_TCLM	Internal torque limit value (TCLM) is used.	Forward side(forward direction) : limited at internal set value. Reverse side (reverse direction) : limited at internal set value.	01:_Analog_1	External torque limit input is used. Forward side/F-TLA, Reverse side/R-TLA(-voltage input)	Forward side(forward direction) : limited at + voltage input at F-TLA. Reverse side (reverse direction) : limited at - voltage input at R-TLA.	02:_Analog_2	External torque limit input is used. Forward side/F-TLA, Reverse side/R-TLA(+ voltage input)	Forward side (forward direction) : limited at + voltage input at F-TLA. Reverse side (reverse direction) : limited at + voltage input at R-TLA.	03:_Analog_3	External torque limit input is used. Forward side/F-TLA Reverse side/F-TLA	Forward (forward direction)side : limited at + voltage input at F-TLA. Reverse (reverse direction)side : limited at + voltage input at F-TLA.	
Selection		Contents															
00:_TCLM	Internal torque limit value (TCLM) is used.	Forward side(forward direction) : limited at internal set value. Reverse side (reverse direction) : limited at internal set value.															
01:_Analog_1	External torque limit input is used. Forward side/F-TLA, Reverse side/R-TLA(-voltage input)	Forward side(forward direction) : limited at + voltage input at F-TLA. Reverse side (reverse direction) : limited at - voltage input at R-TLA.															
02:_Analog_2	External torque limit input is used. Forward side/F-TLA, Reverse side/R-TLA(+ voltage input)	Forward side (forward direction) : limited at + voltage input at F-TLA. Reverse side (reverse direction) : limited at + voltage input at R-TLA.															
03:_Analog_3	External torque limit input is used. Forward side/F-TLA Reverse side/F-TLA	Forward (forward direction)side : limited at + voltage input at F-TLA. Reverse (reverse direction)side : limited at + voltage input at F-TLA.															
36	Internal Torque Limit [TCLM]																
	<table border="1"> <tr> <th>Setting range</th> <th>Unit</th> <th>Standard value</th> </tr> <tr> <td>10~500</td> <td>%</td> <td>100</td> </tr> </table>	Setting range	Unit	Standard value	10~500	%	100	Parameter for limiting output torque. Torque limit value is determined by comparing it with the rated output torque.(100%= rated torque) Output torque is limited at the internal torque limit set value when the torque limit input signal is functioning. Output torque is restricted by TP if a value exceeding the peak output torque TP is selected.									
Setting range	Unit	Standard value															
10~500	%	100															
37	Torque Limit at Sequence Operation [SQTCLM]																
	<table border="1"> <tr> <th>Setting range</th> <th>Unit</th> <th>Standard value</th> </tr> <tr> <td>10~500</td> <td>%</td> <td>120</td> </tr> </table>	Setting range	Unit	Standard value	10~500	%	120	Parameter for setting sequence operation torque limit value (JOG operation, holding brake operation waiting, and OT status, etc.) Torque limit value is determined by comparing it with the rated output torque. (100%=rated torque) During sequence operation, output torque is restricted by this set value. Output torque is restricted by TP if a value exceeding the peak output torque TP is selected.									
Setting range	Unit	Standard value															
10~500	%	120															

5. Parameter

[Parameter setting value【Group8】]

Page	Contents						
40	In-Position Near Range [NEAR]						
	<table border="1"> <thead> <tr> <th>Setting range</th> <th>Unit</th> <th>Standard value</th> </tr> </thead> <tbody> <tr> <td>1~65535</td> <td>Pulse</td> <td>500</td> </tr> </tbody> </table>	Setting range	Unit	Standard value	1~65535	Pulse	500
Setting range	Unit	Standard value					
1~65535	Pulse	500					
41	In-Position Window [INP]						
	<table border="1"> <thead> <tr> <th>Setting range</th> <th>Unit</th> <th>Standard value</th> </tr> </thead> <tbody> <tr> <td>1~65535</td> <td>Pulse</td> <td>100</td> </tr> </tbody> </table>	Setting range	Unit	Standard value	1~65535	Pulse	100
Setting range	Unit	Standard value					
1~65535	Pulse	100					
42	Speed Zero Range [ZV]						
	<table border="1"> <thead> <tr> <th>Setting range</th> <th>Unit</th> <th>Standard value</th> </tr> </thead> <tbody> <tr> <td>50~500</td> <td>min⁻¹</td> <td>50</td> </tr> </tbody> </table>	Setting range	Unit	Standard value	50~500	min ⁻¹	50
Setting range	Unit	Standard value					
50~500	min ⁻¹	50					
43	Low Speed Range [LOWV]						
	<table border="1"> <thead> <tr> <th>Setting range</th> <th>Unit</th> <th>Standard value</th> </tr> </thead> <tbody> <tr> <td>0~65535</td> <td>min⁻¹</td> <td>50</td> </tr> </tbody> </table>	Setting range	Unit	Standard value	0~65535	min ⁻¹	50
Setting range	Unit	Standard value					
0~65535	min ⁻¹	50					
44	Speed Matching Width [VCMP]						
	<table border="1"> <thead> <tr> <th>Setting range</th> <th>Unit</th> <th>Standard value</th> </tr> </thead> <tbody> <tr> <td>0~65535</td> <td>min⁻¹</td> <td>50</td> </tr> </tbody> </table>	Setting range	Unit	Standard value	0~65535	min ⁻¹	50
Setting range	Unit	Standard value					
0~65535	min ⁻¹	50					
45	High Speed Range [VA]						
	<table border="1"> <thead> <tr> <th>Setting range</th> <th>Unit</th> <th>Standard value</th> </tr> </thead> <tbody> <tr> <td>0~65535</td> <td>min⁻¹</td> <td>1000</td> </tr> </tbody> </table>	Setting range	Unit	Standard value	0~65535	min ⁻¹	1000
Setting range	Unit	Standard value					
0~65535	min ⁻¹	1000					

5. Parameter

[Parameter setting value [Group9]]

■ General parameter Group 9 [Condition settings for enabling functions]

Input signals and conditions to enable the functions of each page are set.

 Selection contents to be set are on the next page.

Page	Contents	
00	Positive Over-Travel Function [F-OT]	
	Setting range 00~27	Standard value OD: _CONT6_OFF
01	Negative Over-Travel Function [R-OT]	
	Setting range 00~27	Standard value OB: _CONT5_OFF
02	Alarm Reset Function [AL-RST]	
	Setting range 00~27	Standard value 10: _CONT8_ON
03	Absolute Encoder Clear Function [ECLR]	
	Setting range 00~27	Standard value 06: _CONT3_ON
04	Deviation Clear Function [CLR]	
	Setting range 00~27	Standard value 08: _CONT4_ON
05	SERVO-ON Function [S-ON]	
	Setting range 00~27	Standard value 02: _CONT1_ON
10	Control Mode Switching Function [MS]	
	Setting range 00~27	Standard value 00: Always_Disable
11	Position Command Pulse Inhibit Function and Velocity Command Zero Clamp Function [INH/Z-STP]	
	Setting range 00~27	Standard value 00: Always_Disable
12	Electric Gear Switching Function [GERS]	
	Setting range 00~27	Standard value 00: Always_Disable
13	Gain Switching Function, Select Input 1 [GC1]	
	Setting range 00~27	Standard value 00: Always_Disable
14	Gain Switching Function, Select Input 2 [GC2]	
	Setting range 00~27	Standard value 00: Always_Disable
15	Vibration Suppressor Frequency, Select Input 1 [SUPFSEL1]	
	Setting range 00~27	Standard value 00: Always_Disable
16	Vibration Suppressor Frequency, Select Input 2 [SUPFSEL2]	
	Setting range 00~27	Standard value 00: Always_Disable
17	Position Loop Proportional Control, Switching Function [PLPCON]	
	Setting range 00~27	Standard value 01: Always_Enable

Page	Contents	
20	Preset Velocity Command, Select Input 1 [SP1]	
	Setting range 00~27	Standard value 00: Always_Disable
21	Preset Velocity Command, Select Input 2 [SP2]	
	Setting range 00~27	Standard value 00: Always_Disable
22	Preset Velocity Command, Direction of Move [DIR]	
	Setting range 00~27	Standard value 00: Always_Disable
23	Preset Velocity Command, Operation Start Signal Input [RUN]	
	Setting range 00~27	Standard value 00: Always_Disable
24	Preset Velocity Command, Positive Move Signal Input [RUN-F]	
	Setting range 00~27	Standard value 00: Always_Disable
25	Preset Velocity Command, Negative Move Signal Input [RUN-R]	
	Setting range 00~27	Standard value 00: Always_Disable
26	Velocity Loop Proportional Control, Switching Function [VLPCON]	
	Setting range 00~27	Standard value 04: _CONT2_ON
27	Velocity Compensation Function, Select Input [VCOMPS]	
	Setting range 00~27	Standard value 00: Always_Disable
30	Torque Compensation Function, Select Input 1 [TCOMPS1]	
	Setting range 00~27	Standard value 00: Always_Disable
31	Torque Compensation Function, Select Input 2 [TCOMPS2]	
	Setting range 00~27	Standard value 00: Always_Disable
32	Torque Limit, Input Selection [TL]	
	Setting range 00~27	Standard value OE: _CONT7_ON
33	Disturbance Observer [OBS]	
	Setting range 00~27	Standard value 00: Always_Disable
40	External Error Input [EXT-E]	
	Setting range 00~27	Standard value 00: Always_Disable
41	Main Power Discharge Function [DISCHARG]	
	Setting range 00~27	Standard value 01: Always_Enable
42	Emergency Stop Function [EMR]	
	Setting range 00~27	Standard value 00: Always_Disable

5. Parameter

[Parameter setting value [Group9]]

● General parameter Group 9 List of selection contents

When functions are to be always enabled or disabled.

Selection	Contents
00: _Always_Disable	Always disable the function.
01: _Always_Enable	Always enable the function.

When functions are to be used with the generic input signals.

Selection	Contents
02: _CONT1_ON	Enable the function when general purpose input CONT1 is ON.
03: _CONT1_OFF	Enable the function when general purpose input CONT1 is OFF.
04: _CONT2_ON	Enable the function when general purpose input CONT2 is ON.
05: _CONT2_OFF	Enable the function when general purpose input CONT2 is OFF.
06: _CONT3_ON	Enable the function when general purpose input CONT3 is ON.
07: _CONT3_OFF	Enable the function when general purpose input CONT3 is OFF.
08: _CONT4_ON	Enable the function when general purpose input CONT4 is ON.
09: _CONT4_OFF	Enable the function when general purpose input CONT4 is OFF.
0A: _CONT5_ON	Enable the function when general purpose input CONT5 is ON.
0B: _CONT5_OFF	Enable the function when general purpose input CONT5 is OFF.
0C: _CONT6_ON	Enable the function when general purpose input CONT6 is ON.
0D: _CONT6_OFF	Enable the function when general purpose input CONT6 is OFF.
0E: _CONT7_ON	Enable the function when general purpose input CONT7 is ON.
0F: _CONT7_OFF	Enable the function when general purpose input CONT7 is OFF.
10: _CONT8_ON	Enable the function when general purpose input CONT8 is ON.
11: _CONT8_OFF	Enable the function when general purpose input CONT8 is OFF.

When functions are to be set with the conditions of servo motor rotation speed.

Selection	Contents
12: _LOWV_IN	Enable the function during low speed status (speed is less than LOWV).
13: _LOWV_OUT	Enable the function while low speed status is not kept.
14: _VA_IN	Enable the function during high speed status (speed is more than VA).
15: _VA_OUT	Enable the function while high speed status is not kept.
16: _VCMP_IN	Enable the function during speed matching status (velocity deviation < VCMP).
17: _VCMP_OUT	Enable the function while speed matching status is not kept.
18: _ZV_IN	Enable the function during zero speed status (speed is less than ZV).
19: _ZV_OUT	Enable the function while zero speed status is not kept.

When functions are to be set with the conditions of positioning signals.

Selection	Contents
20: _NEAR_IN	Enable the function during NEAR status (position deviation < NEAR).
21: _NEAR_OUT	Enable the function while NEAR status is not kept.
1A: _INP_IN	Enable the function during In-Position status (position deviation < INP).
1B: _INP_OUT	Enable the function while In-Position status is not kept.
26: _INPZ_IN	Enable the function during PCMD=0 and In-position Status.
27: _INPZ_OUT	Disable the function during PCMD=0 or In-position Status.

When functions are to be set with the conditions of torque / speed limit

Selection	Contents
1C: _TLC_IN	Enable the function during torque limiting.
1D: _TLC_OUT	Enable the function while torque limiting is not performed.
1E: _VLC_IN	Enable the function during velocity limiting.
1F: _VLC_OUT	Enable the function while velocity limiting is not performed.

When functions are to be set with the servo motor rotation direction and stop status.

Selection	Contents
22: _VMON_>_+LV	Enable the function when Moving Direction is Positive (VMON > LOWV).
23: _VMON_<=_+LV	Enable the function when Moving Direction is not Positive (VMON <= LOWV).
24: _VMON_<_-LV	Enable the function when Moving Direction is Negative (VMON < LOWV).
25: _VMON_>=_-LV	Enable the function when Moving Direction is not Negative (VMON >= LOWV).

5. Parameter

[Parameter setting value [GroupA]]

- General parameter Group A [generic output terminal outputting condition/monitor output selection/setup software settings]

Page	Name and Contents																																													
00	General Purpose Output 1 [OUT1]																																													
	Setting range	Standard value																																												
01	General Purpose Output 2 [OUT2]																																													
	Setting range	Standard value																																												
02	General Purpose Output 3 [OUT3]																																													
	Setting range	Standard value																																												
03	General Purpose Output 4 [OUT4]																																													
	Setting range	Standard value																																												
04	General Purpose Output 5 [OUT5]																																													
	Setting range	Standard value																																												
05	General Purpose Output 6 [OUT6]																																													
	Setting range	Standard value																																												
06	General Purpose Output 7 [OUT7]																																													
	Setting range	Standard value																																												
07	General Purpose Output 8 [OUT8]																																													
	Setting range	Standard value																																												
10	Digital Monitor, Output Signal Selection [DMON]																																													
	Setting range	Standard value																																												
11	Analog Monitor 1, Output Signal Selection [MON1]																																													
	Setting range	Standard value																																												
12	Analog Monitor 2, Output Signal Selection [MON2]																																													
	Setting range	Standard value																																												
<table border="1"> <tbody> <tr> <td>00</td> <td>Reserved</td> </tr> <tr> <td>01: TMON_2V/TR</td> <td>Torque (thrust) monitor 2V/ rated torque (thrust)</td> </tr> <tr> <td>02: TCMON_2V/TR</td> <td>Torque (thrust) command monitor 2V/ rated torque (thrust)</td> </tr> <tr> <td>03: VMON_0.2mV/ min⁻¹</td> <td>Velocity monitor 0.2mV/ min⁻¹</td> </tr> <tr> <td>04: VMON_1mV/ min⁻¹</td> <td>Velocity monitor 1mV/ min⁻¹</td> </tr> <tr> <td>05: VMON_2mV/ min⁻¹</td> <td>Velocity monitor 2mV/ min⁻¹</td> </tr> <tr> <td>06: VMON_3mV/ min⁻¹</td> <td>Velocity monitor 3mV/ min⁻¹</td> </tr> <tr> <td>07: VCMON_0.2mV/ min⁻¹</td> <td>Velocity command monitor 0.2mV/ min⁻¹</td> </tr> <tr> <td>08: VCMON_1mV/ min⁻¹</td> <td>Velocity command monitor 1mV/ min⁻¹</td> </tr> <tr> <td>09: VCMON_2mV/ min⁻¹</td> <td>Velocity command monitor 2mV/ min⁻¹</td> </tr> <tr> <td>0A: VCMON_3mV/ min⁻¹</td> <td>Velocity command monitor 3mV/ min⁻¹</td> </tr> <tr> <td>0B: PMON_0.1mV/P</td> <td>Position deviation counter monitor 0.1mV/ Pulse</td> </tr> <tr> <td>0C: PMON_1mV/P</td> <td>Position deviation counter monitor 1mV/ Pulse</td> </tr> <tr> <td>0D: PMON_10mV/P</td> <td>Position deviation counter monitor 10mV/ Pulse</td> </tr> <tr> <td>0E: PMON_20mV/P</td> <td>Position deviation counter monitor 20mV/ Pulse</td> </tr> <tr> <td>0F: PMON_50mV/P</td> <td>Position deviation counter monitor 50mV/Pulse</td> </tr> <tr> <td>10: FMON_2mV/kP/s</td> <td>Position command pulse monitor (position command pulse input frequency)2mV/kPulse/s</td> </tr> <tr> <td>11: FMON_10mV/kP/s</td> <td>Position command pulse monitor (position command pulse input frequency)10mV/kPulse/s</td> </tr> <tr> <td>12: TLMON_EST_2V/TR</td> <td>Load torque (thrust) monitor (estimated value) 2V/ rated torque (thrust)</td> </tr> <tr> <td>13: Sine-U</td> <td>U phase electric angle Sin 8 V peak</td> </tr> <tr> <td>14: VBUS_1V/DC100V</td> <td>Main circuit DC voltage 1V/DC100V</td> </tr> <tr> <td>15: VBUS_1V/DC10V</td> <td>Main circuit DC voltage 1V/DC10V</td> </tr> </tbody> </table>			00	Reserved	01: TMON_2V/TR	Torque (thrust) monitor 2V/ rated torque (thrust)	02: TCMON_2V/TR	Torque (thrust) command monitor 2V/ rated torque (thrust)	03: VMON_0.2mV/ min ⁻¹	Velocity monitor 0.2mV/ min ⁻¹	04: VMON_1mV/ min ⁻¹	Velocity monitor 1mV/ min ⁻¹	05: VMON_2mV/ min ⁻¹	Velocity monitor 2mV/ min ⁻¹	06: VMON_3mV/ min ⁻¹	Velocity monitor 3mV/ min ⁻¹	07: VCMON_0.2mV/ min ⁻¹	Velocity command monitor 0.2mV/ min ⁻¹	08: VCMON_1mV/ min ⁻¹	Velocity command monitor 1mV/ min ⁻¹	09: VCMON_2mV/ min ⁻¹	Velocity command monitor 2mV/ min ⁻¹	0A: VCMON_3mV/ min ⁻¹	Velocity command monitor 3mV/ min ⁻¹	0B: PMON_0.1mV/P	Position deviation counter monitor 0.1mV/ Pulse	0C: PMON_1mV/P	Position deviation counter monitor 1mV/ Pulse	0D: PMON_10mV/P	Position deviation counter monitor 10mV/ Pulse	0E: PMON_20mV/P	Position deviation counter monitor 20mV/ Pulse	0F: PMON_50mV/P	Position deviation counter monitor 50mV/Pulse	10: FMON_2mV/kP/s	Position command pulse monitor (position command pulse input frequency)2mV/kPulse/s	11: FMON_10mV/kP/s	Position command pulse monitor (position command pulse input frequency)10mV/kPulse/s	12: TLMON_EST_2V/TR	Load torque (thrust) monitor (estimated value) 2V/ rated torque (thrust)	13: Sine-U	U phase electric angle Sin 8 V peak	14: VBUS_1V/DC100V	Main circuit DC voltage 1V/DC100V	15: VBUS_1V/DC10V	Main circuit DC voltage 1V/DC10V
00	Reserved																																													
01: TMON_2V/TR	Torque (thrust) monitor 2V/ rated torque (thrust)																																													
02: TCMON_2V/TR	Torque (thrust) command monitor 2V/ rated torque (thrust)																																													
03: VMON_0.2mV/ min ⁻¹	Velocity monitor 0.2mV/ min ⁻¹																																													
04: VMON_1mV/ min ⁻¹	Velocity monitor 1mV/ min ⁻¹																																													
05: VMON_2mV/ min ⁻¹	Velocity monitor 2mV/ min ⁻¹																																													
06: VMON_3mV/ min ⁻¹	Velocity monitor 3mV/ min ⁻¹																																													
07: VCMON_0.2mV/ min ⁻¹	Velocity command monitor 0.2mV/ min ⁻¹																																													
08: VCMON_1mV/ min ⁻¹	Velocity command monitor 1mV/ min ⁻¹																																													
09: VCMON_2mV/ min ⁻¹	Velocity command monitor 2mV/ min ⁻¹																																													
0A: VCMON_3mV/ min ⁻¹	Velocity command monitor 3mV/ min ⁻¹																																													
0B: PMON_0.1mV/P	Position deviation counter monitor 0.1mV/ Pulse																																													
0C: PMON_1mV/P	Position deviation counter monitor 1mV/ Pulse																																													
0D: PMON_10mV/P	Position deviation counter monitor 10mV/ Pulse																																													
0E: PMON_20mV/P	Position deviation counter monitor 20mV/ Pulse																																													
0F: PMON_50mV/P	Position deviation counter monitor 50mV/Pulse																																													
10: FMON_2mV/kP/s	Position command pulse monitor (position command pulse input frequency)2mV/kPulse/s																																													
11: FMON_10mV/kP/s	Position command pulse monitor (position command pulse input frequency)10mV/kPulse/s																																													
12: TLMON_EST_2V/TR	Load torque (thrust) monitor (estimated value) 2V/ rated torque (thrust)																																													
13: Sine-U	U phase electric angle Sin 8 V peak																																													
14: VBUS_1V/DC100V	Main circuit DC voltage 1V/DC100V																																													
15: VBUS_1V/DC10V	Main circuit DC voltage 1V/DC10V																																													

Output signals for Generic output OUT1~Generic output OUT8 are selected.

 Selection values to be set are on the next page.

Output signals for digital monitor output are selected.

 Selection values to be set are on the next page.

Output signals for analog monitor output 1, 2 are selected from the followings.

5. Parameter



[Parameter setting value [GroupA]]

- Generic output OUT1~Generic output OUT8, List of selection contents for digital monitor output

When functions are to be always enabled or disabled.																																																																																									
<table border="1"> <thead> <tr> <th>Selection</th> <th>Contents</th> </tr> </thead> <tbody> <tr> <td>00: Always_OFF</td> <td>The output is always OFF.</td> </tr> <tr> <td>01: Always_ON</td> <td>The output is always ON.</td> </tr> </tbody> </table>	Selection	Contents	00: Always_OFF	The output is always OFF.	01: Always_ON	The output is always ON.																																																																																			
Selection	Contents																																																																																								
00: Always_OFF	The output is always OFF.																																																																																								
01: Always_ON	The output is always ON.																																																																																								
When Generic input signal status is to be output.																																																																																									
<table border="1"> <thead> <tr> <th>Selection</th> <th>Contents</th> </tr> </thead> <tbody> <tr> <td>3A: CONT1_ON</td> <td>The output is ON while general purpose input CONT 1 is ON.</td> </tr> <tr> <td>3B: CONT1_OFF</td> <td>The output is OFF while general purpose input CONT 1 is ON.</td> </tr> <tr> <td>3C: CONT2_ON</td> <td>The output is ON while general purpose input CONT 2 is ON.</td> </tr> <tr> <td>3D: CONT2_OFF</td> <td>The output is OFF while general purpose input CONT 2 is ON.</td> </tr> <tr> <td>3E: CONT3_ON</td> <td>The output is ON while general purpose input CONT 3 is ON.</td> </tr> <tr> <td>3F: CONT3_OFF</td> <td>The output is OFF while general purpose input CONT 3 is ON.</td> </tr> <tr> <td>40: CONT4_ON</td> <td>The output is ON while general purpose input CONT 4 is ON.</td> </tr> <tr> <td>41: CONT4_OFF</td> <td>The output is OFF while general purpose input CONT 4 is ON.</td> </tr> </tbody> </table>	Selection	Contents	3A: CONT1_ON	The output is ON while general purpose input CONT 1 is ON.	3B: CONT1_OFF	The output is OFF while general purpose input CONT 1 is ON.	3C: CONT2_ON	The output is ON while general purpose input CONT 2 is ON.	3D: CONT2_OFF	The output is OFF while general purpose input CONT 2 is ON.	3E: CONT3_ON	The output is ON while general purpose input CONT 3 is ON.	3F: CONT3_OFF	The output is OFF while general purpose input CONT 3 is ON.	40: CONT4_ON	The output is ON while general purpose input CONT 4 is ON.	41: CONT4_OFF	The output is OFF while general purpose input CONT 4 is ON.	<table border="1"> <thead> <tr> <th>Selection</th> <th>Contents</th> </tr> </thead> <tbody> <tr> <td>42: CONT5_ON</td> <td>The output is ON while general purpose input CONT 5 is ON.</td> </tr> <tr> <td>43: CONT5_OFF</td> <td>The output is OFF while general purpose input CONT 5 is ON.</td> </tr> <tr> <td>44: CONT6_ON</td> <td>The output is ON while general purpose input CONT 6 is ON.</td> </tr> <tr> <td>45: CONT6_OFF</td> <td>The output is OFF while general purpose input CONT6 is ON.</td> </tr> <tr> <td>46: CONT7_ON</td> <td>The output is ON while general purpose input CONT 7 is ON.</td> </tr> <tr> <td>47: CONT7_OFF</td> <td>The output is OFF while general purpose input CONT 7 is ON.</td> </tr> <tr> <td>48: CONT8_ON</td> <td>The output is ON while general purpose input CONT 8 is ON.</td> </tr> <tr> <td>49: CONT8_OFF</td> <td>The output is OFF while general purpose input CONT 8 is ON.</td> </tr> </tbody> </table>	Selection	Contents	42: CONT5_ON	The output is ON while general purpose input CONT 5 is ON.	43: CONT5_OFF	The output is OFF while general purpose input CONT 5 is ON.	44: CONT6_ON	The output is ON while general purpose input CONT 6 is ON.	45: CONT6_OFF	The output is OFF while general purpose input CONT6 is ON.	46: CONT7_ON	The output is ON while general purpose input CONT 7 is ON.	47: CONT7_OFF	The output is OFF while general purpose input CONT 7 is ON.	48: CONT8_ON	The output is ON while general purpose input CONT 8 is ON.	49: CONT8_OFF	The output is OFF while general purpose input CONT 8 is ON.																																																				
Selection	Contents																																																																																								
3A: CONT1_ON	The output is ON while general purpose input CONT 1 is ON.																																																																																								
3B: CONT1_OFF	The output is OFF while general purpose input CONT 1 is ON.																																																																																								
3C: CONT2_ON	The output is ON while general purpose input CONT 2 is ON.																																																																																								
3D: CONT2_OFF	The output is OFF while general purpose input CONT 2 is ON.																																																																																								
3E: CONT3_ON	The output is ON while general purpose input CONT 3 is ON.																																																																																								
3F: CONT3_OFF	The output is OFF while general purpose input CONT 3 is ON.																																																																																								
40: CONT4_ON	The output is ON while general purpose input CONT 4 is ON.																																																																																								
41: CONT4_OFF	The output is OFF while general purpose input CONT 4 is ON.																																																																																								
Selection	Contents																																																																																								
42: CONT5_ON	The output is ON while general purpose input CONT 5 is ON.																																																																																								
43: CONT5_OFF	The output is OFF while general purpose input CONT 5 is ON.																																																																																								
44: CONT6_ON	The output is ON while general purpose input CONT 6 is ON.																																																																																								
45: CONT6_OFF	The output is OFF while general purpose input CONT6 is ON.																																																																																								
46: CONT7_ON	The output is ON while general purpose input CONT 7 is ON.																																																																																								
47: CONT7_OFF	The output is OFF while general purpose input CONT 7 is ON.																																																																																								
48: CONT8_ON	The output is ON while general purpose input CONT 8 is ON.																																																																																								
49: CONT8_OFF	The output is OFF while general purpose input CONT 8 is ON.																																																																																								
When servo amplifier inner status is to be output.																																																																																									
<table border="1"> <thead> <tr> <th>Selection</th> <th>Contents</th> </tr> </thead> <tbody> <tr> <td>02: S-RDY_ON</td> <td>The output is ON during Servo Ready complete.</td> </tr> <tr> <td>03: S-RDY_OFF</td> <td>The output is OFF during Servo Ready complete.</td> </tr> <tr> <td>58: S-RDY2_ON</td> <td>The output is ON during Servo Ready complete.</td> </tr> <tr> <td>59: S-RDY2_OFF</td> <td>The output is OFF during Servo Ready complete.</td> </tr> <tr> <td>04: P-ON_ON</td> <td>The output is ON while the main power supply is turned on.</td> </tr> <tr> <td>05: P-ON_OFF</td> <td>The output is OFF while the main power supply is turned on.</td> </tr> <tr> <td>06: A-RDY_ON</td> <td>The output is ON during the main power supply ON permission.</td> </tr> <tr> <td>07: A-RDY_OFF</td> <td>The output is OFF during the main power supply ON permission.</td> </tr> <tr> <td>08: S-ON_ON</td> <td>The output is ON during motor excitation.</td> </tr> <tr> <td>09: S-ON_OFF</td> <td>The output is OFF during motor excitation.</td> </tr> <tr> <td>0A: MBR-ON_ON</td> <td>The output is ON while holding brake excitation signal outputs.</td> </tr> <tr> <td>0B: MBR-ON_OFF</td> <td>The output is OFF while holding brake excitation signal outputs.</td> </tr> <tr> <td>0C: TLC_ON</td> <td>The output is ON during torque limiting.</td> </tr> <tr> <td>0D: TLC_OFF</td> <td>The output is OFF during torque limiting.</td> </tr> <tr> <td>0E: VLC_ON</td> <td>The output is ON during velocity limiting.</td> </tr> <tr> <td>0F: VLC_OFF</td> <td>The output is OFF during velocity limiting.</td> </tr> <tr> <td>10: LOWV_ON</td> <td>The output is ON during low speed status (speed is less than LOWV).</td> </tr> <tr> <td>11: LOWV_OFF</td> <td>The output is OFF during low speed status (speed is less than LOWV).</td> </tr> <tr> <td>12: VA_ON</td> <td>The output is ON during high speed status (speed is more than VA).</td> </tr> <tr> <td>13: VA_OFF</td> <td>The output is OFF during high speed status (speed is more than VA).</td> </tr> <tr> <td>14: VCMP_ON</td> <td>The output is ON during speed matching status (velocity deviation < VCMP).</td> </tr> <tr> <td>15: VCMP_OFF</td> <td>The output is OFF during speed matching status (velocity deviation < VCMP).</td> </tr> </tbody> </table>	Selection	Contents	02: S-RDY_ON	The output is ON during Servo Ready complete.	03: S-RDY_OFF	The output is OFF during Servo Ready complete.	58: S-RDY2_ON	The output is ON during Servo Ready complete.	59: S-RDY2_OFF	The output is OFF during Servo Ready complete.	04: P-ON_ON	The output is ON while the main power supply is turned on.	05: P-ON_OFF	The output is OFF while the main power supply is turned on.	06: A-RDY_ON	The output is ON during the main power supply ON permission.	07: A-RDY_OFF	The output is OFF during the main power supply ON permission.	08: S-ON_ON	The output is ON during motor excitation.	09: S-ON_OFF	The output is OFF during motor excitation.	0A: MBR-ON_ON	The output is ON while holding brake excitation signal outputs.	0B: MBR-ON_OFF	The output is OFF while holding brake excitation signal outputs.	0C: TLC_ON	The output is ON during torque limiting.	0D: TLC_OFF	The output is OFF during torque limiting.	0E: VLC_ON	The output is ON during velocity limiting.	0F: VLC_OFF	The output is OFF during velocity limiting.	10: LOWV_ON	The output is ON during low speed status (speed is less than LOWV).	11: LOWV_OFF	The output is OFF during low speed status (speed is less than LOWV).	12: VA_ON	The output is ON during high speed status (speed is more than VA).	13: VA_OFF	The output is OFF during high speed status (speed is more than VA).	14: VCMP_ON	The output is ON during speed matching status (velocity deviation < VCMP).	15: VCMP_OFF	The output is OFF during speed matching status (velocity deviation < VCMP).	<table border="1"> <thead> <tr> <th>Selection</th> <th>Contents</th> </tr> </thead> <tbody> <tr> <td>16: ZV_ON</td> <td>The output is ON during zero speed status (speed is less than ZV).</td> </tr> <tr> <td>17: ZV_OFF</td> <td>The output is OFF during zero speed status (speed is less than ZV).</td> </tr> <tr> <td>1C: CMD-ACK_ON</td> <td>The output is ON while command can be accepted.</td> </tr> <tr> <td>1D: CMD-ACK_OFF</td> <td>The output is OFF while command can be accepted.</td> </tr> <tr> <td>1E: GC-ACK_ON</td> <td>The output is ON during gain switching.</td> </tr> <tr> <td>1F: GC-ACK_OFF</td> <td>The output is OFF during gain switching.</td> </tr> <tr> <td>20: PCON-ACK_ON</td> <td>The output is ON during velocity loop proportional control switching.</td> </tr> <tr> <td>21: PCON-ACK_OFF</td> <td>The output is OFF during velocity loop proportional control switching.</td> </tr> <tr> <td>22: GERS-ACK_ON</td> <td>The output is ON during electric gear switching.</td> </tr> <tr> <td>23: GERS-ACK_OFF</td> <td>The output is OFF during electric gear switching.</td> </tr> <tr> <td>24: MS-ACK_ON</td> <td>The output is ON during control mode switching.</td> </tr> <tr> <td>25: MS-ACK_OFF</td> <td>The output is OFF during control mode switching.</td> </tr> <tr> <td>26: F-OT_ON</td> <td>The output is ON during positive over-travel status.</td> </tr> <tr> <td>27: F-OT_OFF</td> <td>The output is OFF during positive over-travel status.</td> </tr> <tr> <td>28: R-OT_ON</td> <td>The output is ON during negative over-travel status.</td> </tr> <tr> <td>29: R-OT_OFF</td> <td>The output is OFF during negative over-travel status.</td> </tr> <tr> <td>4A: CHARGE_ON</td> <td>The output is ON while main power supply (capacitor) is charging.</td> </tr> <tr> <td>4B: CHARGE_OFF</td> <td>The output is OFF while main power supply (capacitor) is charging.</td> </tr> <tr> <td>4C: DB_OFF</td> <td>The output is OFF during dynamic braking.</td> </tr> <tr> <td>4D: DB_ON</td> <td>The output is ON during dynamic braking.</td> </tr> </tbody> </table>	Selection	Contents	16: ZV_ON	The output is ON during zero speed status (speed is less than ZV).	17: ZV_OFF	The output is OFF during zero speed status (speed is less than ZV).	1C: CMD-ACK_ON	The output is ON while command can be accepted.	1D: CMD-ACK_OFF	The output is OFF while command can be accepted.	1E: GC-ACK_ON	The output is ON during gain switching.	1F: GC-ACK_OFF	The output is OFF during gain switching.	20: PCON-ACK_ON	The output is ON during velocity loop proportional control switching.	21: PCON-ACK_OFF	The output is OFF during velocity loop proportional control switching.	22: GERS-ACK_ON	The output is ON during electric gear switching.	23: GERS-ACK_OFF	The output is OFF during electric gear switching.	24: MS-ACK_ON	The output is ON during control mode switching.	25: MS-ACK_OFF	The output is OFF during control mode switching.	26: F-OT_ON	The output is ON during positive over-travel status.	27: F-OT_OFF	The output is OFF during positive over-travel status.	28: R-OT_ON	The output is ON during negative over-travel status.	29: R-OT_OFF	The output is OFF during negative over-travel status.	4A: CHARGE_ON	The output is ON while main power supply (capacitor) is charging.	4B: CHARGE_OFF	The output is OFF while main power supply (capacitor) is charging.	4C: DB_OFF	The output is OFF during dynamic braking.	4D: DB_ON	The output is ON during dynamic braking.
Selection	Contents																																																																																								
02: S-RDY_ON	The output is ON during Servo Ready complete.																																																																																								
03: S-RDY_OFF	The output is OFF during Servo Ready complete.																																																																																								
58: S-RDY2_ON	The output is ON during Servo Ready complete.																																																																																								
59: S-RDY2_OFF	The output is OFF during Servo Ready complete.																																																																																								
04: P-ON_ON	The output is ON while the main power supply is turned on.																																																																																								
05: P-ON_OFF	The output is OFF while the main power supply is turned on.																																																																																								
06: A-RDY_ON	The output is ON during the main power supply ON permission.																																																																																								
07: A-RDY_OFF	The output is OFF during the main power supply ON permission.																																																																																								
08: S-ON_ON	The output is ON during motor excitation.																																																																																								
09: S-ON_OFF	The output is OFF during motor excitation.																																																																																								
0A: MBR-ON_ON	The output is ON while holding brake excitation signal outputs.																																																																																								
0B: MBR-ON_OFF	The output is OFF while holding brake excitation signal outputs.																																																																																								
0C: TLC_ON	The output is ON during torque limiting.																																																																																								
0D: TLC_OFF	The output is OFF during torque limiting.																																																																																								
0E: VLC_ON	The output is ON during velocity limiting.																																																																																								
0F: VLC_OFF	The output is OFF during velocity limiting.																																																																																								
10: LOWV_ON	The output is ON during low speed status (speed is less than LOWV).																																																																																								
11: LOWV_OFF	The output is OFF during low speed status (speed is less than LOWV).																																																																																								
12: VA_ON	The output is ON during high speed status (speed is more than VA).																																																																																								
13: VA_OFF	The output is OFF during high speed status (speed is more than VA).																																																																																								
14: VCMP_ON	The output is ON during speed matching status (velocity deviation < VCMP).																																																																																								
15: VCMP_OFF	The output is OFF during speed matching status (velocity deviation < VCMP).																																																																																								
Selection	Contents																																																																																								
16: ZV_ON	The output is ON during zero speed status (speed is less than ZV).																																																																																								
17: ZV_OFF	The output is OFF during zero speed status (speed is less than ZV).																																																																																								
1C: CMD-ACK_ON	The output is ON while command can be accepted.																																																																																								
1D: CMD-ACK_OFF	The output is OFF while command can be accepted.																																																																																								
1E: GC-ACK_ON	The output is ON during gain switching.																																																																																								
1F: GC-ACK_OFF	The output is OFF during gain switching.																																																																																								
20: PCON-ACK_ON	The output is ON during velocity loop proportional control switching.																																																																																								
21: PCON-ACK_OFF	The output is OFF during velocity loop proportional control switching.																																																																																								
22: GERS-ACK_ON	The output is ON during electric gear switching.																																																																																								
23: GERS-ACK_OFF	The output is OFF during electric gear switching.																																																																																								
24: MS-ACK_ON	The output is ON during control mode switching.																																																																																								
25: MS-ACK_OFF	The output is OFF during control mode switching.																																																																																								
26: F-OT_ON	The output is ON during positive over-travel status.																																																																																								
27: F-OT_OFF	The output is OFF during positive over-travel status.																																																																																								
28: R-OT_ON	The output is ON during negative over-travel status.																																																																																								
29: R-OT_OFF	The output is OFF during negative over-travel status.																																																																																								
4A: CHARGE_ON	The output is ON while main power supply (capacitor) is charging.																																																																																								
4B: CHARGE_OFF	The output is OFF while main power supply (capacitor) is charging.																																																																																								
4C: DB_OFF	The output is OFF during dynamic braking.																																																																																								
4D: DB_ON	The output is ON during dynamic braking.																																																																																								
When positioning signal is to be output.																																																																																									
<table border="1"> <thead> <tr> <th>Selection</th> <th>Contents</th> </tr> </thead> <tbody> <tr> <td>18: INP_ON</td> <td>The output is ON during In-Position status (position deviation < INP).</td> </tr> <tr> <td>19: INP_OFF</td> <td>The output is OFF during In-Position status (position deviation < INP).</td> </tr> <tr> <td>1A: NEAR_ON</td> <td>The output is ON during In-Position Near status (position deviation < NEAR).</td> </tr> <tr> <td>1B: NEAR_OFF</td> <td>The output is OFF during In-Position Near status (position deviation < NEAR).</td> </tr> <tr> <td>5A: INPZ_ON</td> <td>The output is ON during PCMD=0 and In-position Status.</td> </tr> <tr> <td>5B: INPZ_OFF</td> <td>The output is OFF during PCMD=0 and In-position Status.</td> </tr> </tbody> </table>	Selection	Contents	18: INP_ON	The output is ON during In-Position status (position deviation < INP).	19: INP_OFF	The output is OFF during In-Position status (position deviation < INP).	1A: NEAR_ON	The output is ON during In-Position Near status (position deviation < NEAR).	1B: NEAR_OFF	The output is OFF during In-Position Near status (position deviation < NEAR).	5A: INPZ_ON	The output is ON during PCMD=0 and In-position Status.	5B: INPZ_OFF	The output is OFF during PCMD=0 and In-position Status.	<table border="1"> <thead> <tr> <th>Selection</th> <th>Contents</th> </tr> </thead> <tbody> <tr> <td>2A: WNG-OFW_ON</td> <td>The output is ON during following warning status (position deviation > OFWL).</td> </tr> <tr> <td>2B: WNG-OFW_OFF</td> <td>The output is OFF during following warning status (position deviation > OFWL).</td> </tr> <tr> <td>2C: WNG-OLW_ON</td> <td>The output is ON during over-load warning status.</td> </tr> <tr> <td>2D: WNG-OLW_OFF</td> <td>The output is OFF during over-load warning status.</td> </tr> <tr> <td>2E: WNG-ROLW_ON</td> <td>The output is ON during regenerative over-load warning status.</td> </tr> <tr> <td>2F: WNG-ROLW_OF F</td> <td>The output is OFF during regenerative over-load warning status.</td> </tr> <tr> <td>30: WNG-BAT_ON</td> <td>The output is ON during battery warning.</td> </tr> <tr> <td>31: WNG-BAT_OFF</td> <td>The output is OFF during battery warning.</td> </tr> </tbody> </table>	Selection	Contents	2A: WNG-OFW_ON	The output is ON during following warning status (position deviation > OFWL).	2B: WNG-OFW_OFF	The output is OFF during following warning status (position deviation > OFWL).	2C: WNG-OLW_ON	The output is ON during over-load warning status.	2D: WNG-OLW_OFF	The output is OFF during over-load warning status.	2E: WNG-ROLW_ON	The output is ON during regenerative over-load warning status.	2F: WNG-ROLW_OF F	The output is OFF during regenerative over-load warning status.	30: WNG-BAT_ON	The output is ON during battery warning.	31: WNG-BAT_OFF	The output is OFF during battery warning.																																																								
Selection	Contents																																																																																								
18: INP_ON	The output is ON during In-Position status (position deviation < INP).																																																																																								
19: INP_OFF	The output is OFF during In-Position status (position deviation < INP).																																																																																								
1A: NEAR_ON	The output is ON during In-Position Near status (position deviation < NEAR).																																																																																								
1B: NEAR_OFF	The output is OFF during In-Position Near status (position deviation < NEAR).																																																																																								
5A: INPZ_ON	The output is ON during PCMD=0 and In-position Status.																																																																																								
5B: INPZ_OFF	The output is OFF during PCMD=0 and In-position Status.																																																																																								
Selection	Contents																																																																																								
2A: WNG-OFW_ON	The output is ON during following warning status (position deviation > OFWL).																																																																																								
2B: WNG-OFW_OFF	The output is OFF during following warning status (position deviation > OFWL).																																																																																								
2C: WNG-OLW_ON	The output is ON during over-load warning status.																																																																																								
2D: WNG-OLW_OFF	The output is OFF during over-load warning status.																																																																																								
2E: WNG-ROLW_ON	The output is ON during regenerative over-load warning status.																																																																																								
2F: WNG-ROLW_OF F	The output is OFF during regenerative over-load warning status.																																																																																								
30: WNG-BAT_ON	The output is ON during battery warning.																																																																																								
31: WNG-BAT_OFF	The output is OFF during battery warning.																																																																																								
When alarm signals are to be output.																																																																																									
<table border="1"> <thead> <tr> <th>Selection</th> <th>Contents</th> </tr> </thead> <tbody> <tr> <td>32: ALM5_ON</td> <td>Output alarm code, bit 5. (Positive logic).</td> </tr> <tr> <td>33: ALM5_OFF</td> <td>Output alarm code, bit 5. (Negative logic).</td> </tr> <tr> <td>34: ALM6_ON</td> <td>Output alarm code, bit 6. (Positive logic).</td> </tr> <tr> <td>35: ALM6_OFF</td> <td>Output alarm code, bit 6. (Negative logic).</td> </tr> <tr> <td>36: ALM7_ON</td> <td>Output alarm code, bit 7. (Positive logic).</td> </tr> <tr> <td>37: ALM7_OFF</td> <td>Output alarm code, bit 7. (Negative logic).</td> </tr> <tr> <td>38: ALM_ON</td> <td>The output is ON during alarm status.</td> </tr> <tr> <td>39: ALM_OFF</td> <td>The output is OFF during alarm status.</td> </tr> </tbody> </table>	Selection	Contents	32: ALM5_ON	Output alarm code, bit 5. (Positive logic).	33: ALM5_OFF	Output alarm code, bit 5. (Negative logic).	34: ALM6_ON	Output alarm code, bit 6. (Positive logic).	35: ALM6_OFF	Output alarm code, bit 6. (Negative logic).	36: ALM7_ON	Output alarm code, bit 7. (Positive logic).	37: ALM7_OFF	Output alarm code, bit 7. (Negative logic).	38: ALM_ON	The output is ON during alarm status.	39: ALM_OFF	The output is OFF during alarm status.	<table border="1"> <thead> <tr> <th>Selection</th> <th>Contents</th> </tr> </thead> <tbody> <tr> <td>50: PYALM1_ON</td> <td>Output PY compatible alarm code 1. (Positive logic).</td> </tr> <tr> <td>51: PYALM1_OFF</td> <td>Output PY compatible alarm code 1. (Negative logic).</td> </tr> <tr> <td>52: PYALM2_ON</td> <td>Output PY compatible alarm code 2. (Positive logic).</td> </tr> <tr> <td>53: PYALM2_OFF</td> <td>Output PY compatible alarm code 1. (Negative logic).</td> </tr> <tr> <td>54: PYALM4_ON</td> <td>Output PY compatible alarm code 4. (Positive logic).</td> </tr> <tr> <td>55: PYALM4_OFF</td> <td>Output PY compatible alarm code 4. (Negative logic).</td> </tr> <tr> <td>56: PYALM8_ON</td> <td>Output PY compatible alarm code 8. (Positive logic).</td> </tr> <tr> <td>57: PYALM8_OFF</td> <td>Output PY compatible alarm code 8. (Negative logic).</td> </tr> </tbody> </table>	Selection	Contents	50: PYALM1_ON	Output PY compatible alarm code 1. (Positive logic).	51: PYALM1_OFF	Output PY compatible alarm code 1. (Negative logic).	52: PYALM2_ON	Output PY compatible alarm code 2. (Positive logic).	53: PYALM2_OFF	Output PY compatible alarm code 1. (Negative logic).	54: PYALM4_ON	Output PY compatible alarm code 4. (Positive logic).	55: PYALM4_OFF	Output PY compatible alarm code 4. (Negative logic).	56: PYALM8_ON	Output PY compatible alarm code 8. (Positive logic).	57: PYALM8_OFF	Output PY compatible alarm code 8. (Negative logic).																																																				
Selection	Contents																																																																																								
32: ALM5_ON	Output alarm code, bit 5. (Positive logic).																																																																																								
33: ALM5_OFF	Output alarm code, bit 5. (Negative logic).																																																																																								
34: ALM6_ON	Output alarm code, bit 6. (Positive logic).																																																																																								
35: ALM6_OFF	Output alarm code, bit 6. (Negative logic).																																																																																								
36: ALM7_ON	Output alarm code, bit 7. (Positive logic).																																																																																								
37: ALM7_OFF	Output alarm code, bit 7. (Negative logic).																																																																																								
38: ALM_ON	The output is ON during alarm status.																																																																																								
39: ALM_OFF	The output is OFF during alarm status.																																																																																								
Selection	Contents																																																																																								
50: PYALM1_ON	Output PY compatible alarm code 1. (Positive logic).																																																																																								
51: PYALM1_OFF	Output PY compatible alarm code 1. (Negative logic).																																																																																								
52: PYALM2_ON	Output PY compatible alarm code 2. (Positive logic).																																																																																								
53: PYALM2_OFF	Output PY compatible alarm code 1. (Negative logic).																																																																																								
54: PYALM4_ON	Output PY compatible alarm code 4. (Positive logic).																																																																																								
55: PYALM4_OFF	Output PY compatible alarm code 4. (Negative logic).																																																																																								
56: PYALM8_ON	Output PY compatible alarm code 8. (Positive logic).																																																																																								
57: PYALM8_OFF	Output PY compatible alarm code 8. (Negative logic).																																																																																								

5. Parameter

[Parameter setting value [GroupA]]

Page	Contents																						
13	Analog monitor output polarity [MONPOL]																						
	<table border="1"> <thead> <tr> <th>Setting range</th> <th>Standard value</th> </tr> </thead> <tbody> <tr> <td>00~08</td> <td>00:_MON1+_MON2+</td> </tr> </tbody> </table>	Setting range	Standard value	00~08	00:_MON1+_MON2+	The output polarity of analog monitor output MON1 and MON2 is selected from the contents below.																	
Setting range	Standard value																						
00~08	00:_MON1+_MON2+																						
13	<table border="1"> <thead> <tr> <th>Selection</th> <th>Contents</th> </tr> </thead> <tbody> <tr> <td>00:_MON1+_MON2+</td> <td>MON1 : Output the positive voltage at forward rotation (positive direction). Output the positive/negative voltage. MON2 : Output the positive voltage at forward rotation (positive direction). Output the positive/negative voltage.</td> </tr> <tr> <td>01:_MON1-_MON2+</td> <td>MON1 : Output the negative voltage at forward rotation (positive direction). Output the positive/negative voltage. MON2 : Output the positive voltage at forward rotation (positive direction). Output the positive/negative voltage.</td> </tr> <tr> <td>02:_MON1+_MON2-</td> <td>MON1 : Output the positive voltage at forward rotation (positive direction). Output the positive/negative voltage. MON2 : Output the negative voltage at forward rotation (positive direction). Output the positive/negative voltage.</td> </tr> <tr> <td>03:_MON1-_MON2-</td> <td>MON1 : Output the negative voltage at forward rotation (positive direction). Output the positive/negative voltage. MON2 : Output the negative voltage at forward rotation (positive direction). Output the positive/negative voltage.</td> </tr> <tr> <td>04:_MON1ABS_MON2+</td> <td>MON1 : Output the positive voltage at both forward rotation (positive direction) and reverse rotation (reverse direction). MON2 : Output the positive voltage at forward rotation (positive direction). Output the positive/negative voltage.</td> </tr> <tr> <td>05:_MON1ABS_MON2-</td> <td>MON1 : Output the positive voltage at both forward rotation (positive direction) and reverse rotation (reverse direction). MON2 : Output the negative voltage at forward rotation (positive direction). Output the positive/negative voltage.</td> </tr> <tr> <td>06:_MON1+_MON2ABS</td> <td>MON1 : Output the positive voltage at forward rotation (positive direction). Output the positive/negative voltage. MON2 : Output the positive voltage at both forward rotation (positive direction) and reverse rotation (reverse direction).</td> </tr> <tr> <td>07:_MON1-_MON2ABS</td> <td>MON1 : Output the negative voltage at forward rotation (positive direction). Output the positive/negative voltage. MON2 : Output the positive voltage at both forward rotation (positive direction) and reverse rotation (reverse direction).</td> </tr> <tr> <td>08:_MON1ABS_MON2ABS</td> <td>MON1 : Output the positive voltage at both forward rotation (positive direction) and reverse rotation (reverse direction). MON2 : Output the positive voltage at both forward rotation (positive direction) and reverse rotation (reverse direction).</td> </tr> </tbody> </table>		Selection	Contents	00:_MON1+_MON2+	MON1 : Output the positive voltage at forward rotation (positive direction). Output the positive/negative voltage. MON2 : Output the positive voltage at forward rotation (positive direction). Output the positive/negative voltage.	01:_MON1-_MON2+	MON1 : Output the negative voltage at forward rotation (positive direction). Output the positive/negative voltage. MON2 : Output the positive voltage at forward rotation (positive direction). Output the positive/negative voltage.	02:_MON1+_MON2-	MON1 : Output the positive voltage at forward rotation (positive direction). Output the positive/negative voltage. MON2 : Output the negative voltage at forward rotation (positive direction). Output the positive/negative voltage.	03:_MON1-_MON2-	MON1 : Output the negative voltage at forward rotation (positive direction). Output the positive/negative voltage. MON2 : Output the negative voltage at forward rotation (positive direction). Output the positive/negative voltage.	04:_MON1ABS_MON2+	MON1 : Output the positive voltage at both forward rotation (positive direction) and reverse rotation (reverse direction). MON2 : Output the positive voltage at forward rotation (positive direction). Output the positive/negative voltage.	05:_MON1ABS_MON2-	MON1 : Output the positive voltage at both forward rotation (positive direction) and reverse rotation (reverse direction). MON2 : Output the negative voltage at forward rotation (positive direction). Output the positive/negative voltage.	06:_MON1+_MON2ABS	MON1 : Output the positive voltage at forward rotation (positive direction). Output the positive/negative voltage. MON2 : Output the positive voltage at both forward rotation (positive direction) and reverse rotation (reverse direction).	07:_MON1-_MON2ABS	MON1 : Output the negative voltage at forward rotation (positive direction). Output the positive/negative voltage. MON2 : Output the positive voltage at both forward rotation (positive direction) and reverse rotation (reverse direction).	08:_MON1ABS_MON2ABS	MON1 : Output the positive voltage at both forward rotation (positive direction) and reverse rotation (reverse direction). MON2 : Output the positive voltage at both forward rotation (positive direction) and reverse rotation (reverse direction).	
	Selection	Contents																					
	00:_MON1+_MON2+	MON1 : Output the positive voltage at forward rotation (positive direction). Output the positive/negative voltage. MON2 : Output the positive voltage at forward rotation (positive direction). Output the positive/negative voltage.																					
	01:_MON1-_MON2+	MON1 : Output the negative voltage at forward rotation (positive direction). Output the positive/negative voltage. MON2 : Output the positive voltage at forward rotation (positive direction). Output the positive/negative voltage.																					
	02:_MON1+_MON2-	MON1 : Output the positive voltage at forward rotation (positive direction). Output the positive/negative voltage. MON2 : Output the negative voltage at forward rotation (positive direction). Output the positive/negative voltage.																					
	03:_MON1-_MON2-	MON1 : Output the negative voltage at forward rotation (positive direction). Output the positive/negative voltage. MON2 : Output the negative voltage at forward rotation (positive direction). Output the positive/negative voltage.																					
	04:_MON1ABS_MON2+	MON1 : Output the positive voltage at both forward rotation (positive direction) and reverse rotation (reverse direction). MON2 : Output the positive voltage at forward rotation (positive direction). Output the positive/negative voltage.																					
	05:_MON1ABS_MON2-	MON1 : Output the positive voltage at both forward rotation (positive direction) and reverse rotation (reverse direction). MON2 : Output the negative voltage at forward rotation (positive direction). Output the positive/negative voltage.																					
	06:_MON1+_MON2ABS	MON1 : Output the positive voltage at forward rotation (positive direction). Output the positive/negative voltage. MON2 : Output the positive voltage at both forward rotation (positive direction) and reverse rotation (reverse direction).																					
07:_MON1-_MON2ABS	MON1 : Output the negative voltage at forward rotation (positive direction). Output the positive/negative voltage. MON2 : Output the positive voltage at both forward rotation (positive direction) and reverse rotation (reverse direction).																						
08:_MON1ABS_MON2ABS	MON1 : Output the positive voltage at both forward rotation (positive direction) and reverse rotation (reverse direction). MON2 : Output the positive voltage at both forward rotation (positive direction) and reverse rotation (reverse direction).																						
20	Setup Software, Communication Axis Number [COMAXIS]																						
	<table border="1"> <thead> <tr> <th>Setting range</th> <th>Standard value</th> </tr> </thead> <tbody> <tr> <td>01~0F</td> <td>01:_#1</td> </tr> </tbody> </table>	Setting range	Standard value	01~0F	01:_#1	The axis number for communication with PC is selected from the contents below.  The selected value is enabled after turning ON the control power again.																	
Setting range	Standard value																						
01~0F	01:_#1																						
21	Setup Software, Communication Baud Rate [COMBAUD]																						
	<table border="1"> <thead> <tr> <th>Setting range</th> <th>Standard value</th> </tr> </thead> <tbody> <tr> <td>00~05</td> <td>05:_38400bps</td> </tr> </tbody> </table>	Setting range	Standard value	00~05	05:_38400bps	The baud rate for communication with PC is selected from the contents below.  The selected value is enabled after turning ON the control power again.																	
Setting range	Standard value																						
00~05	05:_38400bps																						
21	<table border="1"> <thead> <tr> <th>Selection</th> </tr> </thead> <tbody> <tr> <td>00:_1200bps</td> </tr> <tr> <td>01:_2400bps</td> </tr> <tr> <td>02:_4800bps</td> </tr> <tr> <td>03:_9600bps</td> </tr> <tr> <td>04:_19200bps</td> </tr> <tr> <td>05:_38400bps</td> </tr> </tbody> </table>		Selection	00:_1200bps	01:_2400bps	02:_4800bps	03:_9600bps	04:_19200bps	05:_38400bps														
Selection																							
00:_1200bps																							
01:_2400bps																							
02:_4800bps																							
03:_9600bps																							
04:_19200bps																							
05:_38400bps																							

5. Parameter

[Parameter setting value【GroupB】]

■ General parameter Group B [sequence/alarm related settings]

Page	Contents																	
00	JOG Velocity Command [JOGVC]																	
	<table border="1"> <thead> <tr> <th>Setting range</th> <th>Unit</th> <th>Standard value</th> </tr> </thead> <tbody> <tr> <td>0~32767</td> <td>min⁻¹</td> <td>50</td> </tr> </tbody> </table>	Setting range	Unit	Standard value	0~32767	min ⁻¹	50	Velocity command for test run and adjustment JOG operation is set.										
Setting range	Unit	Standard value																
0~32767	min ⁻¹	50																
10	Dynamic Brake Action Selection [DBOPE]																	
	<table border="1"> <thead> <tr> <th>Setting range</th> <th>Unit</th> <th>Standard value</th> </tr> </thead> <tbody> <tr> <td>00~05</td> <td>—</td> <td>04: SB_Free</td> </tr> </tbody> </table>	Setting range	Unit	Standard value	00~05	—	04: SB_Free	Dynamic brake operation when shifted from servo ON → servo OFF, and during servo OFF is selected from the contents below.  When the main circuit power is shut OFF, the dynamic brake will operate irrespective of this setting.										
Setting range	Unit	Standard value																
00~05	—	04: SB_Free																
11	Over-Travel Action Selection [ACTOT]																	
	<table border="1"> <thead> <tr> <th>Setting range</th> <th>Unit</th> <th>Standard value</th> </tr> </thead> <tbody> <tr> <td>00~06</td> <td>—</td> <td>00:_CMDINH_SB_SON</td> </tr> </tbody> </table>	Setting range	Unit	Standard value	00~06	—	00:_CMDINH_SB_SON	Operations at over travel are selected from the contents below.										
Setting range	Unit	Standard value																
00~06	—	00:_CMDINH_SB_SON																
12	Emergency Stop Operation [ACTEMR]																	
	<table border="1"> <thead> <tr> <th>Setting range</th> <th>Unit</th> <th>Standard value</th> </tr> </thead> <tbody> <tr> <td>00~01</td> <td>—</td> <td>00:_SERVO-BRAKE</td> </tr> </tbody> </table>	Setting range	Unit	Standard value	00~01	—	00:_SERVO-BRAKE	Forced stop operations (EMR) are selected from the contents below.										
Setting range	Unit	Standard value																
00~01	—	00:_SERVO-BRAKE																
	<table border="1"> <thead> <tr> <th>Selection</th> <th>Contents</th> </tr> </thead> <tbody> <tr> <td>00:_Free_Free</td> <td>When Servo-OFF, Free-Run is operated. After stops, Motor-Free is operated.</td> </tr> <tr> <td>01:_Free_DB</td> <td>When Servo-OFF, Free-Run is operated. After stops, Dynamic-Braking is performed.</td> </tr> <tr> <td>02:_DB_Free</td> <td>When S-OFF, Dynamic-Braking is performed. After stops, Motor-Free is operated.</td> </tr> <tr> <td>03:_DB_DB</td> <td>When S-OFF, Dynamic-Braking is performed. After stops, Dynamic-Braking.</td> </tr> <tr> <td>04:_SB_Free</td> <td>When Servo-OFF, Servo-Braking is performed. After stops, Motor-Free is operated.</td> </tr> <tr> <td>05:_SB_DB</td> <td>When Servo-OFF, Servo-Braking is performed. After stops, Dynamic-Braking.</td> </tr> </tbody> </table>	Selection	Contents	00:_Free_Free	When Servo-OFF, Free-Run is operated. After stops, Motor-Free is operated.	01:_Free_DB	When Servo-OFF, Free-Run is operated. After stops, Dynamic-Braking is performed.	02:_DB_Free	When S-OFF, Dynamic-Braking is performed. After stops, Motor-Free is operated.	03:_DB_DB	When S-OFF, Dynamic-Braking is performed. After stops, Dynamic-Braking.	04:_SB_Free	When Servo-OFF, Servo-Braking is performed. After stops, Motor-Free is operated.	05:_SB_DB	When Servo-OFF, Servo-Braking is performed. After stops, Dynamic-Braking.			
Selection	Contents																	
00:_Free_Free	When Servo-OFF, Free-Run is operated. After stops, Motor-Free is operated.																	
01:_Free_DB	When Servo-OFF, Free-Run is operated. After stops, Dynamic-Braking is performed.																	
02:_DB_Free	When S-OFF, Dynamic-Braking is performed. After stops, Motor-Free is operated.																	
03:_DB_DB	When S-OFF, Dynamic-Braking is performed. After stops, Dynamic-Braking.																	
04:_SB_Free	When Servo-OFF, Servo-Braking is performed. After stops, Motor-Free is operated.																	
05:_SB_DB	When Servo-OFF, Servo-Braking is performed. After stops, Dynamic-Braking.																	
	<table border="1"> <thead> <tr> <th>Selection</th> <th>Contents</th> </tr> </thead> <tbody> <tr> <td>00:_CMDINH_SB_SON</td> <td>PC is inhibited and Servo-Braking is performed. After stops, S-ON is operated.</td> </tr> <tr> <td>01:_CMDINH_DB_SON</td> <td>PC is inhibited and Dynamic-Braking is performed. After stops, S-ON is operated.</td> </tr> <tr> <td>02:_CMDINH_Free_SON</td> <td>PC is inhibited and Free-Run is performed. After stops, Servo-ON is operated.</td> </tr> <tr> <td>03:_CMDINH_SB_SOFF</td> <td>PC is inhibited and Servo-Braking is performed. After stops, S-OFF is operated.</td> </tr> <tr> <td>04:_CMDINH_DB_SOFF</td> <td>PC is inhibited and Dynamic-Braking is performed. After stops, S-OFF is operated.</td> </tr> <tr> <td>05:_CMDINH_Free_SOFF</td> <td>PC is inhibited and Free-Run is performed. After stops, Servo-OFF is operated.</td> </tr> <tr> <td>06:_CMDACK_VCLM=0</td> <td>****</td> </tr> </tbody> </table>	Selection	Contents	00:_CMDINH_SB_SON	PC is inhibited and Servo-Braking is performed. After stops, S-ON is operated.	01:_CMDINH_DB_SON	PC is inhibited and Dynamic-Braking is performed. After stops, S-ON is operated.	02:_CMDINH_Free_SON	PC is inhibited and Free-Run is performed. After stops, Servo-ON is operated.	03:_CMDINH_SB_SOFF	PC is inhibited and Servo-Braking is performed. After stops, S-OFF is operated.	04:_CMDINH_DB_SOFF	PC is inhibited and Dynamic-Braking is performed. After stops, S-OFF is operated.	05:_CMDINH_Free_SOFF	PC is inhibited and Free-Run is performed. After stops, Servo-OFF is operated.	06:_CMDACK_VCLM=0	****	
Selection	Contents																	
00:_CMDINH_SB_SON	PC is inhibited and Servo-Braking is performed. After stops, S-ON is operated.																	
01:_CMDINH_DB_SON	PC is inhibited and Dynamic-Braking is performed. After stops, S-ON is operated.																	
02:_CMDINH_Free_SON	PC is inhibited and Free-Run is performed. After stops, Servo-ON is operated.																	
03:_CMDINH_SB_SOFF	PC is inhibited and Servo-Braking is performed. After stops, S-OFF is operated.																	
04:_CMDINH_DB_SOFF	PC is inhibited and Dynamic-Braking is performed. After stops, S-OFF is operated.																	
05:_CMDINH_Free_SOFF	PC is inhibited and Free-Run is performed. After stops, Servo-OFF is operated.																	
06:_CMDACK_VCLM=0	****																	
	<table border="1"> <thead> <tr> <th>Selection</th> <th>Contents</th> </tr> </thead> <tbody> <tr> <td>00:_SERVO-BRAKE</td> <td>When EMR is input, motor is stopped by servo brake operations.</td> </tr> <tr> <td>01:_DINAMIC-BRAKE</td> <td>When EMR is input, motor is stopped by dynamic brake operations.</td> </tr> </tbody> </table>	Selection	Contents	00:_SERVO-BRAKE	When EMR is input, motor is stopped by servo brake operations.	01:_DINAMIC-BRAKE	When EMR is input, motor is stopped by dynamic brake operations.											
Selection	Contents																	
00:_SERVO-BRAKE	When EMR is input, motor is stopped by servo brake operations.																	
01:_DINAMIC-BRAKE	When EMR is input, motor is stopped by dynamic brake operations.																	

5. Parameter

[Parameter setting value【GroupB】]

Page	Contents							
13	Delay Time of Engaging Holding Brake (holding brake holding delay time) [BONDLY]							
	<table border="1"> <thead> <tr> <th>Setting range</th> <th>Unit</th> <th>Standard value</th> </tr> </thead> <tbody> <tr> <td>0~1000</td> <td>ms</td> <td>300</td> </tr> </tbody> </table>	Setting range	Unit	Standard value	0~1000	ms	300	Holding brake operation delay time when shifted from servo ON to servo OFF is set. When shifted from servo ON to servo OFF, motor excitation is kept during this time. (Velocity command is Zero.)
Setting range	Unit	Standard value						
0~1000	ms	300						
14	Delay Time of Releasing Holding Brake (holding brake release delay time) [BOFFDLY]							
	<table border="1"> <thead> <tr> <th>Setting range</th> <th>Unit</th> <th>Standard value</th> </tr> </thead> <tbody> <tr> <td>0~1000</td> <td>ms</td> <td>300</td> </tr> </tbody> </table>	Setting range	Unit	Standard value	0~1000	ms	300	Holding brake operation release delay time when shifted from servo OFF to servo ON is set. When shifted from servo OFF to servo ON, motor is excited during this time. (Velocity Command is Zero.)
Setting range	Unit	Standard value						
0~1000	ms	300						
15	Brake Operation Beginning Time [BONBGN]							
	<table border="1"> <thead> <tr> <th>Setting range</th> <th>Unit</th> <th>Standard value</th> </tr> </thead> <tbody> <tr> <td>0~65535</td> <td>ms</td> <td>0</td> </tr> </tbody> </table>	Setting range	Unit	Standard value	0~65535	ms	0	Parameter for setting motor free operation time, dynamic brake operation time and servo brake operation time. When shifted from servo ON to Servo OFF, holding brake and dynamic brake start to operate after this set time. When motor does not stop even after servo OFF at gravity axis or else, motor is stopped by holding brake and dynamic brake. In the system where motor speed becomes lower than Speed Zero Range (ZV) within the set time, this setting does not function. If set to 0msec, brake operation start time is disabled (=infinite).
Setting range	Unit	Standard value						
0~65535	ms	0						
16	Power Failure Detection Delay Time [PFDDL]							
	<table border="1"> <thead> <tr> <th>Setting range</th> <th>Unit</th> <th>Standard value</th> </tr> </thead> <tbody> <tr> <td>20~1000</td> <td>ms</td> <td>32</td> </tr> </tbody> </table>	Setting range	Unit	Standard value	20~1000	ms	32	The delay time from control power OFF to control power error detection is set. The larger value makes the detection of instantaneous stop slower. (Larger set value will only result in slower detection of error. In case of power failure of internal logic circuit, operation is the same as when control power is turned ON again. In case of energy shortage of main circuit power, other errors, such as main circuit power loss, may be detected.) In this setting, actual detection delay time varies by 12ms and +6ms.  The selected value is enabled after control power is turned ON again.
Setting range	Unit	Standard value						
20~1000	ms	32						
20	Following Error Warning Level [OFWL]							
	<table border="1"> <thead> <tr> <th>Setting range</th> <th>Unit</th> <th>Standard value</th> </tr> </thead> <tbody> <tr> <td>1~65535</td> <td>× 1024 Pulse</td> <td>65535</td> </tr> </tbody> </table>	Setting range	Unit	Standard value	1~65535	× 1024 Pulse	65535	Parameter to output warning before excessive position deviation alarm (following error) is output.
Setting range	Unit	Standard value						
1~65535	× 1024 Pulse	65535						
21	Following Error Limit [OFL]							
	<table border="1"> <thead> <tr> <th>Setting range</th> <th>Unit</th> <th>Standard value</th> </tr> </thead> <tbody> <tr> <td>1~65535</td> <td>× 1024 Pulse</td> <td>500</td> </tr> </tbody> </table>	Setting range	Unit	Standard value	1~65535	× 1024 Pulse	500	Parameter for setting the value to output position excessive deviation alarm (following error). Encoder pulse is the standard irrespective of electronic gear and command multiplication function.
Setting range	Unit	Standard value						
1~65535	× 1024 Pulse	500						

5. Parameter

[Parameter setting value【GroupB】]

Page	Contents													
22	<p>Overload Warning Level [OLWLV]</p> <table border="1"> <thead> <tr> <th>Setting range</th> <th>Unit</th> <th>Standard value</th> </tr> </thead> <tbody> <tr> <td>20~100</td> <td>%</td> <td>90</td> </tr> </tbody> </table>	Setting range	Unit	Standard value	20~100	%	90	<p>Parameter for outputting warnings before overload alarm is output. The possible level to be set is ranged from 20%~99%, assuming that the overload alarm level is 100%. When set to 100%, overload warning and overload alarm are output at one time. Overload detection is assumed and set as 75% of a rated load when control power is turned ON (hot start). Therefore, if this is set to below 75%, overload warning may be output when control power is turned ON.</p> <p> The set value is enabled after control power is turned ON again.</p>						
Setting range	Unit	Standard value												
20~100	%	90												
23	<p>Speed Feedback Error (ALM_C3) Detection [VFBALM]</p> <table border="1"> <thead> <tr> <th>Setting range</th> <th>Unit</th> <th>Standard value</th> </tr> </thead> <tbody> <tr> <td>00~01</td> <td>—</td> <td>01:_Enabled</td> </tr> </tbody> </table> <table border="1"> <thead> <tr> <th>Selection</th> <th>Contents</th> </tr> </thead> <tbody> <tr> <td>00:_Disabled</td> <td>Disabled</td> </tr> <tr> <td>01:_Enabled</td> <td>Enabled</td> </tr> </tbody> </table>	Setting range	Unit	Standard value	00~01	—	01:_Enabled	Selection	Contents	00:_Disabled	Disabled	01:_Enabled	Enabled	<p>Select either one from enabled or disabled of velocity feedback error alarm detection.</p>
Setting range	Unit	Standard value												
00~01	—	01:_Enabled												
Selection	Contents													
00:_Disabled	Disabled													
01:_Enabled	Enabled													
24	<p>Speed Control Error (ALM_C2) Detection [VCALM]</p> <table border="1"> <thead> <tr> <th>Setting range</th> <th>Unit</th> <th>Standard value</th> </tr> </thead> <tbody> <tr> <td>00~01</td> <td>—</td> <td>00:_Disabled</td> </tr> </tbody> </table> <table border="1"> <thead> <tr> <th>Selection</th> <th>Contents</th> </tr> </thead> <tbody> <tr> <td>00:_Disabled</td> <td>Disabled</td> </tr> <tr> <td>01:_Enabled</td> <td>Enabled</td> </tr> </tbody> </table>	Setting range	Unit	Standard value	00~01	—	00:_Disabled	Selection	Contents	00:_Disabled	Disabled	01:_Enabled	Enabled	<p>Select either one from enabled or disabled of velocity control error alarm detection. In such an operation pattern as causing a motor overshoot to the command, velocity control error may be detected by mistake. For this, set this parameter to "disabled".</p>
Setting range	Unit	Standard value												
00~01	—	00:_Disabled												
Selection	Contents													
00:_Disabled	Disabled													
01:_Enabled	Enabled													

5. Parameter [Parameter setting value [GroupC]]

■ General parameter Group C [Encoder related settings]

Page	Contents																																				
00	Position detection system choice [ABS/INCSYS]																																				
	<table border="1"> <thead> <tr> <th>Setting range</th> <th>Unit</th> <th>Standard value</th> </tr> </thead> <tbody> <tr> <td>00~01</td> <td>—</td> <td>00:_Absolute</td> </tr> </tbody> </table>	Setting range	Unit	Standard value	00~01	—	00:_Absolute	Position detection system is selected from the contents below.																													
Setting range	Unit	Standard value																																			
00~01	—	00:_Absolute																																			
01	Motor Incremental Encoder, Digital Filter [ENFIL]																																				
	<table border="1"> <thead> <tr> <th>Setting range</th> <th>Unit</th> <th>Standard value</th> </tr> </thead> <tbody> <tr> <td>00~07</td> <td>—</td> <td>01_220nsec</td> </tr> </tbody> </table>	Setting range	Unit	Standard value	00~07	—	01_220nsec	Settings for motor incremental encoder digital filter are selected from the contents below.																													
Setting range	Unit	Standard value																																			
00~07	—	01_220nsec																																			
02	External Incremental Encoder, Digital Filter [EX-ENFIL]																																				
	<table border="1"> <thead> <tr> <th>Setting range</th> <th>Unit</th> <th>Standard value</th> </tr> </thead> <tbody> <tr> <td>00~07</td> <td>—</td> <td>01_220nsec</td> </tr> </tbody> </table>	Setting range	Unit	Standard value	00~07	—	01_220nsec	Settings for external encoder digital filter are selected from the contents below.																													
Setting range	Unit	Standard value																																			
00~07	—	01_220nsec																																			
03	External Encoder Polarity Invert [EX-ENPOL]																																				
	<table border="1"> <thead> <tr> <th>Setting range</th> <th>Unit</th> <th>Standard value</th> </tr> </thead> <tbody> <tr> <td>00~07</td> <td>—</td> <td>00:_Type1</td> </tr> </tbody> </table>	Setting range	Unit	Standard value	00~07	—	00:_Type1	<p>External encoder signal polarity is selected from the contents below.</p> <p> The set value is enabled after control power is turned ON again.</p> <p>When full close controlled and the motor encoder is absolute encoder, this setting is invalid. (Set at Type1.)</p>																													
Setting range	Unit	Standard value																																			
00~07	—	00:_Type1																																			
04	External Encoder Polarity Invert [EX-ENPOL]																																				
	<table border="1"> <thead> <tr> <th>Selection</th> <th colspan="3">Contents</th> </tr> </thead> <tbody> <tr> <td>00:_Type1</td> <td>EX-Z (S3)/ Not Reversed</td> <td>EX-B (S2)/ Not Reversed</td> <td>EX-A (S1)/ Not Reversed</td> </tr> <tr> <td>01:_Type2</td> <td>EX-Z (S3)/ Not Reversed</td> <td>EX-B (S2)/ Not Reversed</td> <td>EX-A (S1)/ Reversed</td> </tr> <tr> <td>02:_Type3</td> <td>EX-Z (S3)/ Not Reversed</td> <td>EX-B (S2)/ Reversed</td> <td>EX-A (S1)/ Not Reversed</td> </tr> <tr> <td>03:_Type4</td> <td>EX-Z (S3)/ Not Reversed</td> <td>EX-B (S2)/ Reversed</td> <td>EX-A (S1)/ Reversed</td> </tr> <tr> <td>04:_Type5</td> <td>EX-Z (S3)/ Reversed</td> <td>EX-B (S2)/ Not Reversed</td> <td>EX-A (S1)/ Not Reversed</td> </tr> <tr> <td>05:_Type6</td> <td>EX-Z (S3)/ Reversed</td> <td>EX-B (S2)/ Not Reversed</td> <td>EX-A (S1)/ Reversed</td> </tr> <tr> <td>06:_Type7</td> <td>EX-Z (S3)/ Reversed</td> <td>EX-B (S2)/ Reversed</td> <td>EX-A (S1)/ Not Reversed</td> </tr> <tr> <td>07:_Type8</td> <td>EX-Z (S3)/ Reversed</td> <td>EX-B (S2)/ Reversed</td> <td>EX-A (S1)/ Reversed</td> </tr> </tbody> </table>	Selection	Contents			00:_Type1	EX-Z (S3)/ Not Reversed	EX-B (S2)/ Not Reversed	EX-A (S1)/ Not Reversed	01:_Type2	EX-Z (S3)/ Not Reversed	EX-B (S2)/ Not Reversed	EX-A (S1)/ Reversed	02:_Type3	EX-Z (S3)/ Not Reversed	EX-B (S2)/ Reversed	EX-A (S1)/ Not Reversed	03:_Type4	EX-Z (S3)/ Not Reversed	EX-B (S2)/ Reversed	EX-A (S1)/ Reversed	04:_Type5	EX-Z (S3)/ Reversed	EX-B (S2)/ Not Reversed	EX-A (S1)/ Not Reversed	05:_Type6	EX-Z (S3)/ Reversed	EX-B (S2)/ Not Reversed	EX-A (S1)/ Reversed	06:_Type7	EX-Z (S3)/ Reversed	EX-B (S2)/ Reversed	EX-A (S1)/ Not Reversed	07:_Type8	EX-Z (S3)/ Reversed	EX-B (S2)/ Reversed	EX-A (S1)/ Reversed
Selection	Contents																																				
00:_Type1	EX-Z (S3)/ Not Reversed	EX-B (S2)/ Not Reversed	EX-A (S1)/ Not Reversed																																		
01:_Type2	EX-Z (S3)/ Not Reversed	EX-B (S2)/ Not Reversed	EX-A (S1)/ Reversed																																		
02:_Type3	EX-Z (S3)/ Not Reversed	EX-B (S2)/ Reversed	EX-A (S1)/ Not Reversed																																		
03:_Type4	EX-Z (S3)/ Not Reversed	EX-B (S2)/ Reversed	EX-A (S1)/ Reversed																																		
04:_Type5	EX-Z (S3)/ Reversed	EX-B (S2)/ Not Reversed	EX-A (S1)/ Not Reversed																																		
05:_Type6	EX-Z (S3)/ Reversed	EX-B (S2)/ Not Reversed	EX-A (S1)/ Reversed																																		
06:_Type7	EX-Z (S3)/ Reversed	EX-B (S2)/ Reversed	EX-A (S1)/ Not Reversed																																		
07:_Type8	EX-Z (S3)/ Reversed	EX-B (S2)/ Reversed	EX-A (S1)/ Reversed																																		

5. Parameter

[Parameter setting value [GroupC]]

Page	Contents						
04	Encoder Pulse Divided Output, Selection [PULOUTSEL]						
	<table border="1"> <thead> <tr> <th>Setting range</th> <th>Unit</th> <th>Standard value</th> </tr> </thead> <tbody> <tr> <td>00~01</td> <td>—</td> <td>00:_Motor_Enc.</td> </tr> </tbody> </table>	Setting range	Unit	Standard value	00~01	—	00:_Motor_Enc.
Setting range	Unit	Standard value					
00~01	—	00:_Motor_Enc.					
05	Encoder Output Pulse, Divide Ratio [ENRAT]						
	<table border="1"> <thead> <tr> <th>Setting range</th> <th>Unit</th> <th>Standard value</th> </tr> </thead> <tbody> <tr> <td>1/1~1/64 2/3~2/64 1/8192~8191/8192</td> <td>—</td> <td>1/1</td> </tr> </tbody> </table>	Setting range	Unit	Standard value	1/1~1/64 2/3~2/64 1/8192~8191/8192	—	1/1
Setting range	Unit	Standard value					
1/1~1/64 2/3~2/64 1/8192~8191/8192	—	1/1					
06	Encoder Pulse Divided output, Polarity [PULOUTPOL]						
	<table border="1"> <thead> <tr> <th>Setting range</th> <th>Unit</th> <th>Standard value</th> </tr> </thead> <tbody> <tr> <td>00~03</td> <td>—</td> <td>00:_Type1</td> </tr> </tbody> </table>	Setting range	Unit	Standard value	00~03	—	00:_Type1
Setting range	Unit	Standard value					
00~03	—	00:_Type1					
07	Encoder Signal Output (PS), Format [PSOFORM]						
	<table border="1"> <thead> <tr> <th>Setting range</th> <th>Unit</th> <th>Standard value</th> </tr> </thead> <tbody> <tr> <td>00~02</td> <td>—</td> <td>00:_Binary</td> </tr> </tbody> </table>	Setting range	Unit	Standard value	00~02	—	00:_Binary
Setting range	Unit	Standard value					
00~02	—	00:_Binary					
08	Abusolute Encoder Clear Function Selection [ECLRFUNC]						
	<table border="1"> <thead> <tr> <th>Setting range</th> <th>Unit</th> <th>Standard value</th> </tr> </thead> <tbody> <tr> <td>00~01</td> <td>—</td> <td>00:_Status_MultiTurn</td> </tr> </tbody> </table>	Setting range	Unit	Standard value	00~01	—	00:_Status_MultiTurn
Setting range	Unit	Standard value					
00~01	—	00:_Status_MultiTurn					

5. Parameter [Parameter setting value【system parameter】]

■ System parameter

Page	Description	
00	Main Power, Input Type	
	Selects the input mode for power supplied to the main circuit power supply. Setting range varies depending on the hardware type.	
	Setting value	Description
	00 : _AC_3-phase	3 phase A C power is supplied to the main circuit.
	01 : _AC_Single-phase	Single phase A C power is supplied to the main circuit.
01	Motor Encoder Type	
	Motor encoder type in use is selected. Setting range varies depending on the hardware type.	
	Setting value	Description
	00 : _Incremental_ENC	Incremental Encoder
	01 : _Absolute_ENC	Absolute Encoder
02	Incremental Encoder, Function Setting	
	Incremental encoder type is selected when an incremental encoder is used for the motor encoder. Setting range varies depending on the hardware type.	
	Setting value	Description
	00 : _Standard	Wiring-Save Incremental Encoder [Standard (4-Pairs)]
	01 : _7Pairs_INC-E	Incremental Encoder with CS Signal. [7-Pairs]
03	Incremental Encoder, Resolution Setting	
	Pulse number per motor shaft rotation is set when an incremental encoder is used for the motor encoder.	
	Setting range	Unit
	500~65535	P/R
04	Absolute Encoder, Function Setting	
	Absolute encoder type is selected when an absolute encoder is used for the motor encoder. Setting range varies depending on the hardware type. Can only be selected when 01: _Absolute_ENC is selected at Page 0 1 (motor encoder type) .	
	Setting	Description
	04 : _PA035C-2.5MH_Manu	PA035, Asynchronous, 2.5Mbps, Half Duplex (Manual Setting)
	05 : _PA035C-4MH_Manu	PA035, Asynchronous, 4Mbps, Half Duplex (Manual Setting)
	06 : _RA062C-2.5MH_Manu	RA062, Asynchronous, 2.5Mbps, Half Duplex (Manual Setting)
	07 : _RA062C-4MH_Manu	RA062, Asynchronous, 4Mbps, Half Duplex (Manual Setting)
	80 : _RA062M-1MF	RA062, Manchester, 1Mbps, Full Duplex
	81 : _RA062M-2MF	RA062, Manchester, 2Mbps, Full Duplex
	82 : _ABS-RII-1M	ABS-R II 1Mbps
	83 : _ABS-RII-2M	ABS-R II 2Mbps
	84 : _ABS-E	ABS-E, 1Mbps (Absolute Encoder with Incremental Signal)
05	Absolute Encoder, Resolution Setting	
	Divisions per motor shaft rotation are set when absolute encoder is used for the motor encoder. Can only be selected when 01: _Absolute_ENC is selected at Page 0 1 (motor encoder type) .	
	Setting	Description
	00 : _2048_FMT	2048 divisions
	01 : _4096_FMT	4096 divisions
	02 : _8192_FMT	8192 divisions
	03 : _16384_FMT	16384 divisions
	04 : _32768_FMT	32768 divisions
	05 : _65536_FMT	65536 divisions
	06 : _131072_FMT	131072 divisions
	07 : _262144_FMT	262144 divisions
	08 : _524288_FMT	524288 divisions
	09 : _1048576_FMT	1048576 divisions
	0A : _2097152_FMT	2097152 divisions

5. Parameter [Parameter setting value【system parameter】]

Page	Description																
06	Combined motor model number	Note 1) In "The set up software", model numbers of combined motor and their codes are shown. When combined motor is to be changed, change the motor parameter setting of "The set up software". ⚠ Combined motor cannot be changed. ⚠ Page contents are different for digital operator. Refer to Note 1).															
08	Control Mode	Selects control mode.															
	<table border="1"> <thead> <tr> <th>Setting</th> <th>Description</th> <th>Setting</th> <th>Description</th> </tr> </thead> <tbody> <tr> <td>00 : _Torque</td> <td>Torque Control Mode</td> <td>03 : _Velo-Torq</td> <td>Velocity - Torque Switch Mode</td> </tr> <tr> <td>01 : _Velocity</td> <td>Velocity Control Mode</td> <td>04 : _Posi-Torq</td> <td>Position - Torque Switch Mode</td> </tr> <tr> <td>02 : _Position</td> <td>Position Control Mode</td> <td>05 : _Posi-Velo</td> <td>Position - Velocity Switch Mode</td> </tr> </tbody> </table> <p>⚠ when the switching type between [03:Velo-Torq] [04 : _Posi-Torq] and [05 : _Posi-Velo] is used, there is a possibility that "auto-notch frequency tuning", "auto-vibration suppressing frequency tuning" and "JOG operation" cannot be used. To use these, switch the control mode to the base side (Velo(velocity control) in case of [03 : _Velo-Torq]).</p>	Setting	Description	Setting	Description	00 : _Torque	Torque Control Mode	03 : _Velo-Torq	Velocity - Torque Switch Mode	01 : _Velocity	Velocity Control Mode	04 : _Posi-Torq	Position - Torque Switch Mode	02 : _Position	Position Control Mode	05 : _Posi-Velo	Position - Velocity Switch Mode
Setting	Description	Setting	Description														
00 : _Torque	Torque Control Mode	03 : _Velo-Torq	Velocity - Torque Switch Mode														
01 : _Velocity	Velocity Control Mode	04 : _Posi-Torq	Position - Torque Switch Mode														
02 : _Position	Position Control Mode	05 : _Posi-Velo	Position - Velocity Switch Mode														
09	Position Loop Control and Position Loop Encoder Selection	Position loop encoder is selected used for position loop control method and position loop control. Setting range varies depending on the hardware type.															
	<table border="1"> <thead> <tr> <th>Setting</th> <th>Description</th> </tr> </thead> <tbody> <tr> <td>00 : _Motor_encoder</td> <td>Semi-Closed Control / Motor Encoder</td> </tr> <tr> <td>01 : _Ext-ENC</td> <td>Fully Closed Control / External Encoder</td> </tr> </tbody> </table>	Setting	Description	00 : _Motor_encoder	Semi-Closed Control / Motor Encoder	01 : _Ext-ENC	Fully Closed Control / External Encoder										
Setting	Description																
00 : _Motor_encoder	Semi-Closed Control / Motor Encoder																
01 : _Ext-ENC	Fully Closed Control / External Encoder																
0A	External Encoder, Resolution Setting	Sets the resolution of the external encoder under full closed control. Sets the number of converted pulses for each rotation of the motor shaft.															
	<table border="1"> <thead> <tr> <th>Setting range</th> <th>Unit</th> <th>Standard value</th> </tr> </thead> <tbody> <tr> <td>500~65535</td> <td>P/R</td> <td>—</td> </tr> </tbody> </table>	Setting range	Unit	Standard value	500~65535	P/R	—										
Setting range	Unit	Standard value															
500~65535	P/R	—															
0B	Regenerative Resistor Selection	Selects the type of regenerative resistance to be connected.															
	<table border="1"> <thead> <tr> <th>Setting</th> <th>Description</th> </tr> </thead> <tbody> <tr> <td>00 : _Not_connect</td> <td>Regenerative Resistor is not Connected</td> </tr> <tr> <td>01 : _Built-in_R</td> <td>Use Built-In Regenerative Resistor</td> </tr> <tr> <td>02 : _External_R</td> <td>Use External Regenerative Resistor</td> </tr> </tbody> </table>	Setting	Description	00 : _Not_connect	Regenerative Resistor is not Connected	01 : _Built-in_R	Use Built-In Regenerative Resistor	02 : _External_R	Use External Regenerative Resistor								
Setting	Description																
00 : _Not_connect	Regenerative Resistor is not Connected																
01 : _Built-in_R	Use Built-In Regenerative Resistor																
02 : _External_R	Use External Regenerative Resistor																

Note) In case of digital operator

Page	Description	
06	Servo amplifier information	This is for maker maintenance.
07	Combined motor code	In the digital operator, motor codes of the selected servo motor are displayed. To change the combined motor, change the motor parameter setting at "The set up software". ⚠ Combined motor cannot be changed by the digital operator.

[Operations]

◆ Procedure prior to operation.....	6-1
◆ Confirmation of Installation and Wiring.....	6-3
◆ Confirmation & Change of servo amplifier specification.....	6-4
◆ Confirmation & Change of servo motor encoder specification ..	6-5
◆ Confirmation & Change of servo motor model number	6-6
◆ JOG operation.....	6-7
◆ Confirmation of I/O signal.....	6-8
◆ Confirmation of device operation.....	6-9
◆ Operation sequence.....	6-10

6. Operations

[Procedure prior to operation]

- After wiring, test run will begin. Please do not connect the shaft of the servo motor with the machine.

- Confirm installation and wiring of the servo amplifier and servo motor.

[Confirmation of installation and wiring]

Procedure	Item	Contents
1	Installation	Referring to [Chapter 2. Installation], install the servo amplifier and the servo motor. Do not connect the shaft of the servo motor into the machine to keep the status of no load.
2	Wiring and connection	Referring to [Chapter 3. Wiring], perform wirings for the power supply, the servo motor, and the upper device. However, please do not connect CN1 with the servo amplifier after wiring has been done.
3	Power supply turning on	Please turn on the power supply. Please confirm the alarm code is not being displayed at a digital operator of the servo amplifier. When it is displayed, follow the instructions in [Chapter 8 Maintenance].

- Confirm the specifications and the combination of the servo amplifier servo motor encoders.

[Confirmation and Change of specification]

Procedure	Item	Contents
4	Confirmation of servo amplifier specification	Use the AC servo system supporting tool R-Setup to confirm and set the specifications of the servo amplifier. <ul style="list-style-type: none"> • Capacity of amplifier • Control power supply input voltage • Control power supply input type • Main circuit power supply input voltage • Main circuit power supply input type • Control mode • Encoder selection for full close control • The regeneration resistance selection
5	Confirmation of servo motor encoder specification	Use the AC servo system supporting tool R-Setup to confirm and set the specifications of the servo motor encoder. <ul style="list-style-type: none"> • Motor encoder type • Incremental encoder function selection • Incremental encoder resolution • Absolute encoder function selection • Absolute encoder resolution • Confirmation of external encoder specification
6	Confirmation of combined servo motor	At the time of shipment, the smallest servo motor is combined with the servo amplifier of each capacity. Confirm the servo motor model number and change the parameter for the one in use.
7	Power supply re-turning on	Turn off the power once and turn it on again. Parameter will have been changed by turning off the power supply. Without turning off the power, even if a parameter is changed here, the parameter change will not complete.
8	Reconfirmation	Please check again the specification changes of servo amplifier and servo encoder, and combination with servo motor. Many of the troubles at test run, such as servo motor not operating, are caused by mistakes in parameter setting.

6. Operations

[Procedure prior to operation]

- The movement of the servo amplifier servo motor is confirmed by driving JOG.

[JOG driving]

Procedure	Item	Contents
9	JOG driving	Do not connect the shaft of the servo motor into the machine to keep the status of no load, and perform JOG operation. Confirm that the servo motor rotates forwards and backwards.

- Connect the upper device with CN1, and set the parameter of the I/O signal.

[I/O signal confirmation]

Procedure	Item	Contents
10	Setting of generic I/O signal	The generic I/O signal (CN1) has been set to standard at the time of shipment. Set I/O signals necessary to the servo amplifier.
11	Confirmation of input signal	Confirm the I/O signal status using the monitoring function inside the servo amplifier. Please confirm that there are protecting functions such as emergency stop, over travel, and alarm reset.
12	The servo on signal is input.	The servo on signal is input, and the servo motor is excited. Please confirm the digital operator on the servo amplifier front is displaying a shape of "8".
13	Command input	Input the command matched with the control mode in use. Confirm the command input at the servo amplifier monitoring function. Confirm that command input and the rotation direction are correct.
14	Power supply shut off	After the servo on signal is turned off, turn the power supply off.

- Connect the servo motor shaft with the machine and confirm the operation.

[Confirmation of machine' s operation function]

Procedure	Item	Contents
15	Command input (low-speed)	Input the command (low-speed) matched with the control mode in use. Confirm the normal operation of moving direction, moving distance, emergency stop, over travel (F-OT・R-OT), etc.

- Input the operation pattern in use and start to operate the machine.

[Operation]

Procedure	Item	Contents
16	Operation	At the time of shipment, real time auto-tuning (automatic adjustment for servo gain and filter) has been set. There is no need for manual tuning unless operations and characteristics are appropriate.

So far, overall procedure is shown.

More detailed procedure is described in the following pages.

6. Operations [Confirmation of installation and wiring]

■ [Procedure 1~Procedure 3] Confirmation of installation and wiring

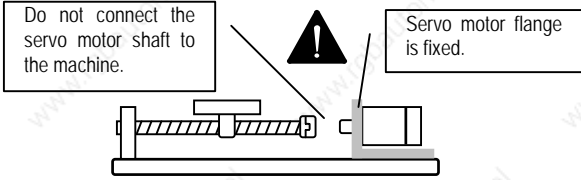
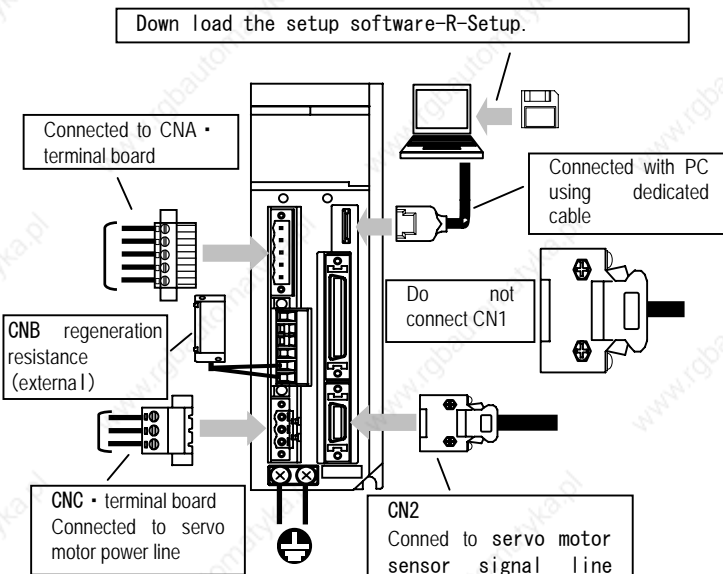
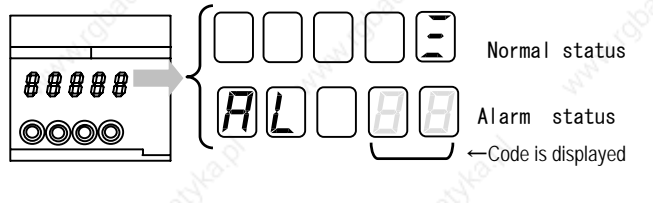
Procedure	Item	Contents
1	<p>Installation</p> <p>Install the servo amplifier and servo motor referring to [Chapter 2, Installation]. Do not connect the servo motor shaft to the machine to keep the status of no load.</p>	
2	<p>Wiring - Connecting</p> <p>Wire the power supply, servo motor and upper device referring to [Chapter 3, Wiring].</p> <p>Confirm the correct wiring. If the servo motor does not rotate or is in a state of runaway / overload in test run, wrong wiring may be the cause of it. Do not connect CN1 to servo amplifier after wiring.</p>	
3	<p>Turning on the power supply</p> <p>Turn on the power supply. Confirm that there is no alarm code displayed on the digital operator of servo amplifier. If there is one, follow the instructions in [Chapter 8, Maintenance].</p>	

6. Operations [Confirmation and change of servo amplifier specifications]

■ [Procedure 4 ~ Procedure 8] Confirming specifications and combination of servo amplifier · servo motor · encoder

Proc edur e	Item and Contents														
4	<p>Confirming servo amplifier specifications System parameter settings</p> <p>Use the AC servo system supporting tool R-Setup to confirm and set the specifications of the servo amplifier. For how to use [the setup software R-Setup], refer to [R-SETUP Instruction Manual].</p>														
	Item														
	<p>Amplifier capacity Capacity of the servo amplifier.</p>	<p>Setting cannot be changed.</p> <p>Make sure that the contents being displayed are suitable for the machine specifications.</p>													
	<p>Motor structure Structure of the motor that can be combined.</p>														
	<p>Control power input voltage Voltage to be supplied to the control power.</p>														
	<p>Input type of control power supply Input type of the control power supply.</p>														
	<p>Voltage of main circuit input power supply Power voltage to be supplied to main circuit.</p>														
	<p>Input type of control circuit power supply Selects the input type supplied to main circuit power. Change the set value to 01 : _AC_Single-phase for single phase use.</p>	<table border="1" style="width: 100%; border-collapse: collapse;"> <thead> <tr> <th style="text-align: center;">Set value</th> <th style="text-align: center;">Contents</th> </tr> </thead> <tbody> <tr> <td>00 : _AC_3-phase</td> <td>3 phase AC power is supplied to main circuit.</td> </tr> <tr> <td>01 : _AC_Single-phase</td> <td>Single phase AC power is supplied to main circuit.</td> </tr> </tbody> </table>	Set value	Contents	00 : _AC_3-phase	3 phase AC power is supplied to main circuit.	01 : _AC_Single-phase	Single phase AC power is supplied to main circuit.							
	Set value	Contents													
	00 : _AC_3-phase	3 phase AC power is supplied to main circuit.													
01 : _AC_Single-phase	Single phase AC power is supplied to main circuit.														
<p>Control mode Selects the control mode. Change the control mode suitable for upper device.</p>	<table border="1" style="width: 100%; border-collapse: collapse;"> <thead> <tr> <th style="text-align: center;">Seting</th> <th style="text-align: center;">Contents</th> </tr> </thead> <tbody> <tr> <td>00 : _Torque</td> <td>Torque control</td> </tr> <tr> <td>01 : _Velocity</td> <td>Velocity control</td> </tr> <tr> <td>02 : _Position</td> <td>Position control</td> </tr> <tr> <td>03 : _Velo-Torq</td> <td>Switching of Velocity control—torque control</td> </tr> <tr> <td>04 : _Posi-Torq</td> <td>Switching of position control —torque control</td> </tr> <tr> <td>05 : _Posi-Velo</td> <td>Switching of position control—velocity control</td> </tr> </tbody> </table>	Seting	Contents	00 : _Torque	Torque control	01 : _Velocity	Velocity control	02 : _Position	Position control	03 : _Velo-Torq	Switching of Velocity control—torque control	04 : _Posi-Torq	Switching of position control —torque control	05 : _Posi-Velo	Switching of position control—velocity control
Seting	Contents														
00 : _Torque	Torque control														
01 : _Velocity	Velocity control														
02 : _Position	Position control														
03 : _Velo-Torq	Switching of Velocity control—torque control														
04 : _Posi-Torq	Switching of position control —torque control														
05 : _Posi-Velo	Switching of position control—velocity control														
<p>Full flosed control encoder selection No change is necessary for other than full closed system. Confirm that this is set to standard value, at the time of shipment, of 00 : _Motor_encoder.</p>	<p>This is to be set when the system is full closed control.</p> <table border="1" style="width: 100%; border-collapse: collapse;"> <thead> <tr> <th style="text-align: center;">Setting</th> <th style="text-align: center;">Contents</th> </tr> </thead> <tbody> <tr> <td>00 : _Motor_encoder</td> <td>Semi-closed control / Motor encoder</td> </tr> <tr> <td>01 : _Ext-ENC</td> <td>Full closed control / External encoder</td> </tr> </tbody> </table>	Setting	Contents	00 : _Motor_encoder	Semi-closed control / Motor encoder	01 : _Ext-ENC	Full closed control / External encoder								
Setting	Contents														
00 : _Motor_encoder	Semi-closed control / Motor encoder														
01 : _Ext-ENC	Full closed control / External encoder														
<p>Regeneration resistance selection Selects the regeneration resistance to be connected.</p>	<table border="1" style="width: 100%; border-collapse: collapse;"> <thead> <tr> <th style="text-align: center;">Setting</th> <th style="text-align: center;">Contents</th> </tr> </thead> <tbody> <tr> <td>00 : _Not_connect</td> <td>Regeneration resistance not connected.</td> </tr> <tr> <td>01 : _Built-in_R</td> <td>Built-in regeneration resistance is used.</td> </tr> <tr> <td>02 : _External_R</td> <td>External regeneration resistance is used.</td> </tr> </tbody> </table>	Setting	Contents	00 : _Not_connect	Regeneration resistance not connected.	01 : _Built-in_R	Built-in regeneration resistance is used.	02 : _External_R	External regeneration resistance is used.						
Setting	Contents														
00 : _Not_connect	Regeneration resistance not connected.														
01 : _Built-in_R	Built-in regeneration resistance is used.														
02 : _External_R	External regeneration resistance is used.														

6. Operations

[JOG operation]

Procedure	Item and Contents																												
5	Confirming servo motor encoder specifications System parameter setting Use the AC servo system supporting tool R-Setup to confirm and set the specifications of the encoder. For how to use [the setup software R-Setup], refer to [R-SETUP Instruction Manual].																												
	Item																												
	Motor encoder type Selects the servo motor encoder type.	<table border="1"> <thead> <tr> <th>Setting value</th> <th>Contents</th> </tr> </thead> <tbody> <tr> <td>00 : _Incremental_ENC</td> <td>Incremental encoder</td> </tr> <tr> <td>01 : _Absolute_ENC</td> <td>Absolute encoder</td> </tr> </tbody> </table>	Setting value	Contents	00 : _Incremental_ENC	Incremental encoder	01 : _Absolute_ENC	Absolute encoder																					
	Setting value	Contents																											
	00 : _Incremental_ENC	Incremental encoder																											
	01 : _Absolute_ENC	Absolute encoder																											
	Incremental encoder function selection Selects detailed function of incremental encoder.	This is set when motor encoder type is "incremental encoder". <table border="1"> <thead> <tr> <th>Setting value</th> <th>Contents</th> </tr> </thead> <tbody> <tr> <td>00 : _Standard</td> <td>Wire-saving incremental encoder [standard (4 pairs)]</td> </tr> <tr> <td>01 : _7pairs_INC-E</td> <td>Incremental encoder with CS signal (7 pairs)</td> </tr> </tbody> </table>	Setting value	Contents	00 : _Standard	Wire-saving incremental encoder [standard (4 pairs)]	01 : _7pairs_INC-E	Incremental encoder with CS signal (7 pairs)																					
	Setting value	Contents																											
00 : _Standard	Wire-saving incremental encoder [standard (4 pairs)]																												
01 : _7pairs_INC-E	Incremental encoder with CS signal (7 pairs)																												
Incremental encoder resolution Sets the incremental encoder resolution.	Sets the pulse number of motor shaft one rotation. 500P/R ~ 65535P/R Setting unit=Pulse/Rev.																												
Absolute encoder function selection Selects detailed function of absolute encoder.	This is set when the motor encoder type is "absolute encoder". <table border="1"> <thead> <tr> <th>setting</th> <th>Contents</th> </tr> </thead> <tbody> <tr> <td>04 : PA035C-2.5MH_Manu</td> <td>PA035 Synchronous , 2.5Mbps Half duplicate communication (manual setting)</td> </tr> <tr> <td>05 : PA035C-4MH_Manu</td> <td>PA035 Synchronous , 4.0Mbps Half duplicate communication (manual setting)</td> </tr> <tr> <td>06 : RA062C-2.5MH_Manu</td> <td>RA062 Synchronous , 2.5Mbps Half duplicate communication (manual setting)</td> </tr> <tr> <td>07 : RA062C-4MH_Manu</td> <td>RA062 Synchronous , 4.0Mbps Half duplicate communication (manual setting)</td> </tr> <tr> <td>80 : RA062M-1MF</td> <td>RA062 Manchester 1Mbps Full duplicate communication</td> </tr> <tr> <td>81 : RA062M-2MF</td> <td>RA062 Manchester 2Mbps Full duplicate communication</td> </tr> <tr> <td>84 : ABS-E</td> <td>ABS-E 1Mbps (with incremental signal)</td> </tr> </tbody> </table>	setting	Contents	04 : PA035C-2.5MH_Manu	PA035 Synchronous , 2.5Mbps Half duplicate communication (manual setting)	05 : PA035C-4MH_Manu	PA035 Synchronous , 4.0Mbps Half duplicate communication (manual setting)	06 : RA062C-2.5MH_Manu	RA062 Synchronous , 2.5Mbps Half duplicate communication (manual setting)	07 : RA062C-4MH_Manu	RA062 Synchronous , 4.0Mbps Half duplicate communication (manual setting)	80 : RA062M-1MF	RA062 Manchester 1Mbps Full duplicate communication	81 : RA062M-2MF	RA062 Manchester 2Mbps Full duplicate communication	84 : ABS-E	ABS-E 1Mbps (with incremental signal)												
setting	Contents																												
04 : PA035C-2.5MH_Manu	PA035 Synchronous , 2.5Mbps Half duplicate communication (manual setting)																												
05 : PA035C-4MH_Manu	PA035 Synchronous , 4.0Mbps Half duplicate communication (manual setting)																												
06 : RA062C-2.5MH_Manu	RA062 Synchronous , 2.5Mbps Half duplicate communication (manual setting)																												
07 : RA062C-4MH_Manu	RA062 Synchronous , 4.0Mbps Half duplicate communication (manual setting)																												
80 : RA062M-1MF	RA062 Manchester 1Mbps Full duplicate communication																												
81 : RA062M-2MF	RA062 Manchester 2Mbps Full duplicate communication																												
84 : ABS-E	ABS-E 1Mbps (with incremental signal)																												
Absolute encoder resolution Sets the absolute encoder resolution. Sets the pulse number of motor shaft one rotation.	This is set when the motor encoder type is "absolute encoder". <table border="1"> <thead> <tr> <th>Setting</th> <th>Contents</th> <th>Setting</th> <th>Contents</th> </tr> </thead> <tbody> <tr> <td>00 : _2048 division</td> <td>2048 division</td> <td>06 : _131972 division</td> <td>131072 division</td> </tr> <tr> <td>01 : _4096 division</td> <td>4096 division</td> <td>07 : _262144 division</td> <td>262144 division</td> </tr> <tr> <td>02 : _8192 division</td> <td>8192 division</td> <td>08 : _524288 division</td> <td>524288 division</td> </tr> <tr> <td>03 : _16384 division</td> <td>16384 division</td> <td>09 : _1048576 division</td> <td>1048576 division</td> </tr> <tr> <td>04 : _32768 division</td> <td>32768 division</td> <td>0A : _2097152 division</td> <td>2097152 division</td> </tr> <tr> <td>05 : _65536 division</td> <td>65536 division</td> <td></td> <td></td> </tr> </tbody> </table>	Setting	Contents	Setting	Contents	00 : _2048 division	2048 division	06 : _131972 division	131072 division	01 : _4096 division	4096 division	07 : _262144 division	262144 division	02 : _8192 division	8192 division	08 : _524288 division	524288 division	03 : _16384 division	16384 division	09 : _1048576 division	1048576 division	04 : _32768 division	32768 division	0A : _2097152 division	2097152 division	05 : _65536 division	65536 division		
Setting	Contents	Setting	Contents																										
00 : _2048 division	2048 division	06 : _131972 division	131072 division																										
01 : _4096 division	4096 division	07 : _262144 division	262144 division																										
02 : _8192 division	8192 division	08 : _524288 division	524288 division																										
03 : _16384 division	16384 division	09 : _1048576 division	1048576 division																										
04 : _32768 division	32768 division	0A : _2097152 division	2097152 division																										
05 : _65536 division	65536 division																												
External encoder resolution Sets the resolution of external encoder in use.	This is set when the system is full closed control or something. Sets the pulse number converted to motor shaft one rotation. 500P/R ~ 65535P/R Setting unit=Pulse/Rev.																												

6. Operations

[JOG operation]

Procedure	Item and Contents					
6	<p><u>Confirming the combined servo motor</u> <u>System parameter setting</u></p> <p>Use the AC servo system supporting tool R-Setup to confirm and set the model type of combined servo motor. For how to use [the setup software R-Setup], refer to [R-SETUP Instruction Manual].</p>					
	<table border="1" style="width: 100%;"> <thead> <tr> <th style="width: 30%;">Item</th> <th></th> </tr> </thead> <tbody> <tr> <td><u>Model number of combined motor</u></td> <td> <p>例: Q2AA07030D (0000-0064)</p> <p style="text-align: center;">↑</p> <p><u>Model number of combined motor is displayed.</u></p> </td> </tr> <tr> <td>Shows the combined motor model number.</td> <td> <p>Combined motor can be changed at Motor parameter setting.</p> </td> </tr> </tbody> </table>	Item		<u>Model number of combined motor</u>	<p>例: Q2AA07030D (0000-0064)</p> <p style="text-align: center;">↑</p> <p><u>Model number of combined motor is displayed.</u></p>	Shows the combined motor model number.
Item						
<u>Model number of combined motor</u>	<p>例: Q2AA07030D (0000-0064)</p> <p style="text-align: center;">↑</p> <p><u>Model number of combined motor is displayed.</u></p>					
Shows the combined motor model number.	<p>Combined motor can be changed at Motor parameter setting.</p>					

Procedure	Item and Contents
7	<p><u>Turning ON the power again</u> <u>Power shut off→turn ON again</u></p> <p>Turn OFF the power of servo amplifier and turn it ON again. Turning OFF the power makes the parameter re-written. Without turning OFF the power, the parameter cannot be changed. Make sure to turn OFF→turn ON again.</p>

Procedure	Item and Contents
8	<p><u>Reconfirming the specifications</u> <u>Reconfirmation</u></p> <p>Reconfirm the specifications and combination of the changed servo amplifier, servo motor encoder and servo motor. Many of the troubles at test run, such as servo motor not operating, are caused by mistakes in parameter setting.</p>

6. Operations

[JOG operation]

■ [Procedure 9] JOG operation

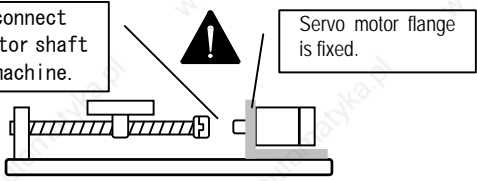
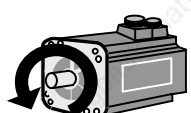
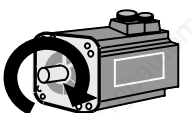
Procedure	Item	Contents			
9	JOG operation		<div style="display: flex; justify-content: space-around; align-items: center;"> <div style="border: 1px solid black; padding: 5px; font-size: small;">Go not connect servo motor shaft to the machine.</div>  <div style="border: 1px solid black; padding: 5px; font-size: small;">Servo motor flange is fixed.</div> </div>		
	Do not connect the servo motor shaft to the machine to keep the status of no load for JOG operation. Confirm that the servo motor rotates forward and backward.				
	How to use digital operator				
	Setting of [forward over travel] is to be changed. Standard setting at the time of shipment 0 d → 0 0 Can also be changed from general parameter group 9 page 00.		MODE	Press the MODE key to display basic mode.	bA 00
			▲▼▶	Press the cursor/up/down key to display b A 0 7 .	bA 07
			WR/▶	Press the WR/▶ key for more than 1 sec, and the set value is displayed.	0 d
			▲▼▶	Press the cursor/up/down key to change 0 d to 0 0 . [Forward rotation over travel disabled.]	00
	Setting of [reverse over travel] is to be changed. Standard setting at the time of shipment 0 b → 0 0 Can also be changed from general parameter group 9 page 01.		WR/▶	Press the WR/▶ key for more than 1 sec, and the values is written.	00
			MODE	Press the MODE key to display b A 0 7 again.	bA 07
			▲▼▶	Press the cursor/up/down key to display b A 0 8 .	bA 08
			WR/▶	Press the WR/▶ key for more than 1 sec, and the set value is displayed.	0 b
	Setting of [reverse over travel] is to be changed. Standard setting at the time of shipment 0 b → 0 0 Can also be changed from general parameter group 9 page 01.		▲▼▶	Press the cursor/up/down key to change 0 b to 0 0 . [Reverse over travel disabled.]	00
			WR/▶	Press the WR/▶ key for more than 1 sec, and the set value is written.	00
			MODE	Press the MODE key to terminate.	
			Forward (CCW)	Reverse (CW)	Input key
	 Motor forward rotation	 Motor reverse rotation	MODE	Press the MODE key to display test run/adjustment mode.	Ad 0
			▲	Press the ▲ key to display "Ad 5" of speed JOG.	Ad 5
			WR/▶	Press the WR/▶ key for more than 1 sec, and confirmation display "—y_n—" will appear.	—y_n—
			▲	Press the ▲ key to display "rdy". Press the ▼ key to return to "Ad 5".	rdy
			WR/▶	Press the WR/▶ key for more than 1 sec, and servo ON status.	8
▲			Press the ▲ key, and the servo motor rotates forward (CCW) at 50min ⁻¹ .	r.u.n. 8	
▼			Press the ▼ key, and the servo motor rotates backward (CW) at 50min ⁻¹ .	r.u.n. 8	
MODE			Press the MODE key to terminate. Alarm "AL dF" is displayed.	AL dF	
Alarm "AL dF" is displayed, which is not an error.					

 The speed at JOG operation can be changed at general parameter group B page 00.

6. Operations

[Confirmation of I/O signal]

■ [Procedure 10 ~ 14] Connection of upper device with CN1, parameter setting for I/O signals

Procedure	Item	Contents																											
10	I/O signal setting	Settings for generic I/O signals (CN1) are standard ones set at the time of shipment. Necessary I/O signals are set at the servo amplifier.																											
	Generic input signal Standard setting at the time of shipment	<p>General parameter Group 9</p> <table border="1"> <thead> <tr> <th>Input signal</th> <th>Name</th> <th>Set value</th> </tr> </thead> <tbody> <tr> <td>CONT1</td> <td>Servo ON function</td> <td>02:_CONT1_ON</td> </tr> <tr> <td>CONT2</td> <td>Velocity loop proportional control switching function</td> <td>04:_CONT2_ON</td> </tr> <tr> <td>CONT3</td> <td>Absolute encoder clearing function</td> <td>06:_CONT3_ON</td> </tr> <tr> <td>CONT4</td> <td>Deviation clearing function</td> <td>08:_CONT4_ON</td> </tr> <tr> <td>CONT5</td> <td>Reverse rotation over travel function</td> <td>0B:_CONT5_OFF</td> </tr> <tr> <td>CONT6</td> <td>Forward rotation over travel function</td> <td>0D:_CONT6_OFF</td> </tr> <tr> <td>CONT7</td> <td>Torque limit function</td> <td>0E:_CONT7_ON</td> </tr> <tr> <td>CONT8</td> <td>Alarm reset function</td> <td>10:_CONT8_ON</td> </tr> </tbody> </table> <p> Generic input signals (CONT 1 ~ CONT 8) shall be allocated to functions necessary to the device, referring to [Chapter 5, Parameter][Parameter setting value Group 9].</p>	Input signal	Name	Set value	CONT1	Servo ON function	02:_CONT1_ON	CONT2	Velocity loop proportional control switching function	04:_CONT2_ON	CONT3	Absolute encoder clearing function	06:_CONT3_ON	CONT4	Deviation clearing function	08:_CONT4_ON	CONT5	Reverse rotation over travel function	0B:_CONT5_OFF	CONT6	Forward rotation over travel function	0D:_CONT6_OFF	CONT7	Torque limit function	0E:_CONT7_ON	CONT8	Alarm reset function	10:_CONT8_ON
	Input signal	Name	Set value																										
CONT1	Servo ON function	02:_CONT1_ON																											
CONT2	Velocity loop proportional control switching function	04:_CONT2_ON																											
CONT3	Absolute encoder clearing function	06:_CONT3_ON																											
CONT4	Deviation clearing function	08:_CONT4_ON																											
CONT5	Reverse rotation over travel function	0B:_CONT5_OFF																											
CONT6	Forward rotation over travel function	0D:_CONT6_OFF																											
CONT7	Torque limit function	0E:_CONT7_ON																											
CONT8	Alarm reset function	10:_CONT8_ON																											
Generic output signal Standard setting at the time of shipment	<p>General parameter Group A</p> <table border="1"> <thead> <tr> <th>Page</th> <th>Name</th> <th>Standard set value</th> </tr> </thead> <tbody> <tr> <td>00</td> <td>Generic output 1</td> <td>18:_INP_ON</td> </tr> <tr> <td>01</td> <td>Generic output 2</td> <td>0C:_TLC_ON</td> </tr> <tr> <td>02</td> <td>Generic output 3</td> <td>02:_S-RDY_ON</td> </tr> <tr> <td>03</td> <td>Generic output 4</td> <td>0A:_MBR_ON</td> </tr> <tr> <td>04</td> <td>Generic output 5</td> <td>33:_ALM5_OFF</td> </tr> <tr> <td>05</td> <td>Generic output 6</td> <td>35:_ALM6_OFF</td> </tr> <tr> <td>06</td> <td>Generic output 7</td> <td>37:_ALM7_OFF</td> </tr> <tr> <td>07</td> <td>Generic output 8</td> <td>39:_ALM_OFF</td> </tr> </tbody> </table> <p> Generic output signals (OUT 1 ~ OUT 8) shall be allocated to functions necessary to the device, referring to [Chapter 5, Parameter][Parameter setting value Group A].</p>	Page	Name	Standard set value	00	Generic output 1	18:_INP_ON	01	Generic output 2	0C:_TLC_ON	02	Generic output 3	02:_S-RDY_ON	03	Generic output 4	0A:_MBR_ON	04	Generic output 5	33:_ALM5_OFF	05	Generic output 6	35:_ALM6_OFF	06	Generic output 7	37:_ALM7_OFF	07	Generic output 8	39:_ALM_OFF	
Page	Name	Standard set value																											
00	Generic output 1	18:_INP_ON																											
01	Generic output 2	0C:_TLC_ON																											
02	Generic output 3	02:_S-RDY_ON																											
03	Generic output 4	0A:_MBR_ON																											
04	Generic output 5	33:_ALM5_OFF																											
05	Generic output 6	35:_ALM6_OFF																											
06	Generic output 7	37:_ALM7_OFF																											
07	Generic output 8	39:_ALM_OFF																											

Procedure	Item	Contents
11	Confirmation of input signals	<p>Input signal status is monitored by the monitoring function inside the servo amplifier. Confirm that there are protective functions such as emergency stop, over travel and alarm reset.</p> <p> Confirm that every I/O signal is properly functioning using generic input (CONT8 ~ 1) monitor and generic output (OUT8 ~ 1) monitor, referring to [Chapter 4, Digital operator][How to operate monitor mode].</p>

Procedure	Item	Contents										
12	Servo ON signal is input.	<p>Servo ON signal is input and the servo motor is excited. Confirm that the digital operator on the servo amplifier front is drawing the character "8".</p> <p> The display shown below indicates over travel status. When there is nothing wrong with the device, check again the above procedure 10 ~ 11 and [Chapter 3, Wiring] [Generic input wiring example].</p> <p>Over travel { <table border="1" style="display: inline-table; vertical-align: middle;"> <tr> <td style="width: 20px; height: 20px;"></td> <td style="width: 20px; height: 20px;"></td> <td style="width: 20px; height: 20px;"></td> <td style="width: 20px; height: 20px;"></td> <td style="width: 20px; height: 20px; text-align: center;">7</td> </tr> <tr> <td style="width: 20px; height: 20px;"></td> <td style="width: 20px; height: 20px;"></td> <td style="width: 20px; height: 20px;"></td> <td style="width: 20px; height: 20px;"></td> <td style="width: 20px; height: 20px; text-align: center;">8</td> </tr> </table> }</p>					7					8
				7								
				8								

6. Operations [Confirmation of I/O signals / Confirmation of device operation]

Procedure	Item	Contents								
13	Command input	<p>Input the command suitable for the control mode in use. Check that the rotation direction matches the command input. Confirm the command input using monitoring function inside the servo amplifier.</p> <ul style="list-style-type: none"> When velocity controlled, torque controlled. <table border="1" style="margin-left: 20px;"> <tr> <td colspan="2">Monitor mode O D</td> </tr> <tr> <td>Analog velocity command / Analog torque command input voltage</td> <td>Command voltage being input is displayed.</td> </tr> </table> When position controlled. <table border="1" style="margin-left: 20px;"> <tr> <td colspan="2">Monitor mode O E</td> </tr> <tr> <td>Position pulse monitor (Position command pulse input frequency)</td> <td>Command pulse frequency being input is displayed.</td> </tr> </table> <p> Many of the cases when monitor values do not change with command input are resulted from wrong wiring. Check the wiring again, referring to [Chapter3, Wiring] [Terminal layout] [Wiring example of input circuit].</p>	Monitor mode O D		Analog velocity command / Analog torque command input voltage	Command voltage being input is displayed.	Monitor mode O E		Position pulse monitor (Position command pulse input frequency)	Command pulse frequency being input is displayed.
Monitor mode O D										
Analog velocity command / Analog torque command input voltage	Command voltage being input is displayed.									
Monitor mode O E										
Position pulse monitor (Position command pulse input frequency)	Command pulse frequency being input is displayed.									

Procedure	Item	Contents
14	Power shut off	Turns OFF the servo ON signal, then turns OFF the power supply.

- [Procedure 15] Connect the servo motor shaft with the machine and check the operation.

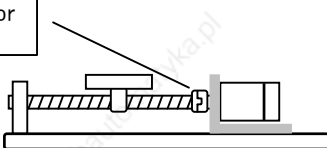
Procedure	Item	Contents
15	Command input (low speed)	<p>Connect the servo motor shaft with the machine</p>  <p>Input the command (low speed) suitable for the control mode in use. Check the operation direction, distance, emergency stop and over travel (F-OT · R-OT) so that they are properly operating.</p>

- [Procedure 16] Input the command of the operation pattern in use and start the machine.

Procedure	Item	Contents
16	Operation	At the time of shipment, auto-tuning (auto-adjustment for servo gain and filter, etc.) has been set. If there is nothing wrong with operation, manual tuning is not necessary.

6. Operations

[Operation sequence]

■ Operation sequence from power turn ON to power shut OFF at the standard shipment setting

● [Power ON → Servo ON]

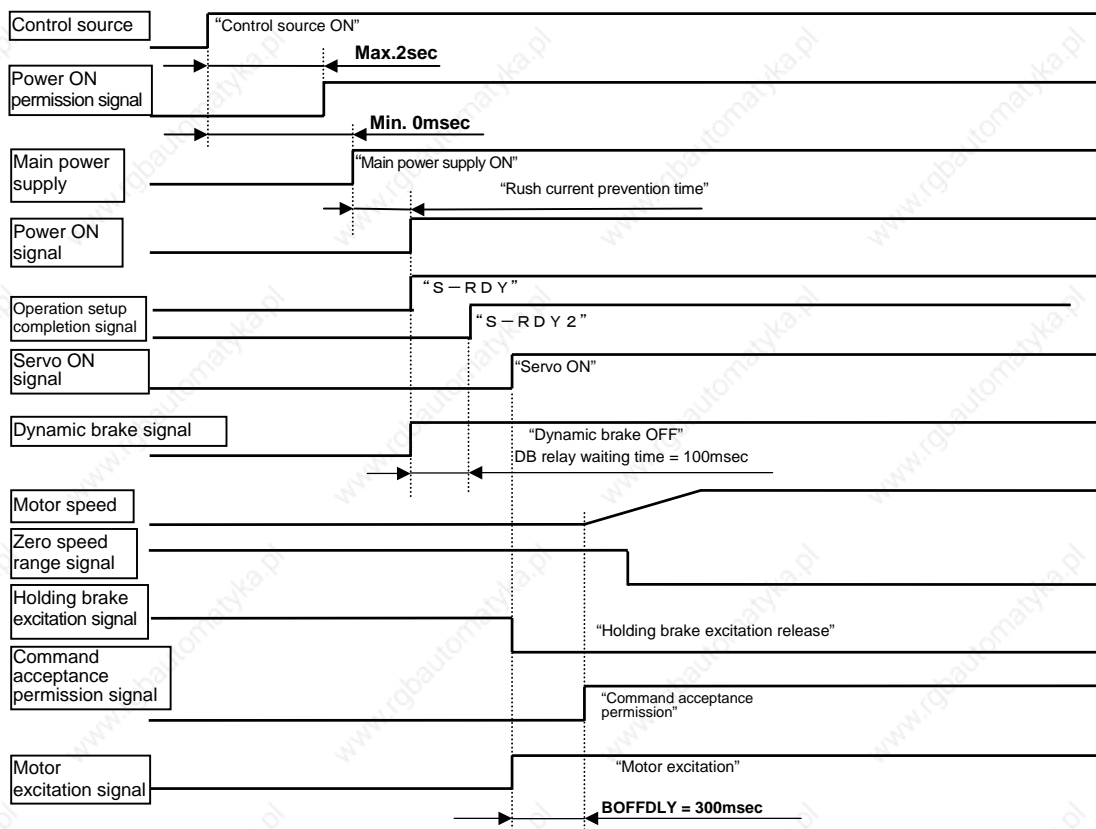

● [Servo OFF → Power OFF]

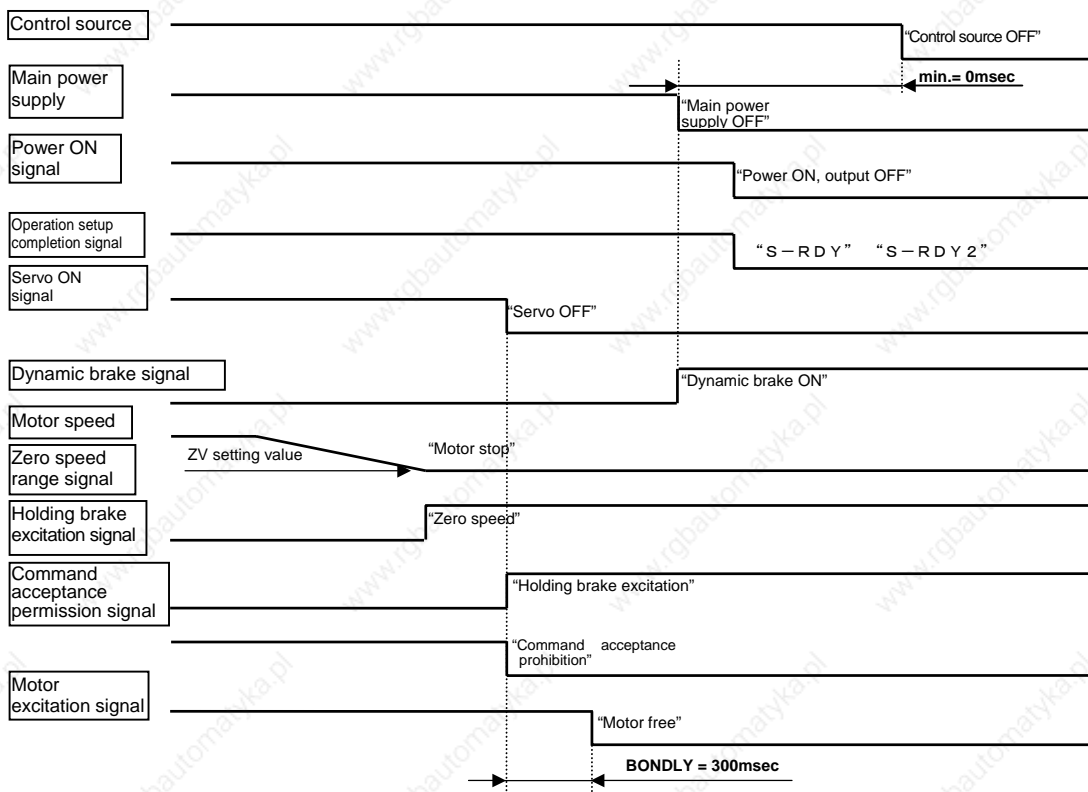

6. Operations

[Operation sequence]

■ Alarm sequence

When an alarm rings, the servo motor is stopped by dynamic brake or servo brake. Which brake is used depends on the alarm. Refer to [Chapter 8, Maintenance] [Alarm list].

● Stop by dynamic brake at alarm

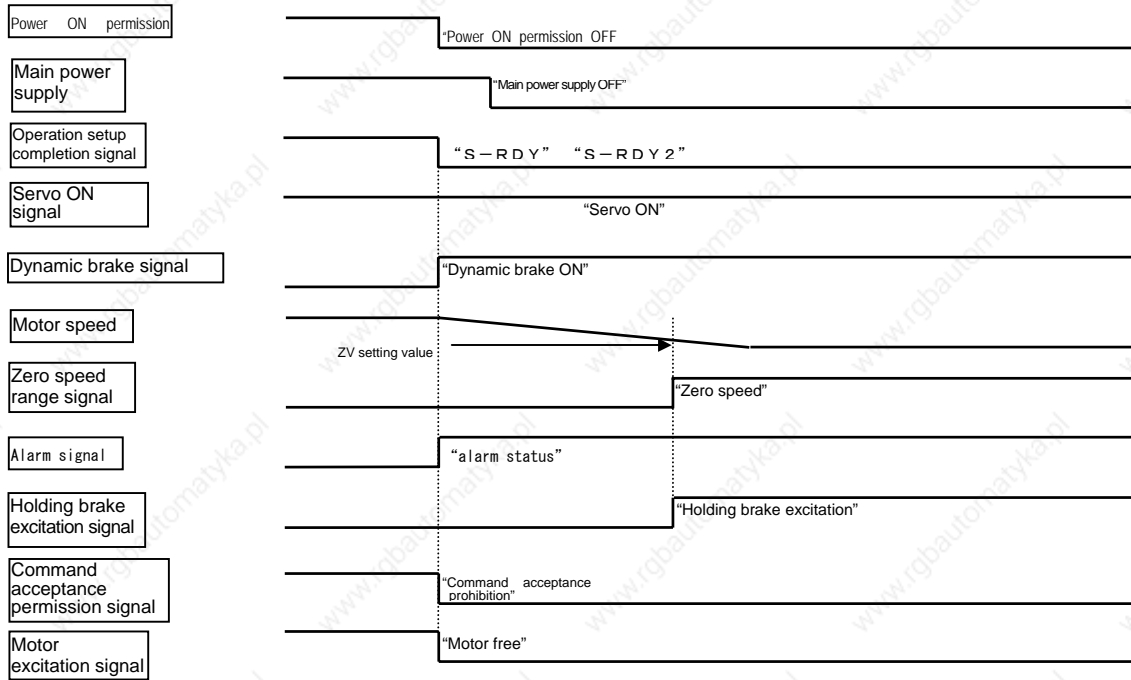

● Stop by servo brake at alarm

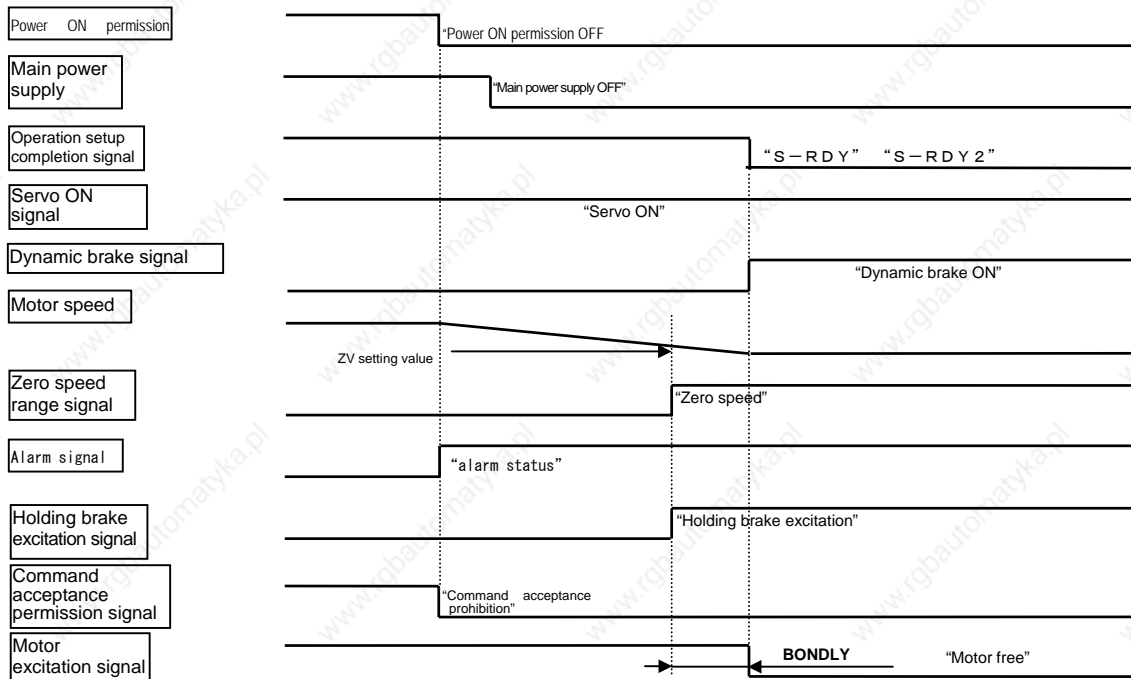

Install a protective circuit referring to [Chapter 3, Wiring] [Wiring example of high voltage circuit, protective circuit]. The above sequence is the one when protective circuit is installed.

6. Operations

[Operation sequence]

■ Sequence at alarm reset

Alarms can be reset by inputting alarm reset signal from generic input signal.

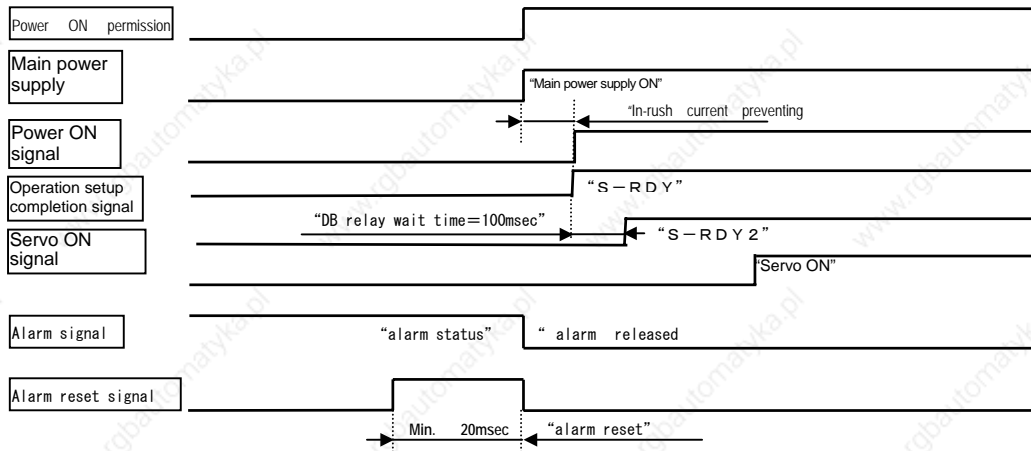

Some alarms cannot be reset unless the power is reset (control power is turned OFF and ON again) or encoder is cleared. Refer to [Chapter 8, Maintenance] [Alarm list].

■ Sequence when power is turned OFF during operation (During servo ON)

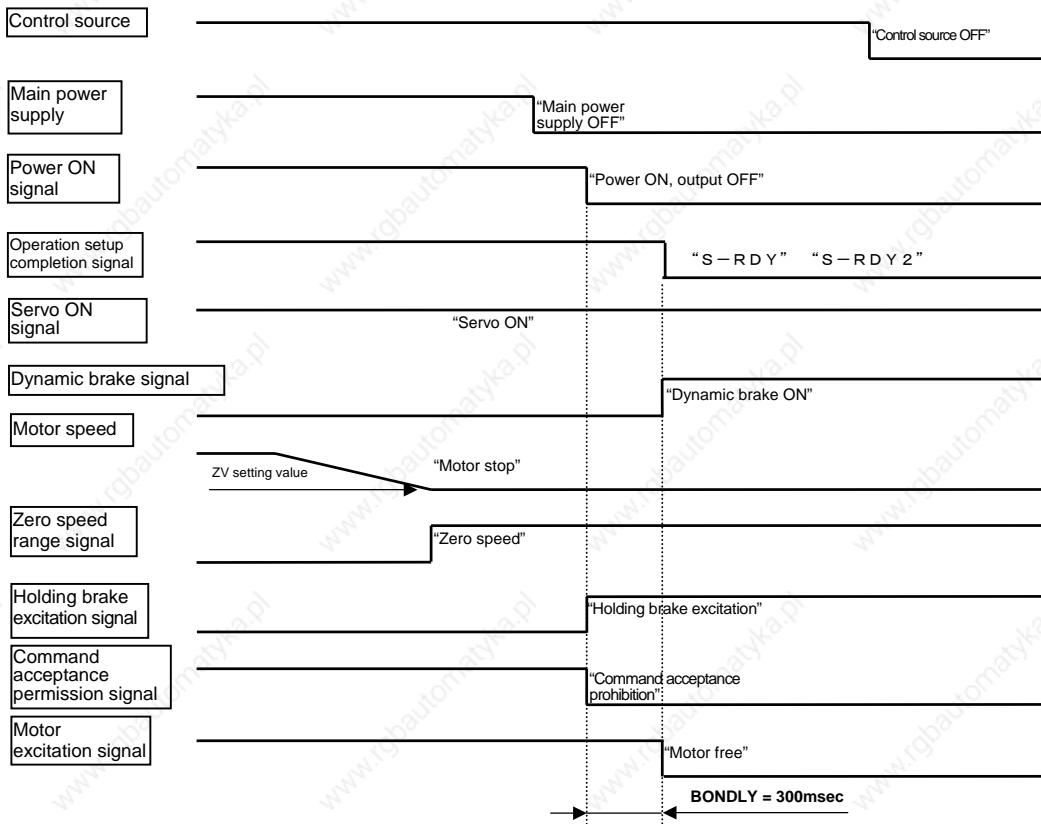

[Adjustment • Functions]

◆	Servo gain tuning.....	7-1
◆	Functions of Group 8.....	7-7
◆	Functions of Group 9.....	7-25
◆	Functions of Group B.....	7-31
◆	Functions of Group C.....	7-36
◆	Functions of monitors.....	7-39

7 . Adjustment • Functions

[Servo gain tuning]

Structure of tuning General parameter Group 0

At “parameter Group 0”, tuning structure of the R series servo amplifier is as follows.

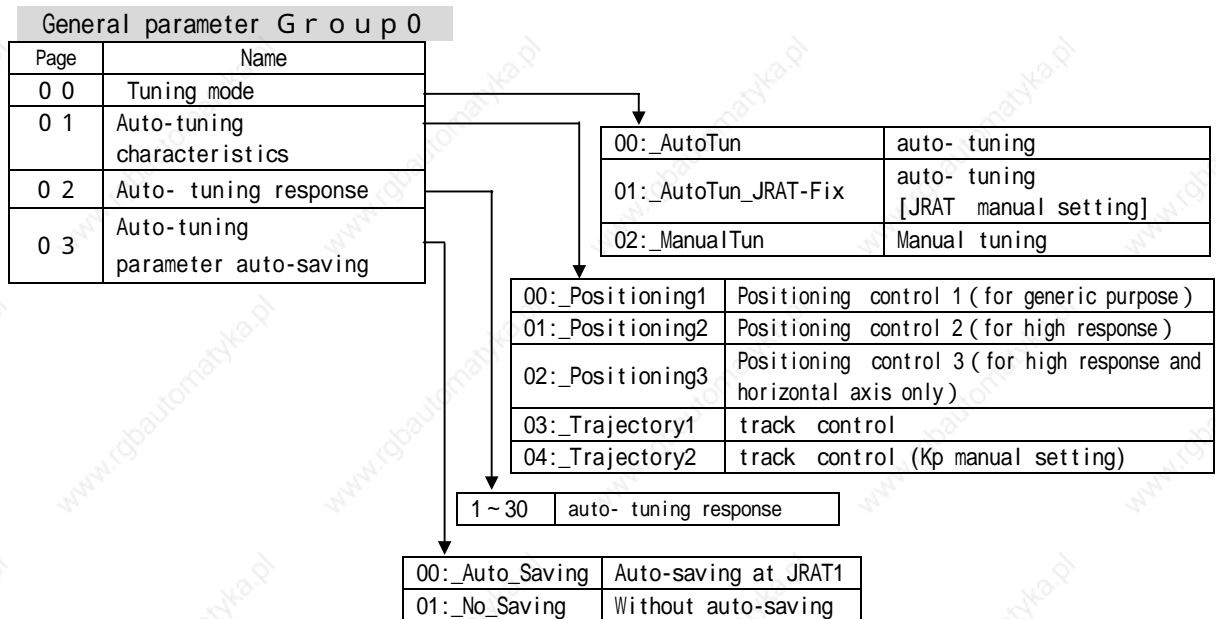

Tuning mode [page 0 0]

00:_AutoTun auto- tuning

The servo amplifier estimates the load inertia moment ratio of the machine and equipment at real time and automatically tunes the servo gain so that it will become the best one. The parameters for the servo amplifier to automatically tune vary depending on the selected auto-tuning characteristics.

The servo amplifier estimates the load inertia moment ratio at the time of acceleration/deceleration. Therefore, for operations with only excessively low acceleration/deceleration time constant or with only low torque with low velocity, this mode cannot be used. Also, operations with large disturbance torque or with large mechanical clearance, this mode cannot be used, either.

01:_AutoTun_JRAT-Fix Usage at Auto-tuning [JRAT manual setting].

01:_AutoTun_JRAT-Fix Auto-tuning [JRAT manual setting]

Based on the load inertia moment ratio (JRAT1) which was set, the servo amplifier automatically tunes and makes the servo gain the best one. The parameters for the servo amplifier to automatically tune vary depending on the selected auto-tuning characteristics.

02:_ManualTun Manual tuning

This is used in order for adjusting the servo gain to the machine and equipment to ensure the maximum response, and when characteristics in auto-tuning are insufficient.

Auto- tuning characteristics [page 0 1]

Characteristics adjusted to machines and equipment are selected when **Auto-tuning** and **Auto-tuning [JRAT manual setting]** are used.

When **Manual tuning** is used, this does not function.

Auto- tuning response [page 0 2]

Set this when **Auto- tuning** and **Auto- tuning [JRAT manual setting]** are used. The larger set value makes the response higher. Set this suitable for the equipment rigidity.

When **Manual tuning** is used, this does not function.

Auto-tuning parameter auto-saving [load inertia moment ratio] [page 0 3]

The “load inertia moment ratio” obtained from auto-tuning is automatically saved in parameter JRAT1 at every 2 hours. The set value is enabled when **auto-tuning** is used.

When **Auto-tuning [JRAT manual setting]** and **Manual tuning** are used, this does not function.

7 . Adjustment • Functions

[Servo gain tuning]

Tuning method selecting procedure

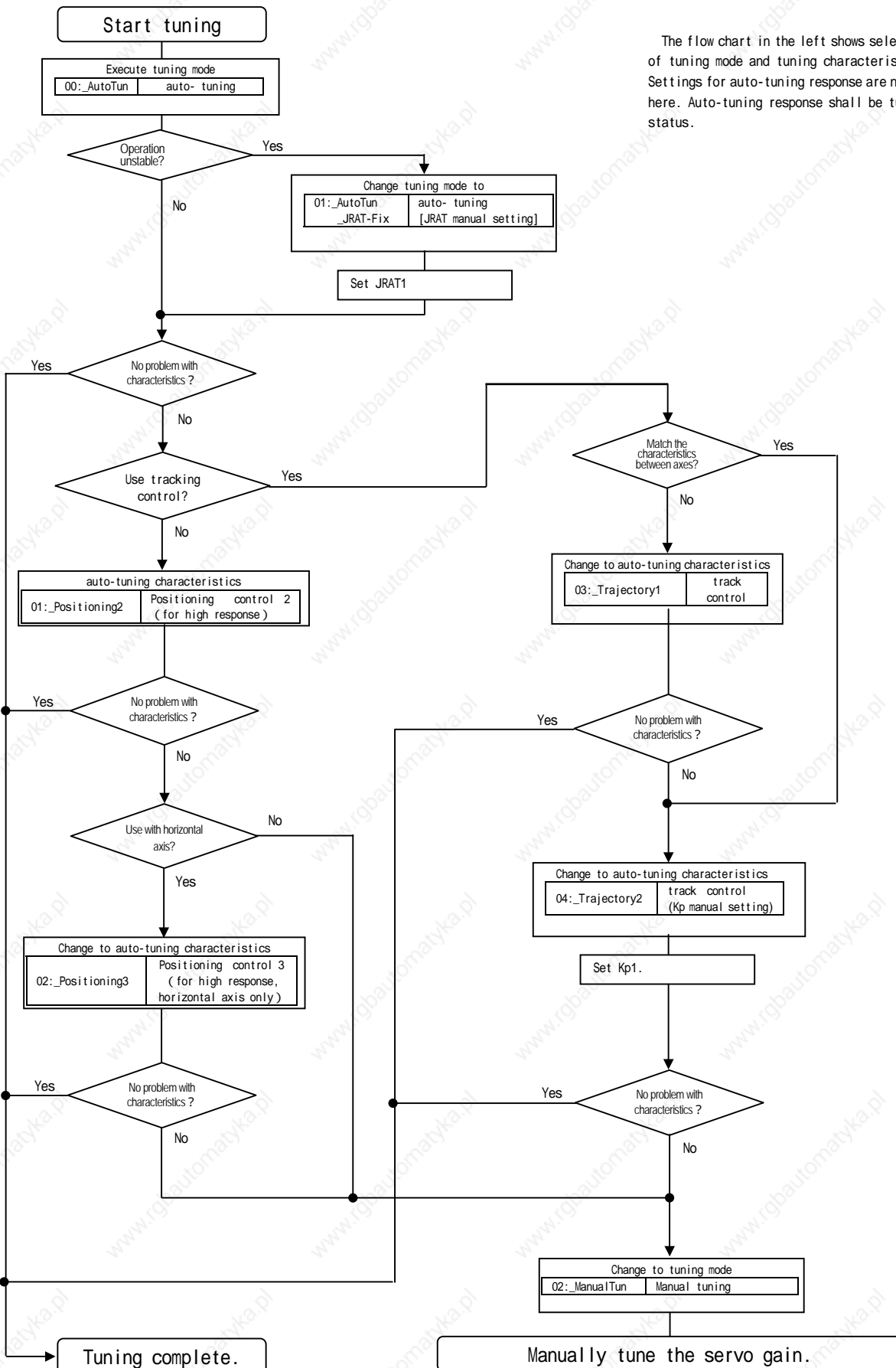

The flow chart in the left shows selecting method of tuning mode and tuning characteristics. Settings for auto-tuning response are not indicated here. Auto-tuning response shall be tuned at each status.

7 . Adjustment • Functions

[Servo gain tuning]

Monitoring servo gain adjustment parameter

The following parameters can be monitored when auto-tuning is used.

Digital operator

Monitor mode	Name
Page 1 5	Load inertia moment ratio monitor
Page 1 6	Position loop proportional gain monitor
Page 1 8	Velocity loop proportional gain monitor
Page 1 9	Velocity loop integral time constant monitor
Page 1 A	torque command filter monitor

R - S E T U P

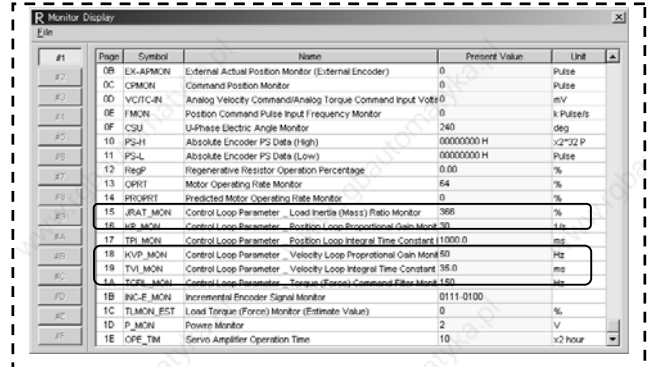

For how to operate these, refer to “Chapter 4, Digital operator”.

For how to operate these, refer to “R-SETUP Instruction Manual”.

Using auto-tuning result at manual tuning.

At manual tuning, auto-tuning result is saved as a batch or by selection using R - S E T U P, and can be used as controlling parameter.

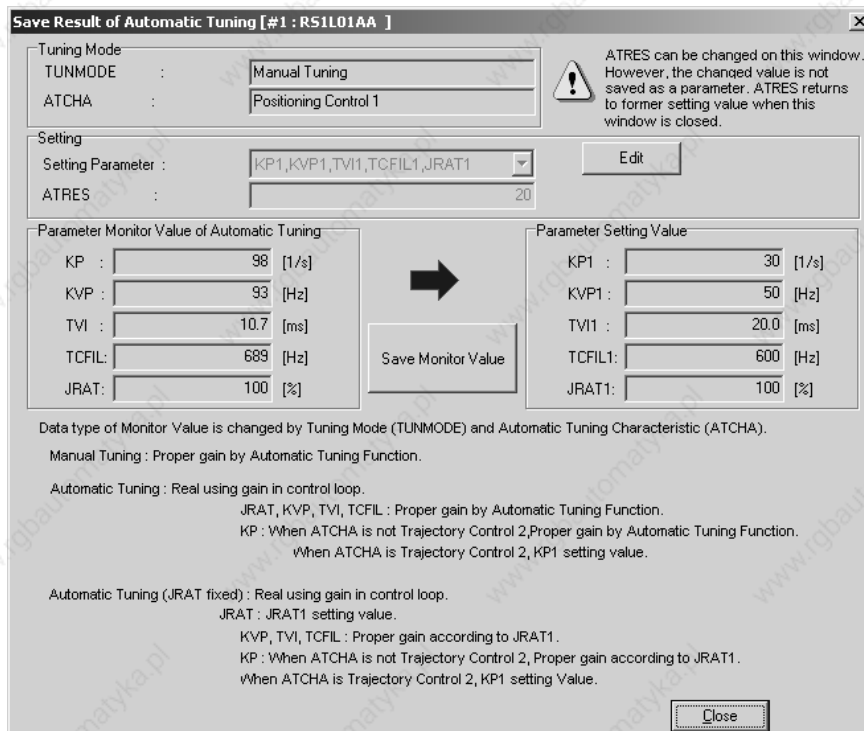

For how to operate these, refer to “ R-SETUP Instruction Manual ”.

Note) In the setting of TUNMODE=02:_ManualTun, parameter setting value is used in the control loop. When auto-tuning result saving is executed, the gain parameter being used will change (except during gain switch over). Therefore, the motor operation may change suddenly. Execute auto-tuning result saving while servo OFF or motor stoppage.

Servo system structure

Servo system consists of 3 subsystems; the position loop, the velocity loop and the current loop. High response is required for the internal loops. If this structure is compromised, it could result in instability, low response, vibration or oscillation.

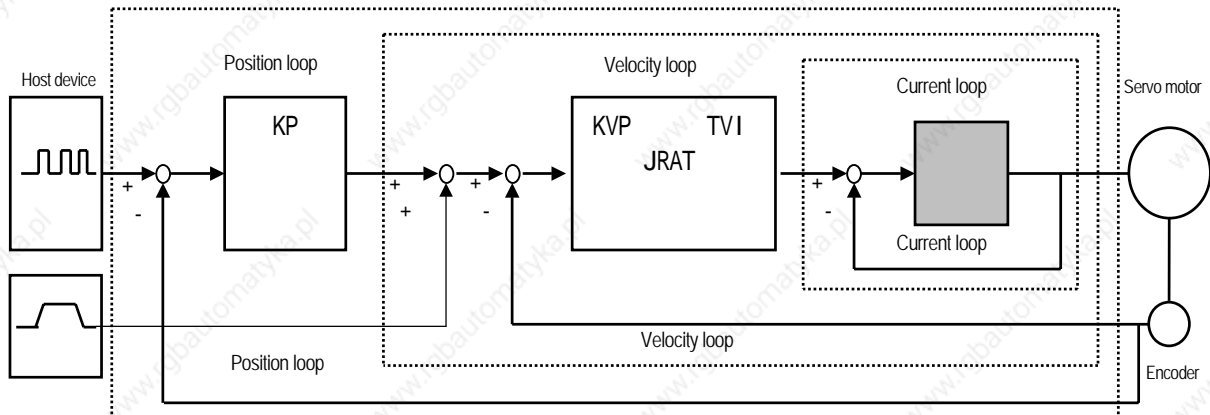

The response of the current loop is ensured internally in the servo amplifier, there is no need for the user to make additional adjustments.

Servo adjustment parameters

Position command filter [PCFIL]

When the position command resolution is low, set this parameter to suppress the ripples contained in the position command. The larger value of this will make the ripple suppressing effect greater, however, delay will be greater.

When high tracking control position compensation gain is set to other than 0%, this parameter is automatically set.

Position loop proportional gain [KP]

Set this equivalent to $KP_{[1/S]} = KVP_{[Hz]} / 4 \cdot 2$.

High tracking control position compensation gain [TRCPGN]

When tracking effect needs to be improved under high resolution of position command, increase this parameter after adjustment of high tracking control velocity compensation gain.

Feed forward gain [FFGN]

Tracking effect of position command can be improved by increasing this gain.

Under positioning control, set this to approximately 30 ~ 40%.

When high tracking control position compensation gain is set to other than 0%, this parameter is automatically set.

Feed forward filter [FFFIL]

When position command resolution is low, set this parameter to suppress ripples.

Velocity command filter [VCFIL]

Under velocity control, when there is a big noise component contained in velocity command, set this parameter to suppress the noise.

Velocity loop proportional gain [KVP]

Set this as high as possible within such a stable operation range as not to cause vibration or oscillation of the machine. If JRAT is accurately set, the set value of KVP becomes the velocity loop response zone.

Velocity loop integration time constant [TVI]

Set this equivalent to $TVI_{[ms]} = 1000 / (KVP_{[Hz]})$.

Load inertia moment ratio [JRAT]

Set the value calculated as shown below.

$$JRAT = \frac{\text{Motor axis converted load inertia moment} \quad \text{【JL】}}{\text{Motor inertia moment} \quad \text{【JM】}} \times 100\%$$

High tracking control velocity compensation gain [TRCVGN]

Tracking effect can be improved by increasing compensation gain.

Adjust this so as to shorten the positioning setting time.

Set the value of JRAT properly to use this function.

Torque command filter [TCFIL]

When rigidity of the mechanical device is high, set this value high and the velocity loop proportional gain can be set to high. When rigidity of the mechanical device is low, set this value low and resonance in high frequency zone and abnormal sound can be suppressed. For normal usage, set this below 1200 Hz.

Adjustment method of vibration suppressing control

Set vibration suppressing frequency to suppress the low frequency vibration at the tip or the body of the machine. Vibration suppressing frequency is obtained by executing auto-tuning of vibration suppressing frequency or by calculating vibration frequency of vibrating point at positioning and its reciprocal. When vibration does not stop with the vibration suppressing control, there is a possibility that the gain for control system may be too high. In this case, lower the control system gain. Also, when used together with high tracking control velocity compensation gain, vibration suppressing effect may be greater.

Vibration suppressing control function can be used together with auto-tuning.

Adjustment method of notch filter

Set the torque command notch filter to suppress high frequency resonance resulted from coupling and rigidity of the device mechanism. Notch filter center frequency can be obtained by executing auto-notch filter tuning or by system analysis.

Torque command notch filter function can be used together with auto-tuning.

When resonance of the device mechanism does not stop even after this parameter is set, there may be two or more resonance points. In this case, insert notch filters B, C and D to suppress each of them. If not yet suppressed, there is a possibility that auto-tuning response or control gain is too high. If so, lower the auto-tuning response or control gain.

Adjustment method of disturbance observer

Set the disturbance observer to suppress the disturbance applied to the motor.

At first, use the low frequency observer characteristics. If not suppressed by that, use that for medium frequency. Gradually increase the observer compensation gain.

The higher the observer compensation gain becomes, the more the disturbance suppressing characteristics will be improved.

However, if it is excessively high, oscillation may result. Use this within the range not causing oscillation.

Disturbance observer cannot be used with auto-tuning.

7 . Adjustment • Functions

[Servo gain tuning]

Adjustment method of gain switch over

When tracking effect is insufficient even if basic parameters of high tracking control position compensation gain and high tracking control velocity compensation gain are set, set the gain switch over so that tracking effect can be improved.

(Example)Gain is increased near positioning complete.

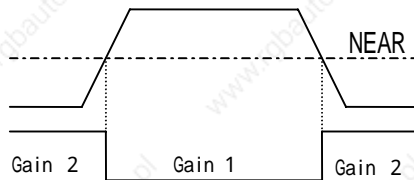

The value of gain 2 shall be set to 1.2 times the value of gain 1.

Gain switch over function cannot be used with auto-tuning.

Adjustment method of high setting control

When tracking effect is insufficient even after gain switch over, set the high setting control parameter and in-position setting characteristics can be improved. When position command resolution is low, set the value of command velocity calculation low pass filter low. Set the acceleration compensation so that the position deviation near acceleration conclusion becomes small. Set the deceleration compensation so that the position deviation near deceleration conclusion (positioning complete) becomes small.

This function cannot be used together with auto-tuning.

How to make R series control characteristics equal to Q series standard characteristics

Parameter change as follows can make the status equal to Q series standard characteristics.

Group	Page		Before change	After change
0	00	Tuning mode	00:_AutoTun	02:ManualTun
1	16	High tracking control velocity compensation gain	0%	100%

7. Adjustment · Functions

[Functions of Group 8][Position command pulse]

■ Functions of Group 8

[Group 8] 00

Position, velocity, torque command input polarity [CMDPOL]

Velocity control

Position control

Torque control

The rotation direction of the servo motor can be reversed without modifying the input command wiring or the servo motor wiring.

Input command	Command polarity	Rotation direction	Selected value	Input command	Command polarity	Rotation direction	Selected value
Position command	+	Forward	00: _PC+_VC+_TC+	Position command	+	Reverse	04: _PC-_VC+_TC+
Velocity command	+	Forward		Velocity command	+	Forward	
Torque command	+	Forward		Torque command	+	Forward	
Position command	+	Forward	01: _PC+_VC+_TC-	Position command	+	Reverse	05: _PC-_VC+_TC-
Velocity command	+	Forward		Velocity command	+	Forward	
Torque command	+	Reverse		Torque command	+	Reverse	
Position command	+	Forward	02: _PC+_VC-_TC+	Position command	+	Reverse	06: _PC-_VC-_TC+
Velocity command	+	Reverse		Velocity command	+	Reverse	
Torque command	+	Forward		Torque command	+	Forward	
Position command	+	Forward	03: _PC+_VC-_TC-	Position command	+	Reverse	07: _PC-_VC-_TC-
Velocity command	+	Reverse		Velocity command	+	Reverse	
Torque command	+	Reverse		Torque command	+	Reverse	

* Using the initial factory settings, the servo motor rotates in the forward (CCW) direction with a positive (+) input, and in the reverse (CW) direction with a negative (-) input.

Standard command input polarity setting

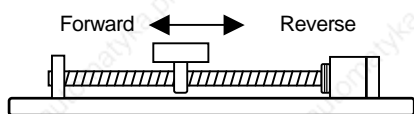

+input=forward (CCW) -input=reverse(CW)



Modified command input polarity setting

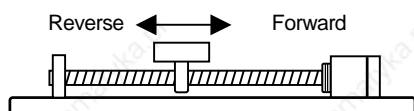

+input=reverse (CW) -input=forward (CCW)



7. Adjustment · Functions

[Functions of Group 8][Position command pulse]

[Group 8] 1 1

Position command pulse selection [PCPTYP]

Position control mode

3 types of location command pulse can be selected; make this selection per the specifications of the host unit.

Selected value	内容
00: F-PC_R-PC	Forward (positive direction) pulse +reverse (reverse direction) pulse
01: 2PhasePulse	90° phase difference 2 phase pulse string
02: CODE_PC	Code + pulse string

The location command pulse input command is the input command used for location control. Connect to CN1 location command pulse input.

Forward	Reverse
Forward pulse (F-PC) : CN1-26	Reverse pulse (R-PC) : CN1-28
Forward pulse (F-PC) : CN1-27	Reverse pulse (R-PC) : CN1-29
Forward pulse SG : CN1-47	Reverse pulse SG : CN1-48

There are 2 output types for the host unit, the “Line driver output” and the “Open collector output”.

Using line driver output

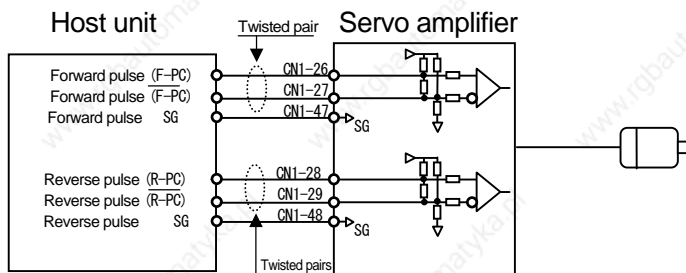

- * Always connect SG.
- * Line Receiver : HD26C32 or equivalent

Using open collector output

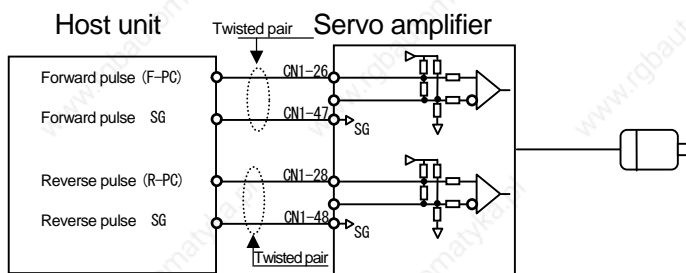

- * Always connect SG.
- * Line Receiver : HD26C32 or equivalent

7. Adjustment · Functions

[Functions of Group 8][Position command pulse]

[Group 8] 1 2

Position command pulse count polarity [PCPPOL]

Position control mode

Position command pulse count polarity can be selected from the following 4 types. Select the one suitable for the host unit.

Selected value	Contents
00:_Type1	F-PC: Count at leading edge. / R-PC: Count at leading edge.
01:_Type2	F-PC: Count at trailing edge. / R-PC: Count at leading edge.
02:_Type3	F-PC: Count at leading edge. / R-PC: Count at trailing edge.
03:_Type4	F-PC: Count at trailing edge / R-PC: Count at trailing edge.

[Group 8] 1 3

Position command pulse digital filter [PCPFIL]

Position control mode

When the time for minimum pulse width at position command input maximum frequency is less than the digital filter set value, alarm "AL D2" will be issued. Set the smaller value for digital filter than the time of minimum pulse width at the time of position command input maximum frequency. Select the position command pulse digital filter setting from the followings according to the command pulse type of the unit in use.

Forward pulse string + Reverse pulse string

Selected value	Minimum pulse width [t]	Position command input maximum frequency [f]
00	t > 834 nsec	f < 599 Kpps
01	t > 250 nsec	f < 2.0 Mpps
02	t > 500 nsec	f < 1.0 Mpps
03	t > 1.8 μsec	f < 277 Kpps
04	t > 3.6 μsec	f < 138 Kpps
05	t > 7.2 μsec	f < 69 Kpps
06	t > 125 nsec	f < 4 Mpps
07	t > 83.4 nsec	f < 5.9 Mpps

90° phase difference 2 phase pulse

Selected value	A phase · B phase Minimum edge interval [t]	Position command input maximum frequency [f]
00	t > 834 nsec	f < 599 Kpps
01	t > 250 nsec	f < 2.0 Mpps
02	t > 500 nsec	f < 1.0 Mpps
03	t > 1.8 μsec	f < 277 Kpps
04	t > 3.6 μsec	f < 138 Kpps
05	t > 7.2 μsec	f < 69 Kpps
06	t > 164 nsec	f < 1.5 Mpps
07	t > 164 nsec	f < 1.5 Mpps

Code + pulse string

Selected value	Minimum pulse width [t]	Position command input maximum frequency [f]
00	t > 834 nsec	f < 599 Kpps
01	t > 250 nsec	f < 2.0 Mpps
02	t > 500 nsec	f < 1.0 Mpps
03	t > 1.8 μsec	f < 277 Kpps
04	t > 3.6 μsec	f < 138 Kpps
05	t > 7.2 μsec	f < 69 Kpps
06	t > 125 nsec	f < 4 Mpps
07	t > 83.4 nsec	f < 5.9 Mpps

7. Adjustment · Functions

[Functions of Group 8][Position command pulse]

Command pulse	Command pulse timing		
Forward rotation pulse string + Reverse rotation pulse string			
90° phase difference 2 phase pulse			
code + pulse string			
	Forward rotation pulse + Reverse rotation pulse	90° phase difference 2 phase pulse	Code + pulse string
t1 · t8	≤ 0.1 μs	≤ 0.1 μs	≤ 0.1 μs
t2 · t9	≤ 0.1 μs	≤ 0.1 μs	≤ 0.1 μs
ts1 · ts2 ts3 · ts4	> T	> T	> T
t4 · t5 · t6 · t7	—	> 250ns	—
(t3/T) x 100	50%	50%	50%

7. Adjustment · Functions [Functions of Group 8] [Electronic gear · Positioning method]

[Group 8] 15、16

Electronic gear * [GER*]

Position control mode

This function allows a distance setting on the servo motor in reference to the location command pulse from the unit.

Setting range	Unit	Standard set value
1/32767~32767/1	—	1/1

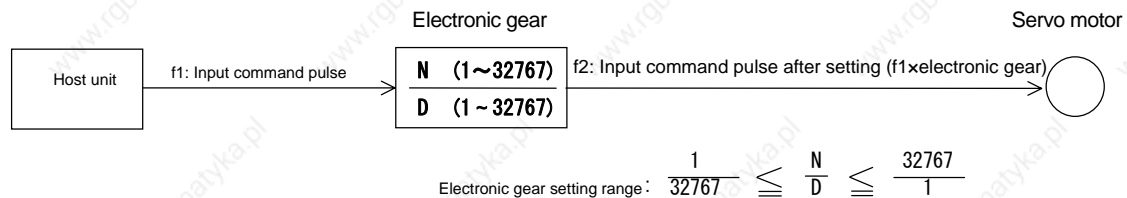

Refer to “Materials; Electronic Gear”.

[Group 8] 17

Positioning method [EDGEPOS]

Position control mode

The location of positioning stop is selected; between encoder pulses or at edge.

Selected value	Contents
00: Pulse_Interval	Positioning between pulses
01: Pulse_Edge	Positioning at edge

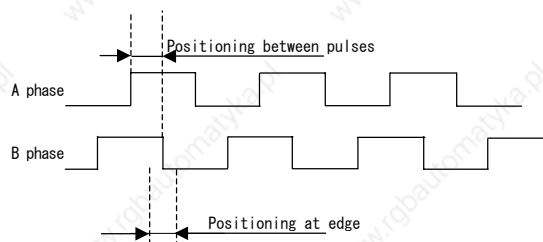

[Group 8] 18

Positioning complete signal / position deviation monitor [PDEVMON]

Position control mode

Positioning complete signal when the position control mode is used, and position command used for outputting position deviation monitor can be selected from before or after the position command filter passes.

Selected value	Contents
00: After_Filter	Compare “position command value” and “feedback value” after filter passes.
01: Before_Filter	Compare “position command value” and “feedback value” before filter passes.

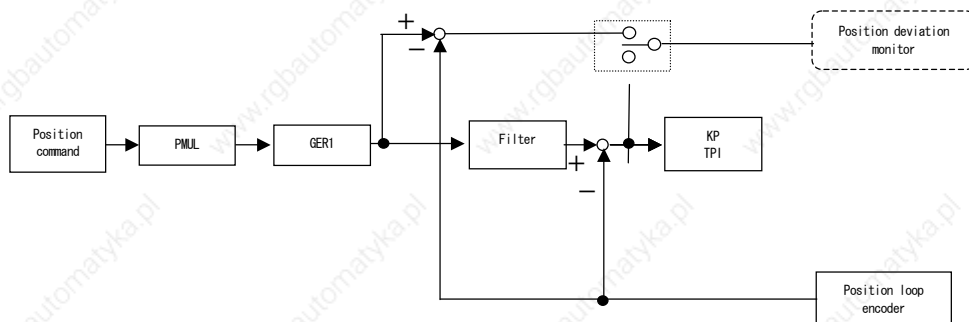

7. Adjustment - Functions [Functions of Group 8] [Deviation clear]

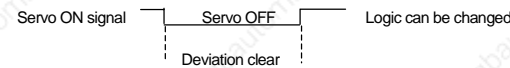
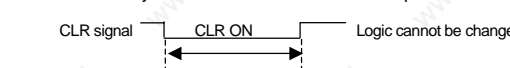
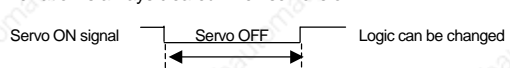
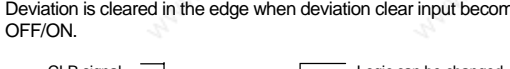
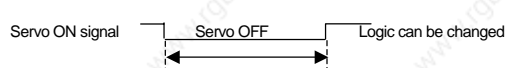
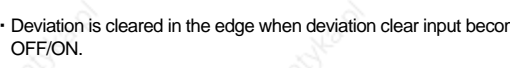
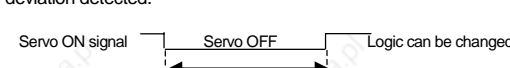
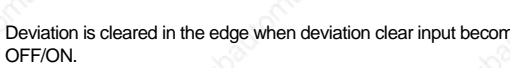
[Group 8] 19		Location control type
Deviation clear selection [CLR]		
This function is used for changing the location deviation counter in the servo amplifier from the host unit to zero.		
Selection	Description	
0H Servo OFF/deviation clear: Deviation clear input/level detection	<ul style="list-style-type: none"> Deviation is always cleared when servo is off.  <ul style="list-style-type: none"> Deviation is always cleared when deviation clear input is ON. 	
1H Servo OFF/deviation clear: Deviation clear input / edge detection	<ul style="list-style-type: none"> Deviation is always cleared when servo is off.  <ul style="list-style-type: none"> Deviation is cleared in the edge when deviation clear input becomes OFF/ON. 	
2H Servo OFF/deviation not cleared: Deviation clear input/level detection	<ul style="list-style-type: none"> Deviation is not cleared when servo is OFF. The motor may start suddenly after servo is turned ON with location deviation detected.  <ul style="list-style-type: none"> Deviation is cleared in the edge when deviation clear input becomes OFF/ON. 	
3H Servo OFF/deviation not cleared: Deviation clear input / edge detection	<ul style="list-style-type: none"> Deviation is not cleared when servo is OFF. The motor may start suddenly after servo is turned ON with location deviation detected.  <ul style="list-style-type: none"> Deviation is cleared in the edge when deviation clear input becomes OFF/ON. 	

Select the conditions for enabling deviation clear.

Parameter Group9 page04	CLR : Deviation clear function
-------------------------	--------------------------------

7. Adjustment · Functions [Functions of Group 8][Internal velocity command]

[Group 8] 20~22														
Internal velocity command 1~3 [VC*]	Speed control mode													
<p>The servo motor can be controlled using internal velocity command. Internal velocity command settings have 3 ways. Internal velocity command and rotation direction can be selected via conditions of generic input CONT1~CONT8.</p>														
1. Set the internal speed command value.														
Parameter Group8Page20	VC1: internal speed command 1 0~32767min ⁻¹													
Parameter Group8Page21	VC2: internal speed command 2 0~32767min ⁻¹													
Parameter Group8Page22	VC3: internal speed command 3 0~32767min ⁻¹													
2. Select the conditions for enabling the internal speed command. The internal speed command requires the selection of valid conditions.														
Parameter Group9Page20	SP1: internal speed setting selection input 1													
Parameter Group9Page21	SP2: internal speed setting selection input 2													
<table border="1"> <tr> <td>SP1 : internal speed setting selection input1</td> <td>Valid</td> <td rowspan="4">→</td> <td>VC1: internal speed command 1</td> </tr> <tr> <td>SP2 : internal speed setting selection input2</td> <td>Invalid</td> <td>VC2: internal speed command 2</td> </tr> <tr> <td>SP1 : internal speed setting selection input1</td> <td>Invalid</td> <td>VC3: internal speed command 3</td> </tr> <tr> <td>SP2 : internal speed setting selection input2</td> <td>Valid</td> <td>Analog speed command</td> </tr> </table>	SP1 : internal speed setting selection input1	Valid	→	VC1: internal speed command 1	SP2 : internal speed setting selection input2	Invalid	VC2: internal speed command 2	SP1 : internal speed setting selection input1	Invalid	VC3: internal speed command 3	SP2 : internal speed setting selection input2	Valid	Analog speed command	
SP1 : internal speed setting selection input1	Valid	→		VC1: internal speed command 1										
SP2 : internal speed setting selection input2	Invalid			VC2: internal speed command 2										
SP1 : internal speed setting selection input1	Invalid			VC3: internal speed command 3										
SP2 : internal speed setting selection input2	Valid		Analog speed command											
<table border="1"> <tr> <td>SP1 : internal speed setting selection input1</td> <td>Valid</td> <td rowspan="4">→</td> <td>VC1: internal speed command 1</td> </tr> <tr> <td>SP2 : internal speed setting selection input2</td> <td>Invalid</td> <td>VC2: internal speed command 2</td> </tr> <tr> <td>SP1 : internal speed setting selection input1</td> <td>Valid</td> <td>VC3: internal speed command 3</td> </tr> <tr> <td>SP2 : internal speed setting selection input2</td> <td>Invalid</td> <td>Analog speed command</td> </tr> </table>	SP1 : internal speed setting selection input1	Valid	→	VC1: internal speed command 1	SP2 : internal speed setting selection input2	Invalid	VC2: internal speed command 2	SP1 : internal speed setting selection input1	Valid	VC3: internal speed command 3	SP2 : internal speed setting selection input2	Invalid	Analog speed command	
SP1 : internal speed setting selection input1	Valid	→		VC1: internal speed command 1										
SP2 : internal speed setting selection input2	Invalid			VC2: internal speed command 2										
SP1 : internal speed setting selection input1	Valid			VC3: internal speed command 3										
SP2 : internal speed setting selection input2	Invalid		Analog speed command											
<table border="1"> <tr> <td>SP1 : internal speed setting selection input1</td> <td>Valid</td> <td rowspan="4">→</td> <td>VC1: internal speed command 1</td> </tr> <tr> <td>SP2 : internal speed setting selection input2</td> <td>Invalid</td> <td>VC2: internal speed command 2</td> </tr> <tr> <td>SP1 : internal speed setting selection input1</td> <td>Valid</td> <td>VC3: internal speed command 3</td> </tr> <tr> <td>SP2 : internal speed setting selection input2</td> <td>Invalid</td> <td>Analog speed command</td> </tr> </table>	SP1 : internal speed setting selection input1	Valid	→	VC1: internal speed command 1	SP2 : internal speed setting selection input2	Invalid	VC2: internal speed command 2	SP1 : internal speed setting selection input1	Valid	VC3: internal speed command 3	SP2 : internal speed setting selection input2	Invalid	Analog speed command	
SP1 : internal speed setting selection input1	Valid	→		VC1: internal speed command 1										
SP2 : internal speed setting selection input2	Invalid			VC2: internal speed command 2										
SP1 : internal speed setting selection input1	Valid			VC3: internal speed command 3										
SP2 : internal speed setting selection input2	Invalid		Analog speed command											
<table border="1"> <tr> <td>SP1 : internal speed setting selection input1</td> <td>Invalid</td> <td rowspan="4">→</td> <td>VC1: internal speed command 1</td> </tr> <tr> <td>SP2 : internal speed setting selection input2</td> <td>Valid</td> <td>VC2: internal speed command 2</td> </tr> <tr> <td>SP1 : internal speed setting selection input1</td> <td>Valid</td> <td>VC3: internal speed command 3</td> </tr> <tr> <td>SP2 : internal speed setting selection input2</td> <td>Invalid</td> <td>Analog speed command</td> </tr> </table>	SP1 : internal speed setting selection input1	Invalid	→	VC1: internal speed command 1	SP2 : internal speed setting selection input2	Valid	VC2: internal speed command 2	SP1 : internal speed setting selection input1	Valid	VC3: internal speed command 3	SP2 : internal speed setting selection input2	Invalid	Analog speed command	
SP1 : internal speed setting selection input1	Invalid	→		VC1: internal speed command 1										
SP2 : internal speed setting selection input2	Valid			VC2: internal speed command 2										
SP1 : internal speed setting selection input1	Valid			VC3: internal speed command 3										
SP2 : internal speed setting selection input2	Invalid		Analog speed command											
<table border="1"> <tr> <td>SP1 : internal speed setting selection input1</td> <td>Invalid</td> <td rowspan="4">→</td> <td>VC1: internal speed command 1</td> </tr> <tr> <td>SP2 : internal speed setting selection input2</td> <td>Invalid</td> <td>VC2: internal speed command 2</td> </tr> <tr> <td>SP1 : internal speed setting selection input1</td> <td>Valid</td> <td>VC3: internal speed command 3</td> </tr> <tr> <td>SP2 : internal speed setting selection input2</td> <td>Invalid</td> <td>Analog speed command</td> </tr> </table>	SP1 : internal speed setting selection input1	Invalid	→	VC1: internal speed command 1	SP2 : internal speed setting selection input2	Invalid	VC2: internal speed command 2	SP1 : internal speed setting selection input1	Valid	VC3: internal speed command 3	SP2 : internal speed setting selection input2	Invalid	Analog speed command	
SP1 : internal speed setting selection input1	Invalid	→		VC1: internal speed command 1										
SP2 : internal speed setting selection input2	Invalid			VC2: internal speed command 2										
SP1 : internal speed setting selection input1	Valid			VC3: internal speed command 3										
SP2 : internal speed setting selection input2	Invalid		Analog speed command											

3. Begin operation with the internal speed command and select the conditions for rotation direction.

Parameter Group9Page22	DIR: internal speed operation direction selection input.
Parameter Group9Page23	RUN: internal speed operation start signal input
Parameter Group9Page24	RUN-F: internal speed forward start signal input
Parameter Group9Page25	RUN-R: internal speed reverse start signal input

4 If the above conditions are valid, run the servo motor with the selection combinations listed below.

RUN: internal speed operation start signal input	Valid	Servo motor moves forward
DIR: internal speed operation direction selection input.	Invalid	
RUN: internal speed operation start signal input	Valid	Servo motor in reverse
DIR: internal speed operation direction selection input.	Valid	
RUN-F: Valid internal speed forward start signal input	Valid	Servo motor moves forward
RUN-R: Valid internal speed reverse start signal input	Valid	Servo motor in reverse

7. Adjustment · Functions [Functions of Group 8][Internal velocity command]

Examples of setting and operation pattern at internal velocity command operation.

VC1: internal speed command 1	1000min ⁻¹
VC2: internal speed command 2	2000min ⁻¹
VC3: internal speed command 3	3500min ⁻¹

SP1: internal speed setting selection input 1	Valid general input CONT3 ON function
SP2: internal speed setting selection input 2	Valid general input CONT4 ON function

RUN-F: internal speed forward start signal input	Valid general input CONT5 ON function
RUN-R: internal speed reverse start signal input	Valid general input CONT5 OFF function

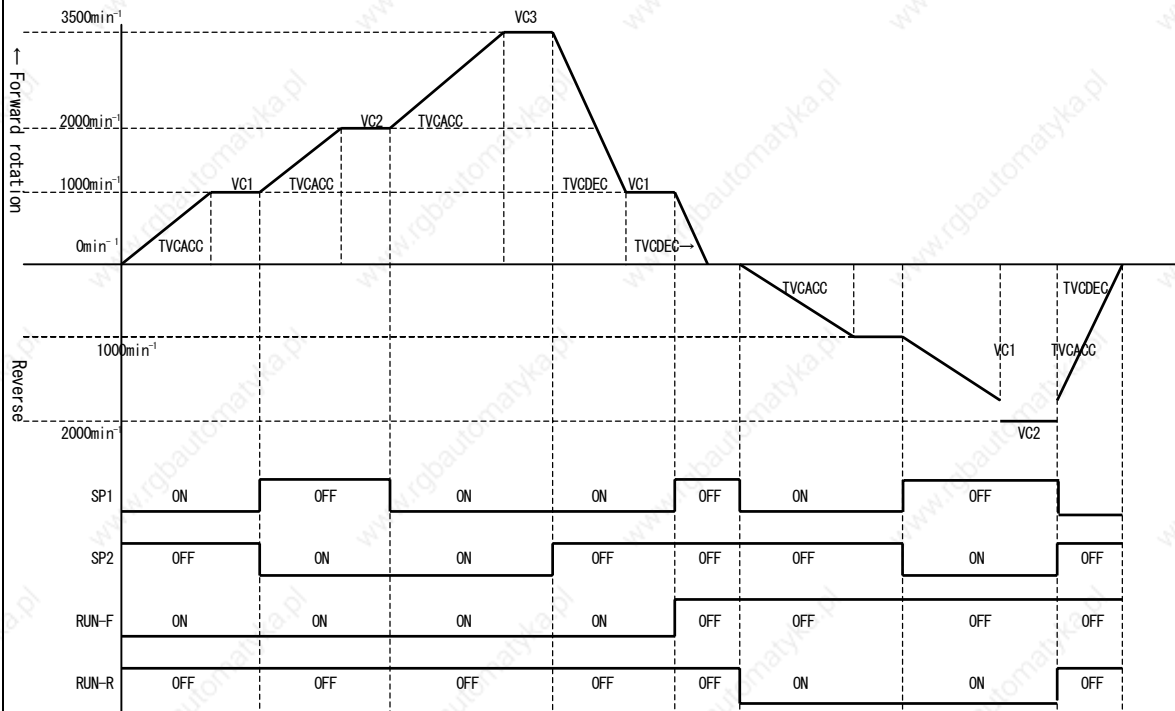

7. Adjustment · Functions [Functions of Group 8][Velocity addition command]

[Group 8] 23~25

Velocity addition command input selection [VCOMSEL] /internal velocity addition command [VCOMP] Position control mode

Analog velocity (addition) command scaling [VCGN]

The speed addition function is the fast-forward function in the speed control system. The speed addition command input function has 2 settings: the internal speed addition command and the analog speed addition command. The internal speed addition command is used when the speed addition command value is a fixed value. The analog speed addition command is used when setting the speed addition command input value from the host unit.

1. Sets the internal speed addition command value.

Parameter Group8 Page24	VCOMP : Internal speed addition command	-9999~+9999 min ⁻¹
-------------------------	---	-------------------------------

2. Select the speed addition command input method.

Parameter Group8 Page23	VCOMSEL : velocity addition command input selection
-------------------------	---

Selection		Description
01:_Analog_Input	Use analog speed addition command	Use analog speed addition command value when speed addition function is valid.
02:_VCOMP	Use internal speed addition command	Use internal speed addition command value when speed addition function is valid.

3. Select the condition for enabling the speed addition function and then input the setting.

Parameter Group9 Page27	VCOMPS : Speed addition function
-------------------------	----------------------------------

1. Set the analog velocity addition command scaling. (This is shared with analog velocity command scaling.)

Parameter group 8 page 25	VCGN : analog velocity command scaling	0~4000 min ⁻¹ /V
---------------------------	--	-----------------------------

The input used in the analog speed addition command is the same as the analog speed command / analog torque command input.

Analog speed addition command input : CN1-21 【Input voltage range -10V~+10V】
 Analog speed addition command input SG : CN1-20

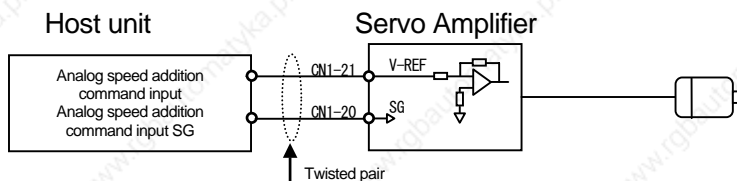

2. Select the speed command input method.

Parameter Group8 Page23	VCOMSEL : Velocity addition command input selection
-------------------------	---

Selection		Description
01:_Analog_Input	Use analog speed addition command	Use analog speed addition command value when speed addition function is valid.
02:_VCOMP	Use internal speed addition command	Use internal speed addition command value when speed addition function is valid.

3. Select the conditions for enabling the speed addition function.

Parameter Group9 Page27	VCOMPS : Speed addition function
-------------------------	----------------------------------

7. Adjustment · Functions [Functions of Group 8][Velocity addition command]

[Group 8] 26~27

Speed command adjustment constant. [TVCACC] Speed command adjustment constant. TVCDEC]
Speed control mode

The step input speed command can be changed to a constant adjustment speed command using the speed command adjustment constant.

Acceleration/deceleration time per $\pm 1000 \text{min}^{-1}$ is set.

Parameter Group8Page26	TVCACC : Speed command adjustment constant.	0~16000 ms
Parameter Group8Page27	TVCDEC : Speed command adjustment constant.	0~16000 ms

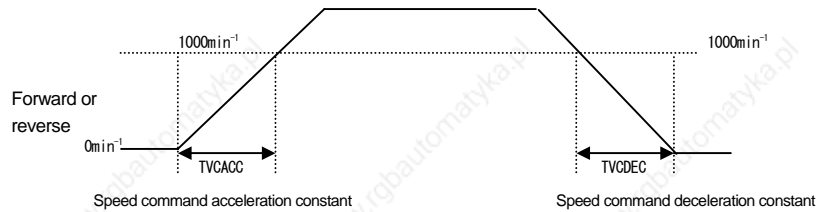

The analog speed command and internal speed command can be used together.

[Group 8] 28

Speed limit command [VCLM] Speed control mode Position control mode

An host limit value can be locked in with the speed limit command.

This value cannot be set to exceed the speed capabilities of the adjoining motor.

Parameter Group8Page28	VCLM : Speed limit command	1~65535 min^{-1}
------------------------	----------------------------	---------------------------

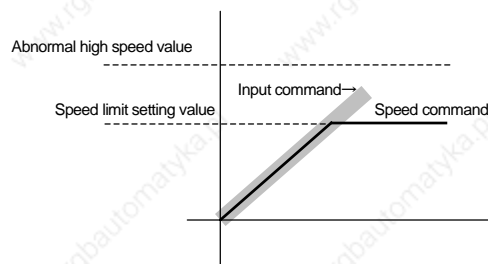

7. Adjustment · Functions [Functions of Group 8] [Torque addition command]

[Group 8] 30~34

Speed control mode Position control mode

Torque addition command input selection [TCOMSEL] Analog torque addition command scaling [TCOMPGN]

Internal torque addition command 1 [TCOMP1] Internal torque addition command 2 [TCOMP2]

Torque addition function 1 [TCOMPS1] Torque addition function 2 [TCOMPS2]

The torque addition function is the fast-forward function of the torque control system. There are 2 types of settings for the torque addition command input function: the internal torque addition command and the analog torque addition command. The internal torque addition command can be used when using the torque addition command value as a fixed value. The analog torque addition command can be used when setting the torque addition command input value from the host unit.

1. Sets the internal torque addition command value.

Parameter Group8Page31	TCOMP : Internal torque addition command 1	-500~+500 %
Parameter Group8Page32	TCOMP : Internal torque addition command 2	-500~+500 %

2. Select the torque addition command input method.

Parameter Group8Page30	TCOMSEL : Torque addition command input selection
------------------------	---

Selection	Description
0H	Torque addition function disabled
1H	Use analog torque addition command Use analog torque addition command value when torque addition function is valid.
2H	Use internal torque addition command Use internal torque addition command value when torque addition function is valid.

3. Select the condition for enabling the torque addition function and then input the setting.

Parameter Group9Page30	TCOMPS1 : Torque addition function 1
Parameter Group9Page31	TCOMPS2 : Torque addition function 2

1. Sets the analog torque addition command scaling.

Parameter Group8Page34	TCOMPGN : Analog speed command scaling	0~500 %
------------------------	--	---------

2. The input used in the analog torque addition command provides the signal analog torque addition command input of CN1.

Analog torque addition command input : CN1-22 [Input voltage range -10V~+10V]
 Analog torque addition command input SG : CN1-23

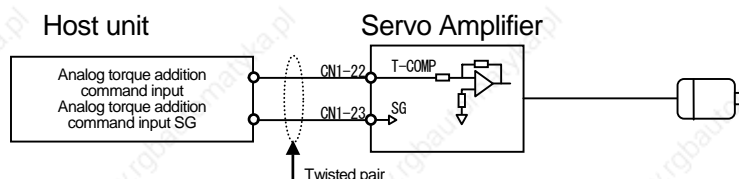

3. Select the torque addition command input method.

Parameter Group8Page30	TCOMSEL : Torque addition command input selection
------------------------	---

Selection	Description
0H	Torque addition function disabled
1H	Use analog torque addition command Use analog torque addition command value when torque addition function is valid.
2H	Use internal torque addition command Use internal torque addition command value when torque addition function is valid.

4. Select the conditions for enabling the torque addition function.

Parameter Group9Page30	TCOMPS1 : Torque addition function 1
Parameter Group9Page31	TCOMPS2 : Torque addition function 2

7. Adjustment · Functions [Functions of Group 8] [Torque Limit]

[Group 8] 35~36

Torque limit input selection [TLSEL] Internal torque limit value [TCLM] Velocity control Position control Torque control

There are two areas where selections for the torque limit function can be made: the internal torque limit and the external torque limit. The two selections have different settings, and affect the operation of the unit in different ways.

Internal torque limit

The internal torque limit (constant) can be used to limit the maximum torque and protect the unit mechanism. Set these parameters according to the following table.

Parameter Group8 Page35 TLSEL: torque limit input

Selection value		Description
00:_TCLM	Use the internal torque limit value (TCLM)	Forward (positive direction) : limited by internal constant. Reverse (reverse direction) : limited by internal constant.

2. Internal torque limit value setting

Parameter Group8 Page36 TCLM : Internal torque limit value 10~500%

3. Torque limit function enable

Parameter Group9 Page32 TL: Torque limit function

Conditions for enabling torque limit permission function are selected. When conditions are valid, torque limit is permitted and operation starts.

- * If the value is set higher than the maximum output torque (T_P) of the servo motor, it will be limited by (T_P).
- * Set this value after considering the acceleration time. Too low of a setting can result in insufficient acceleration torque and poor control.
- * The internal torque limit should be set higher than the acceleration torque.
- * The internal torque limit is identical for forward and reverse rotation. Separate torque limits cannot be set.

External torque limit

With the external torque limit function, separate torque limits can be set for forward and reverse rotation. There is a designated input for external torque limit on the CN1 input signal.

Forward torque limit input (F-TLA) : CN1-18 【Input voltage range 0V~+10V】

Reverse torque limit input (R-TLA) : CN1-19 【Input voltage range -10V~+10V】

SG : CN1-17

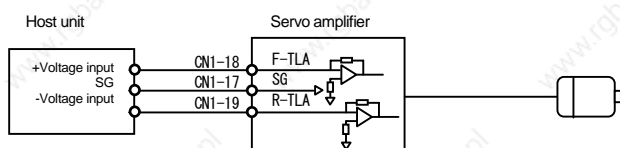

7. Adjustment · Functions [Functions of Group 8] [Torque Limit]

The input voltage specification and the input signal specification can be used in three ways.

Parameter Group8Page35 TLSEL: torque limit input

Selection value		Description
01:_Analog_1	Use the external torque limit input: Forward/F-TLA, Reverse/R-TLA (- voltage input)	<ul style="list-style-type: none"> Forward: The limit will be the positive voltage input to F-TLA. Reverse: The limit will be the negative voltage input to R-TLA.
02:_Analog_2	Use the external torque limit input: Forward/F-TLA, Reverse/R-TLA (+ voltage input)	<ul style="list-style-type: none"> Forward: The limit will be the positive voltage input to F-TLA. Reverse: The limit will be the positive voltage input to R-TLA.
03:_Analog_3	Use the external torque limit input: Forward/F-TLA, Reverse/F-TLA	<ul style="list-style-type: none"> Forward: The limit will be the positive voltage input to F-TLA. Reverse: The limit will be the positive voltage input to F-TLA.

01:_Analog_1

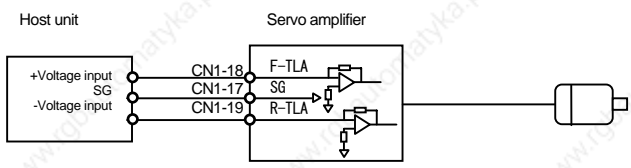

02:_Analog_2

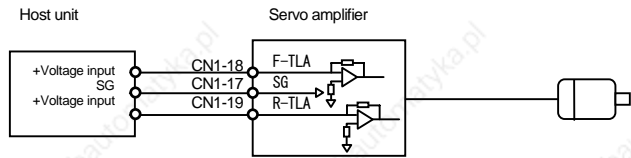

03:_Analog_3

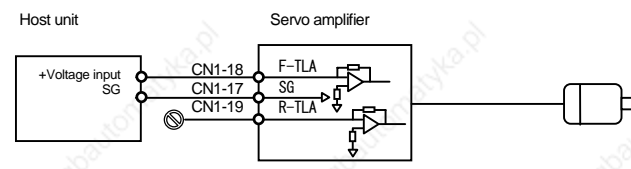

Connect the voltage corresponding to the torque limit to the external torque input pin. The relationship between the input voltage and the limitable torque is the rated torque (TR) = 2V for the type of servo motor used.

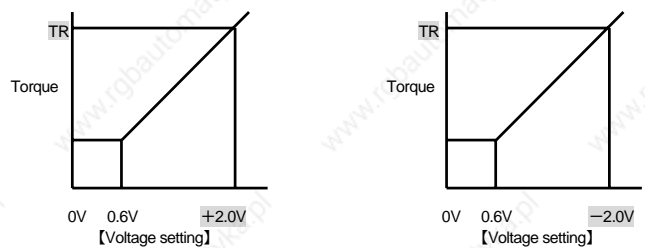

Torque limit function enable

Parameter Group9Page32 TL: limit function

Conditions for enabling torque limit permission function are selected. When conditions are valid, torque limit is permitted and operation starts.

7. Adjustment · Functions [Functions of Group 8][Sequence operation torque limit]

[Group 8] 37

Sequence operation torque limit value [SQTCLM] Velocity control Position control Torque control

During the sequence operation the output torque is limited. Limiting the output torque protects the unit mechanism.

The torque limits during sequence operation support the following sequence operations:

- JOG operation
- Over travel operation
- Securing brake standby time
- Servo brake operation

Sequence operation torque limit value setting

Parameter Group 8 Page37	SQTCLM : Sequence torque operation limit	10~500%
--------------------------	--	---------

If this value is set higher than the maximum output torque (TP) of the servo motor, it will be limited by (TP).

7. Adjustment · Functions [Functions of Group 8] [Near range]

[Group 8] 40

Near range [NEAR]

Position control mode

Outputs signal indicating proximity to position completion.

This is used together with positioning complete signal (INP) and near range of positioning complete is output.

Parameter Group8Page40	NEAR : near range	1~65535	Pulse
------------------------	-------------------	---------	-------

Parameter GroupAPage0 *	OUT* : general output *
-------------------------	-------------------------

Selection	Description	
1A	NEAR_ON	Output turns ON during near range status
1B	NEAR_OFF	Output turns OFF during near range status

Determine the logical status of the NEAR signal output, and to which output terminal to assign the positioning completion signal output. The assignment of the output terminal is the same location as the positioning completion signals (above).

If set to a value greater than the positioning completion range settings, the host unit receives the NEAR signal before receiving the positioning completion signal (INP), and transition to the positioning completion operations is enabled.

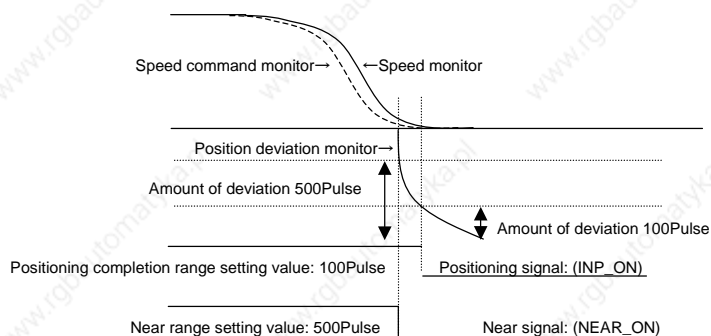

7. Adjustment · Functions [Functions of Group 8] [Positioning complete range]

[Group 8] 4 1

Positioning complete range [INP]

Position control mode

The positioning completion signal is output from the selected output terminal when servo motor movement is completed (reaches the set deviation counter value) during location control mode.

Setting the positioning completion range

Parameter Group8Page41 | INP : Positioning completion range | 1~65535 Pulse

Set the deviation counter value with positioning completion signals. The encoder pulse is standard, irrespective of the command pulse multiplication and electronic gear settings.

Incremental encoder: 4 times (4x) encoder pulses is standard.

Absolute encoder: absolute value is standard.

Setting the positioning completion signal

Parameter GroupA Page0 * | OUT* : general output *

Selection	Description
18 INP_ON	Output turns ON during positioning completion status.
19 INP_OFF	Output turns OFF during positioning completion status.

Determine the logical status of the positioning completion signal output, and to which output terminal to assign the positioning completion signal output.

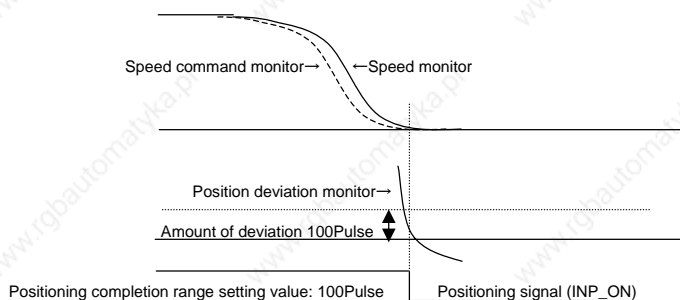

7. Adjustment · Functions [Functions of Group 8] [Velocity setting]

[Group 8] 43~45

Low speed setting [LOWV] speed coincidence range [VCMP] speed transport setting (High velocity setting) [VA] Position control mode Speed control mode Torque control mode

This parameter affects settings for the speed output range. The signal can be output from general output (OUT1~OUT8) and used as a valid condition for all functions. However, the speed coincidence range is invalid in torque control mode.

To direct signals to the host unit, make assignments to the signals in parameter Group 9. Use the general output terminal (OUT1 ~ OUT8) of the connected CN1.

Parameter GroupA Page0 * OUT* : General output *

Selection		Description
10	LOWV_ON	Output turns ON during low speed status
11	LOWV_OFF	Output turns OFF during low speed operation
12	VA_ON	Output turns ON during speed transport status
13	VA_OFF	Output turns OFF during speed transport status
14	VCMP_ON	Output turns ON during speed coincidence status
15	VCMP_OFF	Output turns OFF during speed coincidence status

Low speed range: Low speed signal is sent if speed goes below the set value.

Parameter Group8 Page43 LOWV : Low speed settings 0~65535min⁻¹

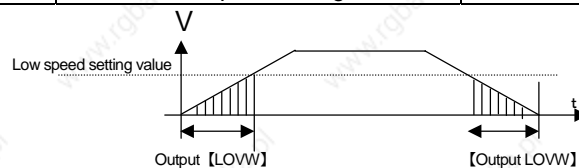

Speed coincidence range: Speed coincidence range signal is given if speed deviation reaches the set range.

Parameter Group8 Page44 VCMP : Speed coincidence range 0~65535min⁻¹

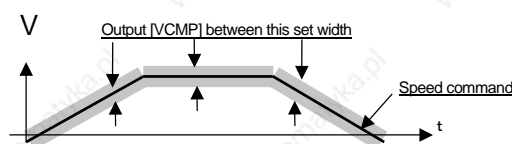

Speed transport settings: Speed transport signal is given if speed exceeds the set value.

Parameter Group1 Page08 VA : Speed transport settings 0~65535min⁻¹

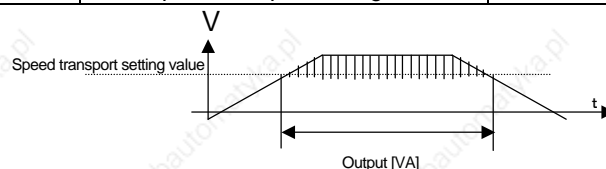

7. Adjustment · Functions [Functions of Group 8] [Velocity setting]

Various functions can be made valid without output signals taken into the host unit when this is used together with Group9 function enabling conditions (input signals).

Selection	Description	
12	LOWV_IN	Function is enabled during low speed status (speed below LOWV set value).
13	LOWV_OUT	Function is enabled when not in low speed status (speed below LOWV set value).
14	VA_IN	Function is enabled during speed transport status (speed above VA set value).
15	VA_OUT	Function is enabled when not in speed transport status (speed above VA set value).
16	VCMP_IN	Function is enabled during speed coincidence status (speed deviation below VCMP set value).
17	VCMP_OUT	Function is enabled when not in speed coincidence status (speed deviation below VCMP set value).

Low speed status [LOWV_IN]: Function is enabled during low speed status (speed below LOWV set value).

Low speed status [LOWV_OUT]: Function is enabled outside of low speed status (speed below LOWV set value).

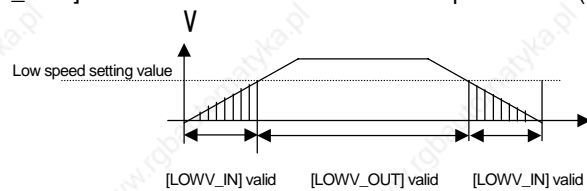

Speed coincidence status [VCMP_IN]: Function is enabled during speed coincidence status (speed deviation below VCMP set value).

Speed coincidence status [VCMP_OUT]: Function is enabled outside of speed coincidence status (speed deviation below VCMP set value).

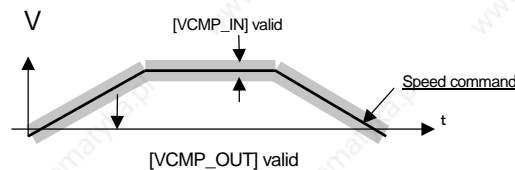

Speed transport status [VA_IN]: Function is enabled during speed transport status (speed above VA set value).

Speed transport status [VA_OUT]: Function is enabled outside of speed transport status (speed above VA set value).

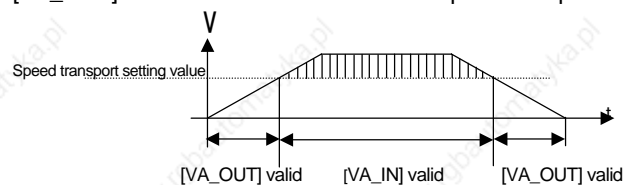

7. Adjustment · Functions [Functions of Group 9] [Over travel]

■ Functions of Group 9

[Group 9] 00~01

Forward over travel function [F-OT] Position control mode Speed control mode Torque control mode

Reverse over travel function [R-OT]

The over travel function uses a limit switch to prevent damage to the unit. It stops the unit when the movement range of the moving part is exceeded.

1. Allocate the over travel input signal to CONT1~CONT8.

Parameter Group9 Page00	F-OT : Forward over travel function
Parameter Group9 Page02	R-OT : Reverse over travel function

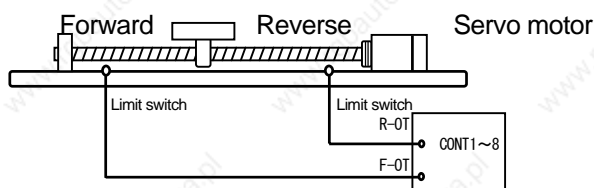

2. If the over travel function is used, select the operating conditions of “Position command input, Servo motor stop operation and Servo ON signal” in the case of over travel.

Parameter GroupB Page11	ACTOT : Over travel operation
-------------------------	-------------------------------

Selected value	内容
00: _CMDINH_SB_SON	<ul style="list-style-type: none"> • If OT occurs, command input is disabled, the servo brake operates and the motor stops. • After the motor stops, the servo turns ON. (At OT, command disabled = velocity limit command = 0)
01: _CMDINH_DB_SON	<ul style="list-style-type: none"> • If OT occurs, command input is disabled, the dynamic brake operates and the motor stops. • After the motor stops, the servo turns ON. (At OT, command disabled = velocity limit command = 0)
02: _CMDINH_Free_SON	<ul style="list-style-type: none"> • If OT occurs, command input is disabled, and the free-run operates. • After the motor stops, the servo turns ON. (At OT, command disabled = velocity limit command = 0)
03: _CMDINH_SB_SOFF	<ul style="list-style-type: none"> • If OT occurs, command input is disabled, the servo brake operates and the motor stops. • After the motor stops, the servo turns OFF.
04: _CMDINH_DB_SOFF	<ul style="list-style-type: none"> • If OT occurs, command input is disabled, the dynamic brake operates and the motor stops. • After the motor stops, the servo turns OFF.
05: _CMDINH_Free_SOFF	<ul style="list-style-type: none"> • If OT occurs, command input is disabled, and the free-run operates. • After the motor stops, the servo turns OFF.
06: _CMDACK_VCLM=0	<ul style="list-style-type: none"> • If OT occurs, OT occurrence velocity limit command becomes zero.

If “the motor is stopped by servo brake operation” [00:_CMDINH_SB_SON] [03:_CMDINH_SB_SOFF] is selected when over travel occurs, torque at the time of servo brake operation can be set at the sequence torque operation limit value.

Parameter Group8 Page37	SQTCLM: Sequence torque operation limit	10~500%
-------------------------	---	---------

If the value is set higher than the maximum output torque (TP) of the servo motor, it will be limited by (TP).

7. Adjustment · Functions [Functions of Group 9] [Alarm reset · Servo ON]

[Group 9] 02

Alarm reset function [AL-RST]

Position control mode Speed control mode Torque control mode

This function enables the sending of an alarm reset signal from the host unit. An alarm is cleared by enabling alarm reset function (AL-RST).

The conditions for enabling alarm reset function are assigned. The alarm is cleared if the AL-RST signal is valid.

Parameter Group9 Page02 AL-RST : Alarm reset function

The following circuit is created when valid conditions are assigned to CONT2. The logic can also be modified by the allocation of valid conditions.

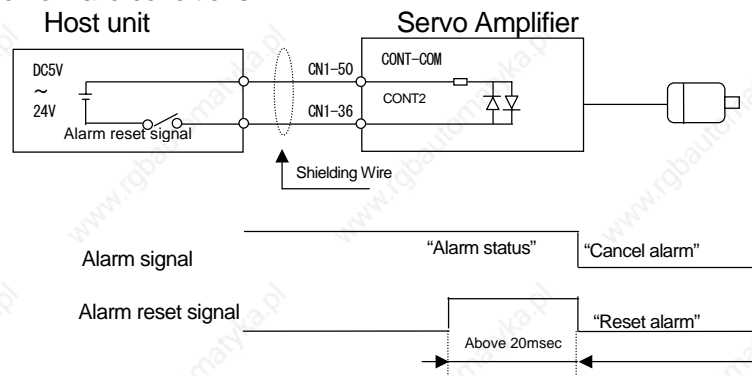

* Note that any alarm not cleared by simply turning OFF the control power supply cannot be cleared with the alarm reset signal.

[Group 9] 05

Servo ON function [S-ON]

Position control mode Speed control mode Torque control mode

This function enables the sending of a servo ON signal from the host unit. The servo motor can be set to "ready" status by enabling the servo ON function (SON).

The conditions for enabling the Servo ON function are assigned. The servo motor is set to "ready" status when the SON signal is enabled.

Parameter Group9 Page05 S-ON : Servo ON function

The following circuit is created when valid conditions are assigned to CONT1. The logic can also be modified by the allocation of valid conditions.

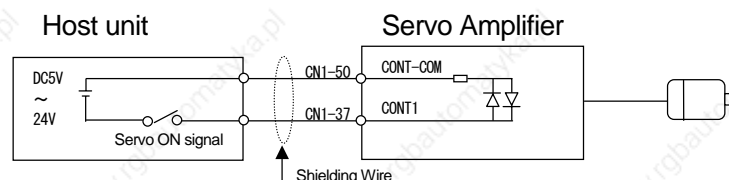

7. Adjustment - Functions [Functions of Group 9][Control mode switch over - Position command pulse inhibit/Zero velocity stop]

[Group 9] 10

Control mode switch over function [MS] Position control mode Speed control mode Torque control mode

2 types of control mode can be switched and used. The control mode to be combined is selected by system parameter and can be switched with control mode switch over function.

Control mode is selected from system parameter Page 08.

Page	Name	Setting range
08	Control mode	6 ways

Setting	Contents
03 : _Velo—Torq	Velocity control — torque control switching type
04 : _Posi—Torq	Position control — torque control switching type
05 : _Posi—Velo	Position control — velocity control switching type

After setting has been changed →The value becomes valid when control power is turned ON again.

Conditions enabling control mode switch over function are allocated. When MS signal is valid, control mode is switched.

Parameter Group9 Page10	MS : Control mode switch over function
-------------------------	--



When control mode switch over type is in use, there is a possibility that "auto-notch frequency tuning", "auto-vibration suppressing frequency tuning", and "JOG operation" cannot be used. Switch the control mode to the base side (disable MS) prior to using "auto-notch frequency tuning", "auto-vibration suppressing frequency tuning", and "JOG operation".

[Group 9] 11

Position command pulse inhibit function - zero velocity stop function [INH/Z-STP] Speed control mode Position control mode

This can be used as position command pulse inhibit function (INHIBIT function) in the position control type, and as zero velocity stop function in the velocity control type.

When the function is enabled while servo motor is operating, input command is inhibited and the servo motor stops at servo motor excitation status. In the position control type, even if position command pulse is input, the input pulse is not counted in the servo amplifier.

Conditions enabling position command pulse inhibit/zero velocity stop function are allocated. When signals of INH/Z-STP are valid, this will function.

Parameter Group9 Page11	INH/Z-STP : Position command pulse inhibit/zero velocity stop function
-------------------------	--

7. Adjustment - Functions [Functions of Group 9] [Gain switch over]

[Group 9] 13~14

Gain switch over condition 1 [GC1] Gain switch over condition 2 [GC2] Position control mode
Speed control mode Torque control mode

4 types of gains can be switched and used.

Conditions enabling gain switch over are allocated. When the signal of GC1 and GC2 combination is valid, the set value of corresponding GAIN becomes enabled.

Parameter Group9 Page13	GC1 : Gain switch over condition 1
Parameter Group9 Page14	GC2 : Gain switch over condition 2

GC1 : Gain switch over condition 1	Invalid	Valid	Invalid	Valid
GC2 : Gain switch over condition 2	Invalid	Invalid	Valid	Valid

↓

Gain to be enabled	GAIN 1	GAIN 2	GAIN 3	GAIN 4
--------------------	--------	--------	--------	--------

[Group 9] 15~16

Position control mode Speed control mode Torque control mode

Vibration suppressing frequency selection input 1 [SUPFSEL1] Vibration suppressing frequency selection input 2 [SUPFSEL2]

4 types of vibration suppressing frequency can be switched and used.

Conditions for enabling vibration suppressing frequency selection input are allocated. When the signal of SUPFSEL1 and SUPFSEL2 combination is valid, the set value of corresponding vibration frequency becomes enabled.

Parameter Group9 Page15	SUPFSEL1 : Vibration suppressing frequency selection input 1
Parameter Group9 Page16	SUPFSEL2 : Vibration suppressing frequency selection input 2

SUPFSEL1 : Vibration suppressing frequency selection input 1	Invalid	Valid	Invalid	Valid
SUPFSEL2 : Vibration suppressing frequency selection input 2	Invalid	Invalid	Valid	Valid

↓

↓

↓

↓

Vibration suppressing frequency to be enabled	Vibration suppressing frequency 1 Group 2 Page 0 0	Vibration suppressing frequency 2 Group 3 Page 4 0	Vibration suppressing frequency 3 Group 3 Page 4 1	Vibration suppressing frequency 4 Group 3 Page 4 2
---	---	---	---	---

7. Adjustment · Functions [Functions of group 9] [Position · velocity loop proportional control switch over]

[Group 9] 17

Position loop proportional control switch over function [PLPCON]

Position control mode

Switching between position loop PI control ↔ P control is possible. Switching is possible when position loop proportional control switchover function (PPCON) is enabled.

Conditions for enabling position loop proportional control switchover function are allocated. Switches to proportional control when the signal of PPCON is valid.

Parameter Group9 Page17

PLPCON : Position loop proportional control switchover function

PI control (proportional · integral control) · · · · Position loop proportional gain (KP) · Integral time constant (TPI)

P control (Proportional control) · · · · Position loop proportional gain (KP)

* Position loop integral time constant (TPI) is 1000.0ms at standard setting, therefore, integral function is invalid.

[Group 9] 26

Speed loop comparison control switchover function [VLPCON] Speed control mode Position control mode

Speed loop PI control / P control can be used alternatively. Activate switching by enabling the speed loop comparison control switching function (PCON)

The conditions for enabling the speed loop comparison control switching function are assigned. Change the comparison control when the PCON signal is valid.

Parameter Group9 Page26

VLPCON : Speed loop comparison control switchover function

PI control (comparison / integral control): Speed loop comparison gain (KVP) / Speed loop reset time constant (TVI)

P control (Comparison control): Speed loop comparison gain (KVP)

* When set to comparison control, servo gain is reduced and the servo system is made stable.

* When the speed loop reset time constant (TVI) is set to 1000.0ms, it is not necessary to use this function, since the reset time constant in use is invalid (Comparison control)

7. Adjustment • Functions [Functions of Group 9] [External trip • Forced discharge • Emergency stop]

[Group 9] 40
External trip input function [EXT-E] Position control mode Speed control mode Torque control mode
This function can output a contact input (such as external thermal) as an alarm (AL55H) in the servo amplifier.
The conditions for enabling the external trip function are assigned. An alarm (AL55H) is given if the EXT-E signal is valid.
Parameter Group9 Page40 EXT-E: External trip function

[Group 9] 41
Forced discharge function [DISCHARG] Position control mode Speed control mode Torque control mode
This function forcefully discharges voltage charged in the condenser for the main circuit power supply in the servo amplifier when power supply to the main circuit is cut. However, discharge is not possible when the main circuit power supply is ON.
The conditions for enabling forced discharge function are assigned. Forced discharge is possible when the DISCHARGE signal is valid.
Parameter Group9 Page41 DISCHARGE : Forced discharge function

[Group 9] 42
Emergency Stop Function [EMR] Position control mode Speed control mode Torque control mode
This function enables an emergency stop of the servo motor after receiving an emergency stop signal in the servo amplifier.
The conditions for enabling the unit emergency stop signal are assigned. The unit emergency stop function is executed when the EMR signal is valid.
Parameter Group9 Page42 EMR : Emergency stop function

7. Adjustment • Functions [Functions of Group B] [Dynamic brake • Forced stop]

■ Functions of Group B

[GroupB] 10	
Dynamic brake operation [DBOPE]	Position control mode Speed control mode Torque control mode
Conditions for stop at servo OFF can be selected from Servo brake/dynamic brake/free run. Conditions after servo motor stop can be selected from dynamic brake/free run.	
Parameter GroupB Page10	DBOPE:Dynamic brake operation
Selected value	
00: Free_Free	Free run operation at servo OFF : Motor free operation after motor stop.
01: Free_DB	Free run operation at servo OFF : Dynamic brake operation after motor stop.
02: DB_Free	Dynamic brake operation at servo OFF : Motor free operation after motor stop.
03: DB_DB	Dynamic brake operation at servo OFF : Dynamic brake operation after motor stop.
04: SB_Free	Servo brake operation at servo OFF : Motor free operation after motor stop
05: SB_DB	Servo brake operation at servo OFF : Dynamic brake operation after motor stop

[GroupB] 12	
Forced stop operation [ACTEMR]	Position control mode Speed control mode Torque control mode
When forced stop is executed by power shut off while servo motor is operating (servo motor is not stopped), conditions for servo motor stop can be selected from servo brake/dynamic brake.	
Parameter GroupB Page12	ACTEMR : Forced stop operation
Selected value	Contents
00: SERVO-BRAKE	When EMR is input, motor is stopped by servo brake operation.
01: DINAMIC-BRAKE	When EMR is input, motor is stopped by dynamic brake operation.

7. Adjustment - Functions [Functions of Group B] [Securing brake operation delay time]

[Group B] 13

Position control mode Speed control mode Torque control mode

Securing brake operation delay function [BONDLY]

This function is enabled during servo brake operation at servo OFF. It is disabled for dynamic brake and free-run.

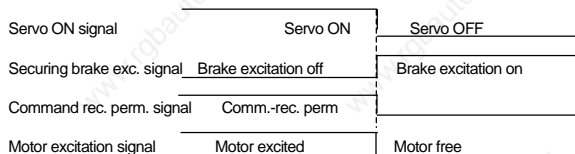

If the motor excitation is turned off here, any delay until the securing brake engages can cause a weight-drop.

Set the delay time for the securing brake operation

Parameter GroupB Page13	BONDLY : Securing brake operation delay time	0~1000ms
-------------------------	--	----------

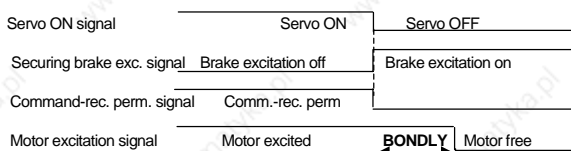

A delay in switching off the motor excitation can prevent weight-drop, as the motor is excited until the securing brake turns ON.

- The setting increment is 4 msec. If the setting is 0 msec, the command is disabled (forced zero) for 4 msec after SON.
- The securing brake excitation signal can be output through the generic outputs (OUT1~OUT8).

Parameter GroupA Page0 *	OUT* : Generic output *
--------------------------	-------------------------

OA : _MBR-ON_ON	During securing brake excitation signal output, the output turns ON.
OB : _MBR-ON_OFF	During securing brake excitation signal output, the output turns OFF.

7. Adjustment · Functions

[Functions of Group B]

[Securing brake release delay time]

[Group B] 14

Position control mode Speed control mode Torque control mode

Securing brake release delay function [BOFFDLY]

- Set the delay time for the securing brake release

Parameter GroupB Page14	BOFFDLY : Securing brake release delay time	0~1000ms
-------------------------	--	----------

- The setting increment is 4 msec. If the setting is 0 msec, the command is disabled (forced zero) for 4 msec after SON.
- The securing brake excitation signal can be output through the generic outputs (OUT1 ~ OUT8).

Parameter Group9 Page0 *	OUT* : Generic output*	
--------------------------	-------------------------------	--

OA: _MBR-ON_ON	During securing brake excitation signal output, the output turns ON.
OB: _MBR-ON_OFF	During securing brake excitation signal output, the output turns OFF.

[Group B] 15

Position control mode Speed control mode Torque control mode

Brake operation start time [BONBGN]

If the motor does not stop within the time frame set for the brake operation start (BONBGN) when the servo is turned OFF, the securing brake and the dynamic brake force the motor to stop. The function can be disabled by setting the value to "0" ms. The setting increment is 4 msec; therefore, set the value to 4 msec or higher.

Parameter GroupB Page15	BONBGN : Brake operation start time	0~65535ms
-------------------------	--	-----------

- * The term "motor does not stop" (above) means that the motor velocity does not fall below the zero velocity (ZV) range.
- * The stop sequence is different depending on the condition settings of the emergency stop operation.
- * When the brake operation start time (BONBGN) passes, the servo motor will be forced to stop by both the dynamic brake and the securing brake, which can cause damage to the securing brake. Therefore, use this function only after considering the specifications and the sequence of the unit.

7. Adjustment · Functions

[Functions of Group B] [Power

failure detection delay time]

[Group B] 16

Power failure detection delay time [PFDDLY] Position control mode Speed control mode Torque control mode

This function can set a delay period, after power off of the control power supply, for detecting problems in the control power supply. Detection of unexpected power failure is diminished when this value is increased. However, even if this value is increased and problem detection is delayed, when the power supply to the internal logic circuit is exhausted, routine operations at the time of control power supply cut off / restart will continue.

Parameter GroupB Page16

PFDDLY : Power failure
detection delay time

20~1000 ms

*When energy to the main circuit power supply is insufficient, problems like a reduction in main circuit power supply are also detected.

*The actual anomaly detection delay time compared to the selected value can vary between -12ms and +6ms.

7. Adjustment - Functions [Excessive deviation warning - Deviation counter overflow - Overload warning]

[Group B] 20	Excessive deviation warning function [OFWL]		
Position control mode Speed control mode Torque control mode			
This function gives a warning before reaching excessive deviation alarm status.			
Set the deviation excessive warning value.			
Parameter GroupB Page20	OFWL : Excessive deviation warning level	1~65535	× 1024 pulse
For sending the signals to the host unit, assign the signals in parameter Group 9. Output from general output number (OUT1 ~ OUT8) of the connected CNs1.			
Parameter GroupA Page0 *	OUT* : Generic output *		
2A: _WNG-OFW_ON	Output turns ON during excessive deviation warning status		
2B: _WNG-OFW_OFF	Output turns OFF during excessive deviation warning status		

[Group B] 21	Deviation counter overflow [OFLV]		
Position control mode Speed control mode Torque control mode			
Parameter to set the value for outputting excessive position deviation alarm. Encoder pulse is the standard irrespective of electronic gear or command multiplication functions.			
Deviation counter overflow value is set.			
Parameter GroupB Page21	OFLV : Deviation counter overflow	1~65535	× 1024 pulse

[Group B] 22	Overload warning function [OLWL]		
Position control mode Speed control mode Torque control mode			
This function will send a warning before reaching overload alarm status. Set the ratio corresponding to the overload alarm value to 100%. When set to 100%, the overload warning and overload alarm are given simultaneously.			
Set the overload warning level.			
Parameter GroupB Page22	OLWL : Overload warning level	20~100	%
For sending the signals to the host unit, assign the signals in parameter Group 9. Output from general output terminal (OUT1 ~ OUT8) of the connected CN1.			
Parameter GroupA Page0 *	OUT* : General output *		
2C: _WNG-OLW_ON	Output turns ON during overload warning status		
2D: _WNG-OLW_OFF	Output turns OFF during overload warning status		
* The overload detection process is assumed to be 75% of the rated load at the time of starting the control power supply (hot start). At this time, if the overload warning level is set below 75%, an overload warning is given after starting the control power supply.			

7. Adjustment · Functions [Functions of Group C] [Digital

filter · External encoder polarity]

■ Functions of Group C

[Group C] 01~02

Position control mode Speed control mode Torque control mode

Motor incremental encoder digital filter [ENFIL]

External encoder (sensor) digital filter [EX-ENFIL]

You can set the digital filter value of the incremental pulse for the selected incremental encoder. When noise is superimposed on the incremental encoder, the pulse below the set value is removed as noise. Set this value by considering the frequency of pulses from the selected encoder and the maximum number of rotations of the servo motor. If the input value is greater than the encoder frequency during the peak rotation of the servo motor, the encoder pulse is removed and the servo motor will stop.

The motor encoder and external encoder can be set separately.

Selection for motor incremental encoder digital filter

Parameter GroupC Page01	ENFIL : Motor incremental encoder digital filter
Parameter GroupC Page02	EX-ENFIL : External encoder (sensor) digital filter

Selected value	Contents
00:_110nsec	Minimum pulse width =110nsec(Minimum phase difference=37.5nsec)
01:_220nsec	Minimum pulse width =220nsec
02:_440nsec	Minimum pulse width =440nsec
03:_880nsec	Minimum pulse width =880nsec
04:_75nsec	Minimum pulse width =75nsec(Minimum phase difference=37.5nsec)
05:_150nsec	Minimum pulse width =150nsec
06:_300nsec	Minimum pulse width =300nsec
07:_600nsec	Minimum pulse width =600nsec

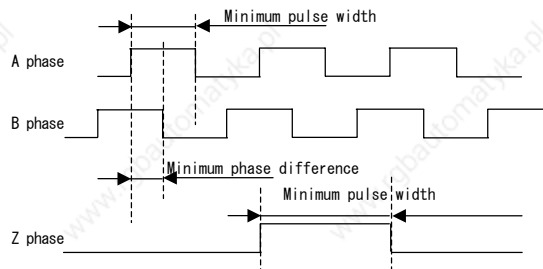

[Group C] 03

External encoder pulse polarity reverse [EX-ENPOL] Position control mode Speed control mode

Torque control mode

You can select external encoder pulse polarity.

Parameter GroupC Page03	EX-ENPOL : External encoder polarity
-------------------------	--------------------------------------

Selected value	Contents		
00:_Type1	EX-Z/Not reversed	EX-B/Not reversed	EX-A/Not reversed
01:_Type2	EX-Z/Not reversed	EX-B/Not reversed	EX-A/Reversed
02:_Type3	EX-Z/Not reversed	EX-B/Reversed	EX-A/Not reversed
03:_Type4	EX-Z/Not reversed	EX-B/Reversed	EX-A/Reversed
04:_Type5	EX-Z/Reversed	EX-B/Not reversed	EX-A/Not reversed
05:_Type6	EX-Z/Reversed	EX-B/Not reversed	EX-A/Reversed
06:_Type7	EX-Z/Reversed	EX-B/Reversed	EX-A/Not reversed
07:_Type8	EX-Z/Reversed	EX-B/Reversed	EX-A/Reversed

This setting is disabled in case of full closed control and when motor encoder is absolute encoder.

(To be set at Type 1.)

7. Adjustment - Functions [Functions of Group C] [Encoder pulse division]

[Group C] 04	Encoder pulse divider output selection [PULOUTSEL]	Position control mode	Speed control mode	Torque control mode
Encoder pulse divider output can be selected from 2 types; motor encoder or external encoder.				
Parameter GroupCPage04	PULOUTSEL : Encoder pulse divider output			
<ul style="list-style-type: none"> • For semi-closed control, select 0:Motor encoder. • In case of absolute sensor except for incremental absolute encoder, incremental pulse of 8192P/R is input in the divider circuit. • When full-closed controlled and motor encoder is absolute encoder, external encoder pulse is output by selecting any. 				

[Group C] 05	Division ratio for encoder pulse divider output [ENRAT]	Position control mode
		Speed control mode
		Torque control mode
<p>The encoder signals (Phase A/ Phase B) used in the host unit can be output according to a ratio formula. When using in the host unit's position loop control, input the result (obtained after dividing the number of encoder pulses) as an integer. However, when using this function to monitor the host unit, input a ratio that is as close to the setup value as possible.</p> <p>The output of Z phase is not divided. Output can be sin O/C (CN1-11).</p> <p>Division ratio for the encoder pulse divider output is set.</p>		
Parameter GroupC Page05	ENRAT : Ratio of the encoder pulse divider output	1/1~1/8192

The following settings are possible.

- When numerator is "1" : $\frac{1}{1} \sim \frac{1}{64}, \frac{1}{8192}$ can be set.
- When numerator is "2" : $\frac{2}{3} \sim \frac{2}{64}, \frac{2}{8192}$ can be set.
- When denominator is "8192" : $\frac{1}{8192} \sim \frac{8191}{8192}$ can be set.

Frequency division 1/1 (Forward rotation)

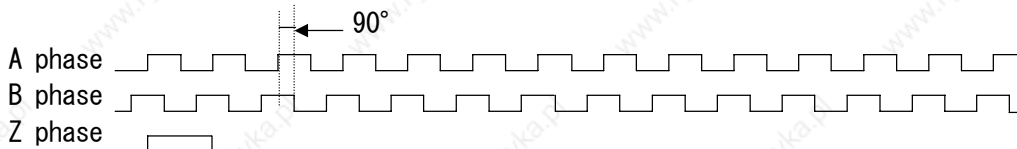

Frequency division 1/2 (Forward rotation)

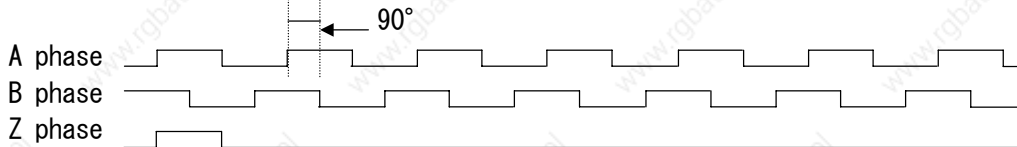

Frequency division 2/5 (Forward rotation)

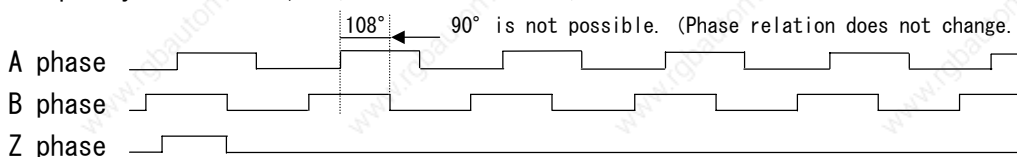

* Destabilizes for 1 sec after control power is supplied.

7. Adjustment - Functions [Functions of Group C] [Encoder division -

Encoder clear]

[Group C] 06

Encoder Pulse Divider Output polarity selection function [PULOUTPOL] Position control mode Speed control mode Torque control mode

The polarity of the encoder pulse frequency output can be selected.

Parameter GroupC Page06 PULOUTPOL : Encoder pulse frequency output polarity

Selected value	Contents
00:_Type1	A phase signal / not reversed Z phase signal logic / High active
01:_Type2	A phase signal / reversed Z phase signal logic / High active
02:_Type3	A phase signal / not reversed Z phase signal logic / Low active
03:_Type4	A phase signal / reversed Z phase signal logic / Low active

Setting 0H (Frequency division ratio 1/1: with forward rotation)
Using the incremental encoder

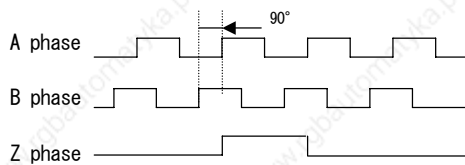

Setting 3H (Frequency division ratio 1/1: with forward rotation)
Using the incremental encoder

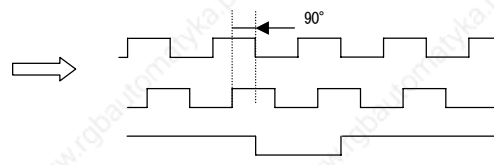

[Group C] 08

Absolute encoder clear function [ECLRFUNC] Position control mode Speed control mode Torque control mode

Select the conditions for enabling absolute encoder clear.

Parameter Group9 Page03 ECLR : Absolute encoder clear function

When using a wire-saving absolute sensor, you can select the contents to be cleared. Wire-saving absolute sensor

Clear "Warning + multiple rotation data"

Clear only "Warning"

Parameter GroupC Page08 ECLRFUNC : Select absolute encoder clear function

Selected value	Contents
00:_Status_MultiTurn	Clear encoder status (abnormal / warning) and multiple rotation data [standard setting]
01:_Status	Clear only encoder status (abnormal / warning)

- * These conditions are applicable only to the wire-saving absolute encoder.
- * Do not input this while the servo motor is rotating. Confirm that the servo motor stops before inputting this.

7. Adjustment · Functions

[Monitor] [Analog monitor]

■ Description of monitor

All signals and internal status of the servo amplifier can be monitored. There are 3 kinds of monitors.

1. Analog monitor { Monitor box and dedicated monitor cable are needed. Refer to "Materials; Option, Monitor box".
2. Digital monitor { Refer to "Chapter 1, Prior to Use, Servo Amplifier Part Names 1-5" for locations for connectors to be connected.
3. Monitor in display (Setup software—R—SETUP, Digital Operator)

● Analog monitor (2 channels)

[GroupA] 11~13

Analog monitor output 1 selection [MON1] Position control mode Speed control mode Torque control mode

Analog monitor output 2 selection [MON2]

Analog monitor output polarity [MONPOL]

Analog monitor for use is selected.

Parameter GroupA Page11	MON1 : Analog monitor output 1 selection
Parameter GroupA Page12	MON2 : Analog monitor output 2 selection

Selected value	Contents
00	Reserved
01:_TMON_2V/TR	Torque (thrust) monitor 2V/ rated torque (thrust)
02:_TCMON_2V/TR	Torque (thrust) command monitor 2V/ rated torque (thrust)
03:_VMON_0.2mV/ min ⁻¹	velocity monitor 0.2mV/ min ⁻¹
04:_VMON_1mV/ min ⁻¹	velocity monitor 1mV/ min ⁻¹
05:_VMON_2mV/ min ⁻¹	velocity monitor 2mV/ min ⁻¹
06:_VMON_3mV/ min ⁻¹	velocity monitor 3mV/ min ⁻¹
07:_VCMON_0.2mV/ min ⁻¹	velocity command monitor 0.2mV/ min ⁻¹
08:_VCMON_1mV/ min ⁻¹	velocity command monitor 1mV/ min ⁻¹
09:_VCMON_2mV/ min ⁻¹	velocity command monitor 2mV/ min ⁻¹
0A:_VCMON_3mV/ min ⁻¹	velocity command monitor 3mV/ min ⁻¹
0B:_PMON_0.1mV/P	position deviation counter monitor 0.1mV/ Pulse
0C:_PMON_1mV/P	position deviation counter monitor 1mV/ Pulse
0D:_PMON_10mV/P	position deviation counter monitor 10mV/ Pulse
0E:_PMON_20mV/P	position deviation counter monitor 20mV/ Pulse
0F:_PMON_50mV/P	position deviation counter monitor 50mV/Pulse
10:_FMON_2mV/kP/s	position command pulse monitor(position command pulse input frequency)2mV/kPulse/s
11:_FMON_10mV/kP/s	position command pulse monitor(position command pulse input frequency)10mV/kPulse/s
12:_TLMON_EST_2V/TR	Load torque (thrust)monitor(estimated value) 2V/ rated torque (thrust)
13:_Sine-U	U phase electric angle Sin 8 V peak
14:_VBUS_1V/DC100V	Main circuit DC voltage 1V/DC100V
15:_VBUS_1V/DC10V	Main circuit DC voltage 1V/DC10V

Select this when polarity is to be changed.

Parameter GroupA Page12	MONPOL: Analog monitor output polarity
-------------------------	--

Selected value	Contents
00:_MON1+_MON2+	MON1 : Positive voltage output in forward rotation; output pos and neg voltage. MON2 : Positive voltage output in forward rotation; output pos and neg voltage.
01:_MON1-_MON2+	MON1 : Negative voltage output in forward rotation; output pos and neg voltage. MON2 : Positive voltage output in forward rotation; output pos and neg voltage.
02:_MON1+_MON2-	MON1 : Positive voltage output in forward rotation; output pos and neg voltage. MON2 : Negative voltage output in forward rotation; output pos and neg voltage.
03:_MON1-_MON2-	MON1 : Negative voltage output in forward rotation; output pos and neg voltage. MON2 : Negative voltage output in forward rotation; output pos and neg voltage.
04:_MON1ABS_MON2+	MON1 : Positive voltage output together in forward and reverse rotation MON2 : Positive voltage output in forward rotation; output pos and neg voltage.
05:_MON1ABS_MON2-	MON1 : Positive voltage output together in forward and reverse rotation MON2 : Negative voltage output in forward rotation; output pos and neg voltage.
06:_MON1+_MON2ABS	MON1 : Positive voltage output in forward rotation; output pos and neg voltage. MON2 : Positive voltage output together in forward and reverse rotation
07:_MON1-_MON2ABS	MON1 : Negative voltage output in forward rotation; output pos and neg voltage. MON2 : Positive voltage output together in forward and reverse rotation
08:_MON1ABS_MON2ABS	MON1 : Positive voltage output together in forward and reverse rotation MON2 : Positive voltage output together in forward and reverse rotation

7. Adjustment - Functions [Monitor] [Digital monitor]

[Displayed monitor list]

● Digital monitor (1 channel)

[GroupA] 1 2

Digital monitor output selection [DMON] Position control mode Speed control mode Torque control mode

Digital monitor for use is selected.

Parameter GroupA Page12 DMON : Digital monitor output selection

For selected values, refer to “Chapter 5, Parameter [Parameter setting value [GroupA]] generic output OUT1~ generic output OUT8, and setting selection list of digital monitor output.

● List of monitors in display

[monitor] 0 0 ~ 1 E

Page	Name	Contents	Unit
00	Servo amplifier status	Displays the statuses of main circuit power being supplied, operation ready and servo ON.	—
01	Warning status 1	Displays warning status.	—
02	Warning status 2	Displays warning status.	—
03	Generic input CONT8~1 monitor	Displays generic input terminal status.	—
04	Generic output OUT8~1 monitor	Displays generic output terminal status.	—
05	Velocity monitor	Displays motor rotation velocity.	min ⁻¹
06	velocity command monitor	Displays velocity command value.	min ⁻¹
07	Torque monitor	Displays motor output torque.	%
08	Torque command monitor	Displays torque command value.	%
09	Position deviation monitor	Displays position deviation values.	Pulse
0A	Current position monitor	Displays current position compared with original position when the control power is turned ON. This is a free run counter. Therefore, when current position exceeds the displayed range, the display is maximum value of reversed polarity.	Pulse
0B	Current position monitor		
0C	Command position monitor		
0D	Analog velocity command / Analog torque command input voltage	Displays command voltage being input.	mV
0E	Position command pulse monitor (position command pulse input frequency)	Displays command pulse frequency being input.	k Pulse/s
0F	U phase electric angle monitor	Displays electric angle of U phase. Except for encoder (sensor) error, this is always displayed.	deg
10	Absolute encoder PS data (upper)	Displays absolute encoder position data PS.	x2 ³² P
11	Absolute encoder PS data(lower)	Displays absolute encoder position data PS.	Pulse
12	Regeneration resistor operation ratio	Displays regeneration resistance operation status.	%
13	Motor usage ratio monitor	Displays exact values, however, it may take several hours for the value to become stable depending on the operation pattern.	%
14	Motor usage ratio monitor (estimated value)	Displays estimated value of servo motor usage ratio, which is estimated from a short period of operation. In an application where the same operation pattern repeats in a short period of time, the usage ratio can be confirmed fast.	%
15	Load inertia moment ratio monitor	Values can be confirmed when gain switch over and auto-tuning functions are used.	%
16	Position loop proportional gain monitor		s ⁻¹
17	Position loop integral time constant monitor	Values can be confirmed when gain switch over function is used.	ms
18	Velocity loop proportional gain monitor	Values can be confirmed when gain switch over and auto-tuning function are used.	Hz
19	Velocity loop integral time constant monitor		ms
1A	Torque command filter monitor		Hz
1B	Incremental encoder signal monitor	Incremental signal of CN2 is displayed.	—
1C	Load torque monitor(estimated value)	Load torque is displayed.	%
1D	Main circuit DC voltage monitor	Main circuit DC voltage is displayed.	V
1E	Amplifier operation time	Counted while control power supply is ON. The time is displayed value×2 hours.	× 2 hour

For displays of monitor by digital operator, refer to “Chapter 4, Digital operator” .

For displays of monitor by Setup Software, refer to “Setup Software R-SETUP” .

[Maintenance]

◆	Trouble Shooting	8-1
◆	Alarm List	8-3
◆	Trouble shooting when Alarm Occurs	8-5
◆	Inspection / Parts Overhaul	8-25

Corrective Actions for Problems During Operation

When troubles occur without any alarm displayed, check and take corrective actions for them referring to the description below. When alarm rings, take corrective measures referring to “Trouble Shooting When Alarm Rings” .



Conducting investigations or corrective actions without turning the power OFF is dangerous, and could lead to injury.

No	Problems	Investigation	Assumed causes and corrective actions
1	“≡” does not blink in 7-segment LED even if main power is ON.	Check the voltage at the power input terminal.	<ul style="list-style-type: none"> If voltage is low, check the power supply. If there is no voltage, check that wires and screws are fastened properly.
		Check if red “CHARGE” LED is blinking.	<ul style="list-style-type: none"> Internal power circuit of servo amplifier is defective. → Replace the servo amplifier.
2	7-segment LED displays a rotating character “8” (Servo ON status), but motor does not rotate.	Check if command is entered.	<ul style="list-style-type: none"> Reenter the previous command.
		Check if servo is locked.	<ul style="list-style-type: none"> Fasten the connecting screws, as power line of motor is not connected.
		Check if torque limit is input.	<ul style="list-style-type: none"> Because torque limit has been input, motor cannot rotate more than load torque.
		Enter deviation clear to check if process is continued.	<ul style="list-style-type: none"> Stop the input of deviation clear.
3	Rotations of servo motor are unstable and less than the specified command.	Check if proportional control is entered.	<ul style="list-style-type: none"> Stop the input of proportional control.
		Check if torque limit is input.	Quit inputting torque limit.
4	Servo motor rotates only once, and stops.	Check motor power line.	<ul style="list-style-type: none"> The motor power line is not connected.
		Check if the encoder resolution settings are correct.	<ul style="list-style-type: none"> Change the settings and turn ON the power again.

8. Maintenance

[Trouble Shooting]

No	Problems	Investigation	Assumed causes and corrective actions
5	Motor is accelerated.	Check the motor power line.	<ul style="list-style-type: none"> Phase order of motor power line does not match.
		Check the wiring of encoder cable.	<ul style="list-style-type: none"> Wiring of A phase and B phase of the encoder is incorrect.
6	Motor is vibrating with frequency above 200 Hz.	-	<ul style="list-style-type: none"> Reduce the loop gain speed. Set the torque command low-pass filter and torque command notch filter.
7	Excessive over shoot/ under shoot during starting / stopping.	-	<ul style="list-style-type: none"> Adjust the servo tuning "response". Reduce the loop gain speed. Increase the integral time constant. Simplify the acceleration and declaration command. Use position command low-pass filter.
8	Abnormal sound occurs	Check that there is no defect in mechanical installation.	<ul style="list-style-type: none"> Observe by operating one motor. Pay attention while coupling and confirm that there is no unbalance.
		Check whether abnormal sound is random or periodic while operating at low speed.	<ul style="list-style-type: none"> Confirm that the twisted pair and shield processing of encoder signal line are correct. Confirm that the wiring for encoder line and power line are installed in the same port. Confirm that the power supply voltage is sufficient.

8. Maintenance

[Alarm List]

Alarm List

	Alarm code								Alarm title	Alarm contents	Detection Operations	Alarm Clear
	Display	3 bits output			PY compatible code							
		Bit7	Bit6	Bit5	ALM8	ALM4	ALM2	ALM1				
Abnormality related to drive	2 1 H	0	0	1	0	0	0	1	Power device Abnormality (Over current)	<ul style="list-style-type: none"> Over current of drive module Abnormality in drive power source Overheating of drive module 	D B	V
	2 2 H				0	0	0	1	Electric current abnormality 0	Abnormality of electric current detection value	D B	V
	2 3 H				0	0	0	1	Electric current abnormality 1	Abnormality of Electric current detection circuit	D B	V
	2 4 H				0	0	0	1	Electric current abnormality 2	Abnormality in communication with Electric current detection circuit	D B	V
Abnormality related to load	4 1 H	0	1	0	0	0	1	0	Electrical overload 1	Excessive effective torque	S B	V
	4 2 H				0	0	1	0	Overload 2	Stall over load	D B	V
	4 3 H				0	1	0	1	Regeneration Abnormality	Regeneration load ratio exorbitance	D B	V
	5 1 H				0	0	1	1	Amplifier Overheating	Overheating detection of amplifier ambient temperature	S B	V
	5 2 H				0	0	1	1	In-rush prevention resistance overheating	Detection of in-rush prevention resistance overheating	S B	V
	5 3 H				0	0	1	1	DB resistor Overheating	Overheating detection of DB resistor	S B	V
	5 4 H				0	1	0	1	Internal overheating	Overheating detection of Internal regeneration resistor	D B	V
	5 5 H				0	0	1	1	External overheating	Overheating detection of External regeneration resistor	D B	V
	Alarm code								Alarm name	Alarm contents	Operations while detecting	Alarm clear
	Display	3 bits output			PY compatible code							
		Bit7	Bit6	Bit5	ALM8	ALM4	ALM2	ALM1				
Abnormality in power source	6 1 H	0	1	1	0	1	0	1	Excess voltage	DC Excess voltage of main circuit	D B	V
	6 2 H				1	0	0	1	Main circuit under voltage (Note 1)	DC Main circuit low voltage	D B	V
	6 3 H				1	0	1	0	Main power supply line drop (Note 1)	1 phase of the 3 phase main circuit power supply disconnected	S B	V
	7 1 H				0	1	1	1	Control power supply under voltage (Note 3)	Control power supply low voltage	D B	V (Note 2)
	7 2 H				0	1	1	1	+12 V power supply voltage	Under voltage of +12 V	S B	V
Abnormality related to encoder wiring	8 1 H	1	0	0	1	0	0	0	Encoder A phase/ B Phase pulse signal abnormality 1	<ul style="list-style-type: none"> Incremental encoder (A, B, Z) signal line break Power supply break 	D B	" "
	8 2 H				1	0	0	0	Breaking of absolute signal wire	Absolute Encoder (PS) signal line break	D B	V
	8 3 H				1	0	0	0	External Encoder A phase/ B phase signal Abnormality	Breaking of full close Encoder (A, B) signal line	D B	V
	8 4 H				1	0	0	0	Abnormality in communication between encoder and amplifier	Encoder serial signal time out	D B	V (Note 5)
	8 5 H				1	0	0	0	Encoder initial process Abnormality	<ul style="list-style-type: none"> Failed to read CS data of incremental encoder Abnormality in initial process of absolute encoder Cable break 	-	" "
	8 7 H				1	0	0	0	CS break	CS signal line break	D B	" "
	9 1 H				1	0	0	0	Encoder command Abnormality	Mismatch of transmission command and reception command	D B	V
	9 2 H				1	0	0	0	Encoder FORM error	<ul style="list-style-type: none"> Start, Stop bit Abnormality Insufficient data length 	D B	V
	9 3 H				1	0	0	0	Encoder SYNC Abnormality	Data cannot be received during the prescribed time after the command is sent.	D B	V
	9 4 H				1	0	0	0	Encoder CRC Abnormality	CRC generated from the received data and sent CRC does not match	D B	V

Note 1: Control power error or servo ready OFF is detected during instantaneous break of 1.5 to 2 cycles.

Detection of control power error and servo ready OFF can be delayed by setting larger value of PFDDLY (Group B Page 16) .

Note 2: When the main power voltage increases or decreases gradually or is suspended, main circuit low voltage or main power failed phase may be detected.

Note 3: When the control panel voltage drops below + 5 V due to suspension of control power, the alarm cannot be cleared without turning OFF the control power, even if having been restored with only a little drop from + 5 V resulting in detection of control power supply error. Turn OFF the control power to reset the alarm.

Note 4: When full-close control/external encoder (CN2 input signal, see System Parameter Page 09) is selected, the alarm can be reset.

Note 5: When the absolute encoder with incremental signal is used, alarm resetting is prohibited.

Note 6: "V" means it is possible to reset. " " means it is not possible to reset.

8. Maintenance

[Alarm List]

	Alarm code								Alarm name	Alarm contents	Operations while detecting	Alarm clear
	Display	3 bits output			PY compatible code							
		Bit7	Bit6	Bit5	ALM8	ALM4	ALM2	ALM1				
Abnormality in encoder main body	A1H	1	0	1	1	0	0	0	Encoder Abnormality 1	• Breakdown of Encoder internal device	D B	Note 3)
	A2H				1	0	0	0	Absolute Encoder Battery Abnormality	• Battery low voltage	D B	Note 3)
	A3H				1	0	0	0	Encoder Overheating	• Motor built-in Encoder Overheating	D B	Note 3)
	A5H				1	0	0	0	Encoder Abnormality 3	• Error generation of multi-rotation data • Abnormality in operations of temperature sensor	D B	Note 3)
	A6H				1	0	0	0	Encoder Abnormality 4	• Encoder internal EEPROM data is not set • Overflow of multi-rotation data	D B	Note 3)
	A7H				1	0	0	0	Encoder Abnormality 5	• Resolver Abnormality • Light receiving abnormality in encoder	D B	Note 3)
	A8H				1	0	0	0	Encoder Abnormality 6	• Resolver disconnection • Light receiving abnormality in encoder	D B	Note 3)
	A9H				1	0	0	0	Encoder failure	• Encoder failure	D B	Note 3)
	B2H				1	0	0	0	Encoder Abnormality 2	• Position data incorrect	D B	Note 3)
	B3H				1	0	0	0	Absolute Encoder rotations counter Abnormality	• Detection of incorrect multiple rotations coefficient	D B	Note 3)
	B4H				1	0	0	0	Absolute Encoder 1 rotation counter abnormality	• Detection of incorrect 1 rotation coefficient	D B	Note 3)
	B5H				1	0	0	0	Exceeds the permitted speed while turning ON the absolute Encoder power	• Exceeds the permitted speed of motor rotation speed when the power is turned ON	D B	Note 3)
	B6H				1	0	0	0	Internal memory error of encoder	• Access error of Encoder internal EEPROM	D B	Note 3)
B7H	1	0	0	0	Acceleration error	• Exceeds the permitted speed for motor rotation	D B	Note 3)				
Control system abnormality	C1H	1	1	0	0	1	1	0	Over speed	• Motor rotation speed is 120 % more than the highest speed limit	D B	V
	C2H				1	1	0	0	Speed control Abnormality	• Torque command and acceleration direction are not matching.	D B	V
	C3H				1	1	0	0	Speed feedback Abnormality	• Motor power disconnection (Note 2)	D B	V
	D1H				1	1	0	1	Excessive position deviation	• Position error exceeds setup value	D B	V
	D2H				1	1	0	1	Position command pulse frequency Abnormality 1	• Frequency of entered position command pulse is excessive	S B	V
	D3H				1	1	0	1	Position command pulse frequency Abnormality 2	• Position command frequency after electronic gear is high.	S B	V
	D FH				1	1	0	1	Test mode end (Note 1)	• Detection in 'Test mode end' status	D B	V
Control system/Memory system abnormality	E1H	1	1	1	1	1	1	1	EEPROM Abnormality	• Abnormality of amplifier with built-in EEPROM	D B	" "
	E2H				1	1	1	1	EEPROM check sum Abnormality	• Error in check sum of EEPROM (entire area)	-	" "
	E3H				1	1	1	1	Internal RAM Abnormality	• Access error in CPU built in RAM	-	" "
	E4H				1	1	1	1	Process abnormality in CPU ~ ASIC	• Access abnormality in CPU ~ ASIC	-	" "
	E5H				1	1	1	1	Parameter error 1	• Detection when non-corresponding or undefined amplifier, motor, encoder code are specified.	-	" "
	E6H				1	1	1	1	Parameter error 2	• Error in combining motor, encoder, and/or amplifier code set from system parameter	-	" "
	F1H				1	1	1	1	Task process Abnormality	• Error in interruption process of CPU	D B	" "
	F2H				1	1	1	1	Initial timeout	• Detection when initial process does not end within initial process time	-	" "

Note 1: Alarm that rings in 'Test mode end' status is not recorded in the alarm history.

Note 2: When there is a rapid motor slow down simultaneous with servo ON, there is a possibility that a break in the motor's power line cannot be detected.

Note 3: Due to abnormality in encoder main body, encoder clear may sometimes be needed.

Note 4: "V" means it is possible to reset. " " means it is not possible to reset.

Warning List

	Warning Title	Warning Contents
Load system	Overload Warning	• When the effective torque exceeds the set torque
	Regenerated Overload Warning	• In case of overload of regenerative resistance
	Amplifier Overheating Warning	• Ambient temperature of the amplifier is out of range of the set temperature
Power supply system	Main circuit is charging	• Voltage of main circuit is above DC 105 V
External input system	Forward over travel	• While entering forward over travel
	Reverse over travel	• While entering reverse over travel
Encoder system	Absolute encoder battery warning	• Battery voltage is below 3.0 V
Control system	Restricting torque command	• While restricting the torque command by torque restriction value
	Restricting speed command	• While restricting the speed command by speed value.
	Excessive position deviation	• When position deviation warning setup value is outside the proscribed limits

8. Maintenance [Trouble Shooting When Alarm Occurs]

Alarm code 21H (Power Device Abnormality / Over current)

Status at the time of alarm	Cause			
	1	2	3	4
Issued when control power is turned ON.	(V)		V	(V)
Issued at servo input.	V	V	V	
Issued while starting and stopping the motor.	(V)	(V)	(V)	
Issued after extended operating time.	(V)	(V)	(V)	V

Corrective actions

Cause		Investigation and corrective actions
1	<ul style="list-style-type: none"> U/V/W-phase of amplifier is short circuited due to the wiring in amplifier and motor. Also, U/V/W-phases are grounded in the earth. 	<ul style="list-style-type: none"> Check the wiring between the amplifier and motor, and confirm that there is no error. If some error is detected, modify or change the wiring.
2	<ul style="list-style-type: none"> Short circuit or fault in U/V/W phases on servo motor side. 	<ul style="list-style-type: none"> Replace the servo motor.
3	<ul style="list-style-type: none"> Defect in control print panel Defect in power device 	<ul style="list-style-type: none"> Replace the servo amplifier.
4	<ul style="list-style-type: none"> Overheat is detected in Power device (IPM). 	<ul style="list-style-type: none"> Confirm that the cooling fan motor for the servo amplifier is working. If it is not working, replace the servo amplifier. Confirm that the temperature of the control panel (ambient temperature of the servo amplifier) does not exceed 55 . If in excess of 55(C, check the installation method of the servo amplifier, and confirm that the cooling temperature of the control panel is set to below 55

Alarm code 22H (Electric current abnormality 0)

Status during alarm	Cause	
	1	2
Issued when the control power is turned ON.	V	(V)
Issued after the power is turned ON.	(V)	V

Corrective actions

Cause		Investigation and corrective actions
1	<ul style="list-style-type: none"> Defect in control print panel Defect in power device 	<ul style="list-style-type: none"> Replace the servo amp.
2	<ul style="list-style-type: none"> Servo amplifier and motor are not combined properly 	<ul style="list-style-type: none"> Confirm that the proper codes (per the specified Motor Codes) have been used for the servo motor; if not, replace the servo motor.

Note) V means the cause number with high possibility.
 (V) means the cause number with middle possibility.

8. Maintenance [Trouble Shooting When Alarm Occurs]

Alarm code 23H (Current detection abnormality 1)

Alarm code 24H (Current detection abnormality 2)

Status during alarm	Cause	
	1	2
Issued when the control power is turned ON.	V	
Issued during operation.	(V)	V

Corrective actions

Cause	Investigation and corrective actions
1 • Defect in internal circuit of servo amplifier.	• Replace the servo amplifier.
2 • Malfunction due to noise	• Confirm proper grounding of the amplifier. • Add ferrite core or similar countermeasures against noise.

Alarm code 41H (Overload 1)

Status during alarm	Cause								
	1	2	3	4	5	6	7	8	9
Issued when power supply control is turned ON.	V								
Issued at input of servo ON.	V	V							V
After command input, issued without rotating the motor.		V			V	V	V		V
After command input, brief motor rotation			V	V	V		(V)	V	

Corrective actions

Cause	Investigation and corrective actions
1 • Defect in servo amplifier control panel or power element peripheral	• Replace the servo amplifier.
2 • Defect in encoder circuit of servomotor	• Replace the servo motor.
3 • Effective torque exceeds the rated torque.	• Monitor the load status using motor usage ratio monitor (OPRT), and check if effective torque exceeds the rated value. • Or, calculate the motor effective torque from load conditions and operation conditions. If the effective torque is excessive, check the operating or loading, or replace the capacity of the large motor.
4 • Defect in motor-amplifier combination	• Check if the motor in use matches with the recommended type, and replace if it is improper.
5 • Holding brake of servo motor does not release.	• Check that the wiring and voltage of the holding brake are acceptable; if not, repair. → If the above are OK, replace the servomotor.
6 • Wiring of U/V/W –phase between servo amplifier and motor do not match.	• Check the wiring conditions and restore if improper.
7 • One or all connections of U/V/W -phase wiring of servo amplifier / motor is disconnected	• Check the wiring conditions and restore if improper.
8 • Machines collided.	• Check the operating conditions and limit switch.
9 • Encoder pulse number setting does not match with the motor.	• Match the encoder pulse number with the motor.



During the alarm caused by conditions in #3 (above), if OFF→ON of power supply control is repeated, there is a risk of burning out the servo motor.

Wait for longer than 30 min. for cooling purposes after power shut OFF, and resume operations.

Note) V means the cause number with high possibility.

(V) means the cause number with middle possibility.

8. Maintenance [Trouble Shooting When Alarm Occurs]

Alarm code 41H (Overload 2)

Status during alarm	Cause								
	1	2	3	4	5	6	7	8	9
Issued when power supply control is turned ON.	V								
Issued at input of servo ON.	V	V							V
After command input, issued without rotating the motor.		V			V	V	V		V
After command input, brief motor rotation			V	V	V		(V)	V	

Corrective actions

Cause	Investigation and corrective actions
1 •Defect in servo amplifier control panel or power element peripheral	•Replace the servo amplifier.
2 •Defect in encoder circuit of servomotor	•Replace the servo motor.
3 • Rotation is less than 5 0 min ⁻¹ and torque command exceeds approx. 2 times of rated torque.	• Check if torque command exceeds approx. 2 times of the rated torque by torque command monitor (TCMON). • Or, calculate the motor effective torque from load conditions and operation conditions. If the effective torque is excessive, check the operating or loading, or replace the capacity of the large motor.
4 •Defect in motor-amplifier combination	• Check the motor type setting and the motor in use are matching. If not, correct them.
5 •Holding brake of servo motor does not release.	• Check that wirings and voltage for holding brake are correct. If not, repair them. If they are appropriate, replace the servo motor.
6 •Wiring of U/V/W –phase between servo amplifier and motor do not match.	• Check the wiring conditions and restore if improper.
7 •One or all connections of U/V/W -phase wiring of servo amplifier / motor is disconnected	• Check the wiring conditions and restore if improper.
8 •Machines collided.	•Check the operating conditions and limit switch.
9 •Encoder pulse number setting does not match with the motor.	•Match the encoder pulse number with the motor.

Alarm code 43H (Regeneration abnormality)

Status during alarm	Cause							
	1	2	3	4	5	6	7	8
Issued when power supply control is turned ON.							V	
Issued when power supply of main circuit is turned ON.						V	V	V
Issued during operation.	V	V	V	V	V		(V)	

Corrective actions

Cause	Investigation and corrective actions
1 • Exceeded permitted value of regenerating power in built-in regenerative resistance specifications. • Excessive load inertia, or tact time is short.	• Check the load inertia and operating pattern. • Use an external regeneration resistor. • Set the load inertia within the specified range. • Increase the deceleration time. • Increase the tact time.
2 • Regenerative resistance wiring conflicts with built-in regenerative resistance specifications.	• Check wiring and replace if incorrect.
3 • Regenerative resistance wiring conflicts with external regeneration resistor specifications.	• Check wiring and replace if incorrect.
4 • Regeneration resistor is disconnected.	• For built-in regeneration resistor specifications, replace the servo amplifier. • For external regeneration resistor specifications, replace the regeneration resistor.
5 • Resistance value of external regeneration resistor is excessive.	• Replace the current resistance value with a value matching the specifications.
6 • Input power supply voltage exceeds the specified range.	• Check the input power supply voltage level.
7 • Defect in control circuit of servo amplifier.	• Replace the servo amplifier.
8 • When external regenerative resistance is selected for system parameter Page OB and external regenerative resistance is not installed.	• Install the external regenerative resistance. • Set to "Do not connect regenerative resistance".



If the setting of system parameter page OB regeneration resistance is incorrect, regeneration error is not detected properly, and the amplifier and surrounding circuit may be damaged or burnt.

Note) V means the cause number with high possibility.
(V) means the cause number with middle possibility.

8. Maintenance [Trouble Shooting When Alarm Occurs]

Alarm code 51H (Amplifier temperature abnormality)

Status during alarm	Cause				
	1	2	3	4	5
Issued when power supply control is turned ON.	(V)		V	(V)	
Issued during operation.	(V)	V	V	V	
Issued after emergency stop.					V

Corrective actions

Cause		Investigation and corrective actions
1	• Defect in internal circuit of servo amplifier.	• Replace the servo amplifier.
2	• Regenerating power exceeded.	• Check the operating conditions. • Use external regeneration resistor.
3	• Regenerating power is within the specified range but ambient temperature of servo amplifier is out of specified range.	• Confirm that the cooling method maintains the temperature of control panel between 0 ~ 55 .
4	• Regenerating power is within the specified range but built-in cooling fan of servo amplifier is stopped.	• For an amplifier equipped with a fan motor, check that the fan motor is running; if not, replace the servo amplifier.
5	• Regeneration energy during emergency stop exceeded.	• Change the servo amp. • Check the loading condition.



Abnormalities are detected in the internal temperature of the amplifier regardless of its ambient temperature. When an amplifier ambient temperature warning is issued, please be sure to check the cooling method of the control panel.

Alarm code 52H (In-rush prevention resistance overheating) [only for RS1 30]

Status during alarm	Cause		
	1	2	3
Issued when power supply is turned ON.	V		
Issued when main circuit power supply is turned ON.		V	
Issued during operation.			V

Corrective actions

Cause		Investigation and corrective actions
1	Defect in internal circuit of servo amplifier.	Replace the servo amplifier
2	• Power turning ON is repeated too frequently.	• Turn ON/OFF the power less frequently.
3	• Ambient temperature is high.	• For a servo amplifier equipped with a cooling fan motor, check that the fan motor is running properly. If not, replace the servo amplifier. • Check if the temperature inside the control panel (servo amplifier ambient temperature) exceeds 55 . If it does, review the servo amplifier installing method and cooling method of control panel to make it below 55 .

Note) V means the cause number with high possibility.
(V) means the cause number with middle possibility.

8. Maintenance [Trouble Shooting When Alarm Occurs]

Alarm code 53H (DB Overheating)

Status during alarm	Cause	
	1	2
Issued when power supply is turned ON.	V	
Issued during operation.	(V)	V

Corrective actions

Cause	Investigation and corrective actions
1 · Defect in internal circuit of servo amplifier.	· Replace the servo amplifier.
2 · DB operation frequency exceeded.	· Use the dynamic brake so as not to exceed the permissive frequency.

Alarm code 54H (Internal overheating)

Status during alarm	Cause		
	1	2	3
Issued when power supply control is turned ON.	(V)		V
Issued during operation.	(V)	V	V

Corrective actions

Cause	Investigation and corrective actions
1 · Defect in internal circuit of servo amplifier.	· Replace the servo amplifier.
2 · Regenerating power excessive.	· Check the built-in regenerative resistance absorption power. · Check the operating conditions, so that regenerating power is within permitted absorption power. · Use an external regeneration resistor.
3 · Improper wiring of built-in regeneration resistor.	· Confirm improper condition and repair if necessary.



When using a regeneration resistance built in the servo amplifier, make sure to set "built-in regeneration resistance" at system parameter Page 0 B [Regeneration resistance type]. This setting makes the judgment between enabled/disabled of the overheating protection detection treatment of the built-in regeneration resistance. When "No connected regenerative resistance or external regenerative resistance" is selected, overheating of built-in regenerative resistance is not detected. Therefore, there is a danger that built-in regenerative resistance will burn out or be damaged.

Note) V means the cause number with high possibility.

(V) means the cause number with middle possibility.

8. Maintenance [Trouble Shooting When Alarm Occurs]

Alarm code 55H (External abnormality)

When external regenerative resistor and output terminal of upper device are not connected

Status during alarm	Cause	
	1	2
Issued when power supply control is turned ON.	V	(V)

Corrective actions

Cause		Investigation and corrective actions
1	• Validity condition for external trip function is set to 'Valid'.	When not used, set 00 : _Always_Disable at Group9 40.
2	• Defect in control panel of servo amplifier.	• Replace the servo amplifier.

When external regenerative resistor is not connected

Status during alarm	Cause		
	1	2	3
Issued when power supply control is turned ON.	V		(V)
Issued after operation.		V	(V)

Corrective actions

Cause		Investigation and corrective actions
1	• Improper wiring of external regenerative resistance.	• Check wiring and replace if necessary.
2	• External regeneration resistor is operating.	• Check the operating conditions. • Increase the capacity of the external regeneration resistor.
3	• Defect in control panel of servo amplifier.	• Replace the servo amplifier.

When output terminal of upper level device is connected:
Eliminate the alarm trigger of the upper level device.

Note) V means the cause number with high possibility.
(V) means the cause number with middle possibility.

8. Maintenance [Trouble Shooting When Alarm Occurs]

Alarm code 61H (Over voltage)

Status during alarm	Cause			
	1	2	3	4
Issued when power supply control is turned ON.	V			
Issued when power supply of main circuit is turned ON.	V	V		
Issued at the time of motor start/stop.		(V)	V	V

Corrective actions

Cause	Investigation and corrective actions
1 • Defect in control panel of servo amplifier.	• Replace the servo amplifier.
2 • The power supply voltage of main circuit exceeds the rated value.	• Reduce the power supply voltage to within the specified range.
3 • Excessive load inertia.	• Reduce the load inertia to within the specified range.
4 • Incorrect wiring for regeneration resistance • Built-in regeneration circuit is not functioning.	• Wire the regeneration resistance correctly. • While using the external regenerative resistance, check the wiring and resistance value. • Replace the servo amplifier if any abnormality occurs.

Alarm code 62H (Main circuit under voltage)

Status during alarm	Cause				
	1	2	3	4	5
Issued when power supply control is turned ON.				V	(V)
Issued after power supply of main circuit is turned ON.	V	V			
Issued during operation, alarm resetting is possible.		(V)	V		
Issued during operation, alarm resetting is not possible.		V			

Corrective actions

Cause	Investigation and corrective actions
1 • Power supply voltage is below the specified range.	• Check the power supply and set it within the specified range.
2 • Rectifier of main circuit is broken.	• Replace the servo amplifier.
3 • Input voltage is reduced and/or blinking.	• Check the power supply and confirm that there is no blinking or low voltage.
4 • Low voltage outside of the specified range is supplied to the main circuit (R/S/T).	• Check the main circuit voltage. Confirm that there is no external power supply to R/S/T when the main circuit is OFF.
5 • Defect in internal circuit of the servo amplifier.	• Replace the servo amplifier.

Note) V means the cause number with high possibility.

(V) means the cause number with middle possibility.

8. Maintenance [Trouble Shooting When Alarm Occurs]

Alarm code 63H (Main power supply line -drop)

Status during alarm	Cause		
	1	2	3
Issued when power supply control is turned ON.		V	
Issued when power supply of main circuit is turned ON.	V		V
Issued during motor operations.	(V)		
Alarm issued during single-phase power input selection.			V

Corrective actions

Cause		Investigation and corrective actions
1	• One out of 3 phases (R/S/T) is not inserted.	• Check the wiring and repair if necessary.
2	• Defect in internal circuit of Servo amplifier.	• Replace the servo amplifier.
3	• Servo amplifier is not specified for single phase.	• Check the model number and delivery specifications of the servo amplifier and replace it with a servo amplifier for single-phase power supply. • Edit the parameters and use a single-phase specification amplifier.

Alarm code 71H (Under voltage of control power supply)

Status during alarm	Cause		
	1	2	3
Issued at the time of power on.	(V)	V	
Issued during operation.	(V)		V

Corrective actions

Cause		Investigation and corrective actions
1	• Defect in internal circuit of the servo amplifier.	• Replace the servo amplifier.
2	• Power supply voltage is within the specified range.	• Confirm that the power supply is set within the specified range.
3	• Input voltage is fluctuating or stopped.	• Confirm that the power supply is neither stopped nor reduced.

Alarm code 72H (± 12 V Power supply abnormality)

Status during alarm	Cause	
	1	2
Issued when power supply control is turned ON.	(V)	V

Corrective actions

Cause		Investigation and corrective actions
1	• Defect in internal circuit of the servo amplifier.	• Replace the servo amplifier.
2	• Defect in external circuit	• Restart the power supply after removing the connector; if alarm is not issued, check the external circuit. • Restart the power supply after replacing the motor; if alarm is not issued, there is defect in the encoder's internal circuit.

Note) V means the cause number with high possibility.

(V) means the cause number with middle possibility.

8. Maintenance [Trouble Shooting When Alarm Occurs]

Alarm code 81H (Pulse signal abnormality 1 of A phase/B phase)

Alarm code 82H (Disconnection of absolute signal)

Alarm code 83H (External encoder A phase/ B phase signal abnormality)

Alarm code 84H (Error in communication between encoder and amplifier)

Alarm code 87H (CS disconnection)

Status during alarm	Cause					
	1	2	3	4	5	6
Issued when power supply control is turned ON.	V	V	V	V	V	V
Issued after servo is turned ON.				V	V	
Issued during operation.	(V)			V	V	

Corrective actions

Cause		Investigation and corrective actions
1	For encoder wiring: <ul style="list-style-type: none"> •Improper wiring •Connector is removed •Loose connection •Encoder cable is too long •Encoder cable is too thin 	<ul style="list-style-type: none"> • Check wiring and repair any abnormality. • Confirm that the encoder power supply voltage of the motor is above 4.75 V; increase it if below 4.75 V.
2	• Wrong amplifier encoder type is selected.	•Select the correct encoder type.
3	•Motor encoder that does not match with amplifier encoder type is attached.	•Replace with servo motor equipped with proper encoder.
4	•Defect in servo amplifier control circuit	•Replace the servo amplifier.
5	•Defect in servo motor encoder	• Replace the servo motor.
6	•Parameter set to 'Full-close/Servo system'.	• Edit the parameter and set to 'Semi-close/System setup'.

Alarm code 85H (Abnormality in initial process of encoder)

Status during alarm	Cause				
	1	2	3	4	5
Issued when power supply control is turned ON.	V	V	V	V	(V)

Corrective actions

Cause		Investigation and corrective actions
1	For encoder wiring: <ul style="list-style-type: none"> •Improper wiring •Connector is removed •Loose connection •Encoder cable is too long •Encoder cable is too thin 	<ul style="list-style-type: none"> • Check wiring and repair any abnormality. • Confirm that the encoder power supply voltage of the motor is above 4.75 V; increase it if below 4.75 V.
2	• Wrong amplifier encoder type is selected.	•Select the correct encoder type.
3	• Defect in servo amplifier control circuit	•Replace the servo amplifier.
4	•Defect in servo motor encoder	•Replace the servo motor.
5	•Initial position data could not be set, as the number of rotations of the motor is more than 300 min ⁻¹ during power supply.	•Restart the power supply after motor is stopped. (Only when PA 035C sensor is used.)

Note) V means the cause number with high possibility.

(V) means the cause number with middle possibility.

8. Maintenance [Trouble Shooting When Alarm Occurs]

Alarm code 91H (Encoder command abnormality)

Alarm code 92H (Encoder FORM error)

Alarm code 93H (Encoder SYNC Abnormality)

Alarm code 94H (Encoder CRC Abnormality)

When abnormalities are detected in the internal part of the absolute position detector for the start-stop synchronization system.

Status during alarm	Cause		
	1	2	3
Issued when control power supply is turned ON.	(V)	V	V

Corrective actions

Cause		Investigation and corrective actions
1	• Defect in encoder	• Replace the servo motor.
2	• Malfunction due to noise	• Confirm proper grounding of the amplifier. • Check the shielding of the encoder cable. • Add ferrite core or similar countermeasures against noise.
3	• Abnormality in encoder wiring.	• Check wiring between the encoder and amplifier.

Alarm code A1H (Encoder Abnormality 1)

When abnormalities are detected in the internal part of the absolute position detector (RA062M) for the Manchester encoding system.

Status during alarm	Cause
	1
Issued when power supply is turned ON.	V
Issued during operation.	V

Corrective actions

Cause		Investigation and corrective actions
1	• Defect in internal circuit of encoder	• Turn ON the power supply again; if not restored, replace the motor.



“Encoder clearing and alarm resetting methods” vary depending on the sensor/encoder in use.
Refer to page 49 “Materials; Encoder Clear”.

Alarm code A2H (Abnormality in absolute encoder battery)

Status during alarm	Cause	
	1	2
Issued when control power is turned ON.	V	V
Issued during operation.		V

Corrective actions

Cause		Investigation and corrective actions
1	• Loose connection of battery cable.	• Confirm the battery connection in the front ON/OFF switch of the amplifier.
2	• Low battery voltage	• Check the battery voltage.



“Encoder clearing and alarm resetting methods” vary depending on the sensor/encoder in use.
Refer to page 49 “Materials; Encoder Clear”.

Note) V means the cause number with high possibility.
(V) means the cause number with middle possibility.

8. Maintenance [Trouble Shooting When Alarm Occurs]

Alarm code A3H (Encoder overheating)

When abnormalities are detected in the internal part of the absolute position detector for the start-stop synchronization system.

Status during alarm	Cause		
	1	2	3
Issued when control power supply is turned ON.	(V)	V	
Issued while stopping the motor.	(V)	V	
Issued during motor operations.		V	V

Corrective actions

Cause		Investigation and corrective actions
1	• Defect in internal circuit of encoder	• Turn ON the power supply again; if not restored, replace the motor.
2	• Motor is not generating heat, but encoder ambient temperature is high.	• Confirm that the cooling method keeps the encoder ambient temperature below 80°C.
3	• Motor is overheated.	• Confirm the cooling procedure of the servo motor.



“Encoder clearing and alarm resetting methods” vary depending on the sensor/encoder in use.

Refer to page 49 “Materials; Encoder Clear”.

Alarm code A5H (Encoder abnormality 3)

When abnormalities are detected in the internal part of the absolute position detector for the start-stop synchronization system.

Status during alarm	Cause		
	1	2	3
Issued when power supply is turned ON.	(V)	V	V
Issued during motor operations.	(V)	V	

Corrective actions

Cause		Investigation and corrective actions
1	• Defect in internal circuit of encoder	• Turn ON the power supply again; if not restored, replace the motor.
2	• Malfunction due to noise	• Confirm proper grounding of the amplifier. • Check the shielding of the encoder cable. • Add ferrite core or similar countermeasures against noise.
3	• Number of rotations exceeds the permitted number of rotations.	• Turn ON the power supply again, when motor is stopped.



“Encoder clearing and alarm resetting methods” vary depending on the sensor/encoder in use.

Refer to page 49 “Materials; Encoder Clear”.

Note) V means the cause number with high possibility.
(V) means the cause number with middle possibility.

8. Maintenance [Trouble Shooting When Alarm Occurs]

Alarm code A6H (Encoder abnormality 4)

When abnormalities are detected in the internal part of the absolute position detector for the start-stop synchronization system.

Status when alarm rings.	Cause		
	1	2	3
Issued when power supply is turned ON.	V	V	
Issued during motor operations.		V	V

Corrective actions

Cause		Investigation and corrective actions
1	• Defect in internal circuit of encoder	• Turn ON the power supply again; if not restored, replace the motor.
2	• Malfunction due to noise	• Confirm proper grounding of the amplifier. • Check the shielding of the encoder cable. • Add ferrite core or similar countermeasures against noise.
3	• Multi-rotation counter overflows.	• Correct the operation pattern, and avoid the continuous operation in a fixed direction.



"Encoder clearing and alarm resetting methods" vary depending on the sensor/encoder in use.
Refer to page 49 "Materials; Encoder Clear".

Alarm code A7H (Encoder abnormality 5)

Alarm code A8H (Encoder abnormality 6)

Alarm code A9H (Encoder failure)

When abnormalities are detected in the internal part of the absolute position detector for the start-stop synchronization system.

Status during alarm	Cause	
	1	2
Issued when power supply is turned ON.	V	V
Issued during motor operations.	(V)	V

Corrective actions

Cause		Investigation and corrective actions
1	• Defect in internal circuit of encoder	• Turn ON the power supply again; if not restored, replace the motor.
2	• Malfunction due to noise	• Confirm proper grounding of the amplifier. • Check the shielding of the encoder cable. • Add ferrite core or similar countermeasures against noise.



"Encoder clearing and alarm resetting methods" vary depending on the sensor/encoder in use.
Refer to page 49 "Materials; Encoder Clear".

Note) V means the cause number with high possibility.
(V) means the cause number with middle possibility.

8. Maintenance [Trouble Shooting When Alarm Occurs]

Alarm Code B2H (Encoder abnormalities 2)

When abnormality is detected in the internal part of the absolute position detector (RAO62M) of the Manchester system.

Status during alarm	Cause	
	1	2
Issued during operation.	(V)	V

Corrective actions

Cause	Investigation and corrective actions
1 • Defect in internal circuit of encoder	• Turn ON the power supply again; if not restored, replace the motor.
2 • Malfunction due to noise	• Confirm proper grounding of the amplifier. • Check the shielding of the encoder cable. • Add ferrite core or similar countermeasures against noise.



“Encoder clearing and alarm resetting methods” vary depending on the sensor/encoder in use.
Refer to page 49 “Materials; Encoder Clear”.

Alarm code B3H (Absolute encoder rotations counter abnormality)

Alarm code B4H (Absolute encoder 1 rotation counter abnormality)

Alarm code B6H (Encoder memory error)

When abnormalities are detected in the internal part of the absolute position detector for the start-stop synchronization system.

Status during alarm	Cause	
	1	2
Issued when control power supply is turned ON.	V	
Issued while operation.	(V)	V

Corrective actions

Cause	Investigation and corrective actions
1 • Defect in internal circuit of encoder	• Turn ON the power supply again; if not restored, replace the motor.
2 • Malfunction due to noise	• Confirm proper grounding of the amplifier. • Check the shielding of the encoder cable. • Add ferrite core or similar countermeasures against noise.



“Encoder clearing and alarm resetting methods” vary depending on the sensor/encoder in use.
Refer to page 49 “Materials; Encoder Clear”.

Note) V means the cause number with high possibility.
(V) means the cause number with middle possibility.

8. Maintenance [Trouble Shooting When Alarm Occurs]

Alarm code B5H (Over speed and multiple rotations generation abnormality)

When abnormalities are detected in the internal part of the absolute position detector for the start-stop synchronization system.

Status during alarm	Cause		
	1	2	3
Issued when power supply is turned ON.	V		(V)
Issued while stopping the motor.	V	V	
Issued while rotating the motor.	(V)	V	V

Corrective actions

Cause		Investigation and corrective actions
1	• Defect in internal circuit of encoder	• Turn ON the power supply again; if not restored, replace the motor.
2	• Malfunction due to noise	• Confirm proper grounding of the amplifier. • Check the shielding of the encoder cable. • Add ferrite core or similar countermeasures against noise.
3	• Number of motor rotations exceeds the permitted speed.	• Check the operation pattern and reduce the maximum number of rotations.

 "Encoder clearing and alarm resetting methods" vary depending on the sensor/encoder in use.
Refer to page 49 "Materials; Encoder Clear".

Alarm code B7H (Acceleration abnormality)

When abnormalities are detected in the internal part of the absolute position detector for the start-stop synchronization system.

Status during alarm	Cause		
	1	2	3
Issued while stopping the motor.	V	V	
Issued while rotating the motor.	(V)	V	V

Corrective actions

Cause		Investigation and corrective actions
1	• Defect in internal circuit of encoder	• Turn ON the power supply again; if not restored, replace the motor.
2	• Malfunction due to noise	• Confirm proper grounding of the amplifier. • Check the shielding of the encoder cable. • Add ferrite core or similar countermeasures against noise.
3	• The acceleration of motor rotation exceeds the permitted acceleration	• Check the operation pattern, and extend the acceleration and deceleration time.

 "Encoder clearing and alarm resetting methods" vary depending on the sensor/encoder in use.
Refer to page 49 "Materials; Encoder Clear".

Note) V means the cause number with high possibility.
(V) means the cause number with middle possibility.

8. Maintenance [Trouble Shooting When Alarm Occurs]

Alarm code C1H (Over speed)

Status during alarm	Cause			
	1	2	3	4
Issued when control power supply is turned ON.	V	(V)		
Issued if command is entered after Servo ON	(V)	V		
Issued when the motor is started.			V	V
Issued other than operating and starting the motor		V	V	

Corrective actions

Cause		Investigation and corrective actions
1	• Defect in control panel of servo amplifier.	• Replace the servo amplifier.
2	• Defect in the encoder of servo motor	• Replace the servo motor.
3	• Excessive overshoot while starting.	<ul style="list-style-type: none"> • Monitor speed with the analog monitor. → Adjust the servo parameters if overshoot is excessive. → Simplify the acceleration and deceleration command pattern. → Reduce the load inertia.
4	• Wiring of U/V/W -phase between servo amplifier and motor do not match.	• Check the wiring and repair any irregularities.

Note) V means the cause number with high possibility.
 (V) means the cause number with middle possibility.

8. Maintenance [Trouble Shooting When Alarm Occurs]

Alarm code C2H (Speed control abnormality)

Status during alarm	Cause				
	1	2	3	4	5
Issued when control power supply is turned ON.					V
Issued while due to input of Servo ON	V		V		
Issued if command is entered.	V	V	V		
Issued while starting and stopping the motor.				V	

Corrective actions

Cause		Investigation and corrective actions
1	• Wiring of U/V/W -phase between servo amplifier and motor do not match.	• Check the wiring and repair any irregularities.
2	• The wiring of A, B phase of INC-E and ABS-EI encoder connection is incorrect.	• Check the wiring and repair any irregularities.
3	• The motor is vibrating (oscillating).	• Adjust the servo parameters so that servo motor will not vibrate (oscillate).
4	• Excessive overshoot and undershoot.	• Monitor speed with the analog monitor. • Adjust the servo parameters to reduce overshoot and undershoot. • Increase acceleration and deceleration command time. Mask the alarm.
5	• Abnormality in servo amplifier control circuit	• Replace the servo amplifier.



For the speed control error alarm, an alarm may occur while starting and stopping when load inertia is excessive.

For this reason, in the gravitational axis applications, "Do not detect" is selected as the standard setting.

If its detection is needed, consult our representatives.

Alarm code C3H (Speed feedback abnormality)

Status during alarm	Cause		
	1	2	3
Issued when command is entered.	V	(V)	V

Corrective actions

Cause		Investigation and corrective actions
1	• Motor is not rotating.	• Confirm that the power line is properly connected. • Replace the servo motor.
2	• Defect in internal circuit of servo amplifier.	• Replace the servo amplifier.
3	• The motor is vibrating (oscillating).	• Adjust the servo parameter so that servo motor will not vibrate (oscillate).

Note) V means the cause number with high possibility.

(V) means the cause number with middle possibility.

8. Maintenance [Trouble Shooting When Alarm Occurs]

Alarm code D1H (Excessive position deviation)

Status during alarm	Cause											
	1	2	3	4	5	6	7	8	9	10	11	12
Issued when control power supply is turned ON.										V		
Issued when servo ON is stopped.						V					V	
Issued immediately after entering the command.	V	(V)	V	V	V		V	(V)	V		(V)	
Issued during starting or stopping at high speed.	V	V					V	V	V		(V)	V
Issued during the operations by lengthy command.		V					V	(V)			(V)	

Corrective actions

	Cause	Investigation and corrective actions
1	• Position command frequency is high or acceleration and deceleration time is short.	• Correct the position command of the controller
2	• Excessive initial load or low motor capacity.	• Correct the load condition or increase the motor capacity
3	• Holding brake is not released.	• Check the wiring and repair any abnormalities. If specified voltage is applied, replace the servo motor.
4	• Motor is mechanically locked or machine is colliding.	• Check the machinery system.
5	• One or all phases of U/V/W -phase of the servo amplifier and motor has disconnected.	• Check and repair the wiring connections.
6	• Motor is being rotated by an external force (Gravity, etc.) during stopping (positioning completion).	• Check the load, and/or increase the motor capacity.
7	• Valid current limit command is entered by the controller, and the current limit setting is reduced. • Number of encoder pulses does not match with the motor.	• Increase the current limit value or disable the current limit. • Match the number of motor encoder pulses.
8	• Settings of servo parameters (Position loop gain, etc.) are not appropriate.	• Check the servo parameter settings (Raise the position loop gain, etc.)
9	• Excessive deviation setting value is reduced.	• Set a greater value for excessive deviation.
10	• Defect in control panel of servo amplifier.	• Replace the servo amplifier.
11	• Servo motor encoder is defective.	• Replace the servo motor.
12	• Power supply voltage is low.	• Check the power supply voltage.

Alarm code D2H (Position pulse frequency abnormality 1)

Status during alarm	Cause
Issued after entering position command pulse.	V

Corrective actions

	Cause	Investigation and corrective actions
1	• Command for the digital filter setting of the command pulse input is entered	• Decrease the frequency of the command pulse. • Increase the frequency of the digital filter.

Note) V means the cause number with high possibility.
(V) means the cause number with middle possibility.

8. Maintenance [Trouble Shooting When Alarm Occurs]

Alarm code D3H (Abnormal position pulse frequency 2)

Status during alarm	Cause	
	1	2
Issued after entering position command pulse.	V	V

Corrective actions

Cause		Investigation and corrective actions
1	• Frequency of command pulse input is excessive.	• Reduce the frequency of command pulse input.
2	• Setting value of electronic gear is excessive.	• Decrease the electronic gear setting value.

Alarm code DFH (Test mode end)

Status during alarm	Cause
	1
Occurred after execution of test mode.	V

Corrective actions

Cause		Investigation and corrective actions
1	• Normal operation.	• Clear the alarm and restore operation. (After completion of test mode, to confirm any deviation in the controller).

Alarm code E1H (EEPROM abnormality)

Status during alarm	Cause	
	1	2
Issued when control power supply is turned ON.	V	(V)
Issued during display key operation or computer interface operation.		V

Corrective actions

Cause		Investigation and corrective actions
1	• Correct value not read by CPU by nonvolatile memory of built-in servo amplifier.	• Replace the servo amplifier.
2	• Defect in the servo amplifier control panel	• Replace the servo amplifier.

Note) V means the cause number with high possibility.
(V) means the cause number with middle possibility.

8. Maintenance [Trouble Shooting When Alarm Occurs]

Alarm code E2H (Abnormality in the internal data of EEPROM)

Status during alarm	Cause	
	1	2
Issued when control power supply is turned ON.	(V)	V

Corrective actions

Cause		Investigation and corrective actions
1	<ul style="list-style-type: none"> Correct value not read by CPU by nonvolatile memory of built-in servo amplifier 	<ul style="list-style-type: none"> Replace the servo amplifier.
2	<ul style="list-style-type: none"> Failed to write into the nonvolatile memory during last power supply cutoff. 	<ul style="list-style-type: none"> Change the optional parameters, turn ON the power supply again, and confirm that alarm has cleared. → If alarm is not cleared, replace the servo amplifier.

Alarm code E3H (Internal RAM abnormality)

Alarm code E4H (Abnormality in process between CPU and ASIC)

Status during alarm	Cause
	1
Issued when control power supply is turned ON.	V

Corrective actions

Cause		Investigation and corrective actions
1	<ul style="list-style-type: none"> Defect in the servo amplifier control panel 	<ul style="list-style-type: none"> Replace the servo amplifier.

Alarm code E5H (Parameter error 1)

Status during alarm	Cause	
	1	2
Issued when control power supply is turned ON.	V	V
Issued after changing any of system parameters.	V	

Corrective actions

Cause		Investigation and corrective actions
1	<ul style="list-style-type: none"> Selected value is outside the specified range for a system parameter. 	<ul style="list-style-type: none"> Confirm the model number of the servo amplifier. Confirm selected values of system parameters and modify if necessary. → Turn ON the power again and confirm that alarm is cleared.
2	<ul style="list-style-type: none"> Defect in servo amplifier 	<ul style="list-style-type: none"> Replace the servo amplifier.

Note) V means the cause number with high possibility.

(V) means the cause number with middle possibility.

8. Maintenance [Trouble Shooting When Alarm Occurs]

Alarm code E6H (Parameter error 2)

Status during alarm	Cause	
	1	2
Issued when control power supply is turned ON.	V	V
Issued after changing any of system parameters.	V	

Corrective actions

Cause		Investigation and corrective actions
1	<ul style="list-style-type: none"> Selected values of system parameters and actual hardware do not match Improper assembly of system parameter settings. 	<ul style="list-style-type: none"> Confirm the model number of servo amplifier. Confirm selected values of system parameters and correct if necessary. → Turn ON the power again and confirm that alarm is cleared.
2	<ul style="list-style-type: none"> Defect in servo amplifier 	<ul style="list-style-type: none"> Replace the servo amplifier.

Alarm code F1H (Abnormality in task process)

Status during alarm	Cause
	1
Issued while operating.	V

Corrective actions

Cause		Investigation and corrective actions
1	<ul style="list-style-type: none"> Abnormality in control circuit of servo amplifier 	<ul style="list-style-type: none"> Replace the servo amplifier

Alarm code F2H (Initial time out)

Status during alarm	Cause	
	1	2
Issued when control power supply is turned ON.	V	V

Corrective actions

Cause		Investigation and corrective actions
1	<ul style="list-style-type: none"> Defect in internal circuit of servo amplifier 	<ul style="list-style-type: none"> Replace the servo amplifier.
2	<ul style="list-style-type: none"> Malfunction due to noise 	<ul style="list-style-type: none"> Confirm proper grounding of the amplifier. Add ferrite core or similar countermeasures against noise.

Note) V means the cause number with high possibility.





(V) means the cause number with middle possibility.

8. Maintenance

[Inspection/Parts overhaul]

Corrective Actions for Problems During Operation

For maintenance purposes, a daily inspection is typically sufficient. Upon inspection, refer to the following description.

Inspection location	Testing conditions			Inspection Items	Inspection Methods	Solution if abnormal
	Time	During operation	While stopping			
Servo motor	Daily	V		Vibration	Check for excessive vibration.	Contact dealer/sales office.
	Daily	V		Sound	Check if there is no abnormal sound as compared to normal sound.	
	Periodic		V	Cleanliness	Check for dirt and dust.	Clean with cloth or air.  1
	Yearly		V	Measure value of insulation resistance	Contact the dealer or sales office.	
	5000 hours  2		V	Replacement of oil seal		
Servo amplifier	Periodic		V	Cleaning	Check for dust accumulated in the accessories.	Clean with air.  1
	Yearly		V	Loose screws	Check for loose connections	Fasten the screws properly.
absolute encoder back up battery	Regularly  3		V	Battery voltage	Confirm that battery voltage is more than DC3.6V.	Replace the battery.
Temperature	On demand	V		Measure temperature	Ambient temperature Motor frame temperature	Set the ambient temperature within the limit. Check the load condition pattern.



1. While cleaning with air, confirm that there is no oil content and/or moisture in the air.
2. This inspection and replacement period is when water- or oil-proof functions are required.
3. The life expectancy of the battery is approximately 2 years, when its power is OFF throughout the year. For replacement, a lithium battery (ER3V: 3.6V, 1000mAh) manufactured by Toshiba Corp. is recommended.

Parts Overhaul

Parts indicated in Table 9-5 may deteriorate over time. Perform periodic inspection for preventive maintenance.

No.	Part name	Number of average replacement years	Corrective measures / usage conditions
1	Condenser for smoothing main circuit	5 Years	Replacement with new part is necessary. Load ratio : Less than 50% of rated output current of amplifier Usage condition: Average temp. 40°C year-round
2	Cooling Fan motor	5 Years	Replacement with new part is necessary. Usage condition: Average temp. 40°C year-round
3	Lithium battery for absolute sensor [ER3V]	3 Years	Replacement with new part is necessary.
4	Electrolysis condenser (other than condenser for smoothing main circuit)	5 Years	Replacement with new part is necessary. Usage condition: Average temp. 40°C year-round Annual usage period is 4800 hours
5	Fuse	10 Years	Replacement with new part is necessary.

1. Condenser for smoothing the main circuit

- If the servo amplifier is in use for more than 3 years, contact the dealer or sales office.

The capacity of the condenser for smoothing the main circuit is reduced due to the frequency of motor output current and power ON/ OFF during usage, and it may cause damage.

8. Maintenance

[Inspection/Parts overhaul]

- When the condenser is used with an average 40 through out the year, and exceeds more than 50% of the rated output current of servo amplifier, it is necessary to replace the condenser with a new part every 5 years.
- When used in an application where the power turn ON/OFF is repeated more than 30 times a day, consult our representatives.

2. Cooling Fan motor

- The R-Series Amplifier is set corresponding to the degree of pollution specified in EN50178 or IEC 664-1. As it is not dust proof or oil proof, use it in an environment above Pollution Degree 2 (i.e., Pollution Degree 1,2).
- R-Series servo amplifiers models RS1□03, RS1□05 RS1□10 RS1□15 and RS1□30 have a built-in cooling fan; therefore be sure to maintain a space of 50mm on the upper and lower side of the amplifier for airflow. Installation in a narrow space may cause damage due to a reduction in the static pressure of the cooling fan and/or degradation of electronic parts. Replacement is necessary if abnormal noise occurs, or oil or dust is observed on the parts. Also, at an average temperature of 40°C year-round, the life expectancy is 5 years.

3. Lithium battery

- The standard replacement period recommended by our company is the life expectancy of lithium battery based on normal usage conditions. However, if there is high frequency of turning the power ON/OFF, or the motor is not used for a long period, then the life of lithium battery is reduced. If the battery power is less than 3.6 V during inspection, replace it with new one.

How to replace absolute encoder back-up battery

Turn ON the servo amplifier control power supply.

Prepare the replacement lithium battery. [SANYO model number : A L - 0 0 4 9 4 6 3 5 - 0 1]

Open the servo amplifier front cover.

Remove the battery connector.

Take out the used lithium battery and put in the new replacement one (prepared at).

Attach the connector in the right direction.

Close the servo amplifier front cover.

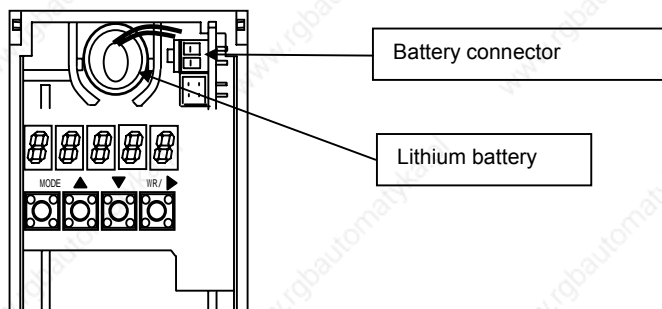

If the battery is replaced while the control power is OFF, multiple rotation counter (position data) of the absolute encoder may be instable. When the amplifier control power is turned ON in this status, an alarm (battery error) may be issued. For this, execute encoder clear and alarm reset to release the alarm status. Also, absolute encoder position data may be instable. Check and adjust the relations between position data and machine coordinate system.



At SANYO DENKI, the overhauled servo amplifier is shipped with the same parameters as the ones before overhauling. Be sure to confirm the parameters before use.

[Specifications]

◆ Servo amplifier	9-1
◆ Pulse output	9-4
◆ Serial output	9-5
◆ General servo motor	9-23
◆ Rotation Direction Specifications	9-23
◆ Mechanical specifications	9-24
◆ Holding brake specifications	9-26

9. Specifications

[Servo amplifier]

General specifications

		Model number		RS1 01	RS1 03	RS1 05	RS1 10	RS1 15	RS1 30	
		Basic specifications		Control function		Speed control, torque control, or position control (Parameter change)				
Control system				IGBT PWM control Sinusoidal drive						
*1 Input power	Main circuit			Three-phase AC200~230V+10, -15%, 50/60Hz±3Hz Single phase AC200~230V+10, -15%, 50/60Hz±3Hz*2 Single phase AC100~115V+10, -15%, 50/60Hz±3Hz*3						
	Controlling circuit			Single phase AC200~230V+10, -15%, 50/60Hz±3Hz Single phase AC100~115V+10, -15%, 50/60Hz ±3Hz*3						
Environment	Ambient temperature**4			0 ~ 55						
	Storage temperature			-20~+65						
	Operating / storage humidity			Below 90%RH (no condensation)						
	Elevation			Below 200 m from the sea level						
	Vibration			0.5G Frequency range 10~55HZ Test for 2H in each direction X.Y.Z						
Shock				5G						
Structure		Built-in tray type power supply								
Mass Kg		0.9	1.0	2.2	5.5	6.8	10.0			
Performance	In case of speed control specification	Speed control range*5		1:5000						
		Frequency characteristics*7		600Hz(JL=JM)						
Built-in functions	Protection functions		Over current, Current detection error, Overload, Regeneration error, Amplifier overheating, External overheating, Over voltage, Main circuit low voltage, Main circuit open-phase, Control power supply error, Sensor error, Over speed, Speed control error, Speed feedback error, Excessive position error, Position command pulse error, CPU error, Built-in memory error, Battery error, Parameter error							
	LED display		Status display, Monitor display, Alarm display, Parameter settings, Adjustment mode							
	Dynamic brake		Built-in							
	Regeneration process		Built-in							
	Applied load inertia		Within the applied load inertia of combined servo motor							
	Monitor output	Speed monitor (VMO)		2.0V±10% (at 1000min ⁻¹)						
		Current monitor (IMO)		2.0V±10% (at 100%)						
Input / Output signal	For speed/torque control specification	Speed command	Command voltage	DC±2.0V (at 1000min ⁻¹ command, Forward motor rotation with positive command, maximum input voltage ±10V)						
			Input impedance	Approx. 10k Ω						
		Torque command	Command voltage	DC±2.0V (at 100% torque, Forward motor rotation with positive command)						
			Input impedance	Approx. 10k Ω						
	Current input limit		DC±2.0V ±15% (at rated armature current)							
	Sequence input signal		Servo on, Alarm reset, Torque limit, Encoder clear, Forward rotation inhibition, Reverse rotation inhibition, Command inhibition, External trip, Forced discharge, Emergency stop, Change of control mode, Proportional control, Gain switch, Internal speed setting							
	Sequence output signal		Servo ready, Power ON, Servo ON, Holding brake timing, Within torque limit, Within speed limit, Low speed, velocity attainment, Matching speed, Zero speed, Command acceptable, Status of gain switch, Speed loop proportional control status, Control mode switchover status, Forward OT, Reverse OT, Warning, Alarm code (3Bit)							
	Position output signal (Pulse division)		N/8192 (N=1~8191), 1/N (N=1~64) or 2/N (N=3~64)							
	For position control specification	Position command	Maximum input pulse frequency	5M pulse/second (Reverse rotation Forward rotation pulse, symbol + Pulse), 1.25M pulse/second (90° phase difference Two phase pulse)						
			Input pulse type	Forward rotation+Reverse rotation command pulse or symbol+Pulse string command or 90° phase difference Two phase sequence command						
Electronic gear			N/D (N=1 ~ 32767, D=1 ~ 32767) however, 1/32767 ≤ N/D ≤ 32767							
Current input limit		DC±2.0V ±15% (at Rated armature current)								
Sequence input signal		Servo ON, Warning reset, Torque limit, Clear encoder, Forward rotation inhibition, Reverse rotation inhibition, Command inhibition, External trip, Forced discharge, Emergency stop, Deviation Clear, Change of control mode, Proportional control, Gain switch, Change of electronic gear, Position loop proportional control								
Sequence output signal		Servo ready, Power ON, Servo ON, Holding brake timing, Within torque limit, Within speed limit, Low speed, velocity attainment, Matching speed, Zero speed, Position fixed, Near range, Command acceptable, Status of gain switch, Speed loop proportional control status, Changed status of electronic gear, Changed control mode status, Forward OT, Reverse OT, Warning, Alarm code (3 bit)								
Position output signal (Pulse division)		N/8192 (N=1~8191), 1/N (N=1~64) or 2/N (N=3~64)								

9. Specifications

[Servo amplifier]

* 1 Source Voltage should be within the specified range.

AC200V Power input type Specified power supply range AC170V~AC253V

AC100V Power input type Specified power supply range AC85V~AC127V

Install a step-down transformer if power supply exceeds the specified power supply.

* 2 AC200V single-phase input type corresponds only to R S 1 0 1 / R S 1 0 3 / R S 1 0 5.

* 3 AC100V single-phase input type corresponds only to R S 1 0 1 / R S 1 0 3.

* 4 When stored in the box, be sure that internal temperature does not exceed this range.

* 5 Minimum rotational speed is determined as equivalent to the amplifier not stopping for a load with maximum continuous torque.

Incoming current

Input voltage	Amplifier model name	Control circuit (Maximum value between 1ms after input)*3	Main circuit (Maximum value between 1.2 seconds after input)
AC200V	RS1 01	40A(O-P)	18A(O-P)*1
	RS1 03		
	RS1 05		
	RS1 10		
	RS1 15		
AC100V	RS1 30	20A(O-P)	9A(O-P)*2
	RS1 01		
	RS1 03		

* 1 The incoming current value is at its maximum when AC230V is supplied.

* 2 The incoming current value is at its maximum when AC115V is supplied.

* 3 Use a thermistor as the incoming current prevention circuit for the power supply control.

When the power is turned ON again after disconnection, a power supply ON/disconnection is repeated over a short time, or the ambient temperature and thermistor temperature is high, an incoming current exceeding the values listed above may occur.

Current leakage

Since the "R series" Servo amplifier drives the motor by PWM control of the IPM, a high-frequency electric current leakage can flow through the floating capacity of the motor winding, power cable or amplifier. This may cause a malfunction in the short circuit breaker and the protective relay installed in the power supply electric circuit. Therefore, use the inverter as an electricity leakage breaker, as it provides a countermeasure against improper operation.

Motor model number	Electric current leakage per motor
RS1 01	0.5 mA
RS1 03	0.5 mA
RS1 05	1.5 mA
RS1 10	3.0 mA
RS1 15	3.0 mA
RS1 30	5.0 mA

- When using 2 or more motors, the electric current leakage each motor is compounded.
- The above values are based on using the recommended tough, **rubber-sheathed 2mm cable** as a power line.
- The system must be grounded (Type D, 3rd type) so that a dangerous voltage condition (on the main part of the machine, i.e., operation panel, etc.) does not occur during an emergency leakage.
- The value of leaked current is measured by an ordinary leak checker (700Hz Filter).

9. Specifications

[Servo amplifier]

Calorific value

Input voltage	Amplifier capacity	Motor model number	Total calorific value of Servo amplifier (W)	Input voltage	Amplifier capacity	Motor model number	Total calorific value of Servo amplifier (W)
AC200V	RS1 01A	Q1AA04003D	11	AC100V	RS1 01A	Q1EA04003D	16
		Q1AA04005D	15			Q1EA04005D	22
		Q1AA04010D	18			Q1EA04010D	27
		Q1AA06020D	24			Q2EA04006D	21
		Q2AA04006D	12			Q2EA04010D	26
		Q2AA04010D	19			Q2EA05005D	22
		Q2AA05005D	16			Q2EA05010D	31
		Q2AA05010D	19			Q1EA06020D	51
		Q2AA05020D	26			Q2EA05020D	43
		Q2AA07020D	32			Q2EA07020D	49
		Q2AA07030D	32				
		Q1AA06040D	44				
		RS1 03A	Q1AA07075D			66	
	Q2AA07040D		45				
	Q2AA07050D		62				
	Q2AA08050D		55				
	Q2AA13050H		65				
	RS1 05A	Q1AA10100D	47				
		Q1AA10150D	61				
		Q1AA12100D	47				
		Q2AA08075D	43				
		Q2AA08100D	45				
		Q2AA10100H	50				
		Q2AA10150H	62				
		Q2AA13100D	58				
	RS1 10A	Q2AA13150D	63				
		Q1AA10200D	111				
		Q1AA10250D	116				
		Q1AA12200D	101				
		Q1AA12300D	123				
		Q1AA13300D	125				
		Q2AA13200H	93				
		Q2AA18200H	101				
	RS1 15A	Q2AA22250H	137				
		Q1AA13400D	146				
		Q1AA13500D	169				
		Q1AA18450M	160				
		Q2AA18350H	138				
		Q2AA18450H	154				
		Q2AA18550R	201				
		Q2AA22350H	137				
	RS1 30A	Q2AA22450R	150				
		Q2AA22550B	191				
		Q2AA22700S	222				
		Q1AA18750H	428				
		Q2AA18550H	361				
		Q2AA18750L	413				
		Q2AA2211KV	496				
		Q2AA2215KV	566				

- Because heat generation of the built-in regeneration resistance is not included in the values given in this table, it may be necessary to add it (if needed).
- If using external regeneration resistance, modify the added of calorific value of external regeneration resistance based on the place where it is installed.
- Be sure to carefully follow the installation method outlined in "Section 2, Installation".

9. Specifications

[Pulse output]

Pulse output

Outputs 90° phase difference two phase pulse (Phase A, Phase B) and Original pulse (Phase Z) from CN 1-3~8

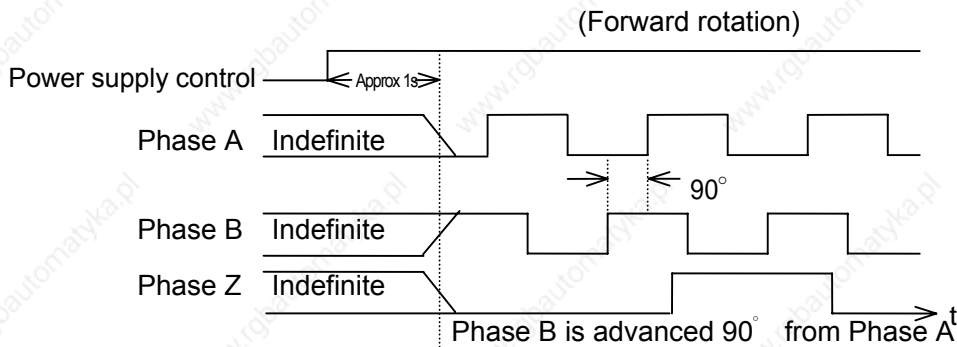

- After turning ON the system, the power supply is not fixed for about 1 sec.
- The encoder pulse (Increment) output is delayed for about 250 μ s after power ON. One pulse is output for every change (once per rotation) of multiple rotations for Phase Z. (Does not determine the position relation of Phase Z and Phase A & B. A single pulse width is output based on the leading or trailing edge of Phase A or Phase B)
- When the division ratio is set other than 1/1, Phase A and Phase B are divided, but Phase Z is output by the original pulse width. In this case, no position relation of Phase Z and Phase A & Phase B is determined.

9. Specifications

[Serial output]

Serial output (Wired-saving absolute encoder)

Encoder signal output (P S) format can be selected from 3 transmission methods.

Select from selection values of [G r o u p C 0 7 encoder signal output (P S) format].

The specifications are shown below.

Selection values	Binary code output
00: Binary	
Transmission method	Asynchronous
Baud rate	9 6 0 0 b p s
Transfer frame	8 frames (11 bit / frame)
Transfer format	Refer to page 9 - 6
Transmission error check	(1 bit) even number parity
Transfer time	9 . 2 m s (T y p .)
Transfer period	Approx. 1 1 m s Refer to page 9 - 1 0
Increase method	Increase during forward rotation

Selection value	A S C I I in decimal code output
01: Decimal	
Transmission method	Asynchronous
Baud rate	9 6 0 0 b p s
Transfer frame	1 6 frame (1 0 bit / frame)
Transfer format	Refer to page 9 - 7
Transmission error check	(1 bit) even number parity
Transfer time	1 6 . 7 m s (T y p .)
Transfer period	Approx. 4 0 m s Refer to page 9 - 1 0
Increase method	Increase during forward rotation

Selection value	Encoder signal direct output
02: Encoder_Signal	
Transmission method	Asynchronous
Baud rate	2 . 5 M b p s、 4 . 0 M b p s
Transfer frame	3 or 4 frame (1 8 bit / frame)
Transfer format	Refer to page 9 - 8
Transmission error check	(8 bit) C R C error check
Transfer time	2 1 . 6 μ s or 2 8 . 8 μ s (T y p .) 2 . 5 M b p s 1 3 . 5 μ s or 1 8 . 0 μ s (T y p .) 4 . 0 M b p s
Transfer period	1 2 5 μ s Refer to page 9 - 1 0
Increase method	Increase during forward rotation



Forward rotation means counterclockwise rotation, as seen from the motor shaft.
If the absolute value is increased to the maximum, the minimum value becomes 0.

9. Specifications

[Serial output]

Transfer format

Selection value 00: Binary Binary code output

1 Structure of Frame 1

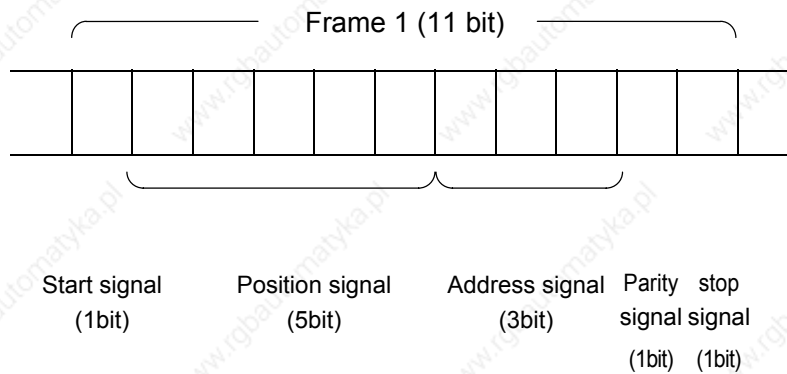

Structure of each frame

	Start signal	Position signal					Address signal			Parity signal	Stop signal
• 1 st frame	0	D0	D1	D2	D3	D4	0	0	0	0 / 1	1
		(LSB)									
• 2 nd frame	0	D5	D6	D7	D8	D9	1	0	0	0 / 1	1
• 3 rd frame	0	D10	D11	D12	D13	D14	0	1	0	0 / 1	1
• 4 th frame	0	D15	D16	D17	D18	D19	1	1	0	0 / 1	1
• 5 th frame	0	D20	D21	D22	D23	D24	0	0	1	0 / 1	1
• 6 th frame	0	D25	D26	D27	D28	D29	1	0	1	0 / 1	1
• 7 th frame	0	D30	0/D31	0/D32	0	0	1	1	1	0 / 1	1
		(MSB)		(MSB)							
• 8 th frame	0	0	0	0	0	0	1	1	1	0 / 1	1

For P A 0 3 5 C

D0 ~ D16 . . . Absolute value of 1 rotation

D17 ~ D32 . . . Absolute value of multiple rotations

For R A 0 6 2 C

D0 ~ D16 . . . Absolute value of 1 rotation

D17 ~ D30 . . . Absolute value of multiple rotations

9. Specifications

[Serial output]

Selection value 01: Decimal A S C I I in decimal code output

Structure of Frame 1

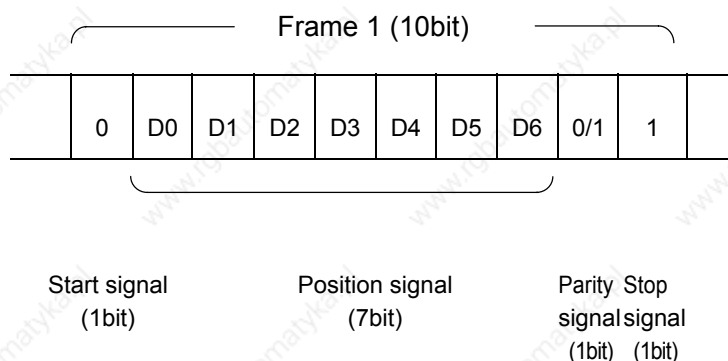

Structure of each frame

Frame number	Transmission character	Data contents
1	“P”(ASCII code 50H)	Indicates that transmission data is position data
2	“+”(ASCII code 2BH)	Symbol of multiple rotations data
3	“0”(ASCII code 30H)	
4	Highest rank	
5	0000 ~ 8191	
6		
7	Lowest rank	
8	“,”(ASCII code 2CH)	End characters
9	“0”(ASCII code 30H)	Absolute value data in 1 rotation (7digits)
10	Highest rank	
11	000000 ~ 131071	
12		
13		
14		
15	Lowest rank	
16	“CR”(ASCII code 0DH)	Carriage return

For P A 0 3 5 C 1 rotation data : 0 0 0 0 0 0 ~ 1 3 1 0 7 1
 Multiple rotation data : 0 0 0 0 0 ~ 6 5 5 3 5

For R A 0 6 2 C 1 rotation data : 0 0 0 0 0 0 ~ 1 3 1 0 7 1
 Multiple rotation data : 0 0 0 0 0 ~ 1 6 3 8 3

9. Specifications

[Serial output]

Selection value 02: Encoder_Signal Encoder signal direct output

Structure of Frame 1

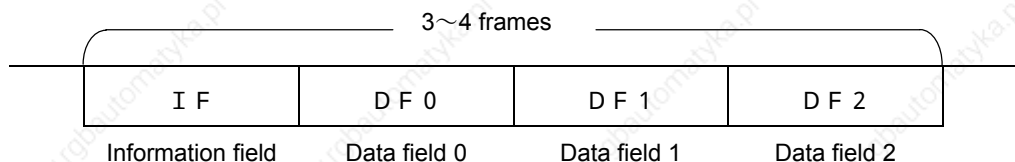

Frame structure

Information field (IF)

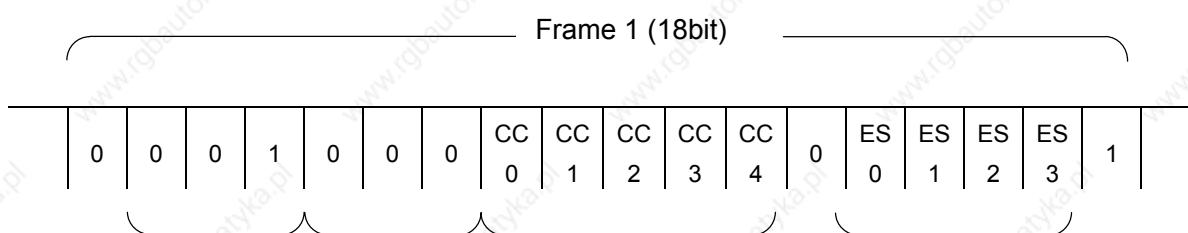

Start signal (1bit)	Sink code (3bit)	Encoder address (3bit)	Command code (5bit)	Fixed (1bit)	Encoder status (4bit)	Stop signal (1bit)
	001fixed	000 fixed				

Command code CC [4:0]

CC[4:0]	Command contents
00000	Absolute full data request
00011	Encoder status request
01000	Status clear request
01010	Status+data clear request with multiple rotations

Encoder status ES [3:0]

ES[3:0]	Status contents	
ES0	PA035C	Accessing sensor, accessing memory in the sensor
	RA062C	Memory operation in the sensor
ES1	PA035C	Battery warning
	RA062C	"0" fixed
ES2	PA035C	Sensor overheat, abnormal memory, overspeed
	RA062C	Sensor overheat, abnormal memory, overspeed, abnormal encoder
ES3	PA035C	Battery alarm, single / multiple rotations counter error
	RA062C	Multiple rotations counter error

9.Specifications

[Serial output]

Data field (DF0~DF2)

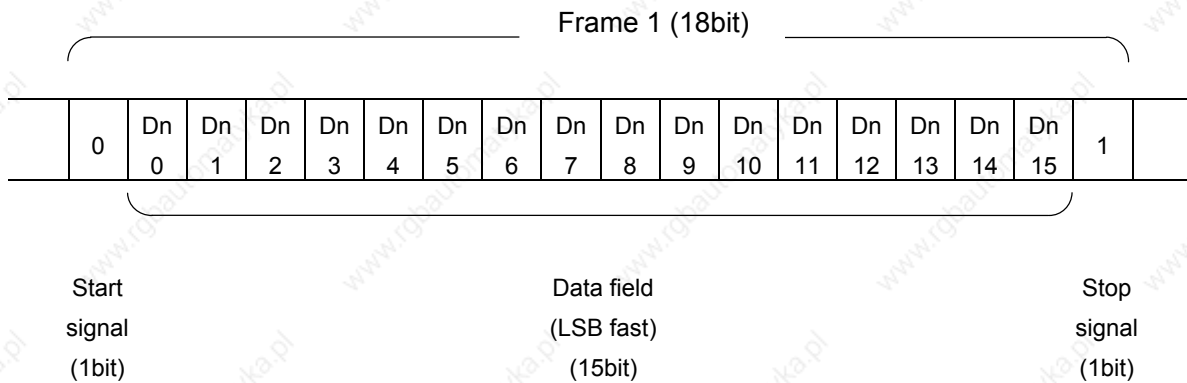

Compatibility table of command and data

Command CC[4:0]	Data			Frame length
	DF0 D0[0:15]	DF1 D1[0:15]	DF2 D2[0:15]	
00000	D0[0:15]=ABS[0:15]	D1[0:15]=ABS[16:31]	D2[0:7]=ABS[32:39] D2[8:15]=CRC[0:7]	4 frames
00011	D0[0:15]=ALM[0:15]	D1[0:7]="00000000"	-	3 frames
01000				
01010				

CRC [0:7] CRC generator polynomial $P(X) = X^8 + X^4 + X^3 + X^2 + 1$

Applicable range is other than start bit and stop bit of each frame

ALM [0:15] Alarm contents differ per the sensor type.

Check sensor specifications for details.

9. Specifications

[Serial output]

Transfer period

Selection value 00: Binary Binary code output

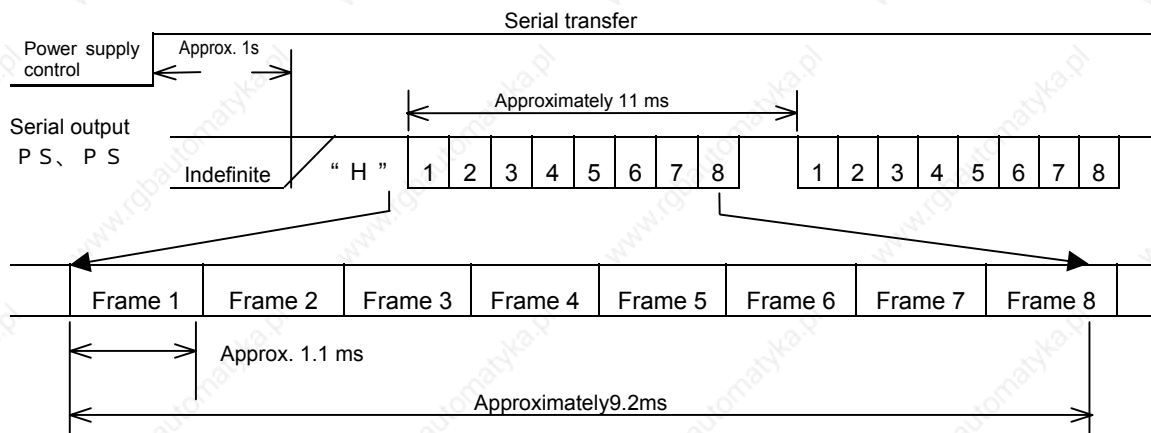

Selection value 01: Decimal 10 ASCII in decimal in decimal code output

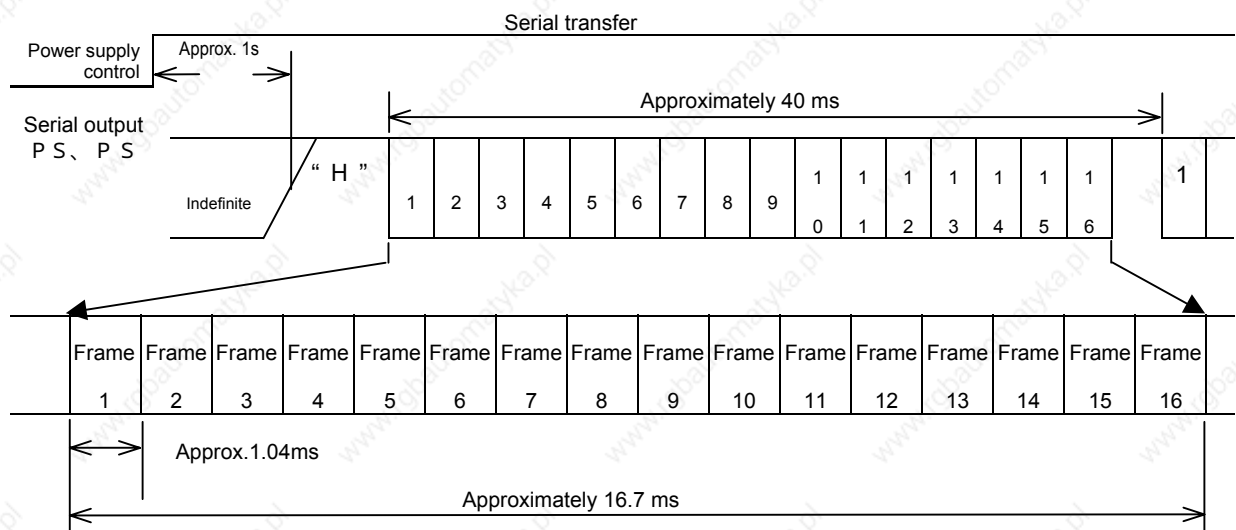

Selection value 02: Encoder_Signal Encoder signal direct output

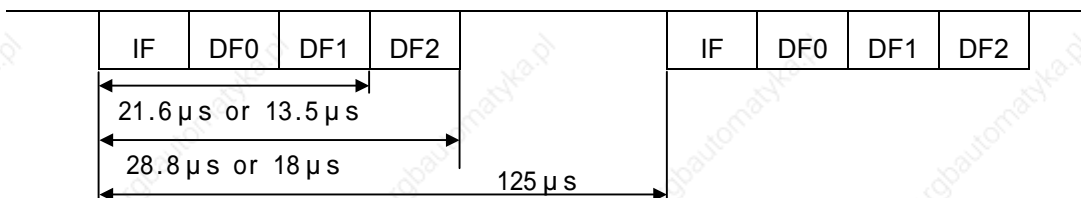

Power supply control is not fixed for 1s after booting.

Communication may not necessarily start from the first frame after 1s.

9. Specifications

[Serial output]

Serial output [Incremental absolute encoder]

Encoder signal output(P S) format can be selected from among the three values.

Select from among selection values of [G r o u p C 0 7 Encoder signal output (P S) format].

The specifications are shown below.

Selection value	Binary code output
00: _Binary	
Transmission method	Asynchronous
Baud rate	9 6 0 0 b p s
Transfer frame number	8 frame (1 1 bit / frame)
Transfer format	Refer to page 9 - 1 2
Transmission error check	(1 bit) even number parity
Transfer time	9 . 2 m s (T y p .)
Transfer period	Approx. 1 1 m s Refer to page 9 - 1 5
Increasing direction	Increase during forward rotation

Selection value	A S C I I in decimal code output
01: _Decimal	
Transmission method	Asynchronous
Baud rate	9 6 0 0 b p s
Transfer frame number	1 6 frame (1 0 bit / Frame)
Transfer format	Refer to page 9 - 1 3
Transmission error check	(1 bit) Even number parity
Transfer time	1 6 . 7 m s (T y p .)
Transfer period	Approx. 4 0 m s Refer to page 9 - 1 5
Increasing direction	Increase during forward rotation

Selection value	Encoder signal direct output
02: _Encoder_Signal	
Transmission method	Manchester encoder synchronous
Baud rate	1 M b p s
Transfer frame number	2 frame (2 5 bit / Frame)
Transfer format	Refer to page 9 - 1 4
Transmission error check	(3 bit) C R C error check
Transfer time	6 6 μ s (T y p .)
Transfer period	8 4 μ s \pm 2 μ s Refer to page 9 - 1 5
Increasing direction	Increase during forward rotation



Forward rotation means anti-clockwise one as seen from motor shaft axis.

When absolute value increases to maximum, it becomes minimum value (0).

9. Specifications

[Serial output]

Transfer format

Selection value 00: Binary Binary code output

Structure of Frame 1

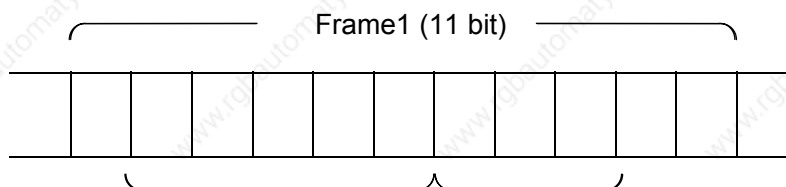

Start signal (1bit) Position signal (5bit) Address signal (3bit) Parity signal (1bit) Stop signal (1bit)

Structure of each frame

	Start signal	Position signal					Address signal			Parity signal	Stop signal
• Frame 1	0	D0	D1	D2	D3	D4	0	0	0	0 / 1	1
		(LSB)									
• Frame 2	0	D5	D6	D7	D8	D9	1	0	0	0 / 1	1
• Frame 3	0	D10	D11	D12	D13	D14	0	1	0	0 / 1	1
• Frame 4	0	D15	D16	D17	D18	D19	1	1	0	0 / 1	1
• Frame 5	0	D20	D21	D22	D23	BATE	0	0	1	0 / 1	1
		(MSB)									
• Frame 6	0	SOT	0	WAR	0	0	1	0	1	0 / 1	1
• Frame 7	0	0	0	0	0	0	0	1	1	0 / 1	1
• Frame 8	0	0	0	0	0	0	1	1	1	0 / 1	1

D0 ~ D10 . . . Absolute value of 1 rotation

D11 ~ D23 . . . Absolute value of multiple rotations

BATE . . . Battery alarm

SOT . . . Absolute value range over

WAR . . . Battery warning

9. Specifications

[Serial output]

Selection value 01: Decimal A S C I I in decimal code output

Structure of Frame 1

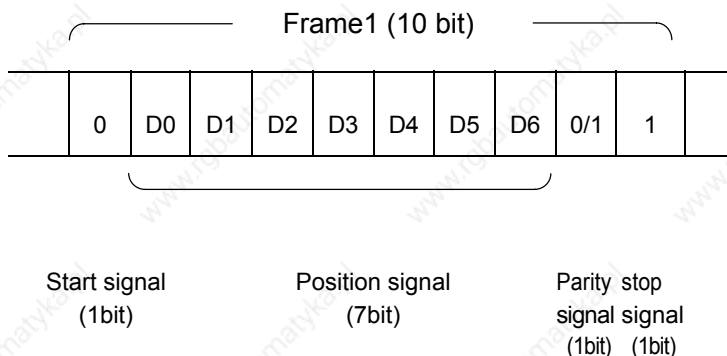

Structure of each frame

Frame number	Transmission character	Data contents
1	“P” (ASCII code 50H)	Indicates that transmission data is a position data
2	“+” (ASCII code 2BH)	Code of multiple rotations
3	“0” (ASCII code 30H)	Multiple rotations data (5 digits)
4	Highest rank	
5	0000 ~ 8191	
6		
7	Lowest rank	
8	“,” (ASCII code 2CH)	End character
9	“0” (ASCII code 30H)	Absolute value data in 1 rotation (7 digits)
10	Highest rank	
11		
12	0000 ~ 2047	
13		
14		
15	Lowest rank	
16	“CR” (ASCII code 0DH)	Carriage return

9. Specifications

[Serial output]

Selection value 02: Encoder_Signal Encoder signal direct output

(Synchronous Manchester encoding)

Structure of Frame 1

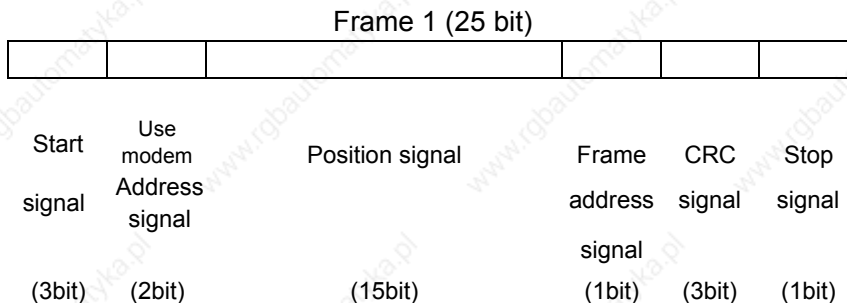

- The first two bits of start signal are output as signal of the whole bit section H (1)
- All the remaining 23 bits after this are Manchester encoded.

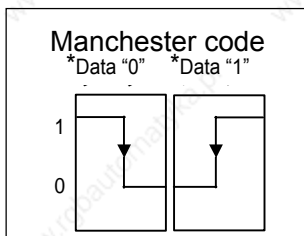

Generator polynomial of CRC signal is $P(X) = X^3 + X + 1$.

Structure of each frame

- First frame

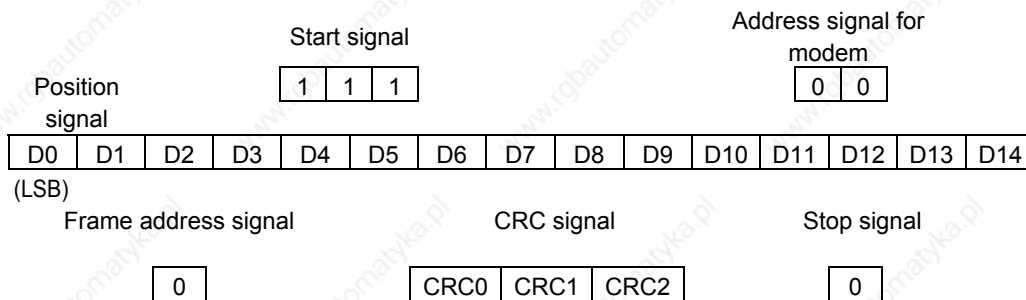

Second frame

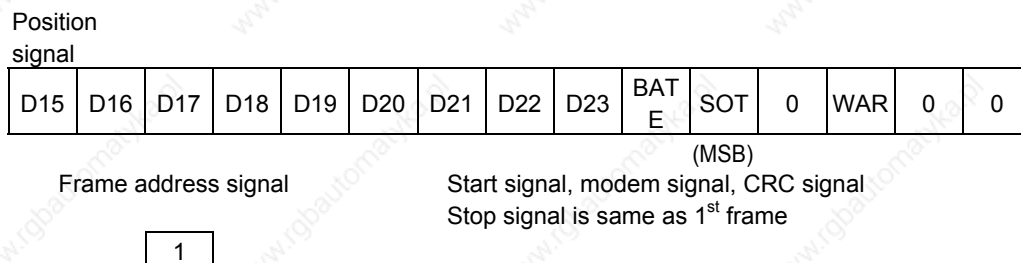

- | |
|----------|
| D0 ~ D10 |
|----------|

 . . . 1 rotation absolute value
- | |
|-----------|
| D11 ~ D23 |
|-----------|

 . . . Multi rotation absolute value
- | |
|------|
| BATE |
|------|

 . . . Battery alarm
- | |
|-----|
| SOT |
|-----|

 . . . Absolute value range over
- | |
|-----|
| WAR |
|-----|

 . . . Battery warning

9. Specifications

[Serial output]

Transfer period

Selection value 00: Binary Binary code output

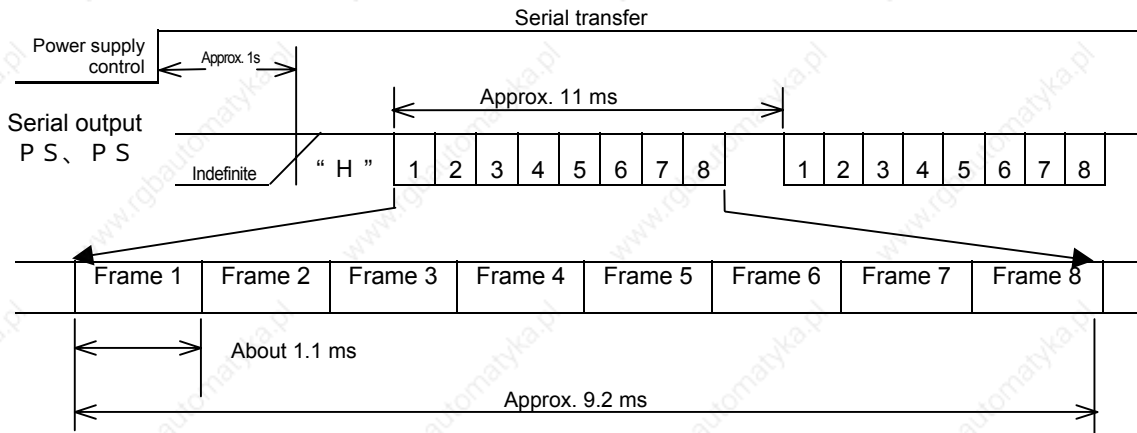

Selection value 01: Decimal Decimal A S C I I code output

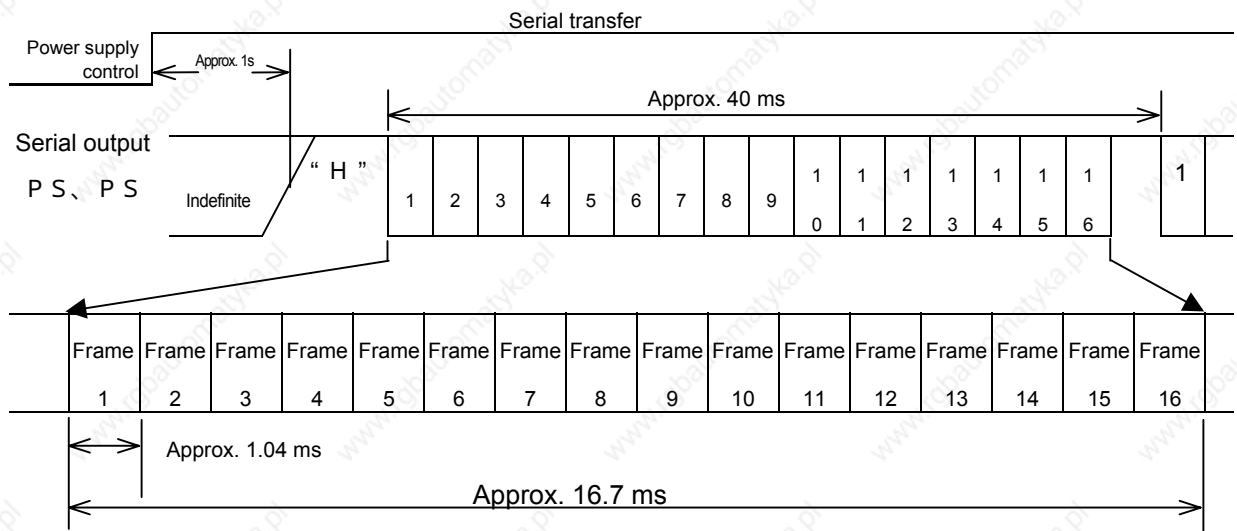

Selection value 02: Encoder_Signal Encoder signal direct output

(Synchronous Manchester encoding)

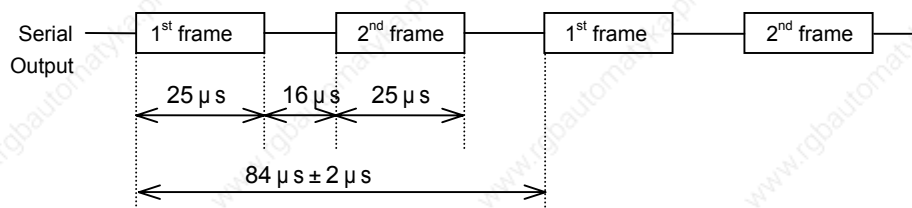

Power supply control is not fixed for 1s after booting.

Communication may not necessarily start from first frame after 1s.

9. Specifications

[Serial output]

Serial output [Absolute encoder with request]

Encoder signal output(P S) format can be selected from among these three values.

Select from among the values of [G r o u p C 0 7 Encoder signal output (P S) format]

The specifications are shown below.

Selection value	Binary code output
00: Binary	
Transmission method	Asynchronous
Baud rate	9600 bps
Number of frames transferred	8 Frames (11 bit/frame)
Transfer format	Refer to page 9 - 1 7
Transmission error check	(1 bit) even number parity
Transfer time	9.2 ms (type.)
Transfer period	Approx. 1 1 m s Refer to page 9 - 2 0
Increase direction	Increase during forward rotation

Selection value	Decimal A S C I I code output
01: Decimal	
Transmission method	Asynchronous
Baud rate	9600 bps
Number of frames transferred	1 6 frame (0 bit / frame)
Transfer format	Refer to page 9 - 1 8
Transmission error check	(1 bit) even number parity
Transfer time	16.7 ms (Type.)
Transfer period	Approx. 4 0 m s Refer to page 9 - 2 0
Increase direction	Increase during forward rotation

Selection value	Encoder signal direct output
02: Encoder_Signal	
Transmission method	Synchronous Manchester encoding
Baud rate	1 M b p s
Number of frames transferred	2 frame (2 7 bit / frame)
Transfer format	Refer to page 9 - 1 9
Transmission error check	(3 bit) C R C error check
Transfer time	6 6 μ s (T y p .)
Transfer period	8 4 μ s ± 2 μ s Refer to page 9 - 2 0
Increase direction	Increase during forward rotation



Forward rotation means anti-clockwise one as seen from motor shaft axis.

When absolute value increases to maximum, it becomes minimum value (0).

9. Specifications

[Serial output]

Transfer format

Selection value 00: Binary Binary code output

Structure of Frame 1

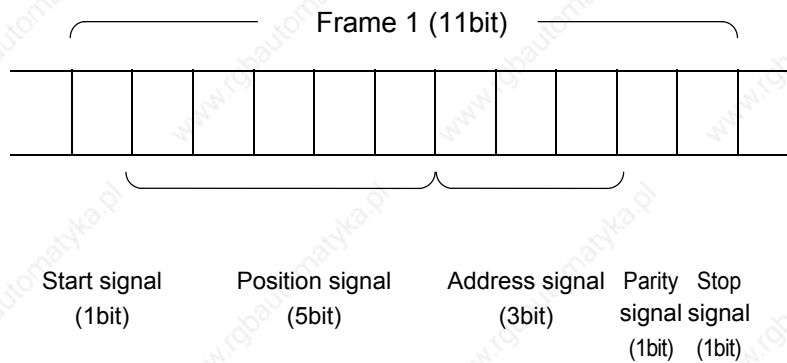

Structure of each frame

	Start signal	Position signal					Address signal			Parity signal	Stop signal
· Frame 1	0	D0	D1	D2	D3	D4	0	0	0	0 / 1	1
		(LSB)									
· Frame 2	0	D5	D6	D7	D8	D9	1	0	0	0 / 1	1
· Frame 3	0	D10	D11	D12	D13	D14	0	1	0	0 / 1	1
· Frame 4	0	D15	D16	D17	D18	D19	1	1	0	0 / 1	1
· Frame 5	0	D20	D21	D22	D23	D24	0	0	1	0 / 1	1
· Frame 6	0	D25	0/D26	0/D27	AW0	AW1	1	0	1	0 / 1	1
		(MSB)		(MSB)							
· Frame 7	0	0	0	0	0	0	0	1	1	0 / 1	1
· Frame 8	0	0	0	0	0	0	1	1	1	0 / 1	1

D0 ~ D14 . . . Absolute value of 1 rotation

D15 ~ D27 . . . Absolute value of multiple rotations

AW0	AW1	Contents
0	0	Normal
0	1	Sensor failure
1	1	Position data trouble
Output L O W		Sensor error

9. Specifications

[Serial output]

Selection value 01: Decimal ASCII code output

Structure of frame 1

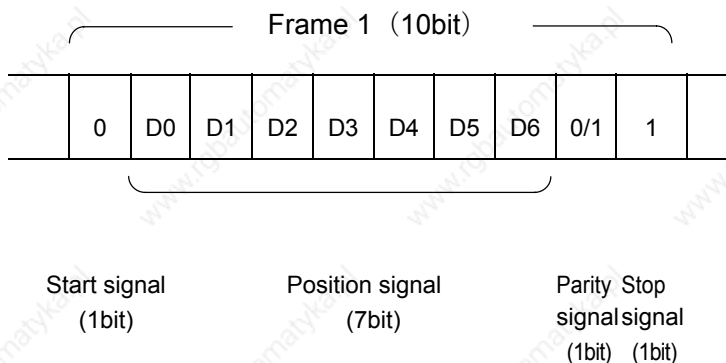

Structure of each frame

Frame No.	Transmission character	Data contents
1	“P” (ASCII code 50H)	Shows that transmission data is position data.
2	“+” (ASCII code 2BH)	Code for data with multiple rotations
3	“0” (ASCII code 30H)	Multiple rotations Data (5digits)
4	Highest rank	
5	0000 ~ 8191	
6		
7	Lowest rank	
8	“,” (ASCII code 2CH)	Delimiter
9	“0” (ASCII code 30H)	Absolute data value in 1 rotation (7 digits)
10	Highest rank	
11		
12	0000 ~ 2047	
13		
14	Lowest rank	
15		
16	“CR” (ASCII code 0DH)	Carriage return

1 rotation data : 0 0 0 0 ~ 3 2 7 6 7

Multiple rotations : 0 0 0 0 ~ 8 1 9 1

9. Specifications

[Serial output]

Selection code 02: Encoder_Signal Encoder signal direct output

(Synchronous Manchester encoding)

Structure of Frame 1

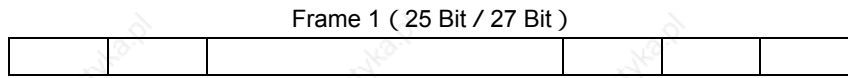

Start Signal	Use modem Address Signal	Signal position	Frame Address Signal	CRC Signal	Stop Signal
(3bit)	(2bit)	(15bit)	(1bit)	(3bit)	(1bit)

- The first 2 bits of start signal is output as the signal of the whole bit interval H(1). The subsequent 23 bits are put into Manchester encoding.

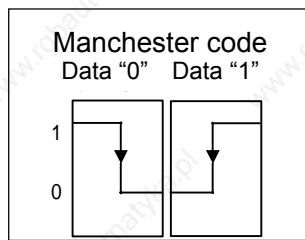

- Generator polynomial of CRC signal is $P(X) = X^3 + X + 1$.

Structure of each frame

- First Frame

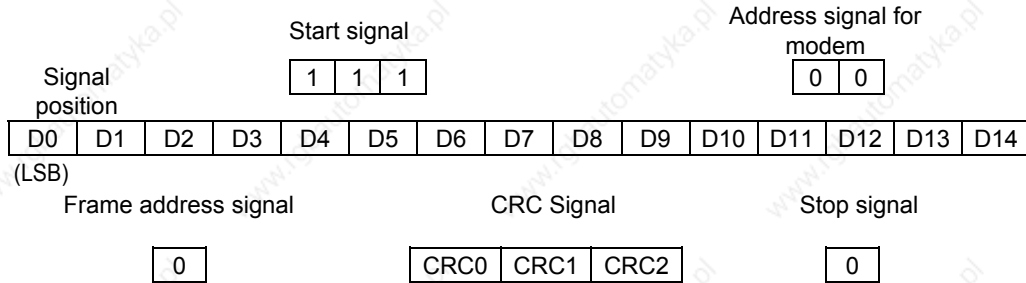

- Second Frame

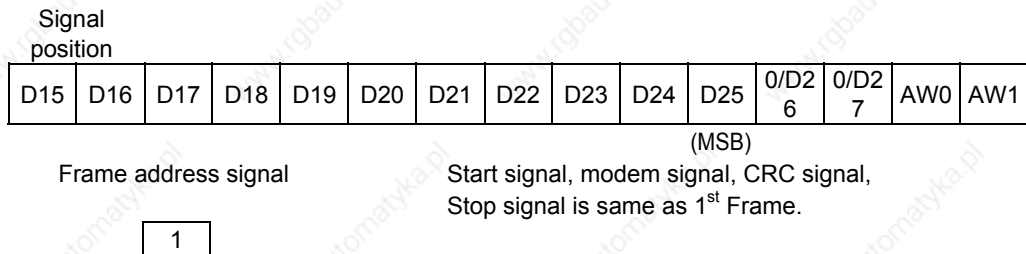

D0 ~ D14 . . . Absolute value of 1 rotation
 D15 ~ D27 . . . Absolute value of multiple rotations

AW0	AW1	Contents
0	0	Normal
0	1	Sensor failure
1	1	Position data trouble
Output L O W		Sensor error

9. Specifications

[Serial output]

Transfer period

Selection value 00: Binary Binary code output

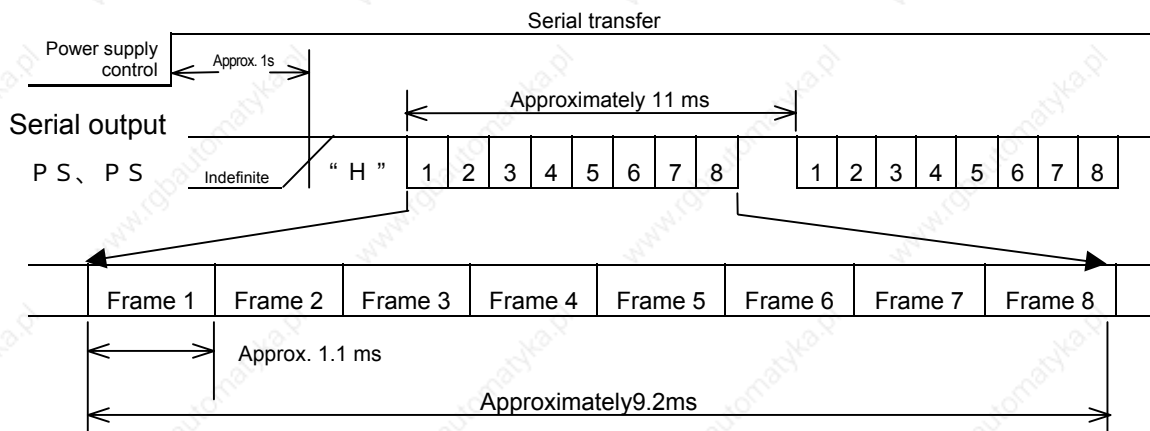

Selection value 01: Decimal Decimal A S C I I code output

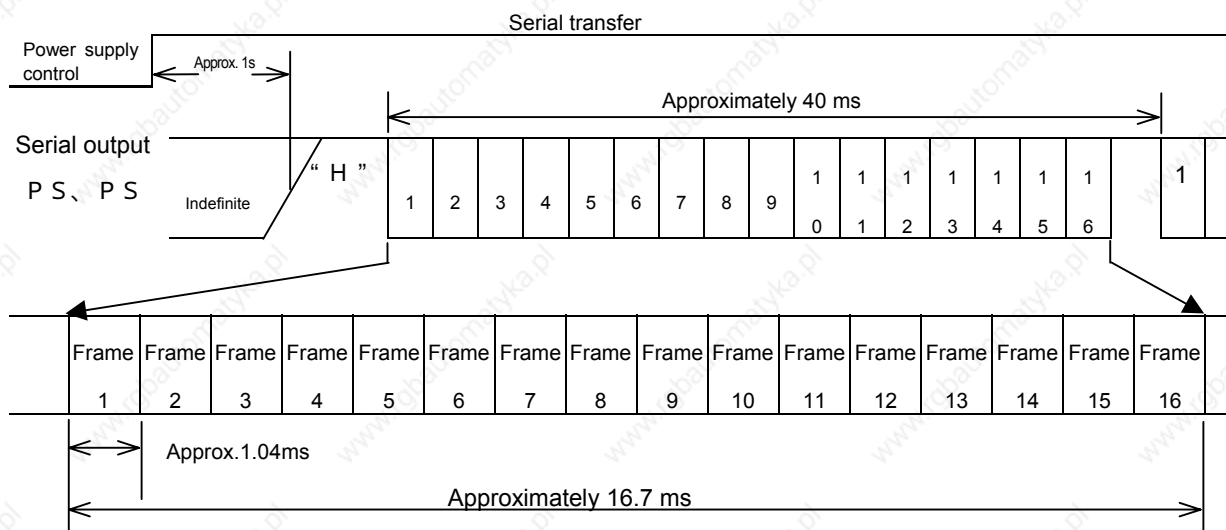

Selection value 02: Encoder_Signal Encoder signal direct output

(Synchronous Manchester encoding)

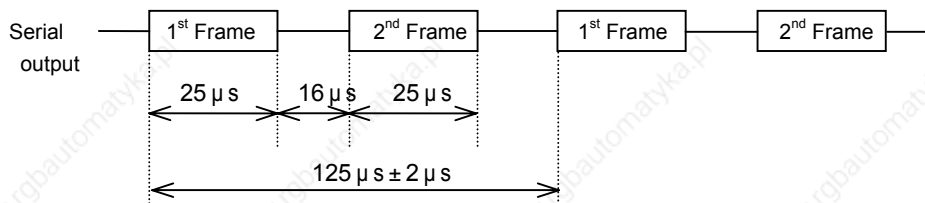

Power supply control is not fixed for 1s after booting.

Communication may not necessarily start from Frame 1 after 1s delay.

9. Specifications

[Serial output]

Serial output [Incremental encoder]

When using the incremental encoder, the actual position monitor value is output, irrespective of the selected value in Group C 07 encoder signal output (PS) format.

When using incremental encoder	
Selection value : invalid	
Transmission method	Asynchronous
Baud rate	9600bps
Number of transferred frames	8 frames (1 1 bit / frame)
Transfer format	Chart below
Transmission error check	(1bit) Even number parity
Transfer time	9.2ms(Type.)
Transfer period	Apprx. 1 1 m s Refer to page 9 - 2 2
Increasing direction	Increasing at normal rotation



Normal rotation means anticlockwise one as seen from motor shaft axis.
Absolute value will be minimum value (0) if it increases to maximum.

Transfer format

Structure of Frame 1

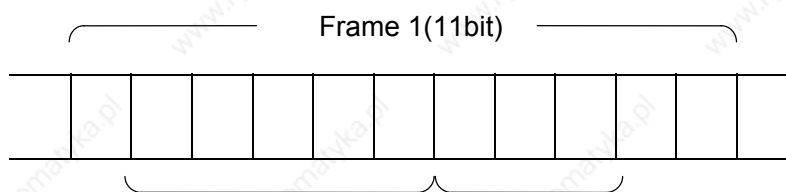

Start signal (1bit) Signal position (5bit) Address signal (3bit) Parity Stop Signal (1bit) Signal (1bit)

Structure of each frame

	Start Signal	Signal position					Address Signal			Parity Signal	Stop Signal
·Frame 1	0	D0	D1	D2	D3	D4	0	0	0	0 / 1	1
		(LSB)									
·Frame 2	0	D5	D6	D7	D8	D9	1	0	0	0 / 1	1
·Frame 3	0	D10	D11	D12	D13	D14	0	1	0	0 / 1	1
·Frame 4	0	D15	D16	D17	D18	D19	1	1	0	0 / 1	1
·Frame 5	0	D20	D21	D22	D23	D24	0	0	1	0 / 1	1
·Frame 6	0	D25	D26	D27	D28	D29	1	0	1	0 / 1	1
·Frame 7	0	D30	D31	0	0	0	0	1	1	0 / 1	1
		(MSB)									
·Frame 8	0	0	0	0	0	0	1	1	1	0 / 1	1

9. Specifications

[Serial output]

● Transfer period

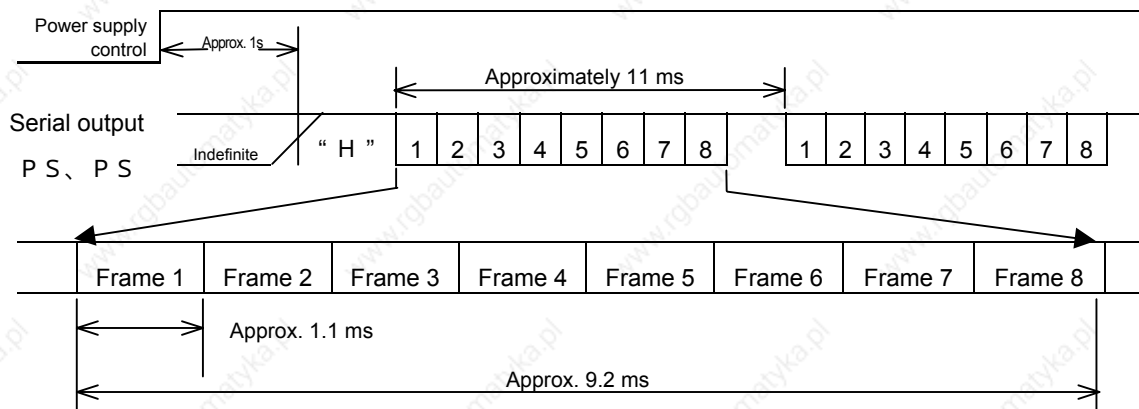

9. Specifications

[Servo motor]

Servo motor general specifications

Series Name	Q1	Q2
Time Rating	Continuous	
Insulation Classification	Type F	
Dielectric Strength Voltage	AC 1500V 1 minute	
Insulation Resistance	DC 500 V, More than 10M	
Protection method	Fully closed, Auto cooling	
	IP 67 (However, Q1 A04,06 and 07 is IP40) It conforms to IP67 by using a waterproof connector, conduit, shell, clamp, etc.	IP 67 *** (However, Q2 A04 is IP40)
Sealing	Sealed (except Q1 A04,06,07)	Sealed (except Q2 A04)
Ambient Temperature	0 ~ + 40	
Storage Temperature	-20 ~ + 65	
Ambient Humidity	20 ~ 90% (without condensation)	
Vibration Classification	V 15	
Coating Color	Munsell N 1.5 equivalent	
Excitation Method	Permanent-magnet type	
Installation Method	Flange mounting	

Rotation Direction Specifications

When a command to increase the position command is entered, the servo motor rotates in a counterclockwise direction from the load side



Encoder Signal Phases

Incremental encoder

< Normal rotation >

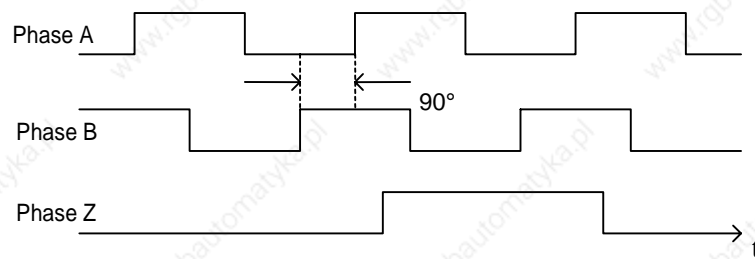

Phase B is ahead of Phase A by 90°.

< Reverse rotation >

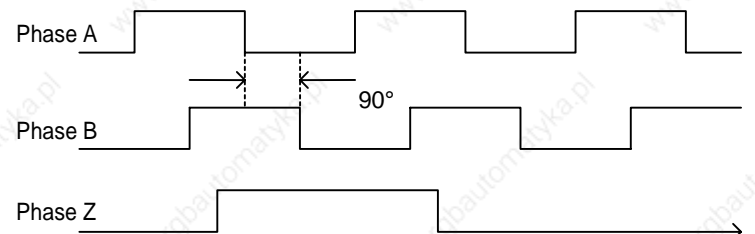

Phase B is behind Phase A by 90°.

When the Z-Phase is high, both A- and B- Phases cross the low level, once every revolution.

Absolute encoder

Normal (forward) rotation: Position data incremental output

Reverse rotation: Position data decreased output

9. Specifications [Servo motor mechanical specifications]

Mechanical specifications

Vibration Resistance

Install the servo motor in a horizontal direction (as shown in the following figure), so that when vibration is applied in any 3 directions (up/down, back/forward, left/right) it can withstand the vibration acceleration up to 24.5m/s^2 .

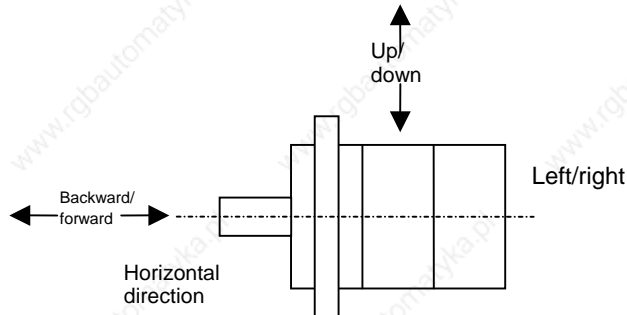

Shock Resistance

Install the shaft of the servo motor in a horizontal direction (as shown in the following figure). It should withstand shock acceleration up to 98 m/s^2 (when shocks are applied in an Up/down direction) for 2 rotations. However, since a precision detector is fixed to the counter-load side of the motor, any shock applied to the shaft may cause damage the detector; therefore, do not subject the shaft to shock under any circumstances.

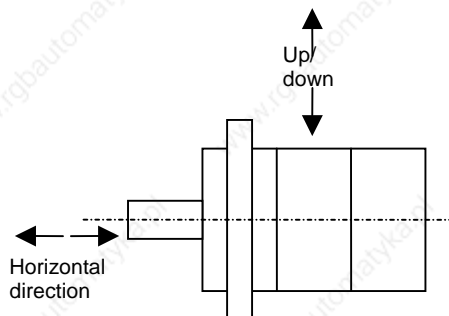

Working accuracy

The following table shows the accuracy of the servo motor output shaft and precision (Total Indicator Reading) of the parts surrounding the shaft.

Items	* 1 T.I.R.	Reference Figure
Vibrations of output shaft terminal	0.02	
Eccentricity of the external diameter of the flange on output shaft M ()	0.06 (Below 86)	
	0.08 (Above 100)	
Perpendicularity of the flange face to output shaft M ()	0.07 (Below 86)	
	0.08 (Above 100)	

* 1 T. I. R (Total Indicator Reading)

9. Specifications [Servo motor mechanical specifications]

Vibration Classification

The vibration classification of the servo motor is V15 or less, at the maximum rotation speed for a single servo motor unit, and is measured in the manner pictured below.

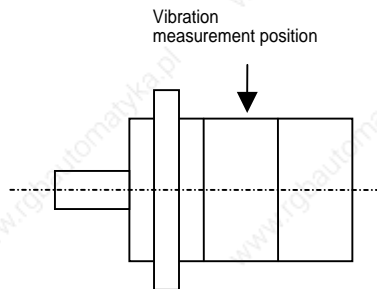

Mechanical Strength

The output strength of the servo motor can withstand instantaneous maximum torque.

Oil seal

A Type S oil seal (as described in the following table) is fixed to the output shaft of the servo motor. This oil seal is produced by NOK Corporation; please contact your dealer or sales representative for replacement of the oil seal.

Servo Motor Model	Oil Seal type (Type S)	Servo Motor Model	Oil Seal type (Type S)	
Q 1 A A 0 4	None	Q 2 A A 0 8	AC 0 8 7 5 A 0	
Q 1 A A 0 6		Q 2 A A 1 0	AC 1 3 0 6 E 0	
Q 1 A A 0 7		Q 2 A A 1 3	AC 1 6 7 7 E 1	
Q 1 A A 1 0	AC 1 3 0 6 E 0	Q 2 A A 1 8	AC 2 3 6 8 E 0	
Q 1 A A 1 2	AC 1 6 7 7 E 1	Q 2 A A 1 8 5 5 0	AC 2 6 5 1 A 8	
Q 1 A A 1 3	AC 1 6 7 7 E 1	Q 2 A A 1 8 7 5 0		
Q 1 A A 1 8 4 5 0	AC 2 3 6 8 E 0	Q 2 A A 2 2	AC 2 3 6 8 E 0	
Q 1 A A 1 8 7 5 0	AC 2 6 5 1 A 8	Q 2 A A 2 2 5 5 0	AC 3 1 5 2 E 0	
Q 2 A A 0 4	None	Q 2 A A 2 2 7 0 0	AC 3 1 5 2 E 0	
Q 2 A A 0 5		AC 0 3 8 2 A 0		Q 2 A A 2 2 1 1 K
Q 2 A A 0 7		AC 0 6 8 7 A 0		Q 2 A A 2 2 1 5 K

9. Specifications

[Holding brake specifications]

Holding brake specifications

An optional holding brake is available for each motor. Since this brake is used for holding, it cannot be used for braking, except for an emergency. Turn brake excitation ON or OFF by using the holding brake timing signal output. When using this signal, set the command for brake release time to 0min¹ for the servo amplifier.

To externally control the holding brake, a response time (as shown in the following table) is required. When using a motor with a brake, determine a time sequence that takes this delay time into account.

	Model	Static friction torque N.m	Release time msec	Braking delay time msec	
				Varistor	Varistor
Q 1	Q 1 A A 0 4 0 0 3 D	0.098	25	15	100
	Q 1 A A 0 4 0 0 5 D	0.157			
	Q 1 A A 0 4 0 1 0 D	0.320			
	Q 1 A A 0 6 0 2 0 D	0.637	30	20	120
	Q 1 A A 0 6 0 4 0 D	1.274			
	Q 1 A A 0 7 0 7 5 D	2.38	40	20	200
	Q 1 A A 1 0 1 0 0 D	3.92	40	30	120
	Q 1 A A 1 0 1 5 0 D	7.84	100	30	140
	Q 1 A A 1 0 2 0 0 D	7.84			
	Q 1 A A 1 0 2 5 0 D	9.80	100	30	140
	Q 1 A A 1 2 1 0 0 D	3.92	100	30	140
	Q 1 A A 1 2 2 0 0 D	7.84	100	30	140
	Q 1 A A 1 2 3 0 0 D	11.8	100	30	140
	Q 1 A A 1 3 4 0 0 D	19.6	120	50	150
	Q 1 A A 1 3 5 0 0 D	19.6			
	Q 1 A A 1 8 4 5 0 M	32.0	150	40	250
Q 1 A A 1 8 7 5 0 H	54.9	300	140	400	
Q 2	Q 2 A A 0 4 0 0 6 D	0.191	25	15	100
	Q 2 A A 0 4 0 1 0 D	0.319			
	Q 2 A A 0 5 0 0 5 D	0.167	15	10	100
	Q 2 A A 0 5 0 1 0 D	0.353			
	Q 2 A A 0 5 0 2 0 D	0.353			
	Q 2 A A 0 7 0 2 0 D	0.69	25	15	100
	Q 2 A A 0 7 0 3 0 D	0.98			
	Q 2 A A 0 7 0 4 0 D	0.98			
	Q 2 A A 0 7 0 5 0 D	1.96	30	20	200
	Q 2 A A 0 8 0 5 0 D	1.96	30	20	200
	Q 2 A A 0 8 0 7 5 D	2.94			
	Q 2 A A 0 8 1 0 0 D	2.94			
	Q 2 A A 1 0 1 0 0 H	3.92	40	30	120
	Q 2 A A 1 0 1 5 0 H	7.84	100	30	140
	Q 2 A A 1 3 0 5 0 H	3.50	40	30	120
	Q 2 A A 1 3 1 0 0 H	9.0	70	30	130
	Q 2 A A 1 3 1 5 0 H	9.0	100	30	140
	Q 2 A A 1 3 2 0 0 H	12.0			
	Q 2 A A 1 8 2 0 0 H	12.0	100	30	140
	Q 2 A A 1 8 3 5 0 H	32.0	120	40	150
	Q 2 A A 1 8 4 5 0 H	32.0	150	40	250
	Q 2 A A 1 8 5 5 0 R	54.9	300	140	400
	Q 2 A A 1 8 5 5 0 H				
	Q 2 A A 1 8 7 5 0 L				
	Q 2 A A 2 2 2 5 0 H	32.0	300	140	400
	Q 2 A A 2 2 3 5 0 H	32.0	300	140	400
	Q 2 A A 2 2 4 5 0 H	32.0	300	140	400
Q 2 A A 2 2 5 5 0 B	90.0	300	140	400	
Q 2 A A 2 2 7 0 0 S	90.0	300	140	400	
Q 2 A A 2 2 1 1 K V					
Q 2 A A 2 2 1 5 K V					

9. Specifications

[Holding brake specifications]

	Model	Static friction torque N.m	Release time msec	Braking delay time msec	
				Varistor	Diode
Q 1	Q 1 E A 0 4 0 0 3 D	0.098	25	15	100
	Q 1 E A 0 4 0 0 5 D	0.157			
	Q 1 E A 0 4 0 1 0 D	0.32			
	Q 1 E A 0 6 0 2 0 D	0.637			
Q 2	Q 2 E A 0 4 0 0 6 D	0.191	25	15	100
	Q 2 E A 0 4 0 1 0 D	0.319			
	Q 2 E A 0 5 0 0 5 D	0.167	15	10	100
	Q 2 E A 0 5 0 1 0 D	0.353			
	Q 2 E A 0 5 0 2 0 D	0.353			
	Q 2 E A 0 7 0 2 0 D	0.69	25	15	100

Brake operating time is measured in the following circuit.

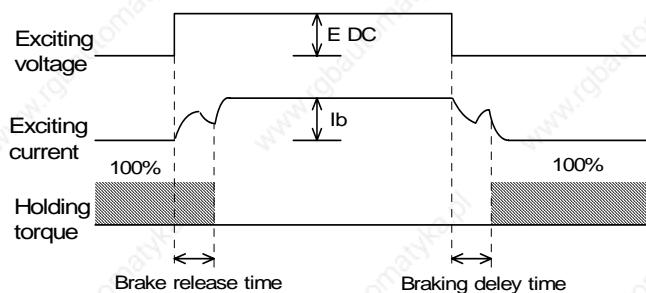
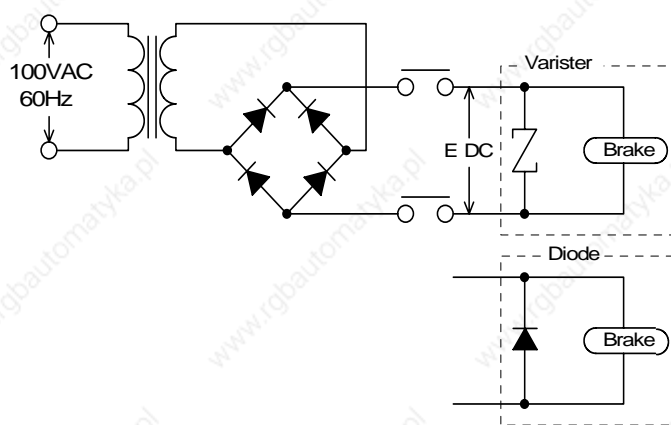

The brake release time and braking delay time refer to those mentioned in the above tables. The brake release time is the same for both the varistor and diode.

Materials

[Selection Details]

◆ Acceleration time / Moderation time / Allowable repetition frequency	1
◆ Loading Precautions	3
◆ Dynamic Brake	4
◆ Regenerative treatment / Regenerative electric power calculation / Confirmation of regenerative electric power	6
◆ External regenerative resistor / Dimension	11

[International Standards]

◆ International standard conformity · Certificate number	18
◆ Compliance with E C directives · Recommended prevention components	20

[Dimension]

◆ Servo amplifier	24
◆ Servo motor	30

[Servo motor data sheet]

◆ Characteristics table	34
◆ Velocity – Torque characteristics	38

[Option]

◆ Connector / Communication cable	43
◆ Metal mounting fittings	44
◆ Monitor box	47
◆ Lithium battery / EMC kit	48

[Encoder clear]

◆ Clear / Reset method	49
----------------------------------	----

[Electronic gear]

◆ Usage	50
-------------------	----

[Shortened model number]

Set-up contents	51
---------------------------	----

Materials: Selection Details [Time of Acceleration and Deceleration/Permitted Repetition]

■ Time of Acceleration and Deceleration

- The motor's acceleration time (t_a) and deceleration time (t_b) when under a constant load is calculated by following method.

$$\text{Acceleration time : } t_a = (J_M + J_L) \cdot (2\pi/60) \cdot \{ (N_2 - N_1) / (TP - TL) \} \quad [s]$$

$$\text{Deceleration time : } t_b = (J_M + J_L) \cdot (2\pi/60) \cdot \{ (N_2 - N_1) / (TP + TL) \} \quad [s]$$

 These expressions are for the rated speed values, but exclude the viscous torque and friction torque of the motor.

t_a : Acceleration time (S)

T_P : Instantaneous maximum stall torque (N · m)

t_b : Deceleration time (S)

T_L : Load torque (N · m)

J_M : Motor inertia (kg · m²)

J_L : Load inertia (kg · m²)

N_1, N_2 : Rotational speed of motor (min⁻¹)

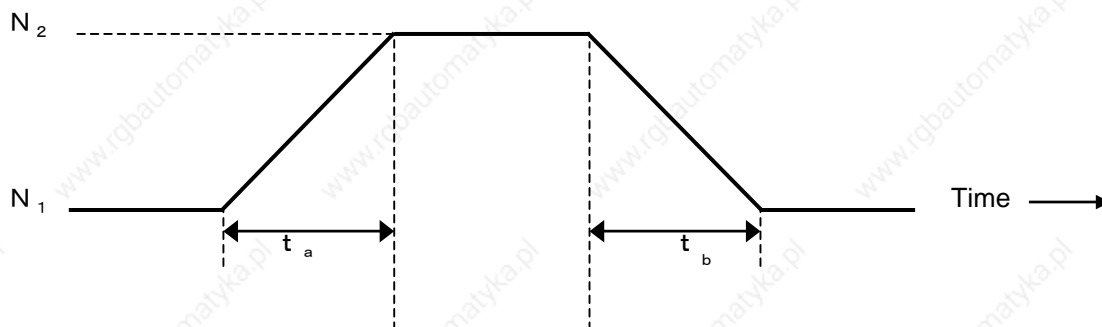

 When determining t_a and t_b , it is recommended to do so by calculating the load margin and decreasing the instantaneous maximum instant stall torque value (TP) to 80%.

■ Permitted repetitions

- There are separate limitations on repetitive operations for both the servo motor and servo amplifier, and the conditions of both must be fulfilled simultaneously.

Permitted repetitions for the servo amplifier

When START / STOP sequences are repeated frequently, confirm in advance that they are within the allowed range. Allowed repetitions differ depending on the type, capacity, load inertia, adjustable-speed current value and motor rotation speed of the motor in use. If the load inertia = motor inertia × m times, and when the permitted START / STOP repetitions (up until the maximum rotation speed) exceed $\frac{20}{m+1}$ times/min, contact your dealer or sales office for assistance, as precise calculation of effective torque and regenerating power is critical.

Permitted repetitions for the motor

Permitted START / STOP repetitions differ according to the motor's usage conditions, such as the load condition and time of operation.

■ When continuous-speed status and motor stop status is repeated

- In operating conditions such as those shown below, the effective value of the armature current of the motor is at a frequency below the rated armature current of the motor.

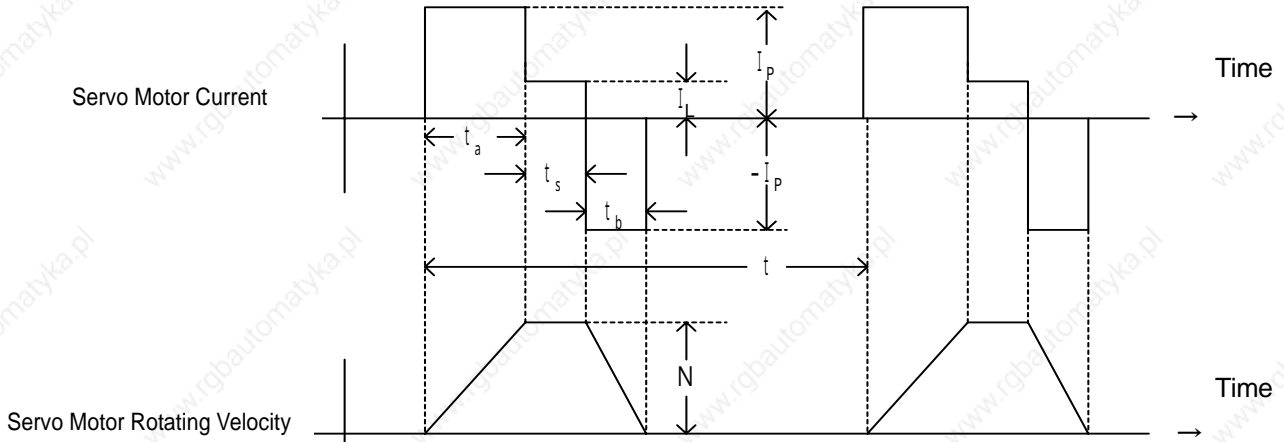

If the operating cycle is considered as 't', the usable range can be determined as follows:

$$t \geq \frac{I_P^2 (t_a + t_b) + I_L^2 t_s}{I_R^2} \text{ [s]}$$

I_P : Instantaneous maximum stall armature current
 I_R : Rated armature current
 I_L : Current corresponding to load torque

When cycle time (t) is predetermined, I_p , t_a , t_b appropriate in the above formula are required.



When actually determining the system drive mode, it is recommended to calculate the load margin and suppress it to $T_{rms} \leq 0.7TR$

■ When the motor repeats acceleration, deceleration, and stop status

- For the operating status shown below, the value of permitted repetitions n (times/min) is displayed by following equation.

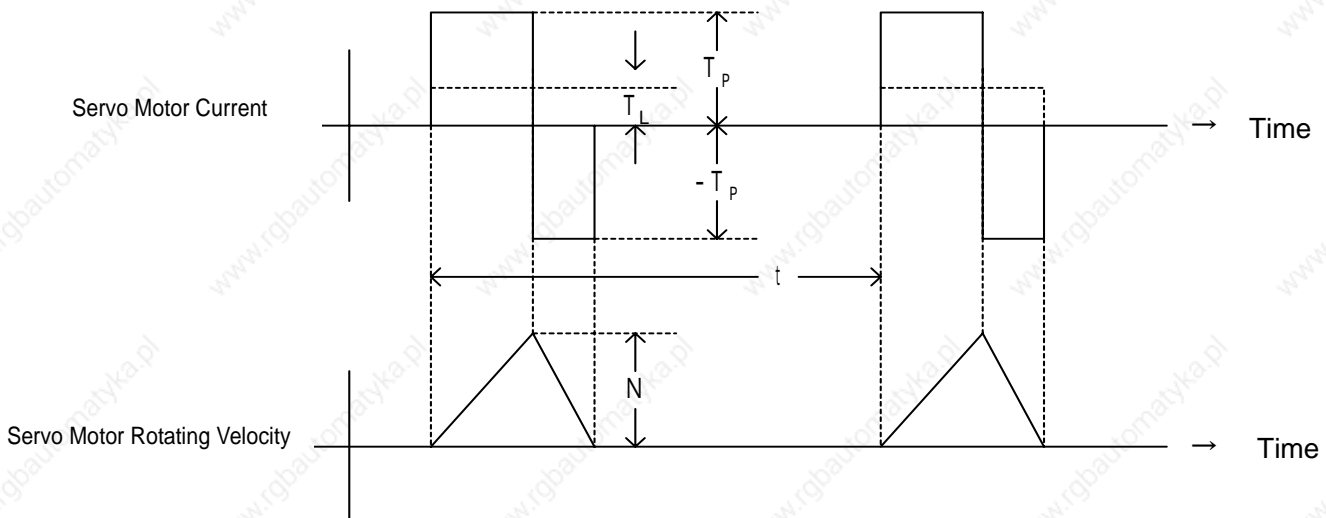

$$n = 2.86 \times 10^2 \times \frac{1}{N (J_M + J_L)} \times \frac{T_P^2 - T_L^2}{T_P^3} \times T_R^2 \text{ [times/min]}$$

T_R : Rated torque

Materials Selection Details [Permitted Repetition/Loading Precaution]

■ When the motor repeats acceleration, constant speed operation, and deceleration status

- For the operating status shown below, the value of permitted repetitions 'n' (times/min) is displayed by following equation.

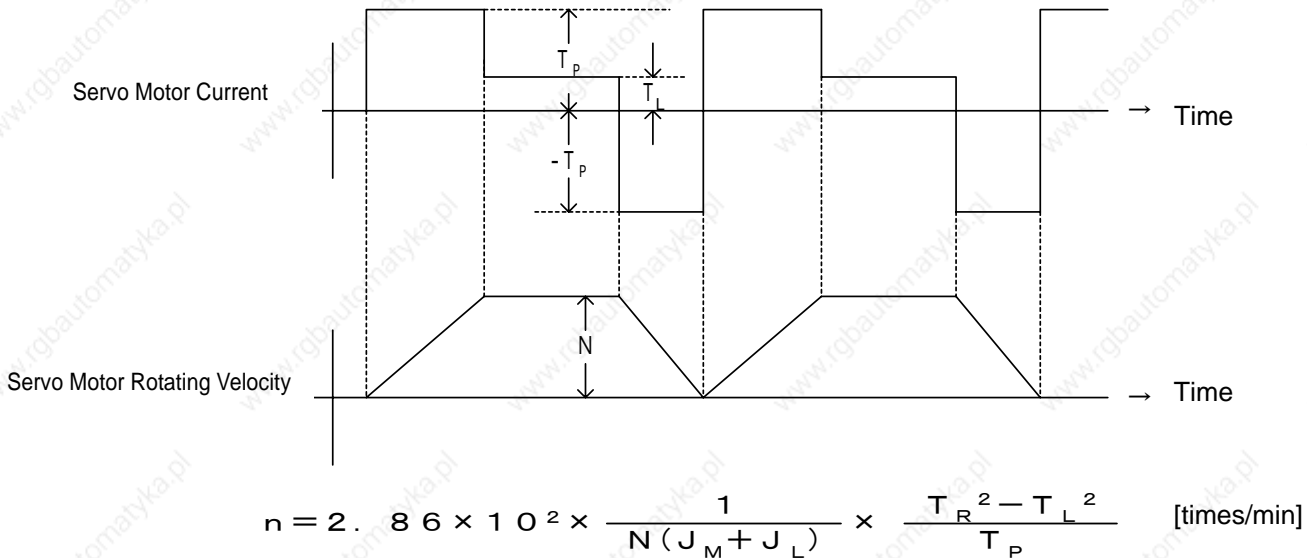

■ Loading Precautions

● Negative load

The servo amplifier cannot perform continuous operations by negative load from the servo motor for more than several seconds.

When using the amplifier with a negative load, contact your dealer or sales representative.

- Downward motor drive (when there is no counter weight.)
- When using like a generator, such as the wind-out spindle of a winder.

● Load Inertia (J_L)

When the servo amplifier is used with a load inertia exceeding the allowable load inertia calculated in terms of the motor shaft, a main circuit power overvoltage detection or regenerative error function may be issued at the time of deceleration.

The following measures must be taken in this case. For more details, please consult with your dealer or sales representative.

- Reduce the torque limit
- Extend the acceleration and deceleration time (Slow down)
- Reduce the maximum motor speed
- Install an external regenerative resistor

■ When the servo motor repeats acceleration, constant speed operation, and deceleration status

● Coasting revolution angle negative load by dynamic brake

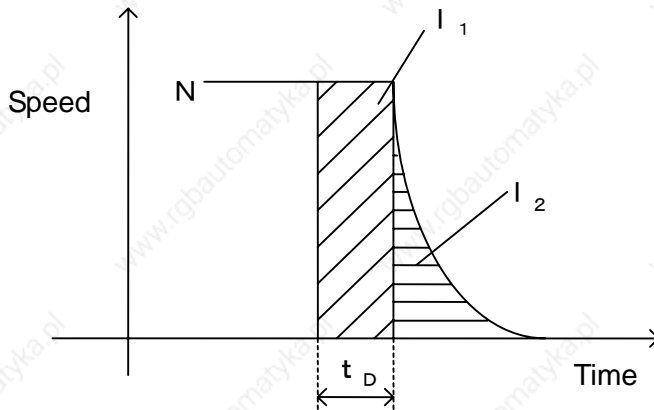

N: Motor speed (min^{-1})

I_1 : Slow-down revolution angle (rad) by amplifier internal process time t_D .

I_2 : Slow-down revolution angle (rad) by on dynamic brake operation

t_D : Delay time from signal display to operation start (s)
(Depending on amplifier capacity; Refer to following)

Servo Amplifier Model Name	Delay Time t_D (S)
RS 1 □ 0 1 □ = L / A / N / E	1.0×10^{-3}
RS 1 □ 0 3 □ = L / A / N / E	1.0×10^{-3}
RS 1 □ 0 5 □ = A / L	1.0×10^{-3}
RS 1 □ 1 0 □ = A / L	2.4×10^{-3}
RS 1 □ 1 5 □ = A / L	2.4×10^{-3}
RS 1 A 3 0	4.2×10^{-3}

[Standard formula] When load torque (T_L) is considered as zero.

$$I = I_1 + I_2$$

$$= \frac{2 \pi N \cdot t_D}{60} + (J_M + J_L) \times (\alpha N + \beta N^3)$$

I: Integrated slow-down rotation angle (rad)

J_M : Motor inertia ($\text{kg} \cdot \text{m}^2$)

J_L : Load inertia (Motor axis conversion) ($\text{kg} \cdot \text{m}^2$)

$\alpha \cdot \beta$: Refer to the constant table of the dynamic brake

■ Instantaneous tolerance of dynamic brake

- If the load inertia (J_L) substantially exceeds the applicable load inertia, abnormal heat can be generated due to dynamic brake resistance. Take precautions against situations such as an overheat alarm or the failure of dynamic break resistance, and consult your dealer or sales representative if such a situation occurs.

The energy (E_{RD}) consumed by dynamic brake resistance in 1 dynamic brake operation is as follows:

$$E_{RD} = \frac{2.5}{R\phi + 2.5} \times \left\{ \frac{1}{2} (J_M + J_L) \times \left(\frac{2\pi}{60} N \right)^2 - I \times T_L \right\}$$

$R\phi$: Motor phase winding resistance (Ω)

J_M : Motor inertia ($\text{kg}\cdot\text{m}^2$)

J_L : Load inertia (Motor shaft conversion) ($\text{kg}\cdot\text{m}^2$)

N : Number of motor rotations (min^{-1}) in feed rate V

I : Integrated slow-down rotating angle (rad)

T_L : Load torque (N/m)

-  Dynamic brake resistance may fail if the energy E_{RD} consumed by dynamic brake resistance during dynamic brake operation exceeds the energy shown in the following table. Consult with the dealer or sales representative if such a situation is anticipated.

Amplifier Model Name	E_{RD} (J)
RS1□01 □=L/A/N/E	360
RS1□03 □=L/A/N/E	360
RS1□05 □=A/L	1800
RS1□10 □=A/L	2450
RS1□15 □=A/L	2450
RS1A30	9384

■ Allowable frequency of dynamic brake

- The allowable frequency (main circuit power ON/OFF) of the dynamic brake is less than 10 rotations per hour and 50 rotations per day under the conditions of maximum speed. However the load inertia is within the applicable one.

-  In basic terms, operation of the dynamic brake in six-minute intervals between two operations is permissible at maximum speed, but if the brake is to be operated with greater frequency, the motor speed must be reduced.

Use the following ratio to determine allowable frequency:

$$\frac{6 \text{ min}}{(\text{Number of rated rotations} / \text{maximum number of rotations for usage})^2}$$

Materials Selection Details

[Regeneration Process]

■ Dynamic brake constant table.

Amplifier capacity	Motor model number	α	β	$J_M(\text{kg}\cdot\text{m}^2)$
RS1A01 RS1L01	Q1AA04003D	204	92.0×10^{-7}	0.01×10^{-4}
	Q1AA04005D	130	34.3×10^{-7}	0.0134×10^{-4}
	Q1AA04010D	53	35.0×10^{-7}	0.0233×10^{-4}
	Q1AA06020D	87.8	25.6×10^{-7}	0.057×10^{-4}
	Q2AA04006D	87.8	25.6×10^{-7}	0.057×10^{-4}
	Q2AA04010D	55.2	8.4×10^{-7}	0.086×10^{-4}
	Q2AA05005D	132	10.7×10^{-7}	0.067×10^{-4}
	Q2AA05010D	45.2	7.93×10^{-7}	0.13×10^{-4}
	Q2AA05020D	19.0	46.9×10^{-7}	0.25×10^{-4}
	Q2AA07020D	25.9	11.7×10^{-7}	0.382×10^{-4}
RS1A03 RA1L03	Q2AA07030D	11.0	13.9×10^{-7}	0.45×10^{-4}
	Q1AA06040D	9.13	13.1×10^{-7}	0.247×10^{-4}
	Q1AA07050D	5.24	7.75×10^{-7}	0.636×10^{-4}
	Q2AA07040D	10.2	7.08×10^{-7}	0.75×10^{-4}
	Q2AA07050D	10.6	3.84×10^{-7}	0.85×10^{-4}
RS1A05 RS1L05	Q2AA08050D	7.71	4.51×10^{-7}	1.30×10^{-4}
	Q2AA13050H	5.34	6.99×10^{-7}	2.80×10^{-4}
	Q1AA10100D	6.50	6.89×10^{-7}	1.04×10^{-4}
	Q1AA10150D	3.95	3.60×10^{-7}	1.61×10^{-4}
	Q2AA08075D	9.23	1.71×10^{-7}	2.07×10^{-4}
	Q2AA08100D	5.30	1.62×10^{-7}	2.73×10^{-4}
	Q2AA10100H	2.78	1.50×10^{-7}	5.44×10^{-4}
RS1A10 RS1L10	Q2AA10150H	2.03	0.92×10^{-7}	7.99×10^{-4}
	Q2AA13100H	2.81	3.35×10^{-7}	5.40×10^{-4}
	Q2AA13150H	1.79	2.33×10^{-7}	7.94×10^{-4}
	Q1AA10200D	4.19	0.47×10^{-7}	2.15×10^{-4}
	Q1AA10250D	2.70	0.46×10^{-7}	2.65×10^{-4}
	Q1AA12200D	2.85	0.33×10^{-7}	4.37×10^{-4}
	Q1AA12300D	1.53	0.27×10^{-7}	6.40×10^{-4}
RS1A15 RS1L15	Q1AA13300D	1.78	0.53×10^{-7}	4.92×10^{-4}
	Q2AA13200H	1.23	0.48×10^{-7}	11.76×10^{-4}
	Q2AA18200H	1.49	0.36×10^{-7}	19.95×10^{-4}
	Q2AA22250H	1.83	0.24×10^{-7}	32.20×10^{-4}
	Q1AA13400D	2.13	0.25×10^{-7}	6.43×10^{-4}
	Q1AA13500D	1.52	0.20×10^{-7}	8.47×10^{-4}
	Q1AA18450M	0.43	0.35×10^{-7}	27.5×10^{-4}
RS1A30	Q2AA18350H	1.14	0.09×10^{-7}	37.89×10^{-4}
	Q2AA18450H	0.74	0.09×10^{-7}	54.95×10^{-4}
	Q2AA18550R	0.52	0.05×10^{-7}	72.65×10^{-4}
	Q2AA22350H	1.13	0.17×10^{-7}	47.33×10^{-4}
	Q2AA22450R	0.76	0.12×10^{-7}	67.45×10^{-4}
	Q2AA22550B	0.46	0.11×10^{-7}	95.3×10^{-4}
	Q2AA22700S	0.18	0.10×10^{-7}	163×10^{-4}
RS1A30	Q1AA18750H	0.96	4.77×10^{-9}	52×10^{-4}
	Q2AA18550H	1.15	2.29×10^{-9}	73×10^{-4}
	Q2AA18750L	0.725	2.30×10^{-9}	95×10^{-4}
	Q2AA2211KV	0.475	2.47×10^{-9}	186×10^{-4}
	Q2AA2215KV	0.335	1.96×10^{-9}	255×10^{-4}

Amplifier capacity	Motor model number	α	β	$J_M(\text{kg}\cdot\text{m}^2)$
RS1E01 RS1N01	Q1EA04003D	276	68.1×10^{-7}	0.01×10^{-4}
	Q1EA04005D	205	39.7×10^{-7}	0.0134×10^{-4}
	Q1EA04010D	82.3	26.1×10^{-7}	0.0233×10^{-4}
	Q2EA04006D	129	7.40×10^{-7}	0.057×10^{-4}
	Q2EA04010D	72.5	4.91×10^{-7}	0.086×10^{-4}
	Q2EA05005D	212	3.48×10^{-7}	0.067×10^{-4}
	Q2EA05010D	71.6	2.55×10^{-7}	0.13×10^{-4}
RS1E03 RS1N03	Q1EA06020D	56.3	9.57×10^{-7}	0.141×10^{-4}
	Q2EA05020D	46.4	0.99×10^{-7}	0.25×10^{-4}
	Q2EA07020D	57.0	5.22×10^{-7}	0.382×10^{-4}



The values for α and β are based on an assumed resistance value of the power line of 0Ω .
If the combination with an amplifier is different than those shown above, consult your dealer or sales office.

■ Regeneration Process

● The regeneration capacity of the servo amplifier depends on the allowable power of the regenerative resistor. When using the servo amplifier with built-in regeneration resistor, be sure to calculate regeneration resistance **PM** and confirm that $PM < PRI$ (the allowable power for the built-in regeneration resistor) is fulfilled.

When regeneration power **PM** exceeds the permitted power (**PRI**) of the built-in regeneration resistor, you can operate by conducting regeneration resistance (PM) calculation, confirming that $PM < PRO$ (the maximum allowable power of the exterior regeneration resistor) is fulfilled, and connecting the optional external regeneration resistor

	Built-in regeneration resistor is available [PM]	Regeneration resistor connecting number	External regeneration resistor is available [PM]	Regeneration resistor connecting number	Contact us in case below
RS 1 □ 0 1	PM = 2 W and below	I	PM = 2 2 0 W and below	Refer to "Materials" page 11	PM = 2 2 0 W and up
RS 1 □ 0 3	PM = 5 W and below	I	PM = 2 2 0 W and below		PM = 2 2 0 W and up
RS 1 □ 0 5	PM = 2 0 W and below	I	PM = 5 0 0 W and below		PM = 5 0 0 W and up
RS 1 □ 1 0	PM = 9 0 W and below	II	PM = 5 0 0 W and below		PM = 5 0 0 W and up
RS 1 □ 1 5	PM = 1 2 0 W and below	II	PM = 5 0 0 W and below		PM = 5 0 0 W and up
RS 1 □ 3 0	—	—	PM = 5 0 0 W and below		PM = 5 0 0 W and up

 If using the built-in regeneration resistor, please specify the model number of the **servo amplifier with built-in regeneration resistor** in reference to "Section 1: Prior to Use – Servo Amplifier Model Number"

If using the exterior regeneration resistor, please specify the model number of the **servo amplifier without built-in regeneration resistor**.

 When regeneration power **PM** exceeds the maximum permitted power (**PRO**) of the external regeneration resistor, reconsider the acceleration constant, load inertia, etc.

● Resistance Value of Servo Amplifier Built-in Regeneration Resistor

Model Number of Servo Amplifier with Built-in Regeneration Resistor	Resistance Value of Built-in Regeneration Resistor
RS 1 □ 0 1 □ = L / M / N / P	1 0 0 Ω
RS 1 □ 0 3 □ = L / M / N / P	5 0 Ω
RS 1 □ 0 5 □ = A / B	1 7 Ω
RS 1 A 1 0 □ = A / B	1 0 Ω
RS 1 A 1 5 □ = A / B	6 Ω

Materials Selection Details

[Calculation Method of Regeneration Power by Operations along Horizontal Axis]

■ Regeneration Power (PM) by Operations along Horizontal Axis

- Regeneration energy is calculated.

$$EM = EHB = \frac{1}{2} \times N \times 3 \cdot KE \times \frac{Tb}{KT} \times tb - \left(\frac{Tb}{KT} \right)^2 \times 3 \cdot R \times tb$$

EM	:	Regeneration energy during operations along horizontal axis[J]
EHB	:	Regeneration energy during deceleration[J]
KE φ	:	Induced voltage constant[Vrms/min ⁻¹] (Motor constant)
KT	:	Torque constant[N·m/Arms] (Motor constant)
N	:	Motor rotation speed[min ⁻¹]
R φ	:	Armature resistance[Ω] (Motor constant)
Tb	:	Deceleration time[s]
Tb	:	Torque during deceleration[N·m] (Tb= Tc - TF)
Tc	:	Adjustable speed torque[N·m]
TF	:	Friction torque[N·m]

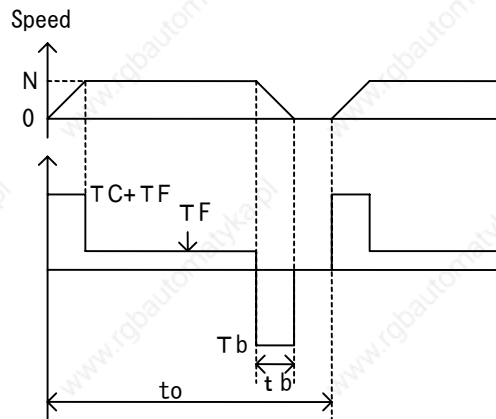

- Effective regeneration power is calculated.

$$PM = \frac{EM}{t_o}$$

PM	:	Effective regeneration power [W]
EM	:	Regeneration energy during deceleration [J]
To	:	Cycle time [s]

Materials Selection Details [Calculation Method of Regeneration Power by Operations along Vertical Axis]

■ Regeneration Power (PM) by Operations along Vertical Axis (With a Gravitational Load)

- Regenerative energy is calculated.

$$E_M = E_{VUb} + E_{VD} + E_{VDb}$$

$$= \frac{1}{2} N \times 3 \cdot K E \phi \times \frac{T_{Ub}}{K T} \times t_{Ub} - \left(\frac{T_{Ub}}{K T} \right)^2 \times 3 \cdot R \phi \times t_{Ub}$$

$$+ N \times 3 \cdot K E \phi \times \frac{T_D}{K T} \times t_D - \left(\frac{T_D}{K T} \right)^2 \times 3 \cdot R \phi \times t_D$$

$$+ \frac{1}{2} N \times 3 \cdot K E \phi \times \frac{T_{Db}}{K T} \times t_{Db} - \left(\frac{T_{Db}}{K T} \right)^2 \times 3 \cdot R \phi \times t_{Db}$$

E_M	:	Regeneration energy during operations along vertical axis[J]
E_{VUb}	:	Regeneration energy during increased deceleration[J]
E_{VD}	:	Regeneration energy during descending run[J]
E_{VDb}	:	Regeneration energy during decreased deceleration[J]
T_{Ub}	:	Torque during increased deceleration[N·m]
t_{Ub}	:	Increased deceleration time[s]
T_D	:	Torque during descending run[N·m] ($T_D = T_M - T_F$)
t_D	:	Descending run time[s]
T_{Db}	:	Torque during decreased deceleration[N·m] ($T_{Db} = T_C - T_F + T_M$)
t_{Db}	:	Decreased deceleration time[s]
T_M	:	Gravitational load torque[N·m]

📎 When the calculation result of either of **E_{VUb}** , **E_{VD}** , or **E_{VDb}** is negative, calculate **E_M** by considering the value of those variables as 0.

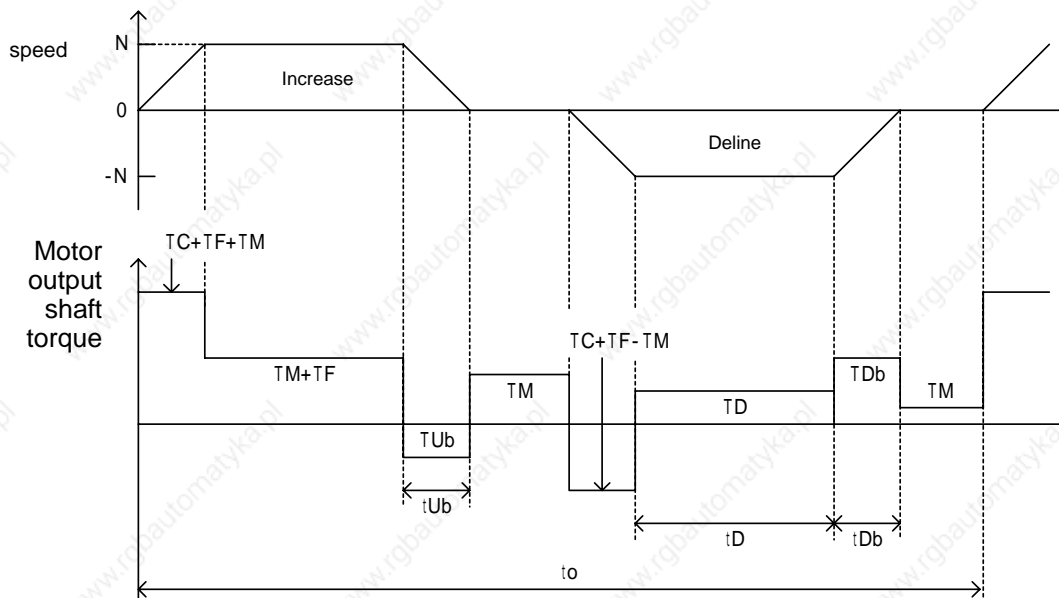

- Effective regeneration power is calculated.

$$P_M = \frac{E_M}{t_0}$$

P_M	:	Effective regeneration power [W]
E_M	:	Regeneration energy during increased deceleration/ descending / decreased deceleration [J]
t_0	:	Cycle time [s]

Materials Selection Details

Method of Regeneration Power

[Confirmation

Confirmation method of regeneration power PM in actual operation

- Regeneration power **PM** can be easily confirmed in the digital operator or by Q-SETUP setup software.

Digital operator ··· Monitor mode Page 12 · Regeneration circuit operating rate

Setup software ··· Monitor display Page 12 · R e g P · Regeneration circuit operating rate



The monitor value of the regeneration circuit operating rate shows the operating rate of regeneration circuit. The display range is 0.01%~99.99%.

- The actual regeneration power **PM** can be calculated from this monitor value by following equation.

Input Supply Voltage : In case of A C 2 0 0 V specification

$$\text{Regeneration power PM (W)} = \frac{400 \text{ (V)} \times 400 \text{ (V)}}{\text{Regeneration resistance } (\Omega)} \times \frac{\text{regeneration circuit operating rate } (\%)}{100 \text{ } (\%)}$$

Input Supply Voltage : In case of A C 1 0 0 V specification

$$\text{Regeneration power PM (W)} = \frac{200 \text{ (V)} \times 200 \text{ (V)}}{\text{Regeneration resistance } (\Omega)} \times \frac{\text{regeneration circuit operating rate } (\%)}{100 \text{ } (\%)}$$

- Calculation Example

Servo Amplifier Model Number : RS 1 L 0 1 A A *

[With built-in regeneration resistance/Input Supply Voltage : A C 2 0 0 V Specification]

Regeneration resistance value : 1 0 0 Ω [Built-in Regeneration Resistance]

Monitor Value : 0 . 1 2 % [R e g P]

$$\text{Regeneration power PM (W)} = \frac{400 \text{ (V)} \times 400 \text{ (V)}}{100 \text{ } (\Omega)} \times \frac{0.12 \text{ } (\%)}{100 \text{ } (\%)} = 1.92 \text{ (W)}$$



The regeneration power calculated from this monitor value continues to be the target until the end of operations. Regeneration power varies with the voltage fluctuation of the input power supply and changes across the ages of the servo amplifier and the loading device.



Select regeneration resistance by calculating regeneration power **PM** from the operation pattern, as per the **calculation method of regeneration power PM**.

Materials Selection Details

[External Regenerative Resistor]

■ Selection of Optional External Regenerative Resistor

- You can select the combination of external regenerative resistors based on effective regenerative power [PM] sought by the regeneration calculation.

Amplifier Model Number	[PM]	Up to 10W	Up to 30W	Up to 55W	Up to 60W	Up to 110W	Below 220W	220W and over
RS1□01	Resistor Sign	A × 1	C × 1	E × 1	D × 2	F × 2	E × 4	Contact
	Connection Number	III	III	III	IV	IV	VI	
RS1□03	Resistor Sign	B × 1	D × 1	F × 1	C × 2	E × 2	F × 4	Contact
	Connection Number	III	III	III	V	V	VI	

Amplifier Model Number	[PM]	Up to 55W	Up to 125W	Up to 250W	Below 500W	500W and over
RS1□05	Resistor Sign	G × 1	H × 1	I × 2	H × 4	Contact
	Connection Number	III	III	IV	VI	

Amplifier Model Number	[PM]	Up to 125W	Up to 250W	Below 500W	500W and over
RS1□10	Resistor Sign	I × 1	H × 2	I × 4	Contact
	Connection Number	III	V	VI	

Amplifier Model Number	[PM]	Up to 125W	Up to 250W	Below 500W	500W and over
RS1□15	Resistor Sign	J × 1	K × 2	J × 4	Contact
	Connection Number	III	V	VI	

Amplifier Model Number	[PM]	Up to 250W	Below 500W	500W and over
RS1□30	Resistor Sign	L × 1	L × 2	Contact
	Connection Number	III	V	

 The above resistor sign of a combination of an external regenerative resistor correspond to the following table.

Please select a resistor model name corresponding to a resistor sign.

 The above connection number of a combination of an external regenerative resistor is on the next page.

Please connect based on the connection number.

Resistor Sign	Resistor Model Number	Resistance Value	Thermostat	Permissible Effective Power	Outline Drawing
A	REGIST-080W100	100 Ω	b Contact	10W	Refer to 'Materials 1 5'
B	REGIST-080W50B	50 Ω		10W	
C	REGIST-120W100	100 Ω		30W	
D	REGIST-120W50B	50 Ω		30W	
E	REGIST-220W100	100 Ω		55W	
F	REGIST-220W50B	50 Ω		55W	
G	REGIST-220W20B	20 Ω		55W	
H	REGIST-500W20B	20 Ω		125W	
I	REGIST-500W10B	10 Ω		125W	
J	REGIST-500W7B	7 Ω		125W	
K	REGIST-500W14B	14 Ω		125W	
L	REGIST-1000W6R	6.7 Ω		250W	

Materials Selection Details

[External Regenerative Resistor]

■ Connection of Regenerative Resistance

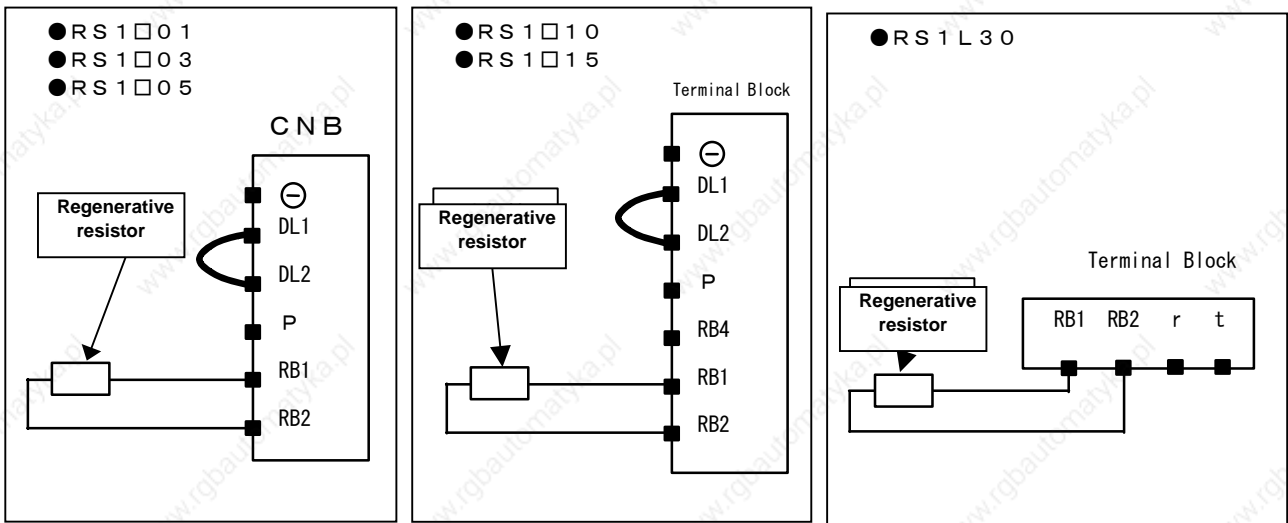

Please make sure to install the external regenerative resistor with twisted wires and use as a short wire which is up to 5 meters long as possible.



Use nonflammable electric wire or perform non-combustible processing (silicon tube, etc.) for connecting cable and wired, and install wiring so as to not come in contact with the built-in unit.



Please make sure to change the set-up of "System Parameter" and "Regenerative Resistance Selection" in line with the kind of regenerative resistor you connect.

■ Connection of the Thermostat of a Regenerative Resistor

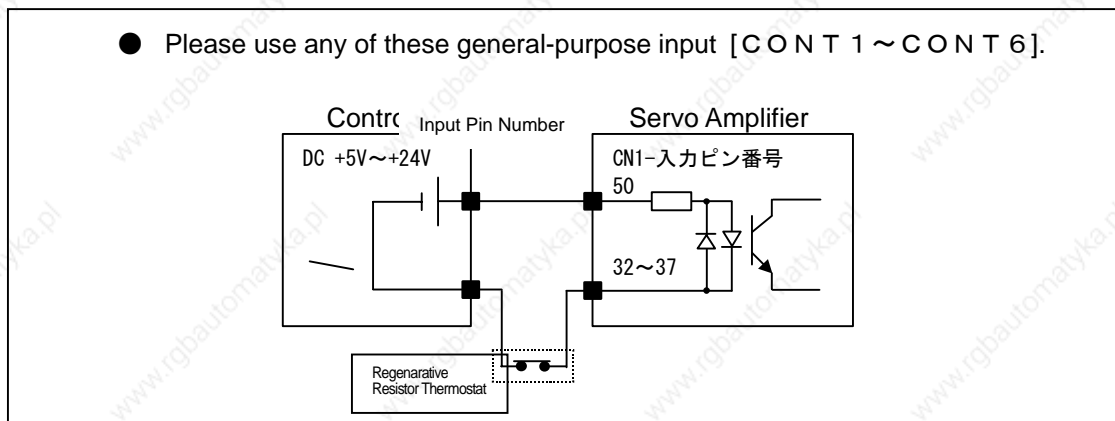

Please allocate the connected general-purpose input (any of [CONT 1 ~ CONT 6]) to [Group9 40 External Trip Input Function of General Parameter].

Parameter Set-up Example : When connecting the thermostat to CONT 6

The external trip function will be valid when [O D H : CONT 6 _ O F F] CONT6 is turned off in [Grop6 40 External Trip Input Function]

Alarm (ALM-55) will be output from the servo amplifier when the thermostat of a generative resistor trips (the contact point comes off) because of heating.

Materials Selection Details

[External Regenerative Resistor]

■ Connection Number of External Regenerative Resistor combinator

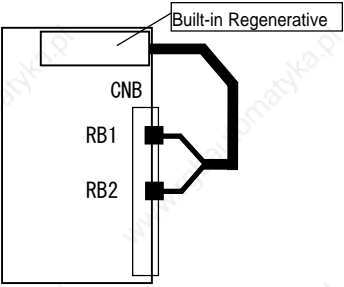
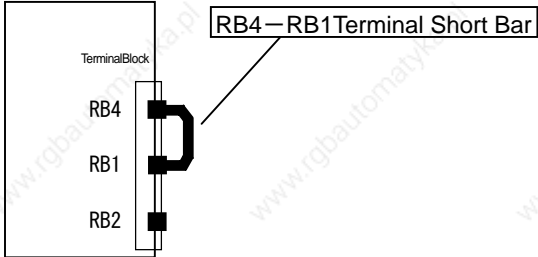
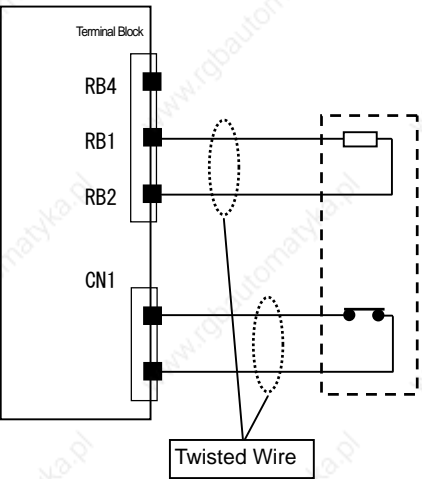
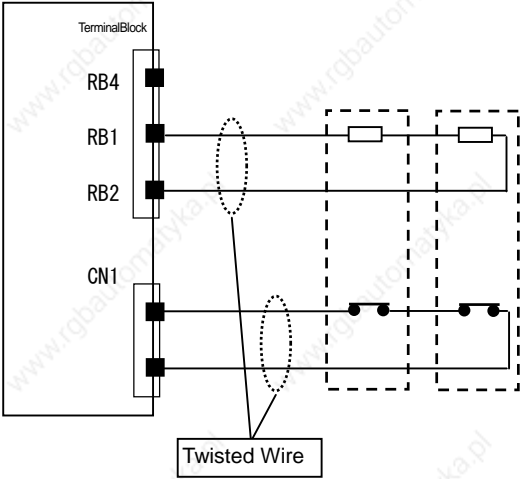
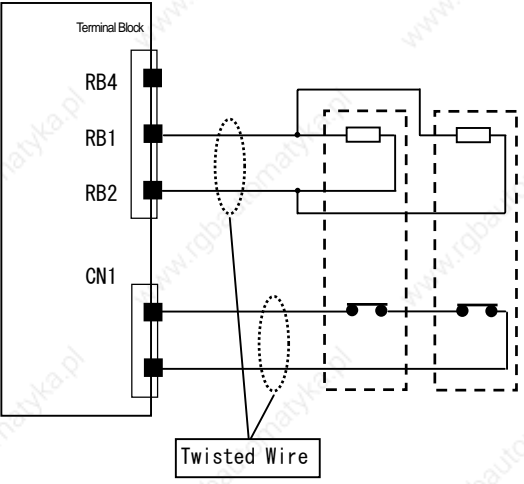
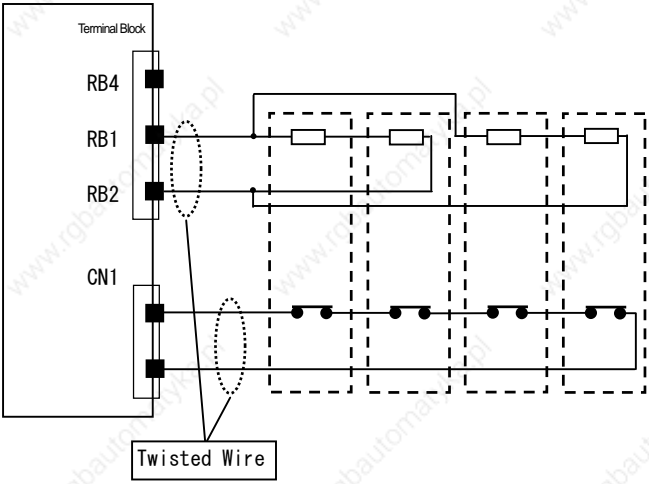
<p>Connection I</p>  <p>Built-in Regenerative</p> <p>CNB</p> <p>RB1</p> <p>RB2</p>	<p>Connection II</p>  <p>TerminalBlock</p> <p>RB4</p> <p>RB1</p> <p>RB2</p> <p>RB4—RB1 Terminal Short Bar</p>
<p>Connection III</p>  <p>Terminal Block</p> <p>RB4</p> <p>RB1</p> <p>RB2</p> <p>CN1</p> <p>Twisted Wire</p>	<p>Connection IV [× 2] Series Connection</p>  <p>TerminalBlock</p> <p>RB4</p> <p>RB1</p> <p>RB2</p> <p>CN1</p> <p>Twisted Wire</p>
<p>Connection V [× 2] Parallel Connection</p>  <p>Terminal Block</p> <p>RB4</p> <p>RB1</p> <p>RB2</p> <p>CN1</p> <p>Twisted Wire</p>	<p>Connection VI [× 4] Series/Parallel Connection</p>  <p>Terminal Block</p> <p>RB4</p> <p>RB1</p> <p>RB2</p> <p>CN1</p> <p>Twisted Wire</p>

Materials Selection Details

[External Regenerative Resistor]

■ Protection Function of Regenerative Resistance

With the R series servo amplifier, the regenerative resistance protection function is specified by parameter selections. Appropriate protection for regenerative resistance is applied by setting parameters according to the type of regenerative resistance to be connected. Set the appropriate parameters by following the instructions given below.

● The protection functions are divided into three main types:

- ① Protection for a short-time, high load factor (using built-in or external regenerative resistance): An error is detected when the power absorption of regenerative resistance is extremely high over a short time period (100msec to 10 seconds). A 'Regenerative Error' alarm ("ALM_43") is issued when this error is detected.
- ② Protection when allowable power absorption is exceeded for long time (using built-in regenerative resistance): An error is detected when the power absorption of the built-in regenerative resistance exceeds the allowable power absorption over a long time period (from a few seconds to a few minutes). An 'Internal Overheat' alarm ("ALM_54") is issued when this error is detected.
- ③ Protection during thermostat operation of the external regenerative resistor: An error is detected when the external trip function is started. An 'External error / external trip' alarm ("ALM_55") is issued when this error is detected.

● The two parameters requiring settings are given below.

①	Regenerative resistance selection	Regenerative resistance built-in type [0 B]
②	External trip input function	General parameter [Group 9 4 0]

● Relationship between parameter settings and protection functions

Regenerative resistance in use		Parameter setting		Protection function operation		
Resistor	Thermostat	Regenerative resistance selection	External trip input function	Regenerative error [ALM_43]	Internal overheat [ALM_54]	External Alarm External Trip [ALM_55]
Not Connecting	—	00:_Not_Connect	—	Invalid	Invalid	—
Built-in Regenerative Resistance	—	01:_Built-in_R	—	Valid	Valid	—
External Regenerative Resistance	—	02:_External_R	—	Valid	Invalid	—
External Regenerative Resistance	Connect to servo amplifier	02:_External_R	Setting	Valid	Invalid	Valid



Make appropriate settings to regenerative resistance [System parameter/Page0B] when using built-in regenerative resistance.



If these parameter settings are incorrect, normally detected errors related to built-in regenerative resistance may not be detected, possibly causing the burning/fuming of regenerative resistance.



The built-in regenerative resistance may generate heat even if the overheat alarm is not issued. Do not touch the servo amplifier for 30 minutes after power is disconnected in the case of a power failure, as there is a risk of burn.



Incorrect parameter settings may cause irregular operation of the protection functions. Upon an alarm, confirm its cause and adjust the settings appropriately.

Materials Selection Details

[External Regenerative Resistor Dimension]

Unit : mm

External Dimension of Regenerative Resistor

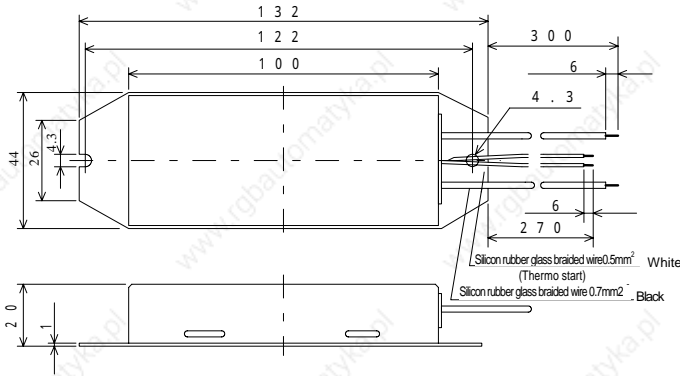

	Model number	Thermostat
1	REGIST-080W100B	Normal close contact
2	REGIST-080W50B	Normal close contact

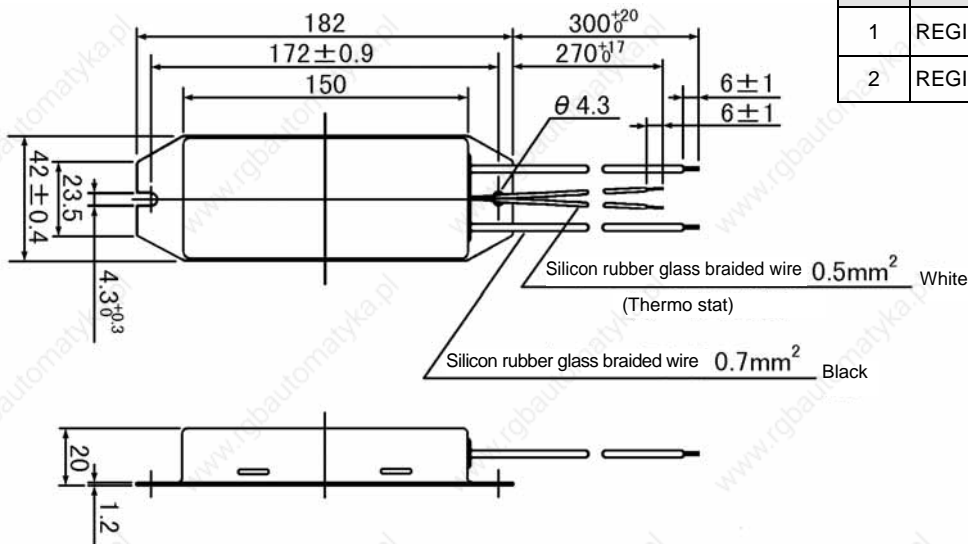

	Model number	Thermostat
1	REGIST-120W100B	Normal close contact
2	REGIST-120W50B	Normal close contact

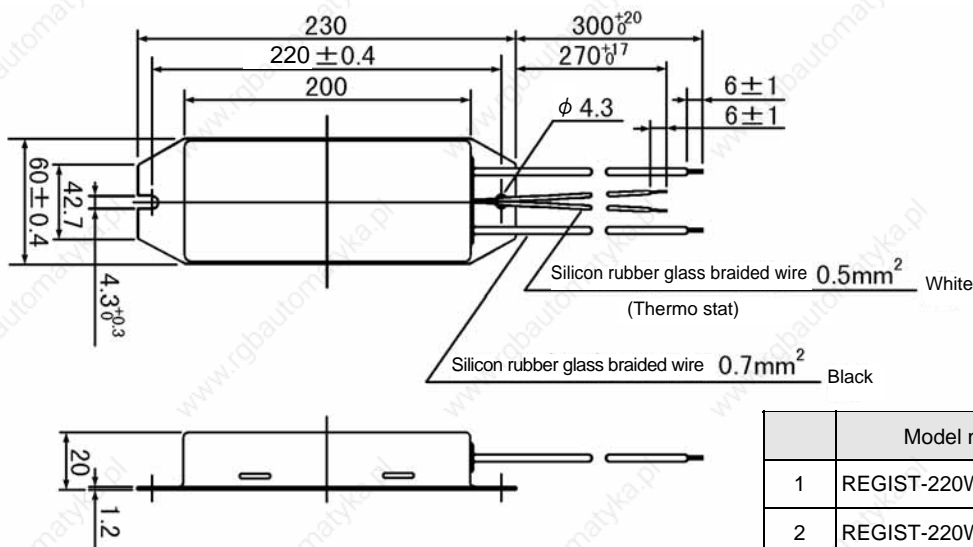

	Model number	Thermostat
1	REGIST-220W50B	Normal close contact
2	REGIST-220W20B	Normal close contact
3	REGIST-220W100B	Normal close contact

Materials Selection Details

[External Regenerative Resistor Dimension]

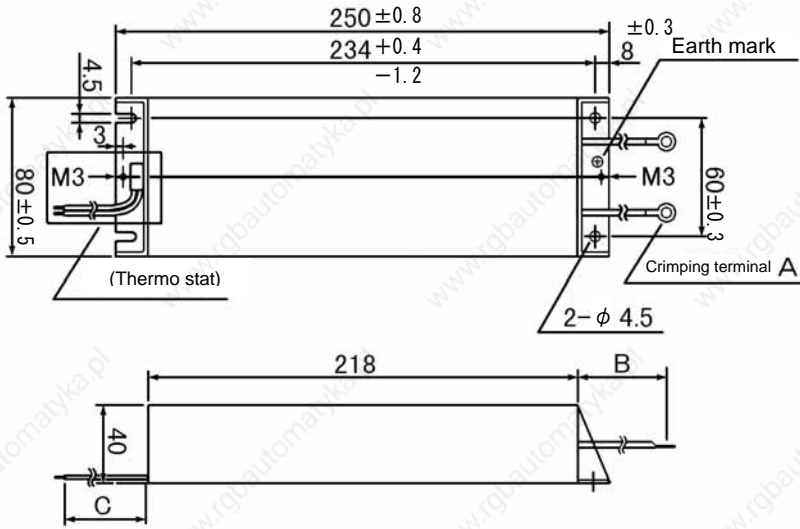

	Model number	Thermostat
1	REGIST-500W20B	Normal close contact
2	REGIST-500W20	None
3	REGIST-500W10B	Normal close contact
4	REGIST-500W10	None
5	REGIST-500W7B	Normal close contact
6	REGIST-500W7	None
7	REGIST-500W14B	Normal close contact
8	REGIST-500W14	None

Crimping terminal A=M5

B=700mm±15

C=350mm±15

Materials Selection Details

[External Regenerative Resistor Dimension]

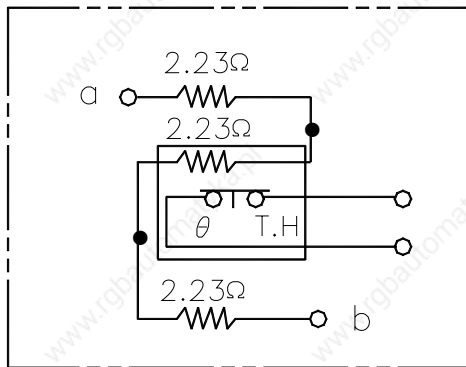
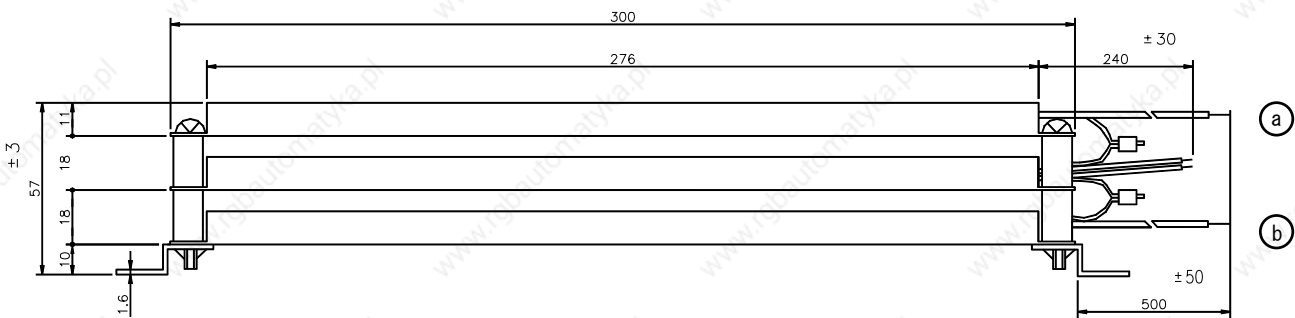
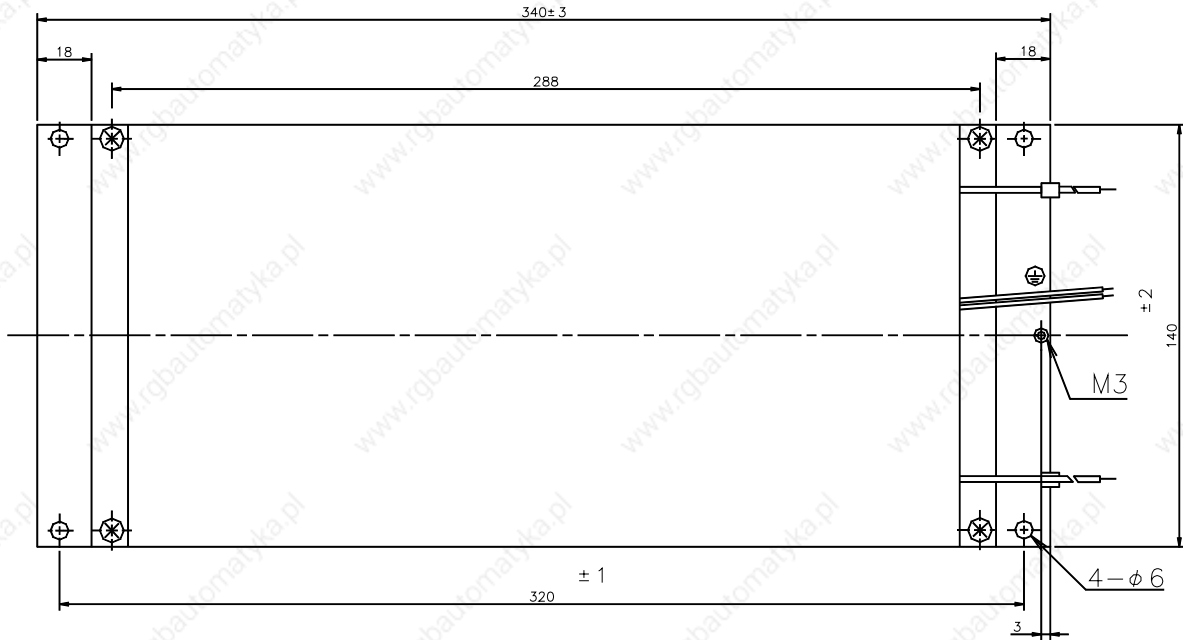

Connection Diagram

	Model number	Thermostat
1	REGIST-1000W6R7B	b Contact Point



Materials International Standards [International standards Conformity]

■ Outline of International Standards Conformity

- R S 1 servo amplifier conforms to the international standards below.

Mark	International standards	Standard number	Certification Organization
	UL standard	UL508C	UL (Underwriters Laboratories inc.)
	CSA standard	UL508C	
	EN standard	EN50178 EN61000-6-2 EN61800-3	TÜV (TÜV Product Service Japan, Ltd.)

- Q servo amplifier conforms to the international standards below.

Display	International standards	Standard number	Certification Organization
	UL standard	UL1004 UL1446	UL (Underwriters Laboratories inc.)
	EN standards	IEC-34-1 IEC34-5 IEC34-9	TÜV (TÜV Product Service Japan, Ltd.)



For products conforming to international standards, some specifications may differ from the standard product due to prerequisites necessary for obtaining approval. Contact the manufacturer for more details.

● Precautions for conformity standards

- ① Make sure to use servo amplifier and servo motor in a proper combination. Check "Section 1 : Prior to use --- Servo amplifier type number.
- ② Make sure to install the servo amplifier in your control panel in an environment where the pollution level specified in EN50178 and IEC664 is no less than 2 (pollution level 1, 2). The control panel installation configuration (under IP54) must exclude exposure to water, oil, carbon, dust, etc.

The servo amplifiers must be used under the conditions specified in overvoltage category , EN50178. For the interface, use a DC power supply with reinforced and insulated input and outputs.

Always ground the protective earth terminals of the servo amplifier to the power supply earth. ()

When connecting grounding wire to the protective earth terminal, always connect one wire in one terminal; never connect jointly with multiple wires or terminals.

When connecting the leakage stopper, make sure to connect the protective earth terminal to the power supply earth. ()

Materials International Standards [International standards Conformity]

Connect earthing wire by using a crimping terminal with insulated tube, so that the connected wire will not touch the neighboring terminals.

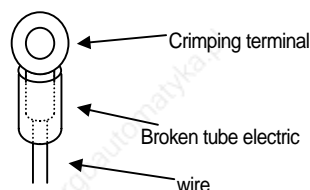

For wire relays, use a fixed terminal block to connect wires; never connect wires directly.

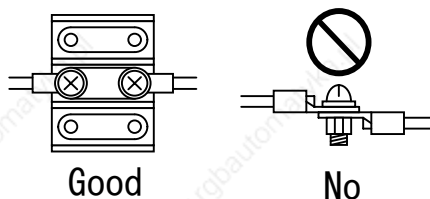

Connect an EMC filter to the input power supply of the unit.

Use an EN/ IEC-standard compatible no-fuse circuit breaker and electromagnetic contactor.

■ International standard certificate number

Classification	Category	File No.
UL / cUL : Servo amplifier	Power Conversion Equipment	E179775
UL : Servo motor	Motors-Component	E179832

Command classification	Type	File No.
Low voltage command : Servo amplifier	Attested certificate	B 05 05 30982 044
EMC command : Servo amplifier / servo motor	Attested certificate	B9 05 05 30982 045
Low voltage command : Q 1 servo motor	Attested certificate	B 04 03 30982 033
Low voltage command : Q 2 servo motor	Attested certificate	B 04 03 30982 032

The file number of UL is available at the UL homepage: <http://www.ul.com/database/>.

Please contact your dealer or sales representative if you need the above certification.

Materials International Standards [Compliance with EC Directives]

■ Compliance with EC Directives

Our company has performed the requisite low voltage and EMC testing in accordance with EC Directives related to CE marking through a separate, third-party certifying authority.

Directive classification	Classification	Test	Test standard
Low voltage Directive (Servo amplifier)	—	—	EN50178: 1997
EMC Directive (Servo amplifier / servo motor)	Emission	Conducted emission	EN55011: A1/1999
		Radiated emission	EN55011: A1/1999
	Immunity test	Electrostatic discharge immunity	EN61000-4-2: A2/2001
		Radiated electromagnetic field immunity	EN61000-4-3: A2/2001
		Electrical first transient/ burst immunity	EN61000-4-4: A2/2001
		Conducted disturbance immunity	EN61000-4-6: A1/2001
		Surge immunity	EN61000-4-5: A1/2001
		Voltage Dips & Interruptions immunity	EN61000-4-11: A1/2001
		Adjustable speed electrical power drive system	EN61800-3/1996 :A11/2000
		Low voltage Directive (Servo motor)	—
Rotating electrical machines-Part5:Classification of degrees of protection provided by enclosures of rotating electrical machines(IP code)	IEC34-5		
Rotating electrical machines-Part9: Noise limits	IEC34-9		

 For the EMC Directives, tests are performed by general installation and countermeasure methods, in our company as machines and configurations differ depending on customers' needs.

 This servo amplifier has been authorized to display CE marking based on the recognition certificate issued by a separate, third-party certifying authority. Accordingly, customers are instructed to perform the final conformity tests for all instruments and devices in use.

Materials International Standards [Compliance with EC Directives]

● Precautions for EMC Directives

Use the following guidelines below for the RS1 servo system in order to conform the customer's equipment and devices to the EMC Directives.

- ① A metallic material must be used for the door and main body of control panel.
- ② The joints of the top and side panels must be masked and welded.
- ③ Parts joined with screws must be welded to prevent noise from leaking out from joints.
- ④ When joining parts with screws or spot welding, the welding space must be within 10cm.
- ⑤ Use an EMI gasket so that there is zero clearance between the door and control panel.
- ⑥ Install EMI gasket uniformly to the contact points between door and main body of control panel.
- ⑦ Perform conductivity processing on the EMI gasket, door and main body of control panel to confirm their conductivity.
- ⑧ Ground the noise filter frame to the control panel.
- ⑨ Ground the servo amplifier chassis provided by the customer.
- ⑩ Use shield cables for the motor power line and sensor cable.
- ⑪ Ground the shield of motor power wire and sensor cable to the control panel with the clamp.
- ⑫ Ground and clamp the shield of motor power line and sensor cable to the frame of the servo amplifier.
- ⑬ Use a conducting metal P clip or U clip to ground and clamp the shield wire, and fix it directly with metal screws. Do not ground by soldering electric wire to the shield wire.

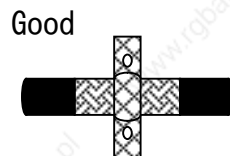

Grounding by U clip or P clip

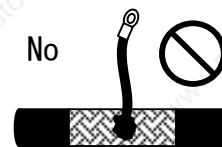

Grounding by soldering

- ⑭ Wrap the zero-phase reactor four times around the primary side of the noise filter.

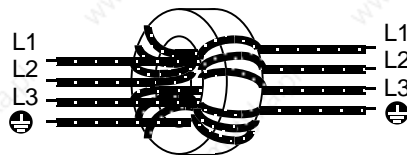

- ⑮ Wire the servo amplifier at a short distance from the secondary side of noise filter.
- ⑯ Wire the primary side and secondary side of the noise filter separately.

Materials International Standards [Compliance with EC Directives]



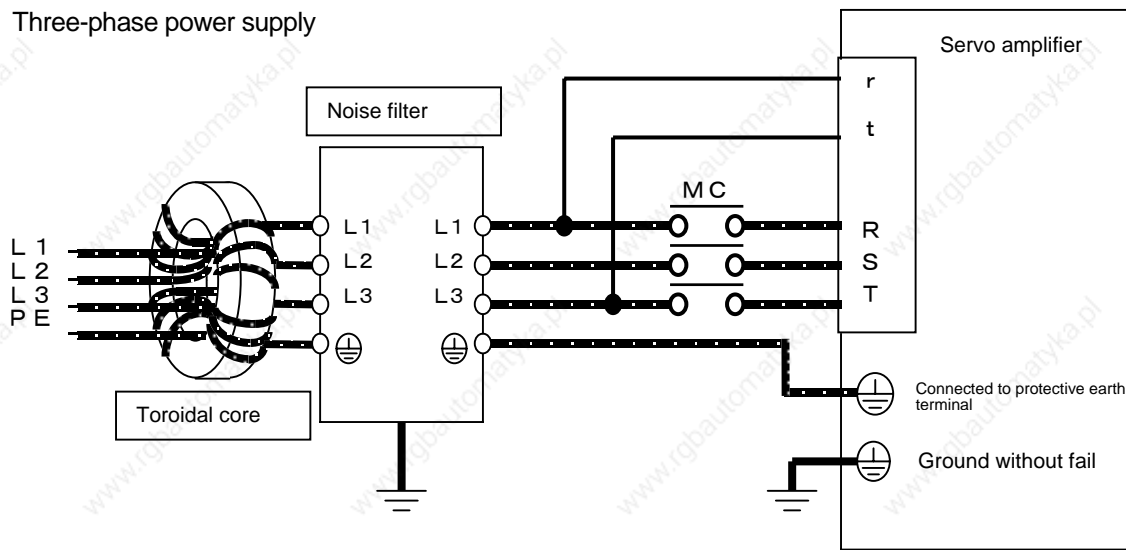

■ Installation of noise filter and servo amplifier

● Three-phase power supply

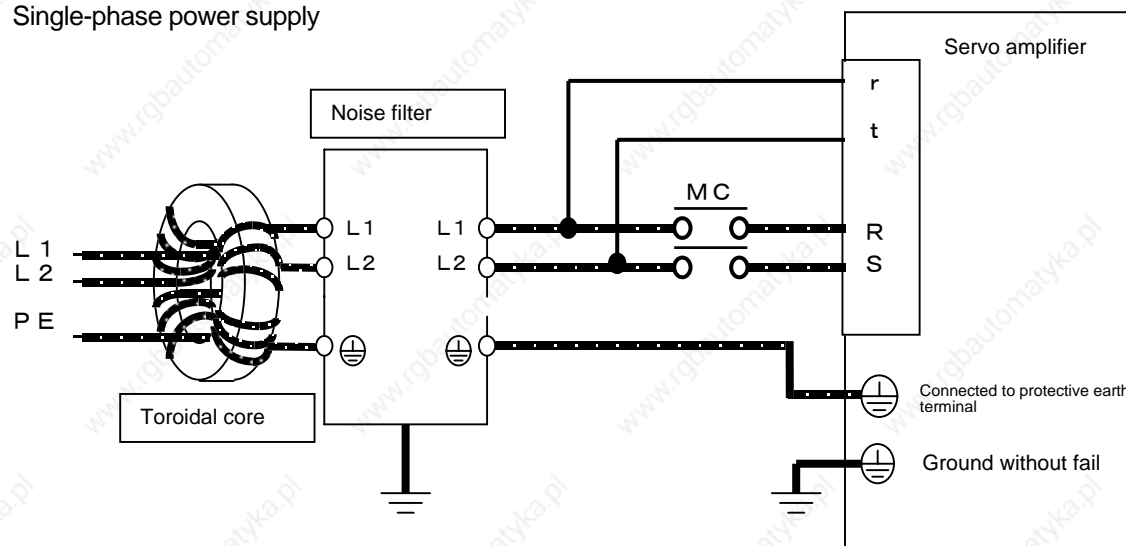

● Single-phase power supply



-  Always ground the frame of the noise filter.
-  Install wiring by separating the primary and secondary wiring of the noise filter as much as possible.
-  Keep wiring from the noise filter to servo amplifier as short as possible.
-  Connect the servo amplifier to the secondary side of noise filter.

Materials International Standards [Compliance with EC Directives]

■ Recommended prevention components

● Noise filter

Model Number	Specifications	Manufacturer
3SUP-HK30-ER-6B	Rated voltage : Line-Line 500 V Rated current : 30 A	Okaya Electric Industries Co. Ltd.
3SUP-HK50-ER-6B	Rated voltage : Line-Line 500 V Rated current : 50 A	Okaya Electric Industries Co. Ltd.
RF3020-DLC	Rated voltage : Line-Line 440 to 550 V Rated current : 20 A	RASMI ELECTRONICS LTD.
RF3030-DLC	Rated voltage : Line-Line 440 to 550 V Rated current : 30 A	RASMI ELECTRONICS LTD.
RF3070-DLC	Rated voltage : Line-Line 440 to 550 V Rated current : 70 A	RASMI ELECTRONICS LTD.
RF1010-DLC	Rated voltage : Line-Neutral 250 V Rated current : 10 A	SCHAFFNER
FS5559-35-33	Rated voltage : Line-Line 480 V Rated current : 35 A	Okaya Electric Industries Co. Ltd.

● Toroidal core

Model Number	External diameter	Internal diameter	Manufacturer
251-211	65 mm	36 mm	SCHAFFNER

Okaya Electric Industries Co. Ltd.: <http://www.okayaelec.co.jp/>

RASMI ELECTRONICS LTD. : <http://www.rasmi.com/>

SCHAFFNER : <http://www.schaffner.com/>

■ Implementation of check test

EMC testing of equipment and devices which the RS1 servo system is built-in should meet the emission and immunity (electromagnetic compatibility) standards for the usage environment / and operating conditions.

It is necessary to follow the instructions mentioned above and conduct a final conformity check test after review.

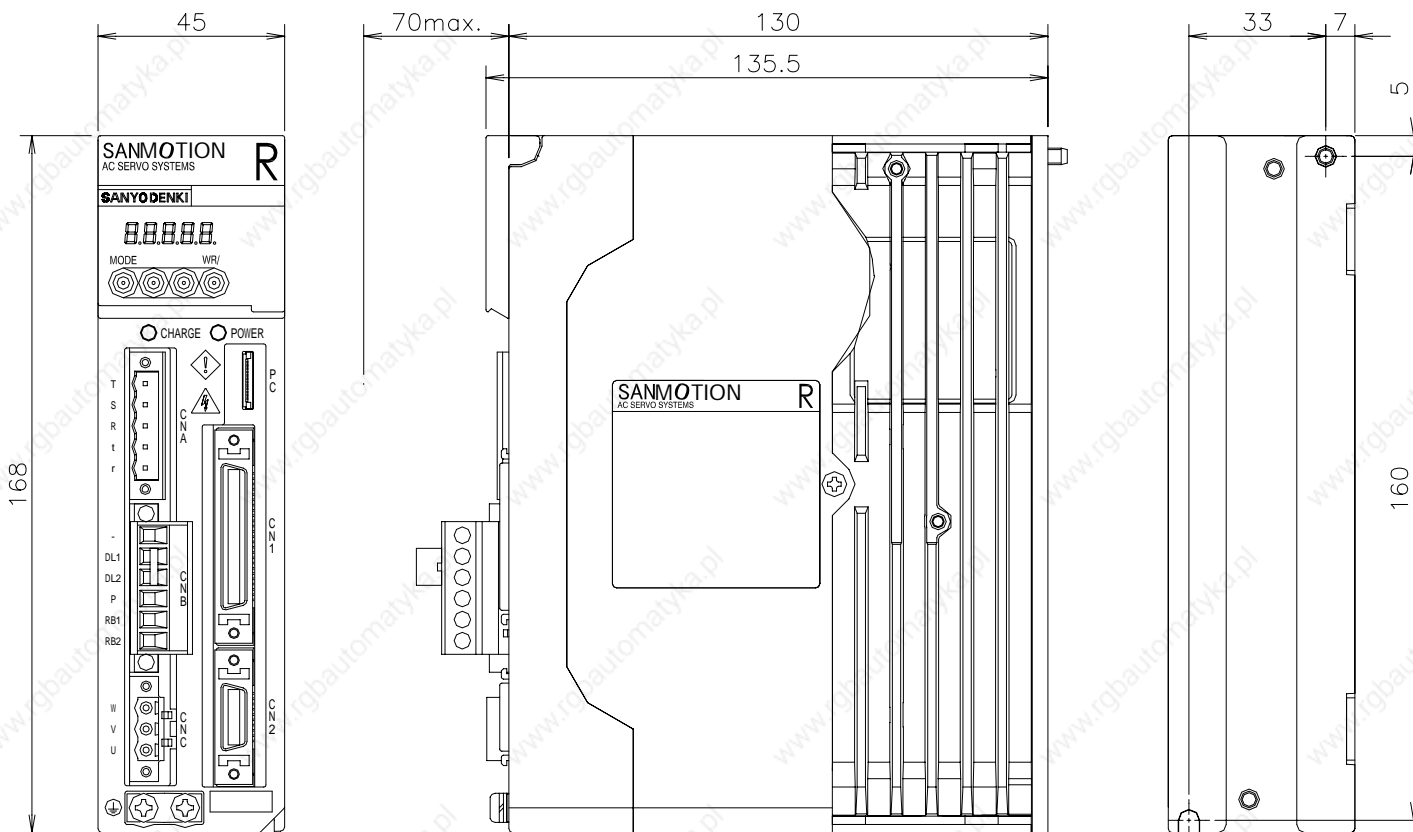
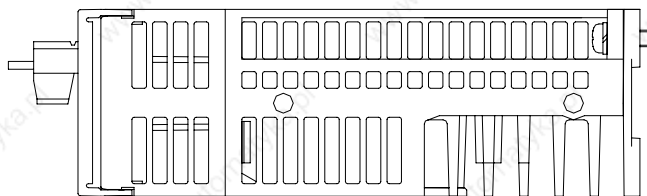

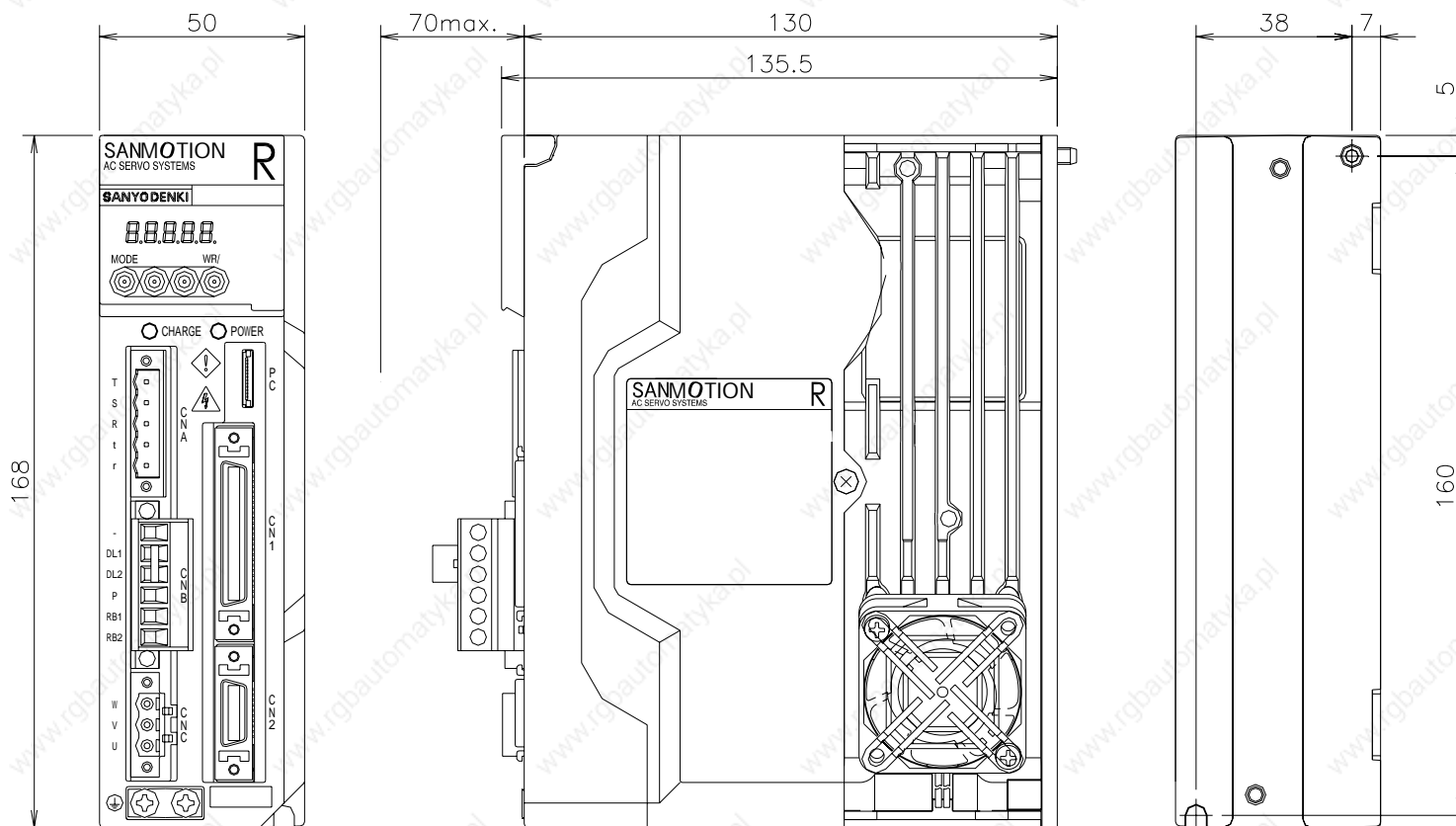
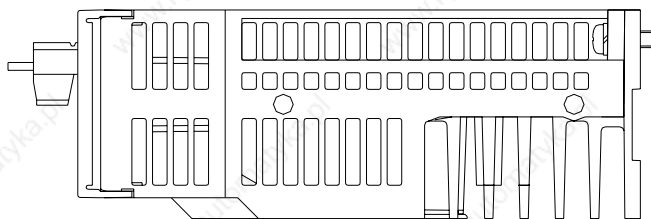

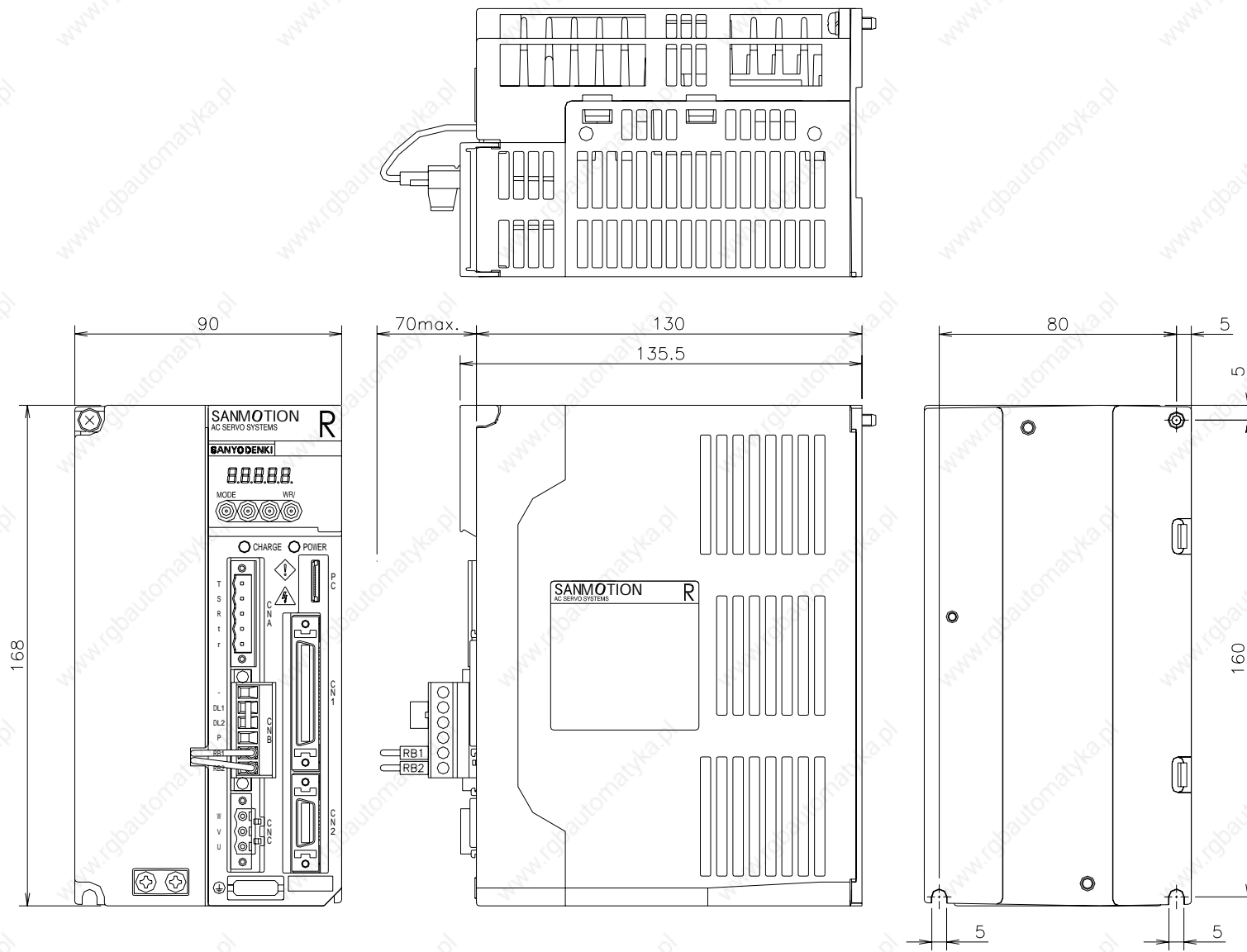

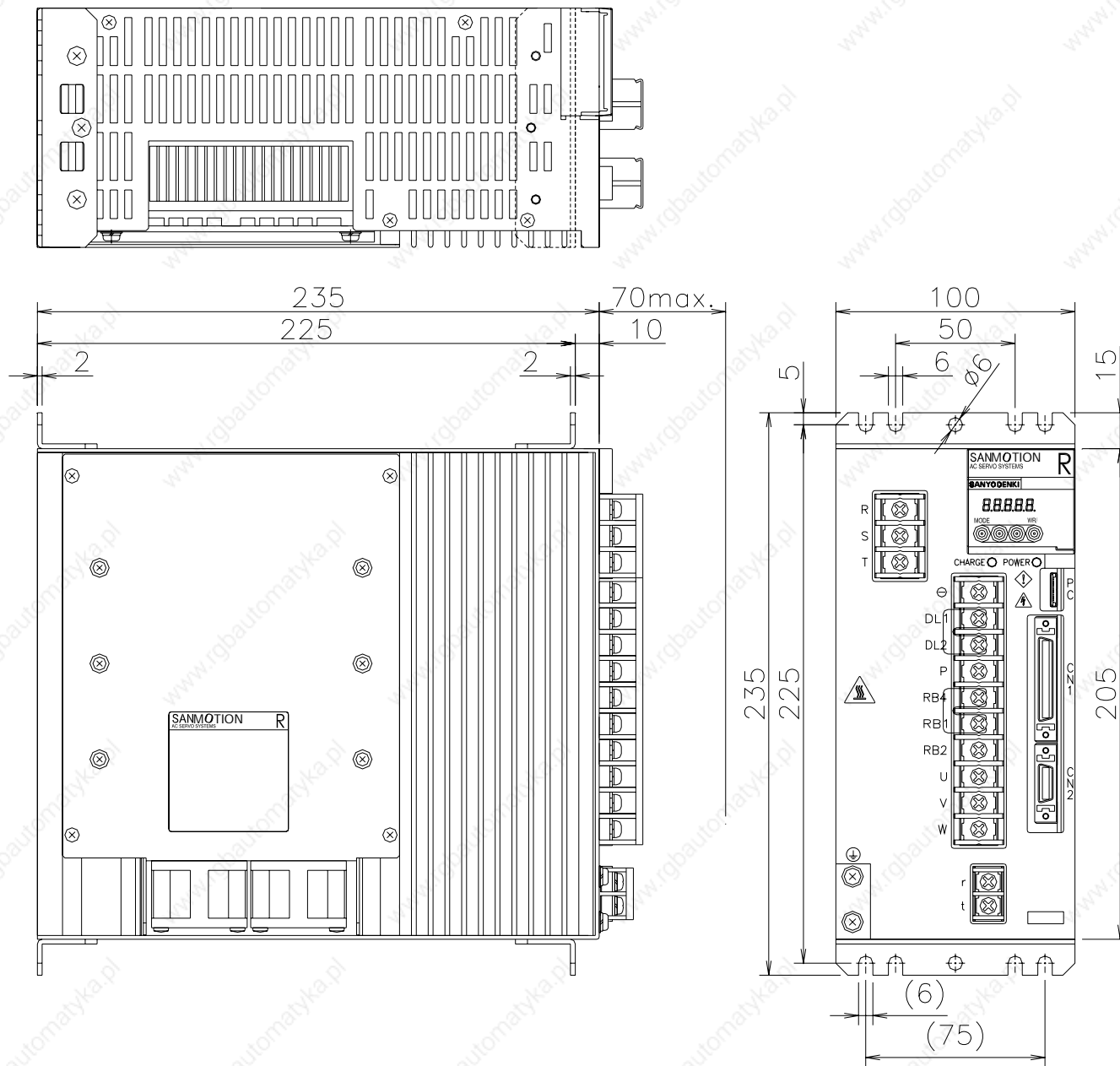

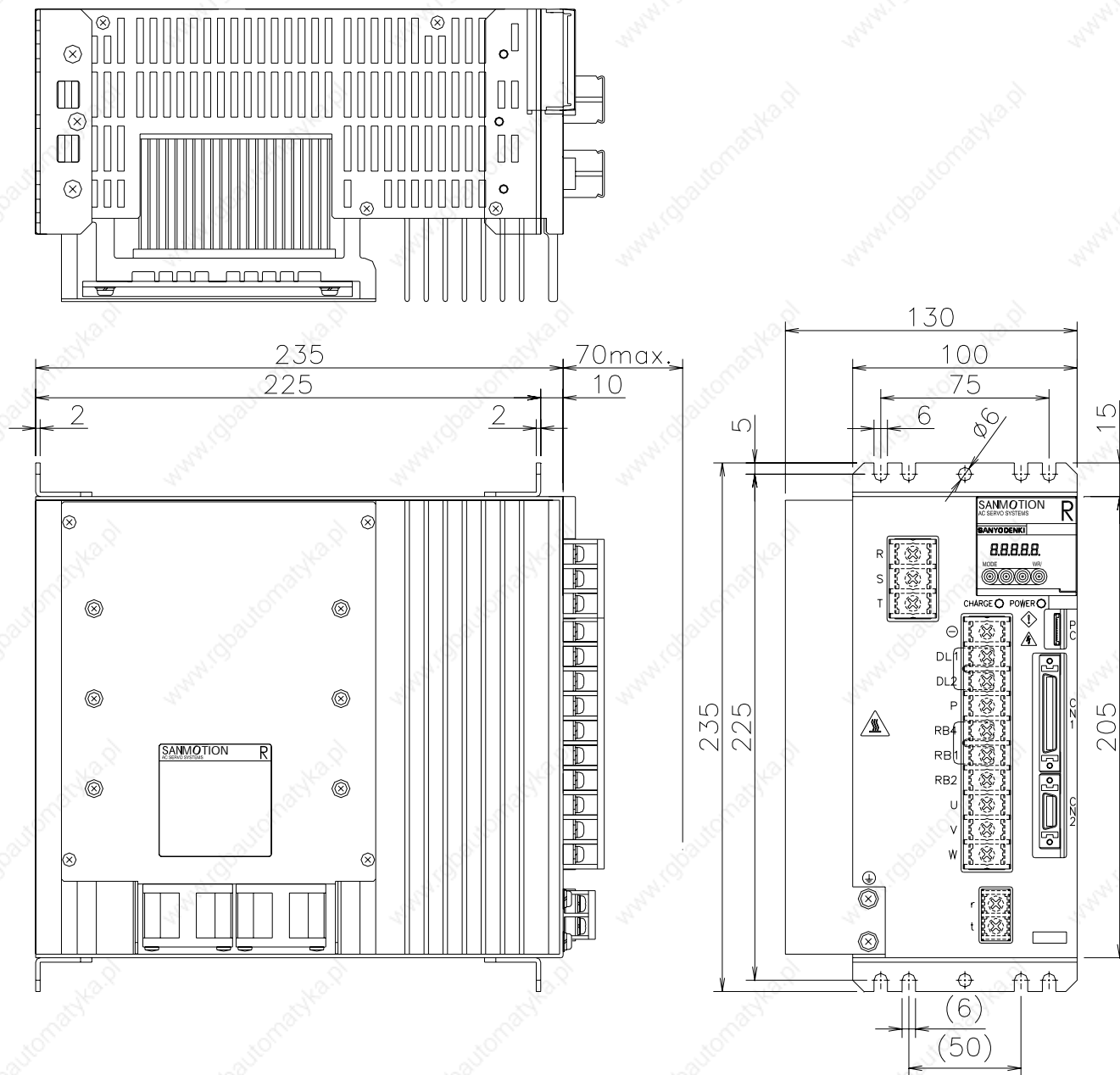

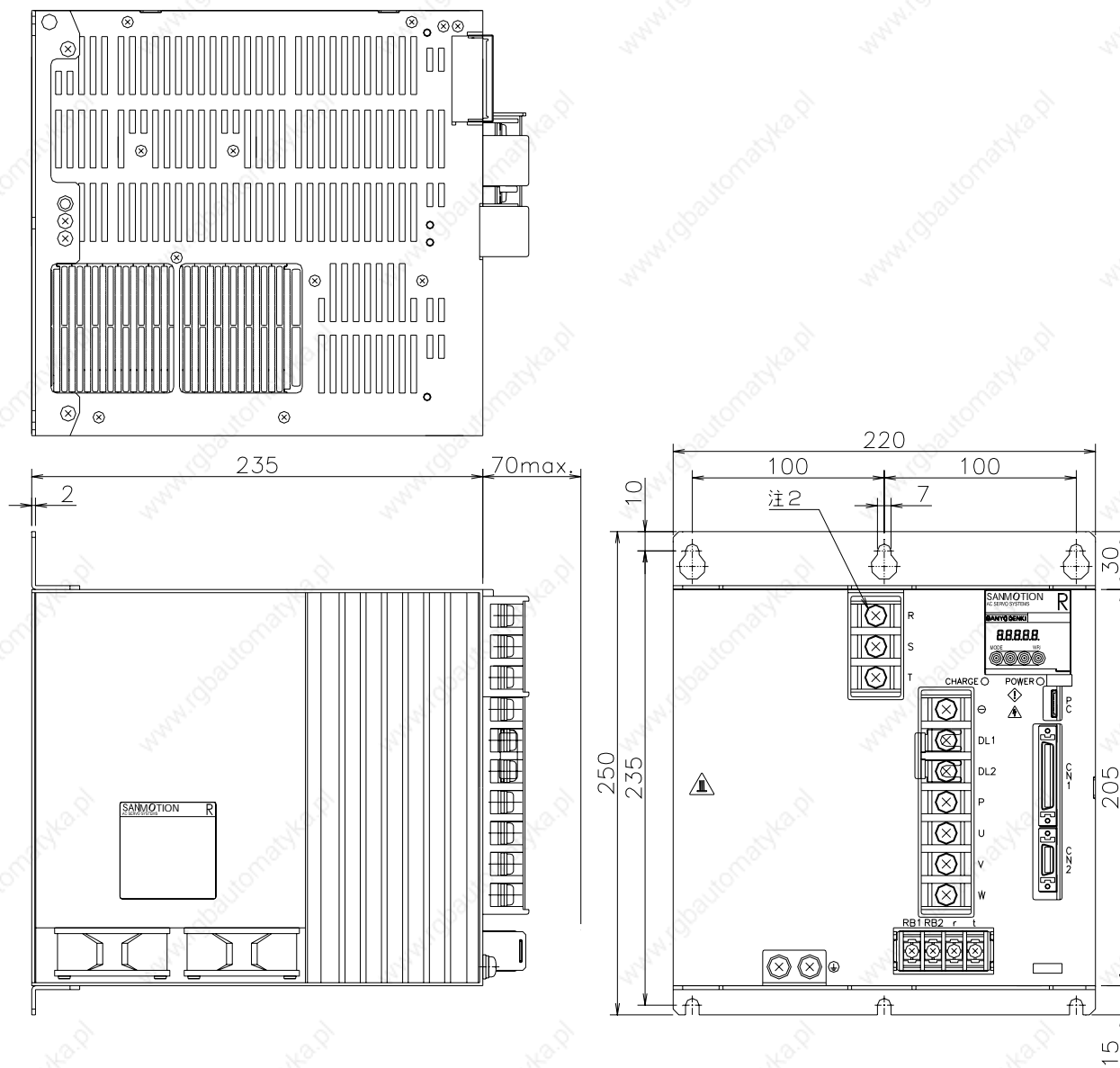

Materials Dimension

[Q1 40 ~ 76]

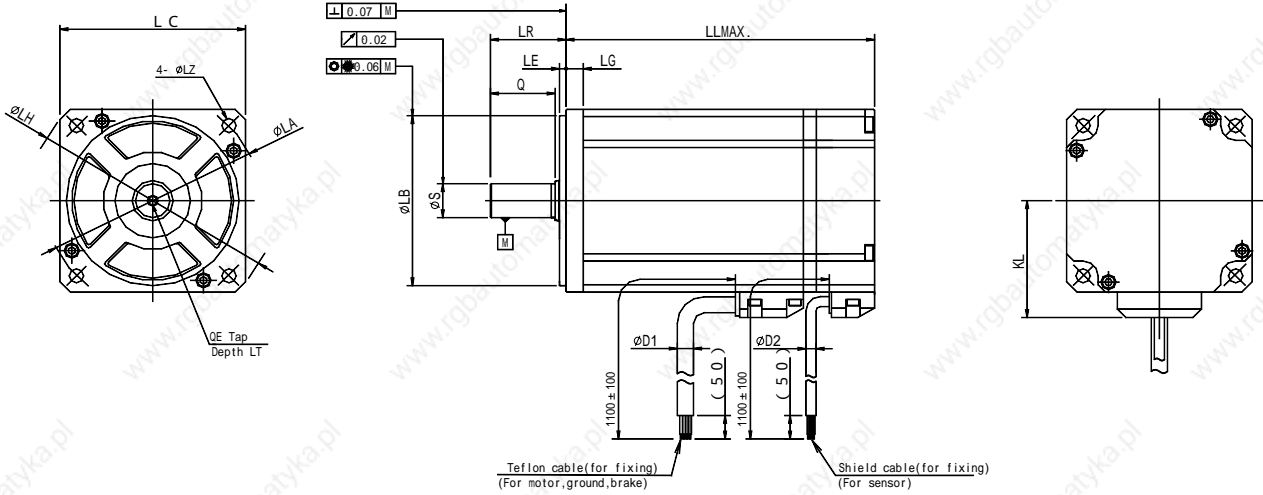

MODEL	Incremental		LG	KL	LA	LB	LE	LH	LC	LZ	LR	S	Q	QE	LT	D1	D2	Oil seal
	Without Brake	With Brake																
Q1AA04003	77	123.5	5	30	46	0 30-0.021	2.5	54	40	4.5	25	0 6-0.008				7	4.7	Option
Q1AA04005	83	129.5										0 8-0.009						
Q1AA04010	102	148.5										0 14-0.011						
Q1AA06020	113	142	6	41	70	0 50-0.025	3	81	60	5.5	30	0 14-0.011	M5	12	7.5	4.7	Option	
Q1AA06040	142	171										0 16-0.011						
Q1AA07075	156	179.5	8	50	90	0 70-0.030	3	100	76	5.5	40	0 16-0.011	35	M5	12	7.5	4.7	Option

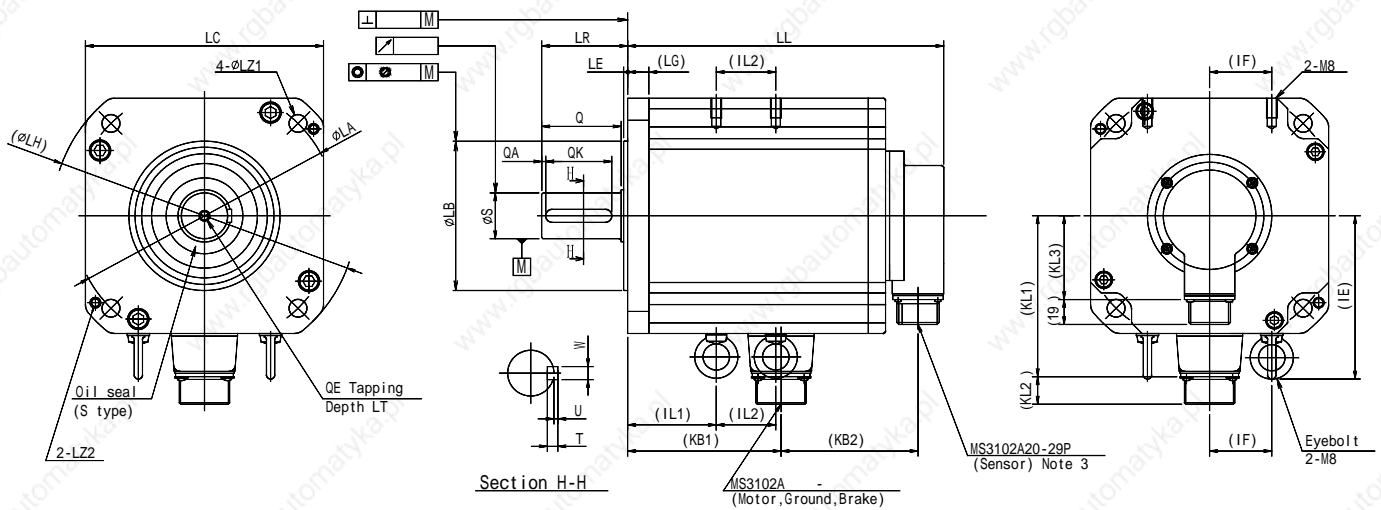

MODEL	Incremental			Connector Note 1		MS3102A	LG	KL1	KL2	KL3	LA	LB	LE	LH	LC	LZ1	LZ2	LR	
	Without Brake	With Brake		Motor grounding	Brake(only when brake is installed) Note2,3														
Q1AA10100	184	80	219	116	-	20-15P	10	78	19	63	115	0 95-0.035	3	130	100	9			45
Q1AA10150	209		244																
Q1AA10200	234		269																
Q1AA10250	259		294																
Q1AA12100	168	72	204	108	-	24-11P	12	93	21	67	135/145	0 110-0.035	3	162	120	9			45
Q1AA12200	205		241																
Q1AA12300	242		278																
Q1AA13300	205		249																
Q1AA13400	232	67	281	117	-	24-11P	12	98	21	80	145	0 110-0.035	4	165	130	9	M6	55	
Q1AA13500	269		318																
Q1AA18450	288		338																
Q1AA18750	384	72	434	122	54	32-17P	19	144	22	80	200	0 114.3-0.035	3	230	180	13.5	M8	65 79	

MODEL	S	Q	QA	QK	W	T	U	KB1			QE	LT	IE	IF	IL1	IL2	
Q1AA10100	22-0.013	40	3	32	6-0.030	6	2.5	84	0.02	0.08	0.08	M6	20				
Q1AA10150								109									
Q1AA10200								134									
Q1AA10250								159									
Q1AA12100	22-0.013	40	3	32	6-0.030	6	2.5	76	0.02	0.08	0.08	M6	20				
Q1AA12200								113									
Q1AA12300								150									
Q1AA13300								117									
Q1AA13400	28-0.013	50	3	42	8-0.036	7	3	144	0.02	0.08	0.08	M8	25				
Q1AA13500								181									
Q1AA18450	35-0.016	60	3	50	10-0.036	8	3	200	0.02	0.08	0.08	M8	25	124	50	93	50
Q1AA18750	42-0.016	75	3	67	12-0.043	8	3	291	0.02	0.08	0.08	M10	25	124	50	85	145

Note 1) Waterproof specification IP67 requires that the connector be attached;for IP67 compliance,use a waterproof connector for the mating plug.

Note 2) Brake connector JL04V-2E10SL-3PE-B is required for CE compliance.

Note 3) Brake is included only with Model QAA18750.

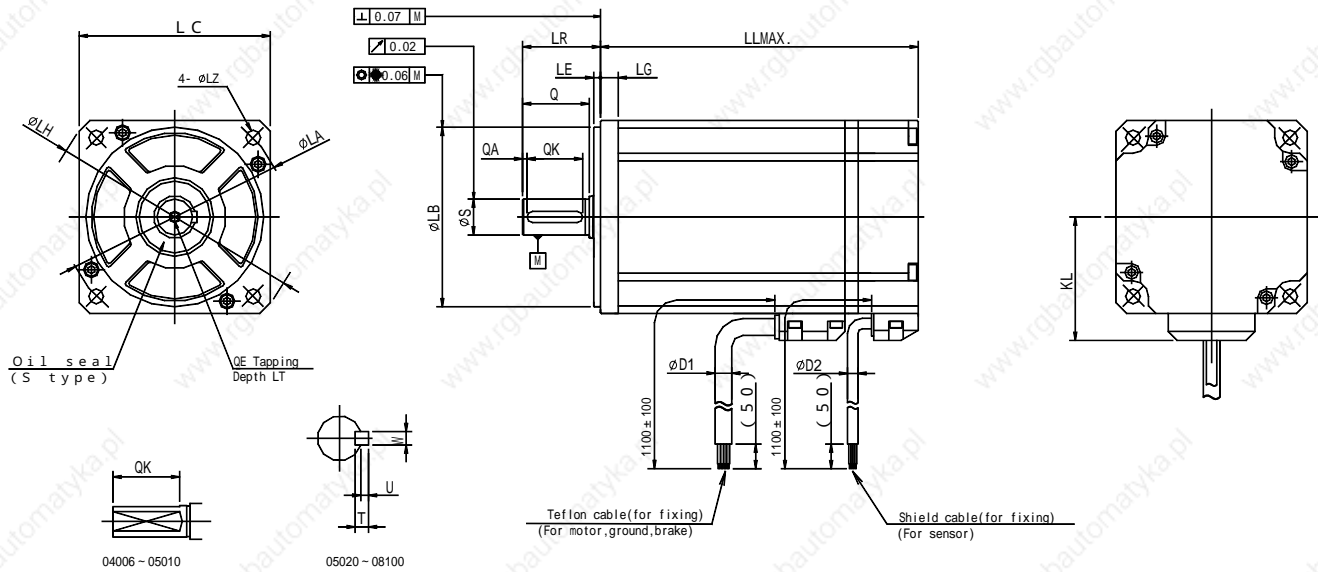

MODEL	Incremental		LG	KL	LA	LB	LE	LH	LC	LZ	LR
	Without Brake	With Brake									
Q2AA04006	82	114	5	31	48	0	2	57	42	3.5	24
Q2AA04010	96	128				34-0.025					
Q2AA05005	81	110	5	38	60	0	2.5	71.5	54	4.5	24
Q2AA05010	89	117				50-0.025					
Q2AA05020	105	133	8	50	90	0	3	100	76	5.5	30
Q2AA07020	98	123									
Q2AA07030	105	130									
Q2AA07040	112	137									
Q2AA07050	120	145	8	55	100	0	3	115	86	6.6	35
Q2AA08050	130	166									
Q2AA08075	147	183									
Q2AA08100	166	200									

MODEL	S	Q	QA	QK	W	T	U	QE	LT	D1	Incremental		Oil seal
											D2		
Q2AA04006	0	20		15	Two slot cuts 6.5 ± 0.2					7			None note1
Q2AA04010	7-0.009												
Q2AA05005	0	20		15	Two slot cuts 7.5 ± 0.2			M3	8				Included
Q2AA05010	8-0.009												
Q2AA05020	0	25	2	20	4	4	1.5	M4	10	7.5	4.7		
Q2AA07020	11-0.011												
Q2AA07030	0												
Q2AA07040	14-0.011												
Q2AA07050	0	30	2	25	5	5	2	M5	12				
Q2AA08050	16-0.011												
Q2AA08075	0												
Q2AA08100	16-0.011												

(Unit:mm)

Note 1) If an oil seal is needed for Q2AA04*, the overall motor length is different.

Materials Dimension

[Q2 100 ~ 220]

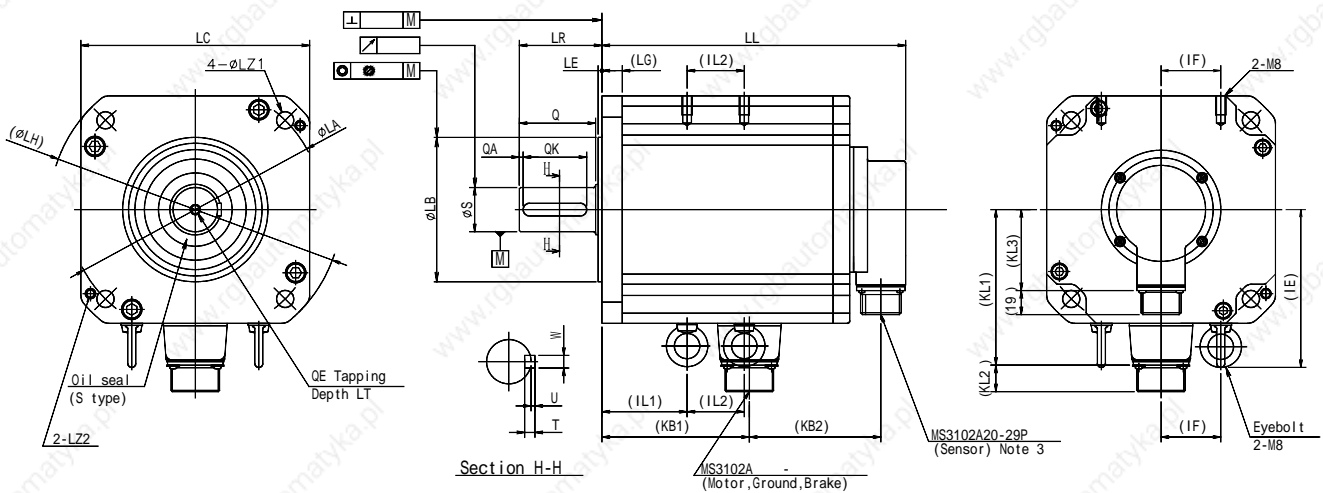

MODEL	Incremental			Connector Note 1																												
	Without Brake	With Brake		Motor grounding	Brake(only when brake is installed) Note2,3																											
	LL	KB2	LL	KB2	KB3	MS3102A	LG	KL1	KL2	KL3	LA	LB	LE	LH	LC	LZ1	LZ2	LR														
Q2AA10100	196	77	231	113		20-15P	10	78	19	67	115	0	3	130	100	9		45														
Q2AA10150	226		261				95-0.035																									
Q2AA13050	135	67	171	103		24-11P	12	98	21	80	145	0	4	165	130	9	M6	55														
Q2AA13100	152		188				110-0.035																									
Q2AA13150	169		205																													
Q2AA13200	186		226				107																									
Q2AA18200	171	67	221	117		24-11P	16	123	21	80	200	0	3	230		180	13.5	M8	65													
Q2AA18350	203		253				114.3-0.035																									
Q2AA18450	218		268																													
Q2AA18550	282	72	332	122	54	32-17P	19	144	22	80	200	0	3	230	180	13.5	M8	79														
Q2AA18750	332		382																114.3-0.035													
Q2AA22250	150	65	196	111		24-11P	16	141	21	80	235	0	4	270	220	13.5	M10	65														
Q2AA22350	163		209				200-0.046																									
Q2AA22450	181		227																													
Q2AA22550	252		309																													
Q2AA22700	310	82	368	140		24-11P	19	141	21	80	235	0	4	270	220	13.5	M10	79														
Q2AA2211K	335																															
Q2AA2215K	394	73				32-17P	19	162	22	80	235	0	4	270	220	13.5	M10	79														
Q2AA2215K	394																															

MODEL	S	Q	QA	QK	W	T	U	KB1				QE	LT	IE	IF	IL1	IL2		
Q2AA10100	0	40	3	32	0	6	2.5	98	0.02	0.08	0.08	M6	20						
Q2AA10150	22-0.013																	6-0.030	128
Q2AA13050	0	50	3	42	0	6	2.5	47	0.02	0.08	0.08	M6	20						
Q2AA13100																		22-0.013	6-0.030
Q2AA13150								81											
Q2AA13200	0	28-0.013			0	7	3	98				M8	25						
Q2AA18200	28-0.013																	8-0.036	
Q2AA18350	0	35-0.016	60	3	50	8	3	83	0.02	0.08	0.08	M8	25	124	50	61	20		
Q2AA18450	35-0.016																	10-0.036	115
Q2AA18550	0	42-0.016	75	3	67	8	3	130	0.02	0.08	0.08	M10	25	124	50	85	50		
Q2AA18750	42-0.016																	12-0.043	189
Q2AA22250	0	35-0.016	60	3	50	8	3	64	0.02	0.08	0.08	M8	25	142	60	50	10		
Q2AA22350	35-0.016																	10-0.036	77
Q2AA22450																			95
Q2AA22550	0																	75	67
Q2AA22700	55-0.019				16-0.043			207									110		
Q2AA2211K	0	55-0.019	75	3	67	10	4	241	0.03	0.08	0.10	M10	25	142	60	69	120		
Q2AA2215K	55-0.019																	16-0.043	300

Note 1) Waterproof specification IP67 requires that the connector be attached; for IP67 compliance, use a waterproof connector for the mating plug.

Note 2) Brake connector JL04V-2E10SL-3PE-B is required for CE compliance.

Note 3) Brake is included only with Model Q2AA18550, Q2AA18750, Q2AA2211K and Q2AA2215K.

Materials Servo motor data sheet [Characteristics table]

Three-phase A C 2 0 0 V Input specification

Servo Motor model Q1AA			04003D	04005D	04010D	06020D	06040D	07075D	10100D
Servo Amplifier model RS1			01*	01*	01*	01*	03*	03*	05*
*Rated output	P_R	kW	0.03	0.05	0.1	0.2	0.4	0.75	1
*Rated speed	N_R	min^{-1}	3000	3000	3000	3000	3000	3000	3000
*Maximum speed	N_{max}	min^{-1}	5000	5000	5000	5000	5000	5000	5000
*Rated torque	T_R	$\text{N}\cdot\text{m}$	0.098	0.159	0.318	0.637	1.27	2.38	3.19
*Continuous stall torque	T_S	$\text{N}\cdot\text{m}$	0.108	0.159	0.318	0.637	1.27	2.38	3.92
*Peak torque	T_P	$\text{N}\cdot\text{m}$	0.322	0.477	0.955	1.91	3.82	7.16	10.5
*Rated current	I_R	Arms	0.49	0.80	1	1.5	2.9	4.3	6.9
*Continuous stall current	I_S	Arms	0.53	0.80	1	1.5	2.9	4.3	8.0
*Peak current	I_P	Arms	2.2	2.9	3.6	5.8	10.5	15	26.5
Torque constant	K_T	$\text{N}\cdot\text{m}/\text{Arms}$	0.220	0.228	0.360	0.493	0.510	0.613	0.553
Voltage constant for each phase	K_E	$\text{m V}/\text{min}^{-1}$	7.68	7.95	12.6	17.2	17.8	21.4	19.3
Phase resistance	R		15	8.72	7.6	2.53	1.28	0.633	0.267
*Rated power rate	Q_R	$\text{k W}/\text{s}$	9.60	18.9	43.4	28.8	65.3	89.1	97.8
Inertia (Including Wiring INC)	J_M	$\text{kg}\cdot\text{m}^2(\text{GD}^2/4) \times 10^{-4}$	0.01	0.0134	0.0233	0.141	0.247	0.636	1.04
Aluminium plate		mm	t6 x 250	t6 x 250	t6 x 250	t12 x 250	t12 x 250	t12 x 250	t20 x 400

Servo Motor model Q1AA			10150D	10200D	10250D	12100D	12200D	12300D	13300D
Servo Amplifier model RS1			05*	10*	10*	05*	10*	10*	10*
*Rated output	P_R	kW	1.5	2	2.5	1	2	3	3
*Rated speed	N_R	min^{-1}	3000	3000	3000	3000	3000	3000	3000
*Maximum speed	N_{max}	min^{-1}	4500	5000	5000	5000	5000	5000	4500
*Rated torque	T_R	$\text{N}\cdot\text{m}$	4.79	6.37	7.97	3.19	6.37	9.55	9.51
*Continuous stall torque	T_S	$\text{N}\cdot\text{m}$	4.9	7.36	8.82	3.92	7.36	11	10.8
*Peak torque	T_P	$\text{N}\cdot\text{m}$	14.7	19.6	24.4	11	21	31	28.4
*Rated current	I_R	Arms	8.2	15.9	16.6	6.2	14.3	16.2	16.1
*Continuous stall current	I_S	Arms	8.2	18	17.2	7.5	16.2	17.3	16.5
*Peak current	I_P	Arms	26.5	55	55	24.5	53	55	55
Torque constant	K_T	$\text{N}\cdot\text{m}/\text{Arms}$	0.705	0.470	0.587	0.578	0.534	0.728	0.693
Voltage constant for each phase	K_E	$\text{m V}/\text{min}^{-1}$	24.6	16.4	20.5	20.2	18.6	25.4	24.2
Phase resistance	R		0.272	0.0860	0.104	0.190	0.0699	0.0793	0.0867
*Rated power rate	Q_R	$\text{k W}/\text{s}$	143	189	240	45.2	92.9	143	184
Inertia (Including Wiring INC)	J_M	$\text{kg}\cdot\text{m}^2(\text{GD}^2/4) \times 10^{-4}$	1.61	2.15	2.65	2.25	4.37	6.4	4.92
Aluminium plate		mm	t20 x 400	t20 x 470	t20 x 470	t20 x 400	t20 x 470	t20 x 470	t20 x 470

Servo Motor model Q1AA			13400D	13500D	18450M	18750H			
Servo Amplifier model RS1			15*	15*	15*	30*			
*Rated output	P_R	kW	4	5	4.5	7.5			
*Rated speed	N_R	min^{-1}	3000	3000	1500	1500			
*Maximum speed	N_{max}	min^{-1}	4500	4500	1500	3000			
*Rated torque	T_R	$\text{N}\cdot\text{m}$	12.7	15.7	28.5	48			
*Continuous stall torque	T_S	$\text{N}\cdot\text{m}$	14.7	18.1	31.6	55			
*Peak torque	T_P	$\text{N}\cdot\text{m}$	39.2	47.6	105	125			
*Rated current	I_R	Arms	23.4	25.8	24.8	55			
*Continuous stall current	I_S	Arms	26.4	27.5	24.8	60			
*Peak current	I_P	Arms	83	83	83	155			
Torque constant	K_T	$\text{N}\cdot\text{m}/\text{Arms}$	0.612	0.724	1.37	0.91			
Voltage constant for each phase	K_E	$\text{m V}/\text{min}^{-1}$	21.4	25.3	47.7	31.7			
Phase resistance	R		0.0478	0.0461	0.0838	0.021			
*Rated power rate	Q_R	$\text{k W}/\text{s}$	251	291	295	443			
Inertia (Including Wiring INC)	J_M	$\text{kg}\cdot\text{m}^2(\text{GD}^2/4) \times 10^{-4}$	6.43	8.47	27.5	52			
Aluminium plate		mm	t20 x 470	t20 x 540	t20 x 540	t20 x 540			

• Constants are values at the time of installing on the aluminum board in the table. They indicate 'thickness' x 'side of square'.

• Items with * and velocity – torque characteristics indicate values after temperature rise saturation. The others indicate values at 20 °C. Each value indicates TYP.

Materials Servo motor data sheet [Characteristics table]

A C 1 0 0 V Input specification

Servo Motor model Q1EA			04003D	04005D	04010D	06020D			
Servo Amplifier model RS1			01*	01*	01*	03*			
*Rated output	P_R	kW	0.03	0.05	0.1	0.2			
*Rated speed	N_R	min^{-1}	3000	3000	3000	3000			
*Maximum speed	N_{\max}	min^{-1}	5000	5000	5000	5000			
*Rated torque	T_R	$\text{N}\cdot\text{m}$	0.098	0.159	0.318	0.637			
*Continuous stall torque	T_S	$\text{N}\cdot\text{m}$	0.108	0.159	0.318	0.637			
*Peak torque	T_P	$\text{N}\cdot\text{m}$	0.322	0.477	0.955	1.91			
*Rated current	I_R	Arms	0.9	1.92	2.2	4.5			
*Continuous stall current	I_S	Arms	0.95	1.92	2.2	4.5			
*Peak current	I_P	Arms	4	7	7.9	15.5			
Torque constant	K_T	$\text{N}\cdot\text{m}/\text{Arms}$	0.115	0.0956	0.176	0.161			
Voltage constant for each phase	K_E	$\text{m V}/\text{min}^{-1}$	4.03	3.34	6.13	5.63			
Phase resistance	R		4.28	1.36	2.21	0.327			
*Rated power rate	Q_R	$\text{k W} / \text{s}$	9.60	18.9	43.4	28.8			
Inertia (Including Wiring INC)	J_M	$\text{kg}\cdot\text{m}^2(\text{GD}^2/4) \times 10^{-4}$	0.01	0.0134	0.0233	0.141			
Aluminium plate		m m	t6 x 305	t6 x 305	t6 x 305	t6 x 305			

- Constants are values at the time of installing on the aluminum board in the table. They indicate 'thickness' \times 'side of square'.
- Items with * and velocity – torque characteristics indicate values after temperature rise saturation. The others indicate values at 20 . Each value indicates T Y P .

Materials Servo motor data sheet [Characteristics table]

Three-phase A C 2 0 0 V Input specification

Servo Motor model Q2AA			04006D	04010D	05005D	05010D	05020D	07020D	07030D
Servo Amplifier model RS1			01*	01*	01*	01*	01*	01*	01*
*Rated output	PR	kW	0.06	0.1	0.05	0.1	0.2	0.2	0.3
*Rated speed	NR	min - 1	3000	3000	3000	3000	3000	3000	3000
*Maximum speed	Nmax	min - 1	5000	5000	5000	5000	5000	5000	5000
*Rated torque	TR	N·m	0.191	0.318	0.159	0.318	0.637	0.637	0.955
*Continuous stall torque	TS	N·m	0.216	0.353	0.167	0.353	0.686	0.686	0.98
*Peak torque	TP	N·m	0.65	1	0.518	1.06	2.05	2.1	3.4
*Rated current	IR	Arms	0.67	1.1	0.86	1.1	1.6	2.1	2.1
*Continuous stall current	IS	Arms	0.67	1.2	0.88	1.2	1.7	2.2	2.5
*Peak current	IP	Arms	2.7	3.6	3.3	4.3	5.9	7.5	7.9
Torque constant	KT	N·m/Arms	0.314	0.325	0.208	0.326	0.435	0.34	0.519
Voltage constant for each phase	KE	m V/min - 1	10.97	11.34	7.26	11.4	15.18	11.8	18.1
Phase resistance	R		11.3	6.77	4.72	4.05	3.24	1.18	2.22
*Rated power rate	Q R	k W / s	6.4	11.8	3.8	7.8	16.2	10.7	20.3
Inertia (Including Wiring INC)	JM	kg·m ² (GD ² /4) × 10 ⁻⁴	0.057	0.086	0.067	0.13	0.25	0.380	0.45
Aluminium plate		mm	t6 × 250	t6 × 250	t6 × 250	t6 × 305	t6 × 305	t6 × 305	t6 × 305

Servo Motor model Q2AA			07040D	07050D	08050D	08075D	08100D	10100H	10150H
Servo Amplifier model RS1			03*	03*	03*	05*	05*	05*	05*
*Rated output	PR	kW	0.4	0.5	0.5	0.75	1	1	1.5
*Rated speed	NR	min - 1	3000	3000	3000	3000	3000	2000	2000
*Maximum speed	Nmax	min - 1	5000	5000	5000	5000	5000	3500	3000
*Rated torque	TR	N·m	1.273	1.59	1.592	2.387	3.18	5	7.2
*Continuous stall torque	TS	N·m	1.372	1.85	1.958	2.941	3.92	6	8
*Peak torque	TP	N·m	4.1	5.2	6.56	9	12.5	16.6	20.5
*Rated current	IR	Arms	3.0	4.3	3.7	5.9	6	6.8	8.6
*Continuous stall current	IS	Arms	3.1	5.0	4.3	7	6.9	8.1	9.4
*Peak current	IP	Arms	12	15	15	23.7	25	24.5	25.5
Torque constant	KT	N·m/Arms	0.482	0.441	0.519	0.441	0.587	0.814	0.937
Voltage constant for each phase	KE	m V/min - 1	16.8	15.4	18.1	15.4	20.5	28.4	32.7
Phase resistance	R		1.26	0.8	0.800	0.358	0.410	0.477	0.34
*Rated power rate	Q R	k W / s	21.6	29.7	19.5	27.5	37.0	46.0	64.9
Inertia (Including Wiring INC)	JM	kg·m ² (GD ² /4) × 10 ⁻⁴	0.75	0.85	1.3	2.07	2.73	5.44	7.99
Aluminium plate		mm	t6 × 305	t6 × 305	t6 × 305	t6 × 305	t20 × 305	t20 × 400	t20 × 400

Servo Motor model Q2AA			13050H	13100H	13150H	13200H	18200H	18350H	18450H
Servo Amplifier model RS1			03*	05*	05*	10*	10*	15*	15*
*Rated output	PR	kW	0.5	1.0	1.5	2	2	3.5	4.5
*Rated speed	NR	min - 1	2000	2000	2000	2000	2000	2000	2000
*Maximum speed	Nmax	min - 1	3500	3000	3500	3500	3500	3500	3000
*Rated torque	TR	N·m	2.5	5	7.52	9.55	9.55	16.7	21.5
*Continuous stall torque	TS	N·m	3	6	9	12	12	21.1	27.0
*Peak torque	TP	N·m	7.1	15	20.3	30.5	31	55	70
*Rated current	IR	Arms	4.6	7	8.7	13.1	14.6	22.6	23.8
*Continuous stall current	IS	Arms	5.2	8.3	10.2	16.3	18.1	28	29
*Peak current	IP	Arms	15	23.7	26.5	48	55	83	81
Torque constant	KT	N·m/Arms	0.607	0.803	0.981	0.822	0.809	0.840	1.04
Voltage constant for each phase	KE	m V/min - 1	21.2	28.0	34.2	28.7	28.3	29.3	36.4
Phase resistance	R		0.636	0.276	0.266	0.119	0.101	0.045	0.0517
*Rated power rate	Q R	k W / s	22.3	46.3	71.2	77.5	46.8	73.7	84.0
Inertia (Including Wiring INC)	JM	kg·m ² (GD ² /4) × 10 ⁻⁴	2.8	5.4	7.94	11.76	19.5	37.89	54.99
Aluminium plate		mm	t20 × 305	t20 × 400	t20 × 400	t20 × 470	t20 × 470	t20 × 470	t20 × 470

• Constants are values at the time of installing on the aluminum board in the table. They indicate 'thickness' × 'side of square'.

• Items with * and velocity – torque characteristics indicate values after temperature rise saturation. The others indicate values at 20 °C. Each value indicates T Y P .

Materials Servo motor data sheet [Characteristics table]

Servo Motor model Q2AA			18550R	22250H	22350H	22450R	22550B	22700S
Servo Amplifier model RS1			15*	10*	15*	15*	15*	15*
*Rated output	PR	kW	5.5	2.5	3.5	4.5	5.5	7
*Rated speed	NR	min - 1	1500	2000	2000	2000	1500	1000
*Maximum speed	Nmax	min - 1	2500	3500	3000	2500	2000	1000
*Rated torque	TR	N·m	35	12	17	21.5	35	67
*Continuous stall torque	TS	N·m	37.3	13.5	22	32	42	70
*Peak torque	TP	N·m	88	30	50	70	90	150
*Rated current	IR	Arms	32.2	19.6	23.3	23	30	34
*Continuous stall current	IS	Arms	33.7	21.8	29.8	33	35.1	34
*Peak current	IP	Arms	83	55	78	83	79.7	83
Torque constant	KT	N·m/Arms	1.24	0.685	0.814	1.06	1.32	2.13
Voltage constant for each phase	KE	m V/min - 1	43.2	23.9	28.4	37.1	46.0	74.5
Phase resistance	R		0.039	0.0735	0.0559	0.0497	0.0464	0.057
*Rated power rate	Q R	k W / s	178	44.7	61.1	68.5	128.5	275.4
Inertia (Including Wiring INC)	JM	kg·m ² (GD ² /4) × 10 ⁻⁴	69	32.2	47.33	67.45	95.3	163
Aluminium plate		mm	t20 × 540	t20 × 470	t20 × 470	t20 × 470	t20 × 540	t20 × 540

Servo Motor model Q2AA			18550H	18750L	2211KV	2215KV
Servo Amplifier model RS1			30*	30*	30*	30*
*Rated output	PR	kW	5.5	7.5	11	15
*Rated speed	NR	min - 1	1500	1500	1500	1500
*Maximum speed	Nmax	min - 1	3000	3000	2000	2000
*Rated torque	TR	N·m	35	48	70	95.5
*Continuous stall torque	TS	N·m	37.3	55	80	95.5
*Peak torque	TP	N·m	107	135	176	215
*Rated current	IR	Arms	47	52	60	66
*Continuous stall current	IS	Arms	47	57	66	66
*Peak current	IP	Arms	155	155	155	157
Torque constant	KT	N·m/Arms	0.830	1.03	1.29	1.54
Voltage constant for each phase	KE	m V/min - 1	29.0	36.0	45.1	53.6
Phase resistance	R		0.018	0.017	0.015	0.016
*Rated power rate	Q R	k W / s	170	240	260	360
Inertia (Including Wiring INC)	JM	kg·m ² (GD ² /4) × 10 ⁻⁴	73	95	186	255
Aluminium plate		mm	t20 × 540	t20 × 540	t20 × 540	t20 × 540

A C 1 0 0 V Input specification

Servo Motor model Q2EA			04006D	04010D	05005D	05010D	05020D	07020D
Servo Amplifier model RS1			01*	01*	01*	01*	03*	03*
*Rated output	PR	kW	0.06	0.1	0.05	0.1	0.2	0.2
*Rated speed	NR	min - 1	3000	3000	3000	3000	3000	3000
*Maximum speed	Nmax	min - 1	5000	5000	5000	5000	5000	5000
*Rated torque	TR	N·m	0.191	0.318	0.159	0.318	0.637	0.637
*Continuous stall torque	TS	N·m	0.216	0.353	0.167	0.353	0.686	0.686
*Peak torque	TP	N·m	0.65	1	0.518	1.03	2.1	2.1
*Rated current	IR	Arms	1.9	2.0	1.5	2.1	3.9	4.4
*Continuous stall current	IS	Arms	1.9	2.2	1.5	2.3	4.1	4.6
*Peak current	IP	Arms	7.9	7	5.6	7.9	15.5	15.5
Torque constant	KT	N·m/Arms	0.117	0.188	0.121	0.169	0.184	0.162
Voltage constant for each phase	KE	m V/min - 1	4.09	6.55	4.23	5.9	6.41	5.67
Phase resistance	R		1.57	2.00	1.84	1.22	0.595	0.504
*Rated power rate	Q R	k W / s	6.40	11.8	3.8	7.8	16.2	10.6
Inertia (Including Wiring INC)	JM	kg·m ² (GD ² /4) × 10 ⁻⁴	0.057	0.086	0.067	0.13	0.25	0.382
Aluminium plate		mm	t6 × 305	t6 × 305	t6 × 305	t6 × 305	t6 × 305	t6 × 305

• Constants are values at the time of installing on the aluminum board in the table. They indicate 'thickness' × 'side of square'.

• Items with * and velocity – torque characteristics indicate values after temperature rise saturation. The others indicate values at 20 °C. Each value indicates TYP.

Materials Servo motor data sheet [Characteristics table]

Q1AA Motor speed-torque characteristics indicate the values in combination with an amplifier 3 phase when amplifier power supply is AC200V. Instant domain decreases when amplifier power supply is below 200V.

Speed – torque characteristics
Q1AA04003D (30W)

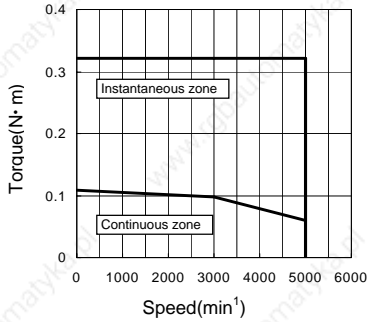

Speed – torque characteristics
Q1AA04005D (50W)

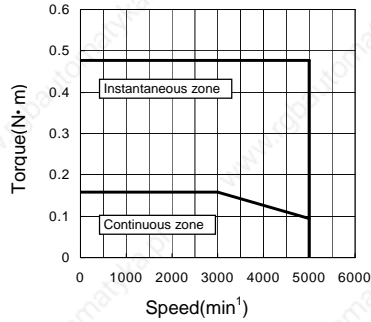

Speed – torque characteristics
Q1AA04010D (100W)

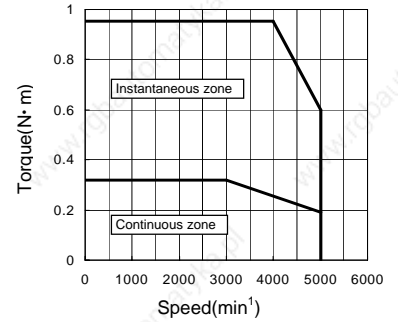

Speed – torque characteristics
Q1AA06020D (200W)

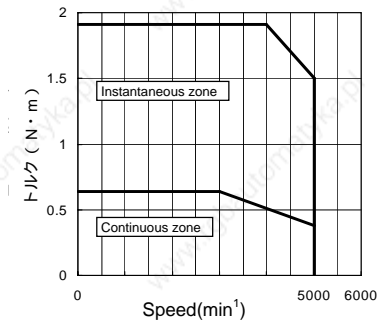

Speed – torque characteristics
Q1AA06040D (400W)

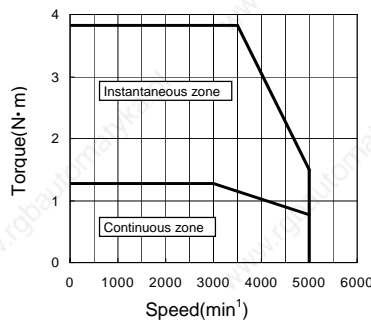

Speed – torque characteristics
Q1AA07075D (750W)

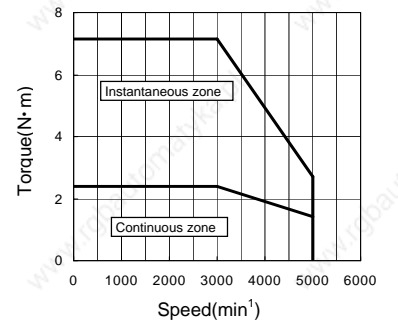

Speed – torque characteristics
Q1AA10100D (1kW)

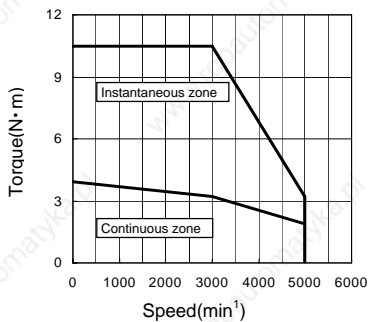

Speed – torque characteristics
Q1AA10150D (1.5kW)

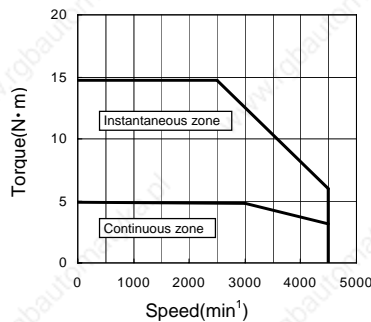

Speed – torque characteristics
Q1AA10200D (2kW)

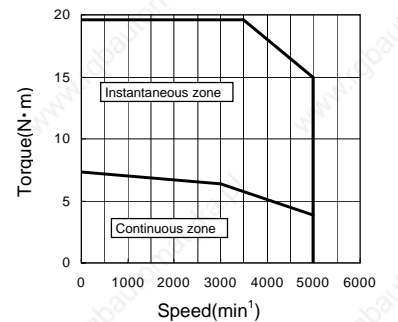

Materials Servo motor data sheet [Characteristics table]

Speed – torque characteristics
Q1AA10250D (2.5kW)

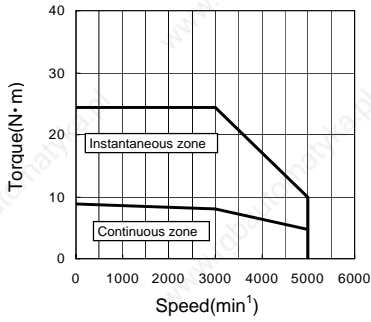

Speed – torque characteristics
Q1AA12100D (1kW)

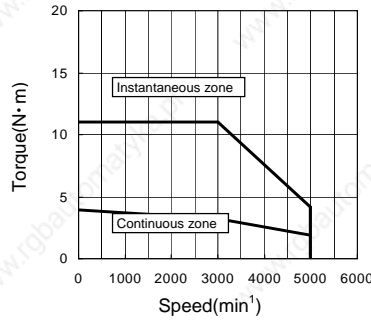

Speed – torque characteristics
Q1AA12200D (2kW)

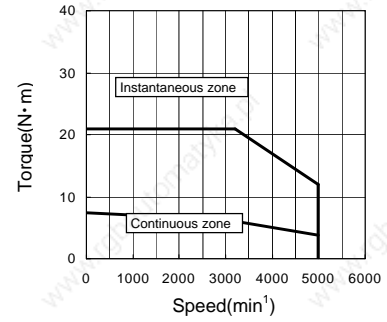

Speed – torque characteristics
Q1AA12300D (3kW)

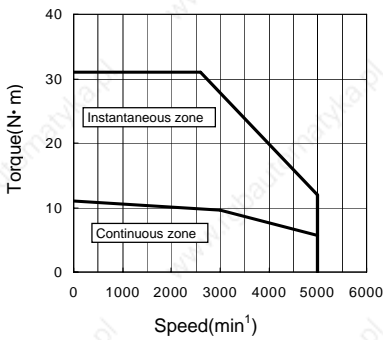

Speed – torque characteristics
Q1AA13300D (3kW)

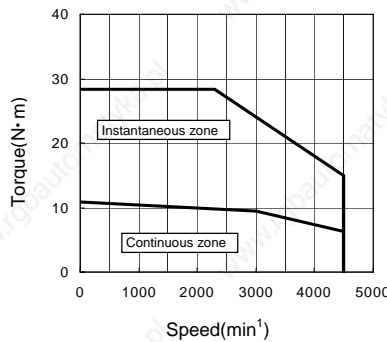

Speed – torque characteristics
Q1AA13400D (4kW)

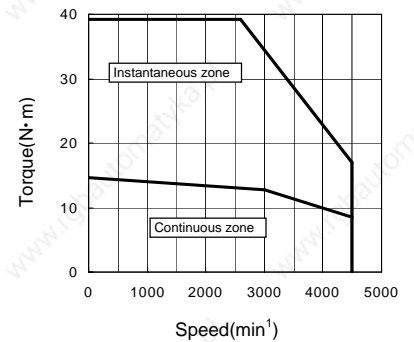

Speed – torque characteristics
Q1AA13500D (5kW)

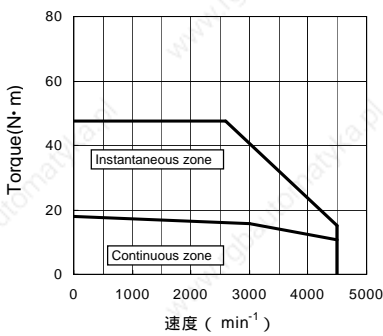

Speed – torque characteristics
Q1AA18450M (4.5kW)

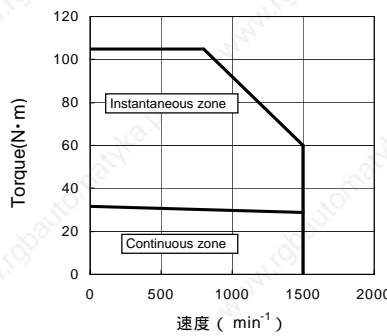

Speed – torque characteristics
Q 1 A A 1 8 7 5 0 H (7.5kW)

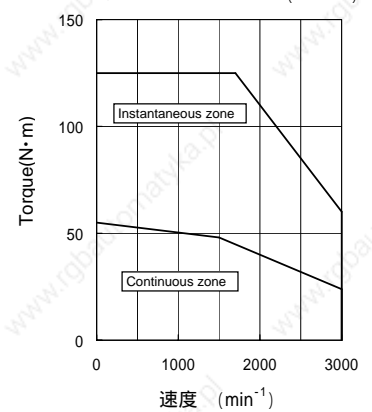

Materials Servo motor data sheet [Characteristics table]

Q1EA Motor speed-torque characteristics indicate the values in combination with operation amplifier for single phase when amplifier power supply is AC100V. Instant domain decreases when amplifier power supply is below 100V.

Speed – torque characteristics
Q1EA04003D (30W)

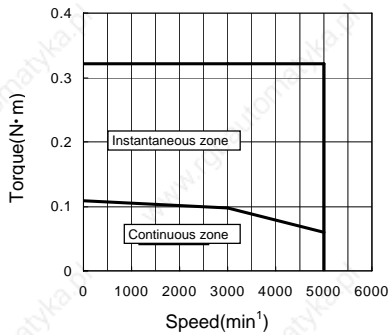

Speed – torque characteristics
Q1EA04005D (50W)

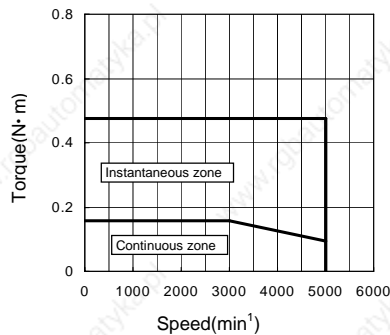

Speed – torque characteristics
Q1EA04010D (100W)

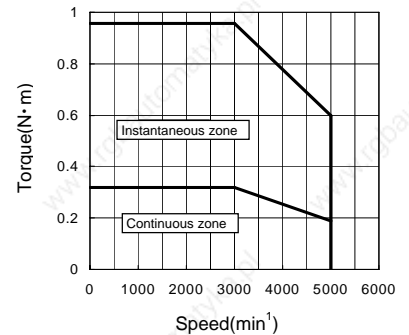

Speed – torque characteristics
Q1EA06020D (200W)

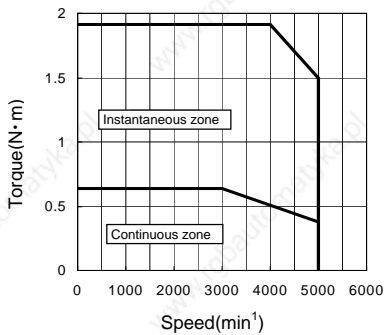

Q2AA Motor speed-torque characteristics indicate the values in combination with operation amplifier for 3 phase when amplifier power supply is AC 200V. Instant domain decreases when amplifier power supply is below 200V.

Speed – torque characteristics
Q2AA04006D (60W)

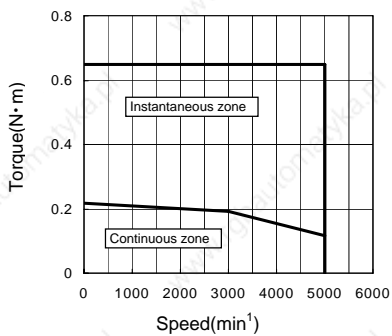

Speed – torque characteristics
Q2AA04010D (100W)

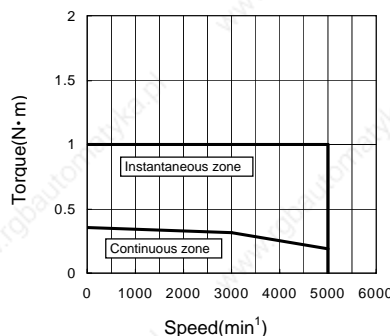

Speed – torque characteristics
Q2AA05005D (50W)

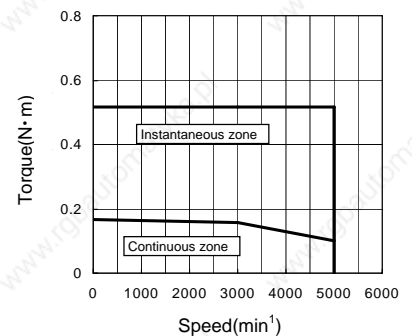

Speed – torque characteristics
Q2AA05010D (100W)

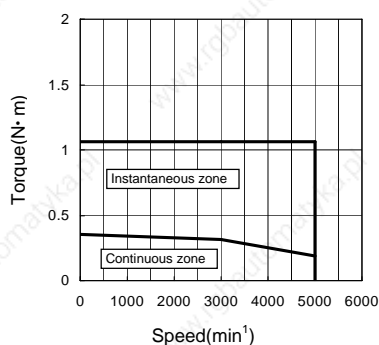

Speed – torque characteristics
Q2AA05020D (200W)

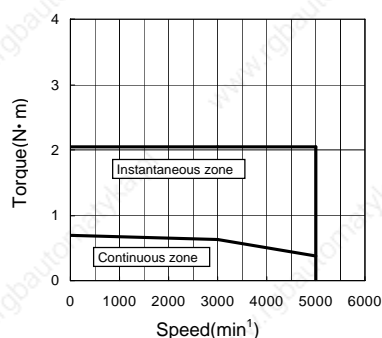

Speed – torque characteristics
Q2AA07020D (200W)

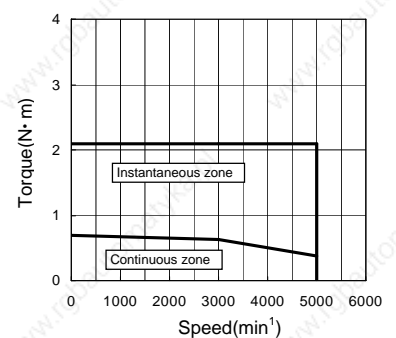

Materials Servo motor data sheet [Characteristics table]

Speed – torque characteristics
Q2AA07030D (300W)

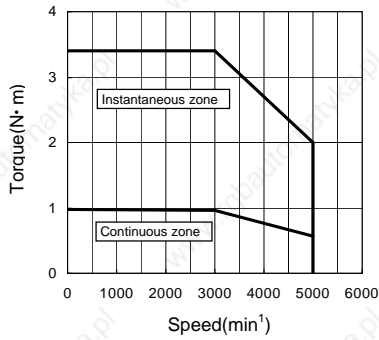

Speed – torque characteristics
Q2AA07040D (400W)

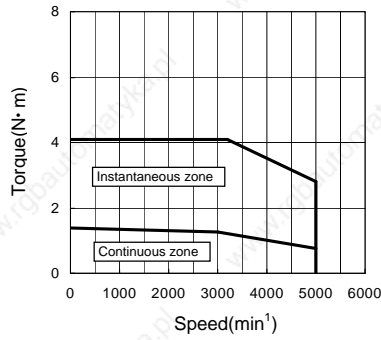

Speed – torque characteristics
Q2AA07050D (500W)

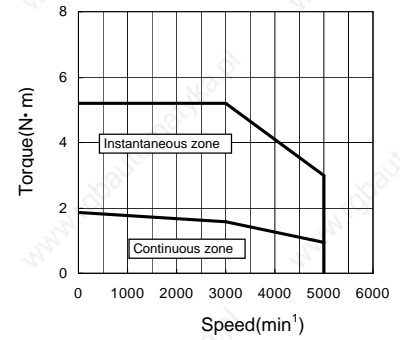

Speed – torque characteristics
Q2AA08050D (500W)

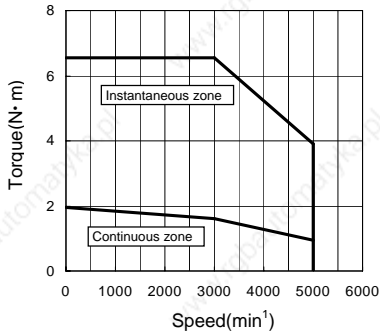

Speed – torque characteristics
Q2AA08075D (750W)

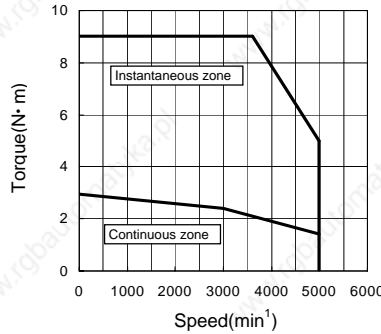

Speed – torque characteristics
Q2AA08100D (1kW)

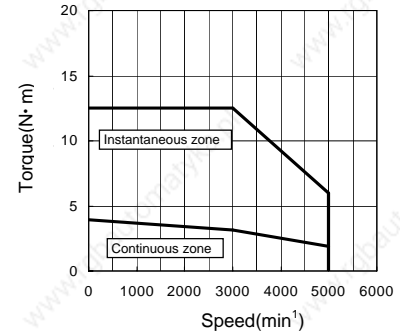

Speed – torque characteristics
Q2AA10100H (1kW)

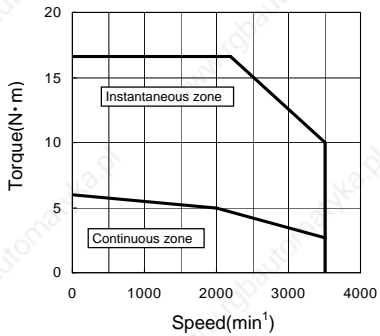

Speed – torque characteristics
Q2AA10150H (1.5kW)

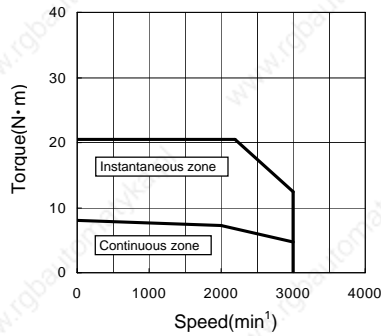

Speed – torque characteristics
Q2AA13050H (500W)

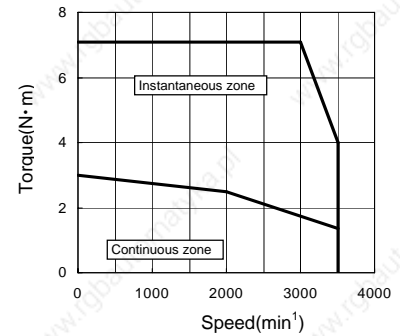

Speed – torque characteristics
Q2AA13100H (1kW)

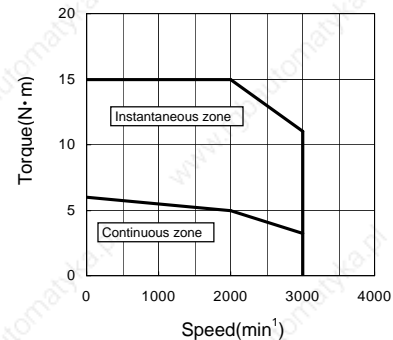

Speed – torque characteristics
Q2AA13150H (1.5kW)

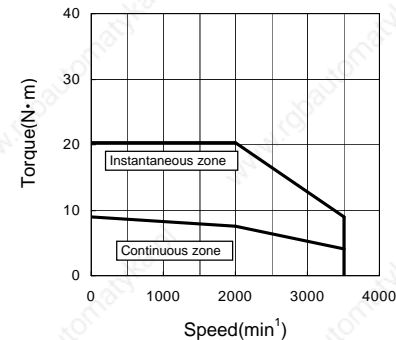

Speed – torque characteristics
Q2AA13200H (2kW)

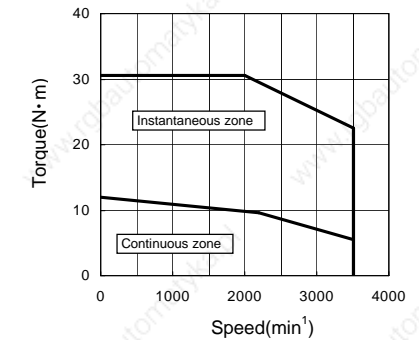

Materials Servo motor data sheet [Characteristics table]

Speed – torque characteristics
Q2AA18200H (2kW)

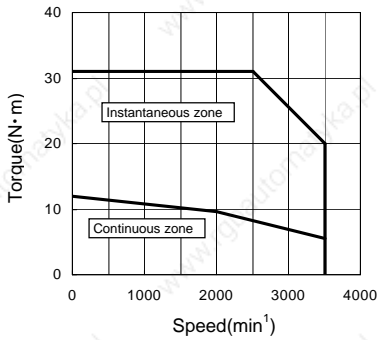

Speed – torque characteristics
Q2AA18350H (3.5kW)

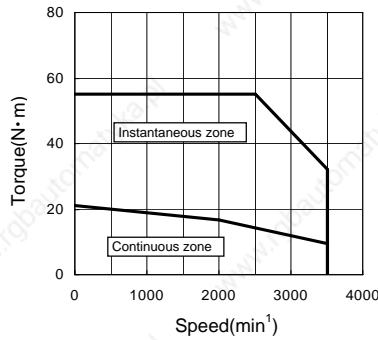

Speed – torque characteristics
Q2AA18450H (4.5kW)

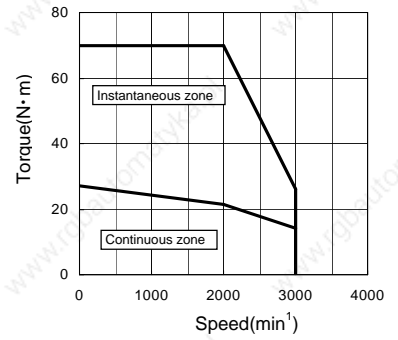

Speed – torque characteristics
Q2AA18550R (5.5kW)

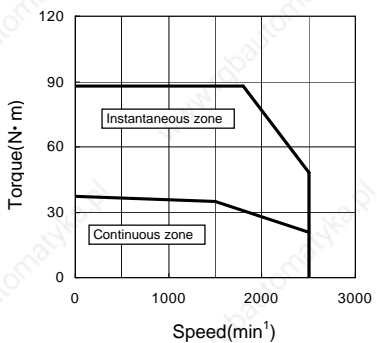

Speed – torque characteristics
Q2AA22250H (2.5kW)

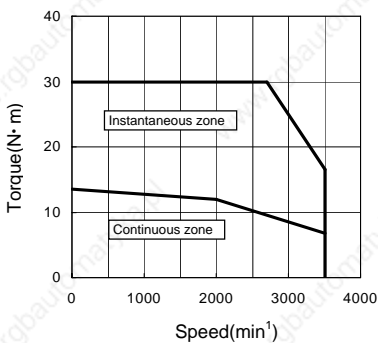

Speed – torque characteristics
Q2AA22350H (3.5kW)

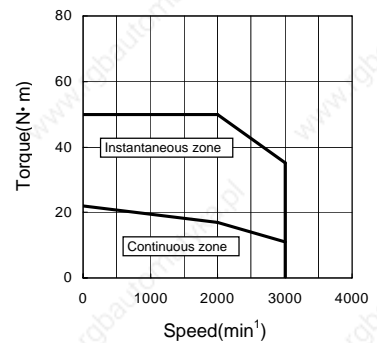

Speed – torque characteristics
Q2AA22450R (4.5kW)

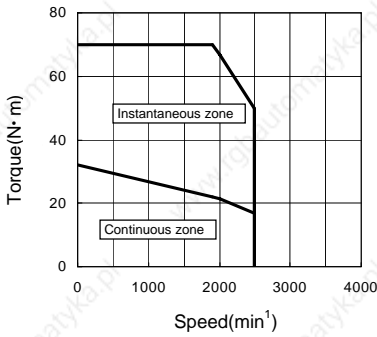

Speed – torque characteristics
Q2AA22550B (5.5kW)

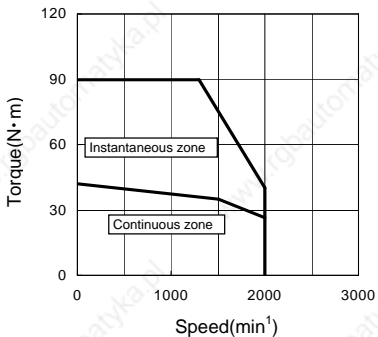

Speed – torque characteristics
Q2AA22700S (7kW)

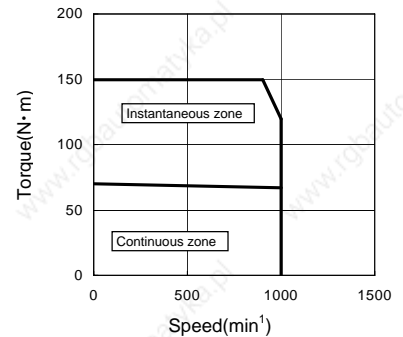

Speed – torque characteristics
Q2AA18550H (5.5kW)

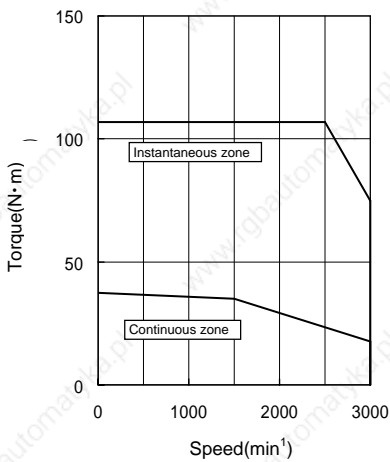

Speed – torque characteristics
Q2AA18750L (7.5kW)

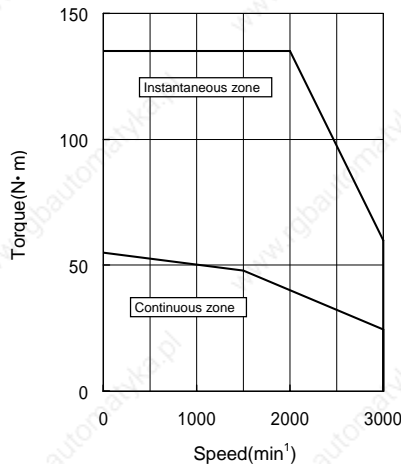

Speed – torque characteristics
Q2AA2211KV (11kW)

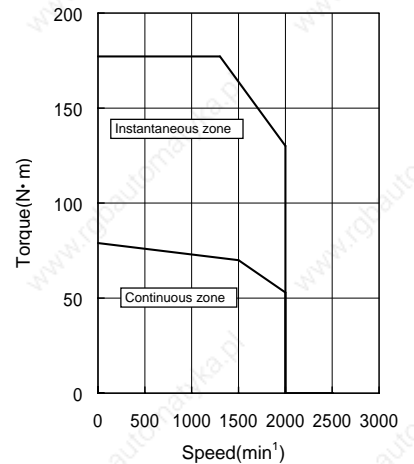

Materials Option

[Metal mounting fittings]

Input-output connector

Connector table for AC 200V input type

Application	Model number	Contents	Manufacturer	Manufacturer's model number
Single connector	AL-00385594	CN1 Plug and housing	Sumitomo 3M Ltd.	10150-3000VE 10350-52A0-008
	AL-00385596	CN2 Plug and housing	Sumitomo 3M Ltd.	10120-3000VE 10320-52A0-008
	AL-00329461-01	CNA plug	Phoenix Contact Co. Ltd.	MSTB2.5/5-STF-5.08
	AL-Y0000988-01	CNB plug	Phoenix Contact Co. Ltd.	IC2.5/6-STF-5.08
	AL-00329458-01	CNC plug	Phoenix Contact Co. Ltd.	IC2.5/3-STF-5.08
Low voltage circuit Connector set	AL-00292309	CN1,CN2 plug and housing	Sumitomo 3M Ltd.	10150-3000VE
				10350-52A0-008
				10120-3000VE
Low voltage circuit Connector set	AL-00416792	CNA,CNB,CNC plug	Phoenix Contact Co. Ltd.	10320-52A0-008
				MSTB2.5/5-STF-5.08
Amplifier capacity RS1 01 ~ RS1 05 Standard set	AL-00393603	CN1,CN2 plug and housing CNA,CNC plug	Sumitomo 3M Ltd. Phoenix Contact Co. Ltd.	IC2.5/3-STF-5.08
				10150-3000VE
				10350-52A0-008
				10120-3000VE
				10320-52A0-008
Amplifier capacity RS1 10,RS1 15 RS1 30 Standard set	AL-00292309	CN1,CN2 plug and housing	Sumitomo 3M Ltd.	MSTB2.5/5-STF-5.08
				IC2.5/3-STF-5.08
				10150-3000VE
				10350-52A0-008
				10120-3000VE
				10320-52A0-008

* CNB is installed in the servo amplifier. It is not included in the high-voltage circuit connector set.

AC100V input type

Application	Model number	Contents	Manufacturer	Manufacturer's model number
Single connector	AL-00329461-02	CNA plug	Phoenix Contact Co. Ltd.	MSTB2.5/4-STF-5.08
Amplifier capacity RS1 01 ~ RS1 03 Standard set	AL-00492384	CN1,CN2 plug and housing CNA,CNC plug	Sumitomo 3M Ltd. Phoenix Contact Co. Ltd.	10150-3000VE
				10350-52A0-008
				10120-3000VE
				10320-52A0-008
				MSTB2.5/4-STF-5.08
				IC2.5/3-STF-5.08

Setup software communication cable

Model number	Remarks
AL-00490833-01	Dedicated cable

Materials Option

[Metal mounting fittings]

Metal mounting fittings

The servo amplifiers of RS 01,RS 03,RS 05 have metal mounting fittings of old compatible (PY2 series) available.

Metal mounting fittings table for RS 01~05

Servo amplifier model number	Mounting Position	Model	Contents
RS1 01	Front	AL-00582788-01	Fitting metals: 1 Tightning screw: 6
RS1 03	Front	AL-00582789-01	Fitting metals: 1 Tightning screw: 2
RS1 01, RS1 03	Back	AL-00582791-01	Fitting metals: 1 Tightning screw: 2
RS1 05	Front	AL-00582790-01	Fitting metals: 1 Tightning screw: 6
	Back	AL-00582792-01	Fitting metals: 1 Tightning screw: 2

Metal mounting fittings of this option employ three-number chromate plating treatment.

(Surface color : It is different from blue-silver/body color.)

AL-00582788-01

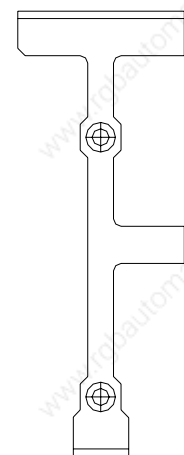
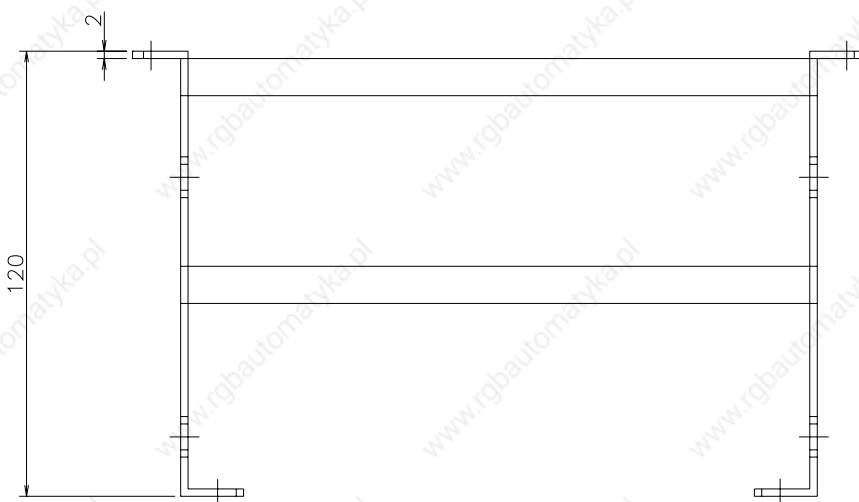

Materials Option

[Metal mounting fittings]

AL-00582789-01

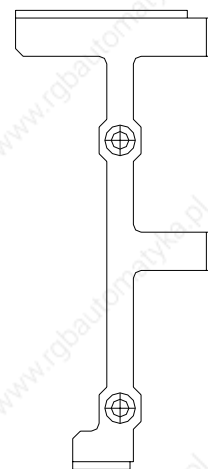
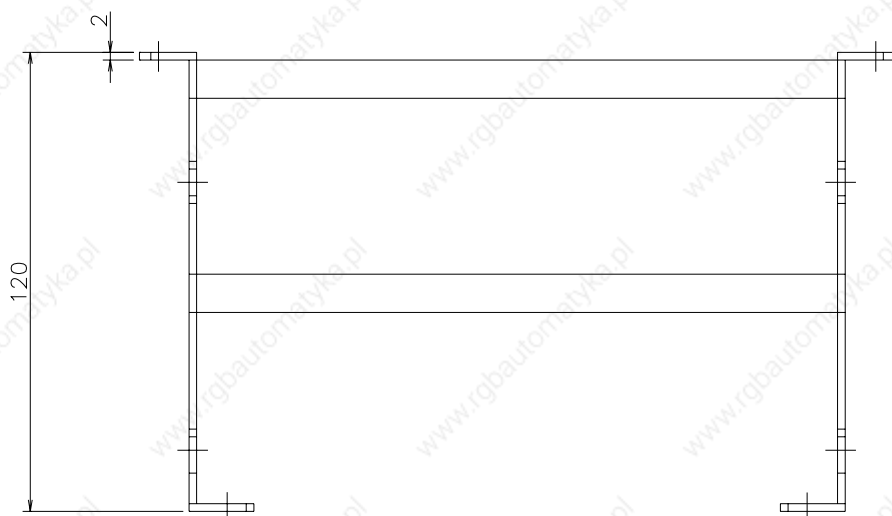
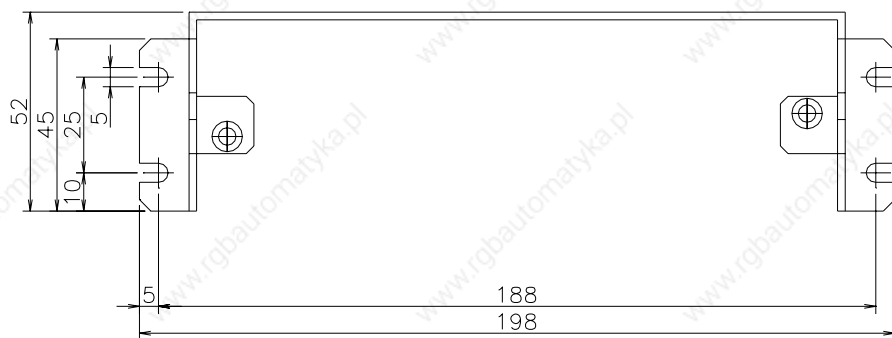

AL-00582791-01

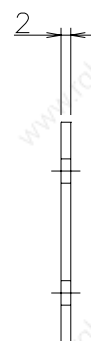

Materials Option

[Metal mounting fittings]

AL-00582790-01

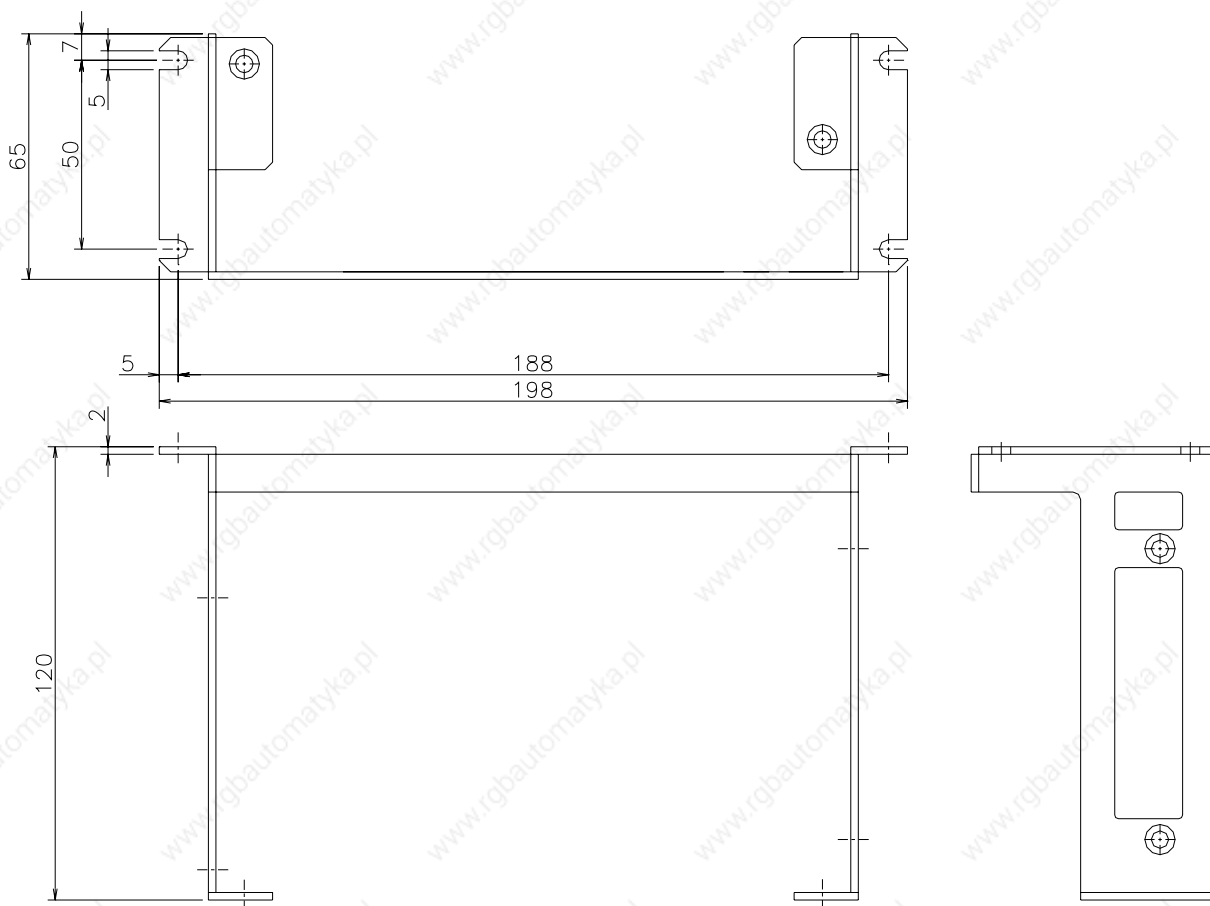

AL-00582792-01

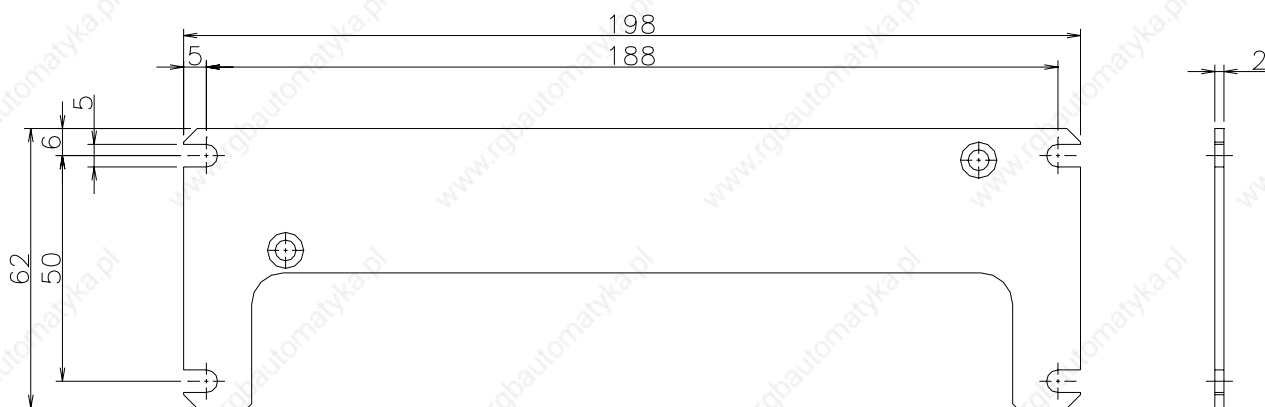

Materials Option

[Monitor Box]

Monitor box

Monitor box and dedicated cable

Model number	Remarks
Q-MON-1	Monitor box + Dedicated cables (2 cables)

Two dedicated cables blow come with this monitor box.

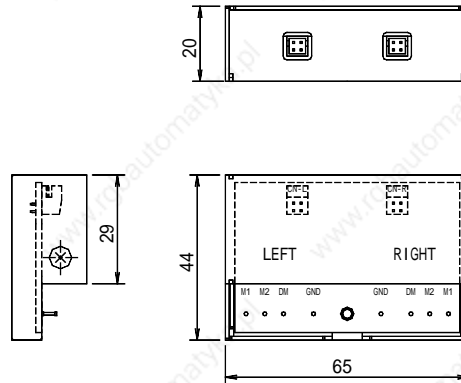

Dedicated cables

Model number	Remarks
AL-00496726-01	Dedicated cables (2 cables)

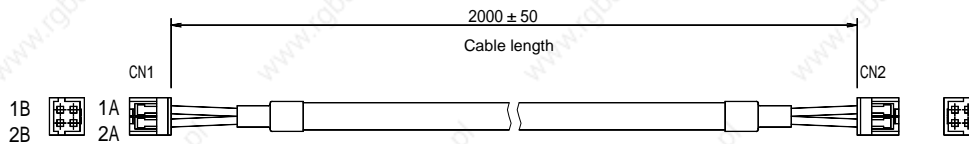

Terminal name	Function
1A	Analog monitor 1
1B	Analog monitor 2
2A	GND
2B	Digital monitor

	Manufacturer mdel number	Manufacturer
Connector	LY10-DC4	Japan Aviation Electronics Industry, Ltd.
Contact	LY10-C1-1-10000	Japan Aviation Electronics Industry, Ltd.

Materials Option

[Lithium battery · EMCKit]

Lithium battery

Model number	Remarks
AL-00494635-01	E R 3 V L Y

Mass : 0.02kg

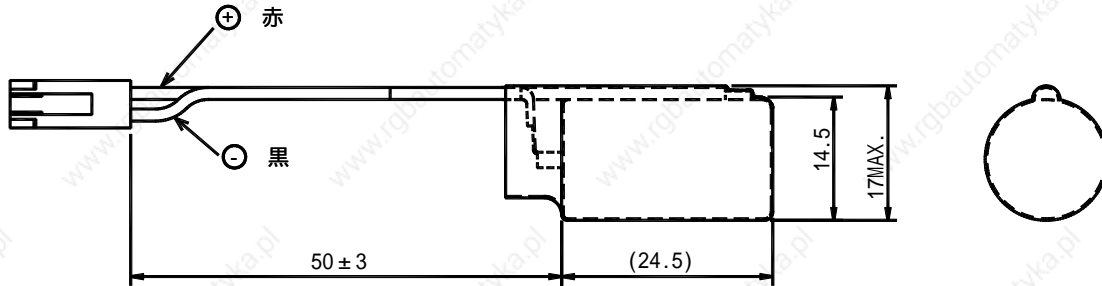

	Manufacturer model number	Manufacturer
Connector	IL-2S-S3L-(N)	Japan Aviation Electronics Industry, Ltd.
Contact	IL-C2-1-10000	Japan Aviation Electronics Industry, Ltd.
Battery	ER3VLY	Toshiba Battery Co., Ltd.

E M C countermeasure kit

Model number	Remarks
AL-00508115	Noise filter: 3SUP-HK30-ER-6B
	Toroidal core: 251-211

Model number : 3 S U P - H K 3 0 - E R - 6 B

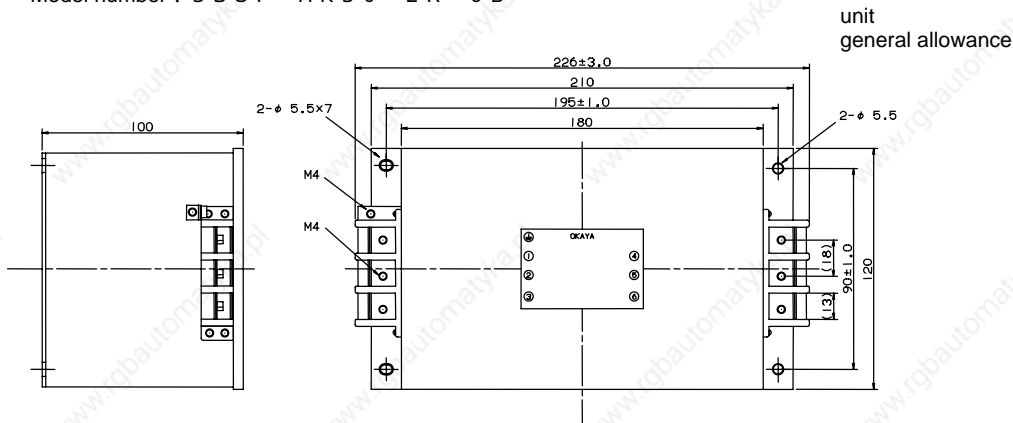

Mass : 2.5kg

Model number : 2 5 1 - 1 1

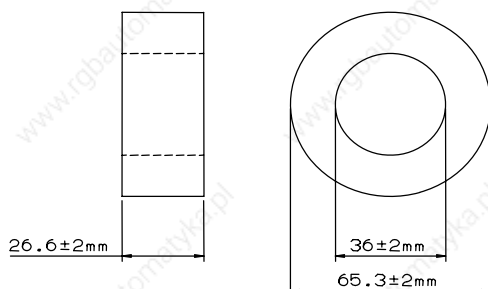

Mass : 0.3kg

Materials Encoder clear [Encoder clear/ reset method]

Encoder clear / Alarm reset method

'Encoder clear / alarm reset method' vary according to the sensor you use. Any alarms will not be reset under the procedure of the list below unless any alarm factors are removed by correction.

Asynchronous sensor

Alarm code	Name	Sensor type	Encoder clear and alarm reset method	
A 2	Battery abnormal	PA035C	After'Encoder clear input'	'Alarm reset input'
		RA062C		
A 3	Sensor overheat	PA035C	'Alarm reset input'	
		RA062C		
A 5	Abnormal encoder 3	PA035C	Power restoration	
		RA062C		
A 6	Abnormal encoder 4	PA035C	Power restoration	
		RA062C		
A 7	Abnormal encoder 5	PA035C	Power restoration	
		RA062C		
A 8	Abnormal encoder 6	PA035C	Power restoration	
		RA062C		
A 9	Encoder failure	PA035C	Power restoration	
		RA062C		
B 3	Numerous rotation abnormal	PA035C	Power restoration	
		RA062C		
B 4	One rotation abnormal	PA035C	Power restoration	
		RA062C		
B 5	Over speed / Numerous rotation abnormal	PA035C	After'Encoder clear input'	'Power restoration'
		RA062C		
B 6	Memory abnormal	PA035C	After'Encoder clear input'	'Power restoration'
		RA062C		
B 7	Acceleration abnormal	PA035C	After'Encoder clear input'	'Power restoration'
		RA062C		

Manchester sensor / Encoder

Alarm code	Name	Sensor type	Encoder clear and alarm reset method	
A 1	Encoder abnormal 1	RA062M	Power restoration	
		ABS - E	After'Encoder clear input'	'Alarm reset input'
A 2	Battery abnormal	RA062M	Power restoration	
		ABS - E	After'Encoder clear input'	'Alarm reset input'

How to use electronic gear

This has a function which can set up the servo motor travel distance equivalent to position command pulse in accordance with the device.

For example : Set-up method when wiring-saving incremental encoder 2 0 0 0 [P/R] is used.

Encoder pulse number equivalent of one rotation of servo motor is $2\ 0\ 0\ 0\ [P/R] \times 4\ \text{times}$ = $8\ 0\ 0\ 0\ [P/R]$

Feed of command input pulse necessary to revolve once or move one revolution is $8\ 0\ 0\ 0\ [P/R]$ then,

Frequency of command input pulse necessary to operate the servo motor at $4\ 8\ 0\ 0\ \text{min}^{-1}$ under this condition can be sought by the equation below.

$f = \frac{N}{60} \times \text{Encoder pulse } [P/R] \times 4\ \text{times}$	f = Frequency of input pulse N = Revolution number to operate servo motor
--	--

Frequency of the command input pulse necessary to operate the servo motor at $4\ 8\ 0\ 0\ \text{min}^{-1}$ under the above condition is $6\ 4\ 0\ \text{kH z}$.

If operation is possible under this condition, set-up value of electronic gear will be 1/1.

- | | |
|--|--------------------------|
| • Set-up value of electronic gear | : $1 / 1$ |
| • Command input pulse feed per servo motor rotation | : $8\ 0\ 0\ 0\ [P/R]$ |
| • Frequency of command input pulse necessary to operate the servo motor at $4\ 8\ 0\ 0\ \text{min}^{-1}$ | : $6\ 4\ 0\ \text{kH z}$ |

If it cannot be used under the above condition



For example

You want to make command input pulse feed per servo motor revolution $5\ 0\ 0\ [P/R]$

Encoder pulse number equivalent of servo motor revolution is $2\ 0\ 0\ 0\ [P/R] \times 4\ \text{times}$ = $8\ 0\ 0\ 0\ [P/R]$.

Command input pulse feed necessary to revolve servo motor once or move one revolution at this time is $5\ 0\ 0\ [P/R]$.

However, command input pulse feed must be $5\ 0\ 0\ [P/R]$.

$$\frac{8\ 0\ 0\ 0}{5\ 0\ 0} = \frac{1\ 6}{1} \text{ times are necessary.}$$

If set-up value of electronic gear is made to be $1\ 6 / 1$, command input pulse feed will be $5\ 0\ 0\ [P/R] \times \frac{1\ 6}{1}$ = $8\ 0\ 0\ 0\ [P/R]$

- | | |
|--|---|
| • Set-up value of electronic gear | : $1\ 6 / 1$ |
| • Command input pulse feed per servo motor rotation | : $5\ 0\ 0\ [P/R]$ |
| • Frequency of command input pulse necessary to operate the servo motor at $4\ 8\ 0\ 0\ \text{min}^{-1}$ | $6\ 4\ 0\ \text{kH z} / (1\ 6 / 1)$: $4\ 0\ \text{kH z}$ |

Materials Shortened Model Number [Set-up Contents]

Set-up contents of shortened model number

System parameter when shortened model number is shipped

In the case of RS1A, RS1B, RS1L, RS1M

Page	Name	Set-up value					
		RS1 01A*	RS1 03A*	RS1A 05A*	RS1A 10A*	RS1 15A*	RS1 30A*
-	Amplifier capacity	15_Ampere	30_Ampere	50_Ampere	100_Ampere	150_Ampere	300_Ampere
-	Motor structure	Rotary_Motor					
-	Control power input voltage	200V Class					
-	Control power input class	AC Single-Phase					
-	Main circuit power input class	200V Class					
00	Main circuit power input class	00:_AC_3-Phase					
01	Motor encoder type	If * is A or T, 00:_Incremental_ENC If * is H or R, 01:_Absolute_ENC					
02	Incremental encoder function selection	00:_Standard					
03	Incremental encoder resolution	2000					
04	Absolute encoder function selection	If * is A or T, 04:_PA035C-2.5MH_Manu If * is H, 80:_RA062M-1MF. If * is R, 84:_ABS-E.					
05	Absolute encoder resolution	If * is A or T or R, 00:_2048_FMT If * is H, 04:_32768_FMT					
06	Combination motor model number	P50B03003D	P50B07040D	P50B08075D	P60B13200H	P80B22350H	P60B18750R
08	Control mode	01:_Velocity					
09	Position loop control · Position loop encoder selection	If * is A or H or R, 00:_Motor_Encoder If * is T, 01:_Ext-ENC					
0A	External encoder resolution	2000					
0B	Regenerative resistance selection	If is A or B, 02:_External_R If is L or M, 01:_Built-in_R		If is A or B, 01:_Built-in_R If is L or M, 02:_External_R		If is A or B, 02:_External_R There is no setting to L or M.	

System parameter when shortened model number is shipped

In the case of RS1E, RS1F, RS1N, RS1P

Page	Name	Set-up value			
		RS1E01A* RS1F01A*	RS1E03A* RS1F03A*	RS1N01A* RS1P01A*	RS1N03A* RS1P03A*
-	Amplifier capacity	15_Ampere	30_Ampere	15_Ampere	30_Ampere
-	Motor structure	Rotary_Motor			
-	Control power input voltage	100V Class			
-	Control power input class	AC Single-Phase			
-	Main circuit input class	100V Class			
00	Main circuit input class	01:_AC_Single-Phase			
01	Motor encoder type	If * is A or T, 00:_Incremental_ENC If * H or R, 01:_Absolute_ENC			
02	Incremental encoder function selection	00:_Standard			
03	Incremental encoder resolution	2000			
04	Absolute encoder function selection	If * is A or T, 04:_PA035C-2.5MH_Manu If * is H, 80:_RA062M-1MF If * is R, 84:_ABS-E			
05	Absolute encoder resolution	00:_2048_FMT			
06	Combination motor model number	P50B03003P	P50B05020P	P50B03003P	P50B05020P
08	Control mode	01:_Velocity			
09	Position loop control · Position loop encoder selection	If * is A or H or R, 00:_Motor_Encoder If * is T, 01:_Ext-ENC			
0A	External encoder resolution	2000			
0B	Regenerative resistance selection	02:_External_R		01:_Built-in_R	

A

Abandonment	5
Absolute encoder clear function	7-38
Absolute position data output circuit	3-15
Acceleration time	5-15, Materials-1
Adjustment method of disturbance observer	7-5
Adjustment method of high setting control	7-6
Adjustment method of notch filter	7-5
Adjustment method of vibration suppressing control	7-5
Adjustment mode(Digital operator)	4-11
Alarm history clear method(Digital operator)	4-13
Alarm list	8-4
Alarm reset function	7-26
Alarm reset sequence	6-12
Alarm sequence	6-11
Alarm table	8-3
Alarm trace	4-15
Alarm trace mode(Digital operator)	4-15
Ambient humidity(Servo-motor)	2-4, 9-23
Ambient temperature	2-3, 9-1
Analog input circuit	3-12
Analog monitor	3-16, 5-4, 5-22, 7-39
Analog torque addition function	7-17
Analog torque command input	7-15
Analog velocity (addition) command scaling	7-15
Analog velocity input	3-12
Auto-adjustment mode	4-11
Automatic offset adjustment of torque command	4-11
Automatic offset adjustment of velocity command	4-11

B

Battery input circuit	3-13
Battery space	8-26
Battery warning function	4-4
Built-in regeneration resistor	Materials-7
Brake function and sequence	6-10
Brake operation beginning time(BONBGN)	7-33

C

Calorific value	9-3
CE	Materials-19
Characteristic table(Servo-motor)	Materials-33
Circuit breaker	3-1, 3-19
CN1 connector terminal layout	3-9, 10
CN1, 2 Wire diameter	3-19
CN2 Connector terminal layout	3-17
CN2 terminal layout	3-17
Command polarity reversed	7-7
Command pulse multiplier	5-14
Compliance with EC directive	Materials-20
Confirmation method of regeneration power(Actual operation)	Materials-10
Control board	Materials-20
Control function	9-1
Control mode changed	5-29
Control mode switching function	7-27
Control power wire diameter	3-19
Control system	9-1
Connection method of regenerative resistor	Materials-12
Connection of regenerative resistance	Materials-11
Connector(Option)	3-20
Connector terminal number	3-9
Corrective actions for problems during operation	8-25
CPU software version(Digital operator)	4-15
Current leakage	9-2
Current loop	7-4

D

Data sheet(Servo-motor)	Materials-33
Deceleration time	7-16, Materials-1
Delay time of engaging holding brake(BONDLY)	7-32
Delay time of releasing holding brake(BOFFDLY)	7-33
Deviation clear selection	7-12
Description of test run mode(Digital operator)	4-12
Digital monitor	7-40
Digital operator name	4-1
Dimension(Servo-amplifier)	Materials-23
Directions	1
Dominant mode(Digital operator)	4-1
Dynamic brake action selection	7-31
Dynamic brake constant table	Materials-6
Dynamic brake delay time	Materials-4

E

Electric gear ratio	7-11, Materials-49
Electromagnetism contactor	3-1, 3-19
Elevation	9-1
Emergency stop function(EMR)	7-30
Encoder clear, Alarm reset method	Materials-48
Encoder output pulse divided ratio	7-37
Encoder pulse divided output	7-37
Encoder pulse divided output polarity	7-38
Encoder pulse divided output selection	7-37
Encoder resolution setting	6-5
Encoder signal output format	9-5
Encoder signal phases	9-23
Encoder type setting(INC ABS)	6-5
Environment	2-4, 8-26, 9-1
External dimension of regenerative resistor	Materials-15
External encoder digital filter	7-36
External encoder polarity invert	7-36
External encoder polarity invert function	7-36
External encoder resolution setting	6-5
External error input	7-30
External regenerative resistor combination	Materials-13
External torque limit	7-18

F

FFFIL	5-8, 7-4
FFGN	5-8, 7-4
Following error limit	7-35
Following error warning	7-35
Forced stop operation(EMR)	7-31, 7-33
Free-Run is operated	5-23, 5-25, 7-31
Full-closed	3-18

G

Gain switching function(Adjusting method)	7-6, 7-28
General parameter list	5-1
General specifications	9-1
Generic input circuit	3-14
Generic input signals	5-19, 5-21
Generic output	3-16

H

Holding brake function	5-24
Holding brake specifications	9-26
Holding brake excitation signal and sequence	6-10
How to replace absolute encoder back-up battery	8-26
How to set the system parameter mode(Digital operator)	4-14

I

Inposition/Position deviation monitor	7-11
Incoming current	9-2
Incremental encoder digital filter	7-36
Incremental pulse signal output circuit	3-15
In-Position near range	7-21
Input key function(Digital operator)	4-1
Input/Output connector(Optional)	3-1, Materials-42
Input power	9-1
In-Rush current preventing	6-10, 6-12
Installation and wiring	6-3
Installation metal fittings	Materials-43
Instantaneous load tolerance dynamic brake	Materials-5
Interpretation of servo amplifier model number	1-3, 1-5
Interpretation of servo motor model number	1-2
Internal torque limit function	7-18
International standards file number	Materials-17, 18

J

JOG driving (Servo-motor)	6-1
JOG operation	6-7
JRAT	7-5

K

KP	7-4
KV	7-4

L

Line driver output circuit	3-13, 7-8
List of monitors display(Monitor)	7-40
Load inertia ratio	7-5
Low speed range	7-23

M

Main power discharge function	7-30
Main power input	5-28
Main power wire diameter	3-19
Maintenance	8-1
Mass(Servo-amplifier)	9-1
Materials dimension(Servo-motor)	Materials-29
Mechanical specifications	9-24
Mechanical strength(Servo-motor)	9-25
Method of editing parameter (Digital operator)	4-8
MODE YEY(Digital operator)	4-1
Monitor box	Materials-46
Monitor mode(Digital operator)	4-4
Monitor table	1-4
Motor-Free is operated	7-31
Mounting method(Servo-amplifier)	2-3
Mounting method(Servo-motor)	2-4

N

NEAR	7-21
Noise filter	Materials-21, 22
Noise processing	Materials-20
Notch filter tuning	5-7, 7-5

O

Oil seal	9-25
Open collector circuit	3-13, 7-8, 7-37
Operation sequence	6-10
Option	Materials-42
Option external regenerative resistor	Materials-11
Origin Z phase output circuit	3-15
Overload warning	7-35
Over travel function	7-25

P

Packaged wiring diagram	3-1
Parameter list	5-1
Parameter saved(Auto tuning)	7-3
Parts overhaul	8-25
Password function	4-16
PCFIL	7-4, 5-7
Peripherals	3-19
Permitted repetitions	Materials-1
Photo coupler input	3-14, 3-16
Position command input circuit	3-13
Position command maximum input pulse frequency	9-1
Position command pulse	7-8
Position command pulse count polarity	7-9
Position command pulse digital filter	7-9
Position command pulse inhibit function	7-27
Position command pulse input circuit	3-13
Position command timing	5-14
Position deviation clear	5-14
Positioning method	7-11
Position loop control and encoder selection	5-29
Position loop proportional control switching function	7-29
Position signal output	3-15
Position signal pulse output	9-4
Position signal Serial output(Absolute encoder with request)	9-16
Position signal Serial output(Incremental absolute encoder)	9-11
Position signal Serial output(Incremental encoder)	9-21
Position signal Serial output(Wired-saving absolute encoder)	9-5
Power capacity	3-19
Power failure detection delay time function	7-34
P-PI Automatic change function	7-29
Preset velocity compensation command	7-13, 7-15
Procedure until driving	6-1
Product verification	1-1
Proportional control	7-29
Protection function of regenerative resistor	Materials-14
Protective circuit	3-7
Protective grounding wire	1-7, 3-19
Pulse output	9-4

Q

R

Radial	2-8
Recommended prevention components(EMC)	Materials-47
Regenerative energy is computational method	Materials-8
Regeneration process	Materials-7
Regenerative overload warning status	4-4, 5-21
Rotation direction specification	9-23

S

Safety Precautions	1
Selection	Materials-1
Semi-closed	3-17, 7-37
Serial output	9-5, 9-11, 9-16, 9-21
Servo adjustment parameters	7-4
Servo amplifier part names	1-7
Servo-Braking is performed	5-23, 6-11, 7-20, 7-25, 7-31
Servo-motor general specification	9-23
Servo motor stop operation	7-25, 7-31
SERVO-ON Function	5-18, 7-26
Servo system structure	7-4
Setting the positioning completion signal	7-22
Shock	9-1, 9-24
Shock resistance(Servo-motor)	9-24
Shorted model number(Servo-amplifier)	Materials-50

Index

Alphabetical order

Size of electric wire	3-19
Speed command voltage	9-1
Speed matching width	7-23
Speed transport settings	7-23
Status display mode(Digital operator)	4-3
Storage humidity	9-1
Storage temperature	9-1
Surge protector	3-1,3-19
Structure of tuning	7-1
System parameter	5-6

T

TCFIL	5-8,7-5
TCONFIL/A/B	5-9
Thrust load	2-8
Toroidal core	Materials-22
Torque command input impedance	9-1
Torque command voltage	9-1
Torque compensation function	7-17
Torque limit function	7-18
Torque limit at sequence operation	7-20
Trouble shooting when alarm rings	8-1
Tuning method selecting procedure	7-2
TVI	5-8,7-5
TUV	Materials-17

U

UL	Materials-17
----	--------------

V

VCFIL	5-8,7-4
Velocity command Acceleration time constant	7-16
Velocity command deceleration time constant	7-16
Velocity command zero clamp function	7-27
Velocity compensation addition function	7-15
velocity input impedance	3-12,9-1
Velocity limit	7-16
Velocity loop	7-4
Velocity loop proportional control switching function	7-29
Velocity-Torque characteristic	Materials-37
Vibration classification(Servo-motor)	9-23
Vibration resistance(Servo-motor)	9-24
Vibration(Servo-amplifier)	9-1
Vibration suppressor frequency select	7-28

W

Working accuracy(Servo-motor)	9-24
-------------------------------	------

X

Y

Z

Precautions For Adoption

Cautions

The possibility of moderate or minor injury and the occurrence of physical damage are assumed when the precautions at right column are not observed. Depending on the situation, this may cause serious consequences. Be sure to follow all listed precautions.

Cautions

- Be sure to read the instruction manual before using this product.
- Take sufficient safety measures and contact us before applying this product to medical equipment that may involve human lives.
- Contact us before adapting this product for use with equipment that could cause serious social or public effects.
- The use of this product in high motion environments where vibration is present, such as in vehicles or shipping vessels, is prohibited.
- Do not convert or modify any equipment components.

* Please contact our Business Division for questions and consultations regarding the above.

SANYO DENKI CO., LTD.

1-15-1, Kita-otsuka Toshima-ku Tokyo 170-8451, JAPAN

<http://www.sanyodenki.com>

(North America area) Phone: +81 3 3917 2223
(Europe area) Phone: +81 3 3917 5157
(Asia area) Phone: +81 3 3917 2814

TAIWAN BRANCH

Room 1208, 12F, No.96 Chung Shan N, Rd., Sec.2, Taipei 104, Taiwan, R.O.C.

Phone:+886 2 2511 3938

HONG KONG BRANCH

1109, 11F New East Ocean Centre, 9 Science Museum Road, TST East, Kowloon, Hong Kong

Phone:+852 2312 6250

SHANGHAI BRANCH

Room 2116, Bldg B, FAR EAST INTERNATIONAL PLAZA, No.317 Xianxia Rd., Shanghai 200051, China

Phone:+86 21 6235 1107

SANYO DENKI AMERICA, INC.

468 Amapola Avenue Torrance, California 90501 U.S.A.

Phone:+1 310 783 5400

SANYO DENKI EUROPE SA.

P.A. PARIS NORD II 48 Allee des Erables-VILLEPINTE BP.50286 F-95958 ROISSY CDG CEDEX France

Phone:+33 1 48 63 26 61

Automation Intelligence, Inc.

2855 Premiere Parkway, Suite A, Duluth, Georgia 30097 U.S.A.

*Remarks : Specifications Are Subject To Change Without Notice.