

ISA-PLAN® - Precision resistors

TECHNICAL DATA	
Resistance values	0.5 mOhm - 1 Ohm
Tolerance	0.5 %* , 1 % , 5 %
Temperature coefficient	< 30 ppm/K (20 °C to 60 °C); > R010
Applicable temperature range	-55 °C to +125 °C
Load capacity	3 W / 10 W (on a heatsink)
Thermal resistance to ambient (R_{th})	< 15 K/W
Thermal resistance to aluminium substrate (R_{thi})	< 3 K/W < 6 K/W for $R < 2$ mOhm
Dielectric withstanding voltage	500 V AC
Inductance (100 mOhm)	< 10 nH
Stability (Nominal load) deviation T_K = Terminal temperature	< 0.5 % after 2000 h ($T_K = 70$ °C)

* upon request

FEATURES

- Up to 10 W
- 4-terminal-connection of the resistor
- High pulse power rating 2 J for 10 ms
- Excellent long term stability

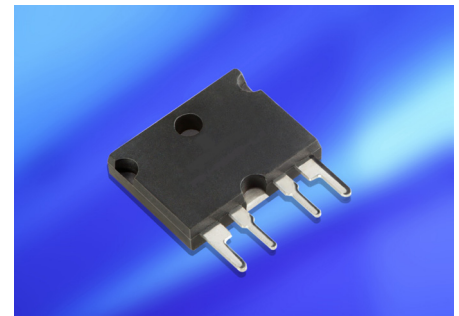

APPLICATION

- Power modules
- frequency converters
- Switch mode power supplies

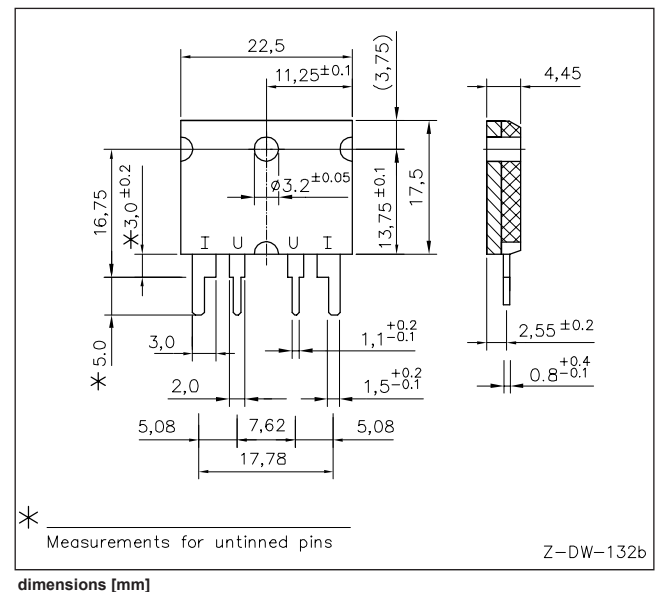

TCR, power derating and long term stability

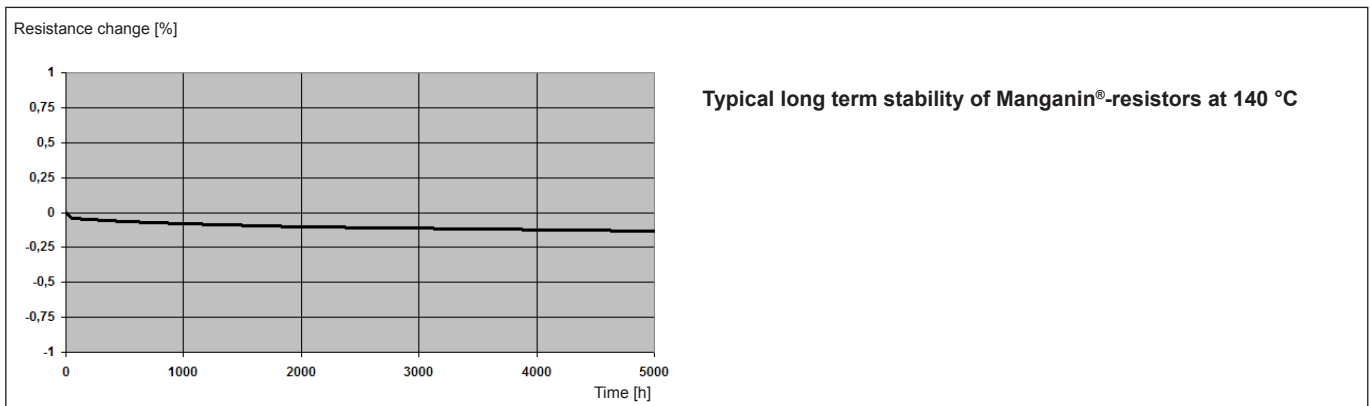
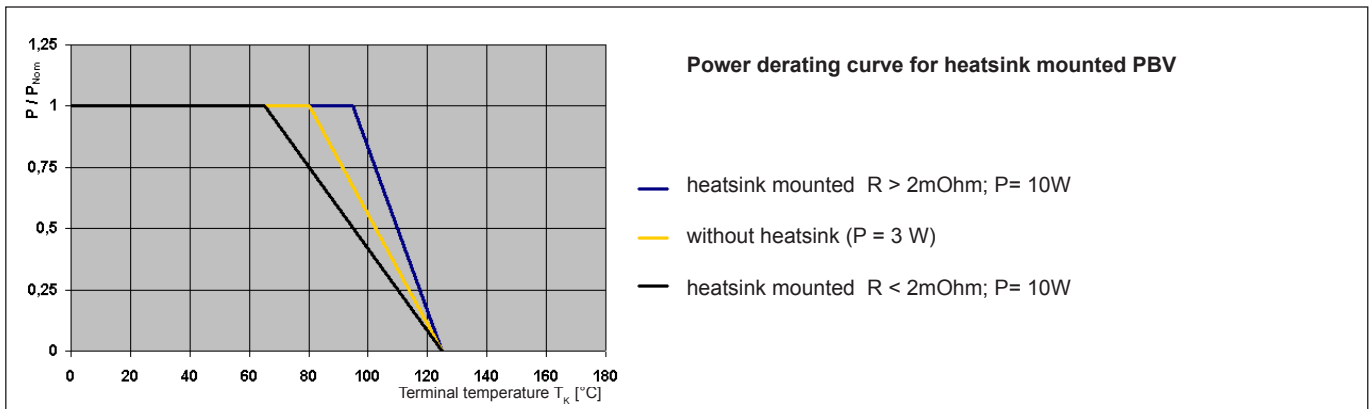
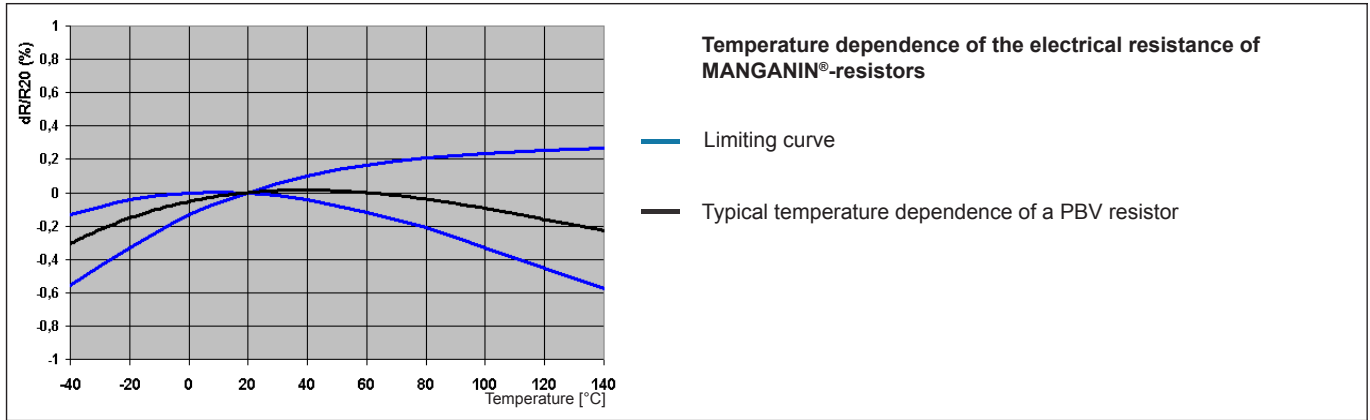

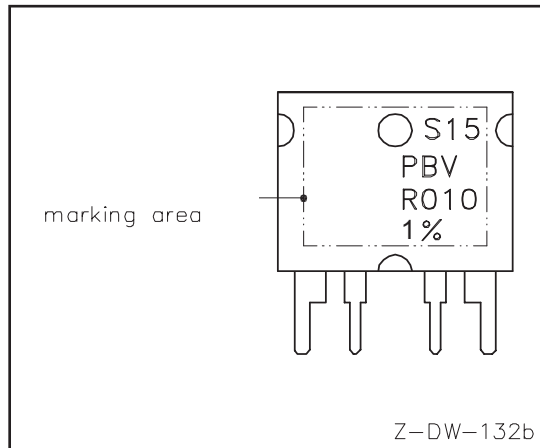
Marking

Assembly instruction

Max. allowed torque for M3 screws

1 Nm

Recommended solder profile

Wave soldering

Temperature [°C]	260	255	217
Time [s]	peak	40	90

PACKAGING INFORMATION

Tube	
Parts per tube	25 pieces

ORDERING CODE
PBV-R001-F1-1.0

Type	Resistance value	Terminal	Tolerance
PBV	1 mOhm	F1	1.0 %

RoHS 2002/95/EC compliance since 01.05.2005

 For more information please visit our website:
www.isabellenhuetten.de
Warranty

All information regarding the suitability, workability and applicability of our products, all technical advice and other information are provided to the best of our knowledge and belief, but shall not discharge the buyer from his own examinations and tests.

Maximum pulse energy respectively pulse power for continuous operation

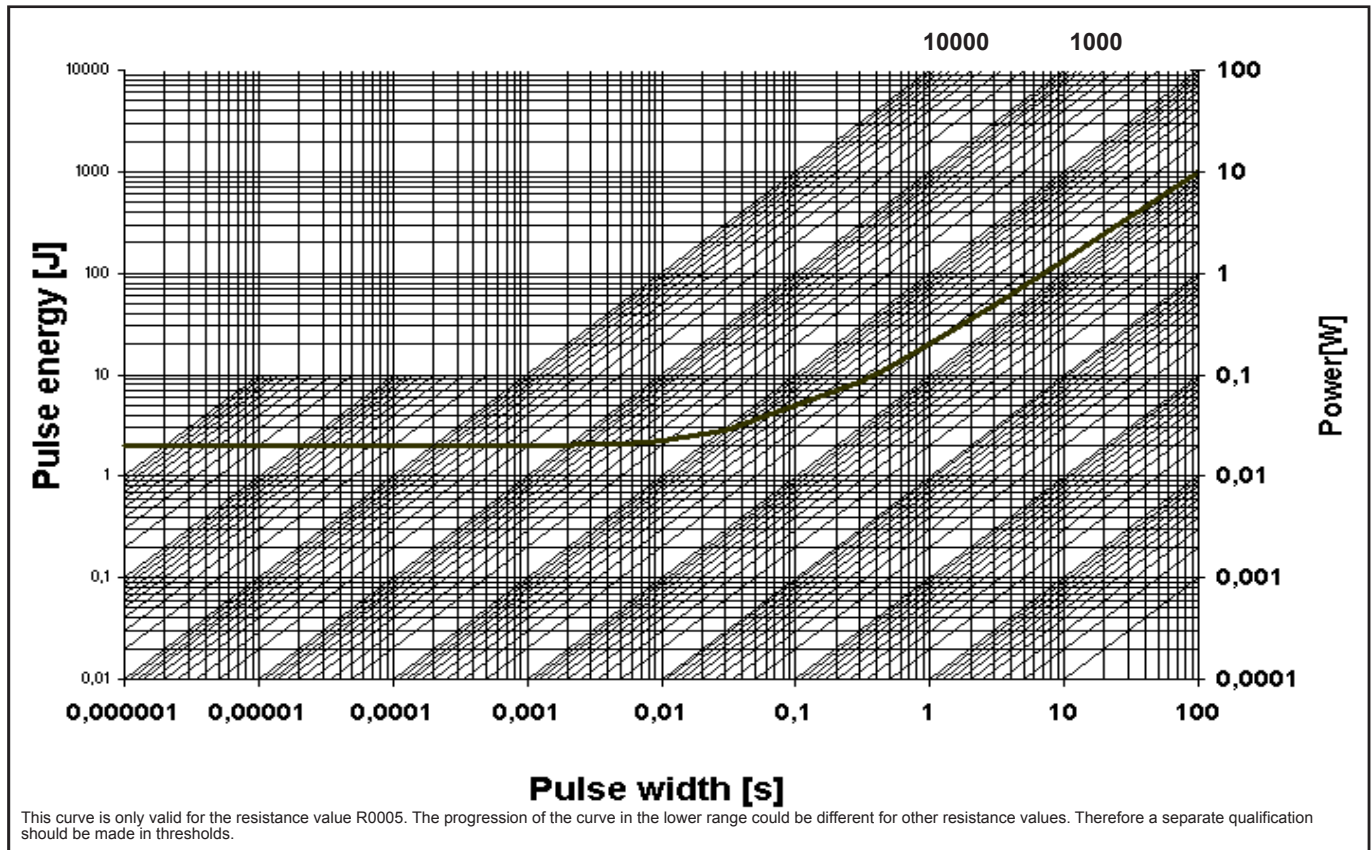

Specification			
Parameters	Test Conditions	Specification	Typical data
Maximum Temperature for full power operation (R > 2 mOhm)	70/90 °C	65/95 °C	95 °C
Working Temperature	-55 to 125 °C	-55 to 125 °C	-55 to 125 °C
Thermal Shock	MIL-STD-202 method 107-B1	0.1 %	0.1 %
Overload	MIL-R-26E (5 times rated power, 5 sec)	0.2 %	0.1 %
Solderability	MIL-STD-202 method 208	> 95 % coverage	> 95 % coverage
Resistance to Solvents	MIL-STD-202 method 215, 2.1a, 2.1d	no damage	no damage
Low Temperature Storage and Operation	MIL-STD-26E	0.1 %	0.03 %
Terminal Strength	MIL-STD-202 method 211	50N, 0.02 %	0.02 %
Resistance to Soldering Heat	MIL-STD-202 method 210	0.1 %	0.02 %
Moisture Resistance	MIL-STD-202 method 106	0.1 %	0.01 %
Shock	MIL-STD-202 method 213-A	0.2 %	0.1 %
Vibration, High Frequency	MIL-STD-202 method 204-B	0.2 %	0.05 %
Life	MIL-STD-26E	0.2 %	0.1 %
Storage Life at Elevated Temperature	MIL-STD-202 method 108-F	0.3 %	0.2 %
High Temperature Exposure	140 °C, 2000 h	0.2%	0.2 %
Current Noise	MIL-STD-202 method 308	0.01 %	0.001 %
Voltage Coefficient (%/V)	MIL-STD-202 method 309	linearity error less than 120dB	
Resistance Temperature Characteristic	MIL-STD-202 method 304 (20-60°C)	< 30 ppm/K	< 30 ppm/K
Thermal EMF	0 - 100 °C	2 µV/K max.	2 µV/K
Frequency Characteristic	inductivity	< 10 nH	< 10 nH