

ALTISTART® 46

Open Style Soft Start Motor Controllers

Class 8636, 8638, 8639, and 8998 MCC's



CONTENTS

Description	Page
ATS46 Open Style	
Introduction	3, 4
Applications	5
Product Characteristics	6
Protective Features	7
Set-Up and Monitoring	8-12
Dimensions	13
Component List for Recommended Wiring Diagrams	14, 15
Wiring Diagrams for Recommended Applications	16-18
Enclosed ATS46 Starters	
Technical Characteristics / Product Selection	20, 21
Factory Modifications (Optional)	24, 25
Dimensions (Wall and Floor Mounts)	26, 27
Model 6 Motor Control Centers	28-38
Application Considerations	39
Comparison of Reduced Voltage Starting Methods	40
Suggested Specifications	41



Schneider Electric Brands



SQUARE D
Schneider Electric

ATS46 Open Style Soft Start Motor Controllers

Introduction



ATS46D17N

The ALTISTART[®] 46 Soft Start with its TCS[™] torque ramp control introduces digital based technology in soft starting and stopping of motor loads. The TCS torque ramp controls the motor accelerating/decelerating torque based upon the configured acceleration/deceleration time and torque ramp settings.

The ATS46 Soft Start still offers all the benefits of previous generation soft starts including:

- Reduction in motor inrush current upon starting to avoid utility peak demand charges
- Elimination of brown out conditions caused by across the line motor starting
- Reduction in motor starting torque to eliminate mechanic shock and stress caused by across the line motor starting

In addition, the ATS46 Soft Start now offers linear motor acceleration/deceleration. Applying TCS torque ramp control produces linear acceleration and deceleration ramps even when the motor is lightly loaded or oversized for the application. Linear acceleration and deceleration of the motor load make it possible to coordinate the ATS46 soft start and motor with the driven load to ensure trouble free applications.

Easy to use-easy to configure for the following constant speed applications:

- | | |
|-----------------------|--|
| Variable Torque Loads | - Service Pumps, Booster Pumps, Circulating Pumps, Chiller Pumps, Exhaust Fans, Supply Fans |
| High Inertia Loads | - Compressors, Scrubber Fans, Induced Draft Fans, Centrifuges, Punch Presses, Band Saws, Wood Chippers, Ball Mills, Hammer Mills, Grinders, Crushers |
| Constant Torque Loads | - Screw Compressors, Conveyors, Aeration Blowers, Mixers, Flocculators, Belt Presses, Bottling Lines, Spindles, Lathes, Travel Drives, Agitators |

Feature / Benefits:

Pump Loads - Eliminates Water-Hammer

Coordination of check valves on pump loads is made easier by the TCS torque ramp control method of linearly controlling motor acceleration/deceleration torque. This allows the check valve to open or close gradually eliminating water-hammer on starting and stopping the pump. No starter options or external motor speed feedback devices are required. TCS torque ramp offers an infinite amount of acceleration/deceleration profiles to fit any pump load combination. TCS torque ramp control acceleration and deceleration performance offers the maximum flexibility in soft-starter applications.

High Inertia Loads - Optimizes accelerating torque during start-up reducing motor heat and accelerating current

Previous technology designed soft starts accelerate high inertia loads in current limit. This produces a distorted NEMA B shaped speed torque profile. TCS torque ramp allows the motor to produce up to 100% rated torque at start and all the way through acceleration. This produces a constant accelerating torque for constant acceleration. The motor draws only the current required to produce the accelerating torque required. This results in lower accelerating current and a cooler start.

Constant Torque Loads - Constant accelerating torque results in constant smooth load acceleration

TCS torque ramp allows the motor to produce a constant torque during starting. Previous soft starts produce a changing accelerating motor torque profile. With the ATS46 the process will accelerate at a constant smooth rate using TCS torque ramp. Constant load acceleration keeps the product in position on a conveyor, threading material through a die, and prevents material from spilling or breaking during starting.



ATS46 Open Style Soft Start Motor Controllers

Introduction

Product Offering

The ALTISTART® 46 Soft Start open style product family includes 21 different power ratings from 17 to 1200 amps, each configurable for operation at 208, 230, 380, or 460 VAC at 50 or 60 Hz. These units are UL listed, CSA Certified and carry the CE mark.

The ATS46 Soft Start is also available enclosed through 500 HP 460 VAC in factory pre-engineered configurations including:

- NEMA 1 or 12 non-combination stand-alone

- NEMA 12 combination stand-alone with shorting contactors as standard for units rated above 38 amps and offer reversing & full voltage bypass options

- MCC packaged starters in NEMA 1, 1A or 12 fusible disconnect combination style. Starter package includes as standard line isolation, shorting, and full voltage bypass contactor options.

The stand-alone units are UL Listed and CSA Certified. The MCC packaged units are UL Listed. All open style starters include a starter mounted digital keypad for ease of user configuration and monitoring. All enclosed packages include a door mounted digital keypad.

Comparison of TCS Torque Control Ramp Starting to Voltage/Current Limit Ramp Starting:

The ALTISTART® 46 Soft Start with its TCS torque ramp control starting applies the motor voltage based upon the motor torque developed. This allows for cooler motor acceleration and produces a constant acceleration torque for any given load allowing the motor to smoothly accelerate up to speed. The voltage/current limit style soft starts apply motor voltage based upon a voltage ramp or current limit setting. Either technique allows the motor to draw more current than necessary and produces a non-linear speed torque curve with varying acceleration torque. The amount of motor accelerating torque changes over the acceleration ramp producing a non-linear acceleration curve.

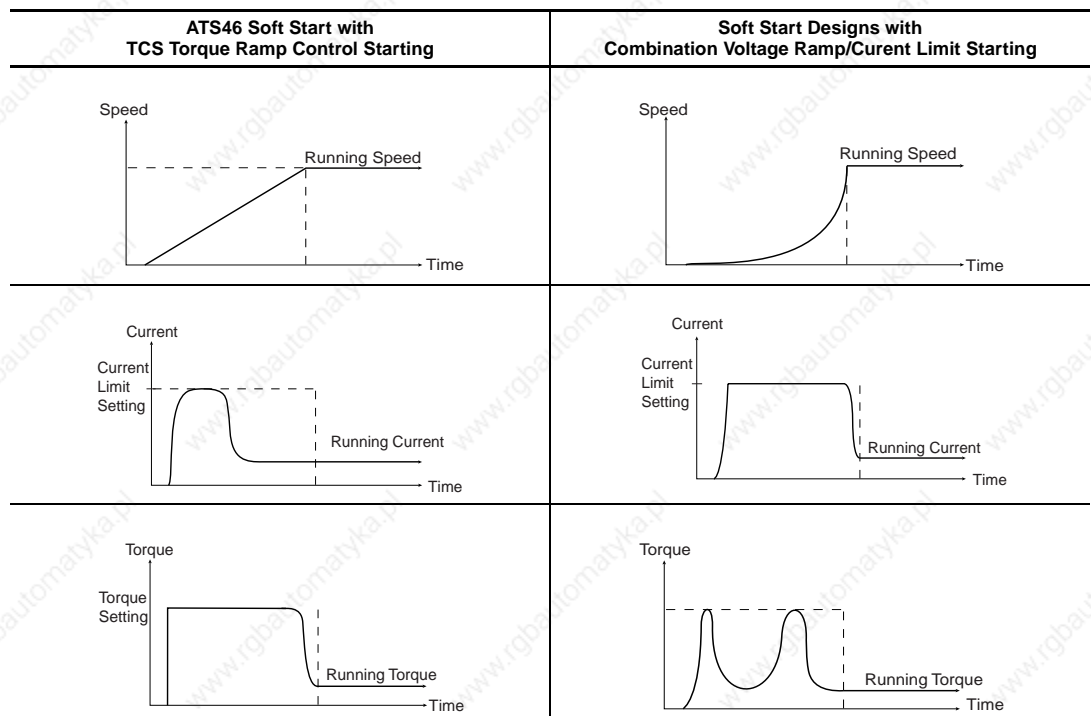

ATS46 Open Style Soft Start Motor Controllers Applications

The Torque Control System of the ATS46 controller allows for flexibility of using soft start applications on a variety of machines which were traditionally not suited for reduced voltage starting. The ATS46 controller is easily adapted to both standard duty and heavy duty applications. The following table lists some suggested settings for several applications. This is to be used as a guide only—settings may vary depending on the actual application.

Type of Machine	Duty	Functions Performed by the ATS46 Controller	Typical Starting Current (In%)	Typical Starting Time (secs)
Centrifugal pump	Standard	Ideal control for acceleration and deceleration (elimination of waterhammer). Protection against underload or inversion of phase rotation.	300	5 to 15
Positive displacement pumps	Standard	Prevention of dry pump condition and reverse rotation.	350	5 to 10
Ventilation fans	Standard (heavy if greater than 30 s start)	Detection of overload caused by clogging or underload (damaged transmission chain).	300	10 to 40
Cold compressor	Standard	Protection, even for special motors	300	5 to 10
Screw-type compressor	Standard	Protection against phase reversal. Contact for automatic unloading at stop.	300	3 to 20
Centrifugal compressor	Standard (heavy if greater than 30 s start)	Protection against phase reversal. Contact for automatic unloading at stop.	350	10 to 40
Positive displacement compressor	Standard	Protection against phase reversal. Contact for automatic unloading at stop.	350	5 to 10
Conveyor	Standard	Adjustable overload; detection of jammed material or of underload for broken belt.	300	3 to 10
Elevator	Standard	Adjustable overload; detection of jamming or of underload. Constant starting with variable load.	350	5 to 10
Circular saw, band saw	Standard (heavy if greater than 30 s start)	Braking for fast stop.	300	10 to 60
Pulper, butchery knives	Heavy	Control of starting torque.	400	3 to 10
Agitator	Standard	Display of current & torque gives the material density.	350	5 to 20
Mixer	Standard	Display of current & torque gives the material density.	350	5 to 10
Grinder	Heavy	Braking to limit vibrations during stopping. Adjustable overload and detection of jamming.	450	5 to 60
Crusher	Heavy	Braking to limit vibrations during stopping. Adjustable overload and detection of jamming.	400	10 to 40
Refiner	Standard	Control of starting and stopping torque.	300	5 to 30
Press	Heavy	Braking to increase the number of cycles.	400	20 to 60

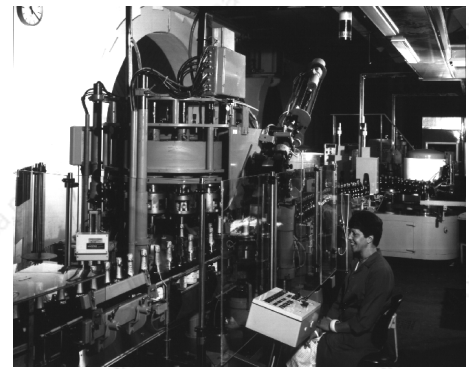
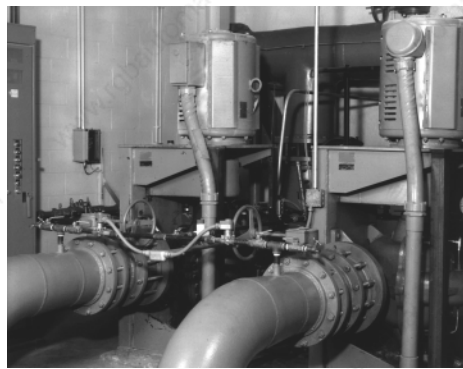

ATS46 Open Style Soft Start Motor Controllers Product Characteristics



The ALTISTART 46 controller is supplied factory set and ready to use. By using the digital keypad or one of the optional communication modules, the factory settings, configuration, and display parameters can be modified. As shown in the figure to the left, the input and output of the controller consists of:

- Digital keypad with LED display (3 / seven segment)
- Status indicator (fault, power)
- Removable terminal strips

ALTISTART 46 soft-start/soft-stop units are recommended when the following features are required:

- Limitation of supply voltage drop and reduction of current peaks during starting
- Limitation of starting torque to protect the driven mechanism
- Smooth acceleration and deceleration or braking to protect both equipment and personnel
- Gradual starting of high-inertia machines
- Ability to easily adapt the starter for special machines
- State-of-the-art motor protection

The ALTISTART 46 controller can control motors with standard three-phase voltages between 208 and 500 V, and with power rating between 3 and 900 hp.

Starting Characteristics

The starting characteristics using TCS “torque ramp control starting” are shown in the graphs below. The acceleration ramp shows that by utilizing the ATS46 controller a linear acceleration ramp can be achieved without tachometer feedback — unlike traditional voltage ramp or current-limit soft starts, where motors are often sluggish at the beginning of the ramp and over-accelerate at the end of the ramp.

By controlling the development of the motor’s torque, TCS “torque ramp control starting” also requires less current than when using traditional current-limiting soft starts. As shown in the graph below, the TCS ramp can result in as much as 15% less current draw than a traditional current-limiting soft start.

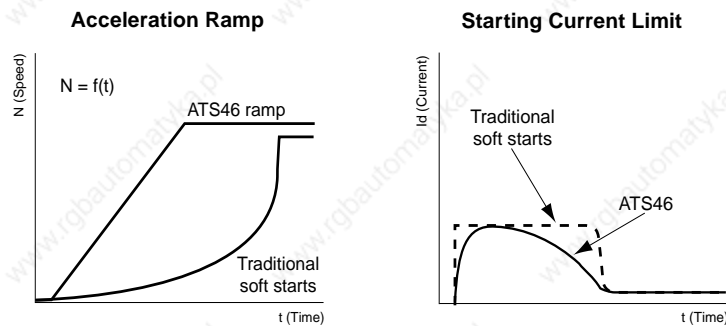

A full-voltage start may also be obtained by increasing the current limit to the maximum setting and decreasing the ramp time to zero. The initial torque may be adjusted up to 100% of the motor nominal torque to assist in duplicating motor performance at full voltage.

Stopping Characteristics

The selection of freewheel stop, deceleration ramp, or INTELE™ braking is standard on all ATS46 controllers. The freewheel stop time (t_1) is a function of the inertia and resistive torque of the application.

When using the deceleration ramp, the stopping time (t_2) will be longer than the freewheel stop time (t_1). By controlling the deceleration ramp based on the motor torque, the ATS46 controller can eliminate waterhammer without requiring a special “pump version” starter.



ATS46 Open Style Soft Start Motor Controllers Protective Features

When using INTELE braking, the stop time (t_3) will be less than the freewheel stopping time (t_1). INTELE braking is a two-part braking which does not require external components. It produces less motor heating than traditional DC injection braking.

The graphs shown below compare the performance of the deceleration ramp and INTELE braking. INTELE Braking is best utilized provided all of the criteria is met:

- 4 pole or 6 pole motors only
- Motor slip less than or equal to 3%

$$t \text{ (sec)} = \frac{WK^2 \times \Delta\text{rpm}}{308 \times (T_{\text{FLT}} \times 0.40)}$$

where:

t (sec) = **Calculated value must be equal to or less than 40**

WK^2 = Connected motor load inertia (lb-ft²)

Δrpm = Change in rpm or synchronous speed

T_{FLT} = Full Load Torque (lb-ft)

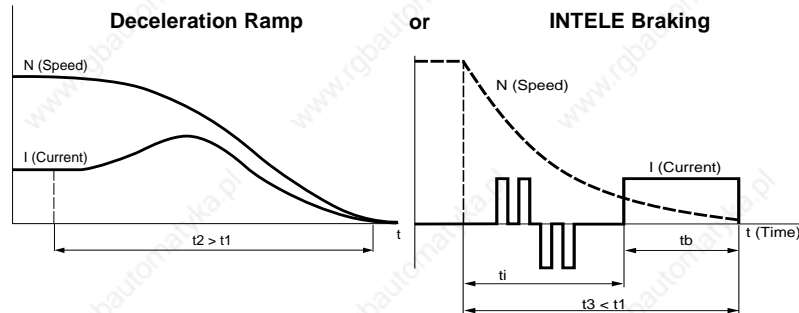

Protective Features

The ATS46 controller provides state-of-the-art protection for motor and starter. The motor and starter status are continuously monitored even if a shorting contactor is used. User-adjustable overload protection is available with a pre-alarm, which can be used to signal a change in the process before an overload condition actually occurs. Phase loss protection is always present with a 500 millisecond delay to prevent nuisance tripping resulting from normal power disturbances. The following additional features are available and can be set-up using the keypad or communications module:

- Phase reversal protection — Upon a start command, the rotation of the mains phases is checked to prevent the motor from running in the reverse direction.
- Stall protection — A maximum starting time can be set to prevent a thermal overload if the motor is stalled during start-up. The maximum starting time can be adjusted from 10 to 999 seconds.
- Jam protection — For protection against material jams or unexpected loading, an overcurrent level can be set to signal a fault condition before the motor is actually overloaded. The overcurrent level can be adjusted from 50% to 300% of the motor nominal current.
- Underload protection — For indication of an unexpected loss in motor loading, such as might occur with a broken belt or a dry pump. The underload level can be adjusted based on the normal running torque for maximum application flexibility.

The ATS46 controller may be set up for automatic fault reset. This allows the controller to re-start after a nuisance trip if the fault has cleared. In addition, a special test mode is available for commissioning a high-horsepower controller using a low-horsepower, unloaded motor.

Thermal Overload Protection

A microprocessor-controlled surveillance system continuously monitors the temperature rise of the motor and of the starter unit. Calculations are based on the motor operating current measured by the controller as compared to the nominal current setting. The thermal state of the motor and controller are stored even when control power is lost.

A logic output pre-alarm indicates that the motor has exceeded its nominal temperature rise threshold before an overload occurs. After a stoppage due to a thermal fault, the control circuit prevents restarting if the temperature of the motor is still too high. You may configure the available logic input to require operator acknowledgment of a thermal overload to reset the controller.



ATS46 Open Style Soft Start Motor Controllers Set-Up and Monitoring

The ATS46 controller is factory preset to provide class 10 overload protection for standard duty applications, but can be adapted for other starting classes (2, 10A, 15, 20, 25, or 30). The table below shows the tripping time according to starting class.

Starting Class	Tripping Time at 7.2 In ^[1]	Tripping Time at 3 In
2	1.5 s	9 s
10A	3.7 s	22 s
10	7.4 s	45 s
15	11.1 s	67 s
20	14.8 s	89 s
25	18.5 s	112 s
30	22.2 s	134 s

[1] Conforming to IEC 947-4-1

The factory setting is as follows:

- Class 10 for standard service
- Class 20 for heavy duty

Standard duty for the starter unit is one which does not exceed 230 seconds at 3 times the motor nominal current per hour, or 6.3% of operating time including starting, stopping, or braking. For example, within one hour, the ATS46 controller could perform:

- 38 starts of 6 sec. or 10 starts of 23 sec.
- 19 starts of 6 sec. and 19 decelerated or braked stops of 6 sec.
- 5 starts of 23 sec. and 5 decelerated or braked stops of 23 sec.

Above these levels, or when the motor connected load inertia is greater than ten times the motor rotor inertia, the controller should be sized for heavy-duty operation.

Set-Up and Monitoring

The ATS46 controller is factory preset, which, for many applications, allows operation without requiring adjustment. As shown in the figure below, a switch is located behind the removable display module that can be toggled from standard-duty to heavy-duty application presets.

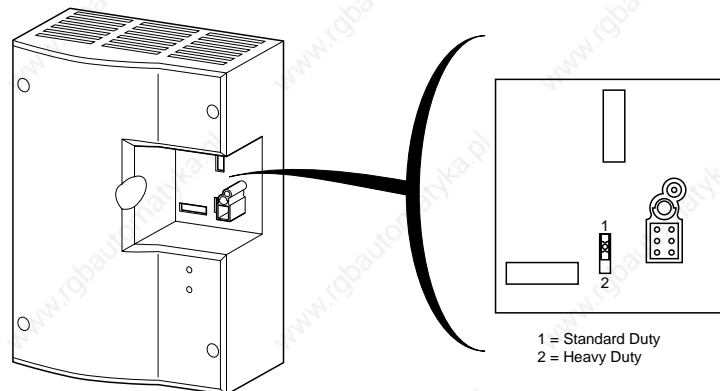

The ATS46 controller is factory preset to standard duty operation. To switch the factory presets for heavy duty applications, remove the keypad and change the selector switch to position 2, as shown in the inset of the figure above. For the change to take affect, control power must be cycled after adjusting the selector switch. The following factory presets change when adjusting the selector switch from position 1 to position 2:

Parameter		Standard-Duty Preset	Heavy-Duty Preset
Acceleration Ramp	AC	10 seconds	15 seconds
Current Limit	lIt	300%	350%
Overload Protection	thp	Class 10	Class 20



ATS46 Open Style Soft Start Motor Controllers Set-Up and Monitoring

The factory preset for the motor nominal current, I_n , and corresponding motor combinations for standard-duty and heavy-duty presets are listed in the table below. If the motor full load amp rating is not between 95% and 105% of the ATS46 controllers factory preset value, or if using a 1.0 service factor motor, the nominal current setting for the motor should be adjusted for optimal motor protection and performance.

ATS46 Model	Rated Current ◆	Standard-Duty Applications				Heavy-Duty Applications			
		Preset Motor Current	Motor Power Rating			Preset Motor Current	Motor Power Rating		
			208V	230V	460V		208V	230V	460V
ATS46D17N	17	15.2	3	5	10	12	2	3	7.5
ATS46D22N	22	21	5	7.5	15	15.2	3	5	10
ATS46D32N	32	28	7.5	10	20	21	5	7.5	15
ATS46D38N	38	34	10	—	25	28	7.5	10	20
ATS46D47N	47	42	—	15	30	34	10	—	25
ATS46D62N	62	54	15	20	40	42	—	15	30
ATS46D75N	75	68	20	25	50	54	15	20	40
ATS46D88N	88	80	25	30	60	68	20	25	50
ATS46C11N	110	98	30	40	75	80	25	30	60
ATS46C14N	145	128	40	50	100	98	30	40	75
ATS46C17N	176	160	50	60	125	128	40	50	100
ATS46C21N	210	190	60	75	150	160	50	60	125
ATS46C25N	257	236	75	100	200	190	60	75	150
ATS46C32N	320	290	100	125	250	236	75	100	200
ATS46C41N	410	367	125	150	300	290	100	125	250
ATS46C48N	480	430	150	—	350	367	125	150	300
ATS46C59N	590	547	—	200	400	430	150	—	350
ATS46C66N	660	610	200	250	500	547	—	200	400
ATS46C79N	790	725	250	300	600	610	200	250	500
ATS46M10N	1000	880	350	400	800	725	250	300	600
ATS46M12N	1200	1130	400	450	900	880	350	400	800

◆ At 40° C ambient.

Note: If purchasing a Class 8636, 8638 or 8639 Enclosed Starter, modifications may have been made to the factory settings listed above to more closely match the motor full load amp ratings at the specified motor voltage. In addition, if an input contactor is provided, the R1 relay has been reset for isolation contactor control.

Keypad Use

A keypad is provided to allow digital setup of the controller and real-time indication of motor performance. The keypad has three seven-segment display characters, one program LED, and four pushbuttons for programming the controller, as shown in the figure to the left.

The keypad is removed by loosening the holding screw, and may be removed while the controller is switched on. The keypad is not required to be in place to operate the controller.

The adjustable parameters are separated into 3 levels. Two switches on the back of the display keypad may be adjusted to provide access to all three programming levels or prevent adjustment to the controller. To avoid accidental controller modifications, the controller is preset to prevent adjustment without first removing the keypad and changing the DIP switch setting

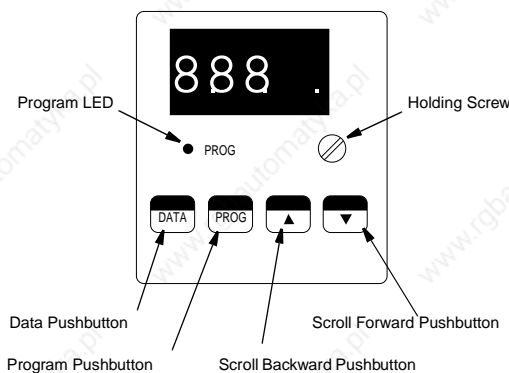

ATS46 Open Style Soft Start Motor Controllers

Set-Up and Monitoring

Adjustment Capabilities

Tables show adjustment parameters if Level 1 is selected; usually selected for simple applications.

Level 1 Adjustment and Configuration Parameters		Adjustment Range
In	Motor nominal current (in A)	50 to 130%
ILt	Motor limit current (in A)	150 to 500%
Acc	Torque ramp on acceleration (in s)	1 to 60 seconds
dEc	Torque ramp on deceleration (in s)	1 to 60 seconds
StY	Stopping type (freewheel, ramp, braking)	f – b – d
Edc	Threshold to change to freewheel stopping at the end of the deceleration ramp (percentage of Tn)	0 to 100%
brc	Braking torque level (as a percentage)	0 to 100%

In addition to the Level 1 parameters shown above, the following parameters may be adjusted in Level 2.

Level 2 Adjustment and Configuration Parameters		Adjustment Range
bSt	Voltage boost (as a percentage of V)	50 to 100%
tqo	Initial starting torque (as a percentage of Tn)	0 to 100%
tLI	Maximum torque limit (as a percentage of Tn)	10 to 200%
ULL	Underload threshold (as a percentage of Tn)	20 to 100%
tLS	Maximum start time (in s)	10 to 999 s
thp	Motor thermal protection (choice of classes)	Off, 10, 10A, 15, 20, 25, 30

The following table shows the adjustment and monitoring parameters if Level 3 is selected (which allows the factory configuration to be modified).

Level 3 Parameters Which Can Be Configured			
ArS	Automatic restart	rth	Reset motor thermal state
CLp	Torque control	Int	Return to factory settings
LSc	Stator loss compensation (as a %)	SSt	Test on low power motor
O-4	Signal type in AO1	CSc	Cascade starting
LI	Assignment of LI	tFr	Operating time since reset (in hours)
Lo1	Assignment of LO1	EbA	Adjustment of braking (as a %)
OIL	Current tripping threshold (as a percentage of In)	Ao	Assignment of analogue output AO1
Phr	Phase rotation fault	ASc	Scale AO
rl	Assignment of relay R1		

This level is independent of Levels 1 and 2. When Level 3 is selected, the user does not have access to the parameters of Levels 1 and 2, but can reconfigure the basic product.

If the locking level is selected, only the monitoring parameters and Level 1 and 2 parameters can be read; no parameters can be modified.

Monitoring Capabilities

The following parameters may be monitored when in lockout mode or Level 1 or 2 programming levels.

Monitoring Parameters (displayed while the ATS46 is running)	
CoS	Value of $\cos \varphi$ (power factor)
Lth	Motor thermal state (as a percentage)
Ltr	Load status (as a percentage of Tn)
Lcr	Motor current (in A)
rdY	Starter status

In addition to monitoring the operational status of the motor, the following fault codes are available to simplify troubleshooting the application.

Fault Definitions			
Code	Description	Code	Description
O c F	Overcurrent fault	O h F	Starter thermal fault
I n F	Internal failure fault	L r F	Locked rotor fault
P i F	Phase inversion fault	U L F	Motor underload
P h F	Phase fault	S t F	Maximum start time exceeded
F r F	Frequency fault	E T F	External fault
U S F	Supply fault	S L F	Serial link fault
O L F ^[1]	Motor thermal fault		

1. If LI is configured for motor overload reset (Lti), operator acknowledgment of the overload condition is required. The overload must also be reset through the logic input after the fault has cleared before restarting the motor.



ATS46 Open Style Soft Start Motor Controllers Set-Up and Monitoring

Option Modules



PLC Communication Module (VW3G46301)

The following option modules may be used to display parameters and modify the factory settings. The modules are used in place of the display keypad, and are the same for all ATS46 soft start models.

Description	Reference	Weight (kg)
Remote mounting kit ^[1]	VW3G46103	0.500
Communication option for UNITELWAY™, MODBUS® RTU/Jbus, MODBUS ASCII protocols ^[2]	VW3G46301	0.500

[1] Kit comprising a unit which plugs into the front panel of the ATS46 controller, a connection (3 meters long) and a flush-mounting kit. To be used with keypad provided with controller.

[2] Option kit includes a unit which plugs into the front panel of the ATS46 controller and a connection cable (3 meters long)

General Characteristics

The asynchronous motor associated with the ATS46 controller must be capable of starting the load to be driven when it is supplied with reduced voltage.

The products are defined for normal or heavy duty. In cases of heavy duty, check with the motor manufacturer that any derating is compatible with the operating cycle and the starting times. This will avoid tripping the thermal overload protection integrated within the ATS46 controller, which may result from abnormal rises in the motor temperature.

Environmental Characteristics

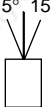
Conformity to standards		The electronic soft-start/soft-stop units were developed and performance-tested in accordance with the following international standards and recommendations relating to industrial control gear (IEC, NFC, VDE), IEC 947-4-2, UL, and CSA.
Marking		The products have CE marking in accordance with the low voltage and electromagnetic compatibility directives.
Degree of protection	Starters ATS-46D17N to 46C14N Starters ATS-46C17N to 46M12N	NEMA: Open devices IEC: IP 20 (IP 10 when no connections are present) IP 00
Shock resistance	Conforming to IEC 68-2-27 Starters ATS-46D17N to 46D38N	15 g for 11ms
Vibration resistance	Conforming to IEC 68-2-6, NFC 2076 and BV1	
Ambient air temperature	For operation	0 to +40°C without derating (between +40°C and +60°C derate the ALTISTART Soft Start current by 1.2% for each degree C)
	For storage	-25 to +70°C
Maximum relative humidity	Conforming to IEC 68-2-3	93% without condensation or dripping water
Maximum ambient pollution	Conforming to IEC 664	Degree 3
Maximum operating altitude		1000m without derating (above this, derate the ATS46 controller current by 0.5% for each additional 100m)
Operating Position^[1] Permanent maximum angle in relation to the normal vertical mounting position		15° 15° 

1. In certain (marine) applications, the starter can temporarily tolerate an angle of $\pm 45^\circ$ in relation to the vertical



ATS46 Open Style Soft Start Motor Controllers

Set-Up and Monitoring

Electrical Characteristics

Category of use	Conforming to IEC 947-4-2	AC-53a
3-phase supply voltage		208V – 10%...240V + 10% 380V – 15%...415V + 10% 440V – 15%...500V + 10%
Frequency		50 or 60 Hz, self-adapting ±5% while starting, +5/-15% while running
Nominal current		17...1200A in 21 ratings
Motor power		2 to 900 hp
Voltage indicated on the motor rating plate		208V...240V 380V...415V 440V...500V
Current adjustment		The motor nominal current is adjustable from 0.5 to 1.3 times the product rating, and the maximum starting current may be adjusted from 1.5 to 5 times the product rating
Starting method		Factory setting: 3 times the nominal current for standard duty on a torque ramp of 10s, adjustable from 0.5 to 60 seconds
Method of stopping	Freewheel	"Freewheel" stop by default
	Controlled by torque ramp	Adjustable from 0.5 to 60 seconds
	Braked stop	Automatically controlled by the load inertia
LED Display	Locking (red)	On indicates fault; flashing indicates automatic reset
	Supply on (green)	On indicates supply on
Output relays (2 relays)	Fault Relay (can be assigned for control of an isolation contactor)	R1: 1 N.O. & 1 N.C.
	End of Start Relay	R2: 1 N.O.
	Maximum operating power	Inrush 1200VA, maintained 120VA
	Minimum switching capacity	100 mA@ 24V
	Nominal operating current	0.5A. Categories AC-14, AC-15 (@ 240V), and DC-13 (@ 48V)
	Nominal thermal current	5A
	Maximum operating voltage	400V
Mechanical durability	50 million operating cycles	
Analog output AO	Indication of motor current, torque, thermal state, or power factor.	Current output 0-20mA with 500 ohm impedance; can be reassigned to 4-20mA. Precision ± 3%, linearity ± 3%
Logic outputs LO	LO1 (indication of thermal pre-alarm or motor powered)	Maximum voltage 40V, minimum voltage 10V Maximum output current 200mA
	LO2 (excess current alarm)	
Available internal power supply		1 isolated output + 24V (PL) Precision +/- 20% Maximum 100 mA
Logic inputs LI	Force to freewheel, external fault, reset of thermal overload, local control, or cascade	3 logic inputs with 3.5 kohm impedance Power supply + 24V State 0 if < 5V; State 1 if > 11V
Protection	Mains supply protection	Integrated thermal protection for motor and starter unit Phase failure and imbalance indicated by output relay
	Thermocontacts	On fan-cooled units, 75 to 1200A ratings
Selection of starter unit		The ATS46 controller must be selected according to the nominal power of the motor and the duty required. Any starter can be used for standard or heavy duty. For heavy duty, derate the starter by one nominal motor size. The ATS46 controller can be used for heavy duty applications at the standard duty rating if the product is bypassed at the end of starting.



ATS46 Open Style Soft Start Motor Controllers Dimensions

Installation Precautions for All ATS46 Soft Start Models

When fitting the ATS46 controller, allow a minimum of 4" above and below the unit, and 2" to the left and right of the unit.

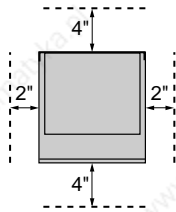

Install the ATS46 controller vertically.

Avoid placing the ATS46 controller close to or above heating elements.

ATS46 D17N to D38N

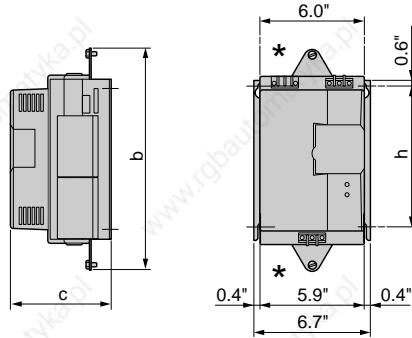

* Removable earth boss, supplied with the product but not fitted

ATS46 D47N to C14N

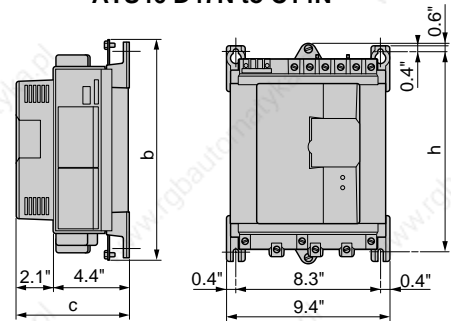

ATS46 C17N to C32N

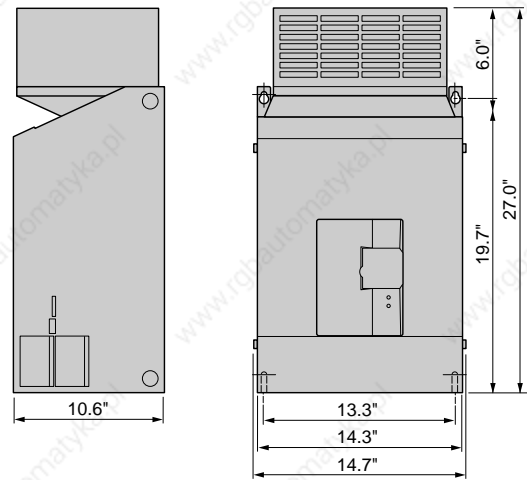

ATS46 Model	b	c	h
D17N	12.8"	5.9"	8.3"
D22N	12.8"	5.9"	8.3"
D32N	14.8"	5.9"	10.2"
D38N	14.8"	5.9"	10.2"
D47N	13.0"	6.6"	11.8"
D62N	13.0"	6.6"	11.8"
D75N	13.4"	9.6"	11.8"
D88N	13.4"	9.6"	11.8"
C11N	15.4"	9.6"	13.8"
C14N	17.3"	9.6"	15.7"

ATS46 C41N to C66N

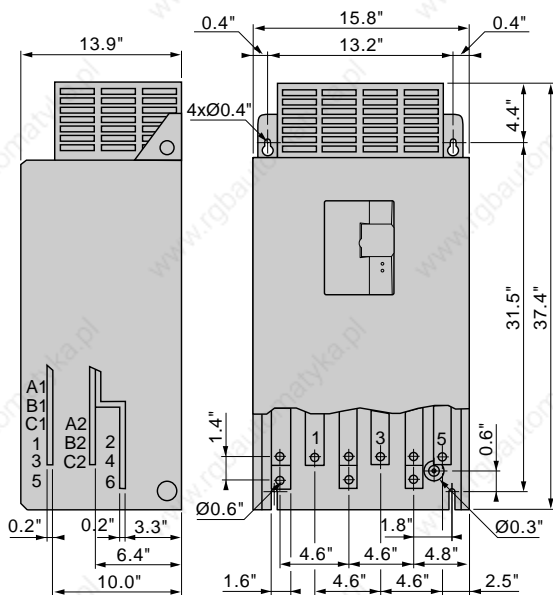

ATS46 C79N to M12N

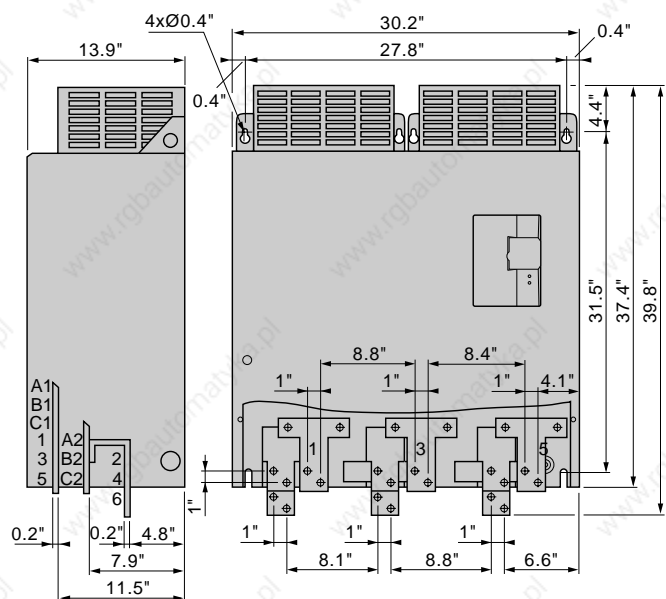

ATS46 Open Style Soft Start Motor Controllers

Component List for Recommended Wiring Diagrams

Suggested Components for Standard Duty Applications.

Induction Motor			ALTISTART Controller				
M			ATS		FU1/FU2		
Rated hp [1]			ATS46 Soft Start	Device Rated Current	ATS Control	Class CC Control Fuse Size	
208 V	230 V	460 V	Model	@ 40 °C [2]	Power Burden	@ 208/230 V	@ 460 V
3	5	10	ATS46 D17N	17	20 VA	0.25 A	0.25 A
5	7.5	15	ATS46 D22N	22	20 VA	0.25 A	0.25 A
7.5	10	20	ATS46 D32N	32	20 VA	0.25 A	0.25 A
10	—	25	ATS46 D38N	38	20 VA	0.25 A	0.25 A
—	15	30	ATS46 D47N	47	70 VA	0.5 A	0.25 A
15	20	40	ATS46 D62N	62	70 VA	0.5 A	0.25 A
20	25	50	ATS46 D75N	75	70 VA	0.5 A	0.25 A
25	30	60	ATS46 D88N	88	70 VA	0.5 A	0.25 A
30	40	75	ATS46 C11N	110	70 VA	0.5 A	0.25 A
40	50	100	ATS46 C14N	145	70 VA	0.5 A	0.25 A
50	60	125	ATS46 C17N	176	250 VA	1.6 A	0.8 A
60	75	150	ATS46 C21N	210	250 VA	1.6 A	0.8 A
75	100	200	ATS46 C25N	257	250 VA	1.6 A	0.8 A
100	125	250	ATS46 C32N	320	250 VA	1.6 A	0.8 A
125	150	300	ATS46 C41N	410	350 VA	1.6 A	0.8 A
150	—	350	ATS46 C48N	480	350 VA	1.6 A	0.8 A
—	200	400	ATS46 C59N	590	350 VA	1.6 A	0.8 A
200	250	500	ATS46 C66N	660	350 VA	1.6 A	0.8 A
250	300	600	ATS46 C79N	790	500 VA	3.0 A	1.5 A
300	400	800	ATS46 M10N	1000	500 VA	3.0 A	1.5 A
400	450	900	ATS46 M12N	1200	500 VA	3.0 A	1.5 A

To select control operators (push buttons, pilot lamps, and selector switches), control power transformers, and wire management devices (control and power terminal strips, wire terminations) indicated on the referenced control circuit configurations, refer to the latest editions of Square D's full line product catalogs.

Notes:

- Motor full load currents through 500 hp @ 460 V and 250 hp @ 230 V are taken from UL508 Table 54.2 (NFPA 70, Table 430-150). Above 500 hp @ 460 V and 250 hp @ 230 V, motor full load currents are calculated based upon 1.2 A/hp for 460 V and 2.4 A/hp for 230 V. Motors listed are for standard duty applications. For heavy duty applications, select the next larger controller size.
- The ambient temperature indicated in the table represents the temperature of the air surrounding the ALTISTART controller. Any additional temperature factors associated with the enclosure system or actual installation ambient temperature must be considered when determining the actual rated current (I_{CL}) of the starter. For operating ambient above 40 °C but not exceeding 60 °C, the rated current (I_{CL}) of the starter must be de-rated by 1.2% per °C.



ATS46 Open Style Soft Start Motor Controllers Component List for Recommended Wiring Diagrams

ATS46 Model	Contactors [3, 4, 7]				Disconnect [10]			
	KM1	KM2		KM3	Fusible Disconnect			Circuit Breaker
	Isolation Contactor	Reversing Contactor [5]	Mechanical Interlock	Shorting Contactor	Power Fuses Class/Rating	Fuse Block [8]	Molded Case Switch [9]	Thermal Magnetic [9]
D17N	LC1 D1211G6	LC1 D1211G6	[6]	N/A	RK5 / 20 A	9080 FB3611R	FHL36000M	FAL34030
D22N	LC1 D1811G6	LC1 D1811G6	[6]	N/A	RK5 / 30 A	9080 FB3611R	FHL36000M	FAL36040
D32N	LC1 D3211G6	LC1 D3211G6	[6]	N/A	RK5 / 40 A	9080 FB3621R	FHL36000M	FAL34050
D38N	LC1 D3211G6	LC1 D3211G6	[6]	N/A	RK5 / 45 A	9080 FB3621R	FHL36000M	FAL34060
D47N	LC1 D4011G6	LC1 D4011G6	[6]	LC1 D4011G6	RK5 / 60 A	9080 FB3621R	FHL36000M	FAL34080
D62N	LC1 D5011G6	LC1 D5011G6	[6]	LC1 D5011G6	RK5 / 70 A	9080 FB3631R	FHL36000M	FAL34090
D75N	LC1 D6511G6	LC1 D6511G6	[6]	LC1 D6511G6	RK5 / 90 A	9080 FB3631R	FHL36000M	FAL34100
D88N	LC1 D8011G6	LC1 D8011G6	[6]	LC1 D8011G6	RK5 / 110 A	6R200A3BE	FHL36000M	KAL36110
C11N	LC1 D8011G6	LC1 D8011G6	[6]	LC1 D8011G6	RK5 / 150 A	6R200A3BE	KHL36000M	KAL36150
C14N	LC1 F150G6	LC1 F150G6	LA9 FF970	LC1 F150G6	RK5 / 175 A	6R200A3BE	KHL36000M	KAL36200
C17N	LC1 F150G6	LC1 F150G6	LA9 FF970	LC1 F150G6	RK5 / 200 A	6R200A3BE	KHL36000M	LAL36225
C21N	LC1 F185G6	LC1 F185G6	LA9 FG970	LC1 F185G6	RK5 / 250 A	6R400A3B	KHL36000M	LAL36250
C25N	LC1 F265G7	LC1 F265G7	LA9 FJ970	LC1 F265G7	RK5 / 350 A	6R400A3B	LHL36000M	LAL36350
C32N	LC1 F330G7	LC1 F330G7	LA9 FJ970	LC1 F330G7	RK5 / 400 A	6R400A3B	LHL36000M	LAL36400
C41N	LC1 F400F7	LC1 F400F7	LA9 FJ970	LC1 F400F7	RK5 / 500 A	6R600A3B	LHL36000M	MAL36600
C48N	LC1 F400F7	LC1 F400F7	LA9 FJ970	LC1 F400F7	RK5 / 600 A	6R600A3B	MHL360006M	MAL36600
C59N	LC1 F500F7	LC1 F500F7	LA9 FJ970	LC1 F500F7	L / 650 A	[8]	MHL360008M	MAL36800
C66N	LC1 F500F7	LC1 F500F7	LA9 FJ970	LC1 F500F7	L / 800 A	[8]	MHL360008M	MAL36900
C79N	LC1 F630F7	LC1 F630F7	LA9 FL970	LC1 F630F7	L / 1000 A	[8]	MHL36000M	[11]
M10N	LC1 F630F7	LC1 F630F7	LA9 FL970	LC1 F630F7	L / 1100 A	[8]	MHL36000M	[11]
M12N	LC1 F780F7	LC1 F780F7	LA9 FX970	LC1 F780F7	L / 1600 A	[8]	NCL3600012M	[11]

Notes:

3. All coils are selected for 120 V, 60 Hz operation. Refer to the Digest for additional coil voltages or auxiliary contact configurations. One block may be added to each contactor.
4. Power terminals are not included with LC1-F contactors. Refer to the latest editions of Square D's full line product catalogs for additional ordering information.
5. Reversing contactors for C11 through M12 controllers must be assembled from components. Parts quantities for a basic contactor assembly, minus the power connection links and terminals, are indicated before each part number. Refer to the latest editions of Square D's full line product catalogs for power connector link and terminal kits. Reversing contactor interlock units used for the C79 through M12 controllers are designed for vertical interlocking of the individual contactors. Horizontally interlocked contactors are used for D17 through C59 controllers.
6. The "D" Line Contactor is available as a reversing configuration. For these applications, change the KM1 part number prefix from LC1- to LC2- to order the KM1 and KM2 combination complete with mechanical interlocks.
7. The use of transient suppressors across all contactor coils is recommended. Refer to the latest editions of Square D's full line product catalogs for selection of transient suppressors.
8. Fuse holders listed are for Class R fuses only. Fuse blocks recommended for use with ATS46 soft start models D88 through C48 are Bussmann part numbers. Class L fuses require bolt-on connections to user-supplied power bus work.
9. The molded case switches and circuit breakers selected require the addition of operator mechanisms to allow operation from the exterior of an enclosure. Refer to the latest editions of Square D's full line product catalogs for operator mechanism information. When using a shunt trip relay for SCR fault isolation, order a disconnect switch with suffix -1021 for addition of shunt trip coil.
10. According to the National Electric Code, branch circuit overcurrent protection must be provided for each controller. Short circuit protective devices recommended in this table are within NEC requirements for Type 1 coordination.
11. Devices rated above 660 A have not been coordinated with circuit breakers. Must use Class L fuse for overcurrent protection with ATS46 soft start models C79, M10, and M12N.



ATS46 Open Style Soft Start Motor Controllers Wiring Diagrams for Recommended Applications

Non-Reversing with Shunt Trip Fault Isolation

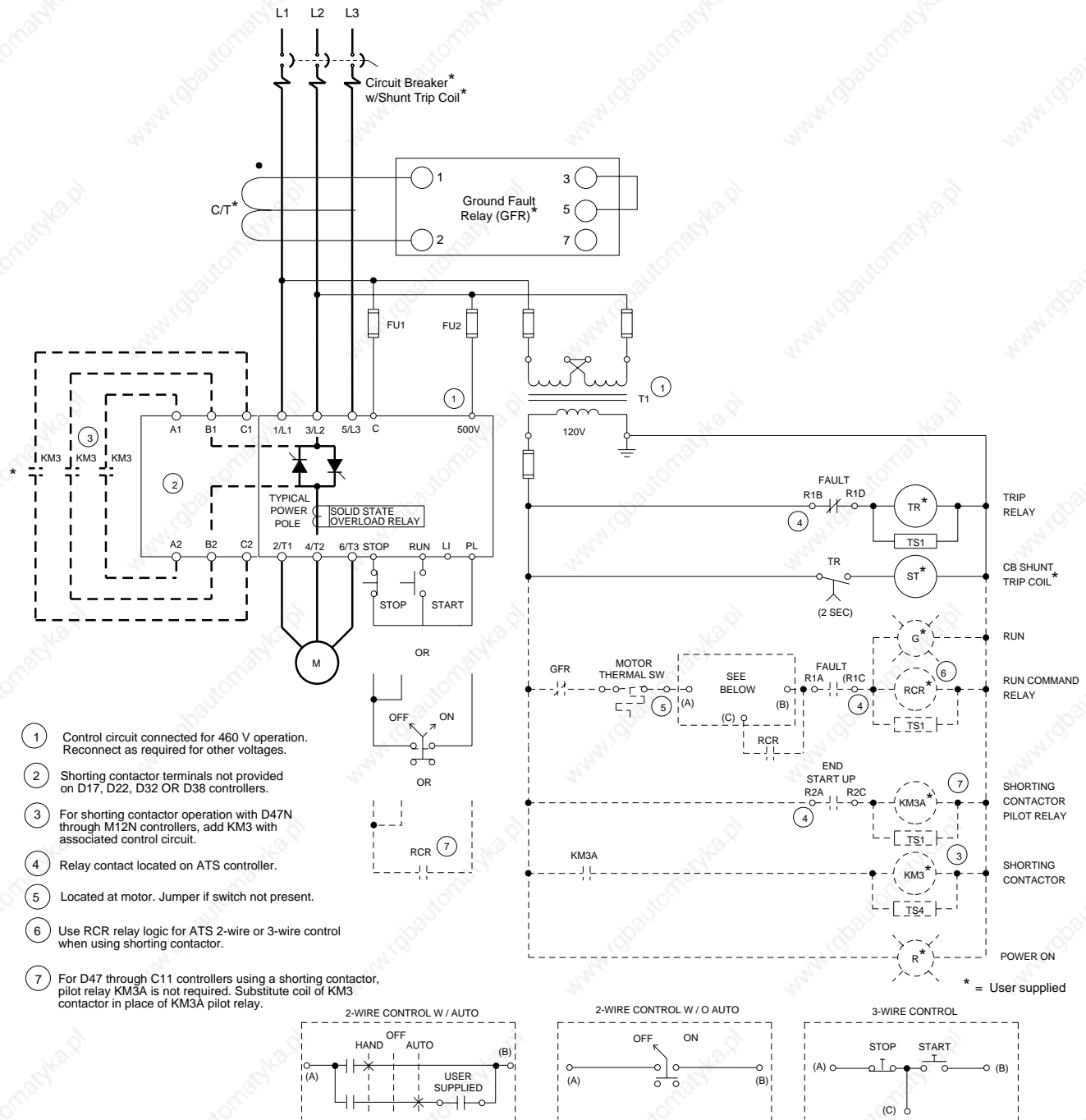

ATS46 Open Style Soft Start Motor Controllers Wiring Diagrams for Recommended Applications

Non-Reversing with Isolation Contactor

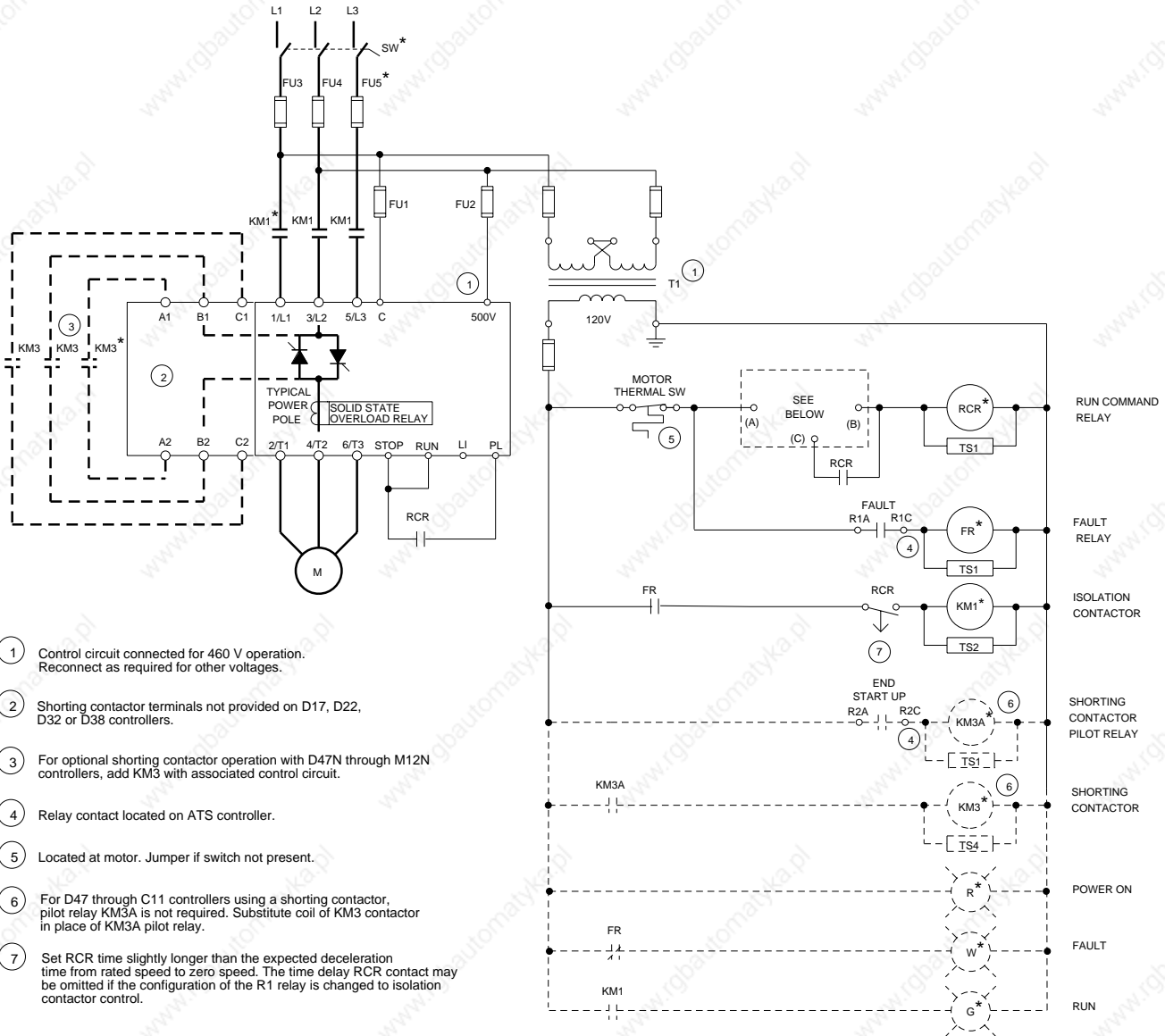

- 1 Control circuit connected for 460 V operation. Reconnect as required for other voltages.
- 2 Shorting contactor terminals not provided on D17, D22, D32 or D38 controllers.
- 3 For optional shorting contactor operation with D47N through M12N controllers, add KM3 with associated control circuit.
- 4 Relay contact located on ATS controller.
- 5 Located at motor. Jumper if switch not present.
- 6 For D47 through C11 controllers using a shorting contactor, pilot relay KM3A is not required. Substitute coil of KM3 contactor in place of KM3A pilot relay.
- 7 Set RCR time slightly longer than the expected deceleration time from rated speed to zero speed. The time delay RCR contact may be omitted if the configuration of the R1 relay is changed to isolation contactor control.

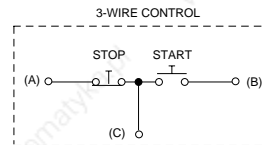
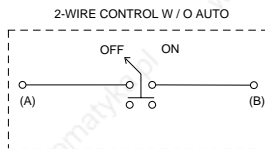
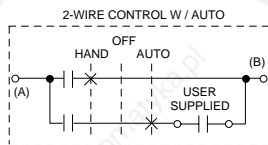

* = User supplied



ATS46 Open Style Soft Start Motor Controllers Wiring Diagrams for Recommended Applications

Reversing with Isolation Contactors

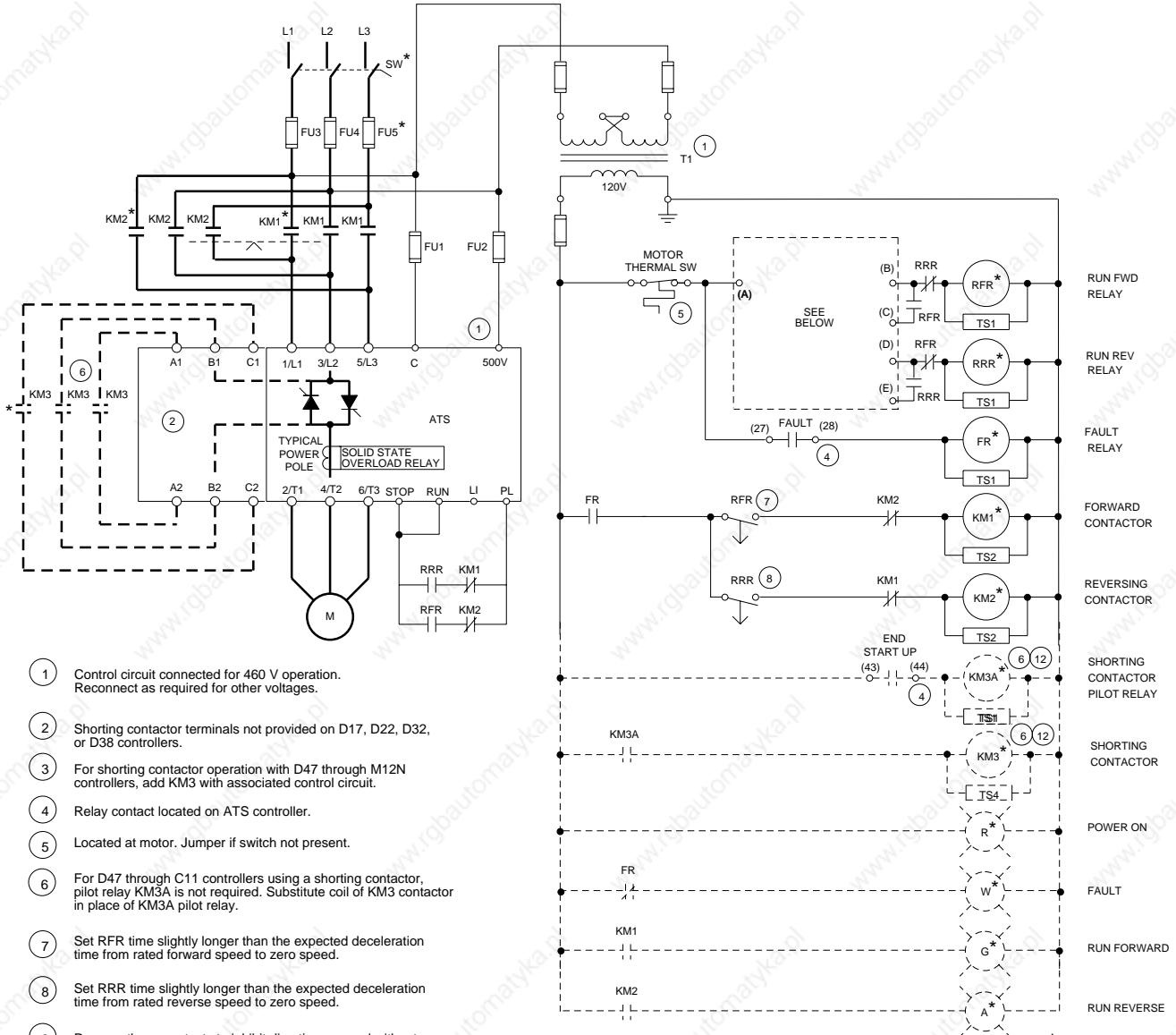

- 1 Control circuit connected for 460 V operation. Reconnect as required for other voltages.
- 2 Shorting contactor terminals not provided on D17, D22, D32, or D38 controllers.
- 3 For shorting contactor operation with D47 through M12N controllers, add KM3 with associated control circuit.
- 4 Relay contact located on ATS controller.
- 5 Located at motor. Jumper if switch not present.
- 6 For D47 through C11 controllers using a shorting contactor, pilot relay KM3A is not required. Substitute coil of KM3 contactor in place of KM3A pilot relay.
- 7 Set RFR time slightly longer than the expected deceleration time from rated forward speed to zero speed.
- 8 Set RRR time slightly longer than the expected deceleration time from rated reverse speed to zero speed.
- 9 Remove these contacts to inhibit direction reversal without first depressing STOP pushbutton.

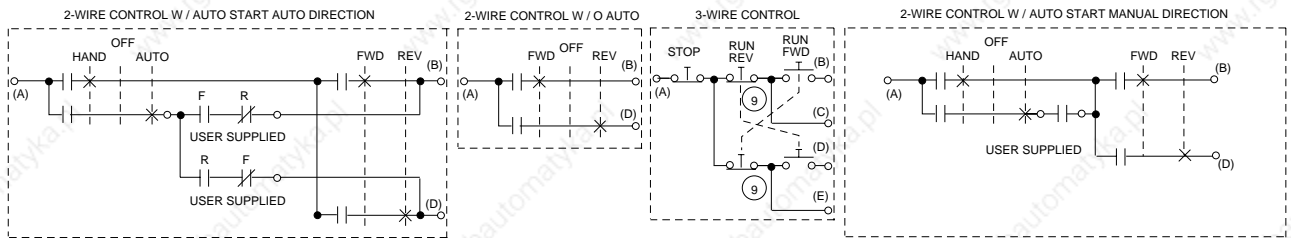

Enclosed ATS46 Starters



Enclosed ATS46 soft starters follow the recommended wiring diagrams shown on pages 16 through 18 to provide automatic SCR fault isolation. On non-combination controllers, the disconnect must be supplied separately, and must not exceed the maximum fuse or thermal magnetic circuit breaker size listed on page 15.

If an isolation contactor is not specified, the shunt trip relay must be tied into the external disconnect mechanism on non-combination starters to maintain the recommended level of SCR fault isolation.

Enclosed devices with a heavy duty rating utilize the next larger ALTISTART controller model, and are coordinated for larger overcurrent protective devices as required to obtain longer starting times.

The fault relay on enclosed units with isolation contactor (that is, type ***N) is pre-programmed for control of an isolation contactor. In this configuration, the R1 relay changes state upon a start command, and switches back if a fault is detected or after deceleration (if selected) is complete. This provides isolation of the soft starter and motor in a fault condition and when the motor is off.

Enclosed ATS46 Starters Catalog Number Identification

Catalog numbers for enclosed ATS46 soft starters may be interpreted using the following information:

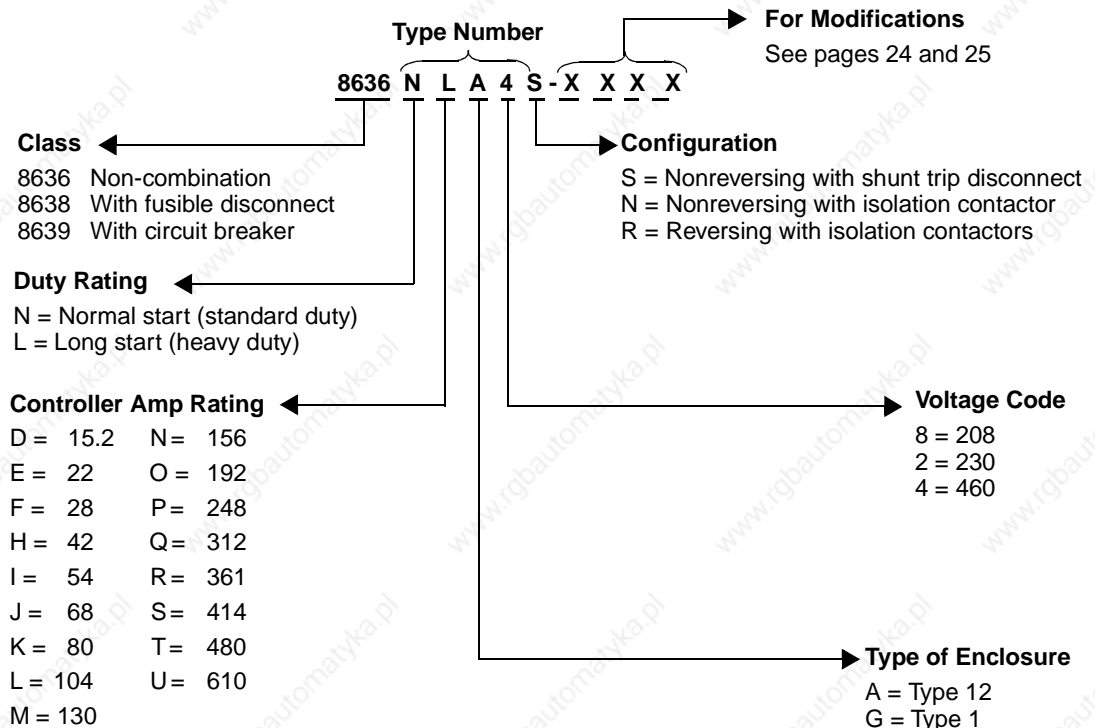

For example, catalog number 8638NLA4S-CP1 designates a 460 V, 75 hp enclosed ALTISTART combination starter with fusible disconnect, fuse block, and shorting contactor. The operator controls (HOA and Run pilot light) are mounted on the door.



Enclosed ATS46 Starters Technical Characteristics

Environment	Degree of protection	The Type 1 enclosures are for general-purpose use. The Type 12 enclosures are sealed to prevent dust from entering the cabinet. The doors are gasketed, the 22mm door-mounted operator devices are oil-tight. Enclosures are painted beige as standard.
	Conformity to standards	Conforms to UL508; Listed by UL Immunity to radioelectrical interference: conforming to IEC 801-3
	Operational test vibration	Conforming to IEC 721-3-3-3M3 amplitude peak to peak from 2-9 Hz
	Transit test to shock	Conforming to National Safe Transit Association and International Safe Transit Association test for packages weighing 100 pounds and over
	Ambient air temperature	Operation: Ambient conditions in installed area from 0 to 40° C; Storage: -25° to +70° C
	Maximum relative humidity	93% non-condensing
	Maximum operating altitude	1000 m (3300 ft.), derate by 1.2% for each additional 100 m up to 3000 m maximum.
Characteristics	3-phase supply voltage	208 ± 10%; 230 ± 15%; 460 ± 15%
	Control voltage	115 (CPT included as standard)
	Frequency	50 to 60 Hz
	Rated current	See Product Selection Tables on pages 21 through 23
	Motor power	2 to 500 hp
	Motor voltage	208, 220, 230, 240, 460, 480
	Duty cycle	Type N: 6 starts per hour, 300% current limit, 26 seconds per start – Class 10 overload Type L: 3 starts per hour, 350% current limit, 46 seconds per start – Class 20 overload
Operation	Methods of Starting	
	Torque ramp	Adjustable from 1 to 60 seconds by keypad
	Current limitation	Adjustable from 150% to 500% of starter-rated current by keypad
	Booster start-up pulse	Full voltage starting for 5 cycles of 50 to 100% mains voltage, selectable by keypad
	Methods of Stopping	
Freewheel	Coast to rest on stop command	
Torque deceleration ramp	Adjustable from 1 to 60 seconds by keypad	
INTELE braking	Selectable by keypad	
Status and Diagnostics	Door-mounted keypad for display of starter, motor, and fault statuses.	
Protection	Motor	
	Thermal overload	Solid state thermal overload is integral to the ALTISTART controller. Selectable overload class 10, 20, or 30 via keypad. Range is 50% to 100% of controller rated current.
	Shunt-trip disconnect	Removes all power from controller cabinet when the controller detects a fault condition.
	Isolation contactor	Removes supply power from SCR power circuit and motor when motor is not running or when the ALTISTART controller detects a fault condition.
	Controller	
	OCPD	Provides Type 1 coordination to the short circuit current withstand ratings listed in the selection tables.
Shorting contactor	Standard on controllers in Type 12 enclosures rated over 40A, and optional in Type 1 enclosures rated over 40 A; reduces temperature rise within the enclosure by eliminating the watts loss of SCRs. Control of contactor allows all forms of stopping as well as providing protective features.	
Thermal switch	Controllers rated 72 A and above have 2 thermal switches, one controls the fan (50° C), the other protects against overheating. Controllers rated below 72 A have one thermal switch to protect against overheating.	



Enclosed ATS46 Starters Product Selection

Class 8636 Non-Combination Enclosed ALTISTART 46 Controller

Voltage	Motor (hp)	Controller Rated Amps*	Type 1 Enclosure		Type 12 Enclosure		Short Circuit Rating with Thermal Magnetic Circuit Breaker ▲
			Connection for External Shutdown	With Isolation Contactor	Connection for External Shunt Trip	With Isolation Contactor	
			Type	Type	Type	Type	
208 V	3	15.2	NDG8S	NDG8N	NDA8S	NDA8N	5,000
	5	22	NEG8S	NEG8N	NEA8S	NEA8N	5,000
	7.5	28	NFG8S	NFG8N	NFA8S	NFA8N	5,000
	10	42	NHG8S	NHG8N	NHA8S	NHA8N	5,000
	15	54	NIG8S	NIG8N	NIA8S	NIA8N	5,000
	20	68	NJG8S	NJG8N	NJA8S	NJA8N	10,000
	25	80	NKG8S	NKG8N	NKA8S	NKA8N	10,000
	30	104	NLG8S	NLG8N	NLA8S	NLA8N	10,000
	40	130	NMG8S	NMG8N	NMA8S	NMA8N	10,000
	50	156	NNG8S	NNG8N	NNA8S	NNA8N	18,000
	60	192	NOG8S	NOG8N	NOA8S	NOA8N	18,000
	75	248	NPG8S	NPG8N	NPA8S	NPA8N	18,000
	100	312	NQG8S	NQG8N	NQA8S	NQA8N	18,000
	125	361	NRG8S	NRG8N	NRA8S	NRA8N	18,000
150	414	NSG8S	NSG8N	NSA8S	NSA8N	30,000	
200	610	—	—	NUA8S	NUA8N	30,000	
230 V	5	15.2	NDG2S	NDG2N	NDA2S	NDA2N	5,000
	7.5	22	NEG2S	NEG2N	NEA2S	NEA2N	5,000
	10	28	NFG2S	NFG2N	NFA2S	NFA2N	5,000
	15	42	NHG2S	NHG2N	NHA2S	NHA2N	5,000
	20	54	NIG2S	NIG2N	NIA2S	NIA2N	5,000
	25	68	NJG2S	NJG2N	NJA2S	NJA2N	10,000
	30	80	NKG2S	NKG2N	NKA2S	NKA2N	10,000
	40	104	NLG2S	NLG2N	NLA2S	NLA2N	10,000
	50	130	NMG2S	NMG2N	NMA2S	NMA2N	10,000
	60	156	NNG2S	NNG2N	NNA2S	NNA2N	18,000
	75	192	NOG2S	NOG2N	NOA2S	NOA2N	18,000
	100	248	NPG2S	NPG2N	NPA2S	NPA2N	18,000
	125	312	NQG2S	NQG2N	NQA2S	NQA2N	18,000
	150	361	NRG2S	NRG2N	NRA2S	NRA2N	18,000
200	480	—	—	NTA2S	NTA2N	30,000	
250	610	—	—	NUA2S	NUA2N	30,000	
460 V	10	15.2	NDG4S	NDG4N	NDA4S	NDA4N	5,000
	15	22	NEG4S	NEG4N	NEA4S	NEA4N	5,000
	20	28	NFG4S	NFG4N	NGA4S	NGA4N	5,000
	30	42	NHG4S	NHG4N	NHA4S	NHA4N	5,000
	40	54	NIG4S	NIG4N	NIA4S	NIA4N	5,000
	50	68	NJG4S	NJG4N	NJA4S	NJA4N	10,000
	60	80	NKG4S	NKG4N	NKA4S	NKA4N	10,000
	75	104	NLG4S	NLG4N	NLA4S	NLA4N	10,000
	100	130	NMG4S	NMG4N	NMA4S	NMA4N	10,000
	125	156	NNG4S	NNG4N	NNA4S	NNA4N	18,000
	150	192	NOG4S	NOG4N	NOA4S	NOA4N	18,000
	200	248	NPG4S	NPG4N	NPA4S	NPA4N	18,000
	250	312	NQG4S	NQG4N	NQA4S	NQA4N	18,000
	300	361	NRG4S	NRG4N	NRA4S	NRA4N	18,000
350	414	NSG4S	NSG4N	NSA4S	NSA4N	30,000	
400	480	—	—	NTA4S	NTA4N	30,000	
500	610	—	—	NUA4S	NUA4N	30,000	

* Controller rated amps are for standard duty operation. For applications requiring more than 10 starts per hour (maximum start time 26 seconds at 300% current limit), select the next larger controller size. The duty cycle must not exceed 2 starts per hour (maximum start time 45 seconds at 350% current or equivalent). Type NU units are rated for 2 starts per hour, with a maximum start time of 15 seconds.

▲ When coordinated with Type RK5 or Type L power fuses as recommended on page 14, the withstand rating is 65,000 A RMS for all models.



Enclosed ATS46 Starters Product Selection

Class 8638 Combination ALTISTART 46 Controllers – Fusible Disconnect

Voltage	Motor (hp)	Controller Rated Amps*	Non-Reversing				Reversing		Short Circuit Rating Type 1 Coordination
			With Shunt Trip Coil		With Isolation Contactor		Normal Start	Long Start	
			Normal Start	Long Start	Normal Start	Long Start			
			Type	Type	Type	Type	Type	Type	
208 V	3	15.2	NDA8S	LDA8S	NDA8N	LDA8N	NDA8R	LDA8R	65 kA
	5	22	NEA8S	LEA8S	NEA8N	LEA8N	NEA8R	LEA8R	
	7.5	28	NFA8S	LFA8S	NFA8N	LFA8N	NFA8R	LFA8R	
	10	42	NHA8S	LHA8S	NHA8N	LHA8N	NHA8R	LHA8R	
	15	54	NIA8S	LIA8S	NIA8N	LIA8N	NIA8R	LIA8R	
	20	68	NJA8S	LJA8S	NJA8N	LJA8N	NJA8R	LJA8R	
	25	80	NKA8S	LKA8S	NKA8N	LKA8N	NKA8R	LKA8R	
	30	104	NLA8S	LLA8S	NLA8N	LLA8N	NLA8R	LLA8R	
	40	130	NMA8S	LMA8S	NMA8N	LMA8N	NMA8R	LMA8R	
	50	156	NNA8S	LNA8S	NNA8N	LNA8N	NNA8R	LNA8R	
	60	192	NOA8S	LOA8S	NOA8N	LOA8N	NOA8R	LOA8R	
	75	248	NPA8S	LPA8S	NPA8N	LPA8N	NPA8R	LPA8R	
	100	312	NQA8S	LQA8S	NQA8N	LQA8N	NQA8R	LQA8R	
	125	361	NRA8S	LRA8S	NRA8N	LRA8N	NRA8R	LRA8R	
150	414	NSA8S	LSA8S	NSA8N	LSA8N	NSA8R	LSA8R		
200	610	NUA8S	—	NUA8N	—	NUA8R	—		
230 V	5	15.2	NDA2S	LDA2S	NDA2N	LDA2N	NDA2R	LDA2R	65 kA
	7.5	22	NEA2S	LEA2S	NEA2N	LEA2N	NEA2R	LEA2R	
	10	28	NFA2S	LFA2S	NFA2N	LFA2N	NFA2R	LFA2R	
	15	42	NHA2S	LHA2S	NHA2N	LHA2N	NHA2R	LHA2R	
	20	54	NIA2S	LIA2S	NIA2N	LIA2N	NIA2R	LIA2R	
	25	68	NJA2S	LJA2S	NJA2N	LJA2N	NJA2R	LJA2R	
	30	80	NKA2S	LKA2S	NKA2N	LKA2N	NKA2R	LKA2R	
	40	104	NLA2S	LLA2S	NLA2N	LLA2N	NLA2R	LLA2R	
	50	130	NMA2S	LMA2S	NMA2N	LMA2N	NMA2R	LMA2R	
	60	156	NNA2S	LNA2S	NNA2N	LNA2N	NNA2R	LNA2R	
	75	192	NOA2S	LOA2S	NOA2N	LOA2N	NOA2R	LOA2R	
	100	248	NPA2S	LPA2S	NPA2N	LPA2N	NPA2R	LPA2R	
	125	312	NQA2S	LQA2S	NQA2N	LQA2N	NQA2R	LQA2R	
	150	361	NRA2S	LRA2S	NRA2N	LRA2N	NRA2R	LRA2R	
200	480	NTA2S	LTA2S	NTA2N	LTA2N	NTA2R	LTA2R		
250	610	NUA2S	—	NUA2N	—	NUA2R	—		
460 V	10	15.2	NDA4S	LDA4S	NDA4N	LDA4N	NDA4R	LDA4R	65 kA
	15	22	NEA4S	LEA4S	NEA4N	LEA4N	NEA4R	LEA4R	
	20	28	NFA4S	LFA4S	NFA4N	LFA4N	NFA4R	LFA4R	
	30	42	NHA4S	LHA4S	NHA4N	LHA4N	NHA4R	LHA4R	
	40	54	NIA4S	LIA4S	NIA4N	LIA4N	NIA4R	LIA4R	
	50	68	NJA4S	LJA4S	NJA4N	LJA4N	NJA4R	LJA4R	
	60	80	NKA4S	LKA4S	NKA4N	LKA4N	NKA4R	LKA4R	
	75	104	NLA4S	LLA4S	NLA4N	LLA4N	NLA4R	LLA4R	
	100	130	NMA4S	LMA4S	NMA4N	LMA4N	NMA4R	LMA4R	
	125	156	NNA4S	LNA4S	NNA4N	LNA4N	NNA4R	LNA4R	
	150	192	NOA4S	LOA4S	NOA4N	LOA4N	NOA4R	LOA4R	
	200	248	NPA4S	LPA4S	NPA4N	LPA4N	NPA4R	LPA4R	
	250	312	NQA4S	LQA4S	NQA4N	LQA4N	NQA4R	LQA4R	
	300	361	NRA4S	LRA4S	NRA4N	LRA4N	NRA4R	LRA4R	
350	414	NSA4S	LSA4S	NSA4N	LSA4N	NSA4R	LSA4R		
400	480	NTA4S	LTA4S	NTA4N	LTA4N	NTA4R	LTA4R		
500	610	NUA4S	—	NUA4N	—	NUA4R	—		

* Type N units are rated for 6 starts per hour, with a maximum start time of 26 seconds at 300% current limit, or equivalent. Type L units are rated for 3 starts per hour, with a maximum start time of 46 seconds at 350% current limit or equivalent. Type NU units are rated for 2 starts per hour, with a maximum start time of 15 seconds.



Enclosed ATS46 Starters Product Selection

Class 8639 Combination ALTISTART 46 Controllers – Circuit Breaker Disconnect

Voltage	Motor (hp)	Controller Rated Amps*	Non-Reversing				Reversing		Withstand Rating Type 1
			With Shunt Trip Coil		With Isolation Contactor		Normal Start	Long Start	
			Normal Start	Long Start	Normal Start	Long Start			
Type	Type	Type	Type	Type	Type				
208 V	3	15.2	NDA8S	LDA8S	NDA8N	LDA8N	NDA8R	LDA8R	5,000
	5	22	NEA8S	LEA8S	NEA8N	LEA8N	NEA8R	LEA8R	5,000
	7.5	28	NFA8S	LFA8S	NFA8N	LFA8N	NFA8R	LFA8R	5,000
	10	42	NHA8S	LHA8S	NHA8N	LHA8N	NHA8R	LHA8R	5,000
	15	54	NIA8S	LIA8S	NIA8N	LIA8N	NIA8R	LIA8R	5,000
	20	68	NJA8S	LJA8S	NJA8N	LJA8N	NJA8R	LJA8R	10,000
	25	80	NKA8S	LKA8S	NKA8N	LKA8N	NKA8R	LKA8R	10,000
	30	104	NLA8S	LLA8S	NLA8N	LLA8N	NLA8R	LLA8R	10,000
	40	130	NMA8S	LMA8S	NMA8N	LMA8N	NMA8R	LMA8R	10,000
	50	156	NNA8S	LNA8S	NNA8N	LNA8N	NNA8R	LNA8R	18,000
	60	192	NOA8S	LOA8S	NOA8N	LOA8N	NOA8R	LOA8R	18,000
	75	248	NPA8S	LPA8S	NPA8N	LPA8N	NPA8R	LPA8R	18,000
	100	312	NQA8S	LQA8S	NQA8N	LQA8N	NQA8R	LQA8R	18,000
	125	361	NRA8S	LRA8S	NRA8N	LRA8N	NRA8R	LRA8R	18,000
150	414	NSA8S	LSA8S	NSA8N	LSA8N	NSA8R	LSA8R	30,000	
200	610	NUA8S	—	NUA8N	—	NUA8R	—	30,000	
230 V	5	15.2	NDA2S	LDA2S	NDA2N	LDA2N	NDA2R	LDA2R	5,000
	7.5	22	NEA2S	LEA2S	NEA2N	LEA2N	NEA2R	LEA2R	5,000
	10	28	NFA2S	LFA2S	NFA2N	LFA2N	NFA2R	LFA2R	5,000
	15	42	NHA2S	LHA2S	NHA2N	LHA2N	NHA2R	LHA2R	5,000
	20	54	NIA2S	LIA2S	NIA2N	LIA2N	NIA2R	LIA2R	5,000
	25	68	NJA2S	LJA2S	NJA2N	LJA2N	NJA2R	LJA2R	10,000
	30	80	NKA2S	LKA2S	NKA2N	LKA2N	NKA2R	LKA2R	10,000
	40	104	NLA2S	LLA2S	NLA2N	LLA2N	NLA2R	LLA2R	10,000
	50	130	NMA2S	LMA2S	NMA2N	LMA2N	NMA2R	LMA2R	10,000
	60	156	NNA2S	LNA2S	NNA2N	LNA2N	NNA2R	LNA2R	18,000
	75	192	NOA2S	LOA2S	NOA2N	LOA2N	NOA2R	LOA2R	18,000
	100	240	NPA2S	LPA2S	NPA2N	LPA2N	NPA2R	LPA2R	18,000
	125	312	NQA2S	LQA2S	NQA2N	LQA2N	NQA2R	LQA2R	18,000
	150	361	NRA2S	LRA2S	NRA2N	LRA2N	NRA2R	LRA2R	18,000
200	480	NTA2S	LTA2S	NTA2N	LTA2N	NTA2R	LTA2R	30,000	
250	610	NUA2S	—	NUA2N	—	NUA2R	—	30,000	
460 V	10	15.2	NDA4S	LDA4S	NDA4N	LDA4N	NDA4R	LDA4R	5,000
	15	22	NEA4S	LEA4S	NEA4N	LEA4N	NEA4R	LEA4R	5,000
	20	28	NFA4S	LFA4S	NFA4N	LFA4N	NFA4R	LFA4R	5,000
	30	42	NHA4S	LHA4S	NHA4N	LHA4N	NHA4R	LHA4R	5,000
	40	54	NIA4S	LIA4S	NIA4N	LIA4N	NIA4R	LIA4R	5,000
	50	68	NJA4S	LJA4S	NJA4N	LJA4N	NJA4R	LJA4R	10,000
	60	80	NKA4S	LKA4S	NKA4N	LKA4N	NKA4R	LKA4R	10,000
	75	104	NLA4S	LLA4S	NLA4N	LLA4N	NLA4R	LLA4R	10,000
	100	130	NMA4S	LMA4S	NMA4N	LMA4N	NMA4R	LMA4R	10,000
	125	156	NNA4S	LNA4S	NNA4N	LNA4N	NNA4R	LNA4R	18,000
	150	192	NOA4S	LOA4S	NOA4N	LOA4N	NOA4R	LOA4R	18,000
	200	248	NPA4S	LPA4S	NPA4N	LPA4N	NPA4R	LPA4R	18,000
	250	312	NQA4S	LQA4S	NQA4N	LQA4N	NQA4R	LQA4R	18,000
	300	361	NRA4S	LRA4S	NRA4N	LRA4N	NRA4R	LRA4R	18,000
350	414	NSA4S	LSA4S	NSA4N	LSA4N	NSA4R	LSA4R	30,000	
400	480	NTA4S	LTA4S	NTA4N	LTA4N	NTA4R	LTA4R	30,000	
500	610	NUA4S	—	NUA4N	—	NUA4R	—	30,000	

* Type N units are rated for 6 starts per hour, with a maximum start time of 26 seconds at 300% current limit, or equivalent. Type L units are rated for 3 starts per hour, with a maximum start time of 46 seconds at 350% current limit or equivalent. Type NU units are rated for 2 starts per hour, with a maximum start time of 15 seconds.



Enclosed ATS46 Starters Factory Modifications (Optional)

The enclosed ATS46 soft start family offers many optional factory modifications. This allows for factory customizing of the enclosed product to meet customer specifications. All factory modifications fall into two categories - Standard Modifications and Engineered Modifications. Standard Modifications do not change published lead times. Engineered Modifications will extend the published lead times.

Standard Modifications

General Category	Function	Mod Letter	Description	Restrictions/Rules
Push Buttons	Start-Stop	A ▲	Start (green) & Stop (red) Pushbuttons	Type numbers ending in S or N
	Fwd-Stop-Rev	A1 ▲	Forward (green), Reverse (amber), and Stop (red) Pushbuttons	Type numbers ending in R
	Emergency Off	A6	Pushbutton for immediate removal of control power	None
	External Overload Reset	A7	Motor OL thermal reset pushbutton - LI configured for reset	Not required with Mod Z24
Selector Switches	Hand-Off-Auto	C	3-position selector switch	Type numbers ending in S or N
	Stop-Run	C6	2-position selector switch	Type numbers ending in S or N
Pilot Lights	Run Pilot Light	P ■	Indication of Run state	None
	Run & Off Pilot Light	P ■ P ■	Indication of Run and Off states	None
	Run Push To Test Pilot Light	P2 ■	Indication of Run state	None
	Run & Off Push To Test Pilot Lights	P2 ■ P2 ■	Indication of Run and Off states	None
Control Transformer	100 Additional VA	T41	100 Additional VA for customer use	None
	200 Additional VA	T42	200 Additional VA for customer use	None
Meters	Ammeter	G91	Single phase ammeter fed from A1 output	None
	Elapsed Time	G97	7 Digit non-resettable elapsed run time meter	None
Power Configurations	Shorting Contactor	Z21	Provides shorting contactor on Class 8636 Types NHG* through NTG* controllers. (Standard for all other Class & Type controllers rated 42 amps or higher)	For Class 8636 Types NHG** through NTG** controllers only (Standard for all other Class & Type controllers rated 42 amps or higher)
	Non-isolated Full Voltage Bypass	Z24	Provides AC3 rated shorting contactor, normal/bypass selector switch, motor OL relay, door mounted OL reset pushbutton for across the line starting capability	Only for Class 8638 or 8639 Type numbers ending in N Not available with shunt trip breaker SCR fault isolation scheme
Communications	Serial Communication Module for MODBUS RTU, MODBUS ASCII, or UNI-TELWAY Protocols	Z1	Substitute communication module in place of keypad to allow for serial communications using either MODBUS RTU, MODBUS ASCII, or UNI-TELWAY protocols	None

▲ - Modifications A and A1 do not include illuminated pushbuttons

■ - Insert color code: Red = 1, Green = 2, Amber = 3



Enclosed ATS46 Starters Factory Modifications (Optional)

Engineered Modifications

General Category	Function	Mod Letter	Description	Restrictions/Rules
Control Options	Power-up on Delay Relay	K1	Provides an electronic time delay relay adjustable 0.1 to 60 seconds. Relay prewired to inhibit start for the users set delay time upon power-up.	None
	Miscellaneous Pilot Light	P9	Specify color and function of pilot light	None
	Miscellaneous Push-to-Test Pilot Light	P29	Specify color and function of push-to-test pilot light	None
	Auxiliary Starter Run Contacts	Q600	Provides (3) Form C contacts rated 5A @ 120 VAC wired to terminal blocks for customer use. Contacts change state when run command is issued or removed.	None
	Auxiliary Motor Run in Bypass Mode Contacts	Q601	Provides (3) Form C contacts rated 5A @ 120 Vac wired to terminal blocks for customer use. Contacts change state when motor is operated across the line with full voltage bypass starter.	Modification Z24 must be selected
	Auxiliary Auto Mode Contacts	Q602	Provides auxiliary auto mode contacts for customer use. Relay has (3) Form C contacts rated 5A @ 120 Vac wired to terminal blocks for customer use	Modification "C" (Hand-Off-Auto Selector Switch) must be selected
	Motor Space Heater	Q603	Provides control circuit contacts, 120V, 150-500 VA supply and fusing wired to terminals for customer use.	Specify VA requirements at time of order entry
	Spare Terminal Blocks	Q604	Provides (10) spare Class 9080 Type GM6 terminal blocks for customer use.	None
	Fault Pilot Light and Contacts	Q605	Provides door mounted fault pilot light (amber) and panel mounted relay with (2) Form C contacts rated 5A @ 120V wired to terminal for customer use.	None
Enclosure and Miscellaneous Options	Enclosure Space Heater	G55	Cabinet space heater and thermostat	None
	ID Engraved Nameplates	Q700	Provides a lamacoid nameplate, engraved with equipment designation	Specify engravings at time of order entry
	Permanent Wire Markers	Q701	Provides permanent type wire markers on control wiring assemblies	None
	ANSI #49 Enclosure Paint	Q702	Provides option to configure to Industry Standard ANSI #49 enclosure paint in lieu of RAL 7032 (Beige)	Not available if modification Q703 is selected
	ANSI #61 Enclosure Paint	Q702	Provides option to configure to Industry Standard ANSI #61 enclosure paint in lieu of RAL 7032 (Beige)	Not available if modification Q702 is selected
Power Options	Secondary Surge Arrester	Q800	Provides supplementary MOV protection using a Class 6671SDSA33650 SURGE-BREAKER™ secondary surge arrester Note: SCRs are protected by RC snubber circuits.	None
	Dual Motor OLs and Motor Branch Short Circuit Protection	Q801	Provides dual motor OL relays rated 1/2 the HP of the selected starter. Motor branch short circuit protection is provided per NEC requirements.	Total current rating of the combined motors must not exceed starter current rating.



Enclosed ATS46 Starters Dimensions - Wall Mounts

Dimensions for Enclosed Starters (Class 8636, 8638, and 8639)

Wall Mounts

Note: Shaded areas represent suggested conduit entries.

Conduit entries should not exceed the areas defined in the drawings.

This is a representation of Class 8638 and 8639 enclosed starters; Class 8636 enclosed starters are essentially similar except that they do not have a disconnect mechanism.

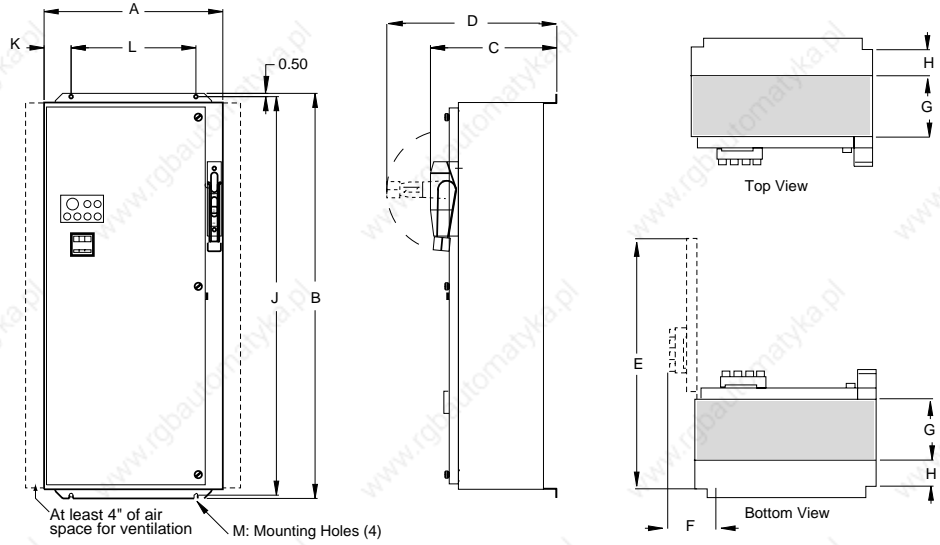

Figure 1

Class	Type		Mount	Dimensions in Inches (Figure 1)												Weight
	Standard Duty	Heavy Duty		A	B	C	D	E	F	G	H	J	K	L	M	
8638 8639	ND-NF	LD-LE	Wall	20.15	38.53	12.70	16.09	29.18	5.28	7.82	2.18	37.53	3.08	14.00	Ø 0.437	150 lbs
	NH-NM	LF-LL	Wall	27.21	62.01	17.73	21.12	41.38	6.32	12.79	2.21	61.01	4.12	19.00	Ø 0.562	380 lbs
Class	Shorting Contactor		Mount	Dimensions in Inches (Figure 1)												Weight
	Without Contactor	With Contactor		A	B	C	D	E	F	G	H	J	K	L	M	
8636	ND-NF	N/A	Wall	18.15	33.53	12.90	N/A	27.18	5.28	7.82	2.18	32.53	3.08	12.00	Ø 0.437	113 lbs
	NH-NL	NH-NM	Wall	25.21	52.01	17.96	N/A	39.38	6.32	12.79	2.21	51.01	4.12	17.00	Ø 0.562	293 lbs



Enclosed ATS46 Starters Dimensions - Floor Mount

Dimensions for Enclosed Starters (Class 8636, 8638, and 8639)

Floor Mounts

Note: Shaded areas represent suggested conduit entries.

Conduit entries should not exceed the areas defined in the drawings.

This is a representation of Class 8638 and 8639 enclosed starters; Class 8636 enclosed starters are essentially similar except that they do not have a disconnect mechanism.

NOTE: Consult Product Support Group for bottom conduit entry.

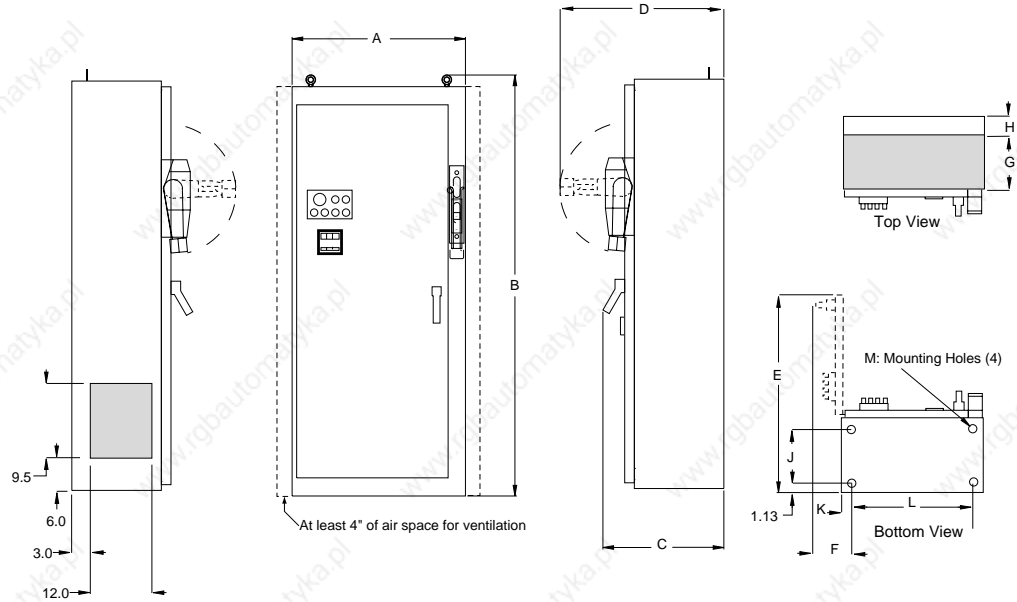

Figure 2

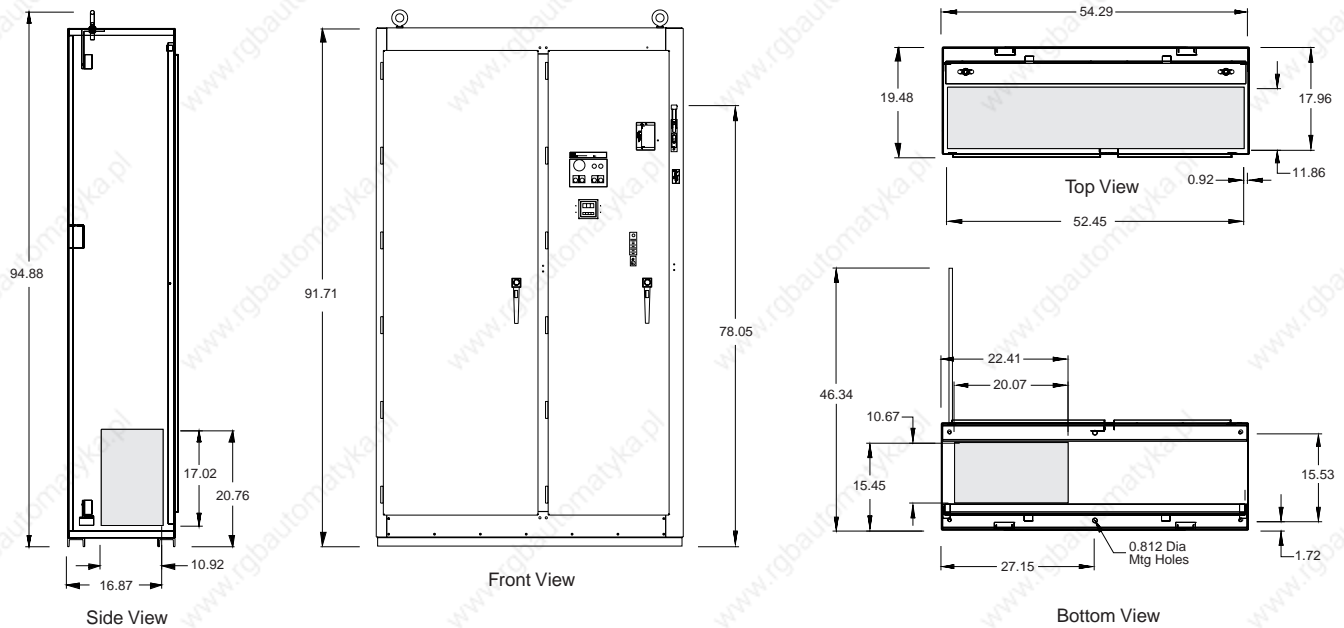

Figure 3

Class	Type		Mount	Dimensions in Inches (Figure 2)											Weight	
	Standard Duty	Heavy Duty		A	B	C	D	E	F	G	H	J	K	L		M
8638 8639	NN-NQ	LM-LP	Floor	34.21	92.68	22.36	26.00	50.25	4.75	13.50	5.25	16.50	1.13	31.75	Ø 0.687	850 lbs
	NR-NT	LQ-LT	Floor	38.21	92.68	22.36	26.00	54.25	4.75	12.07	6.68	16.50	1.13	35.75	Ø 0.687	1030 lbs
	NU	—	Floor	See figure 3 for details.											1425 lbs	
Class	Shorting Contactor		Mount	Dimensions in Inches (Figure 2)											Weight	
	Without Contactor	With Contactor		A	B	C	D	E	F	G	H	J	K	L		M
8636	NM-NP	NN-NQ	Floor	32.21	75.68	22.36	21.71	48.25	4.75	13.50	5.25	16.50	1.13	29.75	Ø 0.687	651 lbs
	NQ-NT	NR-NT	Floor	38.21	82.68	22.36	21.71	54.25	4.75	12.07	6.68	16.50	1.13	35.75	Ø 0.687	891 lbs
	NU	NU	Floor	See figure 3 for details.											1425 lbs	



Model 6 Motor Control Centers General Information



60–100 hp, 480 V
ALTISTART 46
Soft Start Unit

Motor Control Center Soft Start units provide a pre-engineered, integrated motor control center package consisting of a combination disconnect and soft start controller for reduced voltage starting and soft stopping of standard three-phase asynchronous induction (squirrel cage) motors. The Square D MCC Soft Start units integrate the latest technology ALTISTART 46 Soft Start from Telemecanique into a combination starter package for MCCs.

MCC Packaging

ALTISTART 46 Motor Control Center Soft Start units are available from 8.5 to 590 A in NEMA/EEMAC Type 1, Type 1A (gasketed), and Type 12 MCC enclosures. Units are available for three (3) phase, 60 Hz, 208 V, 240 V or 480 V, 3 wire or 4 wire systems. Each unit is a Motor Control Center style package able to be installed and connected to standard Model 5 or Model 6 MCC sections. Units are saddle type, plug-on construction up to 72 A standard duty/62 A heavy duty. Units are full height relay sections above 72 A standard duty/62 A heavy duty. A 20" Deep MCC is required for units rated above 302 A standard duty/257 A heavy duty. The Type 1, Type 1A, and Type 12 units are non-vented below 481 A. Above 480 A the unit includes a door vent and fans and are only available in NEMA/EEMAC Type 1 or 1A enclosures.

The circuit breaker disconnects used on MCC Soft Start units are thermal-magnetic type for standard duty versions and MAG-GARD magnetic only for heavy duty versions. Circuit breakers are sized per motor horsepower information provided with the order. All units with circuit breakers disconnects are shipped with current limiters/fuses to achieve a 65,000 ampere short circuit rating at 480 V. The fusible switch disconnects used on MCC Soft Start units are bladed switches up to 28 A standard duty/ 21 A heavy duty and automatic molded case switches for units above those ratings. Provisions for Class J or L fuses are provided. Fuses are not installed at the factory.



MCC ALTISTART Unit with Open Door



Model 6 Motor Control Centers Benefits / Features



Benefits / Features

- Current limiting short circuit protection provisions to provide high short circuit rating for the unit (65 kA at 480 V).
- Input power disconnect. Fusible switch or circuit breaker disconnects are available.
- Telemecanique D and F line contactors are standard (NEMA/EEMAC type contactors are optional).
- Door-mounted keypad for setup and monitoring of the ALTISTART controller.
- Control devices, if chosen, are mounted on the unit control station plate.
- Agency Listing: The Motor Control Center ALTISTART 46 Soft Start units are listed via the motor control center UL 845 procedures. The Canadian CSA label and Mexican NOM labels can also be applied.
- Shorting Contactor:
A shorting contactor is supplied on all units above 28 A for standard duty versions and above 21 A for heavy duty versions. This allows the motor current to bypass the Soft Start thyristors once the Soft Start has ramped up to full voltage/full speed. The use of a shorting contactor reduces temperature rise within the enclosure during steady state operation and requires less current carrying duty on the thyristors
- Input Isolation Contactor:
All MCC Soft Start units include an input contactor as standard to protect the motor, driven equipment or operating personnel in the event of a semi-conductor fault. The input contactor also opens when the motor is not in use. This provides protection from voltage transients when the electronics are most susceptible to damage. Control power is maintained after the input contactor is opened so fault diagnostics are available.
- Full Voltage Bypass:
All ALTISTART 46 MCC Soft Start units include a manual full voltage bypass scheme as standard to allow emergency full voltage starting of the motor in case the Soft Starter is unable to be used. This feature includes necessary control and power circuitry to manually start the motor with full voltage using a bypass enable/disable selector switch. An additional overload relay is provided to protect the motor in the bypass mode.
- (TCST[™]) Torque Control System:
The ALTISTART 46 uses TCS ramping to accelerate the motor to full voltage. Basing the acceleration ramp on the motor torque rather than current or voltage, as used in traditional soft starts, provides a linear speed ramp independent of the motor loading without tachometer feedback. The TCS ramp is also used for improved control of deceleration and eliminates the need for a special controller to handle water hammer problems.
- Integrated motor and controller thermal protection:
The motor and controller temperature are continuously calculated based on the controller nominal current and the current that is actually drawn. The cooling curve of the motor is simulated through an electronic circuit that stores the thermal state of the motor even if supply power is disconnected. A rise in motor temperature can be caused by a slight or severe overload of long or short duration. As shown in the figure below, the ALTISTART 46 controller creates a digital model of the motor temperature based on two thermal images. The first (T1) represents the level of temperature rise corresponding to "iron" (motor frame). The second (T2) represents the temperature rise of "copper" (stator windings). For each thermal image, two levels of alarm are detected. An overload pre-alarm is signaled via logic output when the thermal state exceed 105% for T1 and/or 130% for T2. A thermal fault is signaled via output relay and keypad when the temperature rise exceeds 110% for T1 and 140% for T2.

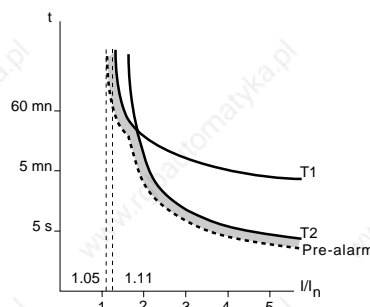

ALTISTART 46 Electronic Overload Thermal Trip Curves



Model 6 Motor Control Centers Benefits / Features

Starting and Stopping

Four types of starting are available:

- TCS soft start - adjustable from 1 to 60 seconds
- TCS with "boost" - adjustable 50 to 100% of mains voltage
- Current limit - adjustable from 150 to 500% of controller rating voltage ramping

Three types of stopping are available

- Freewheel or coast to stop
- TCS soft stop - adjustable from 1 to 60 seconds
- INTELE Braking(- adjustable from 50 to 100%

Protective Features

- Motor thermal overload protection - choice of Class 10 or 20
- Soft Start thermal protection
- Motor phase loss protection
- Mains supply failure of greater than 500ms
- Overcurrent fault
- Locked rotor fault
- Mains frequency outside limits of +/- 3.6Hz
- Selectable protection, including:
 - Phase reversal
 - Stall and jam
 - Thermal overload pre-alarm
 - Current threshold alarm
 - Underload fault

Monitoring and Indication

Door Mounted Keypad

- Displays setup parameters and fault codes for previous five faults.
- Factory preset for most common adjustments.
- Security to avoid accidental controller modifications is provided by dip switches on the back of the keypad, which must be adjusted to provide access to 3 programming levels.

Real-time indication via the digital keypad of:

- Motor current
- Load Torque
- Motor thermal state
- Power factor
- Fault status

Two logic outputs:

- Motor thermal overload or indication of motor current present
- Current threshold alarm

One analog output for 4 to 20 or 0 to 20 mA indication of motor current torque, thermal state, or power factor.



Model 6 Motor Control Centers Applications

One logic input, which is configurable for force to freewheel, thermal overload reset or indication of external fault.

Options:

- NEMA/EEMAC HP rated contactors substituted for Telemecanique D or F line contactors
- Reversing
- 120 Vac Control Power Transformer
- 120 Vac customer VA capacity added to control power transformer
- Push To Test Pilot Lights
- LED Pilot Lights
- Auxiliary interlocks

Application

Unlike NEMA/EEMAC rated electromechanical devices, selection of solid-state reduced voltage starters is application dependent. Motor related factors (such as torque, base speed, and nameplate Full Load Amps), combined with load characteristics (such as connected inertia, acceleration, and running requirements), must be considered for optimum application of solid-state reduced voltage starters. See the ALTISTART catalog (Square D Publication #8638CT9701) and Product Data Bulletin #8600PD9201 for additional technical information.

For convenience, the ALTISTART selection tables are based on nominal horsepower ratings. Remember, nameplate Full Load Amps and starting characteristics vary depending on motor manufacturer, base speed, and design. ALTISTART units must be selected based on maximum unit amps, not horsepower.

The ALTISTART 46 Soft Start is offered in 2 versions: Standard Duty and Heavy Duty. The factory will program the soft start and size the components for standard or heavy duty based on the catalog number entered. For heavy duty applications the soft start has been derated by one size before being packaged in the MCC unit.

Standard Duty: Typical examples of standard duty applications include most fans and centrifugal pumps. Other standard duty applications include machines such as screw conveyors or conveyors that are started with little or no load. For standard duty, the ALTISTART 46 is preset for Class 10 motor overload protection, a 300% current limit and 10 second acceleration ramp. Standard duty operation is defined as 10 starts per hour, with a maximum start time of 23 seconds at 300% current limit or equivalent.

Heavy Duty: Typical heavy duty applications include high inertia loads or other loads requiring long acceleration times. Some examples of heavy duty applications include grinders, crushers and presses as well as high inertia fans and saws. For heavy duty, the ALTISTART 46 is preset for Class 20 motor overload protection, a 350% current limit and 15 second acceleration ramp. Heavy duty is defined as 5 starts per hour, with a maximum start time of 46 seconds at 350% current limit or equivalent.

Contact the Square D Field Office for additional application information and pricing for applications requiring:

- 2 speed or wye-delta motors
- motors other than NEMA/EEMAC Design B
- low slip motors
- power factor correction capacitors
- multi-motor applications
- horsepower greater than 500 hp at 460 V or 200 hp at 200/230V



Model 6 Motor Control Centers Selection

Selection

To select an MCC Soft Start unit, refer to the unit selection tables on the following pages in this section and:

1. Select either circuit breaker or fusible switch disconnect type unit.
2. Select Standard Duty or Heavy Duty rated unit based on the duty cycle, acceleration time and starting current requirements for the load. The ALTISTART 46 Soft Start will be preset for Standard Duty or Heavy Duty at the MCC factory according to the catalog number.
3. Choose a unit with an ampere rating above the nameplate Full Load Amperes (FLA) of the motor being controlled by the soft start.
4. Select a Unit Control Circuit Variation to meet the control power requirements for the application. If no option is chosen the unit will be supplied with unfused separate 120 V control circuit with control power disconnect.
5. Add Power and Control Options required for the application.



Model 6 Motor Control Centers Selection

Standard Duty ALTISTART™ 46 Soft Starts with Circuit Breaker Disconnects (Pumps, Fans, Lightly Loaded or Unloaded Starting Applications)

Standard duty operation is defined as 10 starts per hour with a maximum start time of 23 seconds at 300% current limit or equivalent.

Motor Rated Horsepower			Max. Unit Amps	Thermal Magnetic C/B Amps	Space (Inches)
200V	230V	460V			
—	3	—	10	20	36
3	—	7.5	12	25	
—	—	10	14	30	
—	5	—	16	35	
5	—	—	18	40	
—	—	—	20	45	
—	—	15	21	50	
—	7.5	—	24	50	48
7.5	10	20	28	60	
10	—	25	36	70	
—	—	30	40	80	
15	20	40	54	90	
20	25	50	69	100	
—	—	—	72	110	
25	30	60	80	110	72 (20W)
30	—	—	90	125	
—	40	75	105	150	
40	—	—	115	175	
—	50	100	140	200	72 (30W)
50	60	125	160	225	
60	—	—	172	250	
—	75	150	200	300	72 (35W)
75	100	200	250	350	
100	—	—	285	400	
—	—	250	302	450	72 (50W)
150	150	350	439	600	
—	200	400	480	800	
200 ①	—	450 ①	528	800	
—	—	500 ①	590	900	

① Available in NEMA Type 1 and Type 1A enclosures only.



Model 6 Motor Control Centers Selection

Heavy Duty ALTISTART 46 Soft Starts With Circuit Breaker Disconnects (High Inertia Loads or Loads with Long Starting Times)

Heavy duty operation is defined as 5 starts per hour with a maximum start time of 46 seconds at 350% current limit or equivalent.

Motor Rated Horsepower			Maximum Unit Amps	MAG-GARD C/B Amps	Space (Inches)
200V	230V	460V			
3	3	10	14	15	36
5	5	15	21	30	
—	7.5	—	24	30	
10	10	25	36	50	48
20	20	40	62	100	
30	40	75	105	250	
60	60	125	176	400	72 (20W)
75	100	200	257	400	72 (30W)
150	200	400	480	600	72 (35W)
200 ①	—	500 ①	590	800	72 (50W)

① Available in NEMA Type 1 and 1A enclosures only.

Standard Duty ALTISTART 46 Soft Starts With Fusible Switch Disconnects (Pumps, Fans, Lightly Loaded or Unloaded Starting Applications)

Motor Rated Horsepower shown for convenience only. Size per actual motor full load amperes. Standard duty operation is defined as 10 starts per hour with a maximum start time of 23 seconds at 300% current limit or equivalent)

Motor Rated Horsepower			Max. Unit Amps	Switch Amps (Fuse Class)	Space (Inches)
200 V	230 V	460 V			
5	5	10	20	30 (J)	36
—	—	15	21	60 (J)	
10	10	30	40	60 (J)	
20	20	40	63	100 (J)	48
—	25	50	72	200 (J)	
40	40	100	129	200 (J)	
—	50	—	140	400 (J)	72 (20W)
60	75	150	200	400 (J)	72 (30W)
75	100	200	258	400 (J)	72 (35W)
100	—	250	302	600 (J)	
150	150	300	410	600 (J)	
—	200	400	480	800 (J)	72 (50W)
200	—	450 ①	572	800 (J)	
—	—	500 ①	590	1000 (J)	

① Available in NEMA Type 1 and 1A enclosures only.



Model 6 Motor Control Centers Options

Heavy Duty ALTISTART 46 Soft Starts With Fusible Switch Disconnects (High Inertia Loads or Loads with Long Starting Times)

Heavy duty operation is defined as 5 starts per hour with a maximum start time of 46 seconds at 350% current limit or equivalent.

Motor Rated Horsepower			Max. Unit Amps	Switch Amps (Fuse Class)	Space (Inches)
200 V	230 V	460 V			
5	5	10	20	30 (J)	36
7.5	10	20	28	60 (J)	
10	—	30	40	60 (J)	
20	20	40	63	100 (J)	48
—	25	50	72	200 (J)	
40	40	100	129	200 (J)	
—	50	—	140	400 (J)	72 (20W)
60	75	150	200	400 (J)	72(30W)
75	100	200	258	400 (J)	72 (35W)
100	—	250	302	600 (J)	
150	150	300	410	600 (J)	72 (50W)
—	200	400	480	800 (J)	
200 ①	—	450 ①	572	800 (J)	
—	—	500 ①	590	1000 (J)	

① Available in NEMA Type 1 and 1A enclosures only.

ALTISTART Unit Power Options

Description	Motor Rated Horsepower (Standard Duty Rated Soft Start)			Space (Inches)
	200 V	230 V	460 V	
Substitute NEMA/EEMAC Contactors Provide horsepower rated NEMA/EEMAC Type S contactors in place of Telemecanique, AC3 rated D or F line contactors. Also provides 8501 Type XO control relays in place of Telemecanique D line relays.	20	25	50	6
	40	50	100	0
	60	75	150	5 added to width
	75	100	200	0
	100	100	250	25 added to width (20" Deep)
	150	200	400	10 added to width
Reversing Capability Not available with NEMA/EEMAC Type Contactors	5	5	15	0
	20	25	50	6
	40	50	100	0
	60	75	150	5 added to width
	200	200	500	0
Shorting Contactor	7.5 ①	10 ①	20 ①	0
	200	200	500	Standard

① Freewheel stopping must be acceptable in these applications. No controlled deceleration available.



Model 6 Motor Control Centers Control Circuit Variations

Description	Application	Space (Inches)			
Unfused Separate 120 V Control Circuit with Single Pole Double Throw (SPDT) Control Power Disconnect	Standard on all Starters unless a control power transformer or line voltage control is chosen.	0			
Unfused Separate 120 V Control Circuit with Double Pole Double Throw (DPDT) Control Power Disconnect					
Fused Separate 120 V Control Circuit with Control Power Disconnect	Includes one fuse and control circuit interlock.	0			
Fused Line Voltage Control Circuit (two primary fuses; max. 240V line voltage)	Control power taken between phases.				
	Control power taken from phase and neutral.				
Operating Mechanism Interlock (Added to Control Power Transformer)	SPDT	0			
	DPDT				
Fused Control Power Transformer Available transformers are shown for each horsepower range. VA rating shown in parenthesis is the excess capacity for other control devices after subtracting the contactor requirements for Telemecanique contactors. For NEMA/EEMAC contactors contact the Square D Field Office.	Motor Rated Horsepower (Standard Duty Rated Soft Start)				
			208	230	460
	50 (5) 100 (55) 150 (105) 300 (255)		5	5	15
	100 (11) 150 (61) 300 (211)		20	25	50
	300 (185) 500 (385)		40	50	100
	500 (267) 750 (517)		100	100	250
	300 (227) 500 (427)		150	200	400
	300 (207) 500 (407)		200	—	500



Model 6 Motor Control Centers Control Options

Description	Space (Inches)
1.5–30 sec. start delay	0 if one per starter; 3 for up to three max.
Unwired 2N.O./2N.C. D line relay	
Unwired 2N.O./N.C. D line relay; 1N.O./1N.C. 10–180 sec. on delay timer	
Unwired 2N.O./N.C. D line relay; 1N.O./1N.C. 10–180 sec. off delay timer	
Pilot Lights (max. five devices)	0
Run pilot light (Red)	
Off pilot light (Green)	
Alarm pilot light (Yellow)	
Power On pilot light (Blue)	
Start Enabled pilot light (White)	
Fault pilot light (Red)	
LED Pilot Lights (max. five devices)	
Run pilot light (Red)	
Off pilot light (Green)	
Alarm pilot light (Yellow)	
Fault pilot light (Red)	
Push To Test Pilot Lights (max. five devices)	
Run pilot light (Red)	
Off pilot light (Green)	
Alarm pilot light (Yellow)	
Start Enabled pilot light (White)	
Fault pilot light (Red)	
LED Push To Test Pilot Lights (max. five devices)	
On pilot light (Red)	
Off pilot light (Green)	
Alarm pilot light (Yellow)	
Fault pilot light (Red)	
Start/Stop push buttons	
Hand/Off/Auto selector switch	
Forward/Off/Reverse selector switch	
AC ammeter with current transformer	
Elapsed Time Meter	
Substitute Type K (max. three devices)	
Auxiliary Electrical Interlocks	
1 N.O./1 N.C. Contact on start enabled	
1 N.O./1 N.C. On input contactor	
1 N.O./1 N.C. On shorting/bypass contactor	



Model 6 Motor Control Centers Options

DAA		SS	
	BYPASS		NORM
1L1			x
2T1	x		
3L2			x
4T2	x		

ALTI-START
Wiring Diagram

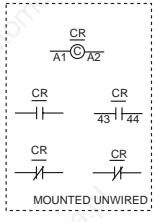
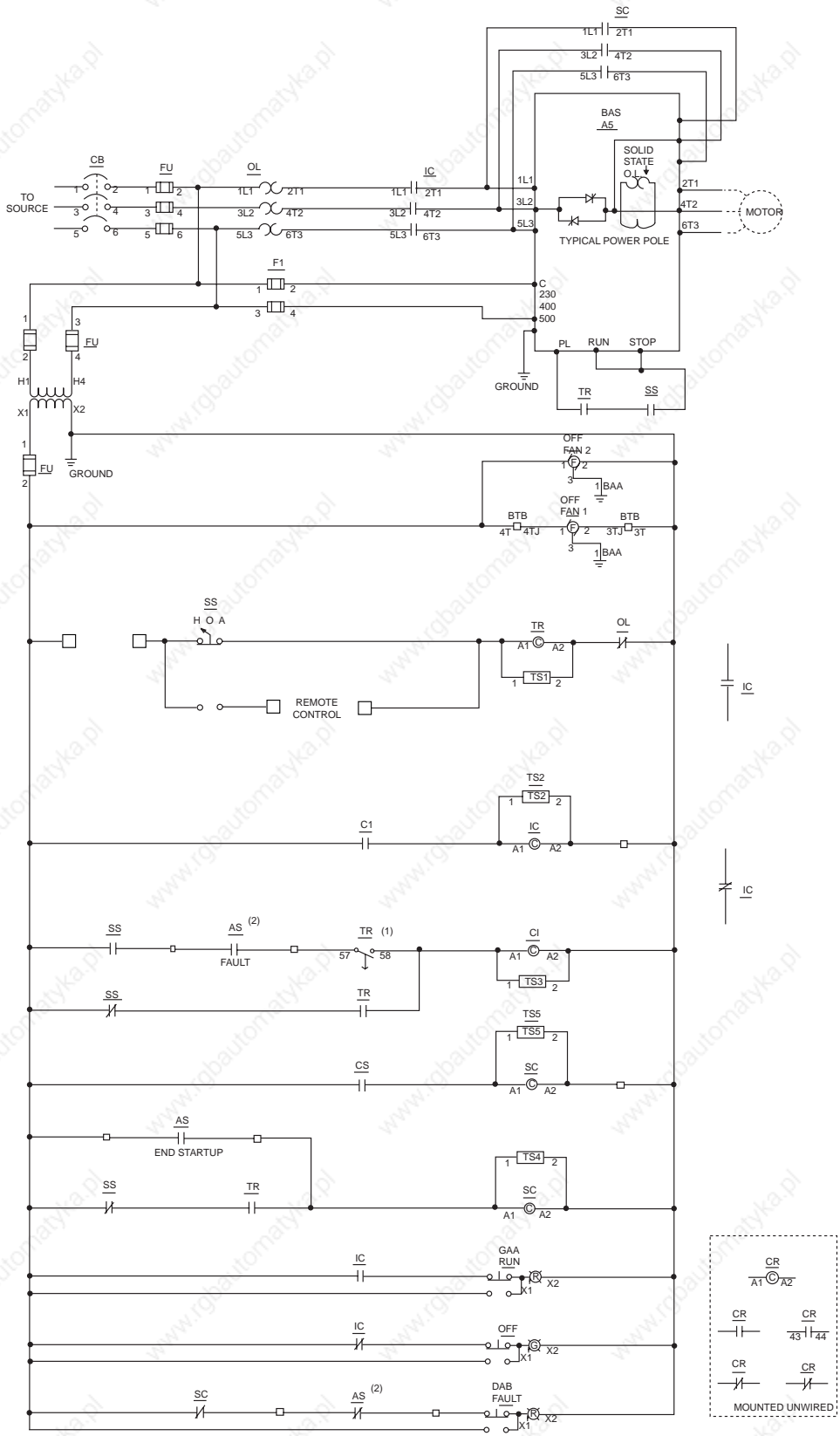

Application Considerations

Occasionally applications arise which use motors other than the standard NEMA Design B motor. The following is a brief description of some of these applications with information on how they can be used with an ATS46 controller. Contact your local Square D sales office for assistance with these and other special application requirements.

Two-Speed, Two-Winding

An ATS46 controller may be used on the line side of an electromechanical two-speed contactor to soft start a two-speed, two-winding motor in high or low speed. The ATS46 controller can also soft-start the motor in low speed only, allowing the motor to transition to high speed without soft starting.

Wye Delta

An ATS46 controller may be used on a wye delta motor when the motor is connected in delta.

Part Winding

An ATS46 controller may be used on a part winding motor by permanently connecting the two windings in parallel.

Wound Rotor

An ATS46 controller is not recommended for use with a wound rotor motor. If using an ATS46 controller on a wound rotor motor, contact the motor manufacturer for recommended starter resistance to add while starting.

Multiple Motors

An ATS46 controller may be used on a multi-motor application when all motors are operated at the same time. The current rating of the starter must be greater than or equal to the total of all the current ratings of the motors and individual overload and short circuit protection is provided for each motor.

Cascading Motors

The ATS46 controllers logic input can be configured to enable deceleration control (in addition to soft starting) for up to 264 motors that are started in sequential order. Separate overload and short circuit protection is required for each motor.

Line Contactor or Shunt Trip Breaker

Proper installation of any solid state device must have an automatic means of disconnecting the device from the line in the event of a fault condition. Specifically, for the case of solid state starters that use SCRs as the control component, there must be a method for creating an "air gap" in the event of a component failure. It is recommended that an isolation contactor or shunt-trip breaker be used to obtain this "air gap."

Power Factor Correction Capacitors

The capacitors must be located on the line side of the ATS46 controller. A separate contactor should be used to bring the capacitors on-line using the auxiliary of the shorting contactor and to switch the capacitors off when the motor is off. The maximum correction for power factor should not be more than 95%. Capacitors should not be connected directly to a motor controlled by an ATS46 controller.

2-Pole Motors

Contact the motor manufacturer before applying reduced voltage starters to 2-pole motors. The starting torque characteristics of 2-pole motors is typically below nominally rated torque through most of the starting cycle and may not allow for starting at reduced voltage.

Additional product and application support information is available via product data bulletins for the following:

Power Circuit Recommendations	8638PD9601
Overvoltage Protection	8638PD9602
Power Factor Correction Capacitors	8638PD9603
Energy Savings	8638PD9604
Full Voltage Bypass Starting	8638PD9605
Generator Power and Soft Starts	8638PD9606
Torque Control System	8636PD9703

These documents are available on the Square D website "www.squared.com" under Products in PDF (Adobe Acrobat format)



Comparison of Reduced Voltage Starting Methods

Comparison of Starting Methods

The graphs shown below illustrate motor performance when the motor is started at full voltage, when using an autotransformer, when using a wye delta electromechanical reduced voltage starter, or when using a soft starter.

When using either the autotransformer or wye delta reduced voltage starting method, a single level of voltage is applied during the start mode. After an adjustable period of time, the contactors switch to the run mode. As shown in the figures below, when switched to the run mode the motor will draw current and produce current at full voltage values (which depend on the speed of the motor when the transition is made).

Soft-starting a motor also provides the benefits of reduced current inrush and starting torque. When a soft start is used, the voltage of the three-phase supply to the motor is steadily increased by the use of a thyristor bridge. The bridge consists of back-to-back pairs of thyristors connected in each phase of the AC supply, as shown in Figure A on the next page.

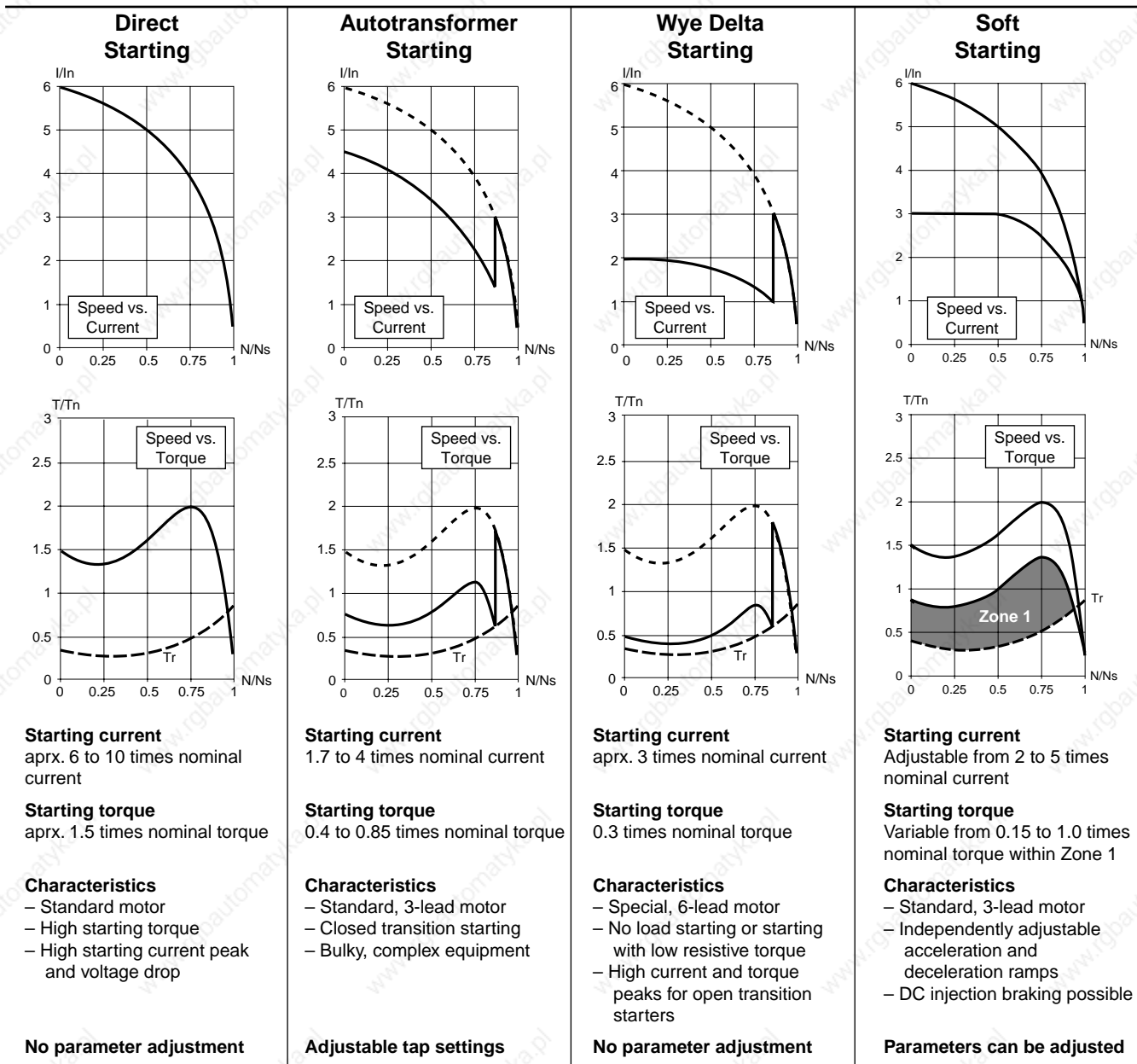

Suggested Specifications

The following is a sample specification for selecting a soft start product. It is intended to assist you in acquiring the best product for your application. This material is not copyrighted, and you may use it in whatever fashion best suits your particular needs.

Specification for Enclosed Combination Starters

Part 1 General

1.01 Scope of Work

- A. These specification requirements are for solid state reduced voltage motor controllers herein referred to as soft starts.
- B. They are for use with NEMA design B, AC motors to reduce the current in-rush as well as mechanical shocks that can result from starting or stopping a motor across the line.

1.02 Quality Assurance

- A. The soft start shall be listed by an independent testing laboratory in accordance with Electric Industrial Control Equipment Specification UL508.
- B. The soft start shall carry the CE mark for indication of compliance to low voltage and EMC directives.
- C. The manufacturer shall be a certified ISO 9002 facility.

1.03 Warranty

- A. An eighteen month warranty shall be provided on materials and workmanship from date of invoice.

Part 2 Product

2.01 General Description

- A. The soft starter shall be provided by the manufacturer in an enclosure rated as NEMA Type 12 for Industrial use.
 - 1. Enclosure shall include a door mounted digital keypad for adjusting the soft start parameters and viewing the motor, soft start and fault status without opening the enclosure door.
 - 2. Provisions shall be available for padlocking the enclosure door.
- B. The enclosed product shall be provided complete with one of the following overcurrent protective devices (OCPDs) for Type 1 short circuit protection:
 - 1. Molded case disconnect switch and in-line fuse block for RK Type power fuses from 10 to 600 A or Class L power fuses from 601 to 1600 A. Short circuit withstand rating shall be 65KA_{rms}.
 - 2. Magnetic only circuit breaker. Short circuit withstand rating shall be based on the motor horsepower as defined in UL 508.
- C. The motor must be automatically protected from solid state component failure by one of the following means:
 - 1. Shunt trip coil to trip disconnect in the event of a controller fault condition including a shorted thyristor.
 - 2. Isolation contactor that opens when the motor is stopped or when the controller detects a fault condition including a shorted thyristor.
- D. The soft start shall utilize a thyristor (SCR) bridge consisting of at least two SCRs per phase to control the starting and stopping of industry standard motors.
- E. The soft start shall provide torque control for linear acceleration without external feedback independent of motor load or type of application. The gating of the thyristors will be controlled in such a manner to ensure smooth and stable acceleration ramp.
- F. The soft start shall be controlled by a microprocessor that continuously monitors the current and controls the phasing of the SCRs. Analog control algorithms shall not be allowed.
- G. All soft start power ratings will utilize the same control module.



Suggested Specifications

- H. A shorting contactor shall be supplied with soft starts rated 47 A or above in Type 12 enclosures. Protective features and deceleration control options integral to the soft start shall be available even when the shorting contactor is employed.

2.02 Motor Data

- A. The soft start shall be designed to operate a NEMA design B motor with a nameplate rating of ___ horsepower, rated for ___ amp continuous at ___ volts.

2.03 Ratings

- A. The soft start shall be designed to operate in an ambient temperature 0°C to 40°C. For ambient temperatures between 40°C and 60°C, derate the current by 1.2% per °C above 40°C.
- B. Storage temperature range shall be -25°C to 70°C.
- C. Maximum relative humidity shall be 93% at 40°C, non-condensing.
- D. The soft start shall be designed to operate in altitudes up to 3300 ft. For higher altitudes, derate by 0.5% for each additional 330 ft.
- E. The soft start shall be capable of operation between -15% and +10% of nominal voltage rating
- F. The soft start shall automatically adapt for operation at 50 or 60 Hz. Frequency tolerance shall be ± 5% when starting and between +5% and -15% during steady state operation.
- G. The soft start shall be capable of supplying 300% of rated full load current for 30 seconds at maximum ambient temperature.
- H. The SCRs shall have a minimum P.I.V. rating of 1400 Vac. Lower rated SCRs with protection by MOVs are not acceptable.

2.04 Adjustments and Configurations

- A. All dialogue functions, display units, remote functions, terminal blocks, configuration switches and adjustment potentiometers shall be accessible on the front of the control module. Exposure to control circuit boards or electrical power devices during routine adjustments is prohibited.
- B. Digital indication shall provide, as a minimum, the following conditions:
 - 1. Soft start status - ready, starting/stopping, run.
 - 2. Motor status - current, torque, thermal state, power factor.
 - 3. Fault status - Motor thermal overload, starter thermal fault, phase fault, frequency fault, supply fault, locked rotor fault, motor underload, max start time exceeded, external fault, serial link fault, phase inversion, internal failure, overcurrent.
- C. The starter must be preset to the following for adjustment-free operation in most applications:
 - 1. Torque acceleration ramp of 10 seconds.
 - 2. Current limitation to 300% of the motor full load current rating.
 - 3. Class 10 overload protection.
 - 4. Motor current preset per NEC and UL tables for standard hp motors.
- D. A digital keypad shall be utilized to configure the following operating parameters as required:
 - 1. Motor full load amps adjustable from 50 to 130% of the controller's rating.
 - 2. Current limitation on starting adjustable from 1.5 to 7 times rated motor current.
 - 3. Torque ramp adjustable from 1 to 60 seconds.
 - 4. Initial torque adjustable from 10 to 100% of nominal motor torque.
 - 5. Torque limit adjustable from 10 to 200% of nominal motor torque.
 - 6. Maximum start time adjustable from 10 to 999 seconds.
 - 7. Voltage boost adjustable from 50 to 100% of the nominal supply voltage.
 - 8. Selection of freewheel, soft stop or braking.
 - 9. Adjustable soft stop torque ramp time from 1 to 60 seconds.
 - 10. Threshold to change to freewheel following a soft stop from 0 to 100% of the nominal motor torque.
 - 11. Braking torque level adjustable from 0 to 100% effectiveness.



Suggested Specifications

12. Selection of Class 2, 10, 10A, 15, 20, 25 or 30 motor thermal overload protection.
- E. A digital keypad shall be utilized configure the following controller parameters as required:
1. Selectable automatic reset operation.
 2. Cancellation of the torque control loop for multi-motor installations.
 3. Adjustment of the stator loss estimation for specialty motors.
 4. Assignment of controller inputs and outputs.
 5. Activation of phase reversal protection.
 6. Reset of motor thermal state.
 7. Return to factory settings.
 8. Activation of test mode for use with low power motors.
 9. Indication of elapsed time in hours of starting, running and stopping.
- F. Output relays shall provide the following status indications:
1. One form A and one form B minimum for indication of fault or control of an isolation contactor.
 2. One form A for indication that torque ramp is complete and current is below 130% motor FLA (End of start).
- G. Additional inputs and outputs shall be available to provide the following status indications:
1. One logic input for force to freewheel, indication of external fault, force to local control, control of cascading motors, or external motor overload reset.
 2. One logic output for indication of motor thermal overload pre-alarm or presence of motor current and one logic output to indicate overcurrent alarm.
 3. One analog output shall be available for 4 to 20 or 4 to 20 milliamp indication of motor current, torque, thermal state, or power factor.
- H. Relay and I/O functions listed above must be isolated with respect to common.

2.05 Protection

- A. A microprocessor controlled thermal protection system shall be included which continuously calculates the temperature-rise of the motor and soft start and provides:
1. An overload pre-alarm which indicates by relay contact that the motor has exceeded its rated temperature rise by 110%. This function shall be annunciation only.
 2. A thermal fault condition which stops the motor if the temperature-rise exceeds 120% of the motor thermal capability.
 3. An analog electronic circuit with a time-constant adjustable to the motor's thermal cooling time-constant ensuring the memorization of the thermal state even after power supply disconnection or shorting out of the power semiconductors.
- B. The soft start shall provide phase loss, phase reversal, underload, stall, and jam protection.
- C. The integral protective features shall be active even if an external shorting contactor is used to bypass the SCRs during steady state operation.

2.06 Control Options

- A. The soft start's control circuit shall be fed from the line supply and be completely independent of the power circuit and separate from the control logic.
- B. The peripheral soft start control circuitry shall be operated at 120 Vac 60 Hz from a control power transformer included within the enclosure.
- C. Operator devices shall be door mounted and shall be (*choose all that apply*):
1. Red STOP and green START push buttons.
 2. Three position H-O-A switch which provides for manual (HAND) start or remote signal (AUTO) start from user-supplied relay contacts.
 3. Red STOP, green FORWARD, and amber REVERSE push buttons mounted on the door control island (*available with reversing starter only*).



Suggested Specifications

4. Red or green RUN pilot light illuminated whenever the soft start is provided a run command and no fault condition is present.
5. Red or green OFF pilot light illuminated whenever the soft start is supplied with control power and no run command is present
6. All operator devices shall be remote-mounted using supplied 120 Vac control logic. Clearly labeled terminals shall be provided for field installation.

2.07 Shorting Contactor (standard on soft starts 47 A and above)

- A. A microprocessor shall control the operation of the shorting contactor via an output relay.
- B. The shorting contactor shall close, shorting the thyristors after the motor current is below 130% of motor FLA and voltage is below nominal voltage (indicating ramp complete), and open on a stop command to allow a deceleration ramp.
- C. Overload protection integral to the soft start shall continue to protect the motor when shorting is utilized.

Part 3 Execution

3.01 Installation

- A. The soft start shall be installed per the manufacturer's specifications with a minimum clearance of 4 inches on each side of the enclosure.
- B. A standard wiring diagram shall be included for making the appropriate electrical connections.

3.02 Start Up (option)

- A. The services of a qualified manufacturer's technical representative shall be available to install, test, and start up all soft starts furnished under this specification.

Specification for Open Style Starters

Modifications for specification of open style soft start are as follows: delete section 2.07 and replace sections 2.01 and 2.06 with the following;

2.01 General Description

- A. The soft starter shall be provided by the manufacturer in a configuration suitable for panel mounting. The component must be suitable for mounting in a pollution degree 3 environment. All power devices and components must be inaccessible during routine maintenance or set-up.
- B. The soft start shall utilize a thyristor (SCR) bridge consisting of at least two SCRs per phase to control the starting and stopping of industry standard motors.
- C. The soft start shall provide torque control for linear acceleration without external feedback independent of motor load or type of application. The gating of the thyristors will be controlled in such a manner to ensure smooth and stable acceleration ramp.
- D. The soft start shall be controlled by a microprocessor that continuously monitors the current and controls the phasing of the SCRs. Analog control algorithms shall not be allowed.
- E. All soft start power ratings will utilize the same control module.
- F. Integral protective capabilities and selectable deceleration control shall be available even if a shorting contactor is used with soft starts rated 47 A or above. Power terminals shall be provided to simplify integration shorting contactor integration without additional components.

2.06 Control Options

- A. The soft start's control circuit shall be completely independent its power circuit and adaptable to 240, 380 or 460 Vac 50 or 60 Hz.
- B. The soft start shall accept control logic either by operator devices (push buttons, selector switches, etc.) wired directly to the unit or from external relay logic.



www.rgbautomatyka.pl



www.rgbautomatyka.pl

Square D Company
Highway 64 East
Raleigh, NC 27545-9023
1-888-SquareD
(1-888-778-2733)
www.squared.com

Schneider Canada Inc.
19 Waterman Avenue,
M4B 1 Y2
Toronto, Ontario
1-800-565-6699
www.schneider.ca

Catalog No. 8636CT9701R2/00 August 2000 Replaces 8636CT9701 dated 10/97.