

HITACHI INVERTER

HFC-VWS₃ EA SERIES

INSTRUCTION MANUAL

Read safety instructions carefully and understand them before using your inverter.

Keep this instruction manual for future reference.



NB428XB

NB428XB

APPENDIX

APPENDIX 1 HFC-VWS3EA Series Data Setting List

The HFC-VW₃EA series inverter has many functions. The user can change standard-set values of those functions.

It is recommended that the user fills in the blanks on this data sheet for quick service, maintenance, and investigation of trouble.

Type HFC-VWS

MFG. No.

} Designated on the nameplate
on the front cover

● Monitor mode

Display sequence	Monitor name	Initial display	Setting data
1	Frequency setting command and output frequency display	<input type="text" value="FS 000.0 000.0Hz"/>	
2	Frequency command method	<input type="text" value="F-SET M Terminal"/>	
3	Operation command method	<input type="text" value="F/R-SW Terminal"/>	
4	Motor speed display	<input type="text" value="RPM 4P 00000rpm"/>	
5	Transformed frequency display	<input type="text" value="/Hz000.0 00000.00"/>	
6	Output current display	<input type="text" value="If----A Im000.0%"/>	
7	Manual torque boost adjustment	<input type="text" value="V-Boost Code 31"/>	
8	Output voltage gain adjustment	<input type="text" value="V-Gain 100%"/>	
9	Jogging frequency setting	<input type="text" value="Jogging 00.5 Hz"/>	

● Function mode

Function number	Monitor name	Original standard setting	Setting data
F-00	V/F pattern setting	VF1-VC 050-050	
F-01	Acceleration time setting	20	
F-02	Deceleration time setting	20	
F-03	Maximum frequency adjustment	0	
F-04	Start frequency adjustment	0.5	
F-05	Upper frequency limit setting	0	
F-06	Lower frequency limit setting	0	
F-07	Jump frequency 1 setting	0	
F-08	Jump frequency 2 setting	0	
F-09	Jump frequency 3 setting	0	
F-10	Carrier frequency adjustment	U	
F-11	Adjustment of frequency stop time at start	0	
F-12	Multi-stage speed 1 setting	0	
F-13	Multi-stage speed 2 setting	0	
F-14	Multi-stage speed 3 setting	0	
F-15	Multi-stage speed 4 setting	0	
F-16	Multi-stage speed 5 setting	0	
F-17	Multi-stage speed 6 setting	0	
F-18	Two-stage acceleration time setting	20	
F-19	Two-stage deceleration time setting	20	
F-20	DC braking frequency adjustment	1.0	
F-21	DC braking power adjustment	10	
F-22	DC braking time adjustment	5	
F-23	Electronic thermal level adjustment	100	
F-24	Linear/S-curved acceleration selection	Linear	
F-25	Linear/S-curved deceleration selection	Linear	
F-26	External frequency setting start	0	
F-27	External frequency setting end	0	
F-28	Switch 1 selection	00000101	
F-29	Switch 2 selection	00111000	
F-30	Overload limit constant setting	1.0	
F-31	Overload warning level adjustment	100	
F-32	Automatic torque boost adjustment	00	
F-33	Allowable momentary power failure time setting	0.3	
F-34	Switch 3 selection	00000000	
F-35	Communication mode selection	INVERTER	
F-36	Standby time setting for restart after momentary power failure	1	
F-37	DC braking wait time adjustment	0.0	
F-39	Frequency setting for reached-speed signal at freely	0	

IMPORTANT INFORMATION

Thank you very much for purchasing Hitachi frequency inverter.
We request that you read this manual carefully and use the inverter correctly. Keep this manual for future reference.

DEFINITIONS AND SYMBOLS

Safety alert symbol, Dangers, Cautions, and Notes are used throughout this manual with the following definitions and symbols.

SAFETY ALERT SYMBOL

This is the industry "Safety Alert Symbol".

This symbol is used to call your attention to items of operations that could be dangerous to you or other person using the inverter.

Please read these messages and follow these instructions carefully.

It is essential that you read the instructions and safety regulations before you attempt to use the inverter.

A signal word-DANGER, WARNING or CAUTION-is used with the safety alert symbol.

DANGER: Indicates the most extreme danger which, if not avoided, will result in death or serious injury.

WARNING: Indicates any condition or practice which, if not avoided, could result in death or seriously injury.

CAUTION: Indicates any condition or practice which, if not avoided, may result in minor or moderate injury or damage to equipment.

NOTE: Indicates an area or subject emphasizing either the products capabilities or common errors in operation or maintenance.

NOTE

- (1) Do not reprint a part or all of the contents of this manual without permission of Hitachi.
- (2) The contents of this manual are subject to change without prior notice without any obligation on the part of the manufacturer.
- (3) All dimensions and speeds in this manual are specified by the metric system.

SAFETY INSTRUCTION

The following safety instructions are basic safety items when you use the inverter, and these instructions for Hitachi inverter describes to assist the operator and maintenance personnel in performing good work safety procedure.

The personnel in charge of operation, maintenance and installation must read and understand the safety instructions carefully before doing work, investigating system/application.

Failure to follow safety instructions may cause a personal injury, damage to the inverter or malfunction.

1. Safety Management

- (1) Appoint a person who is responsible to operate the inverter. Have the only qualified persons operate and perform maintenance.
- (2) Train the operators and maintenance persons for the following.
 - . How to operate (start and stop)
 - . How to maintain the inverter.
- (3) Keep the instruction manual and other documentation in relation to the inverter.
- (4) Do not modify the inverters without manufacturer's written permission.
- (5) Keep the inverter clean to look the LCD and instruction on the inverter for everybody.
- (6) Turn off the power supply to the inverter while not using it.
- (7) Do not use the inverter for medical equipment such as pacemaker and fire pumps.

2. General Safety Instruction upon Receiving

- (1) Check the model name of inverter on the box whether it is the same as your order before unpacking.
- (2) In the case of receiving a different model from your order, do not use it and inquire to the vendor.

3. General Safety Instruction upon Unpacking and Storage

- (1) Open the box and check whether the inverter has a damage or not.
- (2) Check the specifications in the label on the cover whether they are the same as your order.
- (3) If you do not use the inverter for the time being.
Keep the inverter under the good condition.

4. General Safety Instruction upon Installation and Wiring

- (1) Read and understand the installation and wiring section completely before installing the inverter.
- (2) Put a LOCKOUT/TAGOUT to the power supply switch during maintenance and servicing working.
- (3) The installation place must be wide enough space for maintenance.
- (4) Provide emergency stop buttons at necessary places, and do not use the Free-Run-Stop and Reset functions of the inverter for emergency stop. In the case of emergency, the power supply to the inverter must be turned off.
- (5) Install the specified grounding to the inverter and others which require it.
- (6) Connect the wiring correctly to proper terminal.

5. General Safety Instruction upon Test-run

- (1) Check the all wiring to the inverter and make sure everything in order before turning on the power supply.
- (2) Make sure the programed parameters whether they are in accordance with your specifications. For example maximum frequency, before operating.
- (3) Make sure nobody is near motor and equipment before switch on.
- (4) Put a sign board "ON TEST-RUN" around the inverter and equipment (Motor, machine ... etc.).

6. General Safety Instruction upon Inspection and Maintenance

- (1) Put a sign board "ON MAINTENANCE" around the inverter and equipment.
- (2) Put a LOCKOUT and TAGOUT on the power supply switch during working.
- (3) After power turn off, wait for until the LED lamp on the printed circuit board goes off. This LED lamp is visible after the terminal cover is removed, see page 3-1.

Measure the DC bus voltage on the + and - terminals by volt meter and make sure no voltage present on them before touching internal parts.

CONTENTS (Cont'd)

	Page
6. OPERATION	6-1
6.1 Before Operation	6-1
6.2 Operation Pattern	6-2
6.3 Setting Functions before Trial Operation	6-3
6.4 Example of Connection When a Motor with a Brake is Used	6-10
7. MAINTENANCE AND CHECK	7-1
7.1 Cautions on Maintenance and Check	7-1
7.2 Checking Items	7-2
7.3 Measuring Method of Input/Output Voltage, Current, and Power	7-6
7.4 Checking the Converter Module and Inverter Module	7-9
8. FAULT MESSAGE AND TROUBLESHOOTING	8-1
8.1 Causes and Action	8-2
8.2 Protection Functions	8-5
8.3 Content of Check Points	8-7
8.4 Life of Soft Memory Element (NV-RAM)	8-11
9. DESCRIPTION OF DIGITAL OPERATION PANEL, MONITOR MODE AND FUNCTION MODE	9-1
9.1 Configuration of Digital Operation Panel	9-1
9.2 Returning to the Original Standard Setting	9-3
9.3 Monitor Mode Description and Operation	9-5
9.4 Function Mode	9-14
9.5 Automatic Restart Function	9-35
10. SPECIFICATIONS	10-1
10.1 Block Diagram	10-1
10.2 Layout on the Printed Circuit Board	10-3
10.3 Standard Specifications	10-4
10.4 Description of Terminals	10-7
10.5 Potentiometers and DIP Switches	10-9
10.6 Wires and Components	10-10
11. OPTION	11-1

CONTENTS

	Page
IMPORTANT INFORMATION	0-1
SAFETY INSTRUCTION	0-3
1. Safety Management	0-3
2. General Safety Instruction upon Receiving	0-3
3. General Safety Instruction upon Unpacking and Storage ..	0-4
4. General Safety Instruction upon Installation and Wiring	0-4
5. General Safety Instruction upon Test-run	0-4
6. General Safety Instruction upon Inspection and Maintenance	0-5
1. INSPECTION UPON UNPACKING	1-1
2. PRECAUTIONS	2-1
2.1 Installation Environment and Location	2-1
2.2 Input Voltage	2-1
2.3 Connection	2-1
2.4 Maximum Output Frequency	2-2
2.5 Maintenance and Adjustment	2-2
2.6 Insulation Resistance Test and Withstand Voltage Test ..	2-2
2.7 Restart Function	2-3
2.8 Record of Setting Data	2-3
2.9 Data Storage	2-3
3. STRUCTURE	3-1
3.1 Appearance and Name of Each Part	3-1
3.2 Removing and Reattaching the Terminal Cover	3-1
3.3 Removing and Reattaching the Main Unit Cover	3-2
4. INSTALLATION	4-1
4.1 Transportation	4-1
4.2 Installation Environment and Location	4-1
5. WIRING	5-1
5.1 Description of Main Circuit Terminals	5-1
5.2 Connecting Main Circuit Terminals	5-2
5.3 Grounding of Inverter	5-4
5.4 Connection of Control Circuit Terminals	5-5

CONTENTS (Cont'd)

	Page
12. PARTS AND REPAIR	12-1
12.1 Parts Order	12-1
12.2 Repair	12-1
APPENDIX	
1. HFC-VWS3EA Series Data Setting List	A-1

1. INSPECTION UPON UNPACKING

Before installation and wiring, check to see:

- (1) No damage is found on each product during transportation;
- (2) The product is as ordered (check the type name, voltage and frequency)
- (3) A set of inverter unit and instruction manual are contained together in the package upon unpacking.

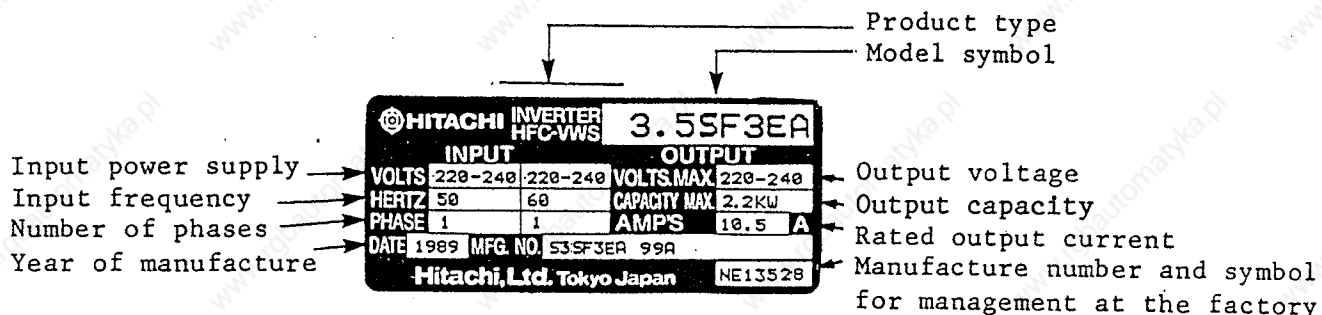
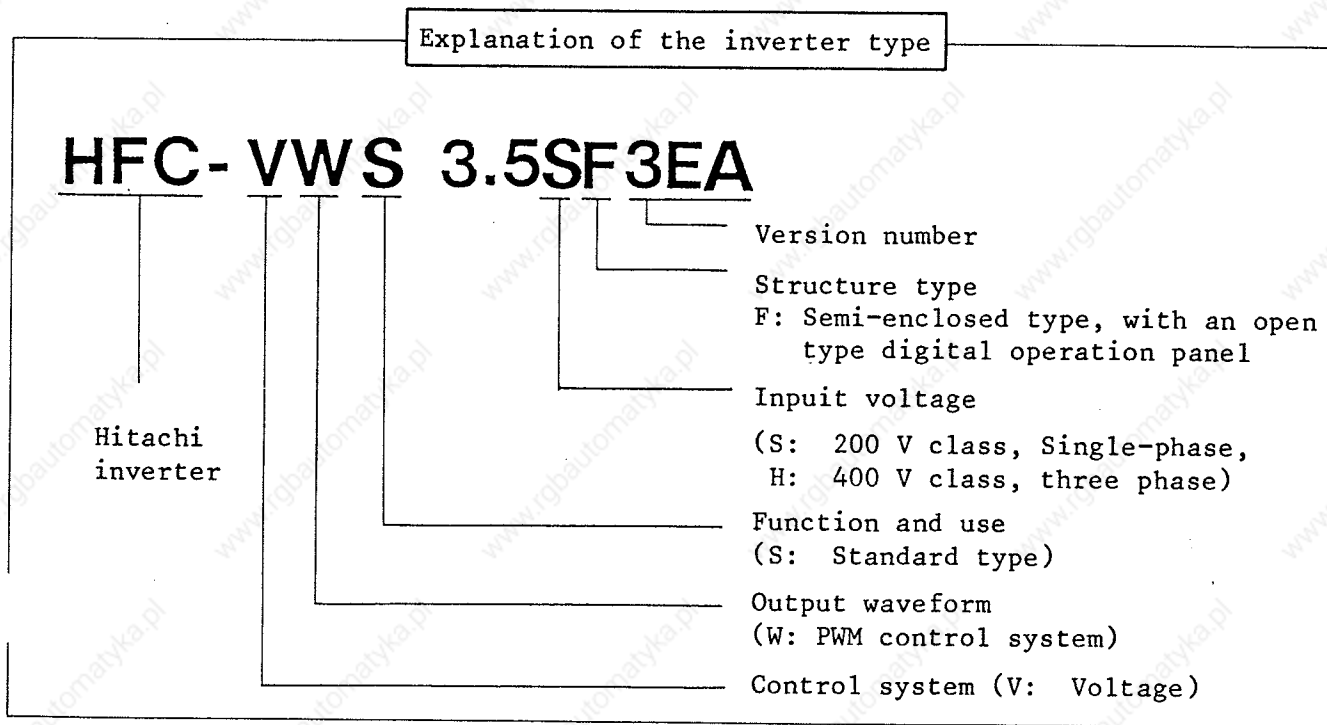

Figure 1-1 Details of Nameplate

For any irregularity, contact your sales shop immediately.



2. PRECAUTIONS

In operating the HFC-VWS₃EA Series inverter, first check that there is no problem on the following: inadequate operation can result in damage to the inverter.

2.1 Installation Environment and Location

- (1) Avoid a high temperature, high humidity, easy-to-dew ambient environment and a place exposed to dust or dirt, corrosive gas and coolant mist, and set the unit in a well-ventilated room not exposed to direct sunlight.
- (2) Avoid a place subjected to substantial vibration.
- (3) When installing the unit within the box, remove the terminal cover. In this case, the unit can be operated within the range of -10 to 50°C inside the box.
- (4) Use a nonflammable material, such a steel sheet on the wall for installation. (The rear side will generate heat.)
- (5) Install the unit always vertically with a clearance around.

2.2 Input Voltage

Check that the input power supply is 1-phase 220 to 240 V 50 Hz, 60 Hz, and 3-phase 380 to 415 V 50 Hz, 400 to 460 V 60 Hz for 400 V class.

2.3 Connection

- (1) Be sure to connect the power supply to L1, N or L1, L2, L3 (input terminals), and the motor to U.V.W (output terminals). (Wrong connections damage to the unit.)

- (2) Be sure to ground an earth terminal (PE) for personnel safety.
(earthing resistance; 100 Ω or less for 200 V class, 10 Ω or less for 400 V class)

- (3) For operation start and stop, use

FWD
RUN

,

REV
RUN

,

STOP

 and FW/RV terminals. Never turn ON/OFF input power supply.

2.4 Maximum Output Frequency

The standard set (set by manufacturer) of the maximum output frequency is 50 Hz and constant torque (see page 9-20). The HFC-VWS₃ EA series inverter allows a maximum frequency of 360 Hz (375 Hz, when using F-03) to be set when an appropriate V/F pattern is selected. Before you change the maximum output frequency or V/F pattern, check whether this frequency is allowable for motors and machines. If not so, select a suitable V/F characteristics.

2.5 Maintenance and Adjustment

- (1) After cutting off power supply, do not touch the internal parts until the LED (charge lamp) on the printed circuit board goes off. (Since the capacitor charged voltage is still present, it is dangerous.)
- (2) Static electricity may cause breakdown to components on PC board. Handle these parts after grounding the work bench, soldering iron and person surely.

2.6 Insulation Resistance Test and Withstand Voltage Test

Special care must be taken for insulation resistance and withstand voltage tests. When conducting these tests actually, be sure to refer to "Insulation Resistance and Withstand Tests", see page 7-2.

2.7 Restart Function

While the restart function is in effect, the motor is in the free-run state. When it is necessary to hold the motor in the free-run state through mechanical braking, therefore, do not use the restart function.

2.8 Record of Setting Data

Though this inverter has various functions, it is recommended to fill in setting data on the data sheet shown in appendix 1 for service, maintenance and investigation.

Pass this record to the final end user.

2.9 Data Storage

The memory element called non-volatile RAM (NVRAM) is used to keep the data after power supply to the inverter is off.

The changed data is stored in the RAM area of NVRAM temporarily and the inverter is operated under this new data. Since this new data can be kept only while the power supply is given, this new data must be re-stored into EEPROM area of NVRAM when power supply is turned off. Under the following procedure shown in Figure 2-1 (a) below, this procedure will be done automatically when power supply is turned off, but in the case of (b), it will not be done and when power is turned on again, the old data before changing appears again.

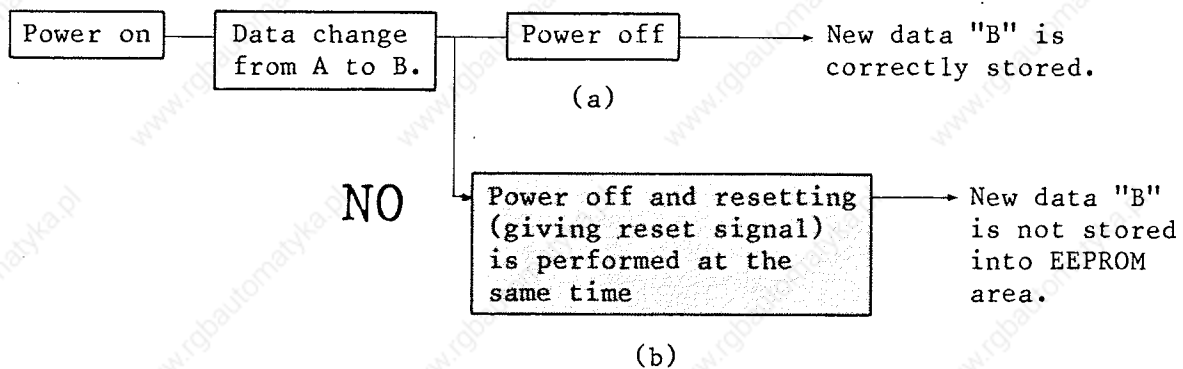
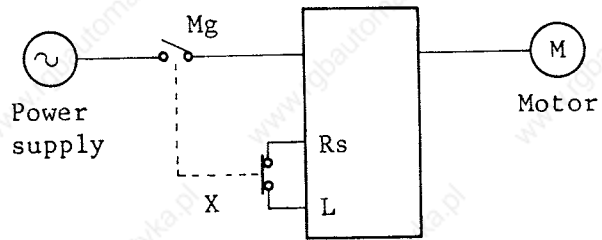

Figure 2-1 Storage of New Data

To avoid the loss of new data, turn off the reset signal once and turn power off to store the new data. This procedure is required only once. Take special care of this if the connection in Figure 2-2 is made.



x: Electronic relay with the same on/off timing as Mg, such as auxiliary contact of Mg.

Figure 2-2 Connection Diagram

3. STRUCTURE

This section provides the structure and VWS3.5SF₃ EA is used as sample.

3.1 Appearance and Name of Each Part

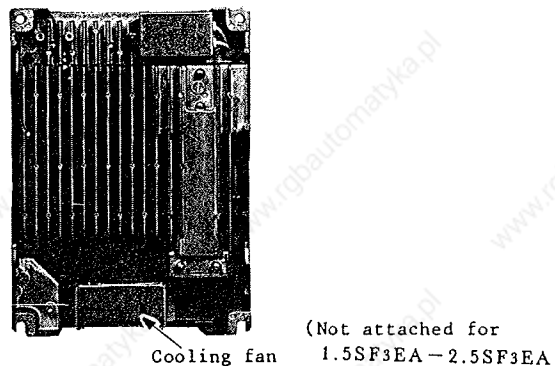
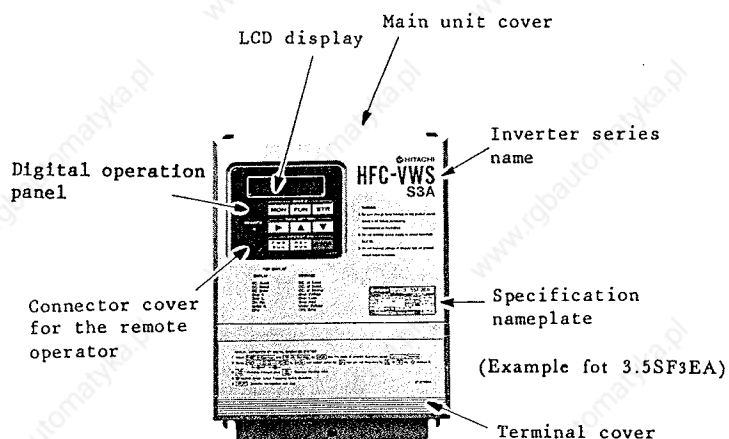

3.2 Removing and Reattaching the Terminal Cover

To remove terminal cover, loosen the screw at the bottom of the terminal cover then lift the cover. (In this state, leads can be connected to terminals.) To reattach the terminal cover, insert the claws at the top of the cover into the holes on the main unit cover.

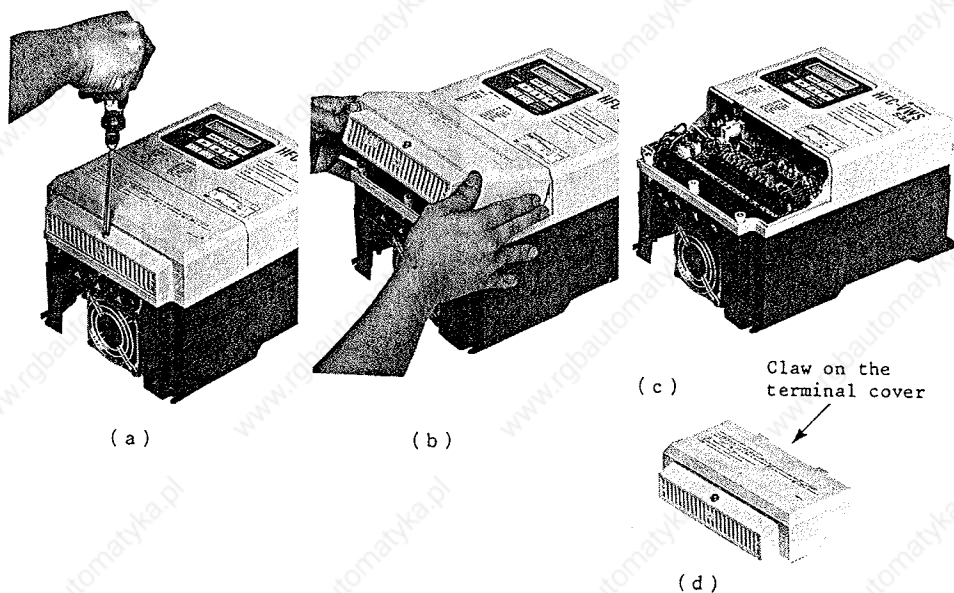

3.3 Removing and Reattaching the Main Unit Cover

After the terminal cover is removed, two screws will appear at the bottom right and left. To remove the main unit cover, loose these screws then move the cover upward. (Do not operate the inverter with the main unit cover removed. Such operation is very dangerous.)

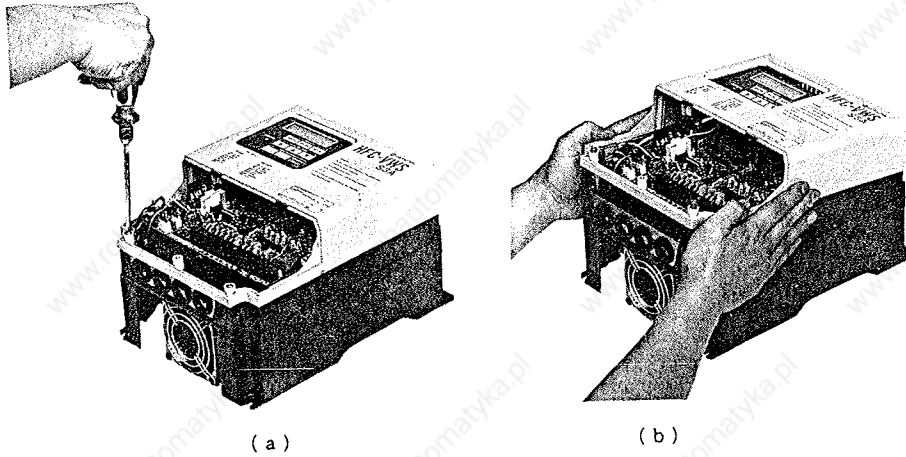

Figure 3-4 Main Unit Cover Removal

To reattach the main unit cover, insert two claws at the top right and left of the cover into the rectangular holes on the aluminum die cast frame (hereafter called simply frame) then press the cover to the frame while pulling it toward you. Finally, tighten the right and left screws at the bottom.

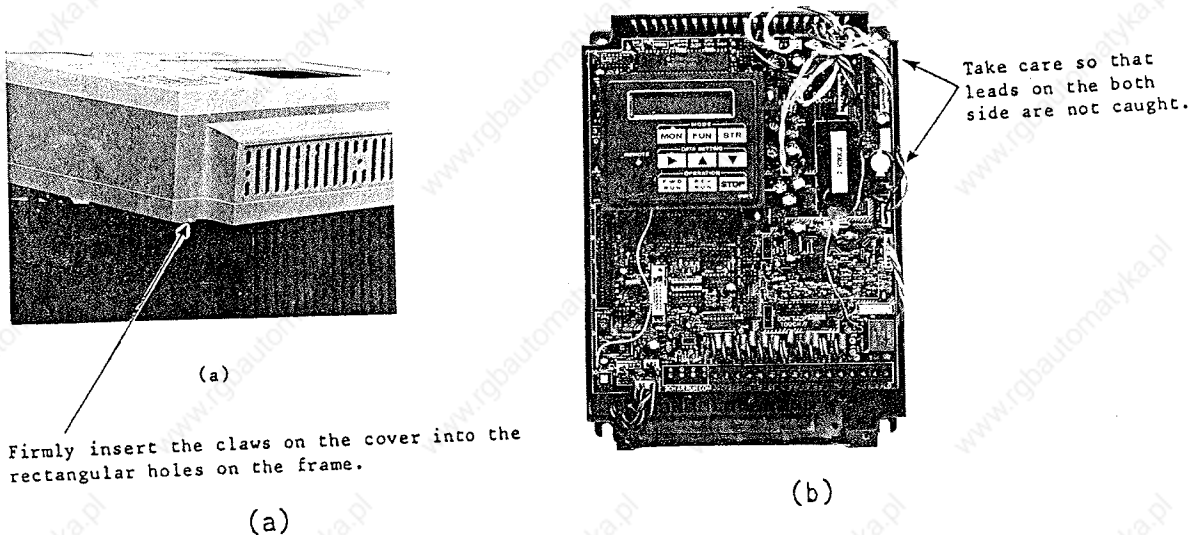

Figure 3-5 Main Unit Cover Reattachment

4. INSTALLATION

4.1 Transportation

Handle with care to prevent the inverter from being damaged during transportation. Do not apply pressure to the cover of the inverter.

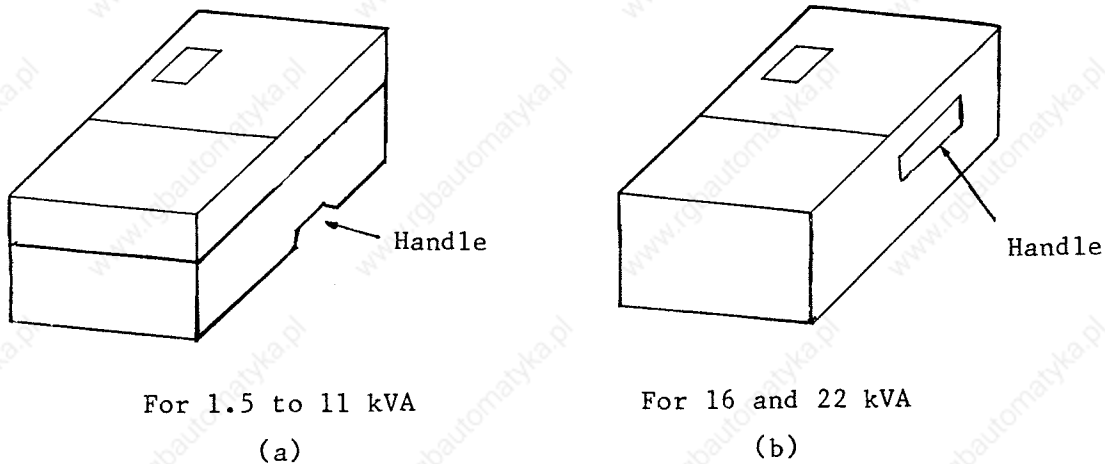

Figure 4-1 Handling the Inverter

4.2 Installation Environment and Location

This paragraph provides precautions for installation. For the details, see table 4-1.

- (1) Installation surface must be flat and be used nonframmable material.
- (2) Wide enough clearance for installation place
- (3) The inverter must be installed vertically and when number of inverters are installed in the same place such as in the cabinet, they must be installed side by side.
- (4) Install the inverter in a place not exposed to direct sunlight, corrosive gas, coolant mist and explosive environment.
- (5) Be sure to attach the cover to protect the inverter when obstacles drop on it.
- (6) Since the heat of approx. 5% of the rated capacity is generated from the inverter, special care must be given to the ventilation when the inverter is installed in the box.

Table 4-1 Environment and Location

Item	1.5 to 22 kVA		Remarks
Ambient Temperature	-10°C to +40°C		1.5 to 22 kVA: IP20
Relative Humidity	20 to 90%		Non condensing
Vibration	0.2 G (10-55 Hz)		
Installation Surface	 <p>Flat and nonframmable material is required.</p> <p>Air Flow</p> <p>Wall</p>		 <p>Flat and nonframmable spacer is required if surface is not flat.</p>
Inverter Air Flow Requirements	 <p>15cm</p> <p>10cm</p> <p>10cm</p> <p>15cm</p> <p>Air flow</p>		<p>Less clearance</p> 
Installation of Single Unit	 <p>Install vertically</p> <p>Air Flow</p>		<p>Do not install Horizontally</p>  <p>Air Flow</p>

Table 4-1 Environment and Location (Continued)

Item	1.5 to 22 kVA		Remarks
Installation of Multi Units	<p>10 cm or more 10 cm or more</p>  <p>Air Flow</p> <p>Keep the space more than 10 cm</p>		 <p>Do not build up the inverters.</p> <p>Air Flow</p>
Sunlight	 <p>Install the inverter away from windows and do not expose to direct sunlight.</p>		
Corrosive Gas and Coolant Mist	<p>Install the inverter in a place not exposed to corrosive gas and coolant mist.</p>		<p>Corrosive Gas</p>  <p>Do not put inverter in a place exposed to corrosive gas and coolant mist.</p>
Explosive Gas	<p>Install the inverter in a place of no explosive environment.</p>		<p>Explosive Gas</p>  <p>Do not put the inverter in the explosive environment.</p>

5. WIRING

⚠ WARNING: To avoid personal injury and damage to the inverter

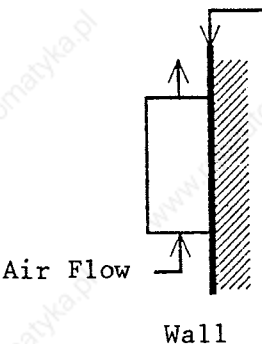
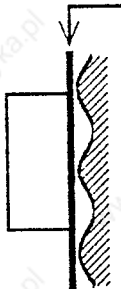
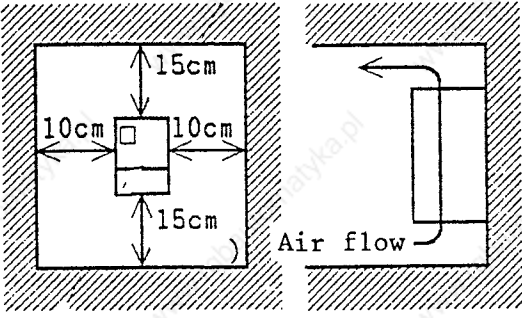
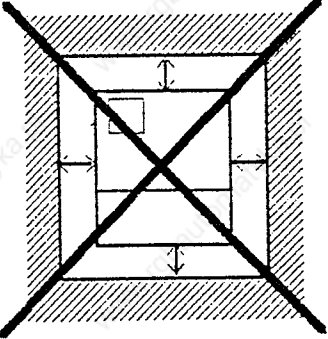
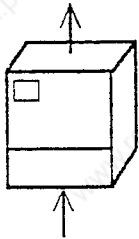
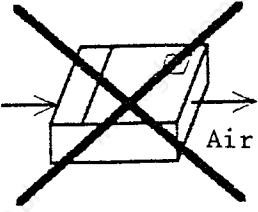
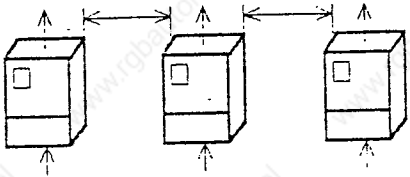
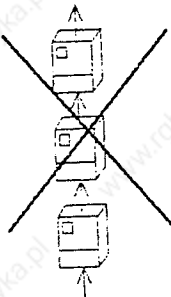
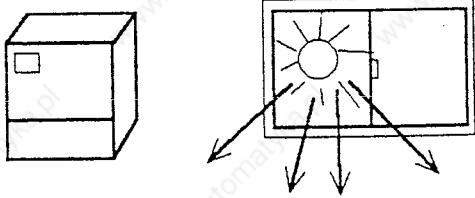
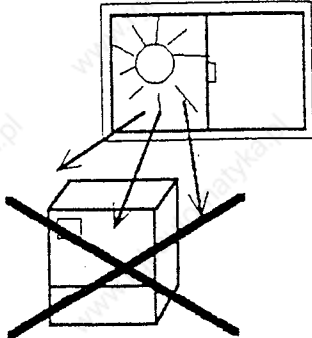
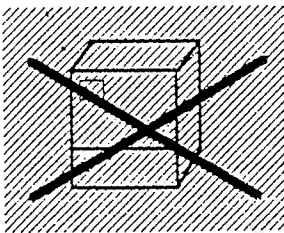
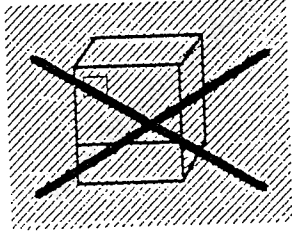
Be sure the input power has been disconnected prior to beginning work.
Put a LOCKOUT and TAGOUT on the power supply switch during working.

⚠ CAUTION: To avoid damage to the inverter

Connect the power and control signal correctly.
Power supply to L1, L2 and L3, or L1 or N
Motor Cable to U, V and W
Take care of the following notes.

5.1 Description of Main Circuit Terminals

Table 5-1 Main Circuit Terminals Description

Model	Terminal location	Type of terminal	Wire size
1.5 to 3.5SF3EA		Screw clamp type	Max. 5.5 mm ²
2.5 to 11HF3EA			Max. 5.5 mm ²
16 to 22HF3EA			Max. 8 mm ²

PE: Ground

5.2 Connecting Main Circuit Terminals

(1) Wiring for the power supply and motor

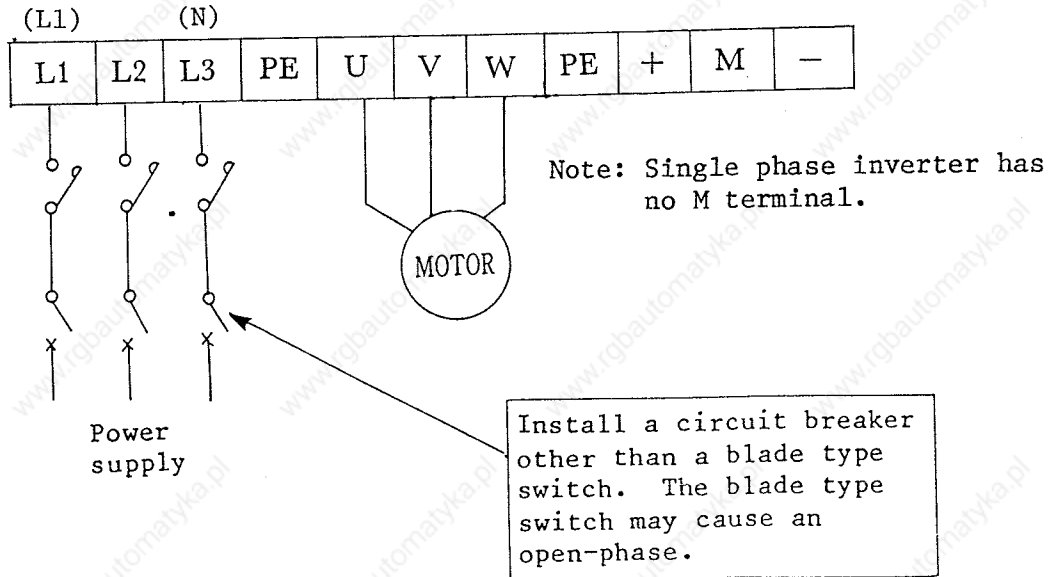

Figure 5-1 Power Line Wiring

Note 1: If line power supply is applied to output terminals U, V, and W instead of input terminals L1, L2, and L3, the inverter is damaged. This is also very dangerous to workers. When the motor is switched between the line voltage power supply and the inverter, a similar problem is likely to occur. To prevent such a mistake, be sure to use electromagnetic contactor with mechanical interlock features to Mg1 and Mg2.

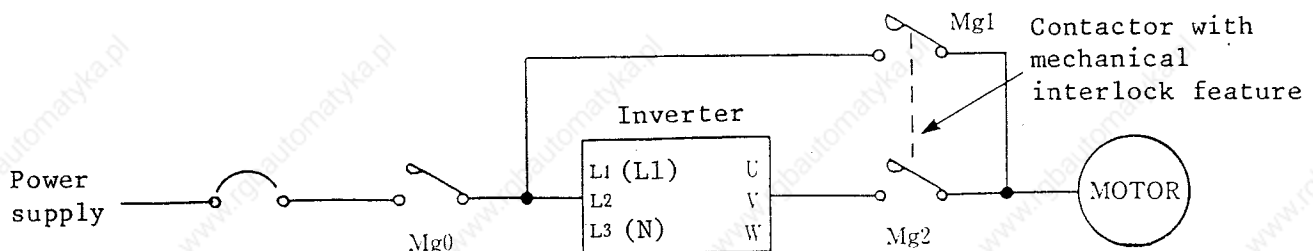

Figure 5-2 Bypass Circuit

Note 2: If the inverter is started and stopped by turning on and off Mg0 and Mg2, the inverter causes an OC trip because a rush current flows due to direct start. If Mg0 and Mg2 are turned on and off repeatedly, elements are damaged. For operation start and stop, use control terminals, the digital operation panel or the remote operator.

Note 3: Do not insert a capacitor for power factor improvement or a surge absorber between the inverter and the motor.

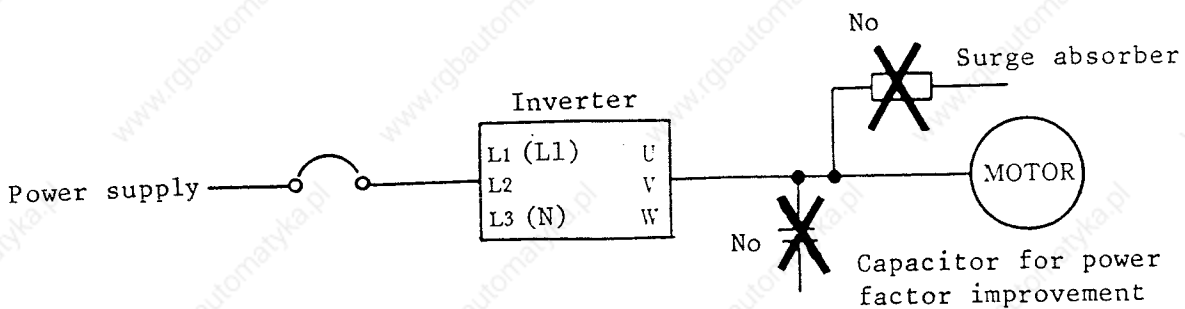
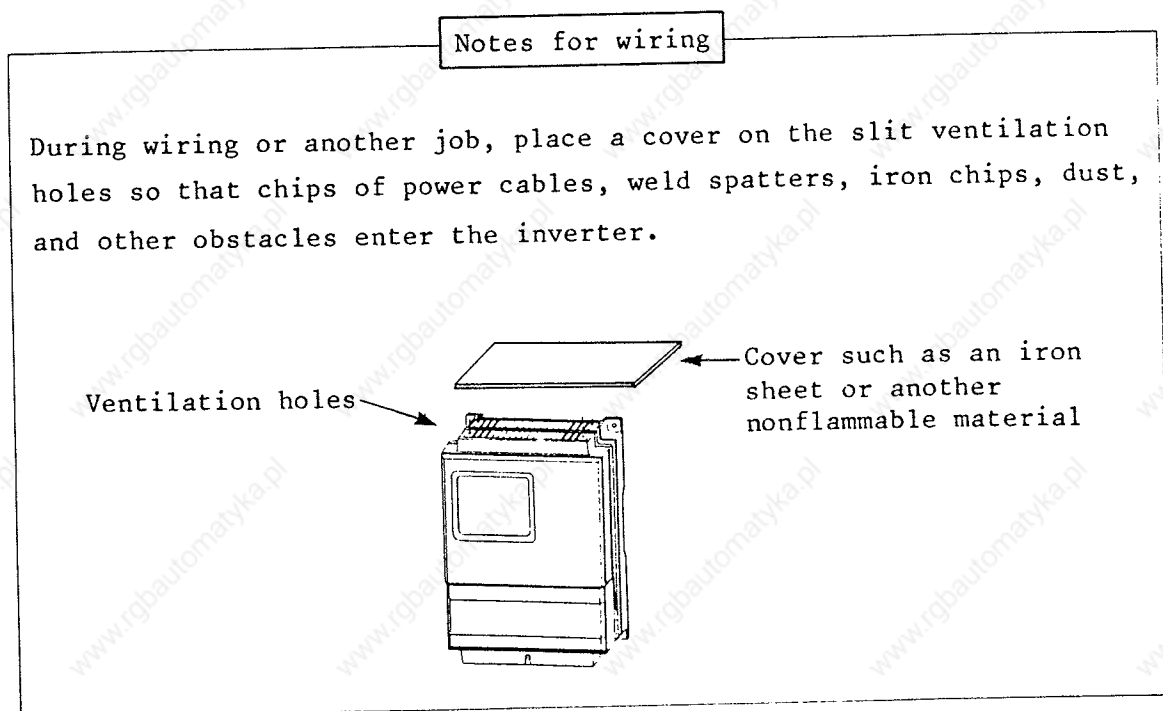

Figure 5-3 Absorber and Capacitor



5.3 Grounding of Inverter

⚠ WARNING: To avoid personal injury and reliable operation

The ground wires must be the same size as the incoming power wires or sized according to NEC (National Electric Code) Table 250-95 and local legal requirements. Be sure of the quality of the your ground used.

A copper conductor must be used. The above is required on the inverter, motor and other equipment.

⚠ WARNING: To avoid personal injury

The ground fault protection circuit is not designed to protect personal injury. For protection, install a leak braker type of a high frequency sensitive current.

Note: Provide a grounding securely as follows:

- Provide grounding for a terminal.
(earthing resistance; 100 Ω or less for 200 V class
10 Ω or less for 400. V class)
- Separate an inverter grounding cable from the grounding cable for other power electrical equipment. Absolutely avoid using the grounding pole together.
- When grounding several inverters, make connections as shown in (b) below so that no loop is produced as shown in (a) below.

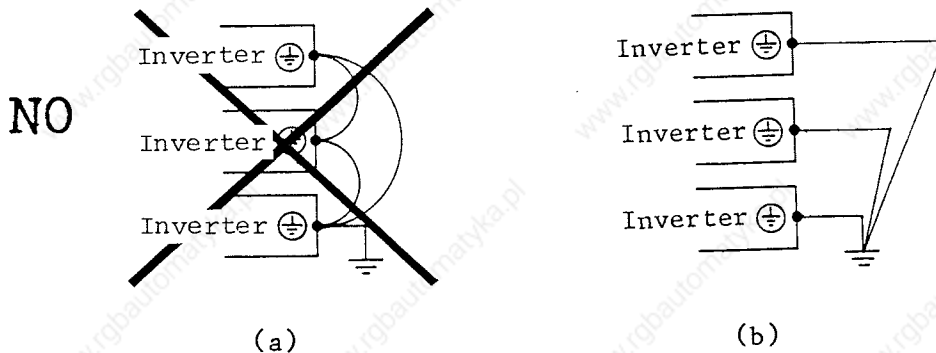

Figure 5-4 Grounding

5.4 Connection of Control Circuit Terminals

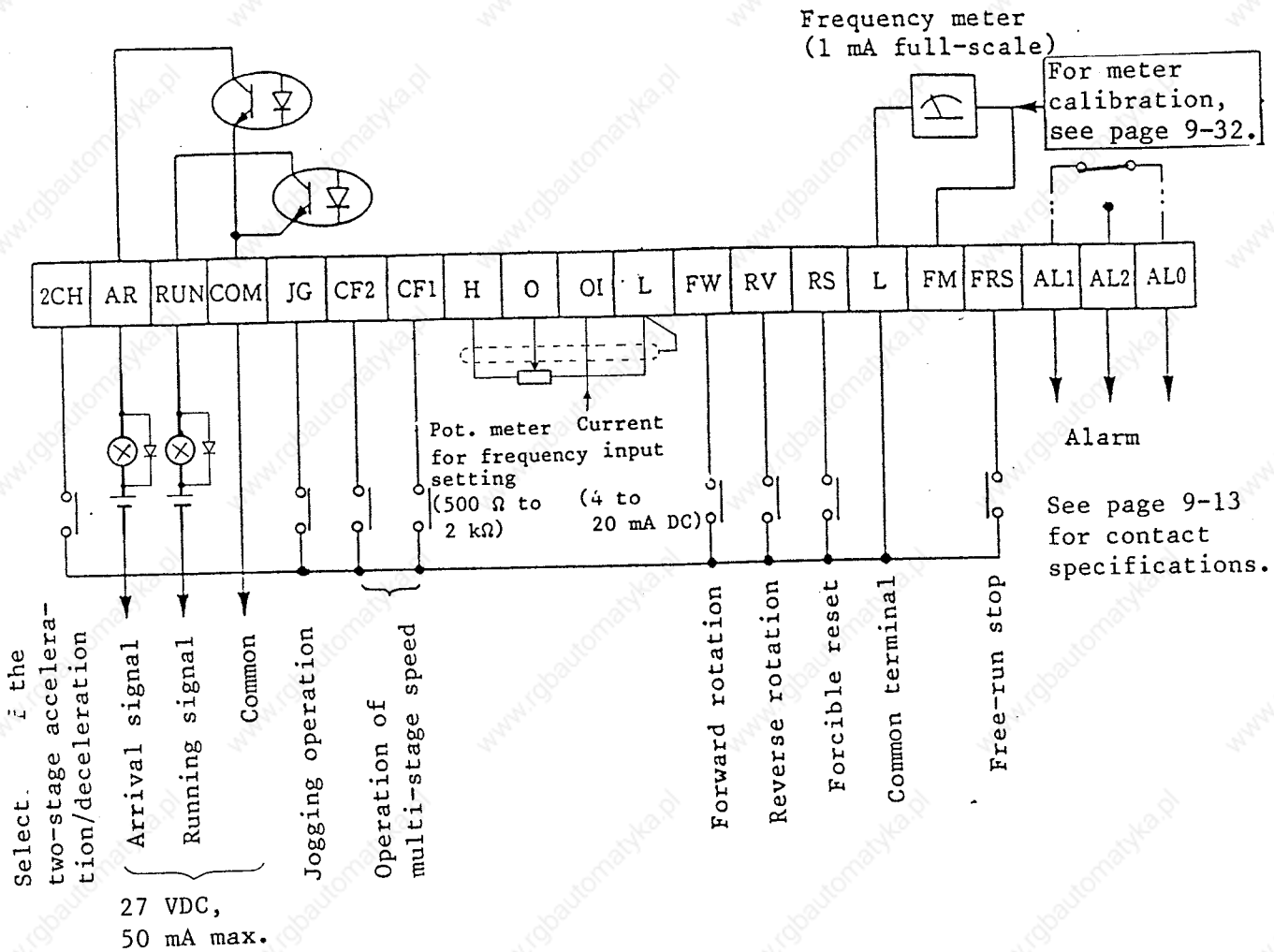

Figure 5-5 Wiring of Control Circuit Terminals

Note 1: COM is a common terminal only for AR and RUN terminals. It is insulated from the other terminals. Terminal L is a common terminal for the other terminals. Distinguish between these two common terminals. Do not connect them with ground.

Note 2: For connecting a relay between AR-COM and RUN-COM, attach a diode to the relay in parallel for surge absorbing.

Note 3: Use a shield wire for a signal line, and process it as shown below. The wire length should be less than 20 m. If the wire length unavoidably exceeds 20 m, use the optional VX application controller RCD-A (remote-control panel) or CVD-E (signal isolation converter).

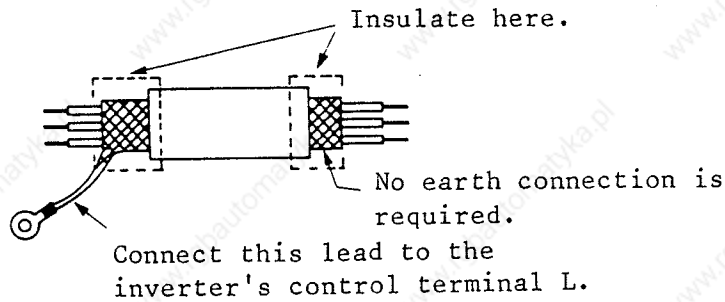

Figure 5-6 Signal Wire Shielding

Note 4: When a frequency setting signal is provided with a contact (on or off), use a relay which does not cause incomplete contact even at weak current or voltage (Use like the cross-bar twin contact).

Note 5: For other contacts, use a relay which does not cause incomplete contact at 12 VDC, 3 mA.

Note 6: Separate the inverter signal line from the power line as shown in below. If cross-over is unavoidable, cross them perpendicularly each other.

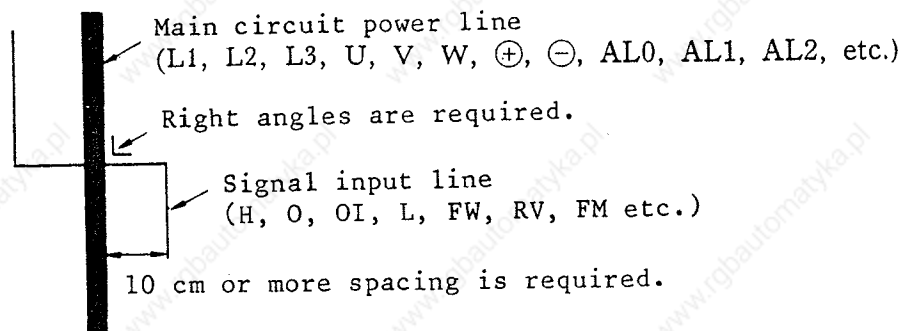



Figure 5-7 Wire Separation

6. OPERATION

 **WARNING:** To avoid personal injury and damage to the inverter.
This inverter must be operated only by qualified personnel familiar with operation. Failure to observe this precaution could result in personal injury and / or equipment damage.

 **WARNING:** To avoid personal injury
Check the inverter parameters. Especially the maximum frequency of the inverter and allowable speed of motor and machine. The overspeed operation causes the mechanical damage of the motor and machine, and it could cause the fatal personal injury.

6.1 Before Operation

Prior to trial operation, check the following.

- (1) Check that all power lines (input terminals L1, L2, L3, output terminals, U, V, W, braking unit terminals +, M, -) are connected correctly. Need special care for input and output terminals have been connected correctly.
- (2) Check the signal lines for wrong wiring.
- (3) Check that the inverter case earth (PE) is grounded.
(earthing resistance; 100 Ω or less for 200 V class
10 Ω or less for 400 V class)
- (4) Check that other terminals than (PE) are not grounded.
- (5) Check that the inverter is mounted on the wall. Also check that non-flammable material, such steel sheet is used for the wall surface on which to install it.
- (6) Check that the terminals have not been short-circuited by cable crumbs or connectors after wiring. Do not leave the tools used.

- (7) Check that neither short-circuit nor grounding occurs in output terminals.
- (8) Check that the screws and terminals have been tightened firmly.

Conduct the insulation test and withstand voltage test according to the procedure shown in Section 7 "Maintenance". Do not test other than the specified terminals.

6.2 Operation Pattern

The HFC-VWS₃EA series inverter provides the following patterns of operations, including the operations of the remote operator and copy unit (options).

Table 6-1 Combination of Operation Method

Command Pattern	Frequency			Operation/stop command			Remarks	For details
	Digital operation panel	Ex-ternal	Digital remote operator	Digital operation panel	Ex-ternal	Digital remote operator		
1	o	/	/	o	/	/		Page 6-6
2	/	o	/	/	o	/	Standard setting	Page 6-7
3	o	/	/	/	o	/		Page 6-8
4	/	o	/	o	/	/		Page 6-9
5	/	/	o *	/	/	o *	Operation by remote operator (option)	
6	/	/	o *	/	o	/		
7	/	o	/	/	/	o *		

Note: * indicates the operations to be performed by the remote operator or copy unit. For details, read the respective instruction manual.

6.3 Setting Functions before Trial Operation

The functions of the inverter are factory-set to standard values.

Change the settings with reference to section 9 (pages 9-1 to 9-34) if necessary. Table 6-2 shows the standard settings of the functions which are usually used frequently.

Table 6-2 Value of Original Standard Setting



Function	Standard setting	Standard setting display	Setting change
V/F pattern setting (F-00)	<p>Maximum frequency is 50 Hz, constant torque characteristics.</p>  <p>The relation between the reference signal and the output frequency is the following.</p> <p>[In the case of external signal]</p> <p>0 - 10 V: A frequency of 50 Hz is set at 10 V. 0 - 5 V: A frequency of 50 Hz is set at 5 V. 4 - 20 mA: A frequency of 50 Hz is set at 20 mA.</p>	VF1-VC 50-60	<p>Set a new value in the function mode (see page 9-19).</p> <p>Gain and bias adjustment are possible (see page 9-27 and F-26, 27).</p>
Acceleration time setting (F-01) and deceleration time setting (F-02)	20 seconds	ACCEL-1 20.0S DECEL-1 20.0S	Set a new value in the function mode (see page 9-21).
Frequency command, operation command	Terminal side (The setting can be changed to the digital operation panel side or optionally to the remote operation side.)	F-SET-M Terminal F/R-SW Terminal	Set a new value in the monitor mode (see pages 9-9 and 9-10).

Table 6-2 Value of Original Standard Setting (Continued)

Function	Standard setting	Standard setting display	Setting change
Frequency setting	Set zero (0) Hz on the digital operation panel. (When the frequency is set with control terminals, set the frequency command switch to the terminal side.)	FS 000.0	Set a frequency in the monitor mode (see page 9-8).
Electronic thermal level adjustment (F-23)	<p>The thermal level is set at the protection level of the general-purpose motor. However, the level is 100% of the rated current of the inverter. Adjust the thermal level setting by following equation;</p> <p>Thermal level setting</p> $= \frac{\text{Motor nameplate current at 50 Hz}}{\text{Inverter rated current}} \times 100 (\%)$ <p>[Example]</p> <p>Inverter: Rated current 16.5 A Motor: Rated current 15 A</p> <p>Thermal level setting</p> $= \frac{15}{16.5} \times 100 = 90\%$	E-therm 100%	Set a new value in the function mode (see page 9-26).
<p>External frequency setting</p> <ul style="list-style-type: none"> ● Start (F-26) ● End (F-27) 	<p>Start point or bias adjustment and end point or gain adjustment for external speed setting signal input, 4 - 20 mA, 0 - 10 V and 0 - 5 V. These frequencies are 0 Hz at standard setting. At 0 Hz, the inverter is operated at the selected V/F pattern.</p> <div style="text-align: center;">  <p>Reverse conversion is also possible.</p> <p>External frequency setting</p> <p>4 - 20 mA 0 - 10 V 0 - 5 V</p> </div>	F-START 000.0Hz E-END 000.0Hz	Set new values in the function mode (see page 9-27).

o Simple trial operation method for operation pattern 1

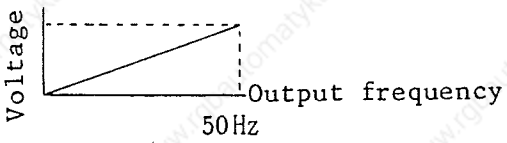
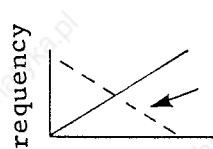
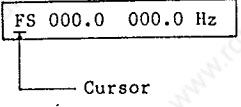
The most simple operation with no additional external device such as a potentiometer or switches can be done by the operation pattern 1 shown on page 6-6. To do this operation, however, some data change in monitor mode is required.

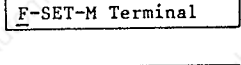
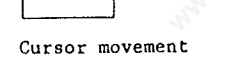
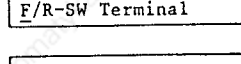
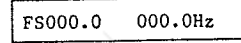
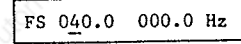
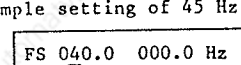
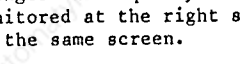
Step	Digital operation panel	Display	Remarks
Power ON			Power on and the frequency setting (FS) and output frequency appears. In the second case and after, the previous display (before power off) appears.
Selection of frequency command method	Press MON or ▲ .		Frequency setting command is selected in digital operation panel.
	Move the cursor, using ▶ , and set to Ope.-key using ▼ ▲ .		Cursor movement
Selection of operation command method	Press MON or ▲ .		Operation command is selected in digital operation panel.
	Move the cursor, and set to Ope.-key using ▼ ▲ .		Cursor movement
Frequency setting	Press MON to display FS .		Move the cursor left by one digit. For details, see page 9-7.
	Move the cursor, using ▶ , and set the frequency, using ▲ ▼ .	<p>(Sample setting of 45 Hz)</p> 	
			
Operation	Press FWD RUN or REV RUN .	Changes in frequency can be monitored at the right side of the same screen.	Press FWD RUN for forward operation and REV RUN for reverse operation. The motor starts to accelerate for operation.
	Select the frequency setting (FS) mode, and change the frequency setting using ▶ ▲ ▼ .	<p>(Sample setting of 30 Hz for deceleration)</p> 	If the setting is changed during motor operation, acceleration or deceleration are started, reaching the set value.
When acceleration and deceleration are required			
Stop	Press STOP .		The motor decelerates when the STOP is pressed, and stops operation.

Operation pattern 1

When the frequency setting, operation and stop command are carried out on the digital operation panel

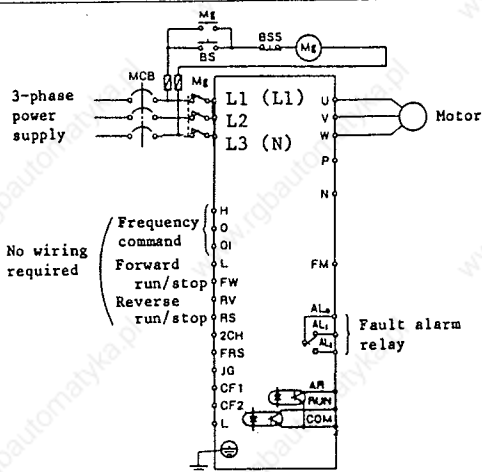

Note 1) If the frequency and operation command are set during power failure, operation will be restarted at power ON. For safety, however, it is recommended that Mg be inserted into the input side.

Step

Description

Power ON

After power ON, the previous display (before power off) appears.

FS 000.0 000.0 Hz

Cursor



Selection of frequency setting mode

The new frequency can be set because the above mode is for frequency setting.

FS 000.0 000.0 Hz

Cursor

Frequency setting

Move the cursor, using , and input the preset value of frequency with  .

FS 040.5 000.0 Hz



Cursor

Operation command

Press  for forward operation.

Press  for reverse operation.



Acceleration/deceleration

Move the cursor with , and re-input the preset value of frequency with  . When it is entered, acceleration or deceleration are started.

1. Press .

When this  key is pressed, the motor decelerates and stops according to the preset deceleration time. (F-01, F-02).

2. Set the setting frequency to "0".

Move the cursor with  and set the frequency preset value to 0, using the  key. The motor decelerates and stops according to the preset deceleration time. (F-01, F-02).

Stop

Operation pattern 2

When the frequency setting and operation/stop command are carried out externally; (FW/RV terminals)

The following description is given for operations on the operation boxes (OPE-4M/8M).

Note 1) If the frequency and operation command are set during power failure, operation will be restarted at power ON. For safety, however, it is recommended that Mg be inserted into the input side.

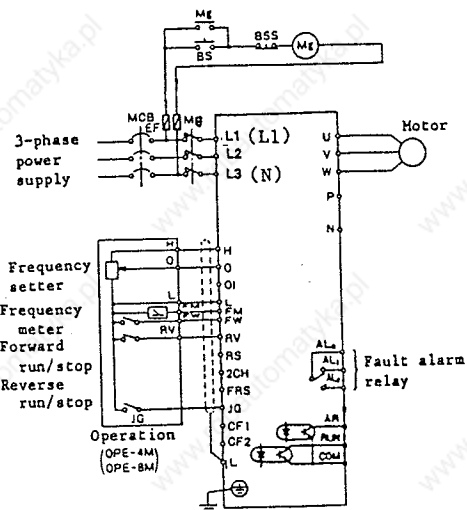

Step	Description
Power ON	After power ON, the previous display (before power off) appears.
Selection of frequency command method	<p><code>F S 0 0 0 . 0 0 0 0 . 0 H z</code></p> <p>Press MON or ▲ once to select the frequency command method.</p> <p><code>F - S E T - M O p e . - K e y</code></p> <p>Cursor movement</p>
Selection of operation command method	<p>Adjust the cursor to "0" position with the ▶ key, and press the ▲ key to select the terminal mode.</p> <p><code>F - S E T - M T e r m i n a l</code></p> <p>Press MON to select the operation command method.</p> <p><code>F / R - S W O p e . - K e y</code></p>
Operation command	<p>Adjust the cursor to "0" position with the ▶ key, and press ▲ to select the terminal mode.</p> <p><code>F / R - S W T e r m i n a l</code></p>
Frequency setting	<p>(FS display)</p> <p>"F" and "R" are displayed, using Forward Operation (FWD) and Reverse Operation (REV) on the operation box respectively.</p> <p>Turn the frequency setter on the operation box (OPE) for frequency setting: the motor will be operated. Set the switch (FWD or REV) on the operation box (OPE) to "STOP": the motor will decelerate and stop according to the preset deceleration time. Even when [STOP] on the operation panel is pressed, the motor decelerates and stops according to the preset deceleration time. In this case, the switch on the operation box (OPE) should be off once and on again for restarting the inverter.</p> <p>In the terminal mode, it is possible to make [STOP] on the operation panel effective or ineffective (see descriptions on page 9-34 and field 3).</p>
Stop	

Operation pattern 3

When the frequency is set on the digital operation panel, and operation/stop command is carried out externally (FW/RV):

Note 1) If the frequency and operation command are set during power failure, operation will be restarted at power ON. For safety, it is recommended that Mg be inserted into the input side.

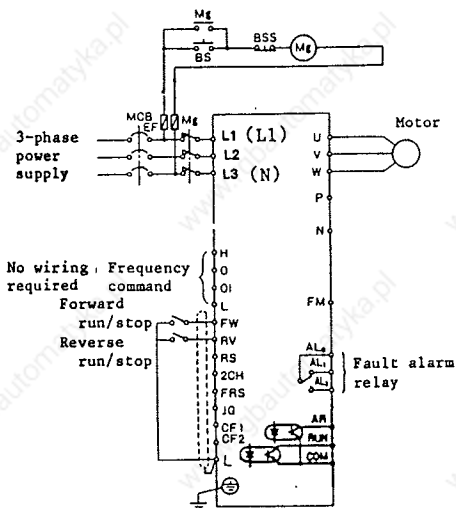

Step	Description
<p>Power ON</p>	<p>After power ON, the previous display (before power off) appears.</p> <p style="text-align: center;">FS 000.0 000.0 Hz</p>
<p>Selection of operation command method</p>	<p>Press MON or ▲ 2 times to select the operation command method.</p> <p style="text-align: center;">F / R - S W O p e . - K e y</p>
<p>Selection of frequency setting mode</p>	<p>Adjust the cursor to "0" position with the ▶ key and select the terminal mode with the ▲ key.</p> <p style="text-align: center;">F / R - S W T e r m i n a l</p> <p style="text-align: center;">— Cursor movement —</p>
<p>Frequency setting</p>	<p>Press the MON or ▼ key any times to select the frequency setting mode.</p> <p style="text-align: center;">F S 000.0 000.0 Hz</p>
<p>Operation command</p>	<p>Move the cursor with the ▶ key and input the preset value of frequency with ▲ and ▼ keys.</p> <p style="text-align: center;">F S 040.5 000.0 Hz</p>
<p>Acceleration/ deceleration</p>	<p>Forward operation is performed with FW-L ON.</p> <p>Reverse operation is performed with RV-L ON.</p>
<p>Stop</p>	<p>Move the cursor with the ▶ key, and re-enter the preset value of frequency.</p> <p>Turn off the control terminals FW-L and RV-L, and the motor will decelerate and stop according to the preset deceleration time.</p>
<p></p>	<p>In the terminal mode, the motor can be stopped with the STOP key. The STOP key can be made effective or ineffective. (See descriptions page 9-34 and field ④.)</p>

6.4 Example of Connection When a Motor with a Brake is Used

⚠ WARNING: To avoid personal injury

When stops the inverter for emergency case not only using the function of free run stop (FRS) or reset (RS) but also the power supply to the inverter must be turned off.

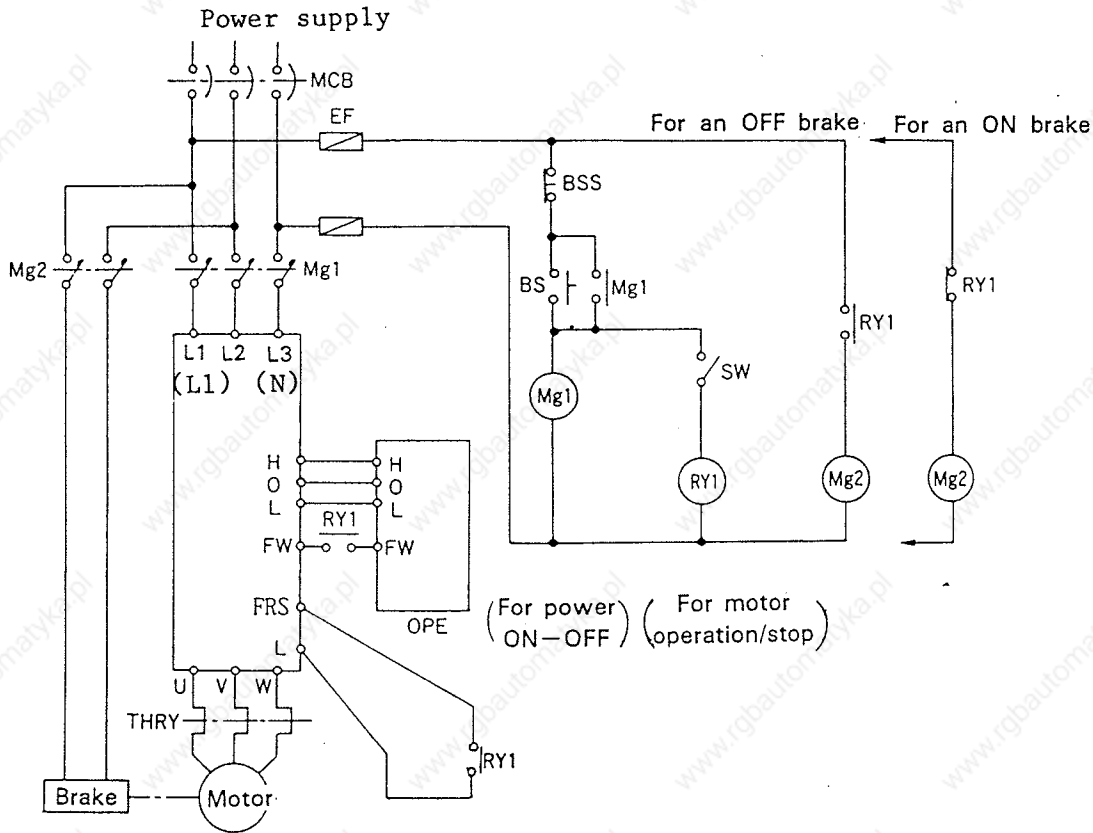

Motor speed

	Mechanical brake		Soft stop	
SW (Operation/Stop switch)	OFF	ON	OFF	ON
Mg1	OFF	ON	OFF	ON
Mg2 {	ON	OFF	ON	OFF
	OFF	ON	OFF	ON

Figure 6-1 Example of Connection when a Motor with a Brake is Used

7. MAINTENANCE AND CHECK

The inverter consists of many components, and will not fulfill the function unless those parts operate normally. It is therefore necessary to find fault signs of the parts and equipment early by periodic inspection and to take measures for them.

Prior to maintenance and check, it is recommended to check the setting data because it may be changed before restart. (See Appendix 1.)

7.1 Cautions on Maintenance and Check

 **WARNING:** To avoid personal injury

Hazardous voltage is present on the terminals and printed circuit board. Always disconnect power supply and put the TAGOUT, LOCKOUT beginning any service. After turning off power supply, do not touch the internal parts of inverter until the LED lamp on the printed circuit board (visible after the terminal cover is removed) goes out, and then measure the DC bus voltage \oplus , M and \ominus terminals with voltmeter, and make sure no voltage on them.

 **CAUTION:** To avoid damage to the inverter

- (1) Keep the unit clean to prevent entry of dust or dirt.
 - (2) Do not pull the cable when removing a connector.
 - (3) Take special care not to mis-insert the connector.
 - (4) Be sure to tighten the terminals and connectors securely.
 - (5) Check no moisture and oil mist are present inside:
- For details, see table 7-1.

7.2 Checking Items

- (1) Routine check
- (2) Periodical check (yearly)
- (3) Insulation resistance and withstand voltage test

⚠ CAUTION: To avoid personal injury and damage to the inverter
To conduct insulation resistance and withstand voltage tests, connect the terminals as shown in Figure 7-1 and perform measurements under the following conditions:

- Measure the resistance between a terminal and the ground with a 500 VDC megger as shown in Figure 7-1. Confirm that the inverter withstands 5 MΩ or more.
- Apply 1500 VAC (200 V class), and 2000 VAC (400 V class) between a terminal and ground for one minute as shown in Figure 7-1. Confirm that there is no abnormality.
- Do not perform insulation resistance and withstand voltage tests for the terminals not shown in Figure 7-1 such as printed circuit board.

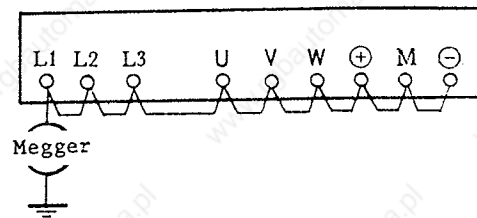

Figure 7-1 Terminal Connection for Insulation Resistance and Withstand Voltage Tests

Table 7-1 Routine . . . Periodic Inspections

Component to be checked	Check item	Details of check	Interval		Check method	Criterion	Standard period before re-placement	Instrument
			Daily	Periodically				
General	Ambient environment	Measure the ambient temperature and humidity and check whether there are dust, noxious gases, and oil mists.	o		See the notes described on page 2-1.	Ambient temperature range: -10°C - +40°C, no freezing	-	Thermometer
	Entire unit	Check whether there are abnormal vibration and noise.	o		Audio-visually check vibration and noise.	Ambient humidity range: 20% - 90%, no condensation		Hygrometer
	Power supply voltages	Check whether the main circuit voltage and control voltage are at the correct levels.	o		Measure voltages across the L1 and L2 terminals on the terminal board of the inverter.	1φ 220~240 V / 50 Hz, 60Hz 3φ 380~415 V / 50 Hz 400~460 V / 60 Hz		Multimeter
Main circuit	General	1) Insulation resistance test (between a main circuit terminal and the ground terminal) 2) Looseness of tightened screws 3) Trace of overheat on individual parts 4) Cleaning	o	o	1) See page 7-2. 2) Retighten screws. 3) Visual check	1) See page 7-2. 2) No abnormality 3) No abnormality	-	500 V megger
	Connection conductor and wire	1) Strain of conductor 2) Tearing or deteriorated wire sheath (cracks, discoloration, etc.)	o	o	1) Visual check 2) Visual check	1) No abnormality 2) No abnormality	-	
	Transformer	Nasty smell and abnormal swell tone	o	o	Acoustic check	No abnormality		
	Terminal block	Damage	o	o	Visual check	No abnormality		Analog multimeter
	Transistor and diode modules	Resistance between terminals	o	o	See pages 7-9 to 7-11.	See pages 7-9 to 7-11.		
	Smoothing capacitor	1) Liquid leakage 2) Safety valve protrusion and bulking 3) Capacitance	o	o	1) Visual check 2) Visual check 3) Measure the capacitance with a capacitance meter.	1) No abnormality 2) No abnormality 3) At least 85% of the rated capacitance	Five years (Note 1)	Capacitance meter

Table 7-1 Routine ar ...dic Inspections (Continued)

Component to be checked	Check item	Details of check	Interval		Check method	Criterion	Standard period before re- placement	Instrument
			Daily	Period- ically				
Main circuit	Electromagnetic contactor	1) Abnormal tone during operation 2) Abnormality on the contact	o	o	1) Acoustic check	1) No abnormality		
	Resistor	1) Large cracks and discoloration 2) Wire breakage	o	o	1) Visual check 2) Disconnect either wire and measure the resistance with a multimeter.	1) No abnormality 2) The measured resistance must be the indicated resistance $\pm 10\%$.		Multimeter
Control	Operation	1) Difference among inter-phase output voltages during operation of the inverter alone	o		1) Measure the inter-phase voltages at the inverter output terminals U, V, and W.	1) The inter-phase voltage difference must be 2% or less.	-	
	Parts including PC boards	General 1) Nasty smell and discoloration 2) Remarkable rust Capacitors Trace of liquid leakage and deformation	o	o	Visual check Visual check.	No abnormality (Note 2)		
Cooling	Cooling fan	1) Abnormal vibration and noise	o		1) Turn off the cooling fan and rotate it manually.	The cooling fan must rotate smoothly.	2 - 3 years under normal condition	
		2) Loose plugs and screws 3) Dust	o	o	2) Retighten plugs and screws.	No abnormality		
Indication	Indication on the digital operation panel	1) Illegible display 2) Insufficiently connected or damaged connector	o	o	Visual	The display must be legible. (Note 3)	Seven years under normal condition	

Note 1: If the inverter is used under a heavy load at a high temperature, the life of the smoothing capacitor is significantly reduced. When replacing the smoothing capacitor with a one which has been stored for three or more years, perform aging under the following conditions before using it:

- 1) At first, apply 80% of the rated voltage to the capacitor for one hour at room temperatures.
- 2) Next, raise the voltage to 90% of the rated voltage and maintain the voltage for one hour at room temperature.
- 3) Finally, apply the rated voltage to the capacitor for five hours at room temperatures.

Note 2: Notes on handling printed circuit board

Usually, no maintenance is required for printed circuit board. If maintenance or check is required, note the following points:

- Prevention of damage due to ESD (Electrostatic Discharge)
The MCUs, ICs, and other components on the printed circuit board are sensitive parts against ESD. Precaution for ESD are required when testing, servicing or repairing. Be sure to ground the working bench, soldering iron, and human body before handling.

Note 3: Since the display is a liquid crystal display, it may be illegible at some viewing angles, however, it is normal.

To minimize the idle time, it is recommended that the parts listed in Table 7-2 be stocked.

Table 7-2 Recommended Spare Parts

Part name	Sequence symbol	Quantity		Remarks
		In use	Spare	
Inverter module	PM	1 - 3	1 - 3	
Cooling fan	FAN	1	1	
Converter module	DM	1	1	
Smoothing capacitor	CB	1 or 2	1 or 2	Store smoothing capacitors at -20°C to +30°C.
Digital operation panel	D.OPE	1	1	
PC (Printed circuit) board	Control PC board	1	1	The control PC board cannot be used for all models in common.
PC board	Base PC board	1	1	11 to 22HF3EA

7.3 Measuring Method of Input/Output Voltage, Current, and Power

General-purpose measuring instruments to measure input/output voltage, current, and power are listed below. For voltage, measure the effective value of the fundamental wave. For power, measure the total effective value.

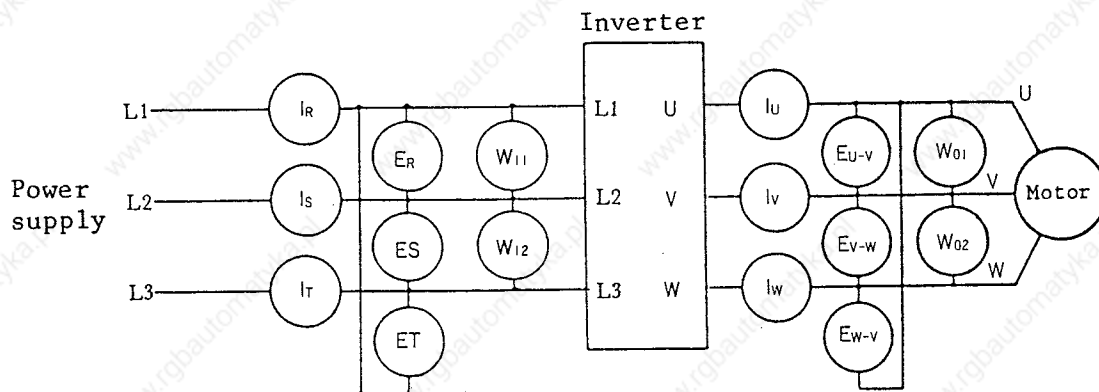







Figure 7-2 Measuring Method

Table 7-3 Measuring Location and Measuring Instruments

Measuring item	Measuring location	Measuring instrument	Measured value	Standard measurement value
Power supply voltage E_1	Between L1 and L2(ER), L2 and L3(ES), and L3 and L1(ET)	 Moving-iron type voltmeter or rectifier type voltmeter	Effective value of the fundamental wave	1 ϕ 220 to 240 V / 50 Hz, 60Hz 3 ϕ 380 to 415 V / 50 Hz 400 to 460 V / 60 Hz
Power supply current I_1	Current at L1, L2, and L3 terminals (IR) (IS) (IT)	 Moving-iron type ammeter	Total effective value	
Primary power W_1	Between L1 and L2 and between L2 and L3 (W_{11}) (W_{12})	 Electro-dynamometer type wattmeter	Total effective value	
Primary power factor Pf_1	Calculated from each measured value of power supply voltage E_1 , power supply current I_1 , and primary power W_1 by using the following formula: $Pf_1 = \frac{W_1}{\sqrt{3} E_1 I_1} \times 100 (\%)$			
Output voltage E_0	Between U and V(EU), V and W(EV), and W and U(EW)	See page 7-8 or use a rectifier type voltmeter.	Total effective value	
Output current I_0	Current at U(IU), V(IV) and W(IW) terminals	 Moving-iron type ammeter	Total effective value	
Output power W_0	Between U and V(W_{01}) and between V and W(W_{02})	 Electro-dynamometer type wattmeter	Total effective value	
Secondary power factor	Calculated from each measured value of output voltage E_0 , output current I_0 , and output power W_0 by using the following formula: $Pf_0 = \frac{W_0}{\sqrt{3} E_0 I_0} \times 100 (\%)$			

Note 1: The voltmeter should indicate effective value of fundamental wave for voltage and total effective value for current and power.

Note 2: Since inverter output waves are distorted, errors are prone to occur particularly at low frequencies. However, measuring method and instruments which listed above provide comparatively accurate values.

Table 7-4 Output Voltage Measurement

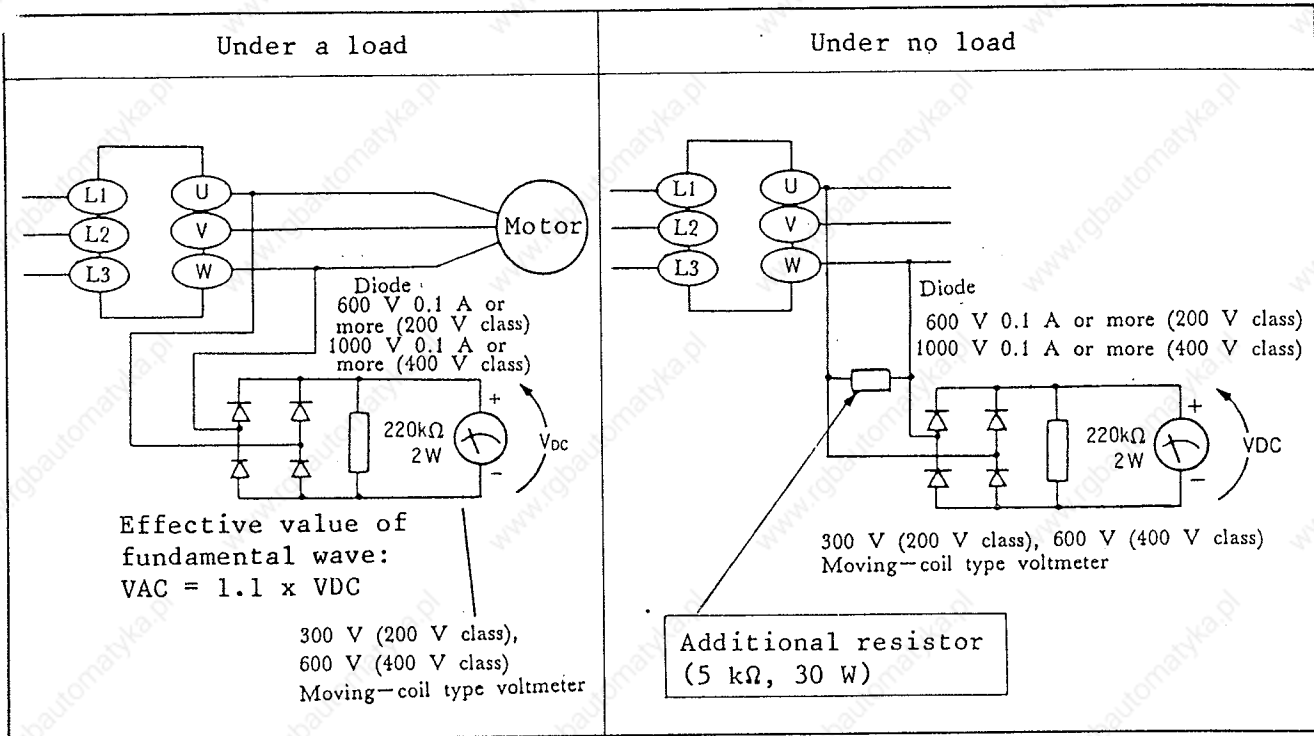

7.4 Checking the Converter Module and Inverter Module



WARNING: To avoid personal injury.

- Before beginning check, turn the power off then wait until the voltage between \oplus and \ominus terminals drops to 15 VDC or less.
- Use an ohmmeter in the 1 Ω range.

Table 7-5 Converter (Diode) Module Check

Circuit diagram	External view													
	<p>200 V class, 400 V class 2.5-8 HF3EA</p>	<p>400 V class 11 - 22HF3EA</p>												
<table border="1"> <thead> <tr> <th data-bbox="224 1037 818 1129">Ohmmeter terminals (-) \rightarrow (+)</th> <th data-bbox="818 1037 1062 1129">Resistance</th> </tr> </thead> <tbody> <tr> <td data-bbox="224 1129 818 1262">L1, L2, L3 \rightarrow L1, L2, L3 (3 ways) (equivalent to L1-L2, L2-L3, and L1-L3)</td> <td data-bbox="818 1129 1062 1262">50 kΩ or more</td> </tr> <tr> <td data-bbox="224 1262 818 1325">\oplus \rightarrow L1, L2, L3</td> <td data-bbox="818 1262 1062 1325">50 kΩ or more</td> </tr> <tr> <td data-bbox="224 1325 818 1388">L1, L2, L3 \rightarrow \oplus</td> <td data-bbox="818 1325 1062 1388">50 Ω or less</td> </tr> <tr> <td data-bbox="224 1388 818 1451">\ominus \rightarrow L1, L2, L3</td> <td data-bbox="818 1388 1062 1451">50 Ω or less</td> </tr> <tr> <td data-bbox="224 1451 818 1520">L1, L2, L3 \rightarrow \ominus</td> <td data-bbox="818 1451 1062 1520">50 kΩ or more</td> </tr> </tbody> </table>			Ohmmeter terminals (-) \rightarrow (+)	Resistance	L1, L2, L3 \rightarrow L1, L2, L3 (3 ways) (equivalent to L1-L2, L2-L3, and L1-L3)	50 k Ω or more	\oplus \rightarrow L1, L2, L3	50 k Ω or more	L1, L2, L3 \rightarrow \oplus	50 Ω or less	\ominus \rightarrow L1, L2, L3	50 Ω or less	L1, L2, L3 \rightarrow \ominus	50 k Ω or more
Ohmmeter terminals (-) \rightarrow (+)	Resistance													
L1, L2, L3 \rightarrow L1, L2, L3 (3 ways) (equivalent to L1-L2, L2-L3, and L1-L3)	50 k Ω or more													
\oplus \rightarrow L1, L2, L3	50 k Ω or more													
L1, L2, L3 \rightarrow \oplus	50 Ω or less													
\ominus \rightarrow L1, L2, L3	50 Ω or less													
L1, L2, L3 \rightarrow \ominus	50 k Ω or more													
<p>Note: Check the resistance using the converter modul alone.</p>														

Table 7-6 Inverter (Transistor) Module Check

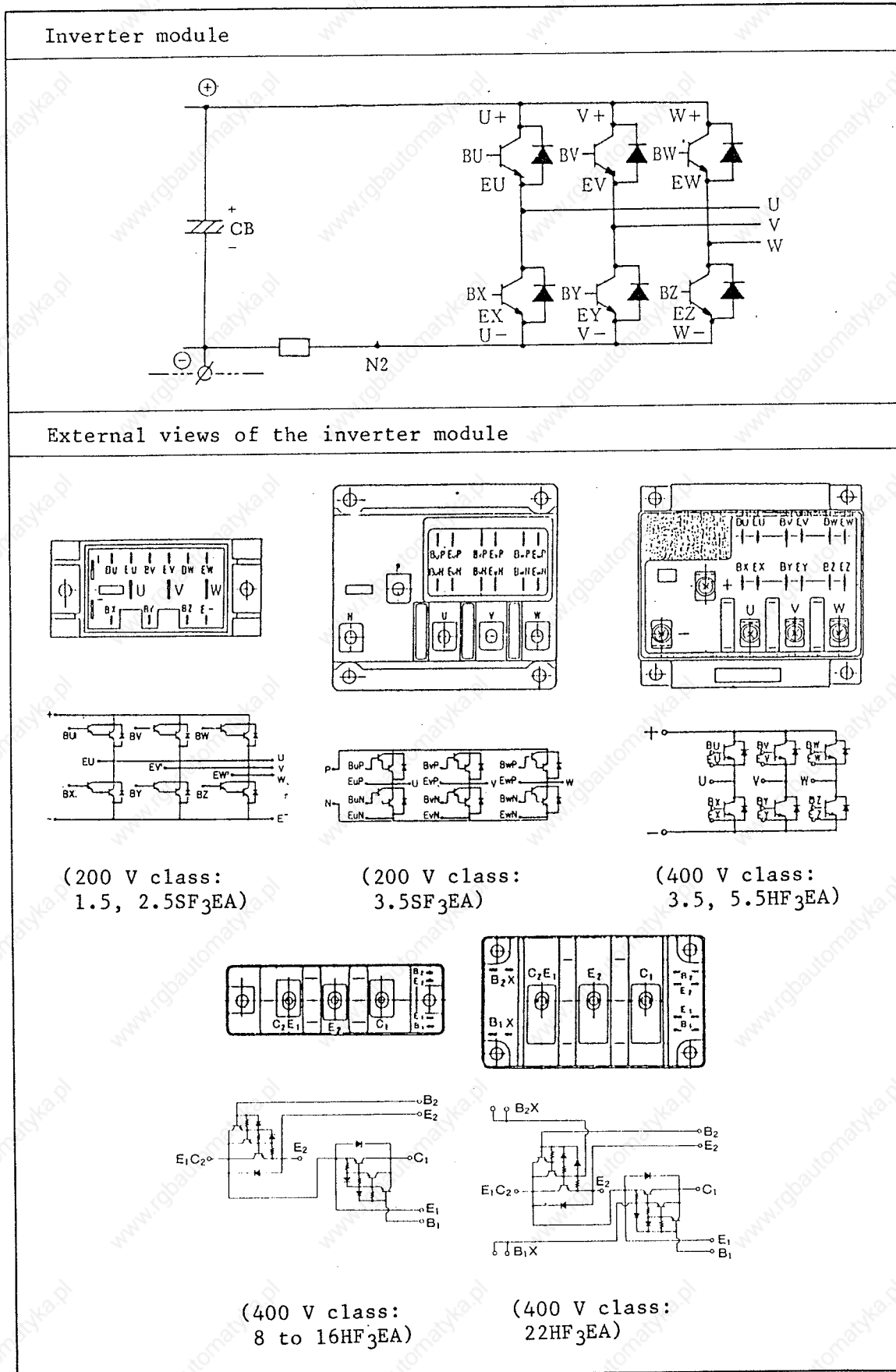

Table 7-7 Inverter (Transistor) Module Check in the Assembly State

When measured in the assembly state			When measured in the disassembly state		
Ohmmeter terminal colors Black - Red (-) - (+)	Resistance	Place to check	Ohmmeter terminal colors Black - Red (-) - (+)	Resistance	Place to check
⊕ - U	50 kΩ or more	U-phase upper frame (U ⁺)	BU - U ⁺	1000 Ω or less	U-phase upper frame (U ⁺)
⊕ - V		V-phase upper frame (V ⁺)	BV - V ⁺		V-phase upper frame (V ⁺)
⊕ - W		W-phase upper frame (W ⁺)	BW - W ⁺		W-phase upper frame (W ⁺)
⊖ - U	50 Ω or less	U-phase lower frame (U ⁻)	BX - U ⁻	1000 Ω or less	U-phase lower frame (U ⁻)
⊖ - V		V-phase lower frame (V ⁻)	BY - V ⁻		V-phase lower frame (V ⁻)
⊖ - W		W-phase lower frame (W ⁻)	BZ - W ⁻		W-phase lower frame (W ⁻)
U - ⊕	50 Ω or less	U-phase upper frame (U ⁺)	U ⁺ - BU	50 to 200 Ω or more	U-phase upper frame (U ⁺)
V - ⊕		V-phase upper frame (V ⁺)	V ⁺ - BV		V-phase upper frame (V ⁺)
W - ⊕		W-phase upper frame (W ⁺)	W ⁺ - BW		W-phase upper frame (W ⁺)
U - ⊖	50 kΩ or more	U-phase lower frame (U ⁻)	U ⁻ - BX	50 to 200 Ω or more	U-phase lower frame (U ⁻)
V - ⊖		V-phase lower frame (V ⁻)	V ⁻ - BY		V-phase lower frame (V ⁻)
W - ⊖		W-phase lower frame (W ⁻)	W ⁻ - BZ		W-phase lower frame (W ⁻)

8. FAULT MESSAGE AND TROUBLESHOOTING

This section provides a meaning of fault message and troubleshooting. If a fault has occurred, locate the cause and corrective measures before restarting operation. Also see the troubleshooting flow chart in this section. When no cause is found and not possible to restart the inverter, contact your distributor.

Note: When you contact with your distributor for a fault, clearly mention inverter model name, manufacturing number, kind of fault message, programmed data (use the data list of appendix 1) and whatever you did to solve a fault. Also see the section 7.

8.1 Causes and Action

Table 8-1 Causes and Action

Symptom of malfunction				Meaning of message	Re-set	Check points	Suggested remedy
Circuit breaker MCB	Electro-magnetic contactor Mg	Display on digital operation panel (?ERROR )	Fault alarm relay				
o	-	-	-	Abnormality between the MCB and an inverter output terminal	-	<ul style="list-style-type: none"> . Check for a shortcircuit on the power supply side. . Check the capacity of the MCB. . Check for a ground fault in the inverter or on the power supply side. 	<ul style="list-style-type: none"> . Correct the shortcircuit. . Increase the MCB capacity. . Correct the ground fault.
						Check whether the converter module is damaged.	Replace the converter module.
						Check whether the magnet switch in the inverter operate correctly.	Replace the magnet switch.
						Check whether the current limiting resistor (RS) is normal.	Replace the resistance.
		OC. Accel OC. Decel OC. Drive GND Flt	o	Overcurrent	*	Check whether the inverter module is damaged or the motor or a connection line has a ground fault.	<ul style="list-style-type: none"> • Replace the inverter module. • Correct the ground fault.
	o	-	-	Power failure	-	Check whether there is a power failure.	Restore the power.
						Check whether the connections of the MCB and Mg are normal.	Replace the MCB and/or Mg.
		Under V.	o	Under power supply voltage	*	Momentary power loss or voltage fluctuation.	Correct the problem in the power distribution system.
						Check input disconnect device and input contactor.	Replace the defective equipment.
		Inst. P-F	o	Instantaneous power failure	*	<ul style="list-style-type: none"> . Check input disconnect device and input contactor. . Check whether the power was turned off then turned on again with POWER OFF still displayed on the inverter. 	<ul style="list-style-type: none"> . Replace the defective equipment. . Be sure to turn on the power again after the POWER OFF display on the inverter disappears. When the load is lighter, the POWER OFF display stays on for a longer time.

* For releasing an fault (error), connect thr RS terminal to the L terminal on the PC board or press the reset button at the left below on the PC board. Fault releasing by power off is not effective. Until reset signal has been given, the fault will be remained.

Table 8-1 Causes and Action (Continued)



Symptom of malfunction				Meaning of message	Re-set	Check points	Suggested remedy
Circuit breaker MCB	Electro-magnetic contactor Mg	Display on digital operation panel (?ERROR )	Fault alarm relay				
		Over V.	o	DC bus voltage	*	<ul style="list-style-type: none"> Check for incoming line voltage. Check whether the capacitor for power factor improvement on the power source line is turned on and off. Check whether the motor is decelerated rapidly. 	<ul style="list-style-type: none"> Lower the line voltage. Avoid connecting capacitor, or insert an AC reactor on the input side. Prolong the deceleration time. Set a time that conforms to inertia of the load. Using a proper regenerative braking device.
		OV SRC	o	Overvoltage source (High line voltage)	*	<ul style="list-style-type: none"> Check for incoming line voltage. 	<ul style="list-style-type: none"> Correct the line voltage. Insert an AC reactor on the input side.
		OC. Accel	o	Overcurrent during motor acceleration	*	<ul style="list-style-type: none"> Connected inertia is too large to be accelerated within the time set. Check for output short-circuit or ground fault. Check for start or jogging frequency set too high. Check for torque boost set too high. Check whether the motor is constrained. 	<ul style="list-style-type: none"> Prolong the acceleration time. Correct the short-circuit or ground fault. Reduce the start or jogging frequency adjustment. Reduce the torque boost adjustment. Release the motor from the constrained state.
		OC. Decel	o	Overcurrent during motor deceleration	*	<ul style="list-style-type: none"> Connected inertia is too large to be decelerated within the time set. Check for output short-circuit or ground fault. 	<ul style="list-style-type: none"> Prolong the deceleration time. Set a time that conforms to inertia of the load. Correct the short-circuit or ground fault.
		OC. Drive	o	Overcurrent during constant motor operation	*	<ul style="list-style-type: none"> Check for overload caused by driven equipment. Check for output short-circuit or ground fault. 	<ul style="list-style-type: none"> Correct the problem in the driven equipment. Correct the short circuit the ground fault.
		Over L.	o	Inverter overload (overloaded operation)	*	<ul style="list-style-type: none"> Check whether the load is too heavy. Check whether the electronic thermal level is correct. 	<ul style="list-style-type: none"> Reduce the load. Adjust F-23 F-therm. (See page 9-26.)

Table 8-1 Causes and Action (Continued)

Symptom of malfunction				Meaning of message	Re-set	Check points	Suggested remedy
Circuit breaker MCB	Electro-magnetic contactor Mg	Display on digital operation panel (?ERROR )	Fault alarm relay				
		Over C.	o	Overcurrent detection just after power on	*	Check whether the current detector and the detection circuit on the PC board are correct.	Check the current detector and the detection circuit on the PC board.
		OH Fin	o	Fin overheat temperature rise	*	<ul style="list-style-type: none"> . Check the cooling fan. . Check whether inlet or outlet is blocked. . Check whether the ambient temperature is too high. 	<ul style="list-style-type: none"> . Replace the cooling fan. . Do not block the inlet and outlet. . Reduce the ambient temperature.
		CPU	o	Microprocessor error	*	<ul style="list-style-type: none"> . Check for electrical noise source. . Defective PCB. 	<ul style="list-style-type: none"> . Suppress the noise source. . Repair the inverter.
		UV WAIT	-	Low input voltage at automatic restart	-	Check whether the power supply voltage drops to the minimum level when restart function is executed.	Restore the power.
		B2C number	o	Invalid data in soft memory element (NV-RAM)	-	Check the number of times to store the new data per day.	Replace the NV-RAM. The number of times data is written in soft storage device is limited to about ten thousands. (If data is stored several times per day, its life will approximately ten years.)
		ADJUST [] S Number	-	This display does not mean an error. It indicates a time subtracted from IPS-R-T.	-	This display does not indicate an error.	-

8.2 Protection Functions

Table 8-2 Protection Functions

Name (Fault message)	Description
Under voltage (Under V.)	When the input line voltage drops, the control circuit does not function correctly, resulting in a failure due to insufficient base current to the main transistor, motor overheat or insufficient torque. To prevent this, when the input line voltage drops, the output is cut off.
Instantaneous power failure (Inst. P-F)	When a momentary power failure continues 15 ms or more, the output is cut off. In the case of automatic restart function is selected, a long power failure exhausts the control power and the failure signal is released. Note that operation is resumed if an operation command has been issued. In the restart mode, operation is also resumed if an operation command has been issued. (The inverter stops momentarily then restarts.)
Overcurrent OC. Accel OC. Decel OC. Drive	When the inverter output side is shortcircuited or the motor is constrained, a large current flows in the inverter and semiconductors may be damaged. To prevent this, DC current and output current are detected. If a current exceed the limit value, the output is cut off. The type of operation, during acceleration (OC. ACCEL), during deceleration (OC. DECEL) or during constant speed operation (OC. DRIVE) is identified.
Overvoltage (Over V.)	When the DC bus voltage is raised beyond the limited value due to the regenerative energy from the motor, the protection circuit functions to cut off the output.
Overload (Over L.)	When the motor is overloaded, the output is cut off.
Overvoltage source (OV SRC)	When the incoming voltage rises the allowable value, the output is cut off and the OV SRC message appears on LCD. When incoming voltage is higher than the allowable value of parts, the parts will be damaged without indication.

Table 8-2 Protection Functions (Continued)

Name (Fault message)	Description
Fin overheat (OH Fin)	Inverter equipped with heat sinks using fan forced cooling include temperature sensing of the heat sink. This fault message is displayed when the fan cooled heat sink becomes abnormally warm. This message typically indicates a failed cooling fan or an obstruction to the flow of air.
Ground fault protection (GND. Flt)	When unbalanced current due to a ground fault is detected between the inverter output section and the motor, the inverter output is cut off. Therefore, this function protects the inverter but does not protect the human body. To protect the human body against electric shock, use an earth leakage breaker. Note that when a ground fault occurs, an overcurrent alarm, OC. ACCEL, OC. DECEL or OC DRIVE, may be indicated as well as GND. Flt.
Stall prevention circuit (—)	The motor is started in such a way that large current is automatically suppressed so that the inverter does not cause an overcurrent trip due to large start current. In addition, the motor is decelerated in such a way that overvoltage and overcurrent are automatically suppressed so that the inverter does not cause a trip due to overvoltage or overcurrent resulting from regenerative energy during deceleration.
Overload suppression (—)	The motor current (inverter output current) is suppressed. When the motor current exceeds the preset value by potentiometer due to an increased load, the inverter output frequency is reduced to suppress the current.

8.3 Content of Check Points

No motor rotates

— Check the wiring between inverter and motor.

— Check the input voltage whether it is rated voltage or not.

— Check the wiring between (FRS) and (L) on the circuit board

* They should be shorted.

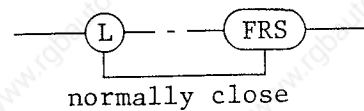

— Check the wiring between (RS) and (L) on the circuit board

* They should be open.

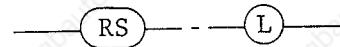

— Check the operation mode in the monitor mode whether it is set according to application system.

F-SET-M: OPE-key/Terminal / COM-EA

F/R-SW: OPE-key/Terminal / COM-EA

— Check the reference (freq. setting) signal

— When F-SET-M "OPE-key" is selected, check the FS□□□.□ in the monitor mode.

— When F-SET-M "Terminal" is selected, check the voltage or current signal on the terminal of printed circuit board.

V_{O-L} : 0 to 10 VDC or 0 to 5 VDC

I_{OI-L} : 4 to 20 mA

— Check whether setting frequency is less than minimum frequency

*Set the frequency more than minimum frequency.

— Check whether LCD indication is in "Monitor" mode.

* Select "Monitor" mode. In the function mode, the inverter cannot start.

Check whether **STOP** key of digital operation panel is pushed when F/R-SW in "Monitor" mode is selected with "terminal".

* Once, run command (FW/RV) must be turned off, and then turned on again from the terminal.

Check the output voltage of U-V, V-W and W-V whether they are balanced or not.

Check whether setting frequency of "SPEED1" to "SPEED3" is proper value when you use multi stage speed terminal (CF1, CF2).

* "SPEED1 to 3" must be set or multi stage speed command (CF1, CF2) must be removed.

Check whether **FWD**
RUN key and **REV**
RUN key of D-OPE are pushed together in "Ope-key" mode.

Check whether forward operation command and reverse operation command are input together in "Terminal" mode.

* Only one signal should be input.

No motor accelerates

Check the reference (freq. setting) signal

When F-SET-M "Ope-key" is selected, check the FS□□□□ in the monitor mode.

When F-SET-M "Terminal" is selected, check the voltage or current signal on the terminal of printed board.

V_{O-L} : 0 to 10 VDC or 0 to 5 VDC

I_{OI-L} : 4 to 20 mA

When F-SET-M "COM-EA" is selected, check the communication system side such as PC or PLC.

Check the F-05 (frequency upper limiter).

Check whether the preset value of "F-END" in the function mode is more than maximum frequency.

Check whether the wiring between (JG) and (L) on the printed circuit board is open.

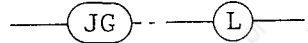

Check the load whether it is too heavy or not.

* Reduce the load or adjust the overload limit level by "OL.LMT" (VR) clockwise.

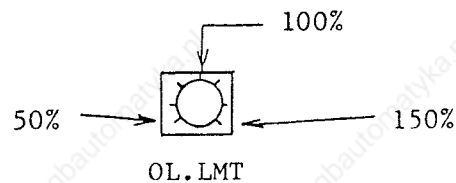

Check whether setting frequency of "SPEED1" to "SPEED3" is proper value when you use multi stage speed terminal (CF1, CF2).

* "SPEED1 to 3" must be set or multi stage speed command (CF1, CF2) must be removed.

Over current trip (OC.Accel, OC.Decel, OC.Drive)

OC trip comes immediately at starting

— Check the following after taking the motor from the inverter.

— Whether OC. trip comes or not.

— OC trip comes.

* Check the inverter (transistor) module.

— No OC. trip

* Check whether a start frequency (F-04) is too high or not.

During the inverter operating (accelerating, decelerating or constant speed)

— Whether the starting frequency is too high or not.

— Whether the V-boost is too high or not.

— Whether the load is too heavy or not.

— Whether the Acc./Dec. time is too short for the load inertia or not.

— Whether the jogging frequency is too high or not.

8.4 Life of Soft Memory Element (NV-RAM)

In the following case, it is presumed that the expected service life of soft memory element mounted on printed circuit board has been reached; therefore, replace it with a new printed circuit board.

Numerals

After power ON, B2C [] [] [] remains displayed, and no operation is performed.

- No operation is performed even for forced reset or even when the initial setting is selected. See page 9-3.

Note 1: Operation and stop should be performed, using a command from the control terminal or digital operation panel.

The soft memory element is used to store parameter changes when incoming power supply is interrupted. See page 2-3. If power is turned ON and OFF several times per day to store the changed data in memory, its life will be approx. 10 years.

It is recommended that the inverter is operated and stopped with a control terminal command or digital operation panel, without turning power ON and OFF; it should be noted that if the inverter is operated and stopped with power ON and OFF whenever the setting data is changed, it will not last longer.

(However, when the power has been turned on, changing data multiple times and pressing the STR key does not affect the life. Therefore, when test operation data is changed frequently, the power must be turned off for data storage after the last change to data.)

Note 2: When no data is stored in memory after various operations are performed although the data is set and the **STR** is depressed, it should be noted that this abnormality is due to the following reason. .

Reason Set the data and press the **STR**, then press the Forced Reset (or short-circuit RS-L terminals) simultaneously with power off. See page 2-3.

Countermeasures ... Release the Forced Reset (or disconnect RS-L) and turn power off once to store the changes. See page 2-3.

Note 3: The following power supply conditions may damage the converter module:

- The unbalance ratio of the power supply voltage is 3% or more.
- The power capacity is ten times or more the inverter capacity and 500 kVA or more.
- The power supply voltage changes rapidly.

Examples:

- A number of inverters are connected together with very low impedance line connections.
- Capacitors for power factor improvement may be switched on line.

If one of the above conditions exists, it is recommended that a reactor of approximately 3% impedance (percentage of voltage drop at the rated current) be inserted on the power supply lines for each inverter.

9. DESCRIPTION OF DIGITAL OPERATION PANEL, MONITOR MODE AND FUNCTION MODE

This section contains a digital operation panel description, monitor mode description and function mode description. Read this section to gain a complete understanding of them prior to attempting operate the inverter.

Note: The digital operation panel with the inverter is used for inverter operation, so the inverter cannot be operated without this panel.

9.1 Configuration of Digital Operation Panel

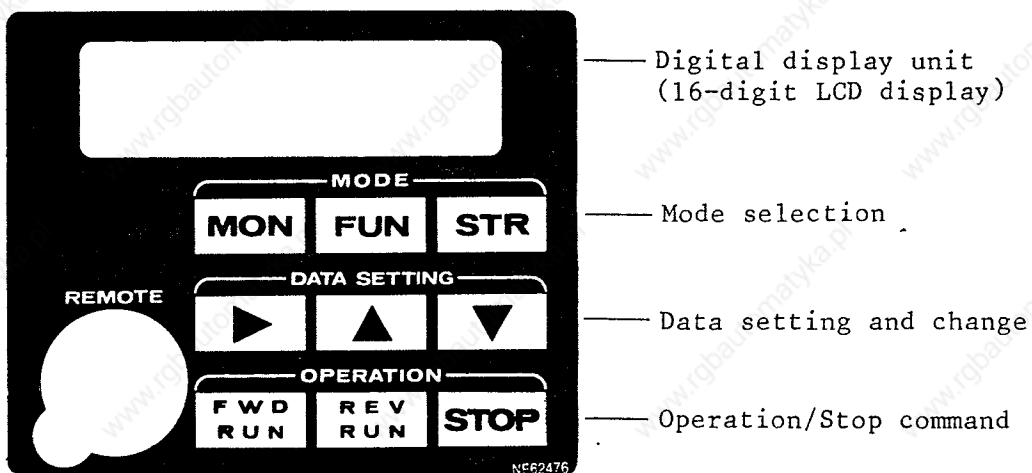

Figure 9-1 Configuration of Digital Operation Panel

Table 9-1 Description of Digital Operation Panel

Section	Key	Key name	Description
Mode selection	<input type="button" value="MON"/>	Monitor	Selects the monitor mode.
	<input type="button" value="FUN"/>	Function	Selects the function mode. Function 1 mode: Selects the function name. Function 2 mode: Selects and changes data.
	<input type="button" value="STR"/>	Store	Stores the preset data in memory.
Data setting and change	<input type="button" value="▶"/>	Cursor movement	Moves the cursor to the place in which the data is set and changed.
	<input type="button" value="▲"/>	UP	Sets and changes data.
	<input type="button" value="▼"/>	DOWN	<p>. The number is incremented by <input type="button" value="▲"/> and decremented by <input type="button" value="▼"/>.</p> <p>The number is carried: 9 0 (0, 1, 2, 8, 9)</p> <p>. For character:</p> <p><input type="button" value="▲"/> Next (A → B) <input type="button" value="▼"/> Back (B → A)</p> <p>. For code:</p> <p><input type="button" value="▲"/> Next (eg. Ope.-key → Terminal → COM-EA) <input type="button" value="▼"/> Back (COM-EA → Terminal → Ope.-key)</p> <p>. For mode:</p> <p><input type="button" value="▲"/> Next mode (eg. F-00 VF1-VC → F-01 ACCEL-1) <input type="button" value="▼"/> Previous mode (eg. F-01 ACCEL → F-00 VF1-VC)</p> <p>(When the key is continuously pressed, data is changed continuously.)</p>
Operation / Stop	<input type="button" value="FWD RUN"/>	Forward operation	Commands the forward operation.
	<input type="button" value="REV RUN"/>	Reverse operation	Commands the reverse operation.
	<input type="button" value="STOP"/>	Stop	Stops operation.

9.2 Returning to the Original Standard Setting

To return the inverter to the original standard setting, observe the following procedure:

- (1) Turn the power on.
- (2) Set the rightmost DIP switch on the printed circuit board to ON.

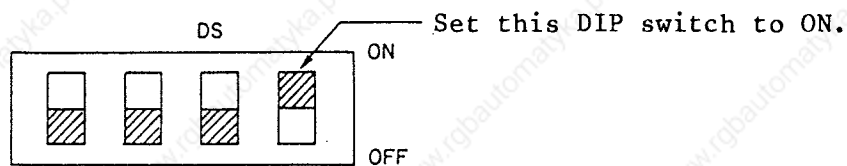

- (3) Press the forcible reset button on the printed circuit board while holding down the **MON**, **FUN**, and **STR** keys on the digital operation panel at one time.
- (4) Release the **MON**, **FUN**, and **STR** keys one to two seconds after reset. Then, **B2C.....** (ROM number) is displayed. If these keys are released earlier, **FS000.0 000.0 Hz** will be displayed. Retry steps (3) and (4).
- (5) Turn the power off.
- (6) Set the DIP switch to OFF.
- (7) Turn the power on again and confirm that the data is set to the original standard setting values.

Note 1: If the DIP switch of the rightmost is set to ON, the following display appears next fault display.

Fault display

#1, 2, 3

a A-0000 DATA-41

This does not mean an error. The display is used for check at the factory. To suppress this display, replace the DIP switch to OFF.

Note 2: If soft lock switch LOCK is set to ON (see page 10-9), the inverter cannot be return to the original factory setting.

9.3 Monitor Mode Description and Operation

(1) Monitor mode list

The initial displays, original standard settings, and change ranges of standard settings in the monitor mode are listed below.

- o: The setting can be changed during inverter operation.
- x: The setting cannot be changed during inverter operation.
- : Only the display is given.

Table 9-2 Description of Monitor Mode

Display sequence	Monitor name	Initial display	Original standard setting	Change range	Data setting and change	Remarks
1	Frequency setting and output frequency		000.0	000.0 -375.0	o	<ul style="list-style-type: none"> • Field ① indicates a set value. • Field ② indicates an output frequency. • The symbol [] indicates an operation command as follows: F: Forward rotation R: Reverse rotation • A multi-stage speed is displayed when the corresponding command is input to a terminal. • When the multi-stage speed mode is selected, jogging is one multi-stage speed and the inverter is soft-started and soft-stopped.
	Multi-stage speed setting and output frequency	1S000.0 [] 000.0Hz				
		2S000.0 [] 000.0Hz				
		3S000.0 [] 000.0Hz				
	Extended multi-stage speed setting	4S000.0 [] 000.0Hz				
		5S000.0 [] 000.0Hz				
Jogging frequency setting and output frequency	JG000.5 [] 000.0Hz	0.5	0.5-9.9			
2	Frequency setting command	F-SET-M Terminal	Terminal	Ope.-key Terminal COM-EA	x	Ope. key: Command from the digital operation panel of the inverter Terminal: Terminal command from the inverter
3	Operation command	F/R-SW Terminal	Terminal	Ope.-key Terminal COM-EA	x	COM-EA: For PC communication (option)
4	Motor speed display	RPM 4P 0000rpm	4	2-48	o	A synchronized speed is displayed.
5	Transformed frequency display	/Hz00.0 0000.00	-	0.1-99.9	o	Any value can be displayed per Hz.
6	Output current display		-	3.0-260	o	<ul style="list-style-type: none"> • Field ① indicates the rated current of the inverter. • Field ② indicates the output current.
7	Manual torque boost adjustment	V-Boost Code 31	31	00-99	o	
8	Output voltage gain adjustment	V-Gain 100%	100	100-50	o	
9	Jogging frequency setting	Jogging 00.5Hz	0.5	0.5-9.9	o	
10	Fault display	Move the cursor right to display the fault corresponding to the number 1, 2, or 3. 	-	-	-	<ul style="list-style-type: none"> • A fault history is recorded. 1: Newest fault 2: Previous fault 3: Fault before the previous fault This history can be released by switch 3 selection. See page 9-30.

(2) Procedures in the monitor mode

When the inverter is turned on, the display FS000.0 ... is given in the monitor mode. When the display before turning power off is in the monitor mode listed below, the same display appears as before power off when power is turning on. To understand how to change data, examples are provided here.

- Frequency, multi-speed, or jogging frequency setting
- Motor speed
- Transformed frequency
- Output current
- Jogging frequency

Example 1. Data change of frequency setting command in monitor mode

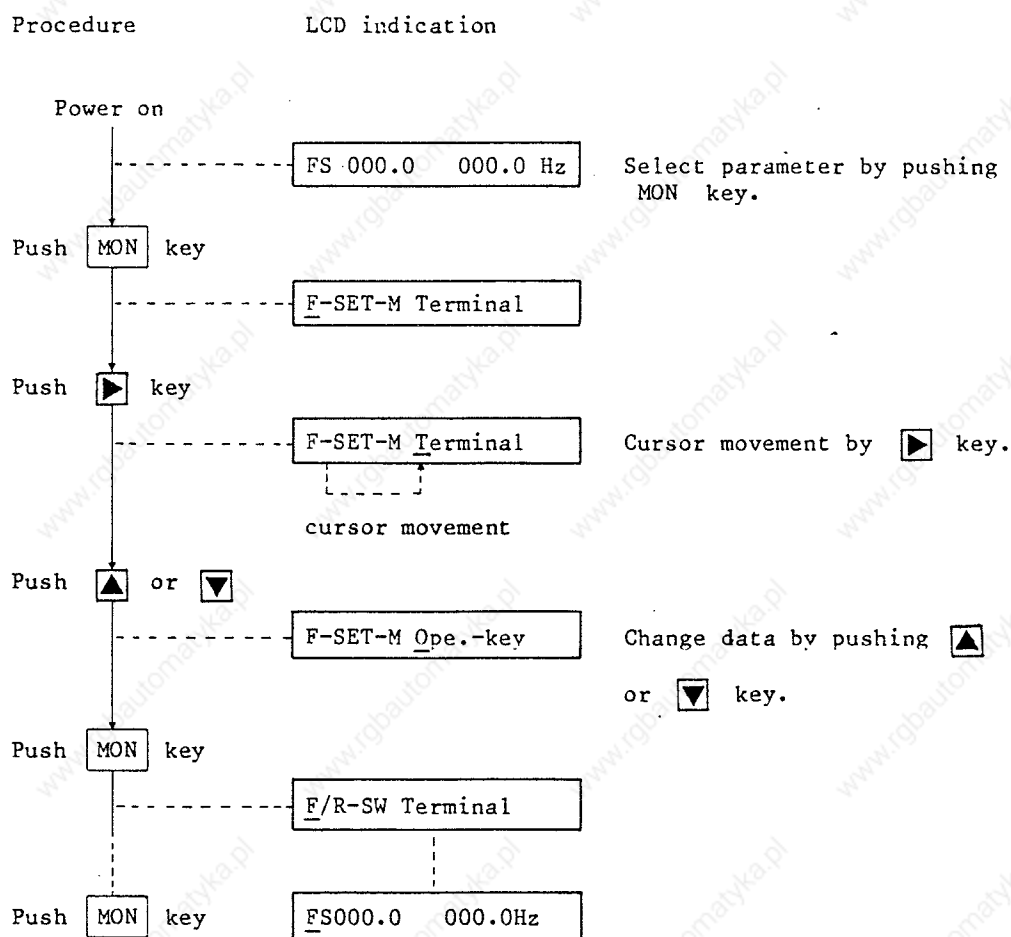

Note: Data change made under the monitor mode are effective when entered, without requiring use of the STR key. Other data can be changed with same procedure.

When soft lock is applied, the cursor cannot be moved.

For soft lock, see page 10-9.

Example 2. Data change of frequency setting value in monitor mode
 To be able to change these values, the frequency set
 command must be in "Ope.-key" mode.

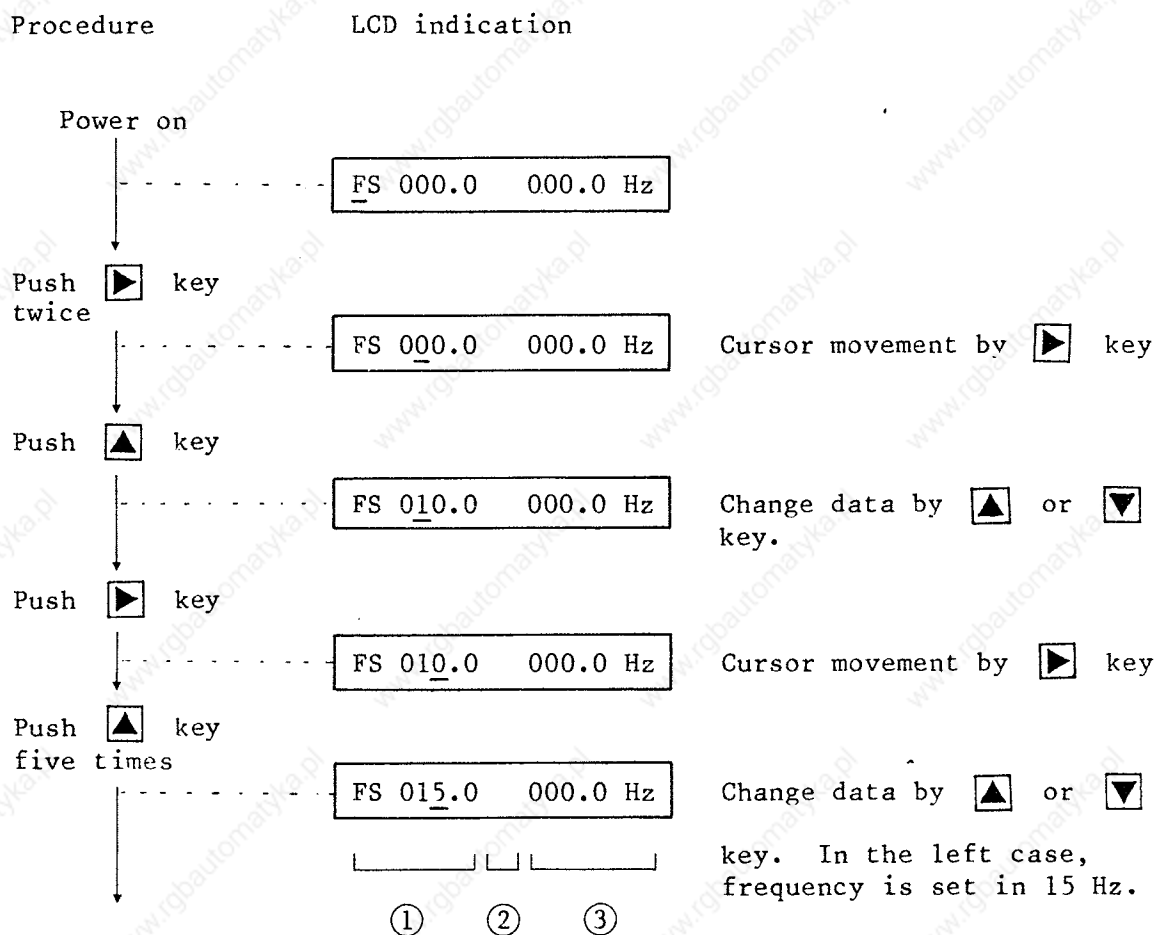

Note: The above shows when no operation command is given. If the operation command is already given, the inverter is driven at the same time when frequency is input into field ①. Field ② shows a direction of motor rotation and output frequencies in field ③. It is also possible to give an operation command after frequencies input into the field ①.

(3) Setting in the monitor mode

Table 9-3 Monitor Mode Description









Display sequence	Monitor name	Key operation	Display	Description																																																
1	Frequency setting command and output frequency display	Mode selection   	Initial display 	<ul style="list-style-type: none"> Frequency setting and frequency monitoring in the Ope.-key mode If the Ope.-key mode is not selected, the setting of FS..... is not possible. (In the terminal mode, the initial display appears but setting is not possible.) <p>Set a frequency in the field indicated by ①. When an operation command is input, the output frequency is increased up to the set frequency. To increase or decrease the frequency during operation, change the frequency in field ① to a desired one.</p> <p>In field ②, F is displayed during forward rotation and R during reverse rotation. The data in field ③ is the output frequency.</p>																																																
		Data setting   																																																		
		Operation command  																																																		
			When a multi-stage speed is set (the initial display is 0)  <p>First stage: 1 } Extended stage speed setting cannot be selected. Second stage: 2 } Third stage: 3 } Fourth stage: 4 } Extended multi-stage speed setting can be selected. Fifth stage: 5 } Sixth stage: 6 } Seventh stage: 6 } Eighth stage: FS</p> <p>Notes:</p> <ol style="list-style-type: none"> In the monitor mode, when SW1, SW2, or SWJ is turned on, the display shown above appears. The data set in the monitor mode can be changed during inverter operation. Data can be set in the function mode. When the mode is changed to the monitor mode, the set data is displayed.  <p>When the setting of a multi-stage speed is determined in advance, it is convenient to set it in the function mode. When a speed is set in the function mode, and then changed in the monitor mode, the data set in the function mode is also changed.</p>	<ul style="list-style-type: none"> When a multi-stage speed is set  <table border="1" data-bbox="894 999 1179 1115"> <thead> <tr> <th></th> <th>SW1</th> <th>SW2</th> </tr> </thead> <tbody> <tr> <td>First stage</td> <td>Close</td> <td>Open</td> </tr> <tr> <td>Second stage</td> <td>Open</td> <td>Close</td> </tr> <tr> <td>Third stage</td> <td>Close</td> <td>Close</td> </tr> </tbody> </table> <ul style="list-style-type: none"> When an extended multi-stage speed is set  <table border="1" data-bbox="894 1314 1243 1566"> <thead> <tr> <th></th> <th>SW1</th> <th>SW2</th> <th>SWJ</th> </tr> </thead> <tbody> <tr> <td>First stage</td> <td>Close</td> <td>Open</td> <td>Open</td> </tr> <tr> <td>Second stage</td> <td>Open</td> <td>Close</td> <td>Open</td> </tr> <tr> <td>Third stage</td> <td>Close</td> <td>Close</td> <td>Open</td> </tr> <tr> <td>Fourth stage</td> <td>Close</td> <td>Open</td> <td>Close</td> </tr> <tr> <td>Fifth stage</td> <td>Open</td> <td>Close</td> <td>Close</td> </tr> <tr> <td>Sixth stage</td> <td>Close</td> <td>Close</td> <td>Close</td> </tr> <tr> <td>Seventh stage</td> <td>Open</td> <td>Open</td> <td>Close</td> </tr> <tr> <td>Eighth stage</td> <td>Open</td> <td>Open</td> <td>Open</td> </tr> </tbody> </table> <p>See also the description of multi-stage speeds in the function mode (page 9-24, 25).</p>		SW1	SW2	First stage	Close	Open	Second stage	Open	Close	Third stage	Close	Close		SW1	SW2	SWJ	First stage	Close	Open	Open	Second stage	Open	Close	Open	Third stage	Close	Close	Open	Fourth stage	Close	Open	Close	Fifth stage	Open	Close	Close	Sixth stage	Close	Close	Close	Seventh stage	Open	Open	Close	Eighth stage	Open	Open	Open
	SW1	SW2																																																		
First stage	Close	Open																																																		
Second stage	Open	Close																																																		
Third stage	Close	Close																																																		
	SW1	SW2	SWJ																																																	
First stage	Close	Open	Open																																																	
Second stage	Open	Close	Open																																																	
Third stage	Close	Close	Open																																																	
Fourth stage	Close	Open	Close																																																	
Fifth stage	Open	Close	Close																																																	
Sixth stage	Close	Close	Close																																																	
Seventh stage	Open	Open	Close																																																	
Eighth stage	Open	Open	Open																																																	

Table 9-3 Monitor Mode Description (Continued)

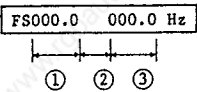



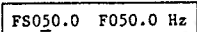

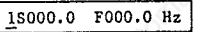
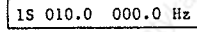
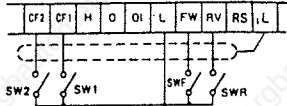
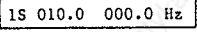
Display sequence	Monitor name	Key operation	Display	Description																														
3	Operation command	Data setting 	Initial display <div style="border: 1px solid black; padding: 2px; display: inline-block;">F/R-SW Terminal</div>	<p>Forward rotation command (FW)</p> <p>Reverse rotation command (RV)</p>    <p>Note:</p> <p>The motor can be stopped by turning the SWF or SWR switch off. It can also be stopped by turning the STOP key. To disable the motor from being stopped with the STOP key, operate switch 2 as described in page 9-34. Switch 2 is factory set to 0, i.e., the motor can be stopped by the STOP key. When the motor is stopped by the STOP key, be sure to turn the SWF or SWR switch off once. Otherwise, the motor cannot be restarted.</p>  <p>FW, RV, JG, CF1, CF2, RS, FRS L level ≤ 0.3 V H level ≥ 2.4 V Minimum input pulse width ≥ 50 ms</p>																														
		Mode selection 	<div style="border: 1px solid black; padding: 2px; display: inline-block;">F/R-SW Terminal</div> <div style="border: 1px solid black; padding: 2px; display: inline-block;">F/R-SW COM-EA</div>	<p>These keys are valid when F/R-SW is in Ope.-key mode.</p> <p>Forward rotation  Reverse rotation </p> <p>This is for PC communication mode. This mode can be displayed, but to use this mode, the optional device "HSCIM" is necessary.</p>																														
4	Motor speed display	Mode selection 	Initial display <div style="border: 1px solid black; padding: 2px; display: inline-block;">RPM 4P 00000rpm</div> 	<p>When the number of poles of the motor is set in the field indicated by ①, the synchronized motor speed is displayed in the field indicated by ②.</p> <p>. Motor pole selection table</p> <table border="1" style="width: 100%; text-align: center;"> <tr> <td>Display sequence</td> <td>1</td><td>2</td><td>3</td><td>4</td><td>5</td><td>6</td><td>7</td><td>8</td><td>9</td><td>10</td><td>11</td><td>12</td><td>13</td><td>14</td> </tr> <tr> <td>Number of poles</td> <td>2</td><td>4</td><td>6</td><td>8</td><td>10</td><td>12</td><td>14</td><td>16</td><td>18</td><td>20</td><td>24</td><td>32</td><td>36</td><td>48</td> </tr> </table>	Display sequence	1	2	3	4	5	6	7	8	9	10	11	12	13	14	Number of poles	2	4	6	8	10	12	14	16	18	20	24	32	36	48
		Display sequence	1		2	3	4	5	6	7	8	9	10	11	12	13	14																	
Number of poles	2	4	6	8	10	12	14	16	18	20	24	32	36	48																				
Data setting 	<div style="border: 1px solid black; padding: 2px; display: inline-block;">RPM 4P 01500rpm</div>																																	

Table 9-3 Monitor Mode Description (Continued)

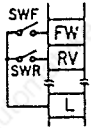
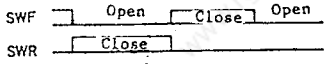
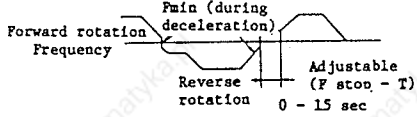
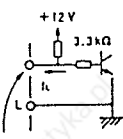

Display sequence	Monitor name	Key operation	Display	Description
2	Frequency setting command	Data setting 	Initial display 	 <p>VR0 2W: 500 Ω 1W: 1 or 2 kΩ</p> <p>Set a frequency in the following way:</p> <ol style="list-style-type: none"> When a variable resistor is used Insert a variable resistor (VR0) between terminals H, O and L on the printed circuit board. The input impedance is 30 kΩ. When an external signal is used <ul style="list-style-type: none"> Voltage setting Input impedance When the range 0 - 10 V is selected: 30 kΩ When the range 0 - 5 V is selected: 15 kΩ <p>Note: Do not apply a voltage of 12 VDC or more across terminals O and L.</p> <ul style="list-style-type: none"> Current setting Input impedance: 250 Ω <p>DIP switched</p>  <p>  10 (When the range 0 - 10 VDC is selected.)  10 (When the range 0 - 5 VDC is selected.) </p> <p>DIP switches can be found on the printed circuit board when the terminal cover is removed.</p>
		Mode selection 	 	<p>Select this mode to set a frequency with the Ope.-key on the digital operation panel.</p> <p>This is for PC communication mode. This mode can be displayed, but to use this mode, the optional device "COM-EA" is necessary.</p>

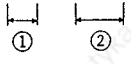
Table 9-3 Monitor Mode Description (Continued)

Display sequence	Monitor name	Key operation	Display	Description																																																											
5	Transformed frequency display	Mode selection MON ▲ ▼	Initial display /Hz00.0 00000.00 ① ②	Input a desired amount per Hz in the field indicated by ①. The field indicated by ② displays the output frequency multiplied by the data in field ①. ② = ① x Output frequency																																																											
		Data setting ▶ ▲ ▼	/Hz33.3 02000.00																																																												
6	Output current display	Mode selection MON ▲ ▼	Initial display If A Im 000.0% ① ②	When no rated current is input in the field indicated by ①, the field indicated by ② displays the ratio to the rated current of the inverter in percentage. When an inverter rated current listed below is input in field ①, field ② displays the rms (root-mean-square) value of the inverter output current.																																																											
		Data setting ▶ ▲ ▼	If 5.0A Im 004.5A																																																												
		-	If A Im 090.0%																																																												
		o Rated current codes of the inverter																																																													
			<table border="1"> <thead> <tr> <th>Display sequence</th> <th>1</th> <th>2</th> <th>3</th> <th>4</th> <th>5</th> <th>6</th> <th>7</th> <th>8</th> <th>9</th> <th>10</th> <th>11</th> <th>12</th> <th>13</th> <th>14</th> </tr> </thead> <tbody> <tr> <td>Inverter rated current</td> <td>3.0</td> <td>3.8</td> <td>5.0</td> <td>5.3</td> <td>7.5</td> <td>8.6</td> <td>10.5</td> <td>13.0</td> <td>16.0</td> <td>16.5</td> <td>23</td> <td>24</td> <td>32</td> <td>46</td> </tr> </tbody> </table> <table border="1"> <thead> <tr> <th>15</th> <th>16</th> <th>17</th> <th>18</th> <th>19</th> <th>20</th> <th>21</th> <th>22</th> <th>23</th> <th>24</th> <th>25</th> <th>26</th> <th>27</th> <th>28</th> <th>29</th> </tr> </thead> <tbody> <tr> <td>48</td> <td>58</td> <td>64</td> <td>75</td> <td>90</td> <td>95</td> <td>110</td> <td>121</td> <td>145</td> <td>149</td> <td>176</td> <td>182</td> <td>217</td> <td>220</td> <td>260</td> </tr> </tbody> </table>	Display sequence	1	2	3	4	5	6	7	8	9	10	11	12	13	14	Inverter rated current	3.0	3.8	5.0	5.3	7.5	8.6	10.5	13.0	16.0	16.5	23	24	32	46	15	16	17	18	19	20	21	22	23	24	25	26	27	28	29	48	58	64	75	90	95	110	121	145	149	176	182	217	220	260
Display sequence	1	2	3	4	5	6	7	8	9	10	11	12	13	14																																																	
Inverter rated current	3.0	3.8	5.0	5.3	7.5	8.6	10.5	13.0	16.0	16.5	23	24	32	46																																																	
15	16	17	18	19	20	21	22	23	24	25	26	27	28	29																																																	
48	58	64	75	90	95	110	121	145	149	176	182	217	220	260																																																	
7	Manual torque boost adjustment	Mode selection MON ▲ ▼	Initial display V-Boost Code <31>	<p>Increase the output voltage at start or in the low frequency area for boost adjustment.</p> <p style="text-align: center;">fk: Base frequency</p> <p>(Note that a larger boost value increases the current, making the inverter to be prone to cause an overcurrent trip.)</p>																																																											
		Data setting ▶ ▲ ▼	V-Boost Code <99>																																																												

Table 9-3 Monitor Mode Description (Continued)

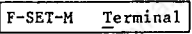
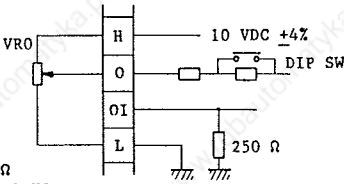
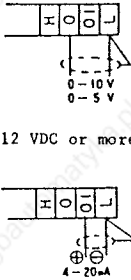
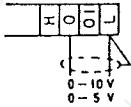
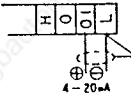
Display sequence	Monitor name	Key operation	Display	Description
8	Output voltage gain adjustment	Mode selection MON ▲ ▼	Initial display V-Gain 100%	Gain for the output voltage frequency is changed. Output voltage Output voltage (%) (%) 1 ... 50 Output 1 ... 50 ... 144 Output 1 ... 60 frequency 1 ... 60 ... 144 frequency 1 ... 87 (Hz) 1 ... 87 ... 144 (Hz) 1 ... 104 1 ... 104 ... 144
		Data setting ▶ ▲ ▼	V-Gain 0 50%	
9	Jogging frequency setting	Mode selection MON ▲ ▼	Initial display Jogging 00.5Hz	<ul style="list-style-type: none"> Set a jogging frequency. Since direct operation of jogging is likely to cause a trip, set a frequency of 5 Hz or less as much as possible. When the switch is turned off, the motor enters the free run state. <ul style="list-style-type: none"> Jogging operation when operation is commanded from the outside. F/R-SW should be in terminal mode. <ul style="list-style-type: none"> To provide an operation command from the digital operation panel, operate the FWD RUN or REV RUN key instead of the SWF switch. F/R-SW should be in Ope.-key mode. <p>Note 1: Jogging operation is not possible in the following cases:</p> <ol style="list-style-type: none"> JG is selected as an extended multi-stage speed. A frequency other than for jogging operation is set. Terminal input, CF1, or CF2, for a multi-stage speed is turned on. The set minimum frequency (Fmin) is greater than the jogging frequency. <p>Note 2: The optional remote operator and copy unit cannot perform jogging. (The input is rejected and normal operation is performed.)</p>
		Data setting ▶ ▲ ▼	Jogging 05.0Hz	

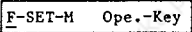
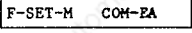
Table 9-3 Monitor Mode Description (Continued)

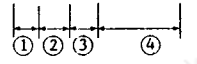
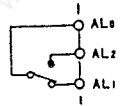
Display sequence	Monitor name	Key operation	Display	Description																
10	Fault display	<p>Mode selection</p> <p>MON</p> <p>▲ ▼</p> <hr/> <p>To display nature of a fault</p> <p>▶</p>	<p>During normal operation</p> <p>#1, 2, 3</p> <p>#1, 2, 3 Over. L</p>  <p>① ② ③ ④</p> <p>When a fault occurs, its fault message is displayed and the fault alarm relay is turned on. The relay contact state and electrical specifications are the following:</p>  <p>Contact specifications:</p> <p>Rating: Maximum 250 VAC, 2.5 A (resistive load) 0.2 A (cosφ=0.4) 30 VDC, 3.0 A (resistive load) 0.7 A (cosφ=0.4)</p> <p>Minimum 100 VAC, 10 mA 5 VDC, 100 mA</p>	<ul style="list-style-type: none"> For nature of fault, see page 43 - 46. The numbers 1 to 3 indicate a fault history. <ul style="list-style-type: none"> ①: Most recent fault ②: Previous fault ③: Fault before the previous one ④: Nature of the fault corresponding to the field at which the cursor is positioned is displayed. <p>(The example on the left indicates that the most recent fault is Over. L.)</p> <table border="1" data-bbox="860 703 1242 913"> <thead> <tr> <th>Power supply</th> <th>Operation status</th> <th>ALO-AL1</th> <th>ALO-AL2</th> </tr> </thead> <tbody> <tr> <td>ON</td> <td>In normal condition</td> <td>Close</td> <td>Open</td> </tr> <tr> <td>ON</td> <td>In abnormal condition</td> <td>Open</td> <td>Close</td> </tr> <tr> <td>OFF</td> <td>N/A</td> <td>Open</td> <td>Close</td> </tr> </tbody> </table>	Power supply	Operation status	ALO-AL1	ALO-AL2	ON	In normal condition	Close	Open	ON	In abnormal condition	Open	Close	OFF	N/A	Open	Close
Power supply	Operation status	ALO-AL1	ALO-AL2																	
ON	In normal condition	Close	Open																	
ON	In abnormal condition	Open	Close																	
OFF	N/A	Open	Close																	

9.4 Function Mode

(1) Function mode list

In function mode 1, a function name is selected but data can be neither set nor changed. In function mode 2, data is set or changed.

The table below indicates the initial display, original standard setting, and the range in which data can be set or changed for each function.

Table 9-4

Display sequence	Function name	Function 1 mode	Display	Function 2 mode	Initial display	Original setting	Setting/changing range	Remarks
1	V/F pattern setting	F-00	V F 1 - V C	V F 1 - V C	0 5 0 - 0 5 0	Same as left	See page 9-19	
2	Acceleration time setting	F-01	A C C E L - 1	A C C E L - 1	0 0 2 0 . 0 S	20	0.1~2999.9(S)	
3	Deceleration time setting	F-02	D E C E L - 1	D E C E L - 1	0 0 2 0 . 0 S	20	0.1~2999.9(S)	
4	Maximum frequency adjustment	F-03	+ F m a x	+ F m a x	0 0 0 . 0 H Z	0	0~15(Hz)	
5	Start frequency adjustment	F-04	F m i n	F m i n	0 0 0 . 5 H Z	0.5	0.5~5.0(Hz)	
6	Upper frequency limit setting	F-05	H - L I M - F	H - L I M - F	0 0 0 . 0 H Z	0	0~375(Hz)	Effective up to the maximum frequency of the selected V/F pattern.
7	Lower frequency limit setting	F-06	L - L I M - F	L - L I M - F	0 0 0 . 0 H Z	0	0~375(Hz)	
8	Jump frequency 1 setting	F-07	J U M P - F 1	J U M P - F 1	0 0 0 . 0 H Z	0	0~375(Hz)	Effective up to the maximum frequency of the selected V/F pattern.
9	Jump frequency 2 setting	F-08	J U M P - F 2	J U M P - F 2	0 0 0 . 0 H Z	0	0~375(Hz)	
10	Jump frequency 3 setting	F-09	J U M P - F 3	J U M P - F 3	0 0 0 . 0 H Z	0	0~375(Hz)	
11	Carrier frequency adjustment	F-10	C F - c o d e	C F - c o d e	U	U	0~U	
12	Adjustment of frequency stop time at start	F-11	F s t o p - T	F s t o p - T	0 0 0 . 0 S	0	0~15(S)	
13	Multi-stage speed 1 setting	F-12	S p e e d - 1	S p e e d - 1	0 0 0 . 0 H Z	0	0~375(Hz)	Effective up to the maximum frequency selected by the V/F pattern
14	Multi-stage speed 2 setting	F-13	S p e e d - 2	S p e e d - 2	0 0 0 . 0 H Z	0	0~375(Hz)	
15	Multi-stage speed 3 setting	F-14	S p e e d - 3	S p e e d - 3	0 0 0 . 0 H Z	0	0~375(Hz)	
16	Multi-stage speed 4 setting	F-15	S p e e d - 4	S p e e d - 4	0 0 0 . 0 H Z	0	0~375(Hz)	
17	Multi-stage speed 5 setting	F-16	S p e e d - 5	S p e e d - 5	0 0 0 . 0 H Z	0	0~375(Hz)	
18	Multi-stage speed 6 setting	F-17	S p e e d - 6	S p e e d - 6	0 0 0 . 0 H Z	0	0~375(Hz)	
19	Two-stage acceleration time setting	F-18	A C C E L - 2	A C C E L - 2	0 0 2 0 . 0 S	20	0.1~2999.9(S)	
20	Two-stage deceleration time setting	F-19	D E C E L - 2	D E C E L - 2	0 0 2 0 . 0 S	20	0.1~2999.9(S)	
21	DC braking frequency adjustment	F-20	F - D C B	F - D C B	0 0 1 . 0 H Z	1.0	0.5~375(Hz)	
22	DC braking power adjustment	F-21	V - D C B	V - D C B	0 1 0	10	00~20	
23	DC braking time adjustment	F-22	T - D C B	T - D C B	0 0 5 . 0 S	5.0	00~600(S)	
24	Electronic thermal level adjustment	F-23	E - t h e r m	E - t h e r m	1 0 0 %	100	100~50(%)	
25	Linear/S-curved acceleration selection	F-24	A C C l i n e	A C C l i n e	L i n e a r	Linear	Linear or S curve	
26	Linear/S-curved deceleration selection	F-25	D E C l i n e	D E C l i n e	L i n e a r	Linear	Linear or S curve	
27	Start point frequency of external frequency setting	F-26	F - S T A R T	F - S T A R T	0 0 0 . 0 H Z	0	0~375(Hz)	
28	End point frequency of external frequency setting	F-27	F - E N D	F - E N D	0 0 0 . 0 H Z	0	0~375(Hz)	
29	Switch 1 selection	F-28	S W I T C H 1	S W I T C H 1	0 0 0 0 0 1 0 1	Same as left		
30	Switch 2 selection	F-29	S W I T C H 2	S W I T C H 2	0 0 1 1 1 0 0 0	Same as left		
31	Overload limit constant setting	F-30	L H . C O N S	L H . C O N S	0 0 0 1 . 0	1.0	0.3~30	
32	Overload warning level adjustment	F-31	OL alarm	OL alarm	100%	100	50~150%	Effective with option board
33	Automatic torque boost adjustment	F-32	V - a u t o	V - a u t o	+ 0 0	00	00~20	
34	Allowable momentary power failure time setting	F-33	I P S - T	I P S - T	0 0 0 . 3 S	0.3 (1.0)	0.3~15.0(S)	0.3: For 200 V class 1.0: For 400 V class
35	Switch 3 selection	F-34	switch 3	Switch 3	0 0 0 0 0 0 0 0	Same as left		
36	Communication mode selection	F-35	PARMSET	PARMSET	I N V E R T E R	I N V E R T E R	Inverter COM-EA	For PC communication
37	Standby time setting for restart after momentary power failure	F-36	I P S - R - T	I P S - R - T	0 0 0 1 . 0 S	1	0.3~100(S)	
38	DC braking waiting time adjustment	F-37	W - T - D C B	W - T - D C B	0 0 0 0 . 0 S	0.0	0~5S	
39	Arbitrary frequency setting for reached-speed signal	F-39	S P D - A R V	S P D - A R V	0 0 0 . 0 H Z	0	0.5~375(Hz)	

(2) Procedures in the function mode

1) In the function mode, set or change data while the inverter is stopped.

(Data can be neither set nor changed during inverter operation.)

Under the following condition, however, data can be neither set nor changed even when the inverter is stopped.

a) The inverter is stopped by connecting control circuit terminal RS and L on the Printed circuit board.

b) The inverter is stopped by a trip.

2) Upon completion of data setting or change, be sure to press the key.

(Otherwise, the data is not entered and the old data remains stored.)

3) In the function mode, the motor cannot be started. To start the motor, press the key to return to the monitor mode.

(During operation, the function mode can be referenced.)

Table 9-5 Changing Function Mode Screens

















Key operation		Press the FUN key once.	
Press the FUN key to switch from the monitor mode to the function mode.		Function mode 1 display	Function mode 2 display
To proceed to the next function code	To return to the previous function code	(Function item display)	(Function item data display and screen change)
    	    	<div style="border: 1px solid black; padding: 2px; margin-bottom: 5px;">F-00 VF1-VC</div> <div style="border: 1px solid black; padding: 2px; margin-bottom: 5px;">F-01 ACCEL-1</div> <div style="border: 1px solid black; padding: 2px; margin-bottom: 5px;">F-02 DECEL-1</div> <div style="border: 1px solid black; padding: 2px; margin-bottom: 5px;">F-39 SPD-ARV</div> <div style="border: 1px solid black; padding: 2px; margin-bottom: 5px;">F-00 VF1-VC</div> <p style="font-size: small;">* When the last display is reached, the first display is given again.</p>	<div style="border: 1px solid black; padding: 2px; margin-bottom: 5px;">VF1-VC 050-050</div> <div style="border: 1px solid black; padding: 2px; margin-bottom: 5px;">ACCEL-1 0020.0S</div> <div style="border: 1px solid black; padding: 2px; margin-bottom: 5px;">DECEL-1 0020.0S</div> <div style="border: 1px solid black; padding: 2px; margin-bottom: 5px;">SPD-ARV 000.0Hz</div> <div style="border: 1px solid black; padding: 2px; margin-bottom: 5px;">VF1-VC 050-050</div> <p style="font-size: small;">* When the last display is reached, the first display is given again.</p>

Table 9-6 Cursor Movement and Data Change

Key operation	Display
 Press the key once.	ACCEL-1 0020.0S
 Press the key once.	ACCEL-1 0020.0S
 Press the key twice.	ACCEL-1 * 1020.0S Note 1
 Press the key once.	ACCEL-1 * 1020.0S
Press the STR key once.	ACCEL-1 * 1010.0S Note 2
	ACCEL-1 1010.0S

Note 1: When the  or  key is held down, the data is incremented or decremented up to the limit.

Note 2: In function mode 1, data can be neither set nor changed. (The cursor stays at the leftmost position.)

4) Sample of data change

To change the V/F pattern frequency from 50 Hz to 60 Hz

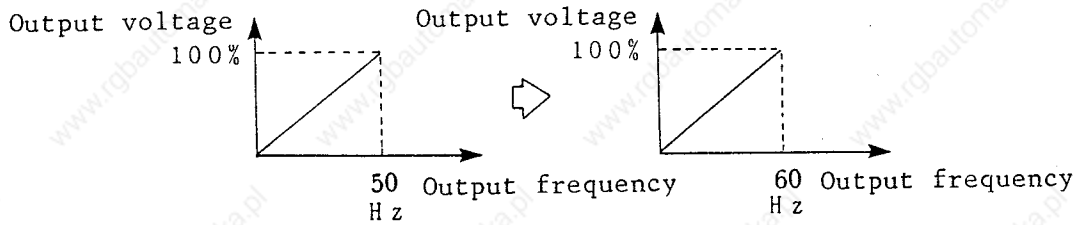

Table 9-7 Data Change Procedure







Operation step	Key operation	Display	Description
1	[FUN]	<u>F</u> -00 VF1-VC	Function mode 1 and the V/F pattern mode are selected.
2	[FUN]	<u>VF</u> 1-VC 050-050	Function mode 2 is selected.
3	▶	<u>VF</u> <u>1</u> -VC 050-050	To move the cursor to the letter 1, press the ▶ key once.
4	▲	<u>VF</u> <u>3</u> -VC * 060-060	To set 3, press the ▲ key two times or hold down it until 3 appears once.
5	[STR]	<u>VF</u> <u>3</u> -VC 060-060	To store the new data, press the [STR] key. When it is stored, the asterisk (*) disappears.

Note: If a reset signal is input at power off, the set or new data after change is not stored. Do not input a reset signal at power off after data is set or changed.

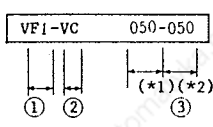
(3) Display and setting in the function mode

Data can be changed at the cursor position in the data set field.

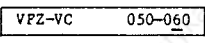
Table 9-8 Description of Function Mode

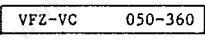
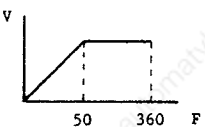
Display sequence	Function code and function name	Key operation	Display	Description	
1	(F-00) V/F pattern setting	See table 9-9	Initial setting  <p>When the value in the field indicated by ① is from 1 to 8, the predetermined value is automatically set in the field indicated by ③. When the value in field ① is Z, the set value is displayed.</p> <p>(*1) Base frequency (*2) Maximum output frequency</p>	Of 36 V/F patterns, one is selected according to a combination of the data in field ① (output frequency range specification) and the data in field ② (torque characteristic specification).	
			Data setting ① 		Setting in field ② VC: Constant torque ($V = kF$) VP1: Reduced torque ($V = kF^{1.5}$) VP2: Reduced torque ($V = kF^{1.7}$) VP3: Reduced torque ($V = kF^2$) When Z is set in field ①, the cursor can move to field ③, enabling a base frequency and a maximum frequency to be set in field ③ in the following ranges. (Note 2) Setting ranges of a base frequency and maximum output frequency when Z is set in field ① Base frequency: 30 - 240 Maximum output frequency: 30 - 360
			Data setting ② 		However, the base frequency must be smaller than or equal to the maximum output frequency.
Data setting ③ 	 Adjusted the following  <p>Note: Data setting ③ is effective only when Z is set in data setting ①.</p>	Note 1: When the base frequency exceeds 60 Hz, use a special motor rather than a general-purpose motor. Therefore, the maximum applicable motor differs. Usually, when the rated power (kW) of a special motor is the same as that of a general-purpose motor, the capacity of the inverter must be increased. Note 2: To set the V/F pattern to Z, set 0 in field ① of F-28 (see page 9-32). (Interlock when a high frequency is selected) Note 3: When selecting a high frequency, sufficiently consider the mechanical strengths of the motor and load.			

V/F patterns

Table 9-9 V/F Patterns

① \ ②	VC	VP 1	VP 2	VP 3
1				
2				
3				
4				
5				
6				
7				
8				
Z				

Standard V/F pattern

Normally, setting is not possible. (see page 9-19.)

$a = 30 - 240$
 $b = 30 - 360$
 $a \leq b$

Note: Original standard setting is the leftmost of top.

Table 9-8 Description of Function Mode (Continued)



Display sequence	Function code and function name	Key operation	Display	Description						
2	(F-01) Acceleration time setting		Initial setting (20 s) ACCEL-1 00.0 S	<p>Acceleration time: Time to start the motor and reach to the maximum frequency corresponding to the selected V/F pattern</p> <p>Deceleration time: Time required to stop the motor running at the maximum frequency corresponding to the selected V/F pattern</p> <p>The inverter can change the acceleration speed and deceleration speed of the motor at two stages separately during acceleration or deceleration as indicated in the table below.</p>						
		Data setting 	ACCEL-1 0150.0 S							
3	(F-02) Deceleration time setting		Initial setting (20 s) DECEL-1 0 0 2 0.0 S	<p>The motor can be started or stopped without shock. During acceleration or deceleration, a high speed or a low speed can be set.</p> <p>Second acceleration time: F-18</p> <p>Second deceleration time: F-19</p>						
		Data setting 	DECEL-1 0100.0 S							
<table border="1" style="margin-left: auto; margin-right: auto;"> <tr> <td>2CH-L</td> <td></td> </tr> <tr> <td>Open</td> <td>Value set by ACCEL-1 or DECEL-1</td> </tr> <tr> <td>Connected</td> <td>Value set by ACCEL-2 or DECEL-2</td> </tr> </table> <p>Input circuit</p>  <p>Low level ≤ 0.3 V High level ≥ 2.4 V Minimum input pulse width FW, RV, 2CH ≥ 50 ms IL $\frac{1}{2}$ 3.5 mA</p> 					2CH-L		Open	Value set by ACCEL-1 or DECEL-1	Connected	Value set by ACCEL-2 or DECEL-2
2CH-L										
Open	Value set by ACCEL-1 or DECEL-1									
Connected	Value set by ACCEL-2 or DECEL-2									
<p>Sample combination of ACCEL1 and ACCEL2</p> <p>In this example, ACCEL1 is set to 60 s and ACCEL 2 to 30 s.</p> <p>o ACCEL-1 = 60 s</p>  <p>ACCEL-1 = 60 s</p> <p>o ACCEL-2 = 30 s</p>  <p>ACCEL-2 = 30 s</p> <p>Ⓐ When the switch is closed 30 s later</p>  <p>Ⓑ When the switch is closed 40 s later</p> 										

Table 9-8 Description of Function Mode (Continued)

Display sequence	Function code and function name	Key operation	Display	Description
4	(F-03) Maximum frequency adjustment	Data setting ▶ ▲ ▼ STR	Initial setting (0 Hz) +Fmax. 000.0 Hz	The maximum frequency is increased. (The acceleration/deceleration time is prolonged.) The adjustment is made within the range of constant output characteristics. 
			+Fmax. 015.0 Hz	
5	(F-04) Starting frequency adjustment	Data setting ▶ ▲ ▼ STR	Initial setting (0.5 Hz) Fmin. 00.5 Hz	The starting frequency is adjusted. (Increasing the starting frequency shortens the acceleration/deceleration time.) 
			Fmin. 05.0 Hz	
6 7	(F-05) (F-06) Upper frequency limit setting Lower frequency limit setting	Data setting ▶ ▲ ▼ STR	Initial setting of the upper frequency limit (0 Hz) H-LIM-F 000.0 Hz	The upper and lower frequency limits can be set separately in the following ranges: Upper limit: From the minimum frequency to the maximum frequency, 0.1 Hz steps. Lower limit: From the minimum frequency to the maximum frequency, 0.1 Hz steps. [Sample setting]  Note: The adjustable range must be set under the following condition: 0 Hz or Upper limit ≥ Lower limit When 0 Hz is set, the limiters do not operate.
	Initial setting of the lower frequency limit (0 Hz) L-LIM-F 000.0 Hz		L-LIM-F 020.0 Hz	

Table 9-8 Description of Function Mode (Continued)

Display sequence	Function code and function name	Key operation	Display	Description
8 9 10	(F-07) (F-08) (F-09) Jump frequency 1 setting Jump frequency 2 setting Jump frequency 3 setting	 Data setting ▶ ▲ ▼ STR	Initial setting (0 Hz) JUMP-F1 000.0 Hz JUMP-F2 000.0 Hz JUMP-F3 000.0 Hz JUMP-F1 010.0 Hz JUMP-F2 030.0 Hz JUMP-F3 045.0 Hz	To avoid resonance with the load, up to three jump frequencies can be set. The setting sequence is at freely. Output frequency (Hz) Jump frequency setting point Frequency reference signal During deceleration Note: A jump frequency makes the setting of a frequency in the range of the set frequency ± 0.3 Hz impossible. When a frequency passes the jump area, it is output.
11	(F-10) Motor noise adjustment	Data setting ▶ ▲ ▼ STR	Initial setting CF-code <U> CF-code <C>	The inverter carrier frequency is varied, making it possible to change the motor sound quality. C D E --- N --- U Low carrier frequency ← → High carrier frequency
12	(F-11) Adjustment of frequency stop time at start	Data setting ▶ ▲ ▼ STR	Initial setting (0.0 s) Fstop-T 000.0 S Fstop-T 015.0 S	To prevent motor overcurrent at start, output frequency increasing is temporarily stopped. Frequency command Stop time 0 - 15 s Time The stop frequency is about one-twelfth of the base frequency or the minimum frequency, whichever is higher. (This function is invalidated when S curve acceleration or deceleration is selected.)

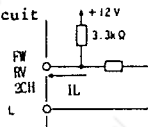
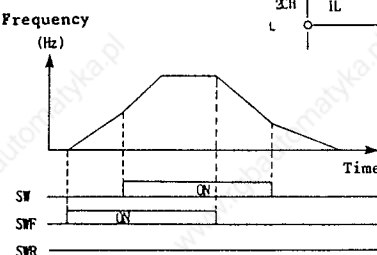
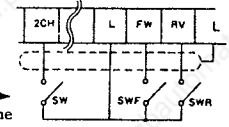
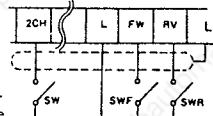
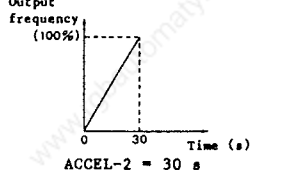
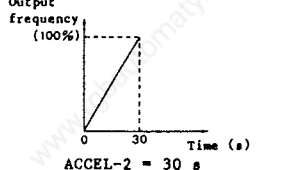
Table 9-8 Description of Function Mode (Continued).

Display sequence	Function code and function name	Key operation	Display	Description
13 14 15 16 17 18	(F-12) (F-13) (F-14) (F-15) (F-16) (F-17) Multi-stage speed 1 setting to multi-stage speed 3 setting		Initial setting (0 Hz) Speed-1 000.0 Hz Speed-2 000.0 Hz Speed-3 000.0 Hz Speed-4 000.0 Hz Speed-5 000.0 Hz Speed-6 000.0 Hz	<p>1) When the jogging/extended multi-stage speed selection flag in field ② of switch 2 of (F-29) is set to the jogging mode (0: standard setting), the motor can be run at up to four staged by a combination of a frequency command from the digital operation panel or outside and speed-1 to speed-3 settings. See page 9-8.</p>  <p>VRO (Setting: FS)</p> 
	Data setting <input type="button" value="▶"/> <input type="button" value="▲"/> <input type="button" value="▼"/> <input type="button" value="STR"/>	Speed-1 010.0 Hz Speed-2 020.0 Hz Speed-3 030.0 Hz Speed-4 025.0 Hz Speed-5 060.0 Hz Speed-6 040.0 Hz		

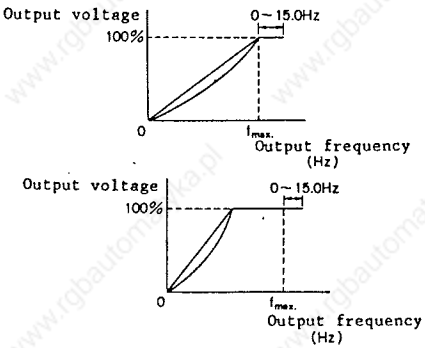
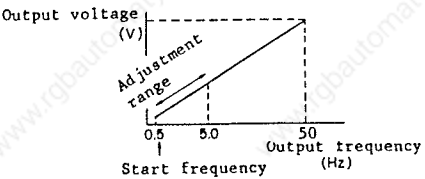
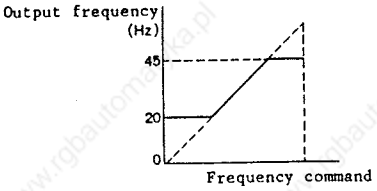
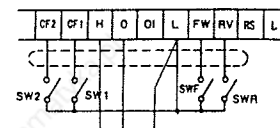
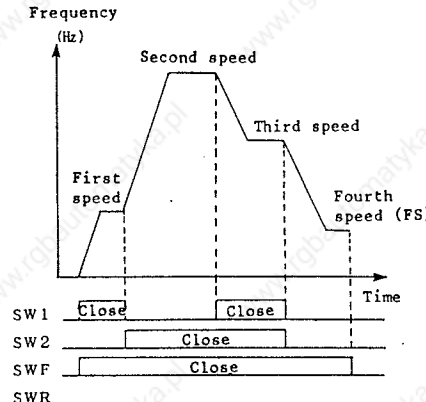
Switch		Set frequency (Hz)
SW1	SW2	
-	-	Frequency command from the Ope.-key or terminal mode
Close	Open	Value preset by speed-1 (1S)
Open	Close	Value preset by speed-2 (2S)
Close	Close	Value preset by speed-3 (3S)

Table 9-8 Description of Function Mode (Continued)

Display sequence	Function code and function name	Key operation	Display	Description																																	
				<p>2) When the jogging/extended multi-stage speed selection flag in field ② of switch 2 of (F-29) is set to the extended multi-stage speed, the motor can be run at up to eight stages by a combination of a frequency command from the digital operation panel or outside and speed-1 to speed-6 settings.</p> <p>Note: When the multi-stage speed mode is selected, jogging operation is not possible. (If operation is performed at a jogging frequency, jogging is not performed but the motor runs according to the set acceleration and deceleration times.)</p>																																	
			<table border="1"> <thead> <tr> <th colspan="3">Switch</th> <th rowspan="2">Set frequency (Hz)</th> </tr> <tr> <th>SW1</th> <th>SW2</th> <th>SWJ</th> </tr> </thead> <tbody> <tr> <td>—</td> <td>—</td> <td rowspan="4">Open</td> <td>Frequency command issued in the Op. key or terminal mode</td> </tr> <tr> <td>Close</td> <td>Open</td> <td>Value set by speed-1 (1S)</td> </tr> <tr> <td>Open</td> <td>Close</td> <td>Value set by speed-2 (2S)</td> </tr> <tr> <td>Close</td> <td>Close</td> <td>Value set by speed-3 (3S)</td> </tr> <tr> <td>Close</td> <td>Open</td> <td rowspan="4">Close</td> <td>Value set by speed-4 (4S)</td> </tr> <tr> <td>Open</td> <td>Close</td> <td>Value set by speed-5 (5S)</td> </tr> <tr> <td>Close</td> <td>Close</td> <td>Value set by speed-6 (6S)</td> </tr> <tr> <td>Open</td> <td>Open</td> <td>Value set by jogging (JG)</td> </tr> </tbody> </table>	Switch			Set frequency (Hz)	SW1	SW2	SWJ	—	—	Open	Frequency command issued in the Op. key or terminal mode	Close	Open	Value set by speed-1 (1S)	Open	Close	Value set by speed-2 (2S)	Close	Close	Value set by speed-3 (3S)	Close	Open	Close	Value set by speed-4 (4S)	Open	Close	Value set by speed-5 (5S)	Close	Close	Value set by speed-6 (6S)	Open	Open	Value set by jogging (JG)	<p>In the above example, FS is set in the terminal mode.</p> <p>Jogging in the monitor mode</p>
Switch			Set frequency (Hz)																																		
SW1	SW2	SWJ																																			
—	—	Open	Frequency command issued in the Op. key or terminal mode																																		
Close	Open		Value set by speed-1 (1S)																																		
Open	Close		Value set by speed-2 (2S)																																		
Close	Close		Value set by speed-3 (3S)																																		
Close	Open	Close	Value set by speed-4 (4S)																																		
Open	Close		Value set by speed-5 (5S)																																		
Close	Close		Value set by speed-6 (6S)																																		
Open	Open		Value set by jogging (JG)																																		
19 20	(F-18) (F-19) Two-stage acceleration time setting and two-stage deceleration time setting	Data setting ▶ ▲ ▼ STR	<p>Initial setting (20 s)</p> <p>ACCEL-2 0020.0 S</p> <p>DECEL-2 0020.0 S</p> <hr/> <p>ACCEL-2 0100.0 S</p> <p>DECEL-2 0150.0 S</p>	See page 9-21.																																	

Table 9-8 Description of Function Mode (Continued)

Display sequence	Function code and function name	Key operation	Display	Description
21	(F-20) DC braking frequency adjustment		Initial setting (1.0 Hz) F-DCB 001.0 Hz	<p>When selecting DC braking, set a performing frequency for DC braking at deceleration.</p> <p>When F-DCB is set, the motor operates at the set frequency or below during deceleration if:</p> <ol style="list-style-type: none"> Both (F-21) V-DCB and (F-22) T-DCB are set. Field ② of (F-28) is set to ① (with DC braking). See page 9-32. A stop command is already input or the set frequency is 0 Hz. <p>If none of the above conditions is met, the motor can operate up to the minimum frequency.</p> <p>See page 9-32: Field ② of F-28. See page 9-34: Field ① of F-29.</p>
		Data setting ▶ ▲ ▼ STR	F-DCB 015.0 Hz	
22	(F-21) DC braking power adjustment		Initial setting (10) V-DCB 010	<p>The DC braking power is varied. When 000 is set, DC braking operation is disabled.</p>
		Data setting ▶ ▲ ▼ STR	V-DCB 020	
23	(F-22) DC braking time adjustment		Initial setting (5 s) T-DCB 000.0 S	<p>The DC braking time is adjusted. When 00.0 s is set, DC braking operation is disabled.</p> <p>See page 9-34: Field ① of F-29.</p> <div style="text-align: center;"> </div> <div style="border: 1px solid black; padding: 5px; margin-top: 10px;"> <p>* Since long or continuous DC braking may cause burning of motor, set the braking time as short as possible.</p> </div>
		Data setting ▶ ▲ ▶ STR	T-DCB 600.0 S	
24	(F-23) Electronic thermal level adjustment		Initial setting (100 %) E-therm 100%	<p>The electronic thermal level can be changed between 50% and 100%. Set a level to conform to the optimum current value of the motor. When operating the motor continuously at 10 Hz or below, use a thermal relay.</p> <div style="text-align: center;"> </div> <p style="text-align: center;"> $\text{adjusted level} = \frac{\text{Motor rated current}}{\text{Inverter rated current}} \times 100 (\%)$ </p>
		Data setting ▶ ▲ ▼ STR	E-therm 050%	

Table 9-8 Description of Function Mode (Continued)

Display sequence	Function code and function name	Key operation	Display	Description
25	(F-24) Linear/ S-curved acceleration selection		Initial setting (linear) <u>AC</u> cline Linear	Select linear accelerator (Linear) or curved acceleration (S-curve).  Note: When s-curve is selected and a frequency reference signal is given from external, a signal fluctuation due to noise may result in an acceleration time longer than the set value by F-01.
		Data setting ▶ ▲ ▼ STR	ACcline <u>S</u> -Curve	
26	(F-25) Linear/ S-curved deceleration selection		Initial setting (linear) <u>DE</u> cline Linear	Select linear deceleration (Linear) or curved deceleration (S-curve). Note: When S-curve is selected and a frequency reference signal is given from external, a signal fluctuation due to noise may result in a deceleration time longer than the set value by F-02.
		Data setting ▶ ▲ ▼ STR	DEcline <u>S</u> -Curve	
27 28	(F-26) (F-27) External frequency setting start and external frequency setting end		Initial setting (0 Hz) of external frequency setting start (F-26) <u>F</u> -START 000.0 Hz	These are functions similar to a gain/bias adjustment for reference signal. The start and end output frequencies are set for analog frequency reference signal (0 - 10 VDC, 0 - 5 VDC, and 4 - 20 mA) issued from the outside to the inverter.  Note 1: The original factory setting is 0 Hz. Note 2: When changing the V/F pattern after the start frequency (F-START) and end frequency (F-END) are set, readjust these frequencies. Note 3: When F-START and F-END are set in such a way that the start frequency is higher than the end frequency or the frequency command is set at the minimum level (0 V or 4 mA), the output frequency may be 0.1 - 0.3 Hz lower than the frequency set by F-START. This is not an error because the reduction in frequency is due to noise on a signal line.
Data setting ▶ ▲ ▼ STR	<u>F</u> -START 020.0 Hz			
	Initial setting (0 Hz) of external frequency setting end (F-27) <u>F</u> -END 000.0 Hz			
Data setting ▶ ▲ ▼ STR	<u>F</u> -END 040.0 Hz			

Table 9-8 Description of Function Mode (Continued)





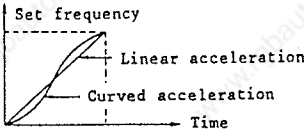
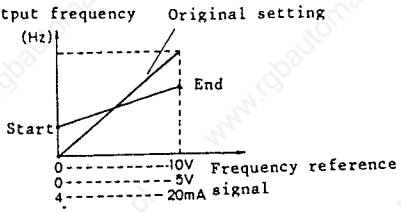

Display sequence	Function code and function name	Key operation	Display	Description
29	(F-28) Switch 1 selection		Initial setting (See below.) SWITCH1 0 0 0 0 0 1 0 1 	Fields ① to ⑥ are selectable areas. For details. See page 9-32 and 9-33. ① : Special V/F pattern (Z-pattern) selection ② : DC braking selection ③ : Frequency monitor selection ④ : Overload selection ⑤ : Automatic restart selection ⑥ : Selection of rotating direction
		Data setting  STR	SWITCH1 0 0 1 0 1 0 0 0	
30	(F-29) Switch 2 selection		Initial setting (See below.) SWITCH2 0 0 1 1 1 0 0 0 	Fields ① to ⑧ are selectable areas. For details, see page 9-34. ① : Selection of DC braking trigger ② : Jogging selection ③ : Selection of STOP key effectiveness ④ : Do not change. Factory-set to 1. ⑤ : Derating of electronic thermal characteristics. ⑥ : Strength change of manual v.boost. ⑦ : Selection of speed detection after reset (RS) release ⑧ : Selection of FS setting soft-lock
		Data setting  STR	SWITCH2 0 0 1 0 1 0 0 1	
31	(F-30) Overload limit constant setting		Initial setting (1.0) LM. CONS 0001.0	. Constant for overload limit characteristics. If an OC trip is likely to occur at the standard value, set a small value. . The overload limit level can be changed by variable resistor OL. LMT.  Counter-clockwise: 50% - 80% Center: 100% Clockwise: 150% The variable resistor is mounted at the lower left corner on the PC board. The level is measured, assuming that the rated current of the inverter is 100%. The standard setting is about 125%.
		Data setting  STR	LM. CONS 0000.5	

Table 9-8 Description of Function Mode (Continued)

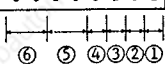
Display sequence	Function code and function name	Key operation	Display	Description
32	(F-31) Overload alarm level adjustment (optional)		Initial setting (100) OLalarm 100%	When the load reaches the level preset within the range 50% - 150% overload, an alarm is output. (Overload alarm signal relay output is possible when the optional PC board is used.) Optional board (S30P-PCB)
		Data setting ▶ ▲ ▼ STR	OLalarm 150%	
33	(F-32) Automatic torque boost adjustment		Initial setting (00) V-auto +00	Only during acceleration, boost is automatically applied. The boost can be adjusted in 20 steps. The voltage is increased about 10% at +20. Output voltage (%)  During automatic boosting, the original V/F is automatically used when a constant speed is reached after acceleration. (Continuous operation is not performed with the motor overexcited.) When manual torque boost is performed together, the voltage is further increased as indicated by the hatched area. See page 9-11. Output voltage (%)  Note: When the inverter load is too heavy, the control power supply is turned off earlier. Therefore, the inverter display may disappear before power restoration even if the power would be restored within the set allowable instantaneous failure time. When this happens, the power is turned off and the inverter operates in the same way as when it is reset.
		Data setting ▶ ▲ ▼ STR	V-auto +20	
34	(F-33) Allowable instantaneous power failure time setting		Initial setting (1.0 s) IPS-T 001.0 S	Set a time to restore the power after an instantaneous power failure. When field ⑤ of switch 1 is set to the retry function and the power is restored within the set time, the inverter restarts automatically. For the details, see paragraph 9.5. Note: When the inverter load is too heavy, the control power supply is turned off earlier. Therefore, the inverter display may disappear before power restoration even if the power would be restored within the set allowable instantaneous failure time. When this happens, the power is turned off and the inverter operates in the same way as when it is reset.
		Data setting ▶ ▲ ▼ STR	IPS-T 003.0 S	

Table 9-8 Description of Function Mode (Continued)

Display sequence	Function code and function name	Key operation	Display	Description
35	(F-34) Switch 3 selection		Initial setting below <div style="border: 1px solid black; padding: 2px; display: inline-block;">SWITCH 3 00000000</div> 	<p>Field ① and ② are selectable. The field ③ has no function and the cursor cannot move into ③.</p> <p>Field ①: Selection of speed detection after free run stop (FRS) release.</p> <p>0 - Motor speed detection is possible.</p> <p>1 - Inverter starts from the start (minimum) frequency.</p> <p>Field ②: Fault history releasing</p> <p>0 - Recorded fault history cannot be released.</p> <p>1 - Possible to release recorded fault history.</p> <p>Set "1" in the field 2 and push the reset button on the printed circuit board. See the fault display on page 9-5.</p>
		Data setting <input type="checkbox"/> <input type="checkbox"/> <input type="checkbox"/>	<div style="border: 1px solid black; padding: 2px; display: inline-block;">SWITCH 3 000000<u>1</u></div>	
36	(F-35)		Initial setting (Inverter) <div style="border: 1px solid black; padding: 2px; display: inline-block;">PARMSET INVERTER</div>	<p>Keep the setting in "INVERTER" when inverter is operated no serial communication interface module (COM-EA). This function is used for PC communication, and in the case of communicating with PC or PLC, change the setting in "COM-EA". "COM-EA" is optional device.</p>
		Data setting <input type="checkbox"/> <input type="checkbox"/> <input type="checkbox"/> <input type="checkbox"/> STR	<div style="border: 1px solid black; padding: 2px; display: inline-block;">PARMSET <u>COM-EA</u></div>	
37	(F-36) Standby time setting for restart after instantaneous power failure		Initial setting (1.0 s) <div style="border: 1px solid black; padding: 2px; display: inline-block;">IPS-R-T 0001.0 S</div>	<p>Set a standby time during which restart is awaited before the inverter is automatically restarted after power is restored from a instantaneous power failure within the allowable instantaneous failure time set by (F-33). For the details, see paragraph 9.5.</p> <p>Note:</p> <p>When the motor speed cannot be detected at restart of the motor, the speed detection is retried but the actual operation time is longer than the set time. If the speed cannot be detected after retry, the motor is started at the start frequency, assuming that the speed of the motor is zero.</p>
		Data setting <input type="checkbox"/> <input type="checkbox"/> <input type="checkbox"/> <input type="checkbox"/> STR	<div style="border: 1px solid black; padding: 2px; display: inline-block;">IPS-R-T 00<u>3</u>.0 S</div>	

Table 9-8 Description of Function Mode (Continued)

Display sequence	Function code and function name	Key operation	Display	Description
38	(F-37) DC braking wait time adjustment	Data setting <input type="checkbox"/> <input type="checkbox"/> <input type="checkbox"/> <input type="checkbox"/> STR	Initial setting (0.0) W-T-DCB 0000.0 W-T-DCB 0005.0	<p>This is for waiting time adjustment of DC braking. In the case of using this function, the DC braking will perform with delay time after reaching DC braking frequency or from being given a DB external signal.</p> <p>Use this function when use DC braking at the high speed and adjust the waiting time longer.</p>
39	(F-39) Frequency setting for reached-speed signal at freely	Data setting <input type="checkbox"/> <input type="checkbox"/> <input type="checkbox"/> <input type="checkbox"/> STR	Initial setting (0 Hz) SPD-ARV 000.0 Hz SPD-ARV 051.5 Hz	<p>Frequency arrival signal can be output at a desired frequency. The setting of 0 causes the signal to be output when the set frequency is reached.</p> <p>A: In case that no preset frequency is entered in SPD-ARV, the signal is turned on when the output frequency is reached to set value. (The signal is turned on at set frequency ± 0.5 Hz and off at set frequency ± 1.5 Hz.)</p> <p>B: In case that non-zero is entered in SPD-ARV, the signal is turned on when the output frequency is reached to preset value. (The signal is turned on and off at set frequency ± 0 Hz.)</p> <p>* The RUN signal indicating that operation is in progress is output during inverter operation.</p> <p>Transister specification Open collector output 27 V, 50 mA max.</p> <p>Forward voltage drop About 1 V</p>

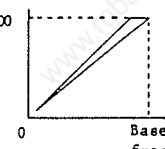
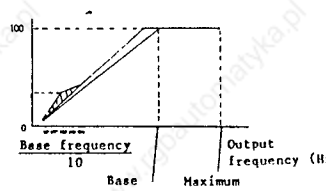
Table 9-8 Description of Function Mode (Continued)

		SWITCH1							
		00	00	0	1	0	1		
		⑥	⑤	④	③	②	①		
F-28	Switch 1	①	0	Special V/F	Set 0 when selecting a V/F pattern (Z pattern), see page 9-19				
			1	Standard V/F	Set 1 when selecting a V/F pattern (1 - 8), see page 9-20.				
		②	0	Without DC braking	See (F-20) to (F-22) on page 9-26, F-37 in page 9-30 and field 1 of F-29 on page 9-34.				
			1	With DC braking					
		③	0	Frequency digital monitoring	Digital monitoring for the frequency counter Pulse trains are output at the output frequency. The duty cycle is about 50%. 				
			1	Frequency analog monitoring	Monitoring for the analog meter This monitor outputs the duty cycle (t/T) proportional to the output frequency. Adjust the M. ADJ variable resistor and the variable resistor in the frequency meter so that the analog meter indicates its maximum value at the maximum frequency.   <p style="text-align: right;">(Load resistance: 10 - 22 kΩ 1 mA max 0 - 10 V full-scale)</p>				
		④	0	Overload limited	Overload limit function is enabled whenever and over the entire area.				
			1	Overload not limited	Overload limit function is not enabled during acceleration and is enabled during reacceleration after once accelerated.				
		⑤	00	Trip	Standard setting An alarm signal is output when an instantaneous power failure, undervoltage, or another trip occurs.				

Table 9-8 Description of Function Mode (Continued)

⑤	10	Restart function	<p>Automatic restart with synchronized start of spinning motor when one of the following trips occurs (however, when the frequency exceeds 50 Hz, restart out the start frequency):</p> <ul style="list-style-type: none"> . Overcurrent . Overvoltage . Undervoltage . Instantaneous power failure <p>The maximum number of restarts is 3 in 10 minutes (15 times within 10 minutes for undervoltage) except for instantaneous power failure.</p> <p>When an instantaneous power failure occurs, it takes a time by (F-36) IPS-R-T before operation is resumed.</p> <p>See paragraph 9.5 on page 9-35.</p>	
	11	Acceleration from zero speed	<p>Automatic restart after instantaneous power failure or undervoltage with acceleration from zero speed</p> <p>Performance is similar to an automatic restart but in the case of setting "11", inverter is restarted from zero speed after a time delay set by (F-36) ISP-R-T. No synchronized restart is performed. This is not effective to overcurrent trip and undervoltage trip.</p>	
	01	-	Do not set 01.	
	⑥	00 11	Forward/reverse rotation	The motor can run in both forward and reverse directions.
	01	Forward rotation	The motor can run only in the forward direction. No reverse rotation command can be accepted.	
	10	Reverse rotation	The motor can run only in the reverse direction. No forward rotation command can be accepted.	

Note: While the restart function is in effect, the motor is in the free-run state. When it is necessary to hold the motor in the free-run state through mechanical braking, therefore, do not use the restart function.

Table 9-8 Description of Function Mode (Continued)

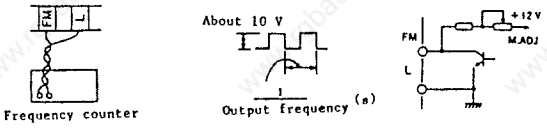
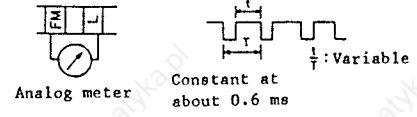
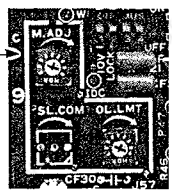
		SWITCH 2																									
		0	0	1	1	1	0	0	0																		
		⑧	⑦	⑥	⑤	④	③	②	①																		
F-29	Switch 2	①	0	Edge operation	Output frequency Operation command																						
		1	Level operation	Output frequency Operation command				Effective in the terminal mode	See F-20 to F-22																		
	②	0	Jogging mode	Set "0" for usual jogging operation. See jogging mode on page 9-12.																							
		1	Extended multi-speed mode	Set "1" for extended multi-stage speed setting when using JG terminal for this purpose. See F-12 to F-17 on page 9-25.																							
	③	0	STOP key enabled	When an operation command comes from the terminal, the STOP key on the digital operation panel (or optional remote operator) is enabled.																							
		1	STOP key disabled	When an operation command comes from the terminal, the STOP key on the digital operation panel (or optional remote terminal) is disabled.																							
	④	0	With no stability control	"0" setting has no stability control. Do not set in "0".																							
		1	With stability control	Set "1" for stabilized inverter operation.																							
	⑤	0	With derating on electronic thermal characteristics	<p>When 1 is set, electric thermal level has linear characteristics.</p> <p>When setting "0", the electronic thermal (F-23) has a derating to avoid motor overheat due to continuous operation at low speed.</p>																							
		1	With no derating on electronic thermal characteristics																								
	⑥	0	Low boost pattern					<table border="1"> <thead> <tr> <th rowspan="2">Output frequency</th> <th colspan="2">Output voltage (V)</th> </tr> <tr> <th>When 0 is set</th> <th>When 1 is set</th> </tr> </thead> <tbody> <tr> <td>f_k</td> <td>100</td> <td>100</td> </tr> <tr> <td>$f_k/2$</td> <td>50</td> <td>50</td> </tr> <tr> <td>$f_k/10$</td> <td>18</td> <td>21</td> </tr> <tr> <td>$f_k/15$</td> <td>14</td> <td>17</td> </tr> </tbody> </table>			Output frequency	Output voltage (V)		When 0 is set	When 1 is set	f_k	100	100	$f_k/2$	50	50	$f_k/10$	18	21	$f_k/15$	14	17
		Output frequency	Output voltage (V)																								
	When 0 is set		When 1 is set																								
	f_k	100	100																								
	$f_k/2$	50	50																								
	$f_k/10$	18	21																								
$f_k/15$	14	17																									
1	Standard boost pattern																										
⑦	0	Without speed detection after reset	After reset is released, the inverter restart with acceleration from zero speed. The inverter starts outputting about 0.3 s after reset is released.																								
	1	With speed detection after reset	After reset is released, the inverter restart according to motor speed if the motor is still running. When using restart function, set "1". See paragraph 9.5.																								
⑧	0	FS setting change inhibited	The FS setting cannot be changed when soft lock is applied (the LOCK DIP switch is set to ON).																								
	1	FS setting change allowed	The FS setting can be changed even soft lock is applied.																								

9.5 Automatic Restart Function

There are some different methods for restarting the inverter. This paragraph provides the explanation and differences between restart modes. Choose the suitable and proper method of restarting to your system.



WARNING: To avoid personal injury

Since the restart mode is selected, the motor is restarted at occurrence of a trip due to overcurrent, overvoltage, undervoltage and instantaneous power failure. When the inverter trip, no fault alarm signal is given and automatically restarts after a certain time. Do not use the automatic restart function, therefore, when it is necessary to hold the motor in free-run state through mechanical braking.

The following table shows the kinds of restart and functions in function mode to be set.

Table 9-10 Kind of Restart

Restart mode	F-28 switch 1 selection field ⑤ 00000101 <input type="checkbox"/> ⑤	F-29 switch 2 selection field ⑦ 00110000 <input type="checkbox"/> ⑦	Other functions in function mode to be set
Restart after instantaneous power failure or under voltage trip	10	1	F-33 (IPS-T) F-36 (IPS-R-T)
Restart after trop (OC, OV)	10	1	F-36 (IPS-R-T)
Restart from zero speed after power failure or under voltage trip	11	1	F-33 (IPS-T) F-36 (IPS-R-T)
Power source switching from commercial to inverter	10, 11, 00 Do not set in "01".	1	-

(1) Restart after instantaneous power failure, restart after trip

This is the function to restart the inverter automatically after instantaneous power failure. In the case of this restart mode, the inverter is restarted with synchronized speed, and possible to restart when the inverter trips due to overcurrent (OC), overvoltage (OV) and undervoltage (UV). The Figure 9-2 shows a time chart of performance when restart function after instantaneous power failure is performed.

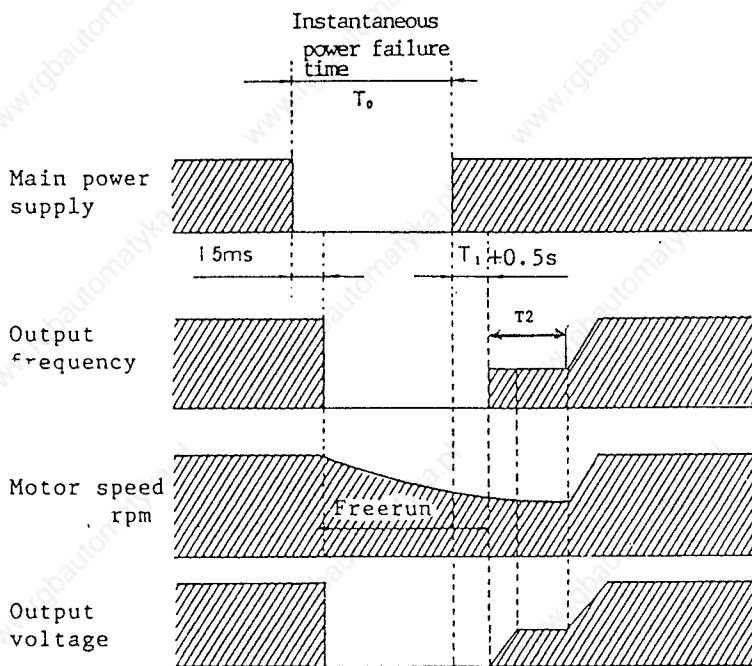

T_0 : Allowable power failure time set by F-33(ISP-T)
The power failure trip occurs when the power failure time is longer than T_0 .

T_1 : Restart stand-by time set by F-36(ISP-R-T)

T_2 : Reseaching time of motor free-run speed. T_2 is not fixed, it is changable and depends on timing and load condition.

Figure 9-2 Timing Chart of Synchronized Restart

Note: On the 400 V class inverter, the keeping time of control power supply of the control board depends on load condition. When power supply to the inverter is off with full (rated) load, it is approximately 0.3 second. When the longer power failure than 0.3 second occurs, the inverter may not be able to catch the motor speed when power comes again and may restart from zero speed.

(2) Restart from zero speed after failure

This is the function to restart the inverter from zero speed after power failure. In the case of this restart mode, the inverter is always restarted from zero speed.

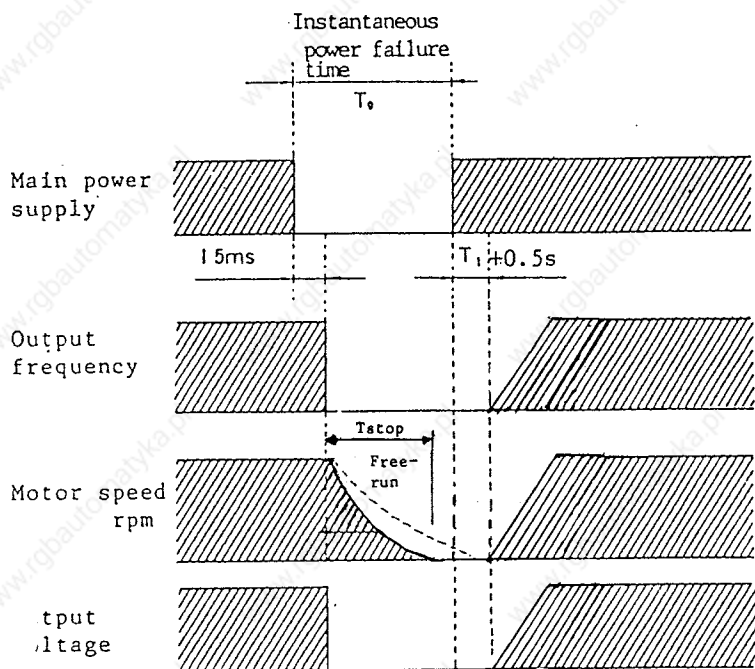

T_0 : Allowable power failure time set by F-33(IPS-T)
The power failure trip occurs when the power failure time is longer than T_0 .

T_1 : Restart stand-by time set by F-36(IPS-R-T)
when T_1 is over, the inverter is restarted from zero speed.

Figure 9-3 Restart Timing from Zero Speed

Note: When the inverter restarts from zero speed, the motor must be already stopped.

- (3) Power source switching from commercial power supply to inverter when switches the power source with the motor from the commercial power supply over to the inverter, it must be noted that an interlock time of electromagnetic contactors, timing of reset signal releasing and timing of operation command applying.



CAUTION:

To avoid damage to inverter

Failure to note the interlock time and so on described in Figure 9-4 could result in inverter damage.

Connection diagrams and timing charts for commercial power supply switching are shown below.

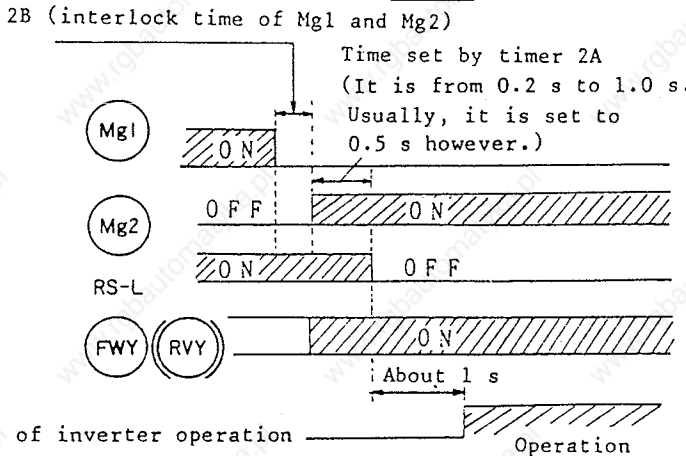
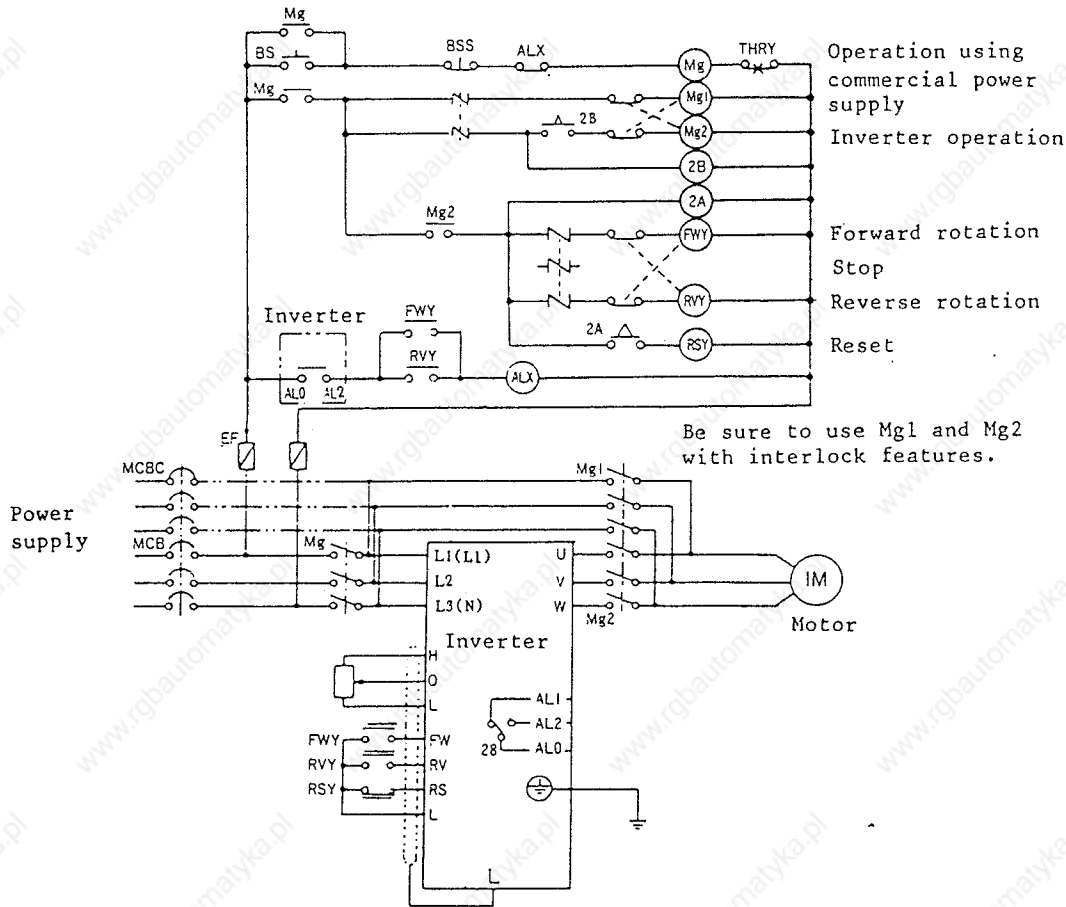

Note 1:
 When the MCB causes a trip due to a ground fault or another failure, the commercial power supply circuit does not also function. If backup power is required, connect the commercial power supply circuit to the MCBC.

Note 2:
 Use relays dedicated to electronics circuits as FWY, RVY, and RSY. Use separate relays for AC and DC. The sequences in this figure are reference data for timing charts.

Figure 9-4 Sample Connection and Timing Charts for Commercial Power Supply Switching

10. SPECIFICATIONS

10.1 Block Diagram

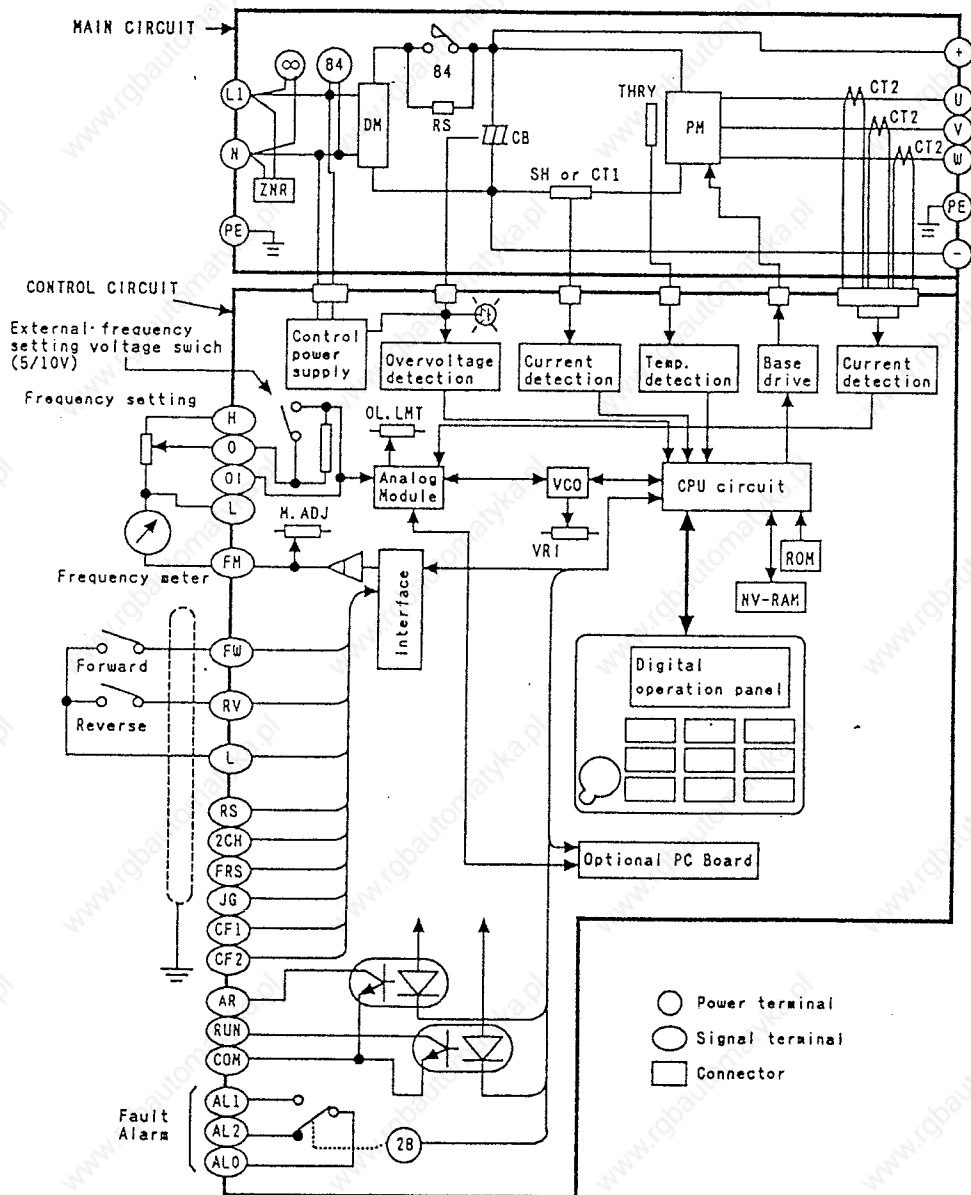

Notes: Explanation of symbols

- | | |
|--|--|
| ○ (84) : Electromagnetic contactor
(Not used to 1.5SF3EA) | ○ S H: Shunt-resistor |
| ○ (FAN) : Fan (3.5SF3EA) | ○ R S: Current Limiting resistor |
| ○ D M : Diode module (Converter module) | ○ P M: Transistor module (Inverter module) |
| ○ C B : Smoothing capacitor | ○ THRY: Thermal relay |
| ○ (2B) : Fault alarm relay | ○ CT2: Current transformer |
| ○ ZNR : Surge absorber | ○ (LED): Charging LED lamp |

Figure 10-1 Block Diagram (For 200 V Class)

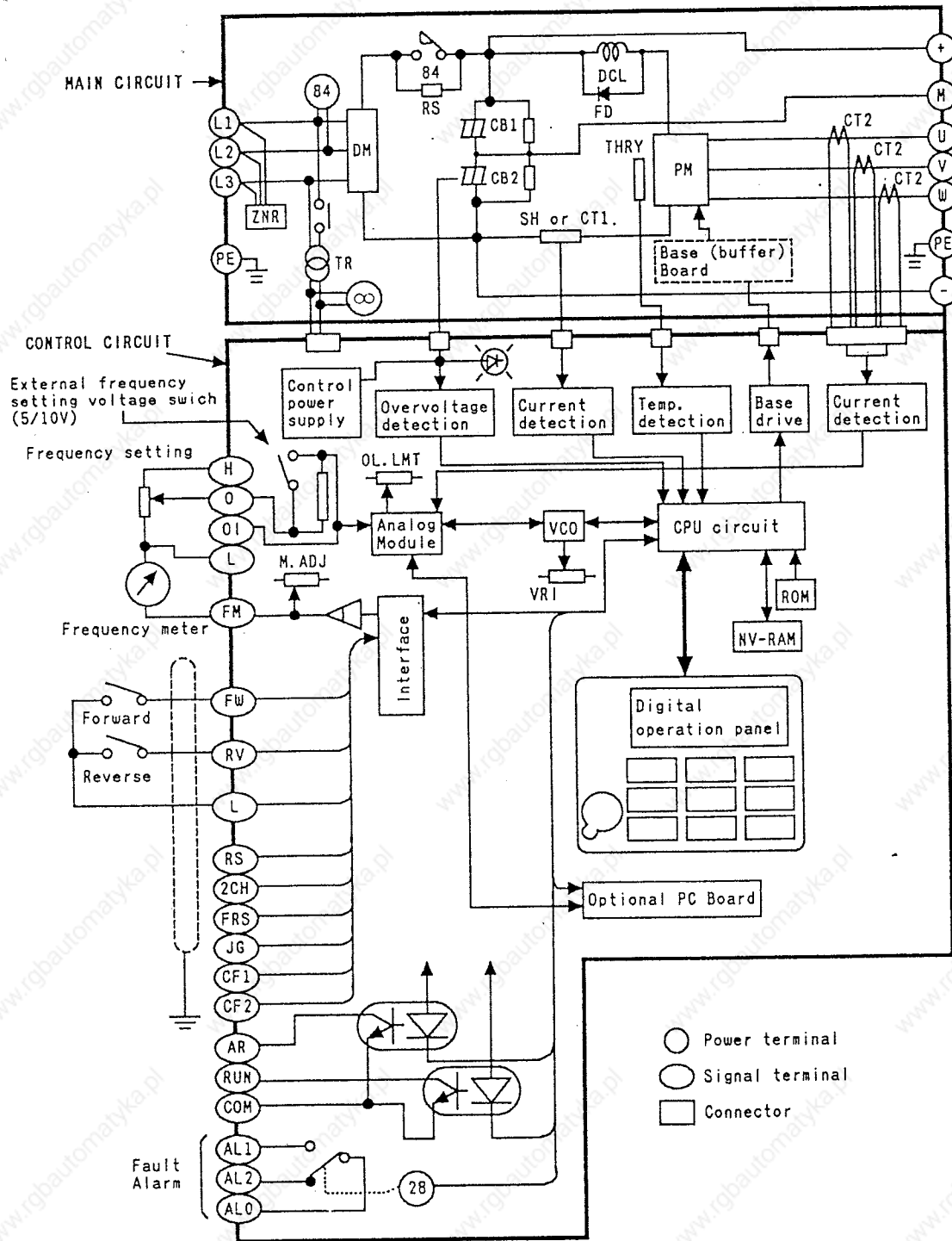

Notes: Explanation of symbols

- | | |
|---|--|
| ○ (84) : Electromagnetic contactor | ○ [] : Base board (11 kVA or more for 400V Class) |
| ○ F D : Flywheel diode | ○ S H : Shunt resistor (5.5HF3EA or less) |
| ○ T R : Transformer (Only for 400V Class) | ○ C T1 : Current transformer (8HF3EA or more) |
| ○ D M : Diode module (Converter module) | ○ R S : Current Limiting resistor |
| ○ C B : Smoothing capacitor | ○ P M : Transistor module (Inverter module) |
| ○ (28) : Fault alarm relay | ○ T H R Y : Thermal relay |
| ○ Z N R : Surge absorber | ○ C T2 : Current transformer |
| ○ D C L : DC reactor | ○ [] : Smoothing capacitor charging check LED |
| ○ ∞ : Fan (8HF3EA or more) | |

Figure 10-2 Block Diagram (For 400 V Class)

10.2 Layout on the Printed Circuit Board

Components of the printed circuit board of the HFC-VWS₃EA are mounted as shown below.

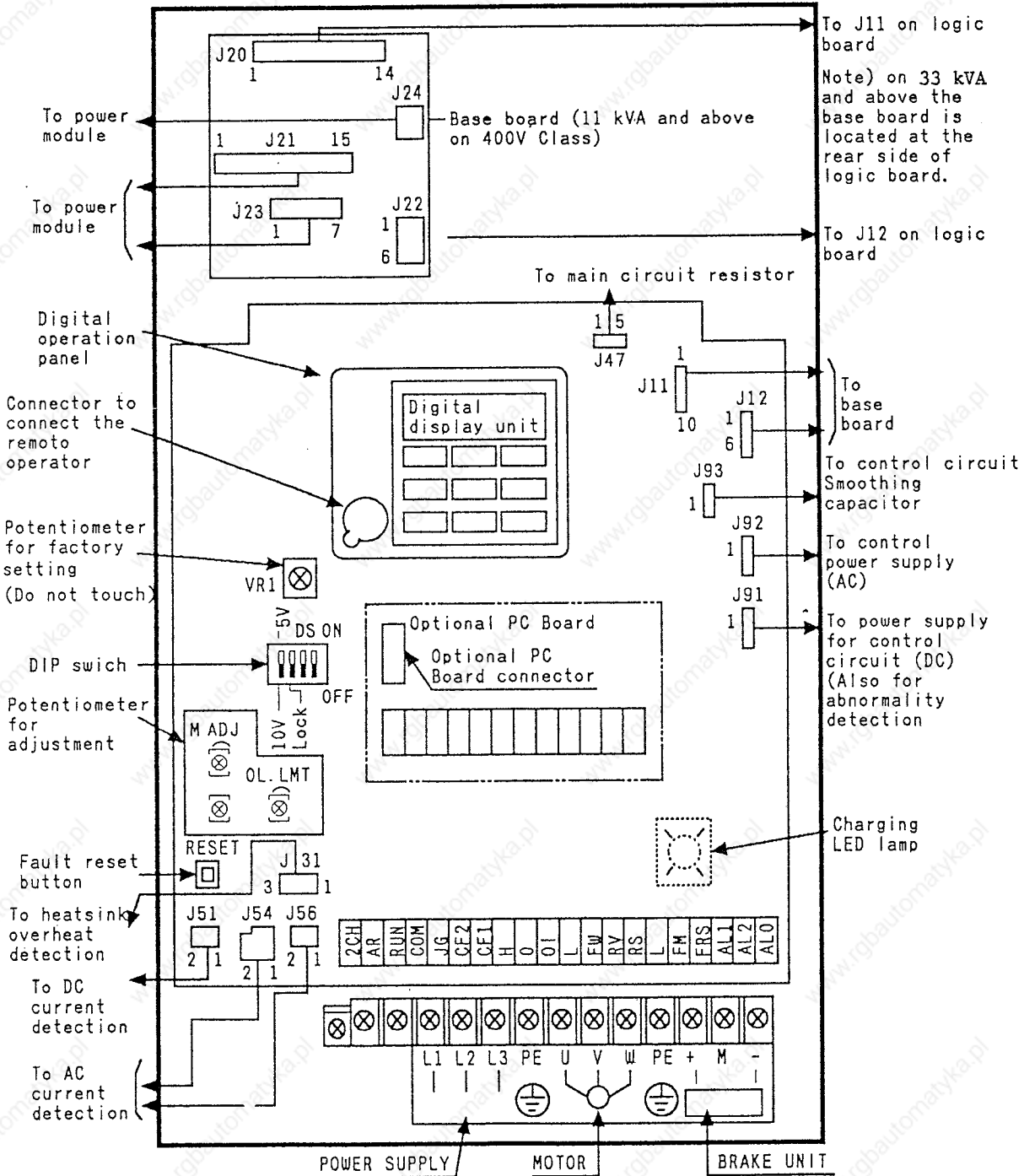

Figure 10-3 Layout on the Printed Circuit Board (For 11HF3EA)

10.3 Standard Specifications

Table 10-1 Standard Specifications







Item		VWS3EA Series Common SPEC	
Input power supply		1-phase 220-240V \pm 10%, 50/60 Hz \pm 5%	3-phase 380-415/400-460V \pm 10%, 50/60 Hz \pm 5%
Output voltage (Max.) 3-phase		220-240V	380-460V
Control system		Voltage source type, sine coded PWM	
Output frequency range		1 to 360 Hz (0.5 Hz start)	
Frequency accuracy		\pm 0.5% (25 \pm 10°C) of the maximum frequency	
Voltage/frequency characteristics		36 types selectable and Z pattern	
Overcurrent capacity		150%, 60 seconds (every 10 minutes)	
Acceleration/deceleration time (Soft start/stop)		Individual setting available Linear acceleration/deceleration: 0.1 - 2999.9 seconds Curved acceleration/deceleration: 0.1 - 2999.9 seconds	
Slip compensation		Approx. 1.5% (at based frequency) under condition of V/F constant and above 15 Hz	
Torque boost		Variable setting available	
Frequency resolution		0.01 Hz	
Braking torque		Regenerative braking	Approx. 10 - 20% (Regenerative braking by feedback to capacitor)
		Dynamic DC braking	Adjustable braking point, braking time and braking power
Input signal	Speed setting (Frequency setting)	Digital operation panel	   Key operation
		External signal	500 Ω - 2 K Ω potentiometer, DC 0 - 5V, DC 0 - 10V (Input impedance 0 - 5V: 15 K Ω , 0 - 10V: 30 K Ω), 4 - 20 mA (Input impedance 250 Ω)
	Forward/reverse operation stop	Digital operation panel	 : Forward operation  : Reverse operation  : Stop operation
		External signal	Forward operation/stop (normally open 1a contact command) Reverse operation/stop (1a contact command)
	Reset	Fault reset, instantaneous cut-off of output (1a contact command)	
	Free-run stop	Instantaneous cut-off of output (1b contact command)	
	Jogging operation	Adjustable between 0.5 and 9.9 Hz (1a contact command)	
	Multistage speed operation	Up to 4 stages can be set up (2a contact command)	
	Extended multi speed operation	Up to 8 stages can be set up (3a contact command)	
	Two-stage accel/decel time	Second accel/decel time command (1a contact)	

Table 10-1 Standard Specifications (Continued)

Item		VWS3EA Series Common SPEC		
Output signal	Frequency monitor	Pulse duty control output (Digital frequency counter, analog meter: 0 to 10V DC, 1 mA full scale connectable)		
	Fault alarm relay	OFF when the inverter is abnormal or without input power supply (1c contact output)		
	Frequency arrival signal	Turned on when the set frequency is reached. (Open collector output)		
	Running signal	Turned on during inverter running. (Open collector output)		
Protective function	Overcurrent	Individual LCD display of overcurrent at acceleration, operation and deceleration		
	Overvoltage	Trip at approx. 400 VDC of DC bus voltage (200 V class), approx. 800 VDC (400V class)		
	Overload	Protection using electronic thermal relay (Settable to 50 to 100%)		
	Fjn overheat	Protection using thermal relay only for inverter with cooling fan		
	Undervoltage	Trip at less than 150 to 160 VAC of input voltage (200 V class)	Trip at less than V1 of input voltage 280 to 320 VAC (400 V class)	
	Instantaneous power failure	Operation continuous for 15 ms or less power failure (When restart function is selected, restart is possible.)		
	Stall prevention	Prevention of stall at overcurrent and overvoltage		
	Overload limit	Inverter output current is detected, and current limit control is performed.		
	Ground fault protection	1.5SF3EA to 22HF3EA: standard.		
Optional function	Relay output of frequency arrival signal	Contact OFF at frequency arrival (1b contact output)		
	Relay output of running signal	Contact ON during running (1a contact output)		
	Speed setting signal	0 - 20 mA (Input impedance 250 Ω)		
	Inverter output current signal	Output with DC voltage (4V DC output at inverter rated current)		
	DC brake external command	DC braking operation with 1a contact command		
	Digital remote operator	DOP-1EA (with 1 m cable), DOP-3EA (with 3 m cable)		
	Copy unit	DRW-1EA (with 1 m cable)		
General specification	Ambient temperature	-10 ~ 40°C (Without terminal cover: -10 ~ 50°C storage temperature: -20 ~ 60°C)		
	Humidity	20 - 90% RH (No dew condensation allowed)		
	Vibration	1.5 - 3.5 SF3EA and 2.5 - 11HF3EA: 0.5G (10 to 55 Hz) 16 - 22 HF3EA: 0.2G (10 to 55 Hz)		
	Operating site	1,000m or less in altitude, indoors (place free of corrosive gas and dust or dirt)		
	External color	Munsell 5Y7/1, (1.5 to 3.5SF3EA, 2.5 to 11HF3EA diecast cases are black corresponding to Munsell N3.)		

• Ratings

Table 10-2 Dimensions of 200 Volt Class

VWS ₃ EA Series Specifications							
Type (Model Abbrevia- tion)	Protective Structure	Capacity (kVA)		Rated Output Current (A)	Max. Appli- cable Motor (kW)	Cooling system	Approx. weight (kg)
		220 V	240 V				
1.5SF3EA	Semi- enclosed type (IP20)	1.9	2.1	5	0.75	Self- cooling	5.5
2.5SF3EA		2.9	3.1	7.5	1.5		6.0
3.5SF3EA		4.0	4.4	10.5	2.2	Forced air cooling	6.5

Table 10-3 Dimensions of 400 Volt Class

VWS ₃ EA Series Specifications							
Type (Model Abbrevia- tion)	Protective Structure	Capacity (kVA)		Rated Output Current (A)	Max. Appli- cable Motor (kW)	Cooling system	Approx. weight (kg)
		380 V	415 V				
2.5HF3EA	Semi- enclosed type (IP20)	2.5	2.7	3.8	1.5	Self- cooling	7.5
3.5HF3EA		3.5	3.8	5.3	2.2		7.5
5.5HF3EA		5.7	6.2	8.6	4.0		8.5
8HF3EA		8.6	9.3	13	5.5	Forced air cooling	14.5
11HF3EA		11	12	16	7.5		15
16HF3EA		15	17	23	11		22.5
22HF3EA		21	23	32	15		24.5

10.4 Description of Terminals

Table 10-4 Designation of Terminals

	Terminal symbol	Terminal name	Description
Main circuit terminals	L1, L2, L3 (3-phase) L1, N (1-phase)	Commercial power supply input terminals	1-phase; 220 - 240 V, 50, 60 Hz 3-phase; 380 - 415/50 Hz, 400 - 460/60 Hz
	U, V, W	Inverter output terminals	Motor connecting terminals
	⊕, M, ⊖	DC bus voltage terminals	Regenerative braking unit connecting terminals
Control circuit terminals	2CH	Two-stage acceleration/deceleration terminal	Contact (close): Two-stage acceleration/deceleration
	AR	Frequency arrival signal terminal	When the set frequency is reached, the transistor output is ON. (27 VDC, 50 mA max)
	RUN	Running signal terminal	The transistor output is ON during operation. (27 VDC, 50 mA max)
	COM	Common terminal	Common terminal only for AR and RUN (This terminal is not a ground terminal.)
	JG	Jogging terminal	Contact (close): Jogging operation
	CF2	Multi-stage speed terminals	Contact (close): Multi-stage speed operation
	CF1		
	H	Frequency setting power supply terminal	10 VDC
	O	Frequency setting terminal	0 - 10 VDC or 0 - 5 VDC (selectable by a DIP switch) Input impedance: 15 kΩ in the 0 - 5 V range or 30 kΩ in 0 - 10 V range
	OI	Frequency setting terminal	4 - 20 mA (Input impedance is 250 Ω.)

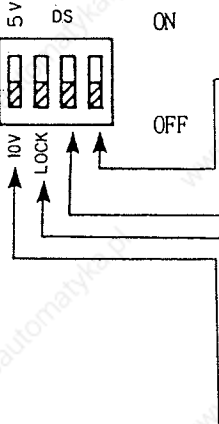
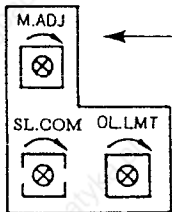

Table 10-4 Designation of Terminals (Continued)

Terminal symbol	Terminal name	Description
L	Common terminal of control terminals	Common terminal of control terminals (This terminal is not a ground terminal.)
FW	Forward rotation/stop terminal	Contact (close): Forward rotation Contact (open): Stop
RV	Reverse rotation/stop	Contact (close): Reverse rotation Contact (open): Stop
RS	Failure reset terminal	Contact (close): The fault signal is released.
L	Common terminal of control terminals	Common terminal of control terminals. (This terminal is not a ground terminal.)
FM	Frequency monitor terminal	A digital frequency counter or an analog meter can be selected. (0 - 10 V, 1 mA full-scale. The load resistance is 10 to 22 k Ω .)
FRS	Free-run stop terminal	Contact (open): The inverter stops and the motor stops in the free-run state. (The fault signal is not released.)
AL1 AL2 ALO	Fault alarm contact terminal	During fault, power off ALO - AL1: Closed ALO - AL2: Open Contact rating 250 VAC, 2.5 A (resistive load) 0.2 A ($\cos \phi = 0.4$) 30 VDC, 3 A (resistive load) 0.7 A ($\cos \phi = 0.4$)

Use electronic relays (usable at 12 VDC, 3 mA) between control circuit terminals except the one between ALO and AL2.

10.5 Potentiometers and DIP Switches

Table 10-5 Designation of Potentiometers and DIP Switches

	Name	Description
Pot. meter for factory setting	 VR1	Factory-set. <u>Do not change this setting.</u>
DIP switches		<p>(To return the inverter to the original standard setting, set this DIP switch to ON. After resetting the inverter, return the DIP switch to OFF. For details, see page 9-3.)</p> <p>(Leave this DIP switch off. If it is set to ON mistakenly, the optional remote operator does not function correctly.)</p> <p>Soft lock: When this DIP switch is set to ON, no data can be changed.</p> <p>External frequency setting voltage switching 5 V: 0 - 5 VDC/0 - Fmax 10 V: 0 - 10 VDC/0 - Fmax</p>
Pot. meters for adjustment		<p>For external analog frequency meter adjustment. (For details, see page 9-32.)</p> <p>(For overload limiting level adjustment. The standard setting is 125%. To increase the limit, rotate the pot. meter clockwise. See also (F-30) on page 9-28.)</p> <p>(The slip compensation allows to reduce the natural speed loss of the asynchronous motor due to increased load.)</p> <p>(In the range under condition of V/F constant and above 15 Hz, speed accuracies approx. 1.5% Nn can be achieved without tacho generator feed back. Turning the "SL.COM" (VR) clockwise, reduces the slip.)</p>
Fault reset button	RESET 	Forced reset button

10.6 Wires and Components

Select appropriate wires and components with reference to the following table.

Note that the contents of the table may differ according to wire lengths and power supply capacities.

Table 10-6 Standard Applicable Equipment

Applicable Motor (4P, KW)	Inverter Model	Wiring			Applicable Equipment		
		Power Line L1, L2 L3, N, PE U, V, W +, M, -	Signal Line JG, CF2 CF1, H, O, OI, L, FW, RV, RS FM, FRS, ZCH AR, RUN, COM	Control Line AL1 AL2 ALO	Circuit Breaker (MCB)	Electro-magnetic Contactor (Mg)	Thermal Relay (RC Value)
0.4	VWS1.5SF3EA	2 mm ² or more	Shielded line for 0.75 mm ² or more	2 mm ² or more	F-30B(15A)	H20	TR20-1E(2.4A)
0.75	VWS1.5SF3EA	2 mm ²		2 mm ²	F-30B(15A)	H20	TR20-1E(3.8A)
1.5	VWS2.5SF3EA	2 mm ²		2 mm ²	F-30B(20A)	H20	TR20-1E(6.8A)
2.2	VWS3.5SF3EA	2 mm ²		2 mm ²	F-30B(30A)	H20	TR20-1E(9A)
1.5	VWS2.5HF3EA	2 mm ²		2 mm ²	F-50F(15A)	H10	TR20-1E(3.0A)
2.2	VWS3.5HF3EA	2 mm ²		2 mm ² or more	F-50F(15A)	H20	TR20-1E(3.8A)
4.0	VWS5.5HF3EA	2 mm ²		2 mm ²	F-50F(15A)	H20	TR20-1E(6.8A)
5.5	VWS8HF3EA	3.5 mm ²		2 mm ²	F-50F(30A)	H20	TR20-1E(9A)
7.5	VWS11HF3EA	3.5 mm ²		2 mm ²	F-50F(30A)	H20	TR20-1E(15A)
11	VWS16HF3EA	5.5 mm ²		2 mm ²	F-50F(50A)	H25	TR20-1E(20A)
15	VWS22HF3EA	8 mm ²		2 mm ²	F-50F(50A)	H35	TR40-1E(28A)

Note 1: Applicable equipment are used for the Hitachi standard 4-pole, 3-phase squirrel-cage motor.

Note 2: When selecting a circuit breaker, consider the breaking capacity.

Note 3: The leakage current of a single inverter is about 3 mA. (The leakage current of wires is not included.)

Note 4: When the Hitachi standard 4-pole, 3-phase squirrel-cage motor is used at frequencies from 10 Hz to 60 Hz, no thermal relay is required.

Note 5: When determining the breaking capacity, consider the power system and wiring system.

Note 6: For grounding, see page 5-4.

11. OPTION

The following options are prepared for VWS3EA series inverter.
For the details, see an individual manual.

Table 11-1 Options

Option name	Model name	Description			
Remote operator	DOP-1EA DOP-3EA	<p>These are for remote operation, and possible to operate the inverter and data change same as digital operation panel.</p> <p>DOP-1EA: Cable length 1 m DOP-3EA: Cable length 3 m</p> 			
Copy unit	DRW-1EA	<p>Possible to read all data in monitor mode and function mode, and transfer all data to other inverters. This unit is very useful to program same data to many inverters. Connected view is the same as the remote operator.</p>			
Operation box	OPE-4M OPE-8M	<p>These are analogue type operation boxes for remote operation.</p> <table border="0" style="width: 100%;"> <tr> <td style="width: 30%; vertical-align: top;"> <p>Meter scales</p> <p>0 - 50 Hz</p> <p>0 - 100 Hz</p> <p>0 - 60 Hz</p> <p>0 - 120 Hz</p> <p style="text-align: right;">4M</p> <p>0 - 50 Hz</p> <p>0 - 100 Hz</p> <p>0 - 200 Hz</p> <p>0 - 60 Hz</p> <p>0 - 120 Hz</p> <p>0 - 240 Hz</p> <p style="text-align: right;">8M</p> </td> <td style="width: 40%; vertical-align: top;"> <p>Operation box</p>  <p style="text-align: center;">Wiring diagram</p> </td> <td style="width: 30%; vertical-align: top;"> <p>Inverter</p> </td> </tr> </table>	<p>Meter scales</p> <p>0 - 50 Hz</p> <p>0 - 100 Hz</p> <p>0 - 60 Hz</p> <p>0 - 120 Hz</p> <p style="text-align: right;">4M</p> <p>0 - 50 Hz</p> <p>0 - 100 Hz</p> <p>0 - 200 Hz</p> <p>0 - 60 Hz</p> <p>0 - 120 Hz</p> <p>0 - 240 Hz</p> <p style="text-align: right;">8M</p>	<p>Operation box</p>  <p style="text-align: center;">Wiring diagram</p>	<p>Inverter</p>
<p>Meter scales</p> <p>0 - 50 Hz</p> <p>0 - 100 Hz</p> <p>0 - 60 Hz</p> <p>0 - 120 Hz</p> <p style="text-align: right;">4M</p> <p>0 - 50 Hz</p> <p>0 - 100 Hz</p> <p>0 - 200 Hz</p> <p>0 - 60 Hz</p> <p>0 - 120 Hz</p> <p>0 - 240 Hz</p> <p style="text-align: right;">8M</p>	<p>Operation box</p>  <p style="text-align: center;">Wiring diagram</p>	<p>Inverter</p>			

Table 11-1 Options (Continued)

Option name	Model name	Description																												
<p>Multi-function board</p>	<p>OP-RY IA-TWK S3OP-PCB</p>	<p>These three option boards are possible to be installed into the inverter inside. (Plug in type). Each board has following functions.</p>																												
		<table border="1"> <thead> <tr> <th></th> <th>OP-RY</th> <th>IA-TWK</th> <th>S3OP-PCB</th> </tr> </thead> <tbody> <tr> <td>Frequency reference signal 0-20 mA</td> <td>N/A</td> <td>Available</td> <td>N/A</td> </tr> <tr> <td>DC braking external signal</td> <td>N/A</td> <td>Available</td> <td>Available</td> </tr> <tr> <td>Inverter output current signal</td> <td>N/A</td> <td>Available</td> <td>Available</td> </tr> <tr> <td>Running signal relay output</td> <td>Available</td> <td>Available</td> <td>Available</td> </tr> <tr> <td>Frequency arrival signal relay output</td> <td>Available</td> <td>Available</td> <td>Available</td> </tr> <tr> <td>Overload warning alarm signal relay output</td> <td>N/A</td> <td>N/A</td> <td>Available</td> </tr> </tbody> </table>		OP-RY	IA-TWK	S3OP-PCB	Frequency reference signal 0-20 mA	N/A	Available	N/A	DC braking external signal	N/A	Available	Available	Inverter output current signal	N/A	Available	Available	Running signal relay output	Available	Available	Available	Frequency arrival signal relay output	Available	Available	Available	Overload warning alarm signal relay output	N/A	N/A	Available
			OP-RY	IA-TWK	S3OP-PCB																									
		Frequency reference signal 0-20 mA	N/A	Available	N/A																									
		DC braking external signal	N/A	Available	Available																									
		Inverter output current signal	N/A	Available	Available																									
		Running signal relay output	Available	Available	Available																									
		Frequency arrival signal relay output	Available	Available	Available																									
Overload warning alarm signal relay output	N/A	N/A	Available																											
																														
<p>Serial communication interface module</p>	<p>COM-EA</p>	<p>This is the communication interface module to communicate with personal computer (PC) or programmable logic controller (PLC). This module is supported by RS232C and RS485. This module is installed between an inverter and PC/PLC, and it is not plug in type like option board.</p>																												

12. PARTS AND REPAIR

12.1 Parts Order

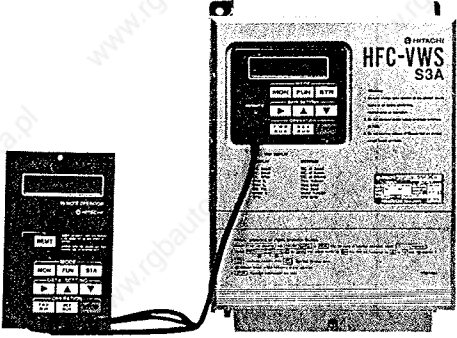
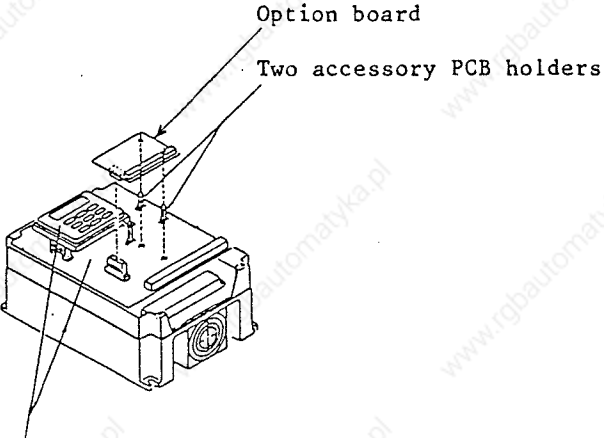
Before ordering parts or inquire what to do when your inverter goes wrong, please check the following items:

- (1) Type
- (2) Output (kVA)
- (3) Manufacturing serial number
- (4) Symptom of failure

If the nameplate is too dirty to read the above information, inform only the clear items and attach simple sketches of the parts that you want.

To minimize the idle time, it is recommended that the parts listed in Table 7-2 on page 7-6 to stocked.

WARRANTY: The warranty period under normal installation and handling conditions shall be one year after the date of delivery. The warranty shall cover only repair of the main unit of the inverter.

12.2 Repair

- (1) The repair shall be charged to the purchaser even within the warranty period if a failure or damage is caused by:
 - (a) Incorrect operation, remodeling, or improper repair
 - (b) Drop after your purchase or accident in transit
 - (c) Fire, earthquake, flood, thunderbolt, natural calamities, pollution, or abnormal voltage
- (2) If you want that the inverter is repaired on your site, the expense associated with the travel and repair expense are charged to the purchaser.
- (3) This manual is not re-issued. Always keep it handy. Do not lose it.