

Product Catalog

Modules

Isolation Amplifiers / Transmitters

Knick. Always better.

Selection matrix / Contents

Type	Products	Inputs				Output				Isolation		Power supply						Error class	Width [mm]	Page	
		0 ... 20 mA	4 ... 20 mA	0 ... 10 V	Others	Bipolar	0 ... (±) 20 mA	4 ... 20 mA	0 ... (±) 10 V	0 ... 50 mA	Working voltage	Test voltage AC 50 Hz	20 ... 253 V AC/DC	90 ... 253 V AC	24 V DC	24 V AC	110/115 V AC				220/230 V AC
Modular cases (safe-area applications)																					
Universal isolation amplifiers	VariTrans® P 27000	✗	✗	✗	0 ... ±0,1 mA to 0 ... ±100 mA, 0 ... ±20 V to 0 ... ±200 V	✗	✗	✗	✗	1000 V	5 kV	Broad-range power supply						0.08	12.5	24	
	VariTrans® A 26000	✗	✗	✗		✗	✗	✗	✗	1000 V	4 kV	Broad-range power supply						0.1	12.5	32	
Isolation amplifiers for standard signals	VariTrans® P 15000	✗	✗	✗			✗	✗	✗	1000 V	4 kV	Broad-range power supply						0.08	12.5	38	
	VariTrans® B 13000	✗	✗	✗			✗	✗	✗	600 V	3.25 kV		●	●	●			0.4	12.5	46	
	VariTrans® B 10000	✗	✗	✗			✗	✗	✗	100 V	510 V		✗					0.4	6.1	54	
	IsoTrans® 41	✗	✗		0 ... 50 mA		✗	✗	✗	500 V	2.5 kV							✗	0.2	17.5/22.5	60
	IsoTrans® A 47	✗	✗		0 ... 50 mA		✗	✗	✗	300 V	2.5 kV * 4 kV							✗	0.2	12.5/22.5	68
Isolation amplifiers for shunt applications	IsoTrans® B 48	✗	✗				✗	✗		100 V	510 V							✗	0.1	6	74
	IsoAmp® 23000				0 ... ±60 mV to 0 ... ±500 mV, 0 ... ±100 V to 0 ... ±1200 V	✗	✗			2000 V	7 kV		●	●	●	●			0.1	22.5	80
	IsoAmp® 24000				0 ... ±60 mV to 0 ... ±500 mV, 0 ... ±100 V to 0 ... ±1200 V	✗			✗	2000 V	7 kV		●	●	●	●			0.1	22.5	80
Repeater power supplies	IsoAmp®PWR A 20100		✗				✗	✗	✗	600 V	2.5 kV		✗						0.1	6.1	86
	IsoAmp®PWR B 10116		✗					✗		300 V	1.5 kV		✗						0.2	6.1	92
Temperature transmitters Resistance thermometers	ThermoTrans 205	Various resistance thermometers					✗	✗		1000 V	4 kV		●	●	●	●			0.1	22.5	98
	ThermoTrans 206	Various resistance thermometers							✗	1000 V	4 kV		●	●	●	●			0.1	22.5	98
Temperature transmitters Thermo-couples	ThermoTrans 210	Various thermocouples					✗	✗		1000 V	4 kV		●	●	●	●			0.1	22.5	106
	ThermoTrans 211	Various thermocouples							✗	1000 V	4 kV		●	●	●	●			0.1	22.5	106
AC/DC transducers	IsoTrans® 600				0 ... 5 A AC, 0 ... 400 V AC, 48 ... 63 Hz		✗		✗		6 kV					●		(✗)	0.5	22.5	114
Isolators for high isolation/ input voltages	IsoAmp® 7000				0 ... ±50 mA to 0 ... ±5 A, 0 ... ±200 V to 0 ... ±3000 V	✗	✗			1500 V	5 kV * 7 kV		●	●	●	●	●		0.2	100	122
	IsoAmp® 8000				0 ... ±50 mA to 0 ... ±5 A, 0 ... ±200 V to 0 ... ±3000 V	✗			✗	1500 V	5 kV * 7 kV		●	●	●	●	●		0.2	100	122
Modular cases (hazardous-area applications)																					
Isolation amplifiers for standard signals	IsoTrans® 36/37	✗	✗				✗			3600 V	4.4 kV * 10 kV							✗	0.2	22.5	128
	WG 20	✗	✗				✗	✗		1000 V	4 kV		✗	✗					0.1	22.5	136
Repeater power supplies	WG 20		✗					✗		1000 V	4 kV		✗	✗					0.1	22.5	136
	WG 21		✗					✗		1000 V	4.4 kV	●	●	●					0.1	22.5	142
	WG 25		✗					✗		1000 V	4.4 kV * 10 kV							✗	0.2	22.5	148
Temperature transmitters Resistance thermometers	ThermoTrans 205	Various resistance thermometers					✗	✗		1000 V	4 kV		●	●	●	●			0.1	22.5	156
	ThermoTrans 206	Various resistance thermometers							✗	1000 V	4 kV		●	●	●	●			0.1	22.5	156
Temperature transmitters Thermocouples	ThermoTrans 210	Various thermocouples					✗	✗		1000 V	4 kV		●	●	●	●			0.1	22.5	166
	ThermoTrans 211	Various thermocouples							✗	1000 V	4 kV		●	●	●	●			0.1	22.5	166
Eurocards (safe-area applications)																					
Universal isolation amplifiers	IsoAmp® 11000	✗		✗	0 ... ±20 mV to 0 ... ±60 mV, 0 ... ±150 mV to 0 ... 500 mV	✗	✗			1000 V	4 kV		●				●		0.2	5 TE	176
	IsoAmp® 12000	✗		✗	0 ... ±20 mV to 0 ... ±60 mV, 0 ... ±150 mV to 0 ... 500 mV	✗			✗	1000 V	4 kV		●				●		0.2	5 TE	176
Isolation amplifiers for standard signals	IsoAmp® 3000	✗	✗	✗			✗	✗		1000 V	4 kV		✗	✗					0.01	4/5 TE	184
	IsoAmp® 4000	✗	✗	✗				✗		1000 V	4 kV		✗	✗					0.01	4/5 TE	184
	IsoTrans® 41	✗	✗		0 ... 50 mA		✗	✗	✗	500 V	2.5 kV							✗	0.02	4 TE	192
	IsoTrans® 46	✗	✗		0 ... 50 mA		✗	✗	✗	100 V	510 V							✗	0.1	3 TE	198
Standard-signal multipliers	EK 30/31	✗	✗	✗			✗	✗		1000 V	4 kV		✗	✗					0.1	4 TE	204
Modules (safe-area applications)																					
Universal isolation amplifiers	IsoAmp® 11000	✗		✗	0 ... ±20 mV to 0 ... ±60 mV, 0 ... ±150 mV to 0 ... 500 mV	✗	✗			1000 V	4 kV						●		0.2	22.5	212
	IsoAmp® 12000	✗		✗	0 ... ±20 mV to 0 ... ±60 mV, 0 ... ±150 mV to 0 ... 500 mV	✗			✗	1000 V	4 kV						●		0.2	22.5	212
Isolation amplifiers for standard signals	IsoAmp® 3000	✗	✗	✗			✗	✗		1000 V	4 kV		✗	✗					0.01	22.5	218
	IsoAmp® 4000	✗	✗	✗				✗		1000 V	4 kV		✗	✗					0.01	22.5	218
	IsoTrans® 41	✗	✗		0 ... 50 mA		✗	✗	✗	500 V	2.5 kV							✗	0.02	22.5	226
	IsoTrans® 46	✗	✗		0 ... 50 mA		✗	✗	✗	100 V	4 kV							✗	0.1	22.5	234

✗ Available

● Ordering alternatives

* optional

Preamble

Selection Matrix / Table of Contents		2 / 3
Product Overview		4
The Company	The whole range of perfection	6
Timeline	Knick. Chronology of innovations.	10
Discourse	Electrical isolation in industrial measuring technology	12

Modular Cases

Universal isolation amplifiers	VariTrans® P 27000	24
	VariTrans® A 26000	32
Isolation amplifiers for standard signals	VariTrans® P 15000	38
	VariTrans® B 13000	46
	VariTrans® B 10000	54
Loop-powered isolators for standard signals	IsoTrans® 41	60
	IsoTrans® A 47	68
Isolating terminal	IsoTrans® B 48	74
Isolation amplifiers for shunt applications	IsoAmp® 23000/24000	80
Repeater power supplies	IsoAmp® PWR A 20100	86
	IsoAmp® PWR B 10116	92
Temperature transmitters	ThermoTrans® 205/206	98
	ThermoTrans® 210/211	106
AC/DC transmitters	IsoTrans® 600	114
Isolators for high isolation/ high input voltages	IsoAmp® 7000/8000	122

Modular cases Hazardous area

Isolation amplifiers for standard signals	see Repeater power supply WG 20	136
Loop-powered isolators for standard signals	IsoTrans® 36/37	128
Power supply/isolator	WG 20	136
Repeater power supply	WG 21	142
Loop-powered supply	WG 25	148
Temperature transmitters	ThermoTrans® 205/206	156
	ThermoTrans® 210/211	166

Eurocards

Universal isolation amplifiers	IsoAmp® 11000/12000	176
Isolation amplifiers for standard signals	IsoAmp® 3000/4000	184
Loop-powered isolators for standard signals	IsoTrans® 41	192
	IsoTrans® 46	198
Standard-signal multipliers	IsoAmp® EK 30/31	204

Modules

Universal isolation amplifiers	IsoAmp® 11000/12000	212
Isolation amplifiers for standard signals	IsoAmp® 3000/4000	218
Loop-powered isolators for standard signals	IsoTrans® 41	226
	IsoTrans® 46	234

Modular cases
Safe area

Modular cases
Hazardous area

Eurocards

Modules

Product Overview

MODULAR CASES Safe areas

Active isolation amplifiers

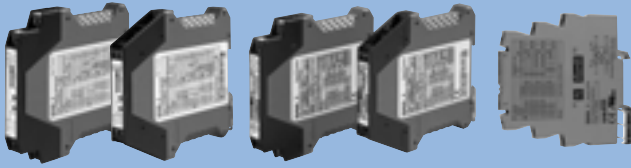

VariTrans® P 27000 / A 26000 / P 15000 / B 13000 / B 10000

Passive isolators



IsoTrans® 41

IsoTrans® A 47

IsoTrans® B 48

MODULAR CASES Safe areas

Repeater power supplies

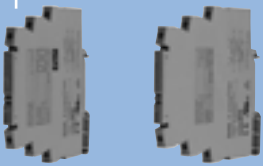

IsoAmp® PWR A 20100

IsoAmp® PWR B 10116

Shunt isolators, AC/DC transducers, high-voltage isolators



IsoAmp® 23000/24000

IsoTrans® 600

IsoAmp® 7000/8000

Temperature transmitters

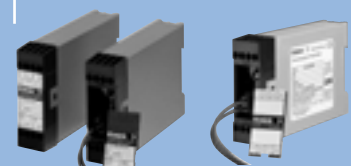

ThermoTrans® 205/206

ThermoTrans® 210/211

MODULAR CASES Hazardous areas

Isolation amplifiers for standard signals

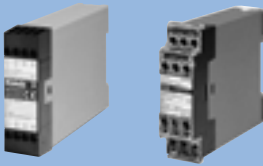

IsoTrans® 36/37

WG 20

Repeater power supplies



WG 20

WG 21

WG 25

Temperature transmitters

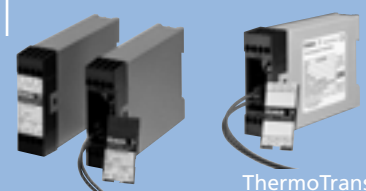

ThermoTrans® 205/206

ThermoTrans® 210/211

EUROCARDS

Universal isolation amplifiers



IsoAmp® 11000/12000

Isolation amplifiers for standard signals

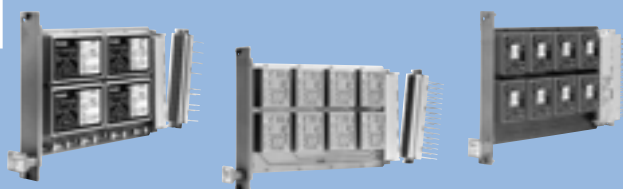

IsoAmp® 3000/4000

IsoTrans® 41

IsoTrans® 46

Standard-signal multipliers



EK 30/31

MODULES

Universal isolation amplifiers

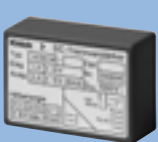

IsoAmp® 11000/12000

Isolation amplifiers for standard signals

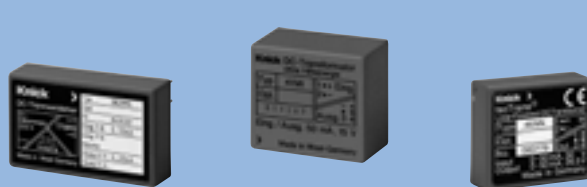

IsoAmp® 3000/4000

IsoTrans® 41

IsoTrans® 46

Always better.

In the field of industrial galvanic isolation, Knick is the market leader. The state-of-the-art is constantly being redefined by the Knick module range. The devices have technical specifications that are continually above the maximum requirements. The aspect of reliability is taken into consideration as early as in the development stage, from the first definition phase. The advantages are in every detail. For example, the switching of measurement ranges is always calibrated on Knick isolators and there is no need for complicated recalibration.

Knick modules

The consistent use of high-quality components with an extremely long shelf life is part of the basic design principles at Knick just like intelligent circuit design and the planning of safety spans between the actual loading and possible maximum rating. Integrated protection measures against overloading ensure further optimization of the devices. Reliability checks and design verification are obligatory in product development.

Certified quality.

Numerous approvals also prove suitability for extraordinary requirements and fields of application. The Knick range contains devices with GL, UL, CSA, FM and ATEX approvals. The main focus is also on preventive quality assurance in production. One result of this perfection is the proverbial long life of Knick isolators that sets standards with a 5-year warranty and a very high level of reliability. Not by chance, but as a declared design and development aim.

Since 1993 Knick has been certified to ISO 9001.



Knick

■ Signals over long distances

If the measuring signal has a long path, for example, to reach the control room, potential differences can occur between the measuring point and the control equipment causing considerable measurement errors. The electrical isolation completely eliminates the effects of these potential differences thus rectifying measurement errors.

■ Signal adaptation

One common problem is the conversion of almost any measuring signals into standard signals. The VariTrans® series from Knick features universal and standard-signal isolators with excellent characteristics in this area.

■ High voltages in the measuring environment

If the signal being measured is in a high-voltage area (for example, power supplies for buildings, railway facilities, production facilities), it needs to be kept away from the control technology (common-mode rejection, potential shift).

■ Signal amplification

If the power output of the signal source is not sufficient, active Knick isolators amplify the signals without falsifying the signal with interfering faults.

■ Measuring high voltages

If high voltages and currents are measured (for example, the voltage of a streetcar contact wire or the current flowing through the drive motor), the control equipment needs to be protected.

Knick isolators provide the only really reliable protection in conjunction with good interference suppression.

■ Explosive mixtures

Ignition sparks must be avoided at all costs during operation in potentially explosive atmospheres. Galvanic isolation suitable for explosive atmospheres is required to connect measuring and control signals from a hazardous area to the control equipment. The Knick range features excellent isolators and transmitters for these applications.

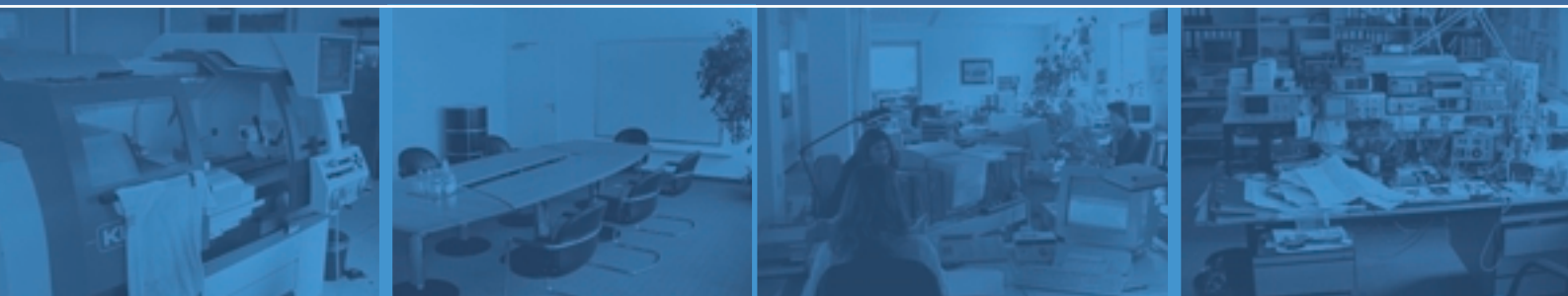

Knick

■ Flexibility

If diverse applications should be covered with a minimum number of models, the VariTrans® P 27000 universal isolation amplifier provides a wide range of input, output and supply voltages in one unit. Also there is no need for adjustment by the user, the devices provide calibrated range selection for input and output.

■ Universal power supply

We have a solution for all supply voltages: Our broad-range power supply works with any voltage between 20 V and 253 V, no matter whether AC or DC.

■ Loop-powered isolation

If there is no power supply or you want to avoid using a power supply, our passive isolators have excellent transmission properties.

■ Space problems

If space is limited, the Knick isolators provide an enormous space advantage in their 6 mm enclosures – without losing out on performance. Due to the minimal heat generation, the isolators can be placed next to each other without 'ventilation gaps'.

■ Supply of 20 mA measuring loops

2-wire measuring systems are supplied via the 20-mA signal line. Knick provides supply units for two-wire power supply and isolation of the sensor signal for hazardous and non-hazardous applications.

■ Signal multipliers

The measuring signal from a thermometer, for example, needs to be sent to an indicator and a data logger on site and to the control room, however, the out-

put power provided (max. load) is not sufficient for both consumers.

Solution: Knick supplies signal multipliers on Eurocards. When top-hat rails are used, two or more active Knick isolators can be connected due to the extremely good input values. Their outputs can then be used independently and without feedback to the inputs.

■ Transmitters

Special sensors require special transmitters so that measuring signals can be understood by standardized control systems. Knick supplies temperature transmitters for resistance thermometers and thermocouples. The diverse configuration possibilities leave nothing to be desired.



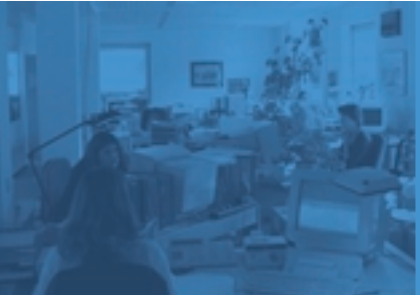
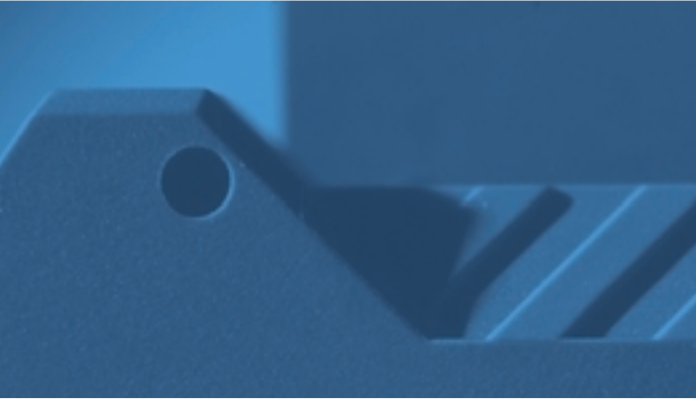

Knick

Knick.











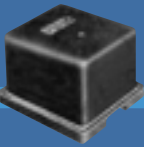





The name Knick has been recognized for outstanding quality in the manufacture of electronic measuring instruments for more than half a century. Back in 1945 the company's founder, engineer Ulrich Knick, started manufacturing high-precision zero-point-stabilized DC amplifiers. These enabled the production of reliable laboratory pH meters and other precision measuring instruments.

Today, company policy still focuses on a high technical level and a highly innovative orientation. Every fourth employee works in Research and Development. A large number of patents and licensing agreements are the result. The current production range at Knick includes pioneering instruments for measurement and control.

A great deal of emphasis is placed on EMC and explosion protection, where the firm has made a name for itself by demonstrating its expertise. For example, Knick also produces standard-signal isolation amplifiers, repeater power supplies and temperature transmitters for use in potentially explosive atmospheres.

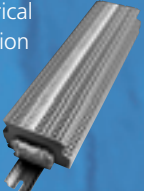

Knick. Chronology of innovations.

<p>1945 World's first zero-point-stabilized modulated DC amplifier</p> 	<p>1956 First laboratory pH meter with zero-point-stabilized Knick amplifier</p> 	<p>1958 First zero-point-stabilized chopperless pH amplifier</p> 	<p>1960 First transistorized chopper amplifier for measuring and control engineering</p> 	<p>1964 First Knick amplifier for use in hazardous locations</p> 	<p>1964 First DC transformer for passive signal isolation in measuring and control engineering</p> 
<p>1979 First microprocessor-controlled pH meter with automatic electrode calibration</p> 	<p>1979 First industrial pH meter with digital display for on-site mounting in hazardous locations with a Zone-0 input</p> 	<p>1980 First electrodeless conductivity measuring system for hazardous area applications with PTB-certified sensor</p> 	<p>1980 First loop-powered digital indicator for mounting within hazardous locations</p> 	<p>1980 First loop-powered DC transformer for mounting within hazardous locations</p> 	<p>1985 First retractable probe control for fully automatic pH measurement</p> 
<p>1995 First process analyzer for simultaneous measurement of pH and conductivity in hazardous locations</p> 	<p>1996 First portable meter for hazardous-area applications with IP 66 protection</p> 	<p>1997 First process analyzer with broad-range power supply of 20 ... 253 V AC/DC</p> 	<p>1998 First terminal with electrical isolation</p> 	<p>1999 First isolation amplifier in 12.5 mm modular case with broad-range power supply 20 ... 253 V AC/DC and calibrated range selection</p> 	<p>2000 First product line for liquid analysis with PROFIBUS®-PA interface and 'Profile for Process Control Devices'</p> 



1965
First zero-point-stabilized industrial pH transmitters for hazardous area applications



1967
First portable pH meter for hazardous area applications (5000 operating hours without battery replacement)

1969
First compact digital pH meter



1972
First DC isolation amplifier from Knick for active signal isolation in measuring and control engineering

1973
First portable pH meter with digital display and automatic sensor control (2500 measurements without battery replacement)



1976
First industrial pH transmitter for applications in the highest danger zone: Zone 0



1986
First system-capable DC calibrators in the DM 2000 price range



1988
Laboratory conductivity meter with 4-electrode sensor and a new circuit principle that for the first time enables measurements in the 1 μ S/cm ... 1000 mS/cm range with a single sensor

1991
First loop-powered digital indicator with EMC to NAMUR



1992
First laboratory pH meter with complete self-monitoring including electrode and EMC according to NAMUR



1992
First analyzer line with EMC and user interface to NAMUR



1995
First portable pH meters with data logger and PC interface



2001
First modular process analyzer in hygienic stainless steel enclosure



2002
First active isolation amplifier with 3-port isolation in 6 mm enclosure

2002
First portable meter for measuring dissolved oxygen with flow-free sensors



2003
First remote-calibration probe with maintenance-free ceramic sealing



2003
First measuring system for fully automatic pH measurement in hygienic locations



2003
First repeater power supply in 6 mm enclosure

Electrical isolation in industrial measuring technology.

Introduction

In industrial plants, the transmission of analog measuring and control signals almost always requires electrical isolation of the signals being processed both for safety reasons and in order to achieve optimum signal quality (see Figure 1).

Measurements at dangerously high voltages or in areas where there is an explosion hazard, different ground potentials (see Figure 2), for example, in plant sections located a long way apart, as well as high common-mode voltages do not allow direct connection of the measuring signals with other plant assemblies. In this case, it is absolutely essential to electrically isolate the transmitted signals.

Knick offers suitable potential isolating components in various designs to meet these requirements. Our range includes modular cases just 6 mm wide, solder-in modules and Eurocards with up to 8 channels. Depending on the model, the appropriate measuring signals are also amplified or converted to the standard values 10 V or 20 mA. Voltages of a few mV up to 3000 V and currents of a few μA up to 10 A can be transmitted or converted with a high level of accuracy.

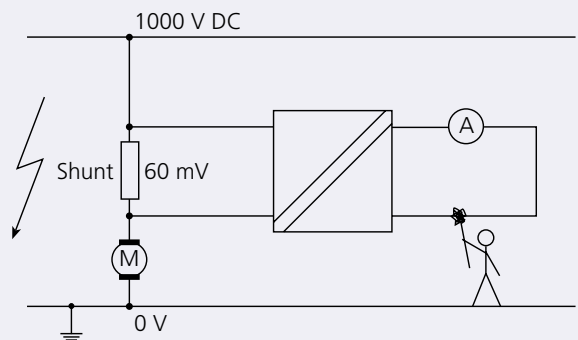
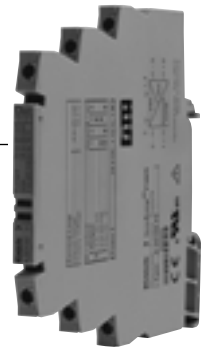

■ Figure 1: Isolation of dangerous high voltages

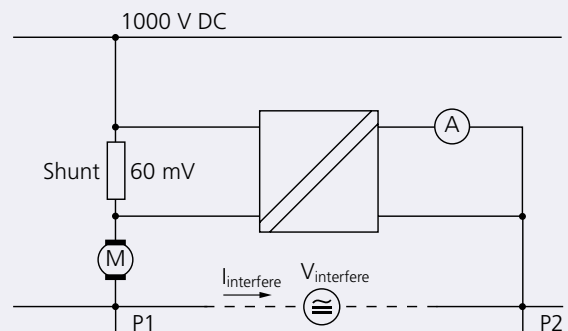

■ Figure 2: Avoiding interference caused by differences in potential

1. Active and passive isolators

Functional principle:

Alternating voltages and alternating currents can easily be transmitted and electrically isolated using transformers. Transformers are reliable, easy to produce and suitable for high working voltages (isolation voltages) when configured accordingly.

The transformers are not suitable for the transmission of direct current (DC) signals. The DC measuring signal is therefore first converted into an alternating voltage using an electronic chopper. This AC voltage is transmitted to the secondary circuit by a transformer, where it is rectified in sync with the chopper frequency (see Figure 3) and then amplified or converted if necessary.

Another principle of signal processing is used in the modern, switchable isolation amplifiers from the VariTrans® series. The input signal is converted into a rectangular signal with a constant frequency. The duty cycle of the rectangular voltage is changed depending on the input voltages (*pulse width modulation, PWM*). The pulse width modulated rectangular signal is transmitted to the output side using a transformer (isolated) and then reconverted into a voltage or current using a low-pass filter. (see Figure 4)

The transmission ratio of the isolation amplifier is controlled by a microcontroller. The settings are made using DIL switches. Since these DIL switches are not incorporated in the negative feedback of amplifier circuits, but instead only switch digital signals, they do not carry currents and cannot cause any contact resistance faults.

1.1 Active isolators (isolation amplifiers)

Isolation amplifiers are the best known type of devices for galvanic isolation of measuring signals. In addition to potential isolation, these devices can also be used as transmitters for signal conversion of voltages or currents into standardized 20 mA or 10 V signals. When measuring signals are transmitted 1:1, they are also used to increase the signal load capacity. The loading of the input signal by the isolation amplifier is generally negligible. Isolation amplifiers generally require an external power supply. Typical examples are the switchable VariTrans® P 27000 and P 15000 isolation amplifiers.

1.1.1 Isolation amplifiers for unipolar signal processing

Isolation amplifiers that are only suitable for transmitting unipolar measuring signals can be used for many applications, for example, for processing standard 0/4 ... 20 mA and 0 ... 10 V signals. For the exact transmission even in the vicinity of zero, however, the control range of the Knick unipolar isolation amplifiers extends a few percent into the negative range. (see Figure 5)

(see Figure 5)

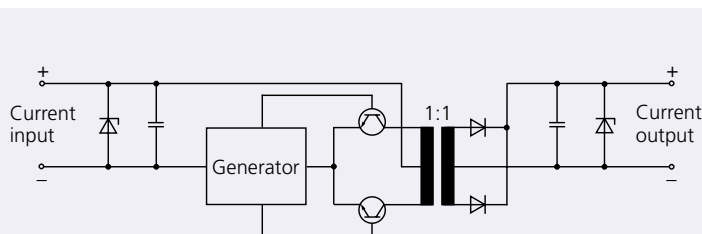

Figure 3: Schematic diagram of an isolator with transformer isolation

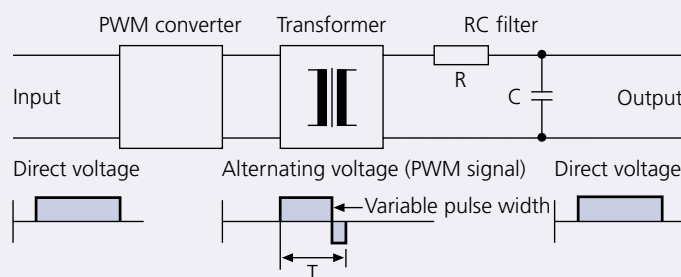

Figure 4: PWM principle: Pulse width modulation

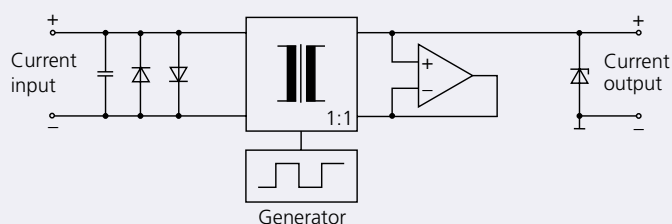

Figure 5: Schematic diagram of an active unipolar isolation amplifier

1.1.2 Isolation amplifiers for bipolar signal processing

Bipolar measuring signals frequently need to be processed when, for example, motor currents are to be measured in both directions of rotation. Bipolar signals are also processed when distances are measured or for better resolution of measuring signals. Knick also supplies different types of bipolar isolation amplifiers, for example, the VariTrans® A 26000 for bipolar standard signals. (see Figure 6)

1.2 Passive isolators

Active isolation amplifiers are absolutely necessary for electrical isolation of injected current signals. Passive isolators can often also be used without limitations.

The passive isolators from Knick do not need a power supply, the power is provided from the measuring signal at the input terminals as a voltage drop. The load capability of the input signal is reduced by the natural voltage requirement of the passive isolator. Passive isolators do not allow signal amplification and do not work isolated, i. e. the output load is directly on the input signal.

As a result, a current can no longer flow in the input current circuit when the output is open (endless resistance) (see Figure 7). If temporary interruption of the output current circuit cannot be ruled out, the DC transformer output can be connected with a Zener diode that has a voltage value well below the maximum voltage transmitted by the DC transformer and above the actual load voltage required. When the output current circuit is open, the input current then flows via the Zener diode in the output of the passive isolator (see Figure 8).

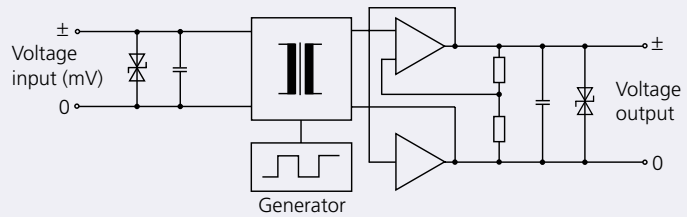

Figure 6: Schematic diagram of an active bipolar isolation amplifier

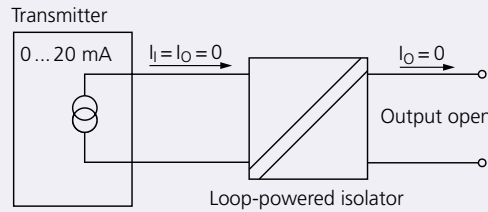

Figure 7: Loop-powered isolator with open output

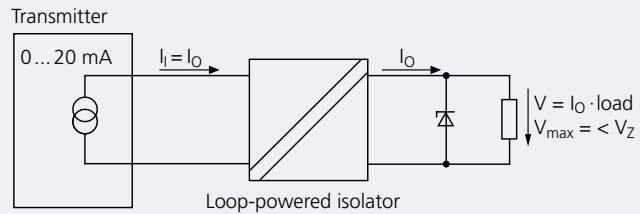

Figure 8: Loop-powered isolator with load connected to output and parallel-connected Zener diode

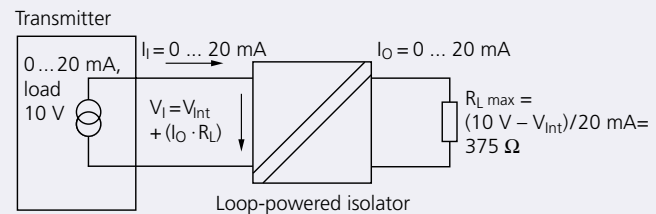

Figure 9: Circuit diagram for example 1

The operating current required to operate the devices is very low. It is approx. 2 µA to 100µA depending on the model without appearing as an additional transmission fault.

Passive isolators are suitable for 1:1 transmission of unipolar current signals. The suitability for the respective application should be checked taking the load capability of the input signal and output load into consideration (see Figure 9).

Passive isolators are particularly advantageous due to the simple installation without additional supply lines.

Passive isolators are available as modular cases with up to 4 channels (e. g. IsoTrans® A 47 H1/4), solder-in modules and on Eurocards with up to 8-channels.

2. Transmission properties

The transmission properties required by a device for signal transmission are determined by various factors. In addition to the requirements regarding accuracy and speed of the signal transmission, the input data of the following devices, the properties of the signal being transmitted and the ambient conditions also need to be taken into account.

2.1 Current or voltage transmission

The initial criteria for selecting an isolator are the input signal to be processed and the output signal required. The output signal is generally determined by the following devices such as controllers, indicators, SPC, PCS etc., whereby many of these devices have either current or voltage inputs alternatively.

If both possibilities are available, current signals should be transmitted over longer transmission paths (see Figure 10). Injected current signals are considerably less insensitive than voltage signals.

inputs so that the signal being processed is practically not loaded. Only in a few cases (very low voltage signals with a high source resistance or low-load capability current signals) would the input resistance be a selection criterion for isolation amplifiers.

The input resistance of the isolation amplifiers from the IsoAmp® 23000/24000 series specially developed for shunt applications is, at approx. 25 kOhms, relatively low compared with other isolation amplifiers. However, for shunt applications with resistances in the mOhm range, the resistance is always several times to the power of ten higher than required.

2.2.1 Input voltage drop

In various isolation amplifiers with a current input and loop-powered DC transformers, the load on the input signal is specified as a voltage drop and not as an input resistance. This voltage drop is constant during normal operation and is max. 500 mV in isolation amplifiers depending on the model.



2.3 Load capability of output

The load capability of voltage outputs is generally indicated by the max. current.

Almost all manufacturers specify a resistance value for the load capability at current outputs. This specification does not indicate the load capability of the output currents of Knick isolation amplifiers absolutely correctly. Therefore the output load capability is 'traditionally' given as a voltage value. A 20 mA current output with a load capability of 10 V can be loaded, for example, with 2 kOhms at 5 mA or 1 kOhm at 10 mA. The specification of the maximum permissible load voltage 10 V therefore applies for each current value, whereas 500 Ohms would apply exclusively for 20 mA.

2.4 Transmission accuracy

Knick isolation amplifiers are distinguished by partly extraordinarily low transmission errors so that the accuracy requirements of practically all measuring tasks in industrial measuring technology are easily met. The long-term stability of Knick electrical isolators ensures maximum transmission accuracy past the 5-year warranty on Knick electrical isolators.

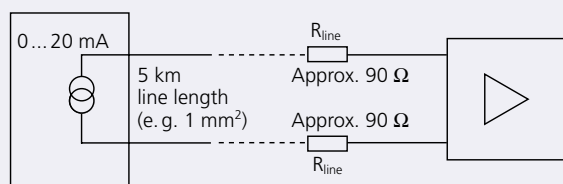

Figure 10: Transmission of a measuring signal across great distances

2.2 Input resistance

The input resistors of modern isolation amplifiers are generally dimensioned in a way that they are of sufficiently high resistance for voltage inputs and of sufficiently low resistance for current

In passive isolators, there is a voltage drop at the input resulting from the natural voltage requirement of the device plus the load voltage at the output. Before passive isolators are used, the load capability of the measuring signal and the load connected to the isolator output should be known.

2.4.1 Measuring signal quality

As accurate a transmission of the input signal as possible is required not only for applications in test engineering. Signal distortions due to change in polarity, overshoots in the case of signal changes, extreme angles in square-wave transmission are the rule in many isolation amplifiers available on the market. These undesirable properties are not immediately visible to the user. They often do not become noticeable until inexplicable errors occur during operation. In the cyclical, digital scanning of measured values, signal distortions, for example, due to overshooting, can cause serious measuring errors. For this reason, Knick traditionally places great emphasis on the accurate transmission of signals in the development of its isolation amplifiers.

2.4.2 Residual ripple

The output signal of DC isolation amplifiers is principally superimposed by low interference voltages. These interference voltages are caused, for example, by the chopper frequency as well as by mains feedover. The amplitude of this interference voltage, referred to as residual ripple, should be as low as possible because otherwise measuring errors cannot be ruled out – especially with low modulation.

2.5 Temperature coefficient (gain droop)

The temperature coefficient or gain droop is a specification for changes in gain caused by temperature changes. Droop rates are specified as a relative variable in %/K or as an absolute value, for example, in nA/K or $\mu\text{A}/\text{K}$.

In absolute value specifications, you need to check whether the TC refers to the input or the output.

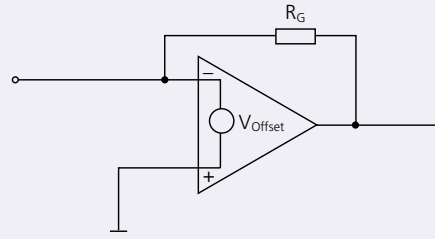

Figure 11: Offset voltage

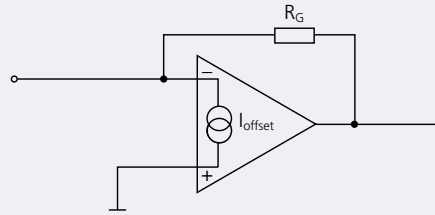

Figure 12: Offset current

Examples:

The temperature coefficient (at the output) of an isolation amplifier is, for example, max. 10 nA/K. A change in temperature of 20 K causes a change in the output current of $20 \times 10 \text{ nA} = 200 \text{ nA}$.

The TC of an isolation amplifier is, for example, 0.0025 %/K. A change in temperature of 20 K causes a change in amplification of 0.05 %.

2.6 Offset voltage, offset current

In (real) amplifiers, the output variable is not exactly '0' even when the input signal is '0'.

The (input) offset voltage of an amplifier is by definition (gain-independent) the voltage that needs to be applied to the input in order for the output variable to become '0'.

It therefore acts as an input voltage or an additional voltage acting in series with the input signal (see Figure 11).

The (input) offset current of an amplifier also acts as an additional input signal (see Figure 12). In amplifiers with a voltage input, the offset current generates a voltage drop at the internal resistor of a voltage source that is added to the input signal.

The offset voltage and offset current are so low in Knick isolation amplifiers that they are negligible for normal applications. Offset influences should only be considered for very special applications, for example, the 1:1 transmission of very small measuring signals or the transmission or amplification of very high-resistance signals.

The polarity of offset variables depends on each model and therefore is given as an amount variable without a plus or minus sign.



2.7 Cut-off frequency

DC isolation amplifiers are basically designed for the transmission or amplification of DC signals. In order to be able to transmit fast changes in the measured value almost without delay, DC isolation amplifiers are only conditionally suitable for transmission of alternating variables. The upper cut-off frequency for Knick isolation amplifiers and DC transformers is up to approx. 12 kHz for sinusoidal signals depending on the model.

As an upper limit frequency, as is common in electronics and telecommunications, the frequency is defined at which the gain is attenuated by 3 dB (in relation to the DC gain) or which corresponds to the amount divided by $\sqrt{2}$ (corresponding to approx. 71 % of the DC gain) (see Figure 13).

2.8 Common-mode behavior

If the same voltage V_{cm} is applied to ground at both inputs of a (symmetrical) amplifier, the input voltage remains $V_{in} = 0$. This operating mode is called common-mode modulation. In an ideally symmetrical amplifier, the output voltage V_{out} would also remain at 0. This is not the case in real amplifiers, however, i. e. a voltage deviating from 0 will appear at the output (see Figure 14). A common-mode modulation always exists when the signal voltage is not at ground potential, i. e. when there is a potential difference between the (two) input lines and the ground, for example, in voltage measurements on a shunt lying at a high potential against ground.

Common-mode voltages can also occur as common-mode interference voltages, for example, in switching processes, due to interference on the signal lines or due to compensating currents.

The ratio between an applied common-mode voltage and the resulting output voltage is known as common-mode gain. However, in practice, the deviation from the ideal common-mode behavior of an amplifier that is indicated as common-mode rejection is of greater interest. The common-mode rejection S is defined as a quotient between opposite-mode and common-mode gain or as the (logarithmic) ratio between an applied common-mode voltage V_{cm} and a signal voltage V_d that would produce the same output signal.

$$S = 20 \cdot \log (V_{cm}/V_d) \text{ [dB]}$$

Example:

The common-mode modulation of an isolation amplifier with $V_{cm} = 800 \text{ V}$ causes a 'common-mode error' (at the input) of $800 \text{ V}/10 (120/20) = 0.8 \text{ mV}$ with a common-mode rejection of 120 dB. In an isolation amplifier with an input sensitivity of 60 mV, this results in a 'common-mode error' of approx. 1.3 % of the end of range value.

For common-mode voltages in the DC and low-frequency AC range (50 Hz), high common-mode rejection is usually easy to achieve. The common-mode error in this range is negligible in Knick isolation amplifiers.

The common-mode rejection of amplifiers is, however, frequency-dependent and becomes considerably lower as the frequency increases. This is essentially influenced by the coupling capacitance between the primary and secondary coils of the transformer used that cannot be reduced as desired.

Therefore the common-mode rejection is considerably lower with pulse-shaped common-mode voltages or fast common-mode voltage changes.

Transient common-mode voltages can be caused both by single and by periodic switching processes, for example, in thyristor-controlled convertors.

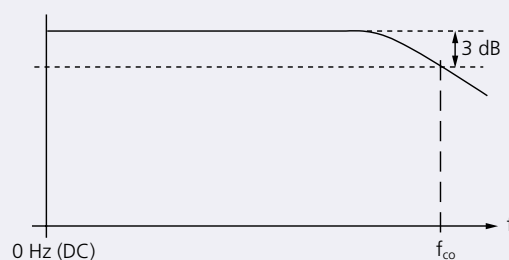

■ Bild 13: Frequency response of a DC isolation amplifier or Loop-powered isolator

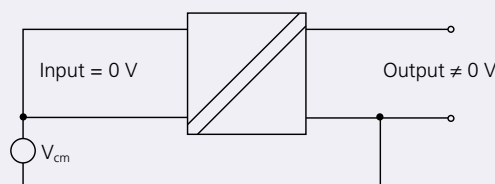

■ Bild 14: Common-mode modulation

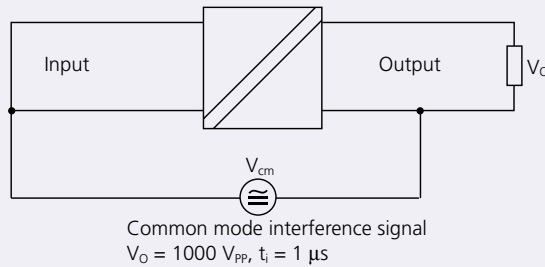

■ Figure 15: Test circuit for measuring the T-CMR

In the IsoAmp® 23000/24000 series isolation amplifiers, special constructional measures have been implemented to suppress this kind of common-mode pulse.

These isolation amplifiers are therefore particularly suited for measurements on shunts with which common-mode pulse voltages or rapidly changing common-mode voltages are to be expected.

The term T-CMR (Transient Common Mode Rejection) has been chosen for the corresponding data specification. It describes the quotient between differential DC gain and common-mode gain of a transient (interference) signal with a rise speed of 1000 V/μs (see Figure 15).

■ 3. Power supply

The universal and standard signal isolation amplifiers VariTrans® P 15000, VariTrans® A 26000 and VariTrans® P 27000 are equipped with the VariPower® broad-range power supply that is designed for supply voltages of 20 ... 253 V AC/DC. These isolation amplifiers are therefore suitable for connection to almost all mains supplies and can be used all over the world. This hugely simplifies storage and spare parts management.

Another advantage of the broad-range power supply is the insensitivity to mains voltage fluctuations within the specified range.

Other Knick isolation amplifiers in modular cases are supplied as standard for a supply voltage of 230 V AC, but are also available for the supply voltages 110 V AC, 24 V AC, 24 V DC and partly also for 60 V DC and 110 V DC.

3.1 Power requirement

A frequently neglected and often underestimated selection criterion is the power requirement of isolation amplifiers. It is not the additional energy required that is decisive, but the heat generated in the isolation amplifiers with unnecessarily high energy requirement due to the power loss. This disadvantage can have adverse effects especially in the case of high packing densities. The development of heat in isolation amplifiers is sometimes so great that these devices cannot be mounted next to each other without spacing. This cancels out the advantages of small dimensions. Another consequence of high temperatures is the reduced service life of the electronic components. A 10 K higher operating temperature in the range between 40 °C and 50 °C (theoretically) causes the service life to be reduced by 50 % and thus lowers product reliability considerably.

The power requirement of isolation amplifiers is therefore one selection criterion that should not be ignored. Since the output power of different isolation amplifiers is generally almost identical, the power requirement of different brands can be compared directly.

3.2 Potential isolation of the power supply circuit

3-port isolation is the technical standard for all Knick isolation amplifiers for mains supply, i. e. the input, output and power supply circuit are galvanically isolated from each other. In 3-port isolation amplifiers, the input and output circuits can be applied to any potentials taking the permitted working voltages into consideration. In rare cases, when the output needs to be applied to higher potentials, you should check whether the permitted working voltage (rated isolation voltage, previously isolation voltage) between the output and power supply circuit is sufficiently high.

Among the modular isolation amplifiers the IsoAmp® 11000/12000 series should be noted for having the output current circuit on the potential of the supply voltage. This is not a technical disadvantage for many applications. If floating outputs are absolutely necessary, 3-port isolation is also possible for modules from the IsoAmp® 11000/12000 M series in conjunction with the EK 16 Eurocard.

Some manufacturers who do not supply isolation amplifiers with 3-port isolation as standard distinguish between input isolation amplifiers, output isolation amplifiers and 3-port isolation amplifiers.

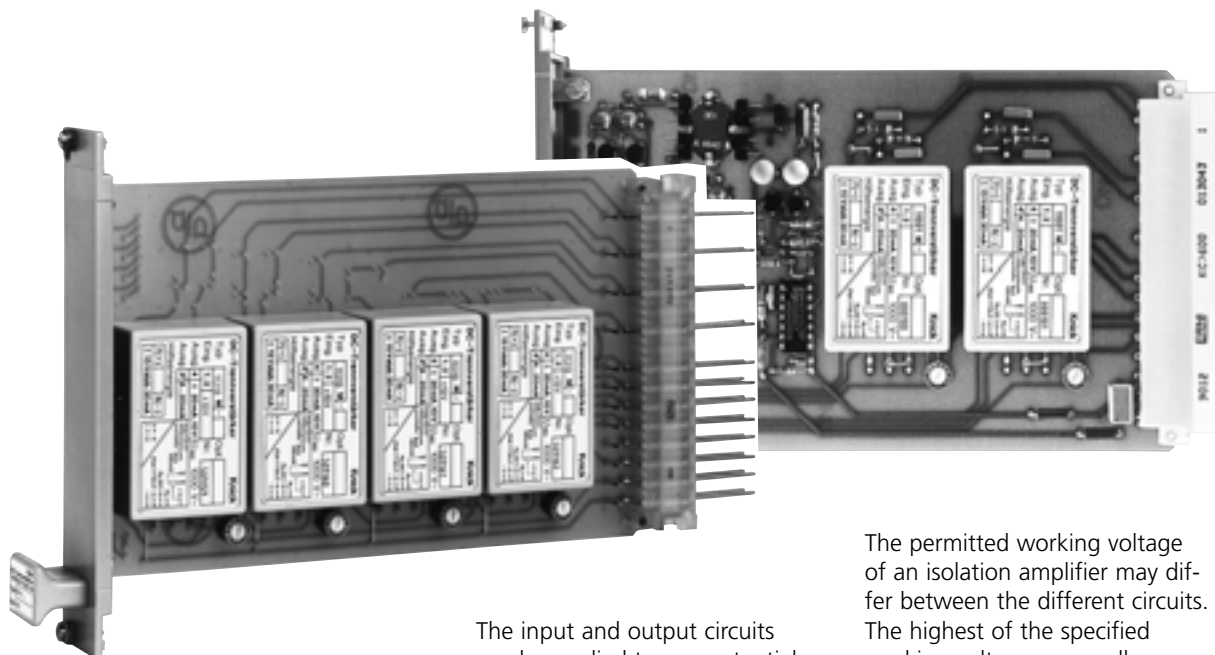

3.2.1 Input isolation amplifiers

In input isolation amplifiers, the input is isolated from all other circuits, the output is at the power supply potential. Input isolation amplifiers are used to isolate an input signal that is at a possibly disturbing or high potential from the output and power supply circuit.

3.2.2 Output isolation amplifiers

In output isolation amplifiers, the input is at the same potential as the power supply. The output signal can be applied to another possibly dangerously high potential.

3.2.3 3-port isolation amplifiers

In 3-port isolation amplifiers, the input, output and power supply circuits are electrically isolated (see Figure 16).

The input and output circuits can be applied to any potentials taking the permitted working voltages into consideration.

As previously mentioned, a distinction need not be made between input and output isolation amplifiers when selecting Knick isolation amplifiers as the 3-port isolation is the technical standard in this field.

4. Electrical safety

4.1 Working voltage

An important parameter when selecting a suitable electrical isolator is the permitted working voltage (rated isolation voltage). It indicates the permitted potential difference between the different circuits (input, output and supply current circuits). (see Figure 17).

The permitted working voltage of an isolation amplifier may differ between the different circuits. The highest of the specified working voltages generally applies across the input and output and across the input and power supply circuit. There can be a lower permitted working voltage between the output and supply current circuit.

The requirements for the working voltages are defined in EN 61010-1.

It should be noted that the permissible working voltage is not only determined by the voltage strength of the permanent insulation used for the isolating elements, but also by constructional features such as clearance and creepage distances as well as by external influences, particularly the pollution degree (environment-related, possible contamination) and the overvoltage category (value of superimposed pulse voltages).

The degree of contamination and overvoltage category are also defined in EN 61010-1. The following classifications apply:

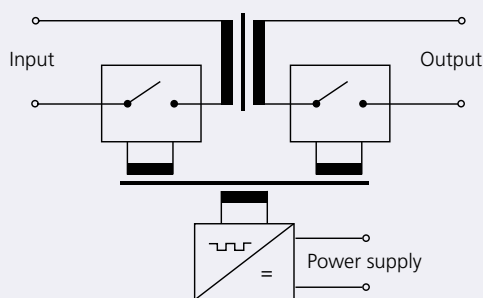
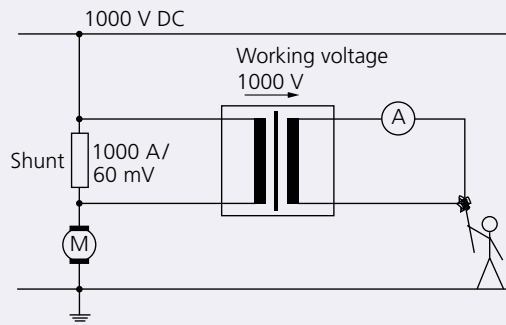

Figure 16: Diagram of typical 3-port isolation amplifier



■ Figure 17: Visual aid model for meaning of working voltage

4.2 Test voltage

The electric strength of the insulation material used for the isolating elements is many times greater than the working voltages permitted for the device. Therefore the test voltage with which each device is tested is specified additionally for isolating devices. This ensures that the specified limit values for the working voltage apply for each device.

The test voltage is also used occasionally as a parameter for the electric strength instead of the working voltage. This then needs to be a certain factor higher than the maximum possible potential difference between the circuits to be isolated according to the guideline for the specific application.

The test voltage for Knick potential isolators is up to 10 kV AC.

Pollution degree 1:

There is no or only dry, non-conductive contamination, for example, in air-conditioned or clean, dry rooms.

Pollution degree 2:

There is only non-conductive contamination. Occasional, temporary conductivity due to condensation can be expected, for example, in laboratories, precision mechanics workshops, test departments and sales-rooms.

Pollution degree 3:

There is conductive contamination or dry, non-conductive contamination that becomes conductive due to expected condensation, for example, in rooms at industrial plants, agricultural plants, unheated warehouse rooms and boiler rooms.

Pollution degree 4:

The contamination leads to permanent conductivity, for example, due to conductive dust, rain or snow; in open rooms or outdoors.

Overvoltage category II:

Systems with switching processes, but without lightning strikes, for example, in private households.

Overvoltage category III:

Plant without lightning strikes, connection of the device nearer to the power supply connection than the loads and/or special requirements for safety and availability of the device.

Overvoltage category IV:

Plants with lightning strikes.

The permitted working voltages for Knick isolation amplifiers and DC transformers are up to approx. 3600 V DC depending on the model.



4.3 Safe electrical isolation

The term 'Safe Electrical Isolation' is defined in EN 61140. This safety standard for protecting people against electrical shock describes measures to achieve the necessary 'safe electrical isolation' in electrical equipment intended for connection to a nominal supply voltage up to 1000 V AC or 1500 V DC.

The implementation of this particularly high level of safety should be ensured both by constructive measures (clearance and creepage distances) and the insulation properties of the isolation elements used internally.

The specification 'Safe Electrical Isolation' always includes the indication of a rated isolation voltage (working voltage). The 'safe electrical isolation' is guaranteed below this voltage. Galvanic isolation is also guaranteed above this voltage up to a higher permitted working voltage.

4.4 Approvals

On an international basis, US and Canadian UL approvals (Under-writer Laboratories) and CSA (Canadian Standards Association) or their combination CUL are required. Many isolators from Knick have proven in strict approval tests that they fulfil these requirements for electrical safety and fire-protection regulations.

4.5 Hazardous area separation

When electrical equipment (including electrical and electronic measuring instruments) is used in potentially explosive atmospheres, you must ensure that these devices cannot ignite any explosive gas-air mixtures even when they malfunction. The possible protection classes include the 'intrinsic safety' type of protection that ensures that

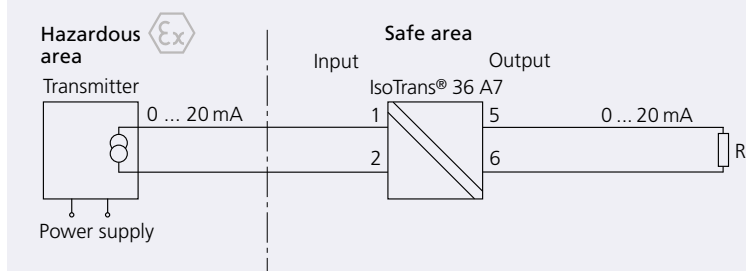

Figure 18: Coupling of intrinsically safe and non-intrinsically safe circuits with the IsoTrans 36 A7 passive isolator

the intrinsically safe circuits in the respective device cannot generate sparks even in the event of a malfunction.

In practice, an isolated solution with intrinsically safe circuits is hardly ever possible, i. e. coupling with non-intrinsically safe circuits is necessary for signal processing. The direct link would cancel out the intrinsic safety and is therefore not permitted. Knick supplies suitable isolation amplifiers or loop-powered DC transformers for coupling the correspond-

ing circuits providing both electrical isolation and hazardous area separation between intrinsically safe and non-intrinsically safe circuits (see Figure 18).

The devices supplied by Knick with 'intrinsic safety' type of protection correspond with the directive 94/9/EC. This directive is generally called ATEX 100a (Atmosphère Explosible and Article 100a).

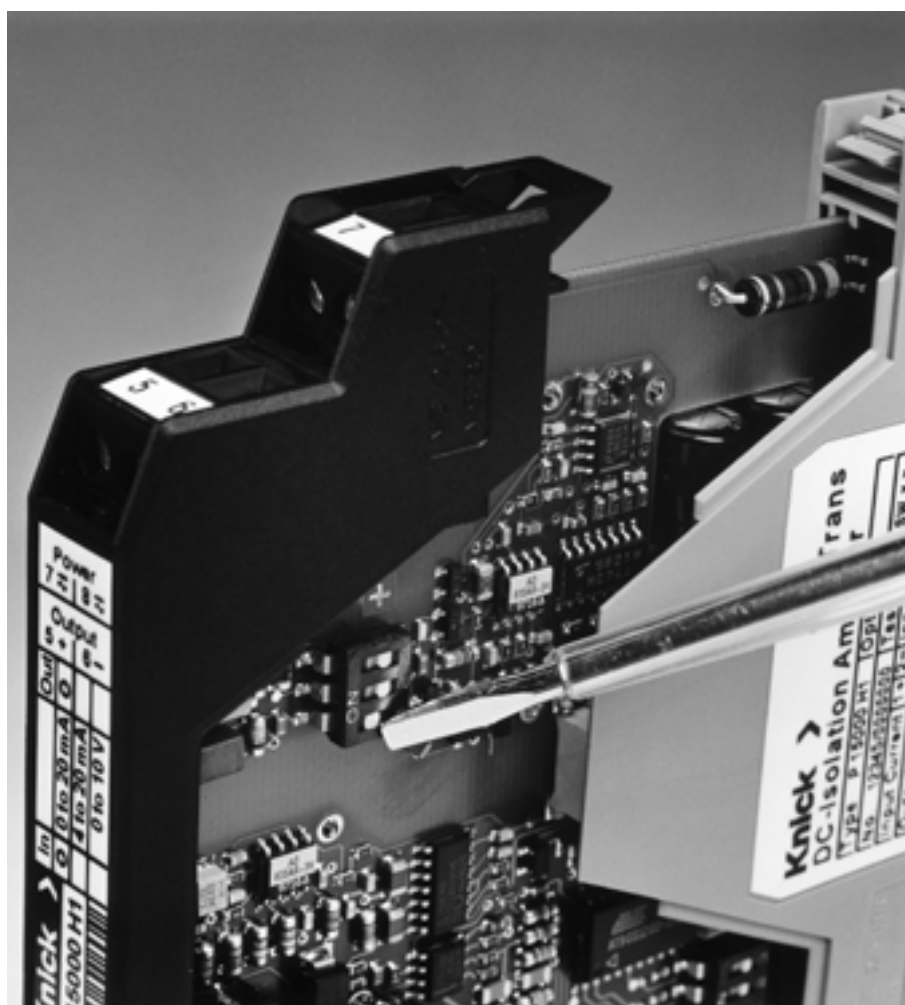

■ 5. Functional safety

5.1 Surge withstand

In industrial plants, transient overvoltages with rise speeds of several 1000 V/ μ s occur in particular due to switching processes. This kind of overvoltage can lead to damage or destruction of sensitive electronic components.

Newly developed Knick isolation amplifiers and DC transformers are surge proof in accordance with IEC 255-4. Both the individual circuits (input, output, supply) and the insulation between the circuits are protected against being destroyed by temporary overvoltages. The test is made with positive and negative pulses of 5 kV with 1.2/50 μ s pulse duration.

5.2 Electromagnetic compatibility (EMC)

The term 'electromagnetic compatibility' defines the property of electrical and electronic devices not to emit intolerable electromagnetic interference and at the same time the capability to work safely under the effect of electromagnetic interference.

The increasing use of all kinds of devices that could emit interference, the constantly increasing use of modern microelectronics in all fields of industry and the interaction of power electronics and microelectronics calls for measures protecting against mutual influence. Electromagnetic interference can cause malfunctions and even complete failure of unprotected electronic devices. The constantly lower energy requirement of microelectronics components and simultaneously increasing processing speeds lead to increased sensitivity to electromagnetic interference.

The limit values to be observed with regard to EMC are regulated, in addition to the requirements to be met, by standardized directives and norms within the European Union. The low-voltage directives and the EMC standards are relevant for isolation amplifiers. The CE certification of Knick products confirms conformity with the respective directives.

5.3 Protection against mechanical loads

Mechanical loads, for example, caused by shaking or vibrations, are often inevitable in industrial plants, in vehicles, on ships etc. The operating safety of electrical and electronic components also needs to be ensured in these environments. The isolation amplifiers from the VariTrans® series have therefore been checked in accordance with the Germanischer Lloyd guidelines and have GL approval for environment category D: Use with increased heat development and increased vibration loading, for example, devices for mounting on combustion engines and compressors.

5.4 Reliability

Knick gives a 5-year warranty on electrical isolation modules. Due to their recognized quality and reliability, they are widespread in industrial measuring and control engineering across the world. The quality management used has also contributed to Knick being certified according to KTA*¹ 1401 as a recognized supplier of isolation amplifiers for use in nuclear power stations since 1994. Other corresponding certifications have also been awarded for products used in the safety-related areas of nuclear power stations.

Intelligent circuits with minimal use of components allow reliability values that were previously considered to be impossible. For example, the MTTF*² is 1800 years for the IsoTrans® 46 Mk.

The Knick quality assurance has been certified according to ISO 9001 for all areas of the company.

The quality of all Knick products is ensured by computer-supported individual checks. For the electrical isolation modules, this means that each individual device is checked again for perfect functioning and compliance with all data after the function check, adjustment, encapsulation where necessary and high-voltage check. Only then is the device approved for delivery.

*¹ Nuclear plants

*² Mean time to failure

Modular Cases

VariTrans® P 27000

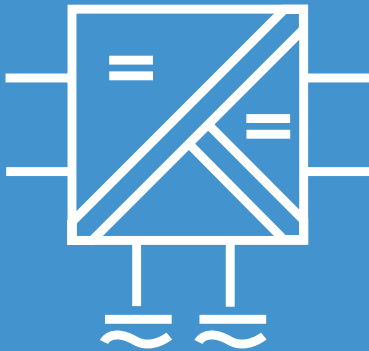

The “Multimeter” among the isolators. With 480 calibrated selectable measuring ranges and broad-range power supply.

The task

A wide range of measuring signals need to be galvanically isolated and converted into standard signals. This applies to any input signals in the range ± 20 mV to ± 200 V and from ± 0.1 mA.

The problem

The variety of tasks results in a large number of different devices.

The solution

The calibrated switching of the input and output ranges using DIP switches allow the Knick

VariTrans® P 27000 professional universal isolation amplifiers to be used without complicated recalibration.

As switchover occurs without expensive and unreliable equipment, the devices can also be easily configured on site.

The broad-range power supply for all common supply voltages from 20 to 253 V AC/DC is unmatched for 12-mm isolators.

To make setting the required input and output ranges simple and user friendly, we supply a free software tool called VariSoft® to support the user. VariSoft® shows you the correct DIP switch position when you enter the required input and output ranges and has a print option for your documentation.

You can download VariSoft® free of charge from our website.

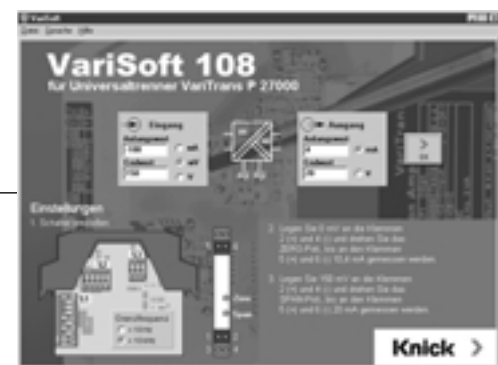

Warranty
5 years!

Defects occurring within 5 years from delivery are remedied free of charge at our plant (carriage and insurance paid by sender).

The enclosure

At just 12.5 mm wide, the modular case with pluggable screw terminals allows simple and fast assembly and prewiring of switch cabinets. Cases with fixed screw terminals are also available for extremely high mechanical loads. The easy-to-open case allows easy configuration of the input and output ranges and good protection against touch and unintended adjustment.

The advantages

The analog transmission of the measuring signal with transformer isolation and the new digitally controlled range selection guarantee almost perfect signal transmission:

- Gain error only 0.08 %
- Excellent pulse formation
- Extremely low residual ripple
- Maximum long-term stability and reliability

The technology

A microcontroller monitors the control element settings and controls the calibrated range selection. Interference to the signal transmission – for example, contact resistances in the range switches – is thus ruled out.

Thanks to the VariPower® power supply, the devices can be used all over the world with almost any power supply. The extremely low power consumption and the related minimal self-heating significantly increase the reliability. That's why we give a 5-year warranty.

The facts

- **Flexible and highly accurate**
calibrated range selection without complicated recalibration
- **VariPower®**
20 ... 253 V AC/DC
broad-range power supply
- **Extremely compact design**
12.5 mm modular case, up to 80 active isolators per meter of top hat rail
- **Fast and easy configuration**
case simple to open
- **Pluggable screw terminals**
simple, time-saving assembly and prewiring of switch cabinets
- **3-port isolation**
protection against incorrect measurements or damage
- **Maximum accuracy**
- **Individual test report**
following EN 10204 2.3
- **Safe isolation**
in accordance with EN 61140. Protection against high voltages (for example, with shunt measurements on high potentials or in 3-phase systems).
- **Maximum reliability**
no repair and failure costs
- **5-year warranty**

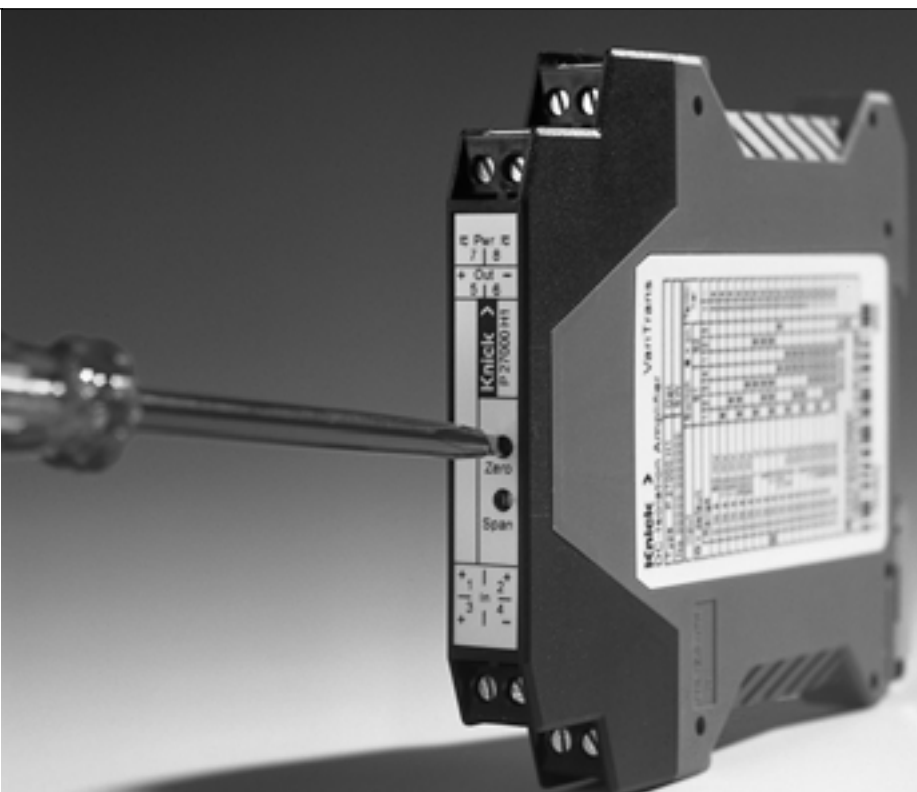

Product line

Devices

Devices			Order no.	Order no.
	Input	Output	With pluggable screw terminal	With fixed screw terminal
P 27000 with adjustable input and output	0 ... ±20 mV/200 V, 0 ... ±0.1 mA/100 mA	0 ... 20 mA 4 ... 20 mA 0 ... 10 V 0 ... ±10 V 0 ... ±20 mA	P 27000 H1	P 27000 F1
P 27000 with fixed settings	0 ... ±20 mA 0 ... ±20 mA 0 ... ±60 mV 0 ... 60 mV 0 ... ±60 mV 0 ... ±150 mV 0 ... 150 mV 0 ... ±150 mV 0 ... ±300 mV 0 ... 300 mV 0 ... ±300 mV 0 ... ±500 mV 0 ... 500 mV 0 ... ±500 mV 0 ... ±1 V 0 ... 1 V 0 ... ±1 V 0 ... ±10 V 0 ... ±10 V	0 ... ±20 mA 0 ... ±10 V 0 ... ±20 mA 4 ... 20 mA 0 ... ±10 V 0 ... ±20 mA 4 ... 20 mA 0 ... ±10 V 0 ... ±20 mA 4 ... 20 mA 0 ... ±10 V 0 ... ±20 mA 4 ... 20 mA 0 ... ±10 V 0 ... ±20 mA 4 ... 20 mA 0 ... ±10 V 0 ... ±20 mA 4 ... 20 mA 0 ... ±10 V	P 27016 H1 P 27018 H1 P 27056 H1 P 27057 H1 P 27058 H1 P 27066 H1 P 27067 H1 P 27068 H1 P 27076 H1 P 27077 H1 P 27078 H1 P 27086 H1 P 27087 H1 P 27088 H1 P 27096 H1 P 27097 H1 P 27098 H1 P 27036 H1 P 27038 H1	P 27016 F1 P 27018 F1 P 27056 F1 P 27057 F1 P 27058 F1 P 27066 F1 P 27067 F1 P 27068 F1 P 27076 F1 P 27077 F1 P 27078 F1 P 27086 F1 P 27087 F1 P 27088 F1 P 27096 F1 P 27097 F1 P 27098 F1 P 27036 F1 P 27038 F1

Power supply

20 ... 253 V AC/DC

Specifications

Input data

Inputs	P 27000 H1/F1:	Factory setting ± 10 V	
	Voltage	Configurable from 20 mV ... 200 V and switchable in calibrated steps 60 mV, 100 mV, 150 mV, 300 mV, 500 mV, 1 V, 5 V, 10 V, 100 V, unipolar/bipolar	
	Current	Configurable from 0.1 mA ... 100 mA and switchable in calibrated steps 1 mA, 5 mA, 10 mA, 20 mA, 50 mA, unipolar/bipolar and 4 ... 20 mA ¹⁾	
Input resistance	Current input	Ranges ≤ 5 mA	approx. 100 Ohms
		Ranges > 5 mA	approx. 5 Ohms
	Voltage input		approx. 1 MOhm
Overload	Current input	Ranges ≤ 5 mA	≤ 100 mA
		Ranges > 5 mA	≤ 300 mA
	Voltage input	Ranges ≤ 500 mV	Limitation with suppressor diode 36 V, max. permitted continuous current ≤ 20 mA
		Ranges > 500 mV	Limitation with suppressor diode 250 V, max. permitted continuous current ≤ 3 mA

Output data

Output	P 27000 H1/F1: Factory setting ± 10 V 20 mA, 5 V, 10 V unipolar/bipolar and 4 ... 20 mA, 1 ... 5 V and 2 ... 10 V calibrated selection		
Offset	-100 %, -50 %, 0 %, 50 %, 100 % span of selected output range calibrated selection		
Load	With output current	≤ 12 V (600 Ohms at 20 mA)	
	With output voltage	≤ 10 mA (1 kOhm at 10 V) ²⁾	
Offset error	20 μ A or 10 mV		
Residual ripple	< 10 mV _{rms}		

Transmission behavior

Adjustment range of ZERO potentiometer	± 25 % span of selected output range		
Adjustment range of SPAN potentiometer	0.33 ... 3.30 x end value of selected input range (max. $V_{in} = 200$ V)		
Gain error	< 0.08 % meas. val.		
Cut-off frequency	P 27000 H1/F1: > 10 kHz, < 10 Hz switchable -3 dB, fixed-setting models > 10 kHz -3 dB		
Temperature coefficient ³⁾	< 0.005 %/K full scale (reference temperature 23 °C)		

1) Input 4 ... 20 mA: Offset switching not calibrated

2) Higher output load on request

3) Average TC in specific working temperature range -10 °C ... +70 °C

Specifications, continued

Power supply

Power supply	20 ... 253 V AC/DC; AC 48 ... 62 Hz, approx. 2 VA; DC approx. 0.9 W
--------------	---

Isolation

Galvanic isolation	3-port isolation between input, output and power supply
--------------------	---

Test voltage	5 kV AC input against output; 4 kV AC output against power supply
--------------	---

Working voltage (basic isolation)	1000 V AC/DC with overvoltage category II and pollution degree 2 according to EN 61010-1. For applications with high working voltages, you should ensure there is sufficient spacing or isolation from neighboring devices and protection against electrical shocks.
--------------------------------------	---

Protection against electrical shock	Safe isolation according to EN 61140 (VDE 0140 Part 1) by reinforced insulation in accordance with EN 61010-1 (VDE 0411 Part 1). Working voltages with overvoltage category II and pollution degree 2 for working voltages: up to 600 V AC/DC across input and output up to 300 V AC/DC across output and power supply up to category II and degree 2 For applications with high working voltages, you should ensure there is sufficient spacing or isolation from neighboring devices and protection against electrical shocks.
--	---

Standards and approvals

Surge withstand	5 kV 1.2/50 μ s according to IEC 255-4
-----------------	--

EMC ⁴⁾	EN 61326
-------------------	----------

Approvals	cUL: File No. E 216767, Standards UL 3101-1, CSA-C 22.2, No. 10101-1 GL: No. 14593-99 HH KTA: Applied for
-----------	---

Other data

Ambient temperature	Operation: -10 ... +70 °C Transport and storage: -40 ... +85 °C
---------------------	--

Version	Modular case, width 12.5 mm, see dimension drawing for other measurements, pluggable screw terminals: Type H1 fixed screw terminals: Type F1
---------	--

Protection class	IP 20
------------------	-------

Mounting	Metal lock for mounting on 35 mm top hat rail according to EN 50022 See dimension drawings for conductor cross section
----------	---

Weight	Approx. 150 g
--------	---------------

4) Slight deviations are possible while there is interference

Schematic diagram

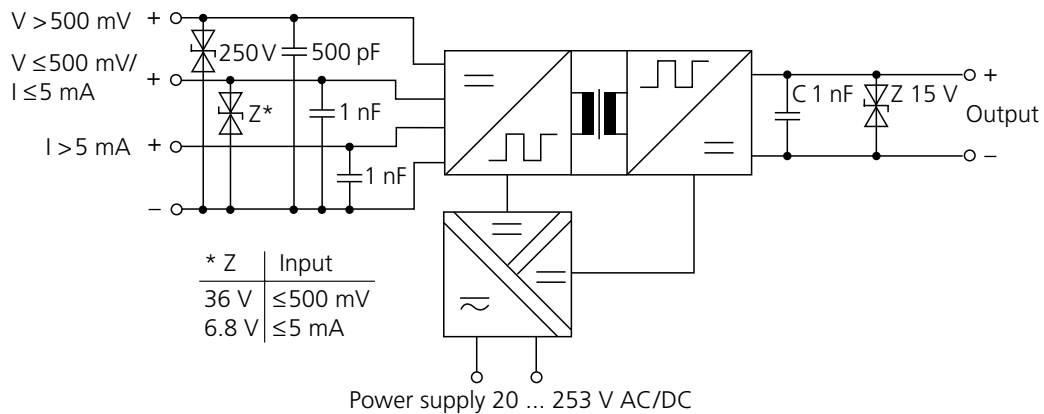

Application examples

Electrical isolation

For safe coupling of the measuring signals to the evaluation electronics

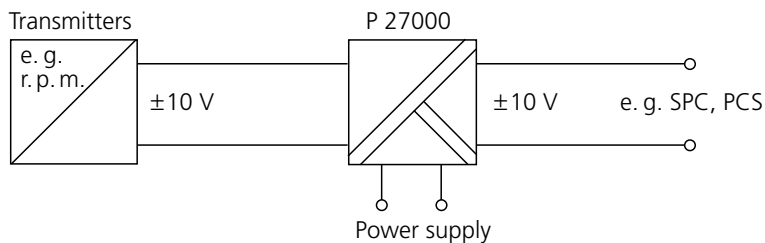

Signal conversion or measuring range adaptation

For conversion of any measuring signals into standard signals 10 V or 20 mA

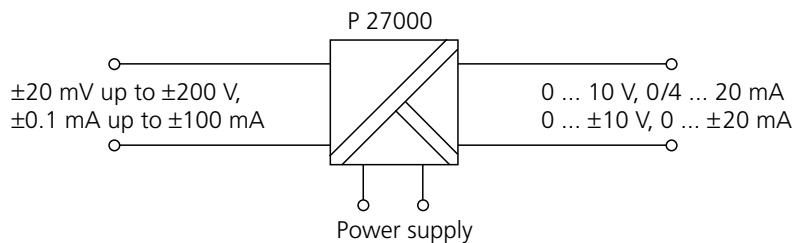

Application examples, continued

Simple shunt measurement

e. g. also with any overload range setting

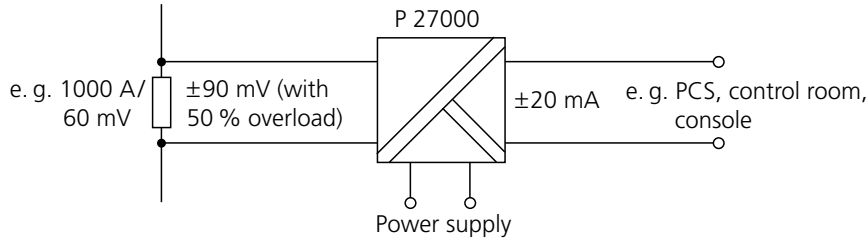

Electrical isolation

For safe coupling of the measuring signals to the evaluation electronics

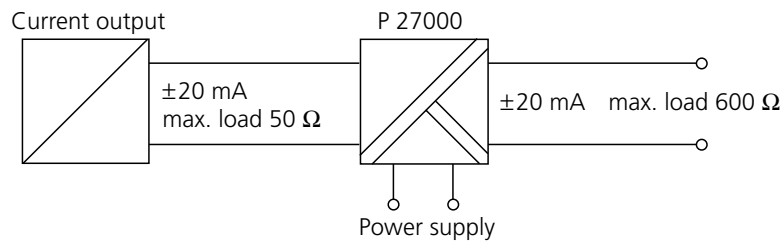

Dimension drawings and terminal assignments

Enclosure with pluggable screw terminals

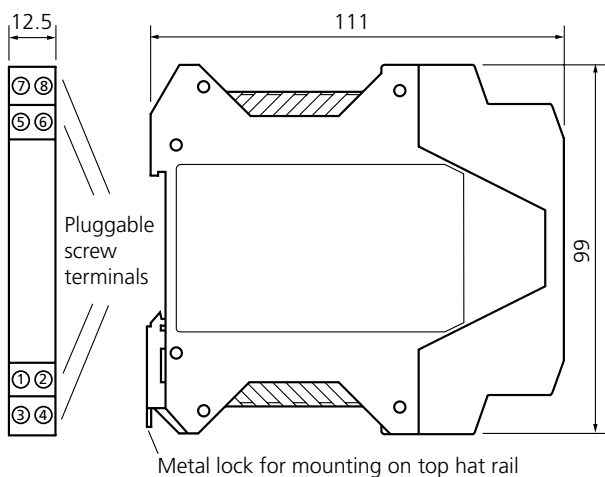

Enclosure with fixed screw terminals

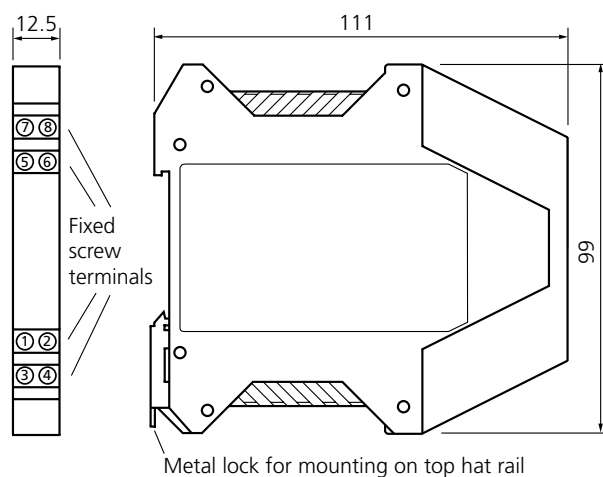

Terminal assignments

- 1 Input + Current > 5 mA
- 2 Input + Current ≤ 5 mA, voltage ≤ 500 mV
- 3 Input + Voltage > 500 mV
- 4 Input -

- 5 Output +
- 6 Output -
- 7 Power supply ≈
- 8 Power supply ≈

All dimensions in mm.

Conductor cross section max. 2.5 mm²

Multi-wire connection max. 1 mm² (two wires with the same cross section)

VariTrans® A 26000

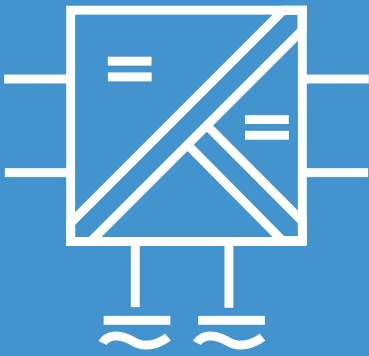

The specialist for ± 10 V / ± 20 mA. With calibrated range selection and broad-range power supply.

The task

The transmission and conversion of standard 0 ... ± 20 mA and 0 ... ± 10 V signals frequently used in industry, for example, for speed monitoring with tachogenerators.

The problems

Measuring errors occur due to potential differences when bipolar measuring signals are transmitted. In addition, the signal adaptation previously required calibration of the isolators.

The solution

Knick provides a tailor-made solution. The calibrated switching of the input and output ranges using DIP switches allows the Knick VariTrans® P 26000 universal isolation amplifiers to be used without complicated recalibration. The broad-range power supply for all common supply voltages from 20 to 253 V AC/DC is unmatched in this kind of compact modular case.

The enclosure

At just 12.5 mm wide, the modular case with pluggable screw terminals allows simple and fast assembly and prewiring of switch cabinets. Cases with fixed screw terminals are also available for extremely high mechanical loads. The easy-to-open case allows easy configuration of the input and output ranges and good protection against touch and unintended adjustment.



Warranty
5 years!

Defects occurring within 5 years from delivery are remedied free of charge at our plant (carriage and insurance paid by sender).

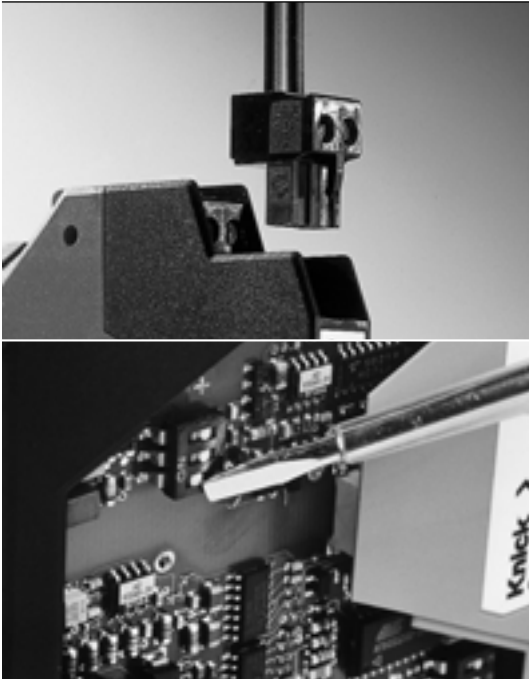

The advantages

The analog transmission of the measuring signal with transformer isolation and the digitally controlled measuring range selection guarantees excellent signal transmission:

- Gain error only 0.1 %
- Excellent pulse formation
- Extremely low residual ripple
- Maximum long-term stability and reliability

The technology

A microcontroller monitors the control element settings and controls the calibrated measuring range selection. Interference to the signal transmission – for example, contact resistances in the range switches – is thus ruled out.

Thanks to the VariPower® power supply, the devices can be used all over the world with almost any power supply. The extremely low power consumption and the related minimal self-heating significantly increase the reliability. That's why we give a 5-year warranty.

The facts

- **Flexible and highly accurate** calibrated range selection without complicated recalibration
- **VariPower®**
20 ... 253 V AC/DC
broad-range power supply
- **Extremely compact design**
12.5 mm modular case, up to 80 active isolators per meter of top hat rail
- **Fast and easy configuration**
case simple to open
- **Pluggable screw terminals**
simple, time-saving assembly and prewiring of switch cabinets
- **3-port isolation**
protection against incorrect measurements or damage
- **Maximum accuracy**
- **Individual test report**
following EN 10204 2.3
- **Safe isolation**
in accordance with EN 61140 (VDE 0140), protection against unpermitted high voltages
- **Maximum reliability**
no repair and failure costs
- **5-year warranty**



Product line

Devices			Order no.	Order no.
	Input	Output	With pluggable screw terminal	With fixed screw terminal
A 26000 with calibrated input and output selection	0 ... ±20 mA, 0 ... ±10 V	0 ... ±20 mA, 0 ... ±10 V	A 26000 H1	A 26000 F1
A 26000 with fixed settings	0 ... ±20 mA	0 ... ±20 mA	A 26016 H1	A 26016 F1
	0 ... ±20 mA	0 ... ±10 V	A 26018 H1	A 26018 F1
	0 ... ±10 V	0 ... ±20 mA	A 26036 H1	A 26036 F1
	0 ... ±10 V	0 ... ±10 V	A 26038 H1	A 26038 F1
Power supply				
20 ... 253 V AC/DC				

Specifications

Input data

Inputs	0 ... ±20 mA 0 ... ±10 V	Terminal selectable / switchable (factory setting ±10 V) or fixed settings (see Product line)
Input resistance	Current input Voltage input	Voltage drop approx. 250 mV at 20 mA approx. 1 MOhm
Overload	Current input Voltage input	≤ 300 mA Voltage limitation with suppressor diode 30 V, max. permitted continuous current 30 mA

Output data

Outputs	0 ... ±20 mA 0 ... ±10 V	Terminal-selectable/switchable (factory setting ±10 V) or fixed settings (see Product line)
Load	With output current With output voltage	≤ 10 V (500 Ohms at 20 mA) ≤ 10 mA (1 kOhm at 10 V) ¹⁾
Offset	20 µA or 10 mV	
Residual ripple	< 10 mV _{rms}	

Transmission behavior

Gain error	< 0.1 % meas. val.
Cut-off frequency	> 5 kHz -3 dB
Temperature coefficient ²⁾	0.0075 % /K full scale (reference temperature 23 °C)

1) Higher output load on request

2) Average TC in specific operating temperature range -10 °C ... +70 °C

Specifications, continued

Power supply

Power supply	20 ... 253 V AC/DC	AC 48 ... 62 Hz, approx. 2 VA DC approx. 0.9 W
--------------	--------------------	---

Isolation

Galvanic isolation	3-port isolation between input, output and power supply	
Test voltage	4 kV AC input against output against power supply	
Working voltage (basic isolation)	1000 V AC/DC with overvoltage category II and pollution degree 2 according to EN 61010-1. For applications with high working voltages, you should ensure there is sufficient spacing or isolation from neighboring devices and protection against electrical shocks.	
Protection against electrical shock	Safe isolation according to EN 61140 by reinforced insulation in accordance with EN 61010-1. Working voltages up to 300 V AC/DC with overvoltage category II and pollution degree 2 between input and output and power supply. For applications with high working voltages, you should ensure there is sufficient spacing or isolation from neighboring devices and protection against electrical shocks.	

Standards and approvals

Surge withstand	5 kV 1.2/50 µs according to IEC 255-4	
EMC ³⁾	EN 61326	
Approvals	cUL: File no. E 216767, Standards UL 3101-1, CSA-C 22.2, No. 10101-1 GL: No. 14593-99 HH	

Other data

Ambient temperature	Operation: -10 ... +70 °C Transport and storage: -40 ... +85 °C
Enclosure	Modular case, width 12.5 mm, see dimension drawing for other measurements, pluggable screw terminals: Type H1 fixed screw terminals: Type F1
Protection class	IP 20
Mounting	Metal lock for mounting on 35 mm top hat rail according to EN 50022 See dimension drawings for conductor cross section
Weight	Approx. 150 g

3) Slight deviations are possible while there is interference

Schematic diagram

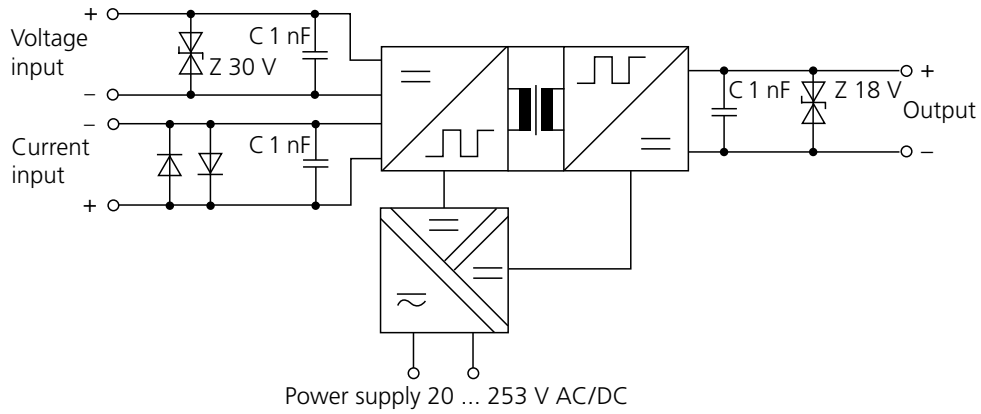

Application examples

Electrical isolation

For safe coupling of the measuring signals to the evaluation electronics

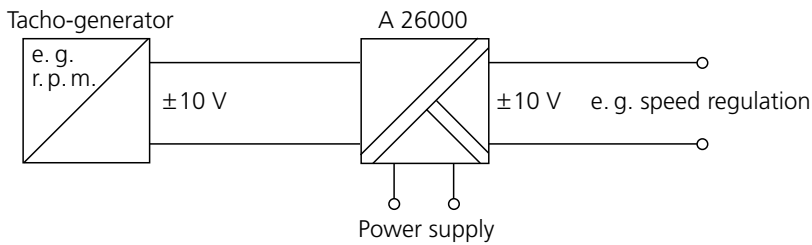

Signal conversion

For conversion of voltage signals into current signals, for example, for interference-free signal transmission over long distances

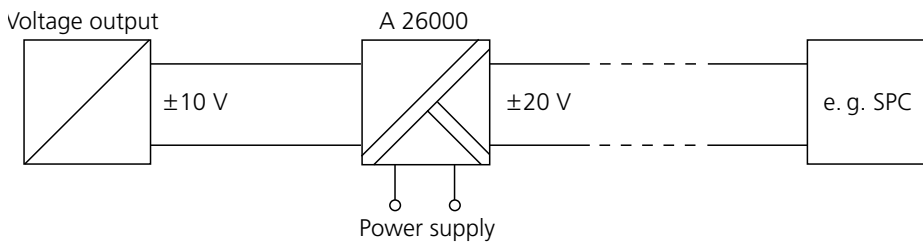

Dimension drawings and terminal assignments

Case with pluggable screw terminals

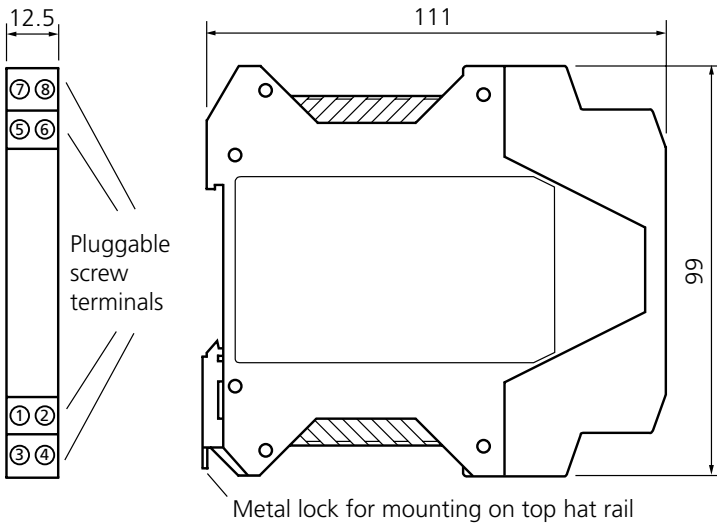

Case with fixed screw terminals

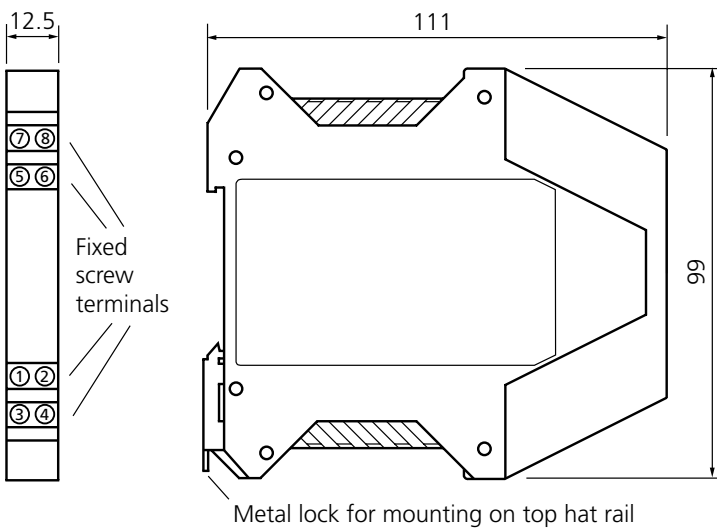

Terminal assignments

- 1 Input + Current
- 2 Input - Current
- 3 Input + Voltage
- 4 Input - Voltage
- 5 Output +
- 6 Output -
- 7 Power supply ≈
- 8 Power supply ≈

Conductor cross section max. 2.5 mm²

Multi-wire connection max. 1 mm²
(two wires with same cross section)

All dimensions in mm.

VariTrans® P 15000

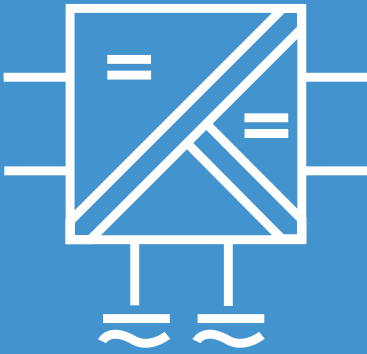

The professional standard-signal isolation amplifier. With calibrated range selection and a broad-range power supply.

The task

Industrial applications require the transmission and conversion of different standard signals (0 ... 20 mA, 4 ... 20 mA and 0 ... 10 V) with high accuracy.

The problems

Long transmission paths can cause potential differences that lead to errors in the measuring result. Furthermore different products would be required for different signals and supply voltages.

The solution

The VariTrans® P 15000 isolation amplifier from Knick features excellent transmission quality combined with the calibrated standard signal switching using DIP switches and a broad-range power supply.

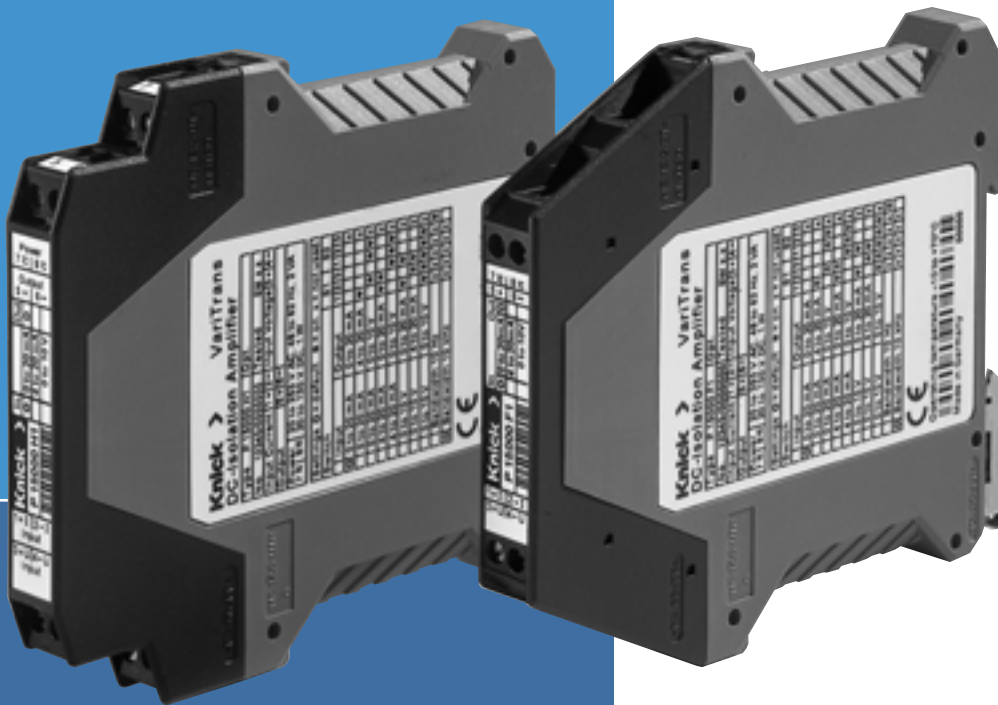

Warranty
5 years!

Defects occurring within 5 years from delivery are remedied free of charge at our plant (carriage and insurance paid by sender).

The enclosure

At just 12.5 mm wide, the modular case with pluggable screw terminals allows simple and fast assembly and prewiring of switch cabinets. Cases with fixed screw terminals are also available for extremely high mechanical loads. The easy-to-open case allows easy configuration of the input and output ranges and good protection against touch and unintended adjustment.

The advantages

The analog transmission of the measuring signal with transformer isolation and the new digitally controlled measuring range selection guarantee almost perfect signal transmission:

- Gain error only 0.08 %
- Excellent pulse formation
- Extremely low residual ripple
- Maximum long-term stability and reliability

The technology

A microcontroller monitors the control element settings and control the calibrated measuring range switching. Interference to the signal transmission – for example, contact resistances in the range switches – is thus ruled out.

Thanks to the VariPower® power supply, the devices can be used all over the world for all common supply voltages from 20 to 253 V AC/DC with almost any power supply. The extremely low power consumption and the related minimal self-heating significantly increase the reliability. That's why we give a 5-year warranty.

The facts

- **Flexible and highly accurate**
calibrated range selection without complicated recalibration
- **VariPower®**
20 ... 253 V AC/DC
broad-range power supply
- **Extremely compact design**
12.5 mm modular case, up to 80 active isolators per meter of top hat rail
- **Fast and easy configuration**
case simple to open
- **Pluggable screw terminals**
simple, time-saving assembly and prewiring of switch cabinets
- **3-port isolation**
protection against incorrect measurements or damage
- **Maximum accuracy**
- **Individual test report**
following EN 10204 2.3
- **Safe isolation**
in accordance with EN 61140, protection against unpermitted high voltages
- **Maximum reliability**
no repair and failure costs
- **5-year warranty**

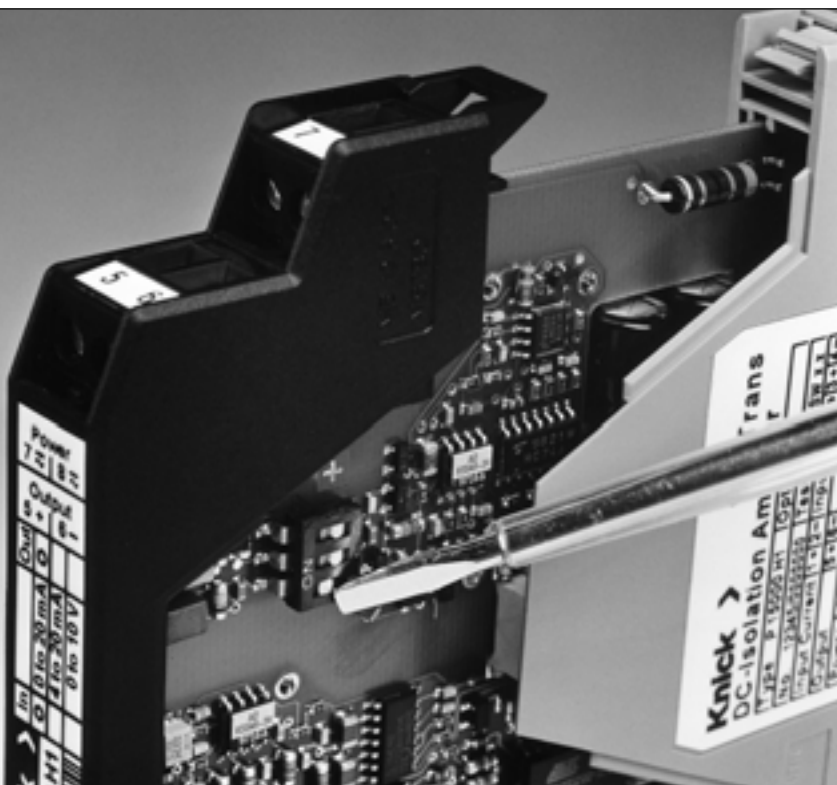

Product line

Devices			Order no.	Order no.
	Input	Output	With pluggable screw terminal	With fixed screw terminal
P 15000 with calibrated input and output selection	0 ... 20 mA, 4 ... 20 mA, 0 ... 10 V	0 ... 20 mA, 4 ... 20 mA, 0 ... 10 V	P 15000 H1	P 15000 F1
P 15000 with fixed settings	0 ... 20 mA	0 ... 20 mA	P 15016 H1	P 15016 F1
	0 ... 20 mA	4 ... 20 mA	P 15017 H1	P 15017 F1
	0 ... 20 mA	0 ... 10 V	P 15018 H1	P 15018 F1
	4 ... 20 mA	0 ... 20 mA	P 15026 H1	P 15026 F1
	4 ... 20 mA	4 ... 20 mA	P 15016 H1	P 15016 F1
	4 ... 20 mA	0 ... 10 V	P 15028 H1	P 15028 F1
	0 ... 10 V	0 ... 20 mA	P 15036 H1	P 15036 F1
	0 ... 10 V	4 ... 20 mA	P 15037 H1	P 15037 F1
	0 ... 10 V	0 ... 10 V	P 15038 H1	P 15038 F1

Power supply

20 ... 253 V AC/DC

Specifications

Input data

Inputs	0 ... 20 mA 4 ... 20 mA 0 ... 10 V	Terminal-selectable/switchable (factory setting 0 ... 20 mA) or fixed settings (see Product line)
Input resistance	Current input Voltage input	Voltage drop approx. 250 mV at 20 mA approx. 1 MOhm
Overload	Current input Voltage input	≤ 300 mA Voltage limitation with suppressor diode 30 V, max. permitted continuous current 30 mA

Output data

Outputs	0 ... 20 mA 4 ... 20 mA 0 ... 10 V (transmission of negative measuring signals up to approx. -5 % of full scale)	Switchable (factory setting 0 ... 20 mA) or fixed settings (see Product line)
Load	With output current With output voltage	≤ 12 V (600 Ohms at 20 mA) ≤ 10 mA (1 kOhm at 10 V) ¹⁾
Offset	20 μA or 10 mV	
Residual ripple	< 10 mV _{rms}	

1) Higher voltage output load on request

Specifications, continued

Transmission behavior

Gain error	< 0.08 % meas. val.
Cut-off frequency	> 10 kHz –3 dB, P 15000 F1/H1 auf < 10 Hz –3 dB switchable
Temperature coefficient ²⁾	0.005 %/K full scale (reference temperature 23 °C)

Power supply

Power supply	20 ... 253 V AC/DC AC 48 ... 62 Hz, approx. 2 VA DC approx. 0.9 W
--------------	---

Isolation

Galvanic isolation	3-port isolation between input, output and power supply
Test voltage	4 kV AC input against output against power supply
Working voltage (basic isolation)	1000 V AC/DC with overvoltage category II and pollution degree 2 according to EN 61010-1. For applications with high working voltages, you should ensure there is sufficient spacing or isolation from neighboring devices and protection against electrical shocks.
Protection against electrical shock	Safe isolation according to EN 61140 by reinforced insulation in accordance with EN 61010-1. Working voltages up to 300 V AC/DC with overvoltage category II and pollution degree 2 between input and output and power supply. For applications with high working voltages, you should ensure there is sufficient spacing or isolation from neighboring devices and protection against electrical shocks.

Standards and approvals

Surge withstand	5 kV 1.2/50 µs according to IEC 255-4
EMC ³⁾	EN 61326
Approvals	cUL: File no. E 216767, Standards UL 3101-1, CSA-C 22.2, No. 10101-1 GL: No. 14593-99 HH KTA: Applied for

2) Average TC in specific working temperature range –10 °C ... +70 °C

3) Slight deviations are possible while there is interference

Specifications, continued

Other data

Ambient temperature	Operation: $-10 \dots +70 \text{ }^\circ\text{C}$ Transport and storage: $-40 \dots +85 \text{ }^\circ\text{C}$
Enclosure	Modular case, width 12.5 mm, see dimension drawing for other measurements, pluggable screw terminals: Type H1 fixed screw terminals: Type F1
Protection class	IP 20
Mounting	Metal lock for mounting on 35 mm top hat rail according to EN 50022 See dimension drawings for conductor cross section
Weight	Approx. 150 g

Schematic diagram

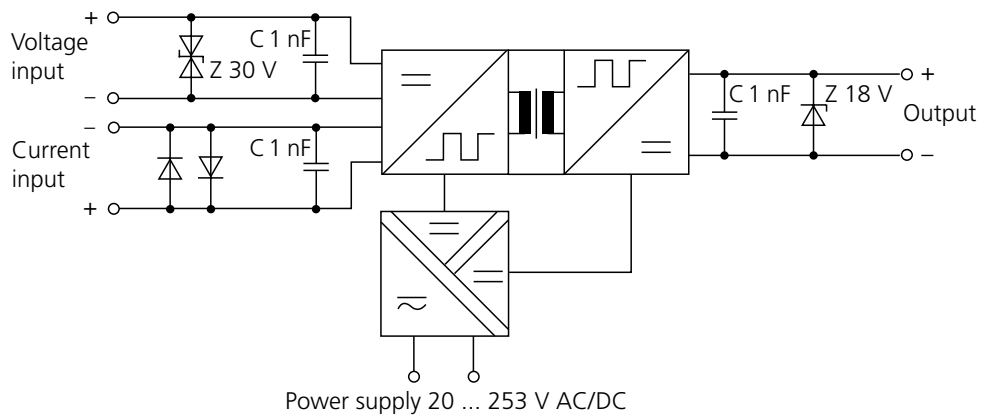

Application examples

Electrical isolation

For safe coupling of the measuring signals to the evaluation electronics

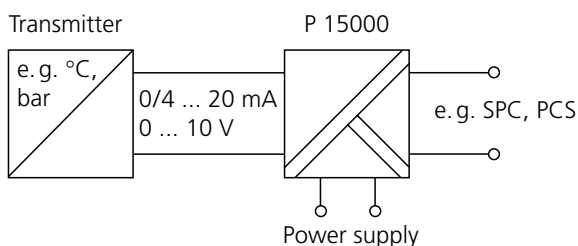

Signal conversion

For example, conversion of voltage signals into current signals for interference-free signal transmission over long distances

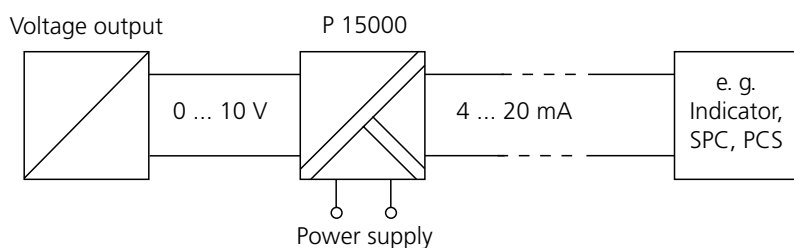

Load increase

e.g. for low load capability measuring signals

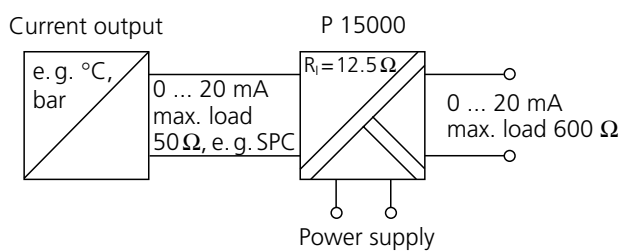

Application examples, continued

Signal multiplication

e. g. for correct evaluation of the measuring signals in different devices

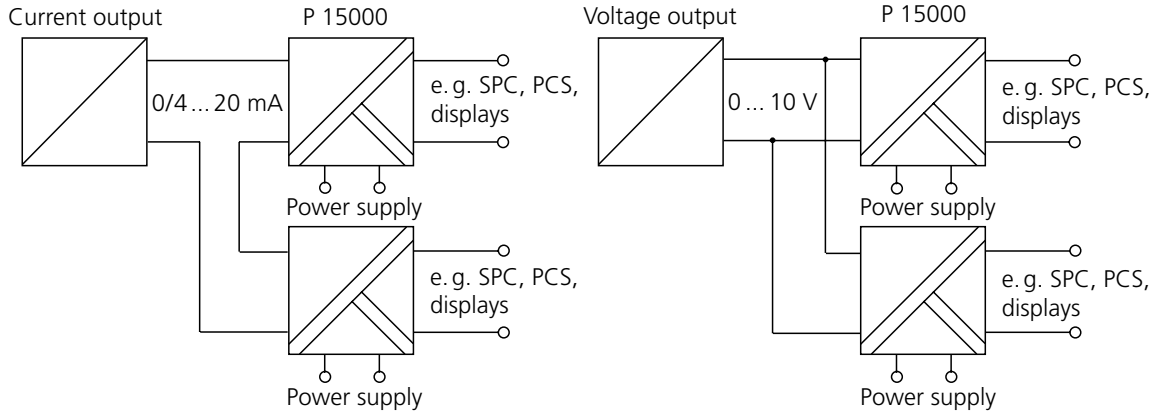

2-wire application

For simple set-up of 2-wire measuring circuits

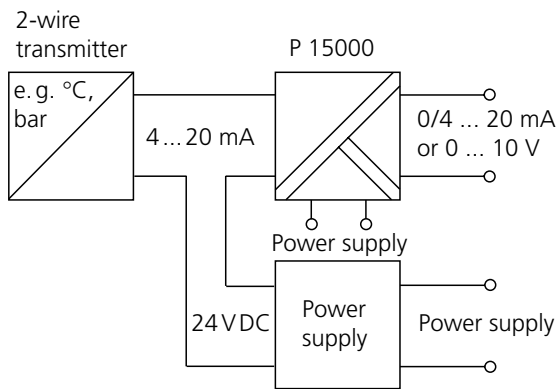

Dimension drawings and terminal assignments

Case with pluggable screw terminals

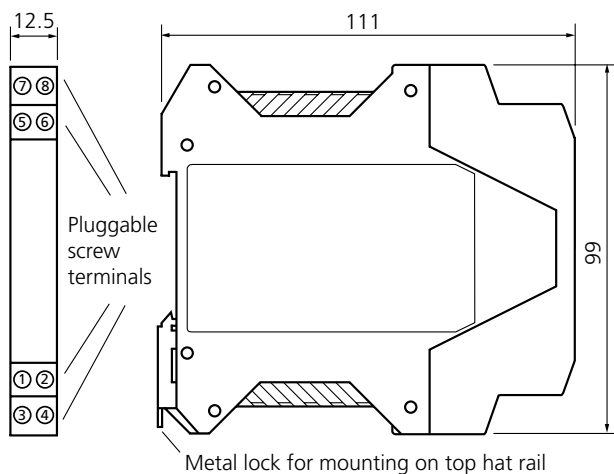

Terminal assignments

- 1 Input + Current
- 2 Input – Current
- 3 Input + Voltage
- 4 Input – Voltage
- 5 Output +
- 6 Output –
- 7 Power supply ≈
- 8 Power supply ≈

Conductor cross section max. 2.5 mm²

Multi-wire connection max. 1 mm² (two wires with same cross section)

Case with fixed screw terminals

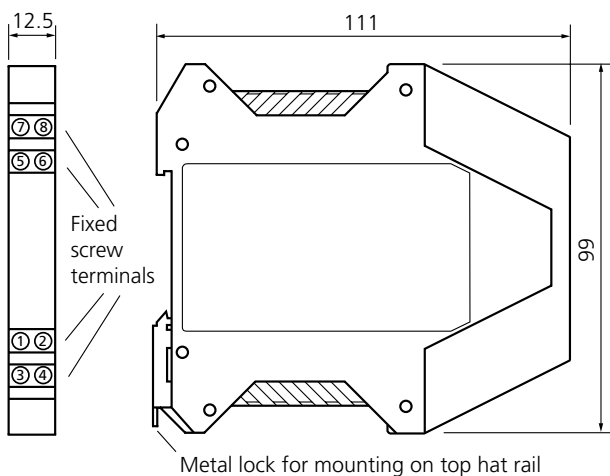

All dimensions in mm.

VariTrans® B 13000

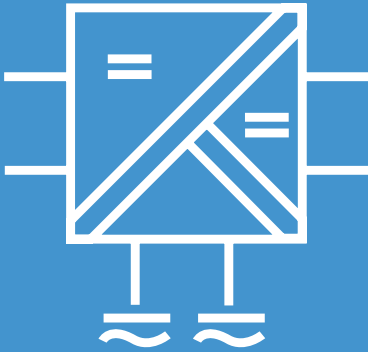

The reasonably priced alternative for standard industrial applications. With calibrated range selection.

The task

Guaranteeing reliable and safe system operation requires galvanic isolation between the sensor and the control (e. g. SPC, PCS etc.).

The problems

In particular with large-scale systems, the difficulties often lies in the financial pressure in addition to the lack of space for mounting the isolators. Up to now, low-cost single-range isolators have, however, caused relatively high purchase, logistics and storage costs, for example, also for stocking of spare parts.

The solution

The calibrated switching of the input and output ranges allows the VariTrans® B 13000 basic low-cost standard signal isolators to be used universally without complicated recalibration. The settings are made simply using DIP switches.

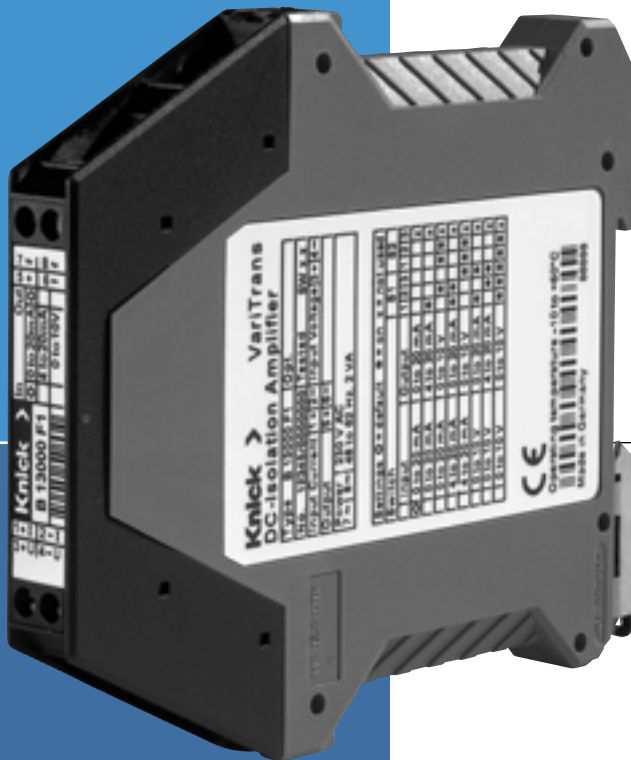

Warranty
5 years!

Defects occurring within 5 years from delivery are remedied free of charge at our plant (carriage and insurance paid by sender).

The enclosure

The modular case, just 12.5 mm in width, can also withstand high mechanical loads. The case is easy to open providing access to the setting elements.

The advantages

The analog transmission of the measuring signal with transformer isolation and the new digitally controlled range selection guarantee troublefree use in all standard industrial applications.

The technology

A microcontroller monitors the control element settings and controls the calibrated range selection. Interference to the signal transmission – for example, contact resistances in the range switches – are thus ruled out.

The integrated power supply is configured for 230 V AC or 24 V AC/DC. The extremely low power consumption and the related minimal self-heating significantly increase the reliability. That's why we give a 5-year warranty.

The facts

- **Flexible and accurate**
calibrated range selection without complicated recalibration
- **Low-cost**
the competitively priced solution for standard applications; considerable reduction in purchasing, logistics and storage costs, for example, for stocking of spare parts
- **Extremely compact design**
12.5 mm modular case; up to 80 active isolators per meter of top hat rail
- **Fast and easy configuration**
case simple to open
- **3-port isolation**
protection against incorrect measurements or damage
- **Maximum reliability**
no repair and failure costs
- **5-year warranty**

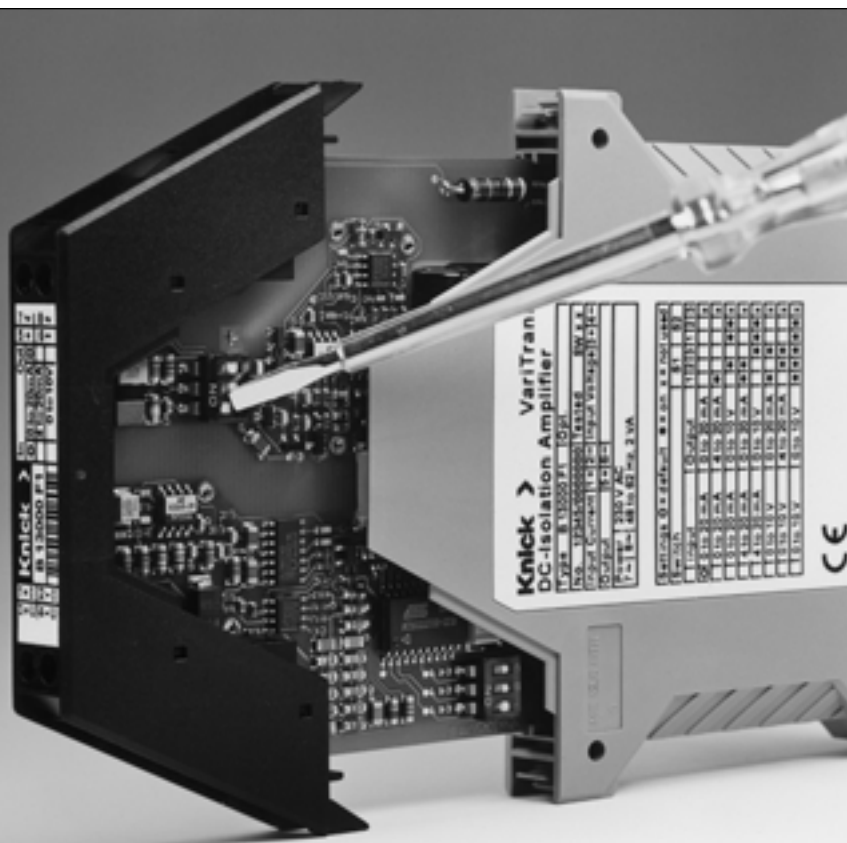

Product line

Devices	Input	Output	Order no.
B 13000 with calibrated input and output selection	0 ... 20 mA, 4 ... 20 mA, 0 ... 10 V	0 ... 20 mA, 4 ... 20 mA, 0 ... 10 V	B 13000 F1
B 13000 with fixed settings	0 ... 20 mA 0 ... 20 mA 0 ... 20 mA 4 ... 20 mA 4 ... 20 mA 4 ... 20 mA 0 ... 10 V 0 ... 10 V 0 ... 10 V	0 ... 20 mA 4 ... 20 mA 0 ... 10 V 0 ... 20 mA 4 ... 20 mA 0 ... 10 V 0 ... 20 mA 4 ... 20 mA 0 ... 10 V	B 13016 F1 B 13017 F1 B 13018 F1 B 13026 F1 B 13016 F1 B 13028 F1 B 13036 F1 B 13037 F1 B 13038 F1
Power supply			
230 V AC			
24 V AC/DC			336

Specifications

Input data

Inputs	0 ... 20 mA 4 ... 20 mA 0 ... 10 V	Terminal-selectable/switchable (factory setting 0 ... 20 mA or fixed settings (see Product line))
Input resistance	Current input Voltage input	Voltage drop approx. 500 mV at 20 mA approx. 1 MOhm
Overload	Current input Voltage input	≤ 300 mA Voltage limitation with suppressor diode 30 V, max. permitted continuous current 30 mA

Output data

Outputs	0 ... 20 mA 4 ... 20 mA 0 ... 10 V	Switchable (factory setting 0 ... 20 mA or fixed settings (see Product line)) (Transmission of negative measuring signals up to approx. -5 % of full scale)
Load	With output current With output voltage	≤ 10 V (500 Ohms at 20 mA) ≤ 10 mA (1 kOhm at 10 V) ¹⁾
Offset	20 μA or 10 mV	
Residual ripple	< 20 mV _{rms}	

1) Higher voltage output load on request

Specifications, continued

Transmission behavior

Gain error	<0.4 % meas. val.
Cut-off frequency	> 1 kHz –3 dB
Temperature coefficient ²⁾	0.015 % /K full scale (reference temperature 23 °C)

Power supply

Power supply	230 V AC, –15 % +10 %, 48 ... 62 Hz, approx. 2 VA	
Opt. 336:	24 V AC/DC	AC: ±15 %, 48 ... 62 Hz, approx. 2 VA DC: ±15 %, approx. 0.9 W

Isolation

Galvanic isolation	3-port isolation between input, output and power supply
Test voltage	3.25 kV AC input against output against power supply
Working voltage (basic isolation)	600 V AC/DC with overvoltage category II and pollution degree 2 according to EN 61010-1. For applications with high working voltages, you should ensure there is sufficient spacing or isolation from neighboring devices and protection against electrical shocks.

Standards and approvals

Surge withstand	5 kV 1.2/50 µs according to IEC 255-4
EMC ³⁾	EMC directive 89/336/EEC, EN 61326
Approvals	cUL: File No. E 216767, Standards UL 3101-1, CSA-C 22.2, No. 10101-1 GL: No. 14627-99 HH

Other data

Ambient temperature	Operation: –10 ... +60 °C Transport and storage: –20 ... +85 °C
Version	Modular case, type F1, with screw terminals, width 12.5 mm, see dimension drawing for other measurements
Protection class	IP 20
Mounting	For 35 mm top hat rail EN 50022 See dimension drawings for conductor cross section
Weight	Approx. 150 g

2) Average TC in specific working temperature range –10 °C ... +60 °C

3) Slight deviations are possible while there is interference

Schematic diagram

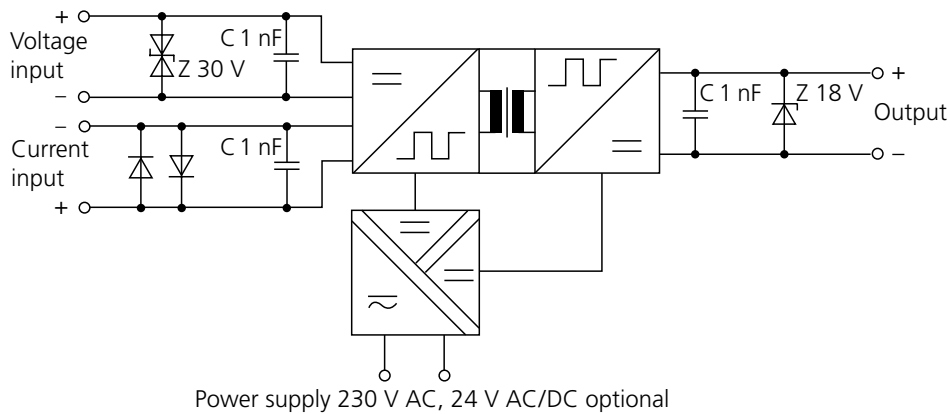

Application examples

Electrical isolation

For safe coupling of the measuring signals to the evaluation electronics

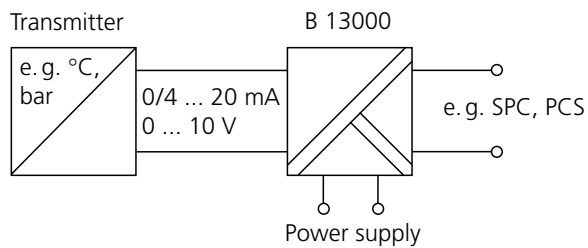

Signal conversion

For example, conversion of voltage signals into current signals for interference-free signal transmission over long distances

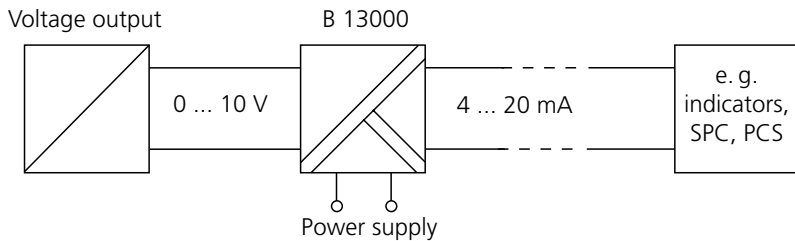

Application examples, continued

Load increase

e. g. for low load capability measuring signals

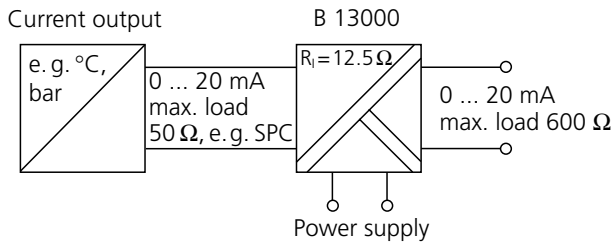

Signal Multiplication

e. g. for correct evaluation of the measuring signals in different devices

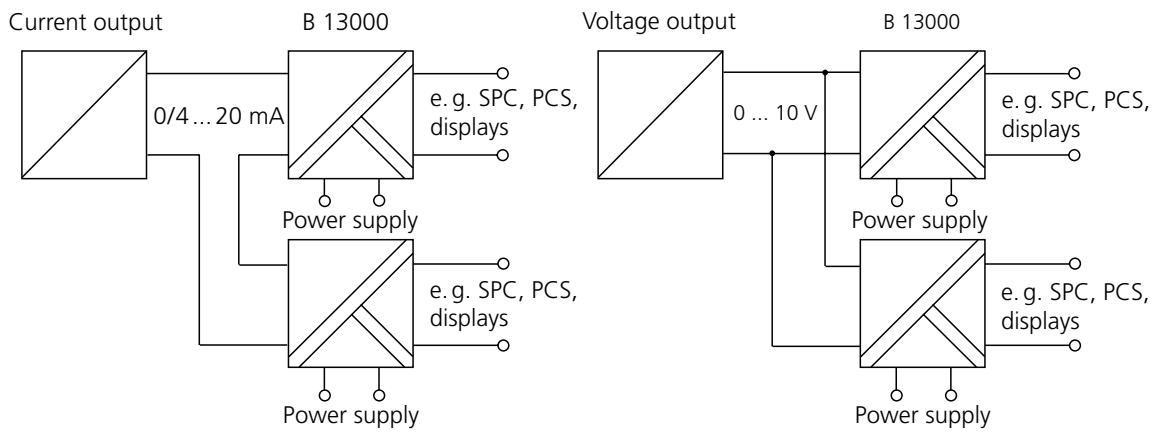

2-wire application

For simple set-up of 2-wire loops

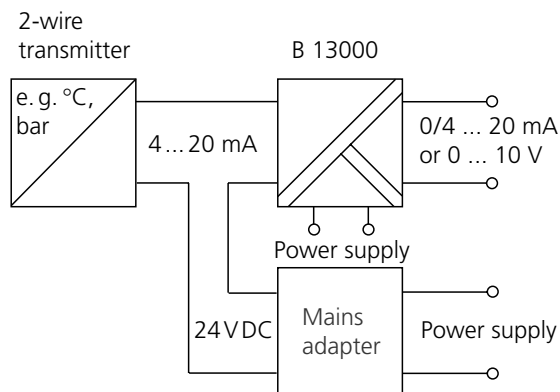

Dimension drawings and terminal assignments

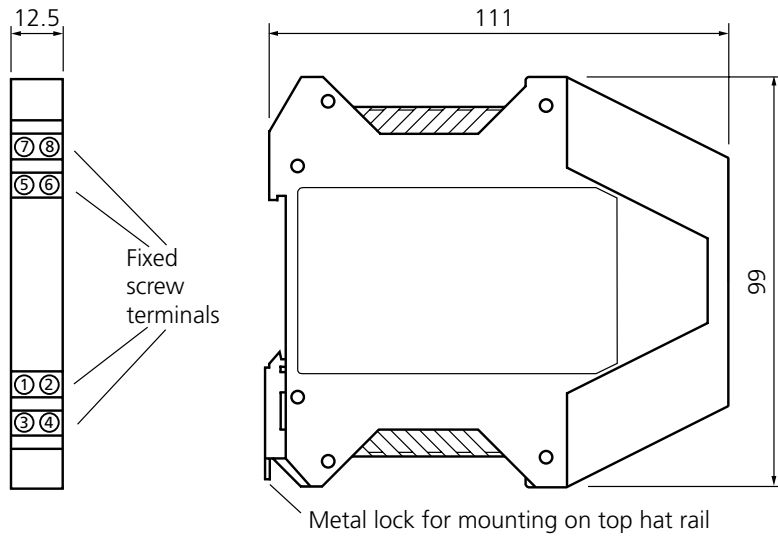

Terminal assignments

All dimensions in mm.

- | | |
|-------------------|------------------|
| 1 Input + Current | 5 Output + |
| 2 Input - Current | 6 Output - |
| 3 Input + Voltage | 7 Power supply ≈ |
| 4 Input - Voltage | 8 Power supply ≈ |

Conductor cross section max. 2.5 mm²

Multi-wire connection max. 1 mm² (two wires with the same cross section)

VariTrans® B 10000

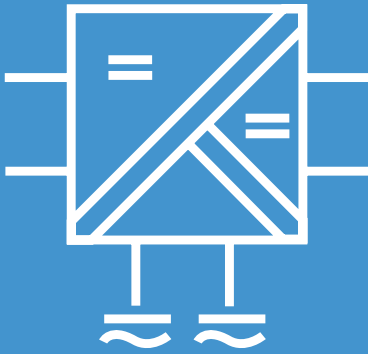

The only 3-port standard signal isolation amplifier in a 6 mm modular case.

The task

Isolation and, if necessary, conversion of 0 ... 20 mA, 4 ... 20 mA as well as 0 ... 10 V standard signals. If you have limited space and budget, there could still be difficulties when it comes to selecting a suitable isolator despite the standard transmission requirements.

The problems

Up to now the only way of reducing costs substantially was to opt for low quality products. As a large number of different signals also required a large number of isolators, this also led to considerable stockkeeping costs.

The solution

The 3-port standard signal isolation amplifier from Knick sets new standards due to its extremely compact design and its low self-heating. The VariTrans® B 10000 is available with 9 selectable, calibrated ranges or as one of eight different variants with fixed settings. In any case it has an extremely attractive price.

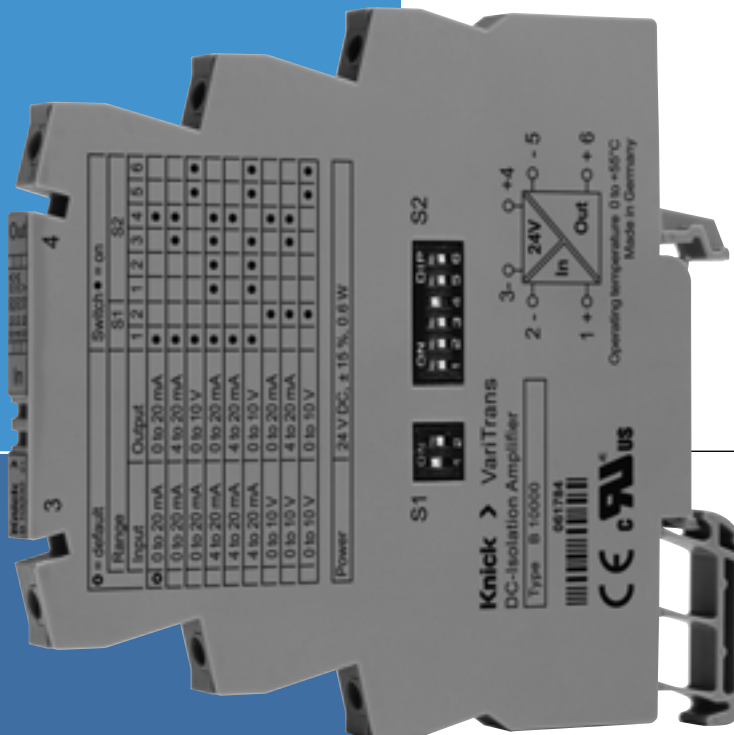

The enclosure

Measuring only 6 mm, the closed modular case of the VariTrans® B 10000 allows up to 163 active isolation amplifiers per meter top-hat rail.

The advantages

In spite of the reduced space, the VariTrans® B 10000 provides true 3-port separation between input, output, and power supply (24 V DC) to prevent parasitic voltages.

A pluggable cross-connection for power supply ensures quick and therefore inexpensive mounting.

The technology

Analog signal processing with transformer isolation ensures excellent signal transmission. The input and output ranges can easily be selected using DIP switches.

Warranty
5 years!

Defects occurring within 5 years from delivery are remedied free of charge at our plant (carriage and insurance paid by sender).

The facts

- **Safety in the smallest of spaces**
3-port isolation in a 6 mm enclosure
- **Space-saving mounting**
No ventilation clearances required since there is no noticeable heat development
- **Attractive price**
One of the cheapest quality isolators on the market
- **Long life**
Extremely low failure rate (MTBF of 440 years) due to reduced self-heating
- **Good accuracy**
Exemplary signal transmission for standard applications
- **Low-cost mounting**
using pluggable cross-connection allows the power supply to be connected to several VariTrans® B 10000 units easily and extremely cost efficient
- **Calibrated range switching**
no tedious readjustment
- **8 fixed range variants**
if range shifting is to be avoided
- **3-port isolation**
prevention of incorrect measurements caused by potential differences
- **Simple configuration**
DIP switches accessible from outside
- **5-year warranty**

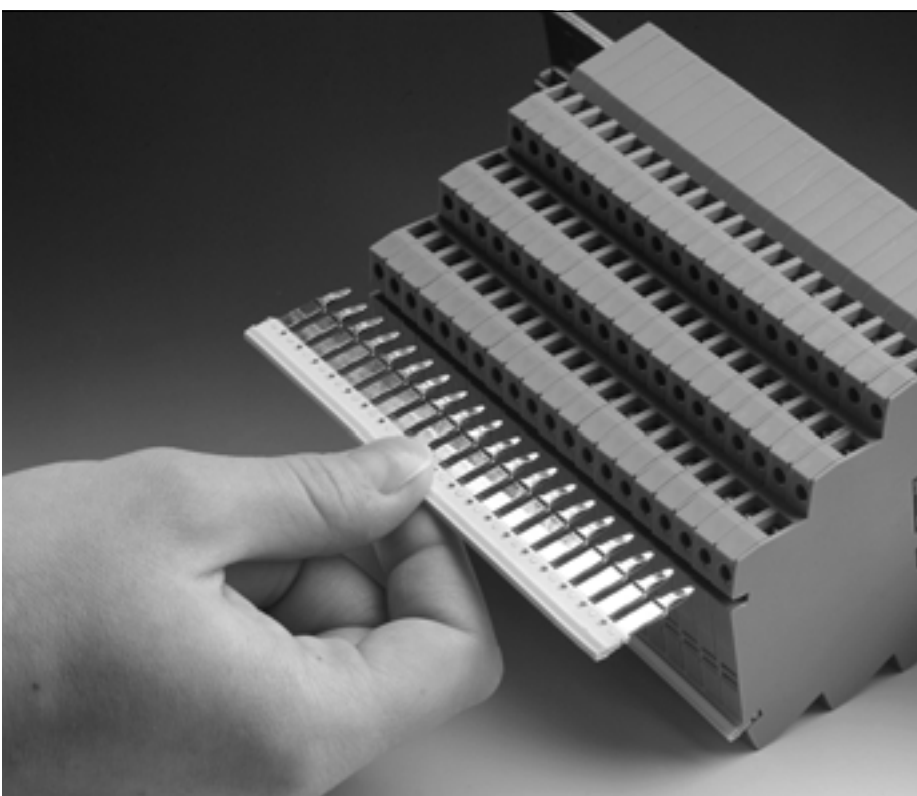

Product line

Devices	Input	Output	Order no.
B 10000 with calibrated input and output selection	0 ... 20 mA, 4 ... 20 mA, 0 ... 10 V	0 ... 20 mA, 4 ... 20 mA, 0 ... 10 V	B 10000 FO
B 10000 with fixed settings	0 ... 20 mA 0 ... 20 mA 0 ... 20 mA 4 ... 20 mA 4 ... 20 mA 4 ... 20 mA 0 ... 10 V 0 ... 10 V 0 ... 10 V	0 ... 20 mA 4 ... 20 mA 0 ... 10 V 0 ... 20 mA 4 ... 20 mA 0 ... 10 V 0 ... 20 mA 4 ... 20 mA 0 ... 10 V	B 10016 FO B 10017 FO B 10018 FO B 10026 FO B 10016 FO B 10028 FO B 10036 FO B 10037 FO B 10038 FO
Cross-connections	Pluggable cross-connection for looping through of the power supply for up to 41 power supply connections VariTrans® B 10000, splittable.		ZU 0542
Power supply	24 V DC		

Specifications

Input data

Inputs	0 ... 20 mA 4 ... 20 mA 0 ... 10 V	Calibrated selection or fixed settings (see Product line)
Input resistance	Current input Voltage input	Voltage drop < 0.1 V at 20 mA Approx. 100 kOhms
Overload	Current input Voltage input	< 100 mA Voltage limitation with suppressor diode 30 V, max. permitted continuous current 3 mA

Output data

Outputs	0 ... 20 mA 4 ... 20 mA 0 ... 10 V	Calibrated selection or fixed settings (see Product line)
Load	With output current With output voltage	≤ 500 Ohms ≥ 10 kOhms

Specifications, continued

Transmission behavior

Transmission error ¹⁾	< 0.4 %
Cut-off frequency	> 100 Hz –3 dB

Power supply

Power supply	24 V DC (± 15 %), 0.6 W
--------------	-------------------------

Isolation

Galvanic isolation	3-port isolation between input, output and power supply
Test voltage	510 V AC (higher test voltage up to 1.5 kV on request)
Working voltage (basic isolation)	100 V with overvoltage category II and pollution degree 2 according to EN 61010-1. For applications with high working voltages, you should ensure there is sufficient spacing or isolation from neighboring devices and protection against electrical shocks.

Standards and approvals

EMC ²⁾	Product standard EN 61326, emitted interference: Class B, Immunity to interference: Industry
Approval	cUL, File No. E 220033, Standards: UL 508 and CAN/CSA 22.2 No. 14

Other data

Ambient temperature	Operation: 0 ... +55 °C Transport and storage: –25 ... +85 °C
Version	Modular case with screw terminals, power supply also possible via cross-connections, width 6.1 mm, see dimension drawing for other measurements
Protection class	IP 20
Mounting	For 35 mm top hat rail to EN 50022 See dimension drawings for conductor cross section
Weight	Approx. 50 g

1) Additional faults in live-zero operation 20 µA or 10 mV

2) Slight deviations are possible while there is interference

Schematic diagram

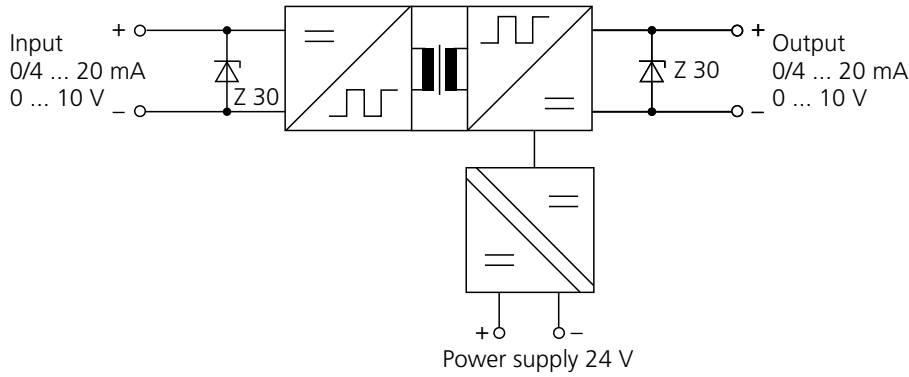

Application examples

Electrical isolation

For safe coupling of the measuring signals to the evaluation electronics

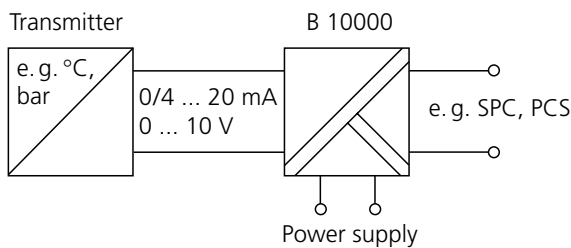

Signal conversion

For example, conversion of voltage signals into current signals for interference-free signal transmission over long distances

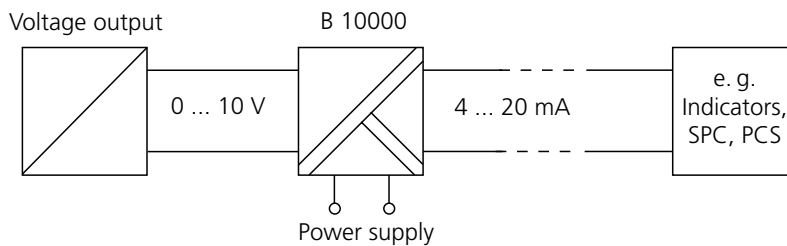

Load increase

e. g. for low load capability measuring signals

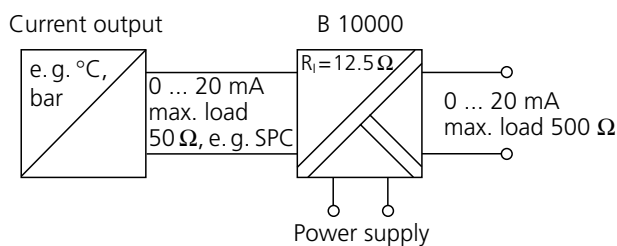

Dimension drawings and terminal assignments

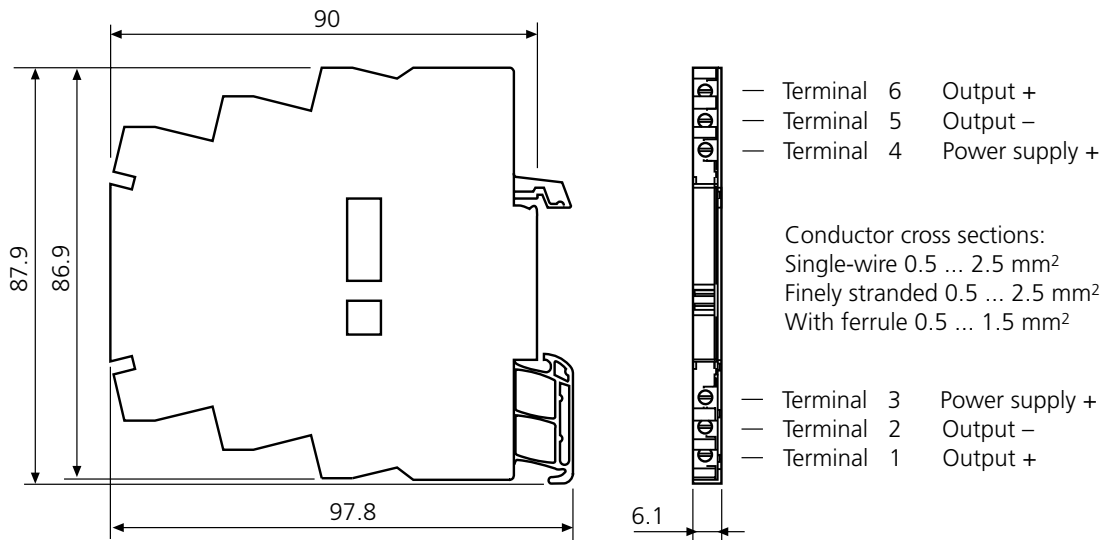

All dimensions in mm.

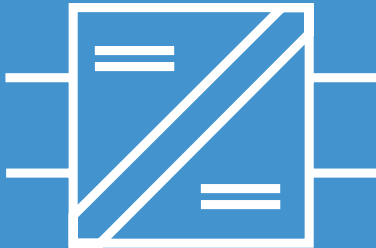

IsoTrans® 41

For separation of 0(4) ... 20 mA standard current signals, up to 3 channels

The load capability of the 20 mA source is limited and therefore requires economical handling of the load voltage.

The task

If there is no power supply available, the galvanic isolation of 0(4) ... 20 mA standard current signals requires investment in supply units.

The solution

Knick IsoTrans® 41 DC transformers with transformer isolation have specifications well beyond other loop-powered DC isolators. 0.2 % fault class and just 1.2 V natural voltage requirement allow diverse uses of this isolator.

The problems

By many products loop-powered isolation is only achieved with insufficient accuracy. The desire for high accuracy demands an isolator concept that fulfils the highest expectations.

The enclosure

The A2 modular case with a width of 22.5 mm for max. 3 isolators offers optimum space usage in multichannel mode. The A3 modular case for one isolator is just 17.5 mm wide.

The full encapsulation guarantees a high level of reliability even in extreme conditions.



Warranty
5 years!

Defects occurring within 5 years from delivery are remedied free of charge at our plant (carriage and insurance paid by sender).

The advantages

The galvanic isolation in the IsoTrans® 41 is achieved using a passive isolator that obtains its power from the measuring signal as a voltage drop. This saves on supply units, cabling and increases the reliability accordingly.

The technology

The units work with a serial chopper generator in the current path. This avoids the accuracy-reducing power losses of normal parallel connected generators, reduces the voltage drop accordingly and also ensures accurate transmission of the smallest currents.

The application

- Galvanic isolation
- of input and output circuits
 - of the supply voltage of 2-wire transformers
 - with addition or other coupling of signals at different potentials
 - for removal of double ground compensation currents
 - when there is an insufficient insulation and test voltage
 - of high-potential signal sources
 - for battery-powered devices with a central battery

The facts

- **Loop-powered**
no mains influences
- **Extremely high accuracy**
- **Broad field of application**
current transmission from 2 μ A to 50 mA
- **Maximum reliability**
no unnecessary heat and therefore maximum service life of components
- **Negligible loading of the measuring signal**
natural voltage requirement just 1.2 V
- **Low signal delay**
- **Space-saving due to multi-channel variants**
modular case with up to 3 channels
- **Computer-controlled testing guarantees quality**
- **5-year warranty**

Product line

Devices

IsoTrans® 41

1-channel, A2 modular case (width: 22.5 mm)
 2-channel, A2 modular case (width: 22.5 mm)
 3-channel, A2 modular case (width: 22.5 mm)
 1-channel, A3 modular case (width: 17.5 mm)

Order no.

41 A2/1
 41 A2/2
 41 A2/3
 41 A3

Power supply

None, supply from input signal

Specifications

Input data

Inputs

0(4) ... 20 mA
 0 ... 50 mA

Operating current

< 2 μ A

Voltage drop

Approx. 1.2 V (20 mA)
 Approx. 1.6 V (50 mA)

Overload

100 mA, 20 V (see also page 64)

Output data

Output

0(4) ... 20 mA/max. 15 V (corresponds with 750 Ohm load)
 0 ... 50 mA/max. 15 V (corresponds with 300 Ohm load)

Offset

< 5 μ A

Residual ripple¹⁾

< 1.5 mV_{pp}/mA

Transmission behavior

Transformation error²⁾

0.02 % meas. val.

Load error

< 0.02 % meas. val. per 100 Ohm

Rise or fall time

Approx. 2.5 ms at 500 Ohm load resistance

1) Slightly increased residual ripple can occur when load < 5 Ohms

2) Temperature range -10 ... +70 °C

Specifications, continued

Isolation

Test voltage	2.5 kV AC
Working voltage (basic isolation)	500 V DC between any inputs and outputs with overvoltage category II and pollution degree 3 according to EN 61010-1 (with type 41 A2/3 between neighbouring inputs and outputs with pollution degree 2 inside the case, degree 3 outside). For applications with high working voltages, you should ensure there is sufficient spacing or isolation from neighboring devices and protection against electrical shocks.

Standards and approvals

Surge withstand	5 kV 1.2/50 µs according to IEC 255-4
Immunity to interference	8 kV according to IEC 801-2

Other data

Ambient temperature	-25 ... +80 °C
Enclosure	Modular case, width 22.5 mm, A2 case and 17.5 mm, A3 case, see dimension drawings for further measurements, screw terminals
Protection class	Protection class with terminal cover according to EN 60529: case IP 40, terminals IP 20
Mounting	With snap-on mounting for 35 mm top hat rail according to EN 50022 or M4 screw mounting See dimension drawings for conductor cross section
Weight	41 A2/1: approx. 140 g 41 A2/2: approx. 190 g 41 A2/3: approx. 210 g 41 A3: approx. 70 g

Transfer functions

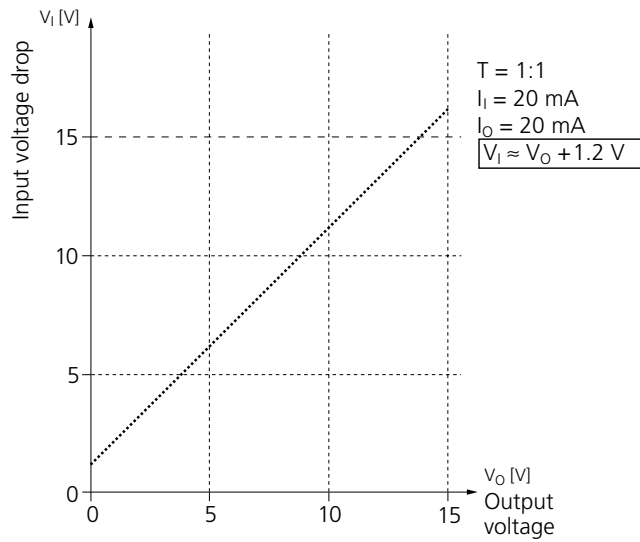

Reactions to square step of input current

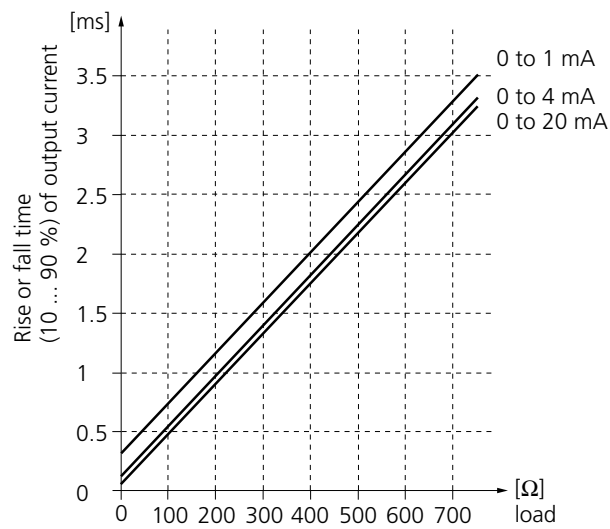

Schematic diagram

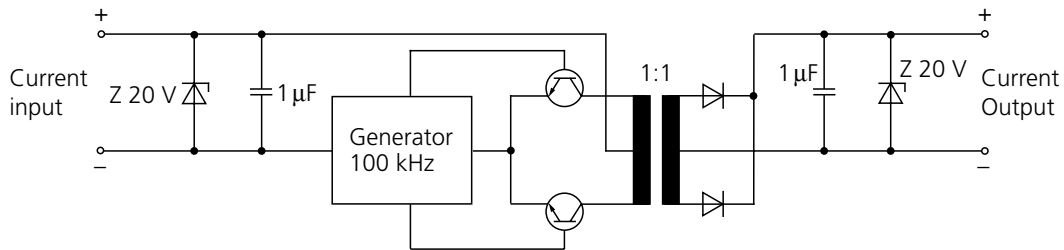

Application examples

Electrical isolation

With impressed current, current output

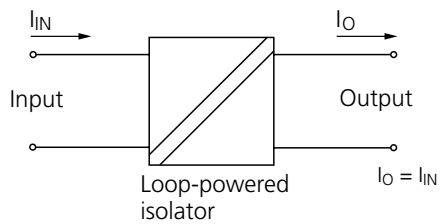

Electrical isolation

With impressed input current, voltage output

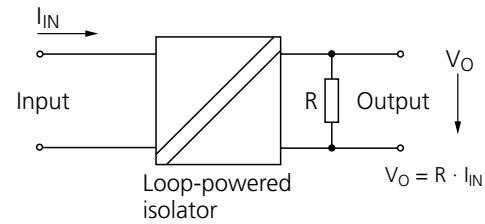

Electrical isolation

in two-wire technology

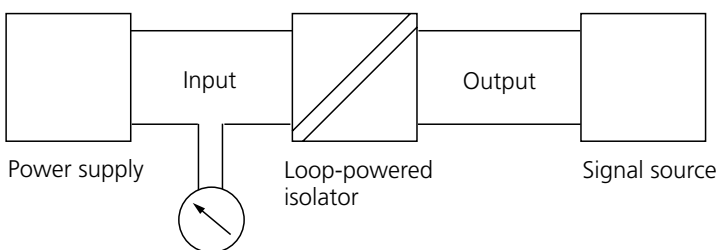

Application examples, continued

Electrical isolation

For current addition with impressed currents

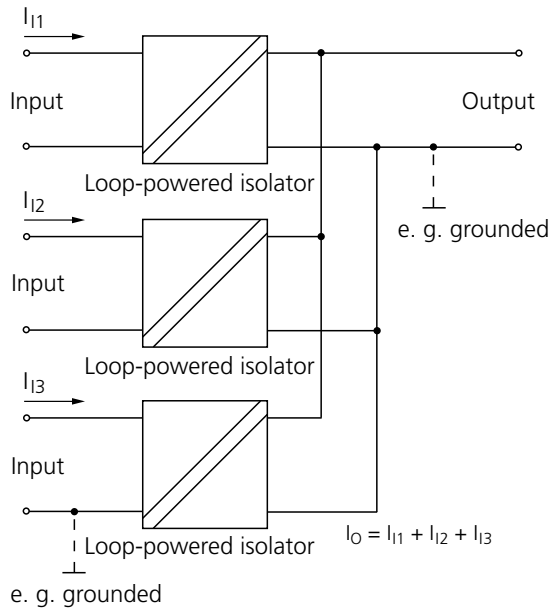

Dimension drawings and terminal assignments

Type A2 modular case

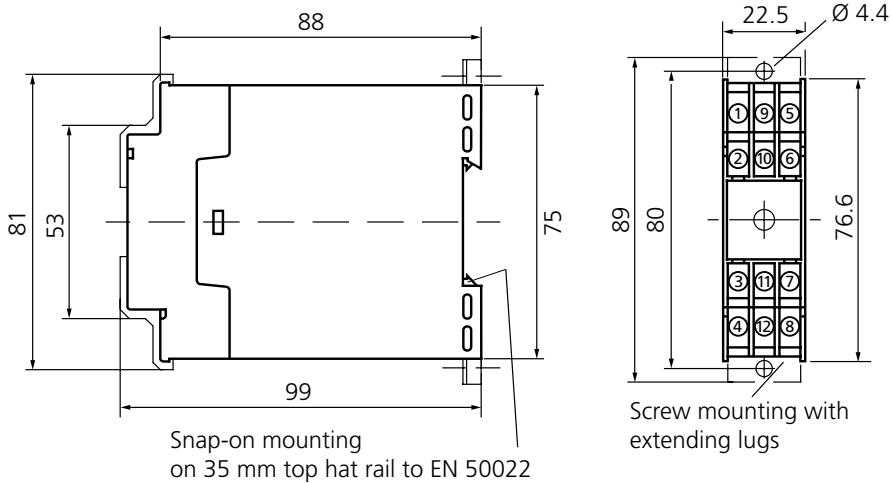

Channel 1	1 Input	+	Channel 2	5 Input	+	Channel 3	9 Input	+
	2 Input	-		6 Input	-		10 Input	-
	3 Output	-		7 Output	-		11 Output	-
	4 Output	+		8 Output	+		12 Output	+

M 2.5 x 8 connecting screws with self-releasing clamping pieces, max. conductor cross section 2 x 2.5 mm² solid or 2 x 1.5 mm² stranded with ferrule

Type A3 modular case

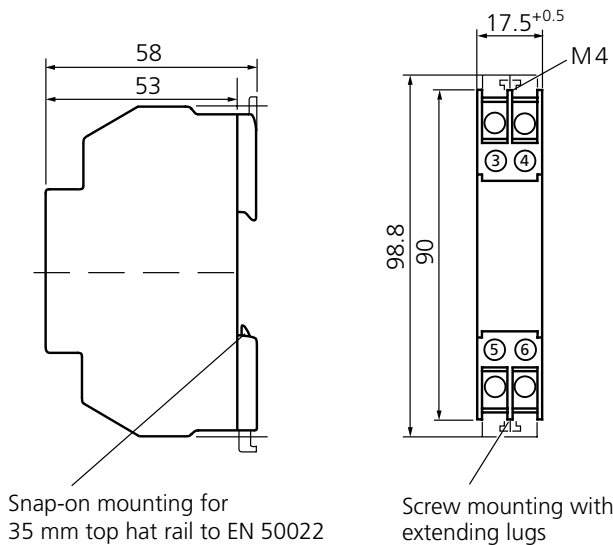

3 Input	+
4 Input	-
5 Output	+
6 Output	-

M3.5 connecting screws with self-releasing clamping pieces, max. conductor cross section 2 x 2.5 mm² solid or 2 x 1.5 mm² stranded with ferrule to DIN 46228

All dimensions in mm.

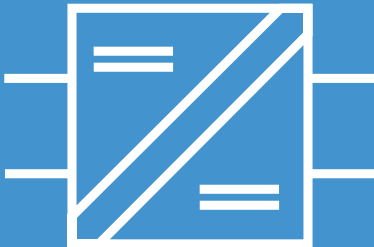

IsoTrans® A 47

For isolation of 0(4) ... 20 mA standard signals, up to 4 channels

The task

Guaranteeing reliable and safe system operation requires galvanic isolation between the sensor and controller (for example, PCS, SPC etc.).

The problems

are often, particularly in large plants, the lack of space for mounting the isolators and the increasing operating temperatures in distributors and switch cabinets.

The solution

from Knick is the IsoTrans® A 47 advanced series of loop-powered isolators. An extremely high component density of 177 channels per meter of top hat rail and excellent technical properties, for example, safe isolation, make the isolators unbeatable.

The enclosure

The modern modular case with a width of 12.5 mm for 1 or 2 channels and 22.5 mm width for 4 channels with practical plug-in terminals allow simple and quick assembly or prewiring of the control cabinet.

The function principle

The IsoTrans® A 47 obtains its power directly from the measuring signal as a voltage drop without falsifying it. There are no costs for a power supply and wiring.

The IsoTrans® A 47 more or less has no self-heating that would cause the electronic components to age faster. Together with a patented switching technique, this means maximum reliability. Due to this long service life, we give a 5-year warranty



Warranty
5 years!

Defects occurring within 5 years from delivery are remedied free of charge at our plant (carriage and insurance paid by sender).

Product line

Devices

IsoTrans® A 47

1-channel, H1 modular case (width: 12.5 mm)
 2-channel, H1 modular case (width: 12.5 mm)
 4-channel, H3 modular case (width: 22.5 mm)

Order no.

A 47 H1/1
 A 47 H1/2
 A 47 H3/4

Power supply

None, supply from input signal

Options

Increased test voltage 4 kV AC, safe isolation

506

Specifications

Input data

Input

0(4) ... 20 mA/max. 30 V (linear transmission up to 50 mA)

Operating current

< 20 μ A

Voltage drop

Approx. 2.5 V at 20 mA

Overload

100 mA, 30 V

Output data

Output

0(4) ... 20 mA/max. 27.5 V (corresponds with 1375 Ohm load)

Residual ripple

< 5 mV_{rms}

Transmission behavior

Transmission error

< 0.1 % full scale

Load error

< 0.02 % meas.val. / 100 Ohms

Response time (T₉₉)

Approx. 5 ms at 500 Ohm load

Temperature influence¹⁾

< 0.002 %/K full scale per 100 Ohm load (reference temperature 23 °C)

1) Average TC in specific working temperature range -10 °C ... +70 °C

Specifications, continued

Isolation

Test voltage	1.5 kV AC input against output of the same channel 2.3 kV AC channels against each other
--------------	---

Standards and approvals

EMC ²⁾	EMC directive 89/336/EEC, EN 61326
Approvals	UL: File no. E 220033, Standards: UL 508 and CAN/CSA 22.2 no. 14

Data for option 506

Test voltage	4 kV AC input against output of the same channel 2.3 kV AC channels against each other
Protection against dangerous currents	Safe isolation according to EN 61140 by reinforced insulation in accordance with EN 61010-1. Working voltages up to 300 V AC/DC with overvoltage category II and pollution degree 2 between all connections. For applications with high working voltages, you should ensure there is sufficient spacing or isolation from neighboring devices and protection against electrical shocks.

Other data

Ambient temperature	Operation: -10 ... +70 °C Transport and storage: -40 ... +85 °C
Enclosure	Modular case, width 12.5 mm or 22.5 mm, with pluggable screw terminal See dimension drawings for further measurements
Protection class	IP 20
Mounting	Metal lock for mounting on 35 mm top hat rail according to EN 50022 See dimension drawings for conductor cross section
Weight	Approx. 100 g

2) Applies to 4 ... 20 mA, slight deviations are possible while there is interference

Transfer functions

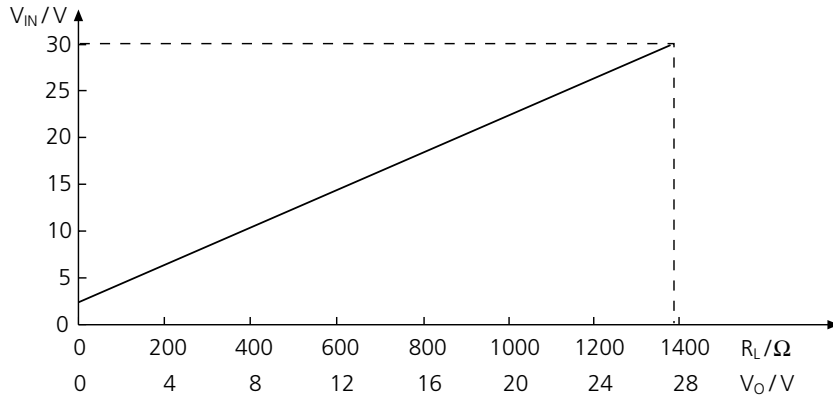

Schematic diagram

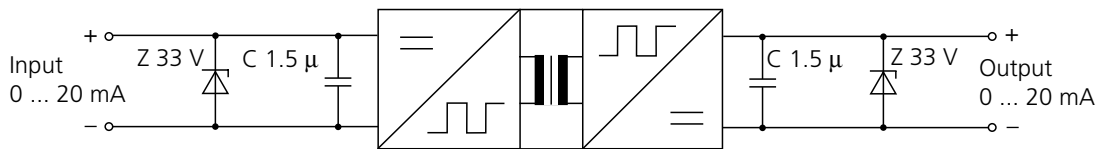

Dimension drawings and terminal assignments

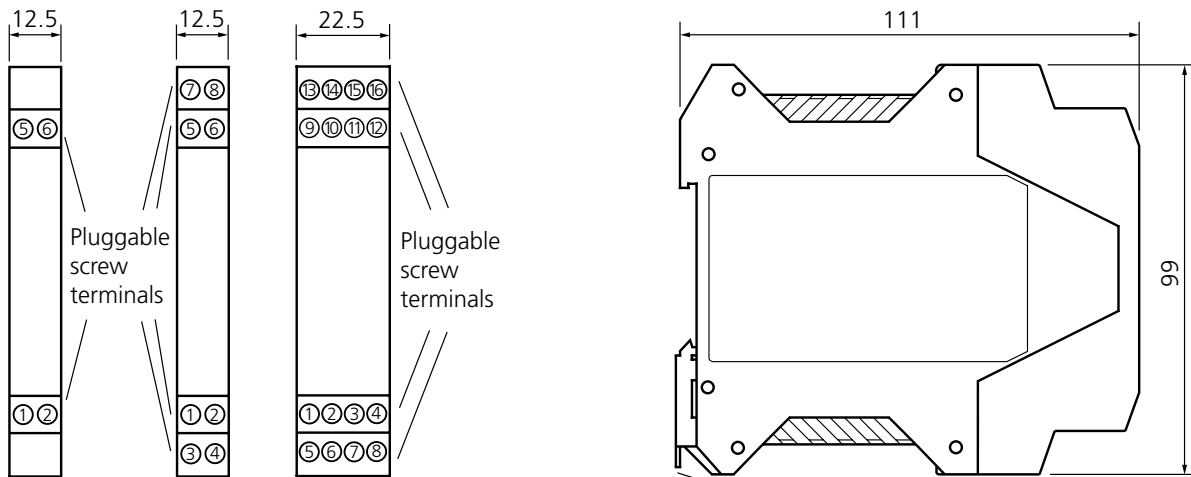

All dimensions in mm.

Metal lock for mounting on top hat rail

Conductor cross section max. 2.5 mm²

Multi-wire connection max. 1 mm² (two wires with same cross section)

1 and 2-channel model

- 1 Input + Channel 1
- 2 Input - Channel 1
- 3 Input + Channel 2
- 4 Input - Channel 2
- 5 Output + Channel 1
- 6 Output - Channel 1
- 7 Output + Channel 2
- 8 Output - Channel 2

4-channel model

- 1 Input + Channel 1
- 2 Input - Channel 1
- 3 Input + Channel 2
- 4 Input - Channel 2
- 5 Input + Channel 3
- 6 Input - Channel 3
- 7 Input + Channel 4
- 8 Input - Channel 4
- 9 Output + Channel 1
- 10 Output - Channel 1
- 11 Output + Channel 2
- 12 Output - Channel 2
- 13 Output + Channel 3
- 14 Output - Channel 3
- 15 Output + Channel 4
- 16 Output - Channel 4

IsoTrans® B 48

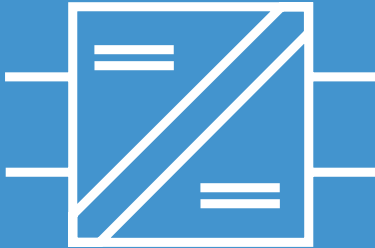

Unbelievably simple isolation!

20 mA transmission with electrical isolation

The task

Preventing measuring errors or even destruction of the system normally requires floating connection of the sensors and actuators to the sensitive MSR electronics.

The problem

was solved up to now with additional devices for electrical isolation after the routing and distributor level.

The solution

is the 6 mm wide IsoTrans® B 48 isolating terminal. It fulfills all tasks set for modern terminals and safely and reliably isolates 0(4) ... 20 mA signals using loop power without falsifying the measuring signal.

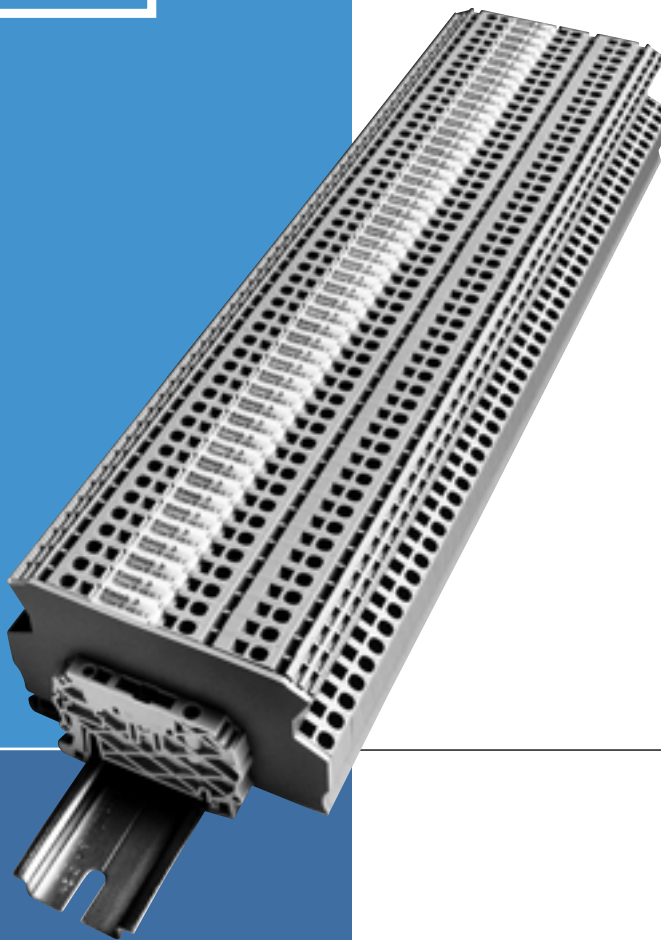

Warranty
5 years!

Defects occurring within 5 years from delivery are remedied free of charge at our plant (carriage and insurance paid by sender).

The connections

use Z-springs and allow simple, fast and safe connection of the lines.

The technology

The constantly improved switching concept of our isolators that have been tried and tested over decades and draw their power from the measuring signal as a voltage drop and the use of a specially developed flat core transformer have led to this extremely narrow housing with a width of just 6 mm. That is up to 166 isolating terminals per meter of top hat rail.

The facts

- **Substantial costs and space-savings**
due to the omission of a whole installation stage
- **Minimum wiring work**
due to loop-powered electrical isolation and the combination of a terminal and isolator in one device
- **Fast, simple and safe wiring using Z-springs**
- **High level of safety thanks to proven switching method**
- **Galvanic isolation**
protection against incorrect measurements or damage to the measuring system caused by parasitic voltages
- **Extremely compact design**
at just 6 mm in width the modular case allows up to 166 channels per meter
- **Easy to use and to maintain**
simple and fast installation due to innovative Z-springs
- **No power supply required**
cost saving due to lower wiring requirement, no mains influences
- **High accuracy**
no falsification of measuring signal
- **5-year warranty**

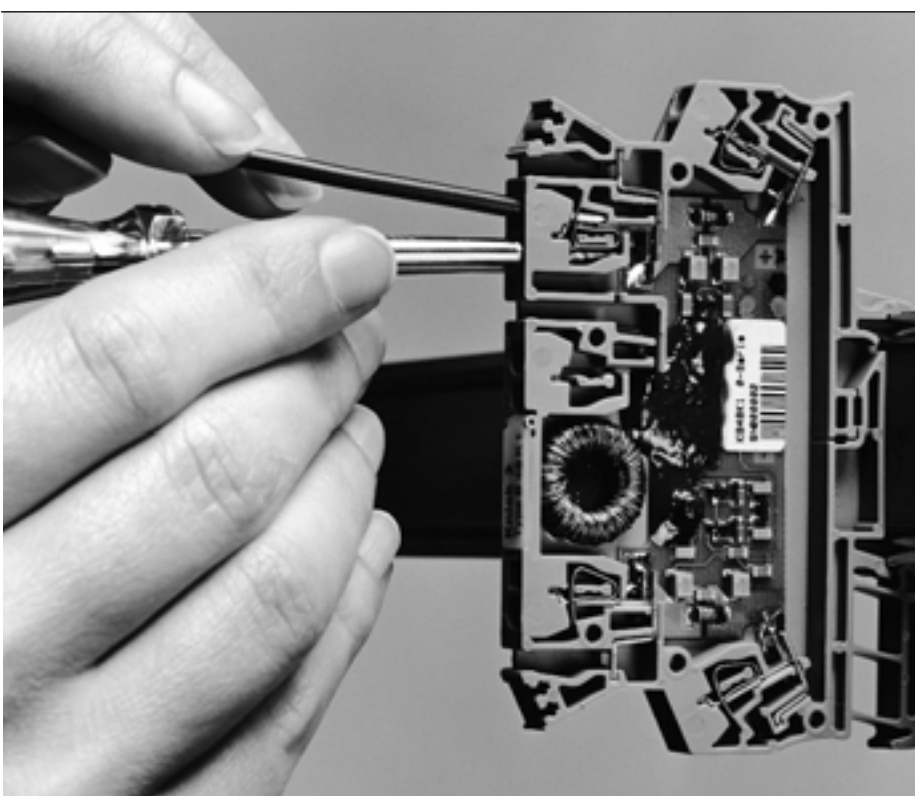

Product line

Devices	Input	Output	Order no.
IsoTrans® B 48	0 ... 20 mA 4 ... 20 mA	0 ... 20 mA 4 ... 20 mA	B 48 K1

Power supply

None, supply from input signal

Accessories

End plate	Shock-hazard protection for the last isolating terminal in the row, required 1 x per application!	ZU 0286
-----------	---	---------

Specifications

Input data

Input	0 ... 20 mA (linear transmission up to 22 mA)
Operating current	< 100 μ A
Voltage drop	Approx. 2.7 V at 20 mA
Overload	50 mA, 15 V

Output data

Output	0 ... 20 mA, \leq 500 Ohms
Residual ripple	< 10 mV _{rms}

Transmission behavior

Transmission error	< 0.1 % full scale
Load error	< 0.05 % meas.val./100 Ohms
Response time (T ₉₉)	Approx. 5 ms at 500 Ohm load
Temperature influence ¹⁾	< 0.005 %/K full scale per 100 Ohm load (reference temperature 23 °C)

Isolation

Test voltage	510 V AC
Working voltage	100 V with overvoltage category II and pollution degree 2 according to EN 61010-1

¹⁾ Average TC in specific working temperature range -25 °C ... +60 °C

Specifications, continued

Standards and approvals

EMC ²⁾	89/336/EEC directive, EN 61326
-------------------	--------------------------------

Other data

Ambient temperature	Operation: -25 ... +60 °C also when mounted in a row Transport and storage: -40 ... +8 °C
---------------------	--

Enclosure	Terminal case, 6 mm width, terminal using Z-spring technology See dimension drawings for further measurements
-----------	--

Protection class	IP 20 in row or with end plate
------------------	--------------------------------

Mounting	For 35 mm top hat rail EN 50022 see dimension drawings for conductor cross section
----------	---

Weight	12 g
--------	------

2) Applies to 4 ... 20 mA, slight deviations are possible while there is interference

Input voltage

Depending on the load at $I_o = 20$ mA

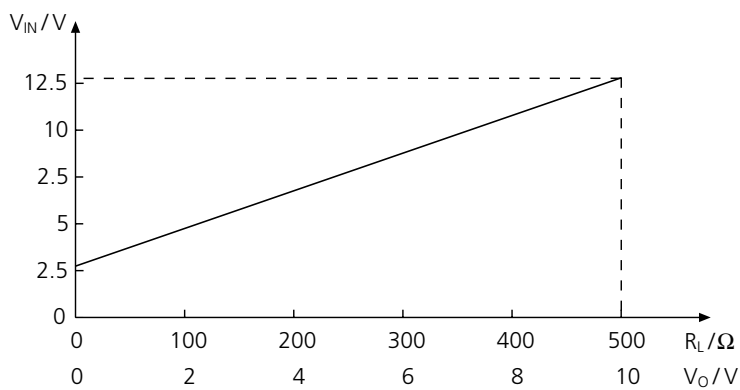

Schematic diagram

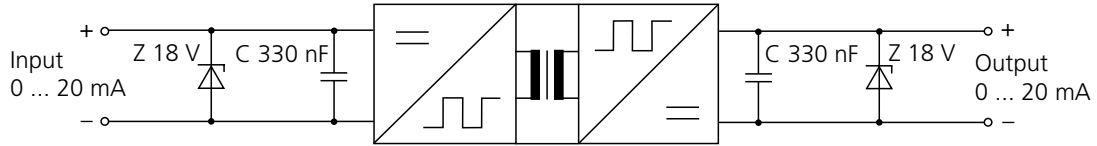

Dimension drawings and terminal assignments

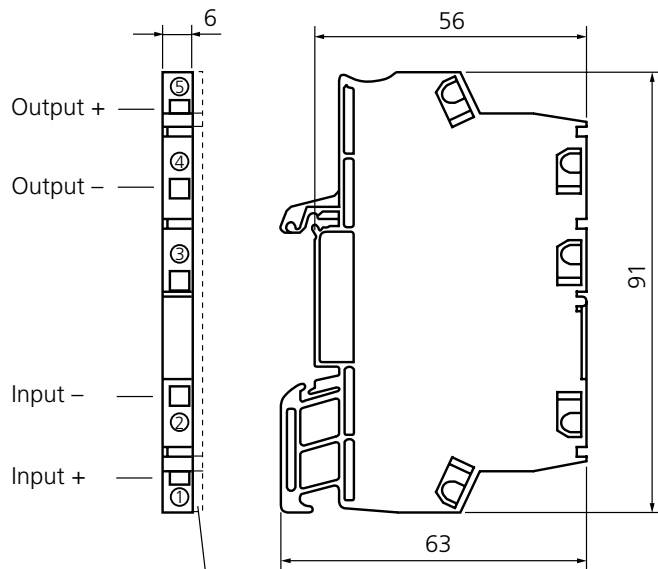

ZU 0286 end plate, 1.5 mm wide, only required for last isolator in row as shock-hazard protection

Conductor cross sections:

Single-wire	0.5 ... 2.5 mm ²
Fine-wire	0.5 ... 2.5 mm ²
With ferrule	0.5 ... 1.5 mm ²

All dimensions in mm.

IsoAmp® 23000/24000

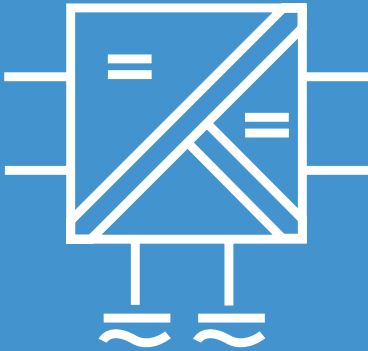

For conversion of shunt voltages to impressed ± 20 mA or ± 10 V signals

The task

Conversion of bipolar mV voltages with high accuracy into 0 ... ± 20 mA or 0 ... ± 10 V signals.

The problems

The high voltages occurring at the operating site will cause substantial measuring errors that could lead to unwanted shutdown of whole sections of the system if there is insufficient isolation and common mode rejection.

The solution

The DC isolation amplifiers from the IsoAmp® 23000/24000 series have been specially conceived for measurements on low-resistance signal sources, for example, shunt resistances. Frequent problems like common-mode interference or interferences from phase control are suppressed effectively.

The isolators provide safe isolation and high insulation from the input to the output and to the power supply.

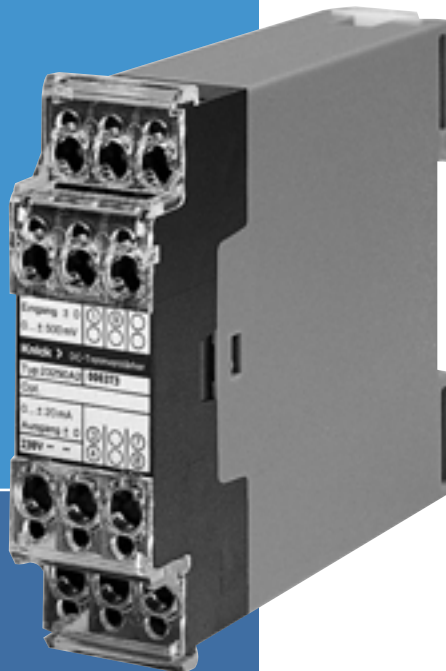

Warranty
5 years!

Defects occurring within 5 years from delivery are remedied free of charge at our plant (carriage and insurance paid by sender).

The enclosure

The DC isolation amplifiers from the IsoAmp® 23000/ 24000 series work in 22.5 mm wide modular cases optionally with a 230 V AC, 115 V AC or 24 V AC/DC power supply.

The advantages

A specially developed chopper circuit allows these isolators to have extraordinarily high values for

- long-term stability
- transmission accuracy
- disruptive strength

The technology

The proven Knick vacuum encapsulation method allows maximum long-term protection against aggressive environmental influences, shock and vibrations.

Their high zero stability and excellent linearity values make the DC isolation amplifiers from the IsoAmp® 23000/24000 series ideally suited to transmissions both in DC and AC applications up to 5 kHz.

The facts

- **Effective interference suppression**
prevention of incorrect measurements or failure due to interference, for example, with high-rated shunt resistors in converters.
- **Safe isolation in accordance with EN 61140,**
protection against unpermitted high voltages
- **3-port isolation**
protection against incorrect measurements or damage
- **Test voltage 7 kV AC**
safety also with high potential differences between input and output
- **No additional power supply**
230 V AC power supply, optional 24 V AC/DC or 115 V AC for supply of the amplifier
- **Modular case 22.5 mm**
straightforward installation due to compact design
- **Maximum reliability**
no repair and failure costs
- **Full encapsulation**
reliable functioning also in aggressive atmospheres or with considerable mechanical loading, for example, due to vibrations
- **5-year warranty**

Product line

Devices

Input	Output	Order no.
0 ... ±60 mV	0 ... ±20 mA	23206 A2
0 ... ±150 mV	0 ... ±20 mA	23215 A2
0 ... ±300 mV	0 ... ±20 mA	23230 A2
0 ... ±500 mV	0 ... ±20 mA	23250 A2
0 ... ±60 mV	0 ... ±10 V	24206 A2
0 ... ±150 mV	0 ... ±10 V	24215 A2
0 ... ±300 mV	0 ... ±10 V	24230 A2
0 ... ±500 mV	0 ... ±10 V	24250 A2

Power supply

230 V AC	
24 V AC/DC	336
115 V AC	363

Options

Only 23000: Rectifier in signal path	152
Gain adjustment to customer requirements from ±60 ... ±500 mV	500
Gain adjustment to customer requirements from ±100 ... ±1200 V In A10 housing (see dimension drawing)	496
Increased test voltage 8.5 kV AC	514

Specifications

Input data	2x206	2x215	2x230	2x250
Input ¹⁾	0 ... ±60 mV	0 ... ±150 mV	0 ... ±300 mV	0 ... ±500 mV
Input resistance	> 25 kOhm			
Offset current	≤ 200 nA			
Temperature coefficient of the current	4 nA/K (Reference temperature 23 °C)			
Offset voltage	≤ 50 μV	≤ 100 μV	≤ 150 μV	≤ 200 μV
Temperature coefficient of the voltage	2 μV/K (Reference temperature 23 °C)			
Overload	≤ 150 mA limitation with suppressor diode to 7 V			

1) Other voltages (up to 500 mV) on request

Specifications, continued

Output data	23xxx	24xxx
Output	0 ... ±20 mA	0 ... ±10 V
Load	≤ 10 V	≤ 20 mA
Residual ripple	< 10 mV _{pp}	< 10 mV _{pp}

Transmission behavior

Gain error	< 0.1 % meas. val.	
Cut-off frequency	Approx. 5 kHz –3 dB	
Common mode rejection ratio	CMRR ²⁾ Approx. 160 dB (DC / AC: 50 Hz)	T-CMR ³⁾ Approx. 115 dB (1000 V, tr = 1 µs)
Temperature coefficient	0.0025 %/K (reference temperature 23 °C)	

Power supply

Power supply	230 V AC –15 % +10 %, 48 ... 62 Hz, approx. 2 VA	
Opt. 336:	24 V AC/DC AC: –15 % +10 %, 48 ... 500 Hz, approx. 0.6 VA DC: –15 % +20 %, approx. 0.6 W	
Opt. 363:	115 V AC –15 % +10 %, 48 ... 62 Hz, approx. 2 VA	

Isolation

Galvanic isolation	3-port isolation between input, output and power supply	
Test voltage	7 kV AC (input against output/power supply) 4 kV AC (output against power supply)	
Working voltage	2000 V DC ⁴⁾ input against output and power supply with overvoltage category II and pollution degree 2, 1000 V DC output against power supply with overvoltage category II and pollution degree 2, according to EN 61010-1 For applications with high working voltages, you should ensure there is sufficient spacing or isolation from neighboring devices and protection against electrical shocks.	
Protection against electrical shock	Safe isolation according to EN 61140 by reinforced insulation in accordance with EN 61010-1. Working voltages up to overvoltage category III and pollution degree 2 Up to 500 V AC/DC input against output and power supply Up to 300 V AC/DC output against power supply. For applications with high working voltages, you should ensure there is sufficient spacing or isolation from neighboring devices and protection against electrical shocks.	

$$2) \text{ Common-Mode Rejection Ratio} = \frac{\text{Differential-mode voltage gain}}{\text{Common-mode voltage gain}} \quad 3) \text{ Transient Common-Mode Rejection} = \frac{\text{Differential-mode DC voltage gain}}{\text{Common-mode transient crest value gain}}$$

4) For circuits according to table 6 from EN 61010-1 (transient overvoltage 2600 V)

Reference temperature for TC specifications 23 °C, the average TC is always specified

Specifications, continued

Standards and approvals

Surge withstand	5 kV 1.2/50 μ s according to IEC 255-4
EMC	EMC directive 89/336/EEC

Other data

Ambient temperature	Operation: $-10 \dots +70 \text{ }^\circ\text{C}$ Transport and storage: $-30 \dots +80 \text{ }^\circ\text{C}$
Enclosure	Modular case, width 22.5 mm, see dimension drawing for other measurements
Protection class	IP 40, terminals IP 20
Mounting	With snap-on mounting for 35 mm top hat rail according to EN 50022 or M4 screw mounting M4, see dimension drawing for conductor cross section
Weight	Approx. 250 g

Schematic diagram

IsoAmp® 23000 series

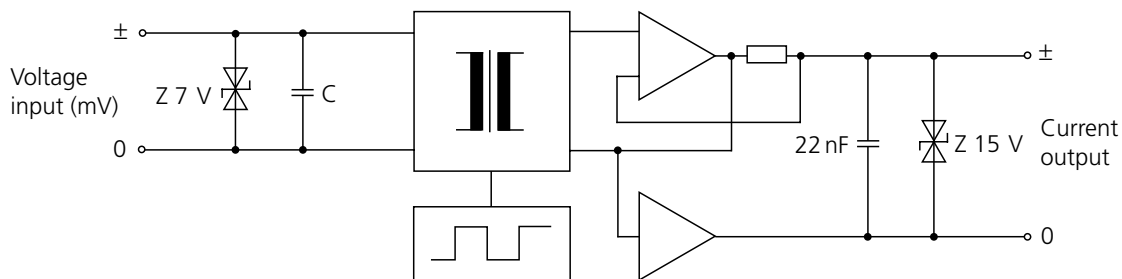

IsoAmp® 24000 series

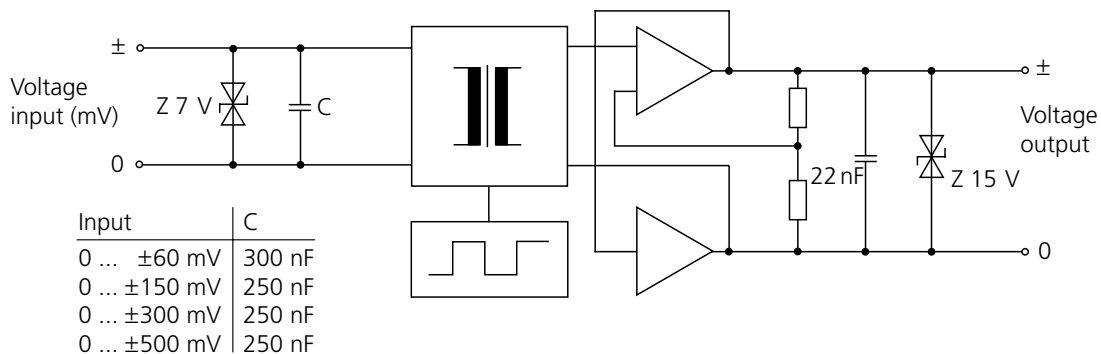

Dimension drawings and terminal assignments

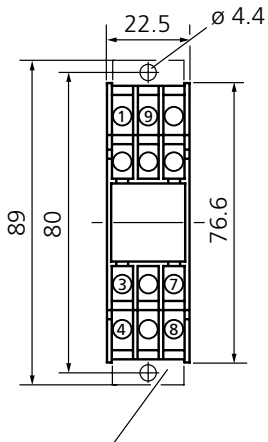

Screw mounting with extending lugs

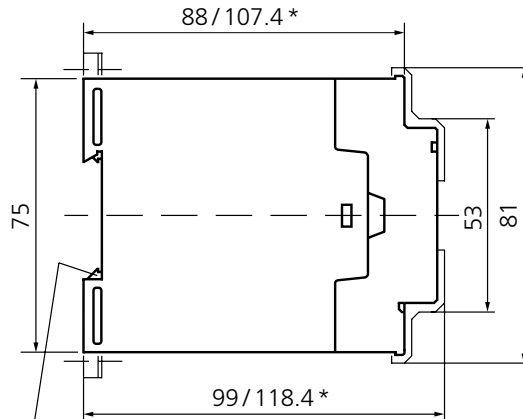

Snap-on mounting on 35 mm top hat rail EN 50022

* With Option 496: A 10 enclosure

- | | |
|----------------|---|
| 1 Input | + |
| 9 Input | - |
| 3 Output | + |
| 7 Output | - |
| 4 Power supply | ~ |
| 8 Power supply | ~ |

All dimensions in mm.

Connecting screws M 3 x 8 with self-releasing clamping pieces, max. conductor cross section 2 x 1.5 mm² solid or 2 x 1.0 mm² stranded wire with ferrule

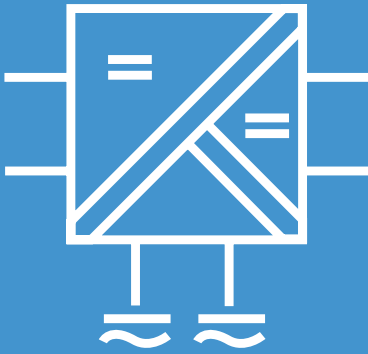

IsoAmp® PWR A 20100

Repeater power supply in 6-mm case

The task

The flexible and safe supply of 2-wire transmitters via the 4 ... 20 mA measuring line with simultaneous transmission of data protocols for SMART transmitters / HART® communication. Conversion of the output signal to 0 ... 20 mA or 0 ... 10 V if necessary.

The problems

Good isolator properties in conjunction with high transmission accuracy often lead to complex systems that cost space and money.

The galvanic isolation of the supply and signal processing is frequently indispensable to exclude measuring problems from the start. The selection of possible alternatives within the budget is often limited.

The solution

Knick is the first manufacturer to supply a repeater power supply in an extremely compact 6-mm case for 2-wire transmitters: IsoAmp® PWR A 20100. It supplies the transmitter with power and transmits the measuring signal galvanically isolated to the output with a high level of accuracy. In case a signal other than the 4 to 20 mA signal is required, you can select output signals on the repeater power supply using DIP switches. HART® signals are of course transmitted without alteration. The width of just 6 mm also allows use of the repeater power supply in the tightest of spaces.



Warranty
5 years!

Defects occurring within 5 years from delivery are remedied free of charge at our plant (carriage and insurance paid by sender).

The enclosure

Structure in tried and tested modular case with 6.1 mm width and screw terminals. The outputs are switched using DIP switches that can be accessed without opening the case.

The advantages

The new IsoAmp® PWR A 20100 repeater power supply unites small dimensions with excellent features. Safe isolation and 0.1 % accuracy also allow use for applications with higher requirements.

The technology

The output signal can be switched between 0 ... 20 mA, 4 ... 20 mA and 0 ... 10 V. The ranges are calibrated and selected via DIP switches.

In addition to the analog signal, the repeater power supply transmits data protocols for SMART transmitters (according to the HART® specification). It allows bidirectional communication with the field device via a host computer or HART® communicators (hand-held communicator).

The facts

- **Powerful supply**
of 4 to 20 mA loop-powered 2-wire transmitters
- **Extremely flat**
3-port isolation in a 6 mm enclosure
- **Flexible and highly accurate**
calibrated output signal switching
- **Simple and fast configuration**
switching with DIL switches on the side so they are easy to access and still protected against accidental adjustment
- **Low-cost assembly**
supply of the measuring supply circuit and galvanic isolation of the measuring signal in one unit
- **Safe isolation**
in accordance with EN 61140 up to 300 V
- **SMART transmitter**
(according to HART® specification)
- **Cross-connections for power supply**
power supply only wired once for almost any number of parallel repeater power supplies
- **5-year warranty**

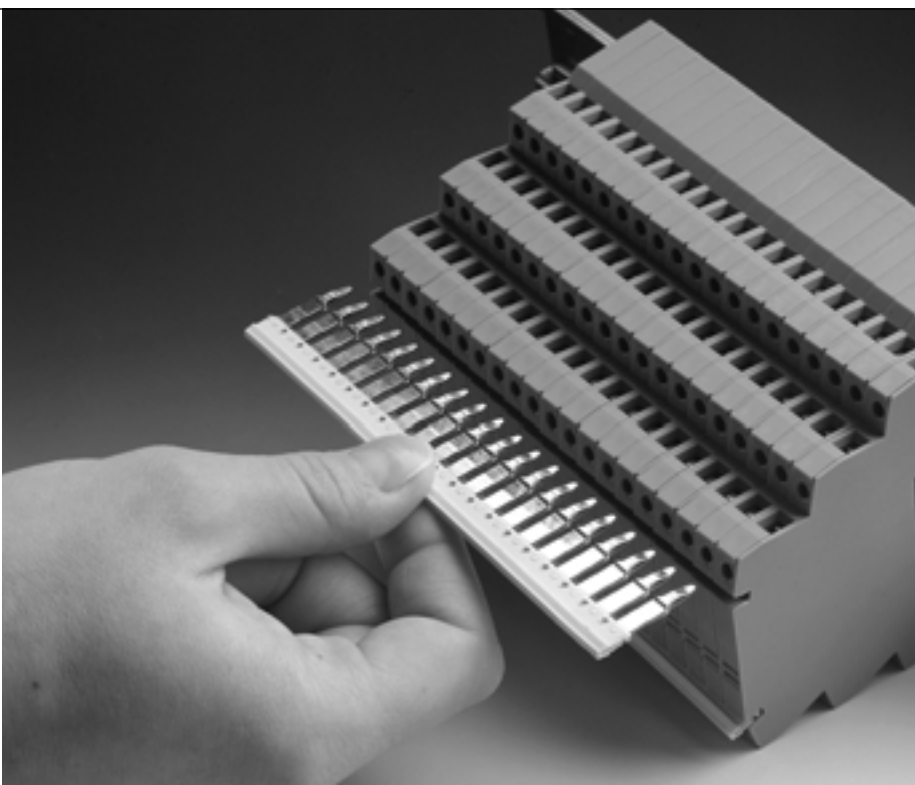

Product line

Devices	Input	Output	Order no.
IsoAmp® PWR A 20100	4 ... 20 mA	4 ... 20 mA 0 ... 20 mA 0 ... 10 V calibrated selection	A 20100 F0

Power supply

24 V DC

Specifications

Input data

Input (current loop)	Supply voltage 16.5 V, constant for 3 ... 22 mA, current limited to max. 25 mA
Residual ripple	< 10 mV _{rms}

Output data

Output	4 ... 20 mA, 0 ... 20 mA or 0 ... 10 V calibrated selection
Output signal with input short-circuit	22 ... 25 mA or 11 ... 12.5 V
Output signal with open input	< 3 mA or 0 for outputs 0 ... 20 mA or 0 ... 10 V
Load with output current with output voltage	≤ 10 V (≤ 500 Ohms at 20 mA) ≤ 1 mA (≤ 10 kOhms at 10 V)
Offset Current output ¹⁾ Voltage output	< 30 μA < 30 mV
Residual ripple at output	< 10 mV _{rms}

Transmission behavior

Gain error Current output Voltage output	< 0.1 % meas. val. < 0.2 % meas. val.
Response time	< 2 ms

1) Additional error 30 μA for output 0 ... 20 mA

Specifications, continued

Transmission behavior

Communication ²⁾ (Output 4 ... 20 mA)	Bidirectional transmission of FSK signals between output and current loop according to the HART® specification
---	--

Power supply

Power supply	24 V DC (±15 %), approx. 1 W The power supply can be routed from one device to another via cross-connections.
--------------	--

Isolation

Galvanic isolation	3-port isolation between input, output and power supply
Test voltage	2.5 kV AC current loop against output/power supply 510 V AC output against power supply
Working voltage (basic isolation)	Up to 600 V AC/DC with overvoltage category II and pollution degree 2 Between current loop and output/power supply. Up to 100 V AC/DC between output power with category II and degree 2 according to EN 61010-1. For applications with high working voltages, you should ensure there is sufficient spacing or isolation from neighboring devices and protection against electrical shocks.

Standards and approvals

Protection against electrical shock	Safe isolation according to EN 61140 by reinforced insulation in accordance with EN 61010-1. Up to 300 V with overvoltage category II and pollution degree 2 between current loop and output/power supply For applications with high working voltages, you should ensure there is sufficient spacing or isolation from neighboring devices and protection against electrical shocks.
EMC ²⁾	Product standard: EN 61326 Emitted interference: Class B Immunity to interference: Industry
Approval	cUL (applied for)

2) Slight deviations are possible while there is interference

Specifications, continued

Other data

Ambient temperature	Operation: 0 ... +55 °C Transport and storage: -25 ... +85 °C
Enclosure	Modular case with screw terminals, width 6.1 mm See dimension drawings for further measurements
Protection class	IP 20
Mounting	For 35 mm top hat rail to EN 50022 See dimension drawings for conductor cross section
Weight	Approx. 50 g

Schematic diagram

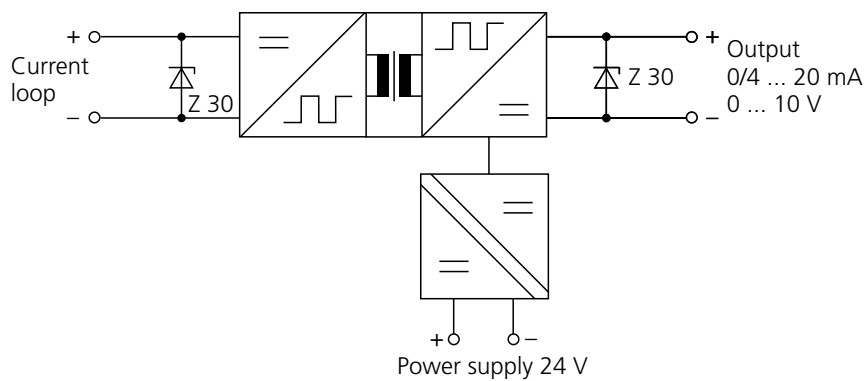

Application example

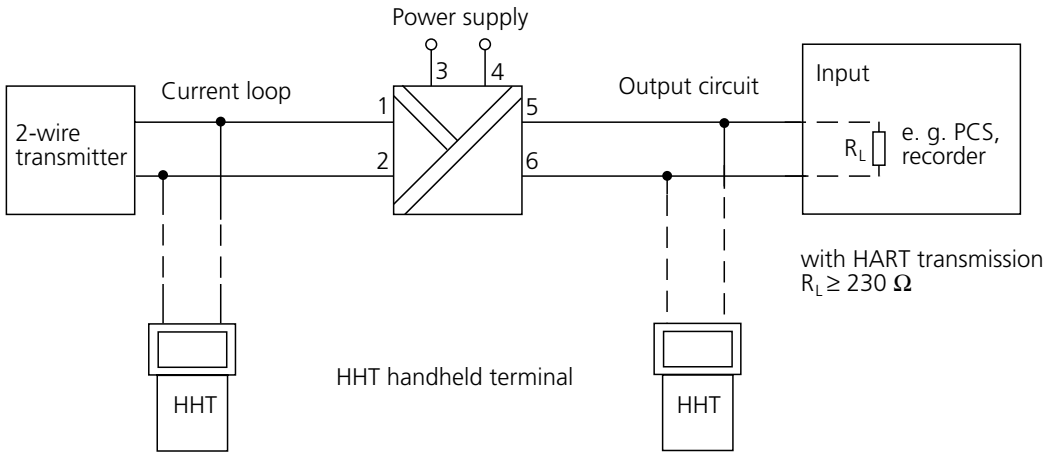

Application example

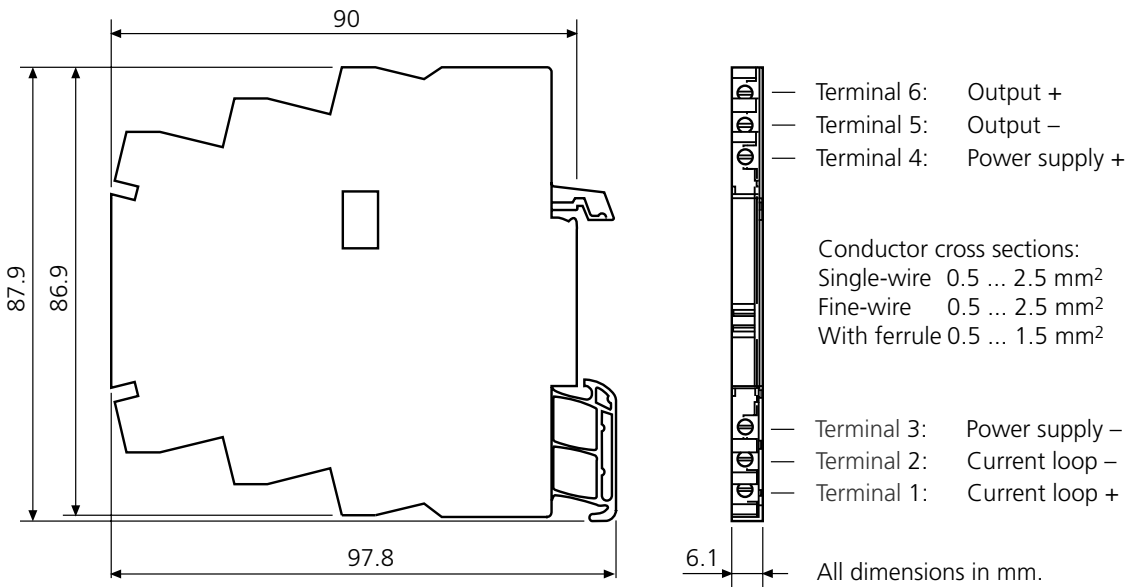

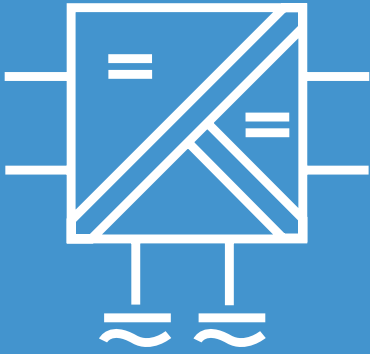

IsoAmp® PWR B 10116

Repeater power supply in 6-mm case

The task

The supply of 2-wire transmitters via the measuring line and the 1:1 transmission of 4 ... 20 mA measuring signals.

The problems

In many cases, space is limited at the operating site and furthermore the additional expense for the supply devices and galvanic isolation require two separate devices.

The solution

We supply one of the narrowest repeater power supplies at an extremely attractive price. The IsoAmp® PWR 10116 supplies the transmitter with power and transmits the measuring signal galvanically isolated from the output with a high level of accuracy. A high supply voltage allows use with almost all commercially available 2-wire transmitters.



Warranty
5 years!

Defects occurring within 5 years from delivery are remedied free of charge at our plant (carriage and insurance paid by sender).

The enclosure

Assembly in 6-pin terminal block housing with 6.1 mm row width. Connection with screw terminals.

The advantages

The new IsoAmp® PWR B 10116 repeater power supply unites excellent technology with unbeatable value for money.

The technology

Transformer transmission of signals and energy. The output signal is permanently set to 4 ... 20 mA.

The facts

- **Powerful supply**
of 4 to 20 mA loop-powered 2-wire transmitters
- **Extremely flat**
3-port isolation in a 6 mm modular case
- **Low-cost assembly**
supply of the current loop and galvanic signal isolation in one unit
- **Safety in the smallest of spaces**
3-port isolation in a 6 mm enclosure
- **Supplies all common signal sources**
- **Power supply 24 V DC**
- **Cross-connections for power supply**
power supply only wired once for almost any number of parallel repeater power supplies
- **5-year warranty**

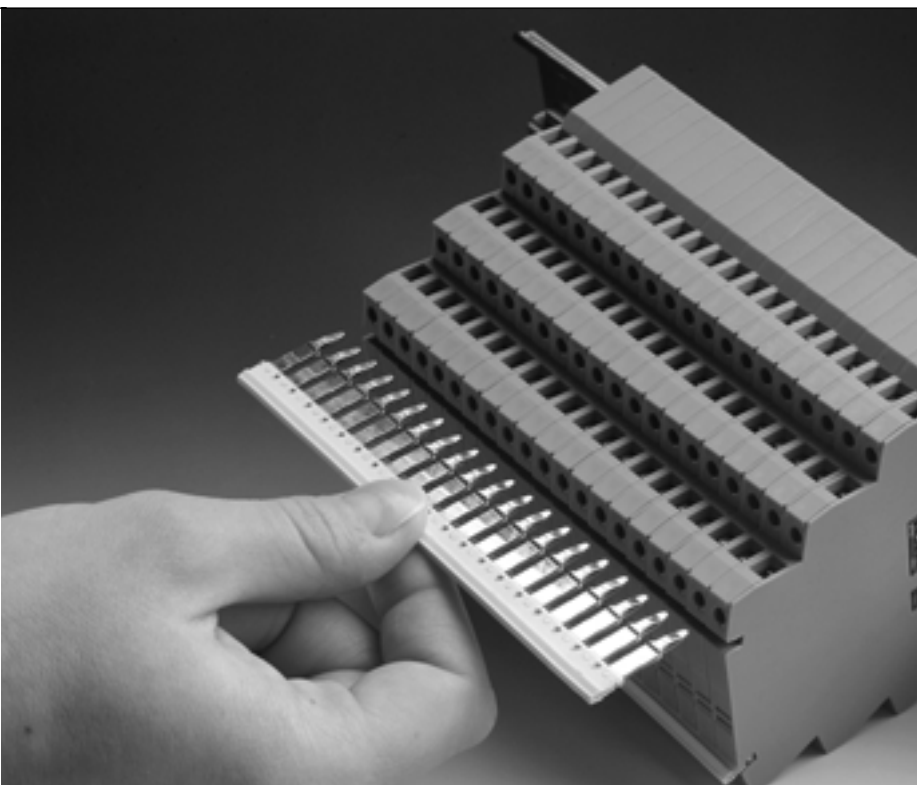

Product line

Devices	Input	Output	Order no.
IsoAmp® PWR B 10116	4 ... 20 mA	4 ... 20 mA	B 10116 F0
Power supply			
24 V DC			

Specifications

Input data

Input (current loop)	Supply voltage 16.5 V, constant for 3 ... 22 mA, current limited to max. 25 mA
Residual ripple	< 10 mV _{rms}

Output data

Output	4 ... 20 mA
Output signal with input short-circuit	22 ... 25 mA
Output signal with open input	< 3 mA
Load	≤ 10 V (≤ 500 Ohms at 20 mA)
Offset	< 30 μA
Residual ripple at output	< 10 mV _{rms}

Transmission behavior

Gain error	< 0.1 % meas. val.
Response time	< 5 ms

Power supply

Power supply	24 V DC (±15 %), approx. 1 W The power supply can be routed from one device to another via cross-connections.
--------------	--

Specifications, continued

Isolation

Galvanic isolation	3-port isolation between input, output and power supply
Test voltage	1.5 kV AC current loop against output/power supply 510 V AC output against power supply
Working voltage (basic isolation)	Up to 300 V AC/DC with overvoltage category II and pollution degree 2 between current loop and output/power supply. Up to 100 V AC/DC between output and power supply with category II and degree 2 according to EN 61010-1. For applications with high working voltages, you should ensure there is sufficient spacing or isolation from neighboring devices and protection against electrical shocks.

Standards and approvals

EMC ¹⁾	Product standard	EN 61326
	Emitted interference:	Class B
	Immunity to interference:	Industry
Approval	cUL (applied for)	

Other data

Ambient temperature	Operation:	0 ... +55 °C
	Transport and storage:	-25 ... +85 °C
Enclosure	Modular case, width 6.1 mm, see dimension drawing for other measurements, with screw terminals	
Protection class	IP 20	
Mounting	For 35 mm top hat rail to EN 50022 See dimension drawings for conductor cross section	
Weight	Approx. 50 g	

1) Slight deviations are possible while there is interference

Schematic diagram

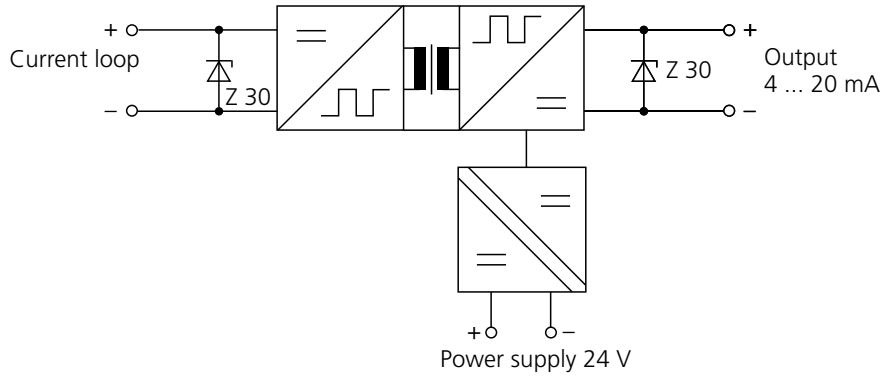

Application example

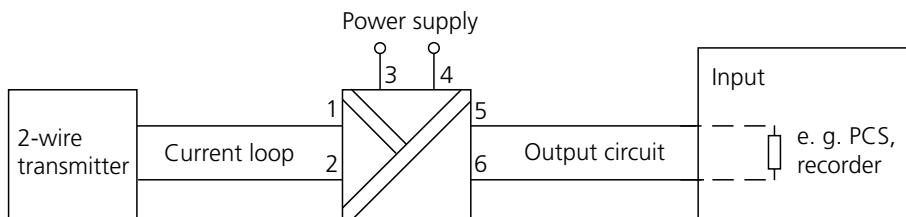

Dimension drawings and terminal assignments

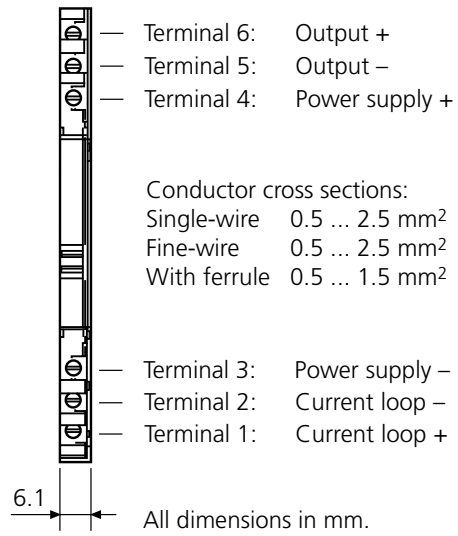
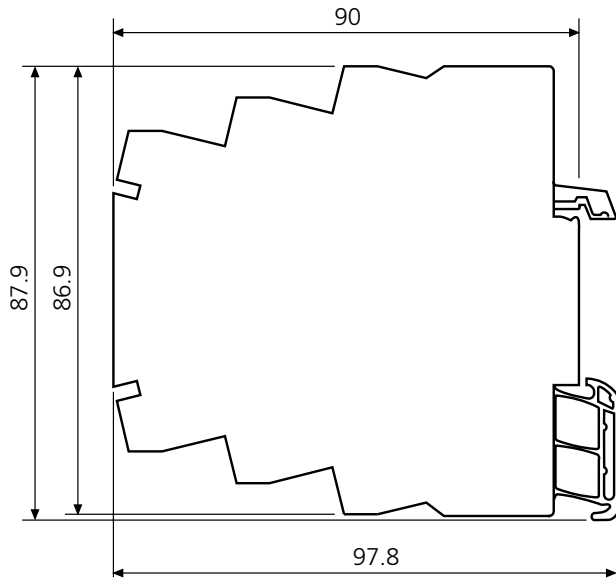

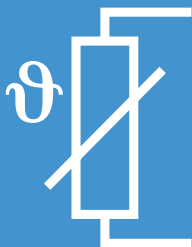

ThermoTrans® 205/206

The practical solution for temperature measurement with resistance thermometers.

The ThermoTrans® 205/206 temperature transmitters provide you with the flexibility you need:

- Adjustment work where it is only really necessary, instead of complicated parameter tables.

- High level of reliability and compact design due to digital signal processing specially developed for the measuring task instead of unnecessary reduction in reliability due to overburdening with complicated technology.

For the majority of the standard applications with fixed preset parameters, you simply select one of the numerous pre-configured standard models.

You can solve special measuring tasks with a transmitter that we configure according to your specifications.

Configuration or adaptation to the measuring task is also not a problem "on site" via the optical interface. The user-friendly, menu-guided Paraly® communication software is supplied together with a fiber-optic cable incl. PC adapter.

The ThermoTrans® 205/206 temperature transmitters provide safe isolation and high insulation resistance between the input, output and power supply.

Vacuum encapsulation protects the devices against aggressive environmental influences, shock and vibrations.



Warranty
5 years!

Defects occurring within 5 years from delivery are remedied free of charge at our plant (carriage and insurance paid by sender).

ThermoTrans® 205/206 for resistance thermometers.

Resistance thermometers are highly accurate temperature sensors with long-term stability for measuring temperatures up to max. 850 °C.

They are mainly used to measure low and medium temperatures, for example, in air-conditioning, process engineering and the food industry.

The ThermoTrans® 205/206 transmitters allow connection of all common resistance thermometers either in 2, 3 or 4-wire circuits.

The possibility for connecting resistance-type sensors and potentiometers creates a wide range of application possibilities, for example, in the field of position measurement. Converting the input signal into a proportional current/voltage signal allows simple further processing.

The facts

- **Extensive range of standard models**
for standard applications, configuration not necessary
- **Adjustable via optical interface**
universal for a wide range of measuring tasks, can also be configured "on site"
- **Paraly® PC configuration software with tag database**
simple, menu-guided configuration in accordance with VDI/VDE 2187, archiving of configuration data
- **Safe isolation in accordance with EN 61140**
protection of the maintenance staff and the subsequent devices against non-permitted high voltages
- **22.5 mm wide modular case with 73.5 mm standard height**
compact design means easy installation, also easy to fit in standard cabinets
- **5-year warranty**



- ▲ You can use the menu-guided Paraly® communication software (according to VDI/VDE 2187) to configure the transmitters. Data from different measuring points can be easily archived and managed in the corresponding tag database.

Product line

		ThermoTrans® 205 with current output	ThermoTrans® 206 with voltage output
Adjustable models	Order No. Adjustable via interface. See Configuration Schedule for factory setting.	205 A7 000 000	206 A7 000 000
Fixed-range standard models	Order no.	205 A7 x xx xx x	206 A7 x xx xx V
Sensors	Pt 100 (–200 ... +850 °C) Pt 1000 (–200 ... +850 °C) Ni 100 (–60 ... +180 °C) 1000 Ohms 5000 Ohms	A B C D E	A B C D E
Span	50 K 100 K 150 K 200 K 300 K 400 K 1000 Ohms 5000 Ohms	05 10 15 20 30 40 70 88	05 10 15 20 30 40 70 88
Start of scale	–100 °C –50 °C 0 °C 50 °C 100 °C 200 °C 0 Ohm	02 01 00 11 12 14 30	02 01 00 11 12 14 30
Output	0 ... 20 mA 4 ... 20 mA 0 ... 10 V	D L	V

Sensors with 4-wire connection (3-wire connection Opt. 494), rising output curve, without filter constant
 ThermoTrans® 205: open circuit recognition 22 mA; ThermoTrans® 206: open circuit recognition 11 V

Power supply	Order no.
230 V AC	
24 V AC/DC	336
115 V AC	363

Options

ThermoTrans® 205/206 standard model with 3-wire connection	494
--	-----

Accessories

Communications kit	For configuration of the temperature transmitter, with tag database according to VDI/VDE 2187, consisting of: – Optical fibre connecting cable 3 m – Adapter D-Sub 9-pole – D-Sub 25-pole – Optical interface adapter – RS 232 – Paraly® configuration software and tag database	ZU 0254
--------------------	--	---------

Product line

		ThermoTrans® 205 with current output	ThermoTrans® 206 with voltage output
Customer-specific models	Order no.	205 A7 999 999	206 A7 999 999

Configuration schedule

Important! Please fill in the configuration schedule completely and enclose it with your order. If entries are missing, the value entered in square brackets or the dark-colored setting will be set.

ThermoTrans® 205/206

Sensor ¹⁾	Temperature probe: <input checked="" type="checkbox"/> Pt 100 according to IEC 751 <input type="checkbox"/> Pt 500 <input type="checkbox"/> Pt 1000 <input type="checkbox"/> Ni 100 according to IEC 43 760 <input type="checkbox"/> Ni 120 <input type="checkbox"/> Ni 500 <input type="checkbox"/> Ni 1000
	Resistance sensor or potentiometer: <input type="checkbox"/> ≤500 Ohms <input type="checkbox"/> ≤5000 Ohms
Connection	<input type="checkbox"/> 2-wire connection Lead resistance ²⁾ _____ . _____ Ohms <input type="checkbox"/> 3-wire connection <input checked="" type="checkbox"/> 4-wire connection
Range	Start of scale ²⁾ _____ °C [0 °C] or _____ Ohms Span ²⁾ _____ K [100 K] or _____ Ohms
Output ³⁾	<input checked="" type="checkbox"/> 0 ... 20 mA <input type="checkbox"/> 4 ... 20 mA <input type="checkbox"/> 0 ... 10 V
Curve	<input checked="" type="checkbox"/> Rising <input type="checkbox"/> Falling
Error messages	Message: <input checked="" type="checkbox"/> only with open circuit <input type="checkbox"/> with open circuit and overrange
	Signal: <input checked="" type="checkbox"/> 22 mA or 11 V <input type="checkbox"/> -1 mA or -0.5 V
Filter constant T ₉₉	_____ s ²⁾ (1st order filter) [0 s]
Tag number	_____ [none]

1) Other models on request
 3) Other values on request

2) See specifications for the possible parameter range

Specifications

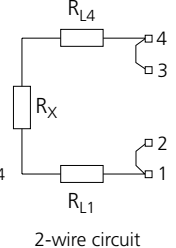
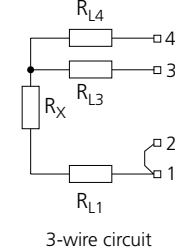
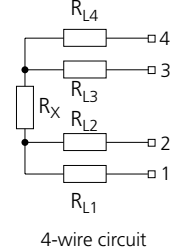
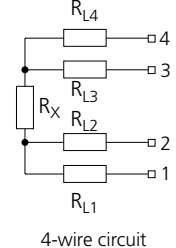
Input data	Sensor type	Measurement range	Span (user-defined)
	Pt 100 to IEC 751 Pt 500 Pt 1000	-200 ... +850 °C	25 ... 1050 K
	Ni 100 to DIN 43760 Ni 120 Ni 500 Ni 1000	-60 ... +180 °C	25 ... 240 K
	Remote resistance sensors and potentiometers	0 ... 500 Ohms or 0 ... 5000 Ohms	9 ... 500 Ohms or 90 ... 5000 Ohms
Connection	2-wire connection: configured line resistance is calculated in the measured value		
	3-wire connection: $R_{L1} = R_{L4}$		
	4-wire connection	2-wire circuit	3-wire circuit
	Max. line resistance	$R_{L1} + R_{L4} = 100$ Ohms	
	Sensor current	Approx. 1 mA or 0.1 mA depending on the measuring range	
	Open-circuit voltage	< 5 V	
	Sensor failure monitoring	All inputs for open circuit	
	Input error limits	Resistance: Range 0 to 500 Ohms	± 0.05 Ohm
		Range 0 to 5 kOhms	± 0.5 Ohm
		with Pt: Range -200 ... +850 °C	± 0.2 K
		with Ni: Range -60 ... +180 °C	± 0.2 K
	Temperature coefficient at input	0.0025 %/K full scale (average TC in permitted operating temperature range, reference temperature 23 °C)	
Output data	Output signal (0 ... 100 %)	Model 205: 0/4 ... 20 mA, impressed current, load voltage ≤ 10 V Model 206: 0 ... 10 V, impressed voltage, load current ≤ 10 mA	
	Resolution	Approx. 8000 steps (for 0 ... 100 %)	
	Control range	-2.5 % ... 102.5 % of span	
	Overrange with error message	Model 205: - 1.0 mA or 22 mA Model 206: -0.5 V or 11 V	
	Output error limits	0.1 % full scale	
	Temperature coefficient at output	0.01 %/K full scale (average TC in permitted operating temperature range, reference temperature 23 °C)	
	Residual ripple at output	< 10 mV _{pp} + digitalization error of input	

Specifications, continued

Transmission behavior

Characteristic	Resistance or temperature-linear rising or falling
Meas. rate	Approx. 1/s
Response time T_{99}	≤ 900 ms
Digital output filter	$T_{99} = 0 \dots 100$ s (1st order filter)

Power supply

Power supply	230 V AC $-15\% +10\%$, 48 ... 62 Hz, approx. 2 VA
Option 336:	24 V AC/DC AC: $-15\% +10\%$, 48 ... 500 Hz, approx. 1.5 VA DC: $-15\% +20\%$, approx. 1.2 W
Option 363:	115 V AC $-15\% +10\%$, 48 ... 62 Hz, approx. 2 VA

Isolation

Galvanic isolation	3-port isolation between input, output and power supply
Test voltage	4 kV AC (input against output and power supply) 3 kV AC (output against power supply)
Working voltage (basic isolation)	1000 V AC/DC input against output and power supply with overvoltage category II and pollution degree 2, 330 V AC/DC output against power supply with overvoltage category II and pollution degree 2 according to EN 61010-1 For applications with high working voltages, you should ensure there is sufficient spacing or isolation from neighboring devices and protection against electrical shocks.
Protection against electrical shock	Safe isolation according to EN 61140 by reinforced insulation in accordance with EN 61010-1. Working voltages with overvoltage category II and pollution degree 2: 600 V AC/DC for input against output and power supply with overvoltage category II and pollution degree 2: 300 V AC/DC for output against power supply. For applications with high working voltages, you should ensure there is sufficient spacing or isolation from neighboring devices and protection against electrical shocks.

Standards and approvals

Surge withstand	5 kV 1.2/50 μ s according to IEC 255-4
EMC ¹⁾	EMC directive 89/336/EEC, EN 61326; NAMUR recommendation NE 21

1) Slight deviations are possible while there is interference from RF radiation

Specifications, continued

Other data

Interface (only user-definable models)	Optical, interface adapter on RS 232 interface (PC) is included in the ZU 0254 communications kit
Ambient temperature	Operation: -10 ... +60 °C Transport and storage: -30 ... +80 °C
Enclosure	Modular case A7, width 22.5 mm, screw terminals See dimension drawings for further measurements
Protection class	Case IP 40, terminals IP 20
Mounting	With snap-on mounting for 35 mm top hat rail according to EN 50022-35, width 22.5 mm, see dimension drawings for conductor cross section
Weight	Approx. 300 g

Schematic diagram

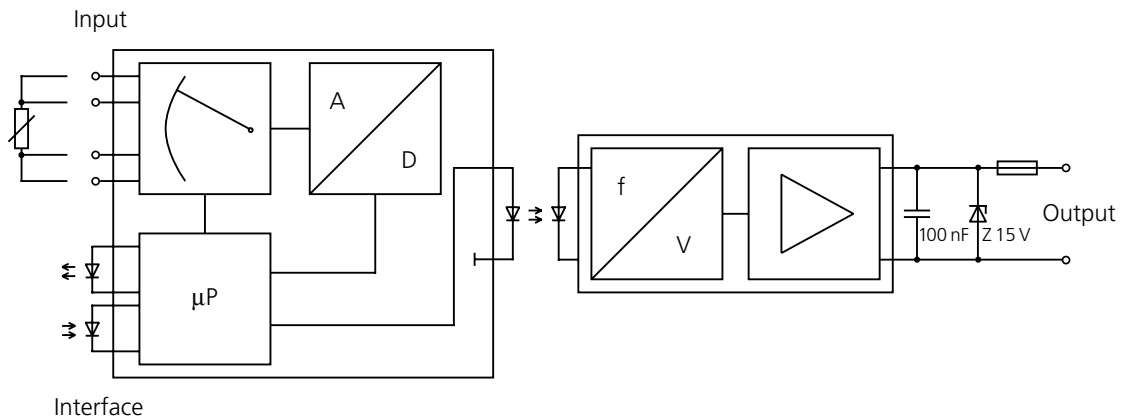

Application examples

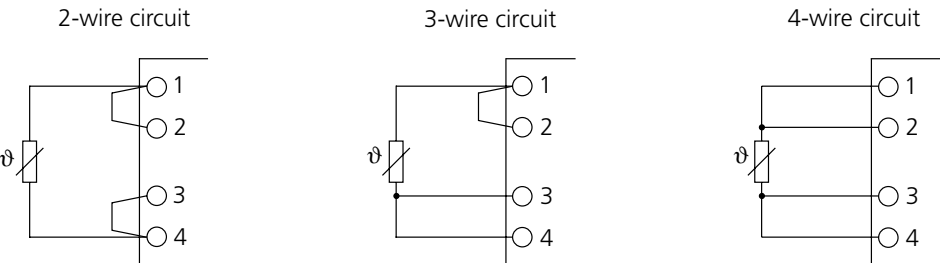

Dimension drawings and terminal assignments

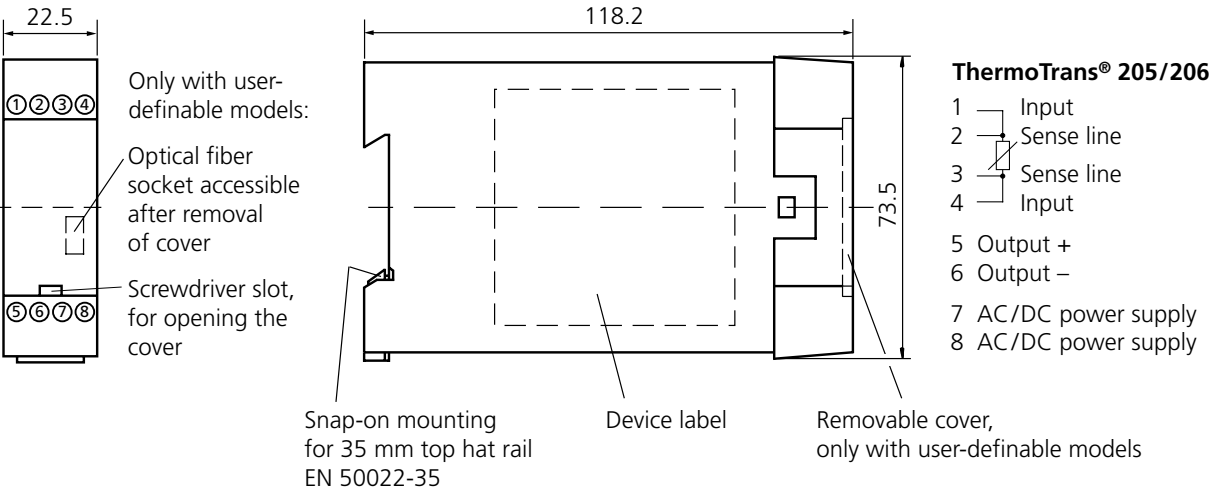

Captive M3x8 clamp screws, box terminals with self-releasing wire protection,
 max. conductor cross section 1 x 4 mm² solid
 1 x 2.5 mm² stranded wire with ferrule
 2 x 1.5 mm² stranded wire with ferrule

All dimensions in mm.

ThermoTrans® 210/211

The practical solution for temperature measurement with thermocouples.

The ThermoTrans® 210/211 temperature transmitters provide you with the flexibility you need:

- Adjustment work where it is only really necessary, instead of complicated parameter tables.

- High level of reliability and compact design due to digital signal processing specially developed for the measuring task instead of unnecessary reduction in reliability due to overburdening with complicated technology.

For the majority of the standard applications with fixed preset parameters, you simply select one of the numerous fixed-range standard models.

You can solve special measuring tasks with a transmitter that we configure according to your specifications.

Configuration or adaptation to the measuring task is also not a problem on site via the optical interface. The user-friendly, menu-guided Paraly® communication software is supplied together with a fiber-optic cable incl. PC adapter.

The ThermoTrans® 210/211 temperature transmitters provide safe isolation and high insulation resistance between the input, output and power supply.

Vacuum encapsulation protects the devices against aggressive environmental influences, shock and vibrations.

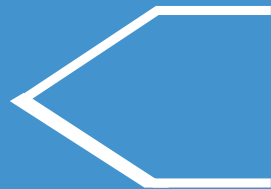

Warranty
5 years!

Defects occurring within 5 years from delivery are remedied free of charge at our plant (carriage and insurance paid by sender).

ThermoTrans® 210/211 for thermocouples.

Thermocouples are very low-resistance and thus noise-free. Their preferred field of application is high temperature ranges, for example, for measurements in ovens, smelting plants and plastic machines.

The range of standard thermocouples is very wide. The ThermoTrans® 210/211 transmitters therefore provide consistent connection possibilities for all regular thermocouples.

To avoid long extension wires, an external reference junction can also be used in addition to the internal one. For thermostatic reference junctions, the reference temperature can be fixed or measured with a Pt 100.

The ThermoTrans® 210/211 transmitters can also be used to measure voltages in the range $-20 \dots +100$ mV with a transfer rate of 1/s. Due to the transfer curve freely configured with various functions or interpolation points, they are intended for difficult measuring tasks, for example, the level in spherical tanks.

The facts

- **Extensive range of standard models**
for standard applications, configuration not necessary
- **Adjustable via optical interface**
universal for a wide range of measuring tasks, can also be configured on site
- **Paraly® PC configuration software with tag database**
simple, menu-guided configuration in accordance with VDI/VDE 2187, archiving of configuration data
- **Safe isolation in accordance with EN 61140**
protection of the maintenance staff and the subsequent devices against non-permitted high voltages
- **22.5 mm wide modular case with 73.5 mm standard height**
compact design means easy installation, also easy to fit in standard cabinets
- **5-year warranty**



- ▲ You can use the menu-guided Paraly® communication software (according to VDI/VDE 2187) to configure the transmitters. The data from different measuring points can be easily archived and managed in the corresponding tag database.

Product line

		ThermoTrans® 210 with current output	ThermoTrans® 211 with voltage output
Adjustable types Adjustable via interface. See Configuration Schedule for factory setting.	Order No.	210 A7 000 000	211 A7 000 000
Fixed-range standard models	Order no.	210 A7 x xx xx x	211 A7 x xx xx V
Sensors	J K S	J K S	J K S
Span	700 K 1000 K 1700 K	60 75 97	60 75 97
Start of scale	0 °C	00	00
Output	0 ... 20 mA 4 ... 20 mA 0 ... 10 V	D L	V

Output curve rising, without filter constant, internal reference junction
 ThermoTrans® 210: open circuit recognition 22 mA; ThermoTrans® 211: open circuit recognition 11 V

Power supply	Order no.
230 V AC	
24 V AC/DC	336
115 V AC	363

Accessories

Communications kit	For configuration of the temperature transmitter, with tag database according to VDI/VDE 2187, consisting of: – Optical fibre connecting cable 3 m – Optical interface adapter – RS 232 – Adapter D-Sub 9-pole – D-Sub 25-pole – Paraly® configuration software and tag database	ZU 0254
--------------------	--	---------

Specifications

Input data

	Sensor type	Range
	Model B DIN/IEC 584-1	0 ... +1820 °C
	Model E DIN/IEC 584-1	-270 ... +1000 °C
	Model J DIN/IEC 584-1	-210 ... +1200 °C
	Model K DIN/IEC 584-1	-270 ... +1372 °C
	Model L DIN 43710	-200 ... +900 °C
	Model N ASTM E 230-87	-270 ... +1300 °C
	Model R DIN/IEC 584-1	-50 ... +1767 °C
	Model S DIN/IEC 584-1	-50 ... +1767 °C
	Model T DIN/IEC 584-1	-270 ... +400 °C
	Model U DIN 43710	-200 ... +600 °C
Voltage input	-20 ... +100 mV	
Input resistance	> 10 MOhms	
Span (configurable)	Min. ≥ 2 mV, max. measuring end – measuring start	
Sensor failure monitoring	All inputs for open circuit (not with voltage measurement)	
Input error limits	$\pm 10 \mu\text{V} + 0.05 \%$ of meas. val.	
Temperature coefficient at input	0.01 %/K full scale (average TC in permitted operating temperature range, reference temperature 23 °C)	
Reference junction input (configurable)	Internal Pt 100	< ± 1.0 K
	External Pt 100	< ± 0.3 K + error of Pt 100 used

Output data

Output signal (0 ... 100 %)	Model 210: 0/4 ... 20 mA, impressed current, load voltage ≤ 10 V Model 211: 0 ... 10 V, impressed voltage, load current ≤ 10 mA	
Resolution	Approx. 8000 steps (for 0 ... 100 %)	
Control range	-2.5 % ... 102.5 % of span	
Overload range with error message	Model 210: -1.0 mA or 22 mA Model 211: -0.5 V or 11 V	
Output error limits	0.1 % full scale	
Temperature coefficient at output	0.01 %/K full scale (average TC in permitted operating temperature range, reference temperature 23 °C)	
Residual ripple at output	< 10 mV _{pp} + digitalization error of input	

Transmission behavior

Characteristic	Temperature-linear, voltage-linear or customer-specific rising or falling	
Meas. rate	Approx. 1/s	
Response time T ₉₉	≤ 900 ms	
Digital output filter	T ₉₉ = 0 ... 100 s (1st order filter)	

Specifications, continued

Power supply

Power supply	230 V AC –15 % +10 %, 48 ... 62 Hz, approx. 2 VA
Option 336:	24 V AC/DC AC: –15 % +10 %, 48 ... 500 Hz, approx. 1.5 VA DC: –15 % +20 %, approx. 1.2 W
Option 363:	115 V AC –15 % +10 %, 48 ... 62 Hz, approx. 2 VA

Isolation

Galvanic isolation	3-port isolation between input, output and power supply
Test voltage	4 kV AC (input against output and power supply) 3 kV AC (output against power supply)
Working voltage (basic isolation)	1000 V AC/DC input against output and power supply with overvoltage category II and pollution degree 2, 330 V AC/DC output against power supply with overvoltage category II and pollution degree 1 according to EN 61010-1 For applications with high working voltages, you should ensure there is sufficient spacing or isolation from neighboring devices and protection against electrical shocks.
Protection against electrical shock	Safe isolation according to EN 61140 by reinforced insulation in accordance with EN 61010-1. Working voltages with overvoltage category II and pollution degree 2: 600 V AC/DC for input against output and power supply with overvoltage category II and pollution degree 2: 300 V AC/DC for output against power supply. For applications with high working voltages, you should ensure there is sufficient spacing or isolation from neighboring devices and protection against electrical shocks.

Standards and approvals

Surge withstand	5 kV 1.2/50 µs according to IEC 255-4
EMC ¹⁾	EMC directive 89/336/EEC, EN 61326, NAMUR recommendation NE 21

Other data

Interface (only user-definable models)	Optical, interface adapter on RS 232 interface (PC) is included in the ZU 0254 communications kit
Ambient temperature	Operation: –10 ... +60 °C Transport and storage: –30 ... +80 °C
Enclosure	Modular case A7, width 22.5 mm, screw terminals See dimension drawings for further measurements
Protection class	Case IP 40, terminals IP 20
Mounting	With snap-on mounting for 35 mm top hat rail according to EN 50022-35, width 22.5 mm, See dimension drawings for conductor cross section
Weight	Approx. 300 g

1) Slight deviations are possible while there is interference from RF radiation

Schematic diagram

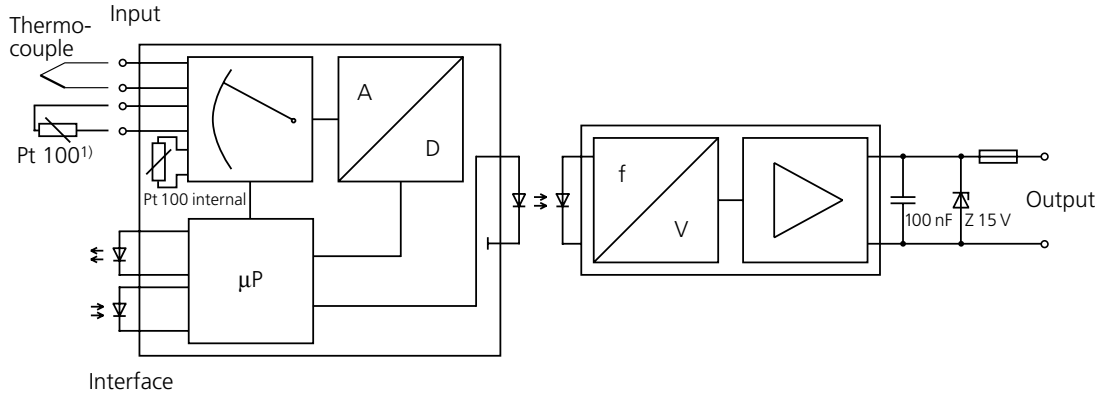

1) For temperature measurement of external reference junctions

Application examples

With external reference junction

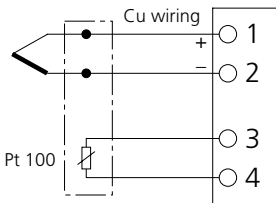

Summing connection with external reference junction

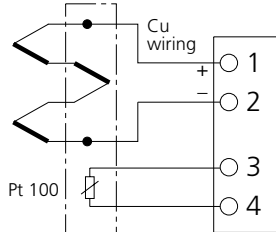

Differential connection

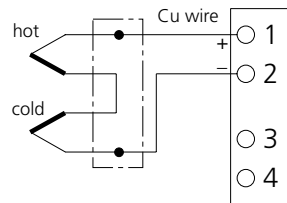

Internal/external reference junction selectable

Pt 100 external

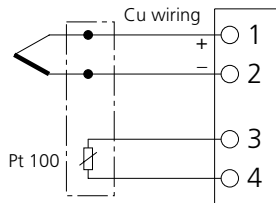

Pt 100 internal

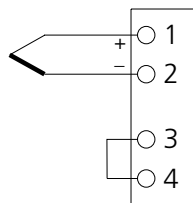

Dimension drawings and terminal assignments

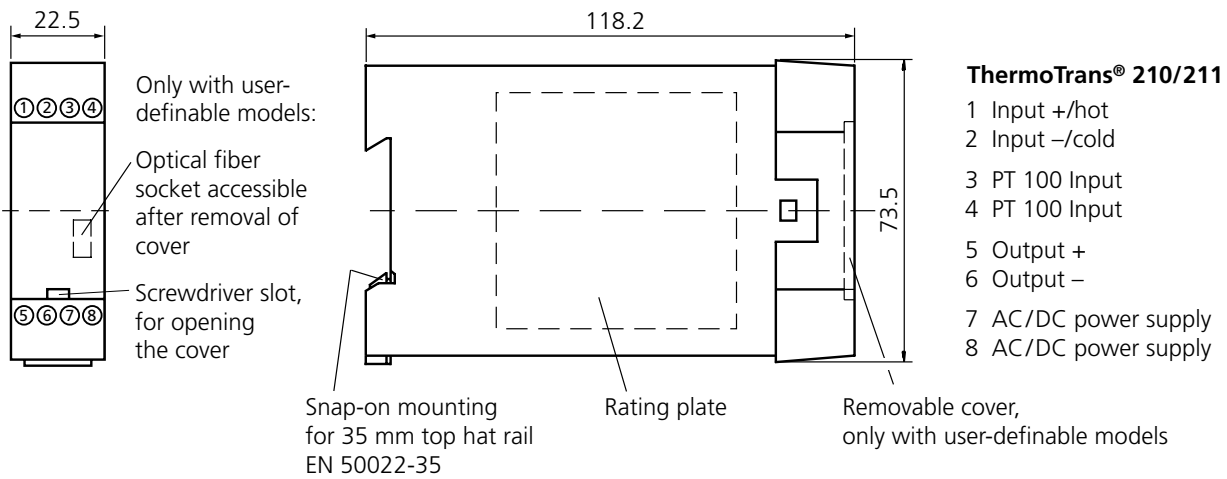

All dimensions in mm.

Captive M3x8 clamp screws, box terminals with self-releasing wire protection, max. conductor cross section

- 1 x 4 mm² solid
- 1 x 2.5 mm² stranded wire with ferrule
- 2 x 1.5 mm² stranded wire with ferrule

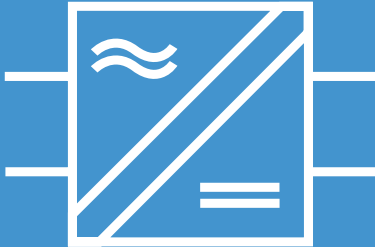

IsoTrans® 600

For isolation and conversion of sinusoidal alternating currents and voltages into standard signals.

The task

For monitoring mains supplies, control of electric motors etc., alternating currents up to 10 A and voltages up to 800 V are converted into 0(4) ... 20 mA or 0 ... 10 V standard signals.

The problem

is the provision of several AC/DC transducers for different measurement ranges. Furthermore the maintenance staff and the system need to be protected against high potentials.

The solution

is a switchable loop-powered IsoTrans® 600 AC/DC transducer.

The calibrated range selection for all regular alternating voltages and the 22.5 mm modular case allow universal use.

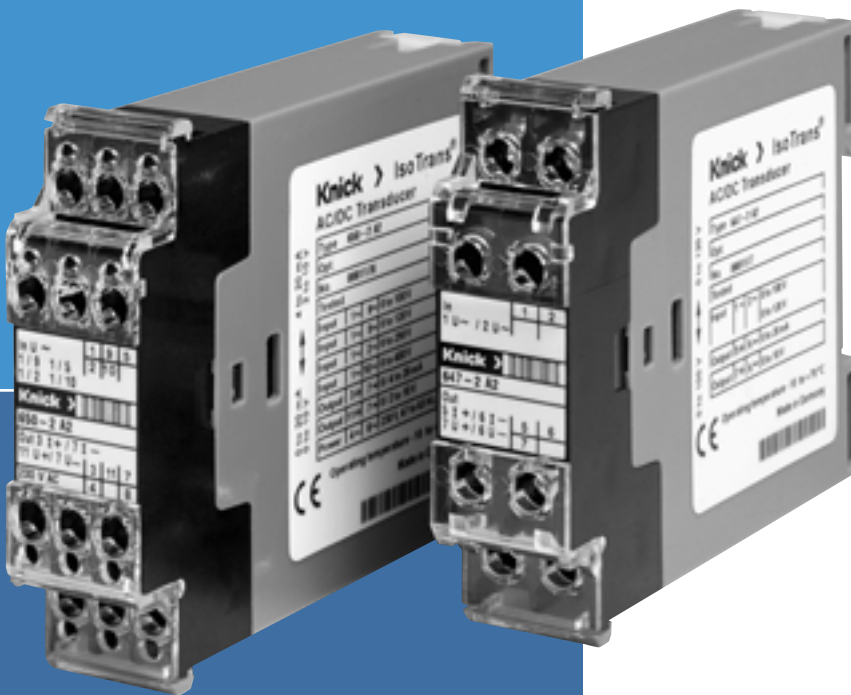

Warranty
5 years!

Defects occurring within 5 years from delivery are remedied free of charge at our plant (carriage and insurance paid by sender).

The advantages

The accuracy class is 0.5 – no need to recalibrate the switchable measuring ranges. IsoTrans® 600 provides safe isolation in accordance with EN 61010-1 up to 600 V. This allows use in 3-phase systems. Further measures for ensuring safe isolation are not necessary.

Except for output 4 ... 20 mA, IsoTrans® 600 is supplied with power directly from the measuring signal. There are no costs for a power supply and wiring.

Optimized switching technology makes the power consumption and the resulting self-heating very low. This protects against unnecessary temperature-related component aging and thus increases the reliability.



The technology

For conversion, the average input values are calibrated to form r. m. s values.

Short rise times, very low residual ripple and excellent overload behavior guarantee maximum transmission quality.

0 ... 1 A
0 ... 5 A
0 ... 400 V
0 ... 250 V
0 ... 120 V
0 ... 100 V
Terminal
selectable

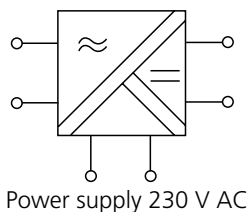

0 ... 20 mA
4 ... 20 mA
0 ... 10 V
Switch/
terminal
selectable

The facts

- **Calibrated measuring range switchover**
simple stockkeeping due to universal application possibilities, no need for complicated recalibration
- **Models with 0 ... 20 mA and 0 ... 10 V output, loop-powered**
little wiring work and no line influences
- **Safe isolation in accordance with EN 61140**
protection of the maintenance staff and the subsequent devices against non-permitted high voltages
- **Modular case 22.5 mm**
low space requirement due to compact design
- **High long-term stability and accuracy**
reliable operation without recalibration
- **Very low power consumption**
allows a minimum rating of the upstream current and voltage transformer
- **Very low self-heating**
no temperature-related component aging, high MTBF
- **Maximum reliability**
no repair and failure costs
- **High reliability**
- **5-year warranty**

Product line

Devices

IsoTrans® 600 with current input

	Input	Output	Order No.
IsoTrans® 611-1	0 ... 1 A	0 ... 20 mA	611-1 A2
IsoTrans® 621-1 (with power supply)	0 ... 1 A	4 ... 20 mA	621-1 A2
IsoTrans® 631-1	0 ... 1 A	0 ... 10 V	631-1 A2
IsoTrans® 615-1	0 ... 5 A	0 ... 20 mA	615-1 A2
IsoTrans® 625-1 (with power supply)	0 ... 5 A	4 ... 20 mA	625-1 A2
IsoTrans® 635-1	0 ... 5 A	0 ... 10 V	635-1 A2

IsoTrans® 600 with voltage input

IsoTrans® 647-2	0 ... 100/120 V switchable	0 ... 20 mA/0 ... 10 V terminal-selectable	647-2 A2
IsoTrans® 648-2	0 ... 250/400 V switchable	0 ... 20 mA/0 ... 10 V terminal-selectable	648-2 A2
IsoTrans® 650-2 (with power supply)	0 ... 100/120/250/400 V, terminal-selectable	0 ... 20 mA/4 ... 20 mA/0 ... 10 V, switchable/terminal-selectable	650-2 A2

Power supply

621-1, 625-1, 650-2: 230 V AC. Others: none, supply from input signal

Options

IsoTrans® 635-1 and IsoTrans® 650-2 for input frequency 16 2/3 Hz (635-1: response time 1 s, load ≥ 7.5 kOhms) 469

Selection aid

		Output		
		0 ... 20 mA	4 ... 20 mA	0 ... 10 V
Input	0 ... 1 A AC	611-1 A2	621-1 A2*)	631-1 A2
	0 ... 5 A AC	615-1 A2	625-1 A2*)	635-1 A2
	0 ... 100 V AC	647-2 A2 650-2 A2*)	650-2 A2*)	647-2 A2 650-2 A2*)
	0 ... 120 V AC	647-2 A2 650-2 A2*)	650-2 A2*)	647-2 A2 650-2 A2*)
	0 ... 250 V AC	648-2 A2 650-2 A2*)	650-2 A2*)	648-2 A2 650-2 A2*)
	0 ... 400 V AC	648-2 A2 650-2 A2*)	650-2 A2*)	648-2 A2 650-2 A2*)

*) with power supply

Specifications

Input data	IsoTrans® 600 with current input			IsoTrans® 600 with voltage input		
	6x1	6x5	647	648	650	
Input ¹⁾	0 ... 1 A 48 ... 63 Hz	0 ... 5 A 48 ... 63 Hz	0 ... 100/120 V switchable Measurement from 10 % full scale 48 ... 63 Hz	0 ... 250/400 V switchable Measurement from 10 % full scale 48 ... 63 Hz	0 ... 100/120/ 250/400 V terminal- selectable 48 ... 63 Hz	
Overload	Continual: 2times I_{nom} 1 s: 50times I_{nom}			Continual: 1.5times V_{nom} 1 s: 4times V_{nom}		
Input power with nominal current	Approx. 1 VA			Max. 0.4 VA		
Output data	IsoTrans® 600 with current input			IsoTrans® 600 with voltage input		
	61x	62x	63x	647	648	650
Output	0 ... 20 mA	4 ... 20 mA	0 ... 10 V	0 ... 20 mA/ 0 ... 10 V terminal- selectable		0(4) ... 20 mA/ 0(2) ... 10 V switchable/ terminal- selectable
Load	≤ 750 Ohms		≤ 2 kOhms	With output current: ≤ 600 Ohms With output current: ≥ 1 kOhm		
Response time (T_{90}) Load 0 Ohm Load 750 Ohms	Approx. 0.1 s Approx. 0.2 s		< 0.2 s	Approx. 0.25 s		
Response	Class 0.5 (EN 60688)					
Power supply	230 V AC – 15 % + 10 %, 47 ... 63 Hz, approx. 1 VA (IsoTrans® 650 approx. 1.5 VA)					
Power supply (only Models with 4 ... 20 mA output)						

1) Other input values up to 10 A or 800 V in the frequency range 16 ... 63 Hz are available on request

Specifications, continued

Isolation

Galvanic isolation	With power supply: 3-port isolation between input, output and power supply Loop-powered: Isolation between input and output
Test voltage	With current input: 6 kV AC for models with power supply: 6 kV AC (input against output/ power supply) 4 kV AC (output against power supply) With voltage input: 4 kV AC
Protection against electrical shock	Safe isolation according to EN 61140 by reinforced insulation in accordance with EN 61010-1. Working voltages with overvoltage category II and pollution degree 2: up to 400 V AC/DC between output and power supply. up to 600 V AC/DC between input and output and, where necessary, power supply (current isolator up to category III, degree 2). For applications with high working voltages, you should ensure there is sufficient spacing or isolation from neighboring devices and protection against electrical shocks.

Standards and approvals

Surge withstand	5 kV 1.2/50 μ s according to IEC 255-4
EMC	EMC directive 89/336/EEC, EN 61326

Other data

Ambient temperature	Operation: -10 ... +70 °C Transport and storage: -30 ... +80 °C
Enclosure	Modular case A7, width 22.5 mm, screw terminals See dimension drawings for further measurements
Protection class	Case IP 40, terminals IP 20
Mounting	With snap-on mounting for 35 mm top hat rail according to EN 50022 or M4 screw mounting, See dimension drawings for conductor cross section
Weight	6xx-1: approx. 350 g 6xx-2: approx. 250 g

Schematic diagram

AC/DC transducers with current input

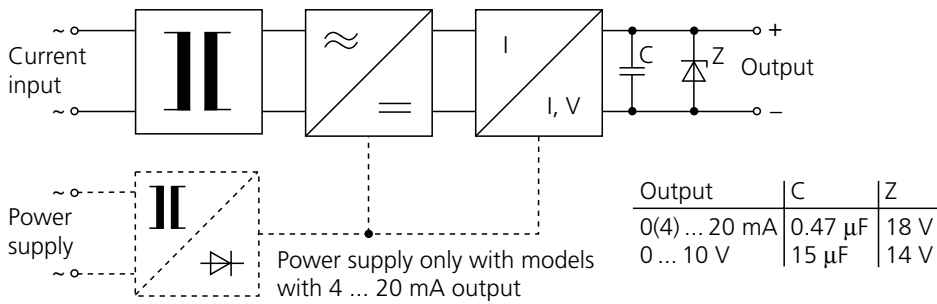

AC/DC transducers with voltage input

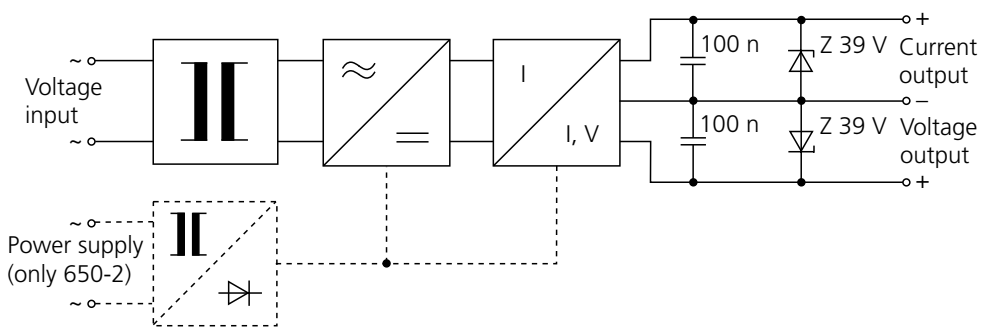

Dimension drawings and terminal assignments

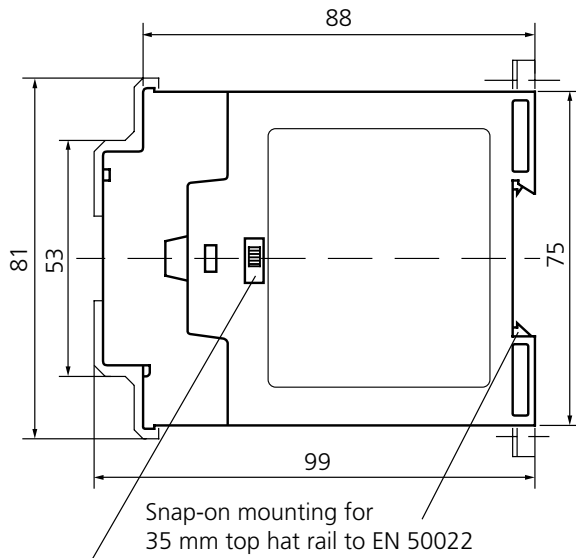

Range switch, do not use during operation!

M2.5x8 connecting screws with self-releasing clamping pieces, max. conductor cross section 2 x 2.5 mm² solid or 2 x 1.5 mm² stranded wire with ferrule

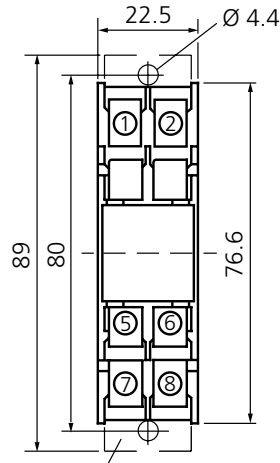

Screw mounting with extending lugs

AC/DC transducers with current input 6**-1

- 1 Input ~
 - 2 Input ~
 - 5 Output +
 - 6 Output -
 - 7 Power supply ~
 - 8 Power supply ~
- (only for models 621 and 625, otherwise not connected)

AC/DC transducers with voltage input 647-2 and 648-2

- 1 Input ~
- 2 Input ~
- 5 Output + 20 mA
- 6 Output -
- 7 Output + 10 V

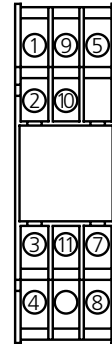

All dimensions in mm.

AC/DC transducer with voltage input 650-2

- 1 Input 0
- 9 Input 100 V ~
- 5 Input 120 V ~
- 2 Input 250 V ~
- 10 Input 400 V ~
- 7 Output -
- 11 Output + 20 mA
- 3 Output + 10 V
- 4 Power supply ~
- 8 Power supply ~

IsoAmp® 7000/8000

**Universal models
up to $I_1 = 3000\text{ V}$ and
 $I_1 = 5\text{ A}$**

The IsoAmp® 7000/8000 DC isolation amplifiers work bipolar as active amplifiers with transformer isolation between the input and sequential circuit. A special winding technique in conjunction with continuous Kapton insulation allows high isolation voltages.

At the same time the switching technology and device construction ensure excellent transmission values that are reflected, among other things, in the zero stability, linearity, long-term stability and frequency response.

Extensive optional equipment allows special applications for input voltages of 200 V to 3000 V or input current of 50 mA to 5 A to be implemented.

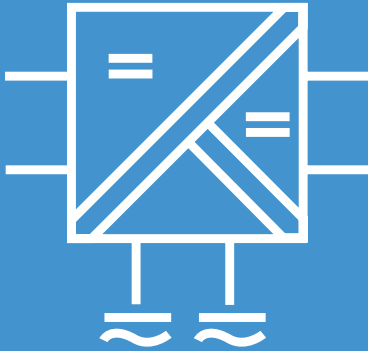

Warranty
5 years!

Defects occurring within 5 years from delivery are remedied free of charge at our plant (carriage and insurance paid by sender).

Product line

Devices	Order no.
Free wiring, with current output	7001 A1
Free wiring, with voltage output	8001 A1
Power supply	
230 V AC	
24 V, $\pm 15\%$, 48 ... 62 Hz, approx. 2 VA	06
110 V, $\pm 15\%$, 48 ... 62 Hz, approx. 2 VA	63
11.5 ... 15.5 V DC or 20.5 ... 27.5 V DC, switchable, approx. 1.5 W	74
60 V DC, $\pm 15\%$, approx. 1.5 W	213
110 V DC, $\pm 15\%$, approx. 1.5 W	243
Options	
Gain adjustment to customer requirements in the range $V_1 > 200 \text{ V} \leq 800 \text{ V}$ or $I_1 > 50 \text{ mA} \leq 5 \text{ A}$ ¹⁾	155
Gain adjustment to customer requirements in the range $V_1 > 800 \text{ V} \leq 1000 \text{ V}$ ¹⁾	156
Gain adjustment to customer requirements in the range $V_1 > 1000 \text{ V} \leq 3000 \text{ V}$ ¹⁾	414
Zero offset to customer requirements ¹⁾	50
Unipolar input, output 4 ... 20 mA, live zero, additional error $\pm 10 \mu\text{A}$ at output	55
Output 20 mA, 20 V, unipolar	59
8000 A1: Output voltage unipolar $\leq 20 \text{ V}$	189
7000 A1: Rectifier in signal path	152
Test voltage 7 kV AC input against output/power supply	179
Silicone emission free	253
Increased shock, vibration and moisture resistance	255

1) Please indicate required setting when ordering

Specifications

Input data

	7001	8001
Input (optional fixed setting upon customer request ¹⁾)	V: ±200 V to ±3000 V I: ±50 mA to ±5 A	V: ±200 V to ±3000 V I: ±50 mA to ±5 A
Input resistance	Dependent on measuring range	
Overload	Input: < 250 V > 250 V ≤ 150 mA > 150 mA Overload: 300 V 20 % fs 300 mA 100 % fs	

Output data

	7001	8001
Output impressed	±20 mA, 10 V	±10 V, 20 mA
Residual ripple	≤30 mV _{pp}	

Transmission behavior

Gain error	Dependent on measuring range (from 0.2 % of measured value)	
Cut-off frequency	10 kHz -3 dB, V _O ≤ 3 V _{pp} 2 kHz -3 dB, V _O ≤ 10 V _{pp} (other values available upon request)	
Temperature coefficient	≤5 nA/K, ≤10 μV/K ±0.0025 %/K of measured value (reference temperature 23 °C)	

Power supply

Power supply ²⁾	230 V -15 % +10 %, 48 ... 62 Hz, approx. 3 VA
----------------------------	---

Isolation

Galvanic isolation	3-port isolation between input, output and power supply		
Test voltage	Input/output/power supply:	5 kV AC	
	Opt. 213 and 243: Output/power supply:	1.5 kV AC	
	Opt. 74: Output/power supply:	750 V AC	
	Opt. 179: Output/power supply:	7 kV AC	
Working voltage (basic isolation)	Permitted working voltage/overvoltage category/pollution degree according to EN 61010-1		
	Version	Input against output and power supply	Power supply against output
	All versions	1500 V- /III/degree 1	1500 V- /III/degree 1
	Except for opt. 74, 213, 243	1400 V- /III/degree 2 630 V~/III/degree 3	1300 V- /III/degree 2 630 V~/III/degree 3
	Option 74	1500 V- /III/degree 1 1400 V- /III/degree 2 630 V~/III/degree 3	150 V~/I /degree 2 63 V~/II/degree 3
	Options 213 or 243	1500 V- /III/degree 1 1400 V- /III/degree 2 630 V~/III/degree 3	200 V~/II/degree 2 150 V~/III/degree 2 63 V~/III/degree 3

For applications with high working voltages, you should ensure there is sufficient spacing or isolation from neighboring devices and protection against electrical shocks.

1) Please indicate required setting when ordering

2) See power supply product line for other values

Specifications, continued

Standards and approvals

EMC	EMC directive 89/336/EEC
-----	--------------------------

Other data

Ambient temperature	-10 ... +70 °C
Enclosure	See dimension drawings for further measurements, screw clamps
Protection class	Case IP 40, terminals IP 20
Mounting	With snap-on mounting for 35 mm standard rail according to EN 46277 or screw mounting max. M5, see dimension drawing for conductor cross section
Weight	Approx. 400 g

Wiring examples

Voltage input:
Range settings with series resistor for any input voltages

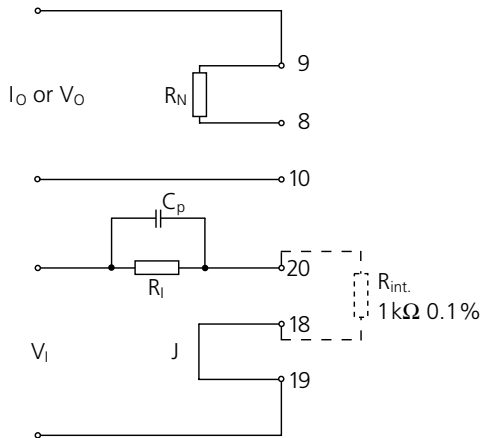

Model 7001:	$R_N = 5 \Omega$
Model 7001, Opt. 55:	$R_N = 6.25 \Omega$
Model 8001:	$R_N = 207 \Omega$

$$R_I = \frac{V_I}{0.1 \text{ mA}} - 1 \text{ k}\Omega$$

Input current: 0.1 mA

$$C_P = \frac{47 \text{ nF} \cdot 1 \text{ k}\Omega}{R_I}$$

Input resistance: $R_I + 1 \text{ k}\Omega$
See Specifications for cut-off frequency

V_I in mV

Current input:
Range setting with shunt resistor R_S (voltage drop at R_S : 100 mV)

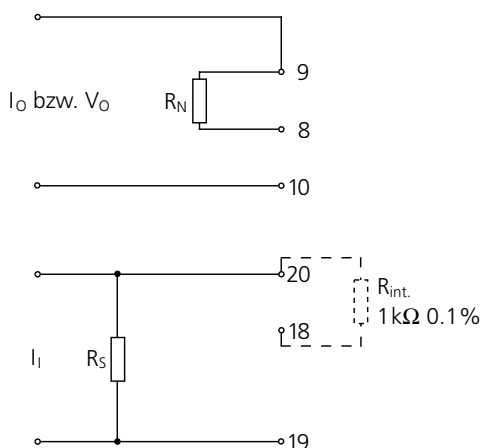

Model 7001:	$R_N = 5 \Omega$
Model 7001, Opt. 55:	$R_N = 6.25 \Omega$
Model 8001:	$R_N = 207 \Omega$

$$R_S = \frac{100 \text{ mV}}{I_I}$$

I_I in mA
Voltage drop at R_S : 100 mV
See Specifications for cut-off frequency

Dimension drawings and terminal assignments

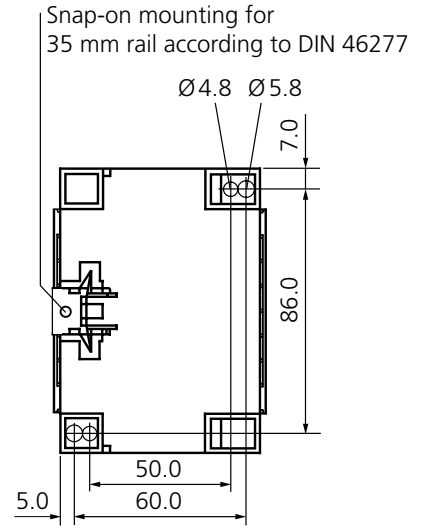
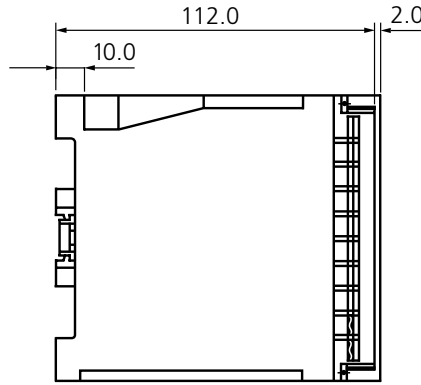
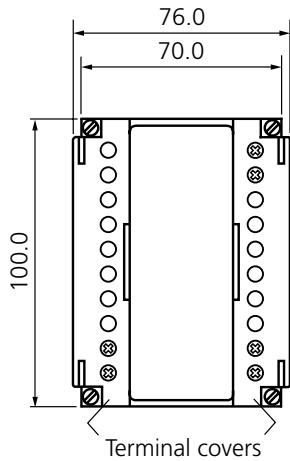

All dimensions in mm.

View without terminal covers

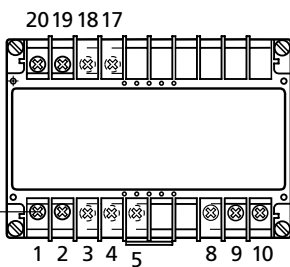

Flat-type terminals with self-releasing clamping pieces to DIN 46206 and DIN 57609/VDE 0609, conductor cross section up to 2 x 2.5 mm², min. 1 or 2 x 0.2 mm²

Terminal assignments

- 1 Power supply -
 - 2 Power supply +
 - 3 Jumper 11.5 ... 15.5 V
 - 4
 - 4 Jumper 20.5 ... 27.5 V
 - 5
- } Opt. 74
- 9 Output ±
 - 10 Output 0
 - 17 Input ± (V_I > 200 V)
 - 19 Input ± (V_I ≤ 200 V)
 - 20 Input 0

Models 7001/8001 without Opt. 155/156/414

- 8 Negative-feedback resistor R_N
- 9 resistor R_N
- 17 n. c.
- 18 Jumper for 1 kΩ R_{int}.
- 19



Modular Cases

Hazardous area



IsoTrans® 36/37

**For hazardous area/
safe area isolation of
0 ... 20 mA standard
signals without power
supply**

The task

Hazardous area normally means systems in constant operation that require highly reliable components. The measuring signals need to be transmitted to the control system outside the hazardous area very accurately to control the processes optimally.

The problems

Complex systems with power supplies are used for reliable hazardous/safe area isolation combined with electrical isolation for preventing measuring errors.

The solution

Knick loop-powered isolators for 0(4) ... 20 mA signal transmission. They are available as isolators with intrinsically safe input or output. Due to their patented design (German patent 3526997), they are considered to be the most reliable solution for isolating standard signals without external power supply.



Warranty
5 years!

Defects occurring within 5 years from delivery are remedied free of charge at our plant (carriage and insurance paid by sender).

The advantages

The IsoTrans® 36 and 37 isolators are not only suitable as highly reliable isolators for normal applications, they also meet the most extreme requirements that can be set for signal isolation. There is no need to wire a power supply.

The technology

The pioneering TransShield® technology allows specifications that previously could not be implemented:

- Extremely high reliability
- Safe isolation, transient protection
- 10 kV test voltage (optional)
- High electromagnetic compatibility
- Extremely low residual ripple and common-mode interference

- Excellent pulse formation
- High transmission accuracy
- SMART transmission
- Hazardous / safe-area isolation

In addition to the analog signals, they also transmit data protocols for SMART transmitters (HART®). They allow bidirectional communication from every point of the cabling.

Special type available! Measure voltage without a power supply

Measuring voltages in the range from 250 to 1200 V DC can be converted into current signals up to 5 mA using a special loop-powered version of the isolator. This allows, for example, the contact wire voltage to be checked easily. Please contact us if you need detailed information on this special model.

The facts

- **Galvanic isolation between input and output signal**
protection against measuring errors caused by grounding problems and parasitic interference voltage
- **No power supply required**
cost saving due to lower wiring requirement, no mains influences
- **Very low residual ripple**
no interference of the connected measuring or control system
- **Explosion protection according to ATEX**
- **High transmission accuracy**
excellent pulse formation, exact transmission of measured values
- **Very low common-mode interference**
avoiding incorrect measurements or failure due to interference signals
- **Maximum reliability**
no repair and failure costs
- **10 kV test voltage (optional)**
- **Safe isolation in accordance with EN 61140**
protection of the maintenance staff and the subsequent devices against non-permitted high voltages
- **SMART transmission**
bidirectional point-to-point transmission of digital data according to HART® specification
- **5-year warranty**

HART® is a registered trademark of the HART Communication Foundation

Product line

Devices

		Order no.
IsoTrans® 36	Input intrinsically safe	36 A7
IsoTrans® 37	Output intrinsically safe	37 A7
IsoTrans® 36 A9 special type	Passive voltage measurement, details on request	36 A9-xxx

Power supply

None, supply from input signal

Option

Increased test voltage 10 kV AC	471
---------------------------------	-----

Specifications

Input data

	36 A7	37 A7
Input ¹⁾	0 ... 20 mA, intrinsically safe	0 ... 20 mA
Operating current	≤ 20 µA	
Overload	50 mA	
Voltage drop	Approx. 4.5 V at 20 mA ²⁾	Approx. 4 V at 20 mA

Output data

	36 A7	37 A7
Output	0 ... 20 mA, max. 10 V (corresponds to 500 Ohm load)	0 ... 20 mA, max. 20 V, intrinsically safe (corresponds to 1000 Ohm load)
Load error	< 0.15 % meas. val. per 100 Ohm load	
Offset	< 20 µA	
Residual ripple V_{rms}	< 10 mV at 20 mA and 500 Ohm load	

Transmission behavior

Transmission error	0.2 % meas. val.
Rise or fall time	≤ 400 µs at 500 Ohm load (10 ... 90 %, jump from 0 ... 20 mA or 20 ... 0 mA)
HART attenuation	< 10 dB

1) Linear transmission: Model 36 up to 50 mA, Model 37 up to 22 mA

2) Approx. 8.5 V at 50 mA

Specifications, continued

Isolation

Test voltage	4.4 kV AC 10 kV AC with option 471
Working voltages (basic isolation)	3600 VAC/DC, 2500 V AC ³⁾ at overvoltage category II and pollution degree 2 according to EN 61010-1 For applications with high working voltages, you should ensure there is sufficient spacing or isolation from neighboring devices and protection against electrical shocks. Permissible working voltages for other overvoltage categories and pollution degrees on request. When used in hazardous areas, the max. working voltage is 250 V.
Protection against dangerous currents	Safe isolation according to EN 61140 by reinforced insulation in accordance with EN 61010-1. Working voltages with overvoltage category II and pollution degree 2: 600 V AC/DC For applications with high working voltages, you should ensure there is sufficient spacing or isolation from neighboring devices and protection against electrical shocks. When used in hazardous areas, the max. working voltage is 250 V.

Standards and approvals

	36 A7	37 A7
Explosion protection	II (1) G [EEx ia] IIC, input intrinsically safe PTB 02 ATEX 2134 For further details see certificates of conformity page 134	II (2) G [EEx ib] IIC, output intrinsically safe PTB 02 ATEX 2063
EMC ⁴⁾	EMC directive 89/536/EEC NAMUR NE 21, EN 61326	

Other data

Ambient temperature	Operation: -10 ... +50 °C Transport and storage: -30 ... +80 °C
Enclosure	Modular case, width 22.5 mm, screw terminals, see dimension drawings for further measurements
Protection class	Case IP 20, terminals IP 20
Mounting	With snap-on mounting for 35 mm top hat rail according to EN 50022, See dimension drawings for conductor cross section
Weight	Approx. 120 g

³⁾ For circuits according to table 6 from EN 61010-1 (transient overvoltage 2600 V)

⁴⁾ In the range from 1 mA ... 20 mA

Schematic diagrams

IsoTrans® 36 A7

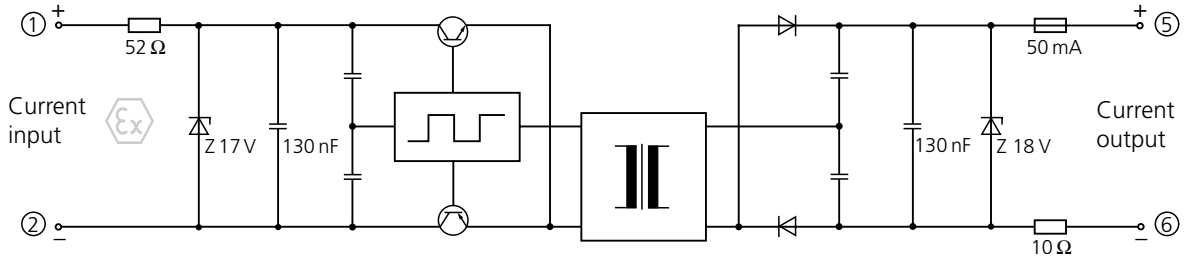

IsoTrans® 37 A7

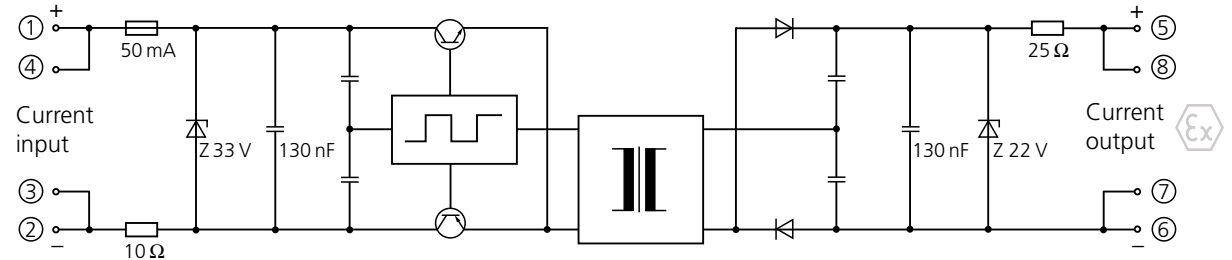

Application examples IsoTrans® 36 A7

Without HART communication

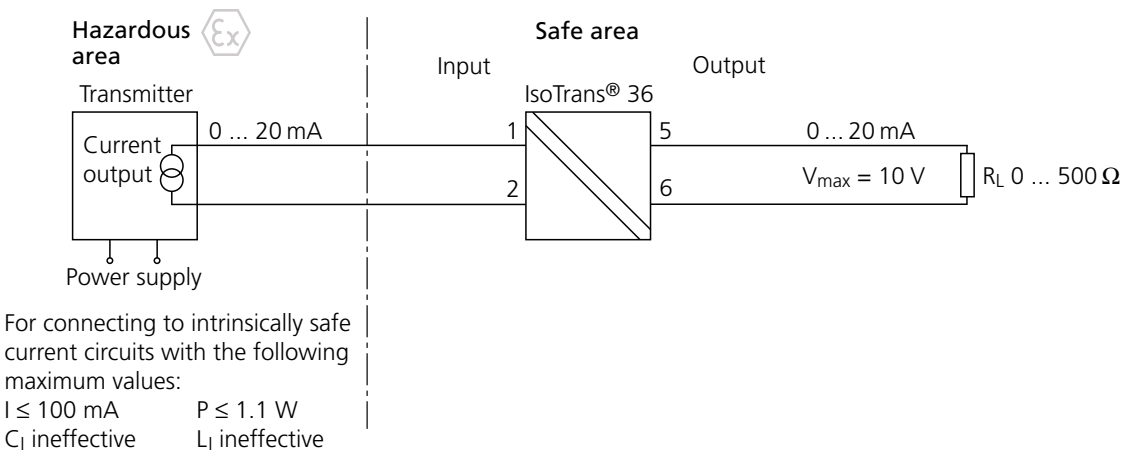

Application examples for IsoTrans® 36 A7, continued

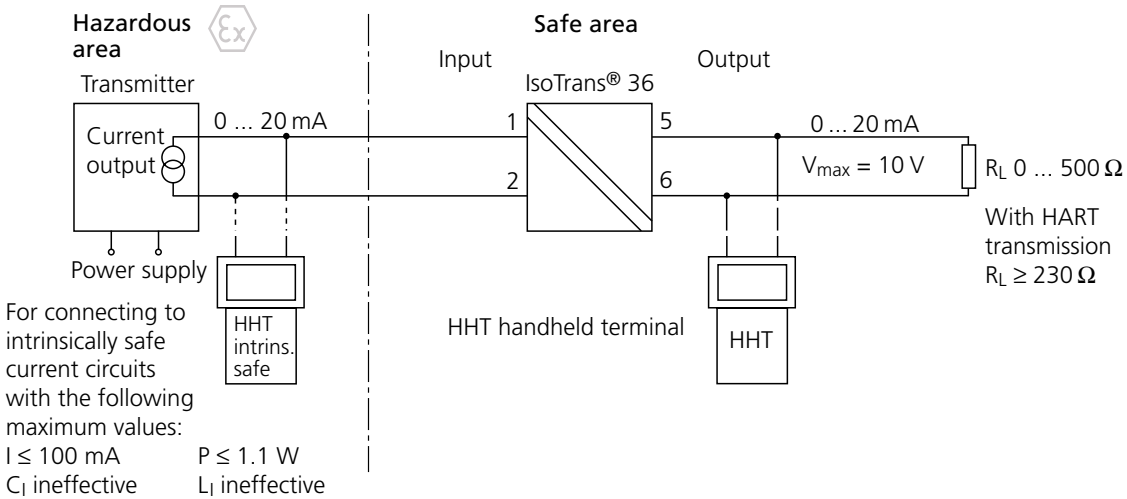
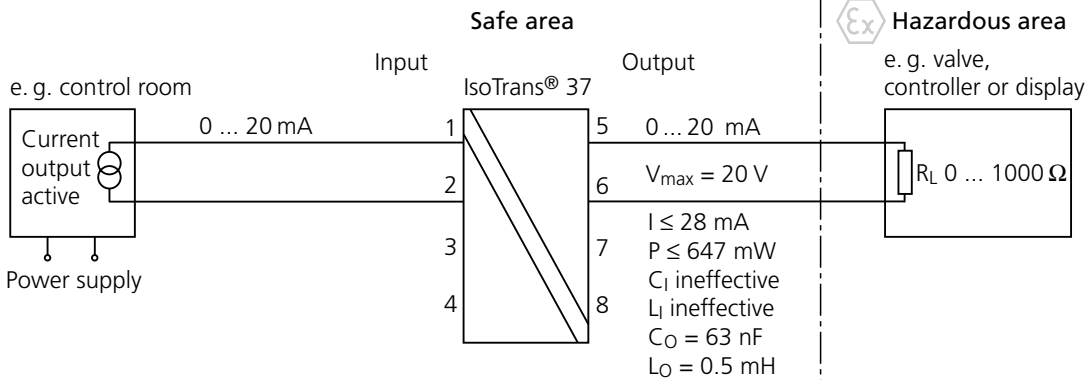
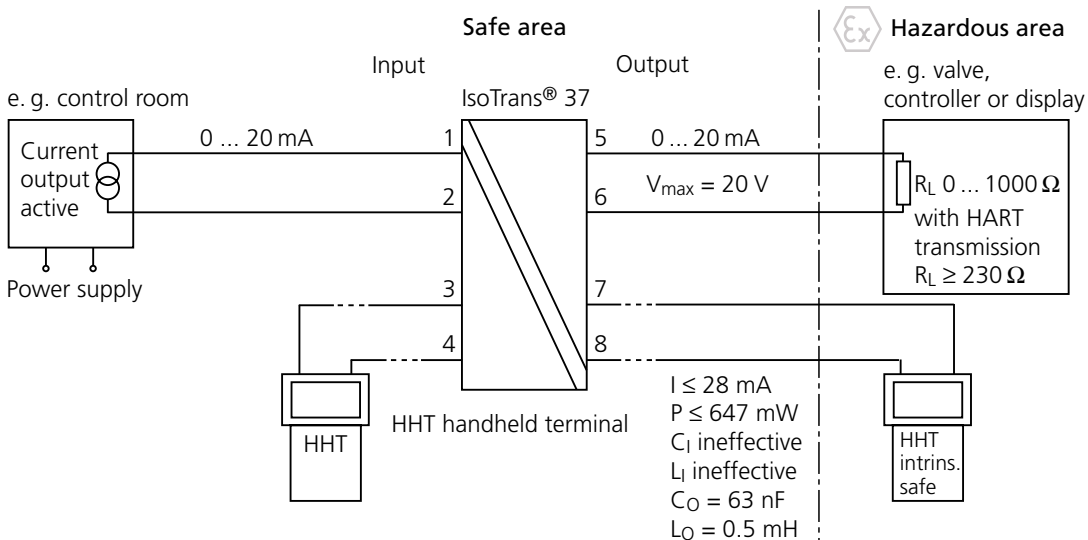
With HART communication

Application examples IsoTrans® 37 A7
Without HART communication

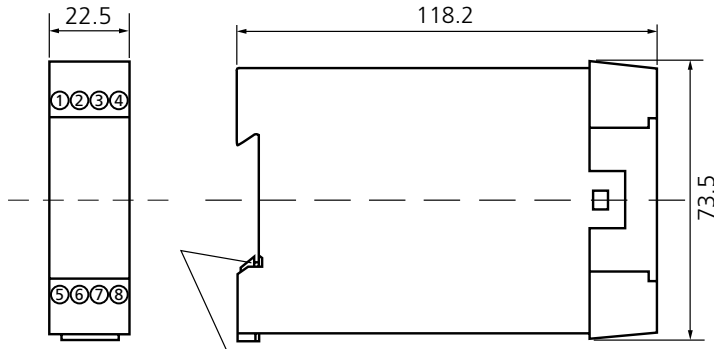
With HART communication

Dimension drawings and terminal assignments



Snap-on mounting for 35 mm top hat rail EN 50022

Installation, commissioning and maintenance may only be carried out by trained personnel.

All dimensions in mm.

IsoTrans® 36 A7		IsoTrans® 37 A7	
1 Input	+	1 Input	+
2 Input	-	2 Input	-
5 Output	+	3 HHT non-intrinsically safe	
6 Output	-	4 HHT non-intrinsically safe	
		5 Output	+
		6 Output	-
		7 HHT intrinsically safe	
		8 HHT intrinsically safe	

HHT = handheld terminal

Captive clamping screws M3 x 8
 Box terminals with self-releasing wire protection
 Max. conductor cross section
 1 x 4 mm² solid
 1 x 2.5 mm² stranded with ferrule
 2 x 1.5 mm² stranded with ferrule

Certificates of Conformity

print preview



Certificates of conformity, continued

Physikalisch-Technische Bundesanstalt **PTB**
 Braunschweig und Berlin
 SCHEDULE TO EC-TYPE-EXAMINATION CERTIFICATE PTB 02 ATEX 2063

(17) **Special conditions for safe use**
 none

(18) **Essential health and safety requirements**
 will be met by the standards quoted

Zertifizierungsbüro Explosionschutz
 By order:
 Dr.-Ing. U. Johannmeyel
 Regierungsdirektor

Braunschweig, September 25, 2002

sheet 3/3

EC-type-examination Certificates without signature and official stamp shall not be valid. The certificate may be discussed only without alteration. Extracts or abridgements are subject to approval by the Physikalisch-Technische Bundesanstalt. In case of dispute, the German text shall prevail.

Physikalisch-Technische Bundesanstalt • Bundesallee 100 • D-38110 Braunschweig

Physikalisch-Technische Bundesanstalt **PTB**
 Braunschweig und Berlin

EC-TYPE-EXAMINATION CERTIFICATE
 (Translation)

(2) Equipment and Protective Systems Intended for Use in Potentially Explosive Atmospheres - Directive 94/9/EC

(3) EC-type-examination Certificate Number:
PTB 02 ATEX 2063

(4) Equipment: Supply and isolating unit, passive, type WG 25 A7 resp. Isolator without auxiliary power, type IsoTrans 37 A7

(5) Manufacturer: Knick Elektronische Messgeräte GmbH & Co.

(6) Address: Beudicker 22, 14163 Berlin, Germany

(7) The equipment and any acceptable variation thereto are specified in the schedule to the certificate and the documents therein referred to.

(8) The Physikalisch-Technische Bundesanstalt, notified body No. 0102 in accordance with Article 3 of the Council Directive 94/9/EC of 23 March 1994, certifies that this equipment has been found to comply with the Essential Health and Safety Requirements relating to the design and construction of equipment and protective systems intended for use in potentially explosive atmospheres, given in Annex II to the Directive.

The examination and test results are recorded in the confidential report PTB Ex 02-21106.

(9) Compliance with the Essential Health and Safety Requirements has been assured by compliance with:

(10) If the sign "T" is placed after the certificate number, it indicates that the equipment is subject to special conditions for safe use specified in the schedule to the certificate.

(11) This EC-type-examination Certificate relates only to the design, examination and tests of the specified equipment in accordance with the Directive 94/9/EC. Further requirements of the Directive apply to the manufacturing process and supply of this equipment. These are not covered by the certificate.

(12) The marking of the equipment shall include the following:

II (2) G (Ex) Ib IIC

Zertifizierungsbüro Explosionschutz
 By order:
 Dr.-Ing. U. Johannmeyel
 Regierungsdirektor

Braunschweig, May 23, 2002

sheet 1/3

EC-type-examination Certificates without signature and official stamp shall not be valid. The certificate may be discussed only without alteration. Extracts or abridgements are subject to approval by the Physikalisch-Technische Bundesanstalt. In case of dispute, the German text shall prevail.

Physikalisch-Technische Bundesanstalt • Bundesallee 100 • D-38110 Braunschweig

Physikalisch-Technische Bundesanstalt **PTB**
 Braunschweig und Berlin

SCHEDULE

(14) **EC-TYPE-EXAMINATION CERTIFICATE PTB 02 ATEX 2063**

(15) **Description of equipment**

The supply and isolating unit, type WG 25 A7 is preferably used as passive supply and isolating unit for 2-wire measuring transducers.

When designed as isolator without auxiliary power, type IsoTrans 37 A7 it is preferably used as isolating transformer for 4 - 20 mA signal circuits.

The unit is installed outside of hazardous areas.

The permissible temperature range is -10 °C up to +50 °C.

Electrical data

WG 25 A7

Output circuit: Operating values:
 U = 30 V, I = 22 mA
 U_L = 253 V

Input/supply measuring circuit: type of protection Intrinsic Safety EEx Ib IIC
 Maximum values:
 U_L = 23.1 V
 I_L = 28 mA
 P_L = 647 mW
 rectangular characteristic
 C: negligibly low
 L: negligibly low

IsoTrans 37 A7

Input circuit: Operating values:
 U = 30 V, I = 22 mA
 U_L = 253 V

Output circuit: type of protection Intrinsic Safety EEx Ib IIC
 Maximum values:
 U_L = 23.1 V
 I_L = 28 mA
 P_L = 647 mW
 rectangular characteristic
 C: negligibly low
 L: negligibly low

sheet 2/3

EC-type-examination Certificates without signature and official stamp shall not be valid. The certificate may be discussed only without alteration. Extracts or abridgements are subject to approval by the Physikalisch-Technische Bundesanstalt. In case of dispute, the German text shall prevail.

Physikalisch-Technische Bundesanstalt • Bundesallee 100 • D-38110 Braunschweig

Physikalisch-Technische Bundesanstalt **PTB**
 Braunschweig und Berlin

SCHEDULE TO EC-TYPE-EXAMINATION CERTIFICATE PTB 02 ATEX 2063

WG 25 A7 and IsoTrans 37 A7

The assignment of explosion group and external capacitances and inductances is shown in the following table:

EEx Ib	IC	IC	IB	IB
C _e	140 nF	90 nF	940 nF	490 nF
L _e	0.1 mH	0.8 mH	0.1 mH	10 mH

The output circuit is safely electrically isolated from the input circuit/supply measuring circuit up to a peak value of the nominal voltage of 375 V.

(16) **Test report** PTB Ex 02-21106

(17) **Special conditions for safe use**
 none

(18) **Essential health and safety requirements**
 will be met by the standards quoted

Zertifizierungsbüro Explosionschutz
 By order:
 Dr.-Ing. U. Johannmeyel
 Regierungsdirektor

Braunschweig, May 23, 2002

sheet 3/3

EC-type-examination Certificates without signature and official stamp shall not be valid. The certificate may be discussed only without alteration. Extracts or abridgements are subject to approval by the Physikalisch-Technische Bundesanstalt. In case of dispute, the German text shall prevail.

Physikalisch-Technische Bundesanstalt • Bundesallee 100 • D-38110 Braunschweig

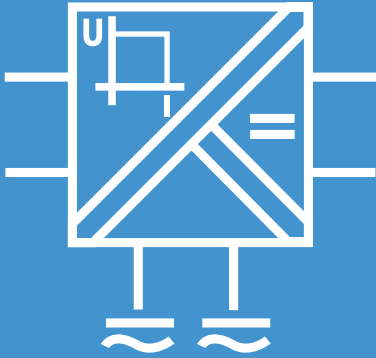

WG 20

For supply of intrinsically safe 2-wire transmitters

The WG 20 power supply/isolator is used to supply intrinsically safe 2-wire transmitters. It supplies the transmitter with power and transmits the measuring signal to the output with high accuracy.

The WG 20 provides safe isolation and high insulation from the input to the output and to the power supply.

An additional measuring current input allows use as a highly accurate standard signal isolator in hazardous areas.

High supply voltage, good hazardous area specifications and the simple LiveZero (4...20 mA)/DeadZero (0...20 mA) switching allow universal applications.

The WG 20 achieves an extraordinarily high transmission accuracy for hazardous-area applications.

The control range of the measuring circuit extends to the negative values and thus allows strictly linear transmission also in the zero range.

The encapsulation technique allows maximum operating safety, long-time stability and disruptive strength even under extreme conditions.

The facts

- Universal use for 2-wire transmitters or as standard signal isolators**
 low stockkeeping costs with many application possibilities
- Safe isolation in accordance with EN 61140**
 protection of the maintenance staff and the subsequent devices against non-permitted high voltages
- 3-port isolation**
 protection against incorrect measurements or damage to the measuring system due to parasitic voltages
- High transmission accuracy**
 exact transmission of measured values
- Explosion protection according to ATEX**
 trouble-free use in hazardous areas
- Output 0 ... 20 mA or 4 ... 20 mA switchable**
 universal adaptation to the following devices
- Measuring circuit with linear zero crossing**
 no transmission loss in the zero range
- Modular case 22.5 mm**
 straightforward installation due to compact design
- 5-year warranty**

Warranty
5 years!

Defects occurring within 5 years from delivery are remedied free of charge at our plant (carriage and insurance paid by sender).

Product line

Devices

WG 20

Order no.

WG 20 A2

Power supply

24 V AC/DC

Specifications

Operation as a repeater power supply

Input (current loop)	4 ... 20 mA, intrinsically safe
Output	4 ... 20 mA/0 ... 20 mA selectable ¹⁾
Current loop	Intrinsically safe supply voltage 20 V, constant for 0 ... 22 mA, floating, resistant to continuous short-circuit, current limited to 30 mA; residual ripple ≤ 10 mV _{pp}

Operation as isolation amplifier

Input ²⁾	0 ... 20 mA, intrinsically safe	4 ... 20 mA, intrinsically safe
Output	0 ... 20 mA	4 ... 20 mA/0 ... 20 mA selectable ¹⁾
Overload capacity (at input)	≤ 300 mA, limitation with diode ≤ 1 V, 13 Ohms	
Input voltage drop	≤ 300 mV	

Output data

Load	≤ 12 V
Offset	< 10 μ A
Residual ripple at output	≤ 10 mV _{pp}

Transmission behavior

Transmission error (at output)	0.1 % meas. val.
Cut-off frequency	1 kHz -3 dB
Temperature coefficient (at output)	≤ 1 μ A/K (reference temperature 23 °C)

 1) Additional error at output 10 μ A

2) Transmission of negative measuring signals up to approx. 3 % full scale

Specifications, continued

Power supply

Power supply	24 V AC/DC AC –15 % +10 %, 48 ... 62 Hz, approx. 3.3 VA DC –15 % +20 %, approx. 2.2 W
--------------	---

Isolation

Galvanic isolation	3-port isolation between input, output and power supply
Test voltage	4 kV AC (current loop, input/output/power supply)
Working voltages (basic isolation)	1000 V AC/DC current loop, input against output and power supply 800 V AC/DC output against power supply with overvoltage category II and pollution degree 2, according to EN 61010-1 For applications with high working voltages, you should ensure there is sufficient spacing or isolation from neighboring devices and protection against electrical shocks. When used in hazardous areas, the max. working voltage is 250 V.
Protection against electrical shock	Safe isolation according to EN 61140 by reinforced insulation in accordance with EN 61010-1. Working voltages with overvoltage category II and pollution degree 2 Up to 600 V AC/DC between loop current, input and output/power supply as well as 250 V AC/DC between output and power supply. For applications with high working voltages, you should ensure there is sufficient spacing or isolation from neighboring devices and protection against electrical shocks. When used in hazardous areas, the max. working voltage is 250 V.

Standards and approvals

Explosion protection	II (1) G [EEx ia] IIC current loop, input intrinsically safe, PTB 99 ATEX 2047, For further details see certificates of conformity page 140
EMC	EMC directive 89/336/EEC ³⁾

Other data

Ambient temperature	Operation: –10 ... +60 °C Transport and storage: –30 ... +80 °C
Enclosure	Modular case, width 22.5 mm, screw terminals See dimension drawings for further measurements
Protection class	Case IP 40, terminals IP 20
Mounting	With snap-on mounting for 35 mm top hat rail according to EN 50022 or M4 screw mounting, see dimension drawings for conductor cross section
Weight	Approx. 250 g

3) Deviations are possible while there is interference

Schematic diagram

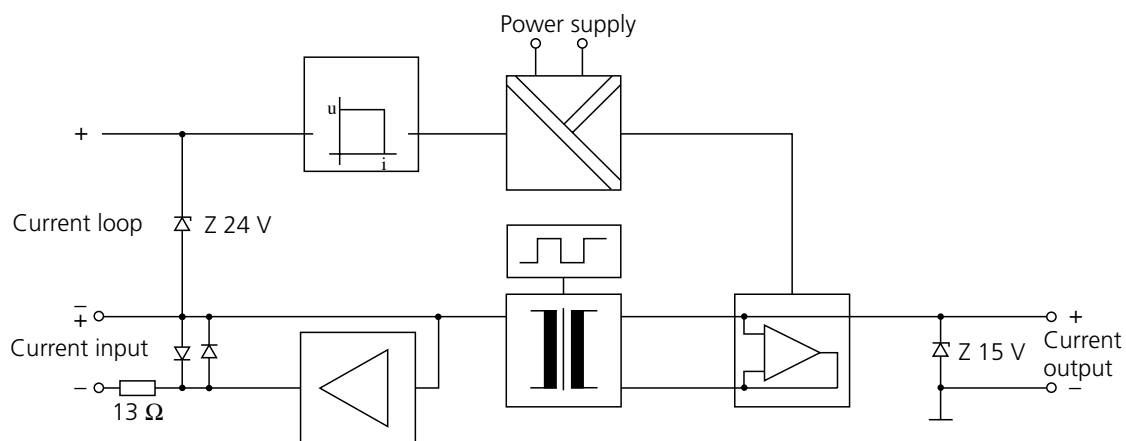

Application example

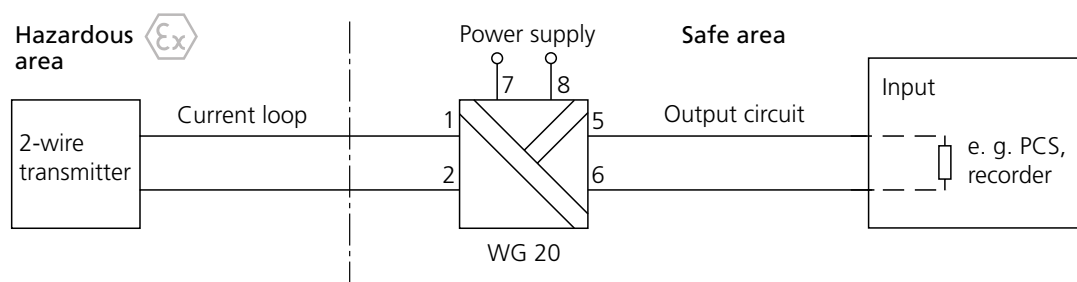

Dimension drawings and terminal assignments

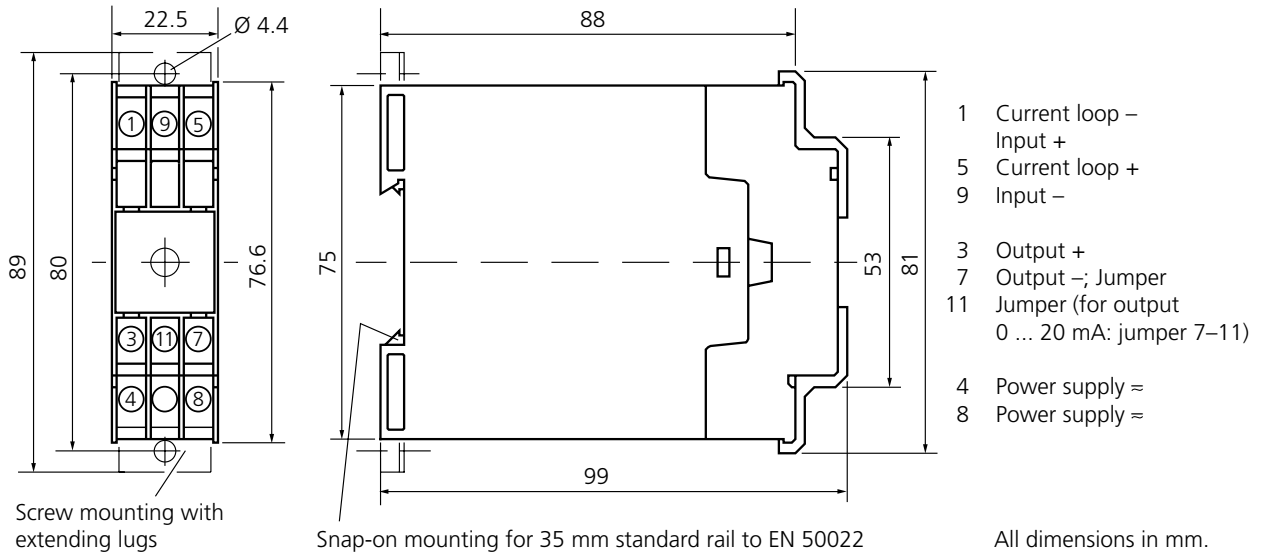

M3x8 terminal screws with self-releasing clamping pieces, max. conductor cross section 2 x 1.5 mm² solid or 2 x 1.0 mm² stranded wire with ferrule

Certificates of Conformity

print preview



Fortsetzung der Konformitätsbescheinigungen

Physikalisch-Technische Bundesanstalt 
 Braunschweig und Berlin
 SCHEDULE TO EC-TYPE-EXAMINATION CERTIFICATE PTB 99 ATEX 2047

maximum permissible external inductance $L_e = 4,6 \text{ mH}$
 maximum permissible external capacitance $C_e = 120 \text{ pF}$

or
 for connection to a certified intrinsically safe circuit with the maximum value: $I = 150 \text{ mA}$

The supply and measuring circuit and the input circuit are safely electrically isolated from the auxiliary power circuit and the output circuit up to a peak value of the nominal voltage of 375 V.

(16) Basic PTB Ex 99-20171

(17) Special conditions for safe use
 not applicable

(18) Essential health and safety requirements
 met by the standards mentioned above

Zertifizierungsgesellschaft Explosionschutz Braunschweig, April 7, 1999
 By order:

In the absence of Dr.-Ing. U. Johannsmeyer
 Regierungsdirektor



Sheet 2/2

EC type-examination Certificate without signature and official stamp shall not be valid. The certificate may be changed only without alteration. Entries or alterations are subject to approval by the Physikalisch-Technische Bundesanstalt in case of dispute, the former text shall prevail.
 Physikalisch-Technische Bundesanstalt - Bundesallee 100 • D-38110 Braunschweig

Physikalisch-Technische Bundesanstalt 
 Braunschweig und Berlin

1. SUPPLEMENT
 according to Directive 94/9/EC Annex II.6
 to EC-TYPE-EXAMINATION CERTIFICATE PTB 99 ATEX 2047
 (Translation)

Equipment: Supply/isolation amplifier, type WG 20 A2
 Marking:  II (1) G [EEx ia] IIC
 Manufacturer: Krick Elektronische Messtechnik GmbH & Co.
 Address: Beuckebach 22
 D-14163 Berlin

Description of supplements and modifications

The supply/isolation amplifier, type WG 20 A2 may in future be manufactured in accordance with the test documents listed in the accompanying test report.

The electronic current limiting has been omitted, only the resistive limiting is still effective.

The electrical data will be supplemented for the supply circuit.

Electrical data
 Supply circuit: _____ type of protection Intrinsic Safety EEx ia IIC
 (terminals 1, 2)

Maximum values:
 $U_e = 25 \text{ V}$
 $I_e = 88 \text{ mA}$
 $P_e = 704 \text{ mW}$
 $R_e = 385 \text{ } \Omega$

Inexplosive characteristics:
 C: negligibly low
 L: negligibly low

Sheet 1/2

EC type-examination Certificate without signature and official stamp shall not be valid. The certificate may be changed only without alteration. Entries or alterations are subject to approval by the Physikalisch-Technische Bundesanstalt in case of dispute, the former text shall prevail.
 Physikalisch-Technische Bundesanstalt - Bundesallee 100 • D-38110 Braunschweig

Physikalisch-Technische Bundesanstalt 
 Braunschweig und Berlin
 1. SUPPLEMENT TO EC-TYPE-EXAMINATION CERTIFICATE PTB 99 ATEX 2047

The correlation between explosion group and maximum permissible values for the external capacitances and inductances is shown in the following table:

Ex ia IIC	Ex ia IIB
$C_e = 10,4 \text{ pF}$	$C_e = 200 \text{ pF}$
$L_e = 0,8 \text{ mH}$	$L_e = 8 \text{ mH}$

All further electrical data and other details are also valid for this 1st. supplement without changes.

Test report: PTB Ex 91-21043

Zertifizierungsgesellschaft Explosionschutz Braunschweig, May 08, 2001
 By order:



Dr.-Ing. U. Johannsmeyer
 Regierungsdirektor

Sheet 2/2

EC type-examination Certificate without signature and official stamp shall not be valid. The certificate may be changed only without alteration. Entries or alterations are subject to approval by the Physikalisch-Technische Bundesanstalt in case of dispute, the former text shall prevail.
 Physikalisch-Technische Bundesanstalt - Bundesallee 100 • D-38110 Braunschweig

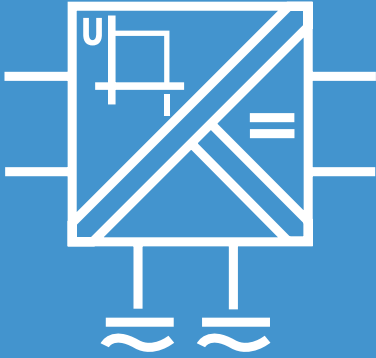

WG 21

For supply of intrinsically safe 2-wire transmitters and SMART transmitters

The WG 21 repeater power supply is used to supply intrinsically safe 2-wire transmitters. It supplies the transmitter with power and transmits the measured signal to the output galvanically isolated and with high accuracy.

In addition to the analog signal, the WG 21 also optionally transmits data protocols for SMART transmitters (HART®). It allows bidirectional communication with the field device from every point of the cabling.

The WG 21 provides safe isolation and high insulation between the input, output and power supply.

The high supply voltage, the good hazardous area specifications and the broad-range power supply allow universal use. Cables 1400 m in length can therefore be used without any problems.

Thanks to a new transformer transmission technique, the WG 21 achieves an extraordinarily high transmission accuracy for hazardous-area applications.

The encapsulation provides maximum operating safety, long-term stability and disruptive strength even under extreme ambient conditions.

The facts

- **SMART transmission**
(optional) bidirectional point-to-point transmission of digital data according to HART® specifications
- **High supply voltage and good hazardous area specifications**
universal use
- **Broad range supply**
just 2 versions for all mains voltages
- **Safe isolation in accordance with EN 61140**
protection of the maintenance staff and the subsequent devices against non-permitted high voltages
- **3-port isolation**
protection against incorrect measurements or damage to the measuring system due to parasitic voltages
- **High transmission accuracy**
exact transmission of measured values
- **Explosion protection according to ATEX**
trouble-free use in hazardous areas
- **Modular case 22.5 mm**
straightforward installation due to compact design
- **5-year warranty**

HART® is a registered trademark of the HART Communication Foundation

Warranty
5 years!

Defects occurring within 5 years from delivery are remedied free of charge at our plant (carriage and insurance paid by sender).

Product line

Devices

WG 21

Order no.

WG 21 A7

Power supply

90 ... 253 V AC

24 V AC/DC

336

Options

Transmission of data protocols for SMART transmitters (HART)

470

Specifications

Input data

Current loop

 Intrinsically safe supply voltage ≥ 18 V, constant for 0 ... 22 mA, floating, current limited to 30 mA; residual ripple < 10 mV

Output data

Output

 4 ... 20 mA¹⁾

Load

 ≤ 13 V

Offset

 < 20 μ A

Residual ripple at output

 < 10 mV

Transmission behavior

Transmission errors

0.2 % meas. val.

Response time

 < 10 ms

Temperature coefficient

 < 0.5 μ A/K +0.005 %/K full scale (average TC), (reference temperature 23 °C)

 Communication
(Option 470)

Bidirectional transmission of FSK signals according to the HART® specification between output and current loop

Power supply

Power supply

90 ... 253 V AC, 48 ... 62 Hz, approx. 3 VA

Opt. 336:

 24 V AC/DC AC: -15 % +10 %, 48 ... 500 Hz, approx. 3 VA
 DC: -15 % +20 %, approx. 2 W

1) Linear transmission of 3.6 ... 22 mA

Specifications, continued

Isolation

Galvanic isolation	3-port isolation between input, output and power supply
Test voltage	4 kV AC (current loop against output and power supply) 3 kV AC (power supply against output)
Working voltages (basic isolation)	1000 V AC/DC current loop against output and power supply, 600 V AC/DC output against power supply with overvoltage category II and pollution degree 2 according to EN 61010-1 For applications with high working voltages, you should ensure there is sufficient spacing or isolation from neighboring devices and protection against electrical shocks. Permitted working voltage for other overvoltage categories and pollution degrees on request. When used in hazardous areas, the max. working voltage is 250 V.
Protection against electrical shock	Safe isolation according to EN 61140 by reinforced insulation according to EN 61010-1. 600 V AC/DC working voltage with overvoltage category II and pollution degree 2, 300 V AC/DC current loop against output and power supply, output against power supply For applications with high working voltages, you should ensure there is sufficient spacing or isolation from neighboring devices and protection against electrical shocks.

Standards and approvals

Explosion protection	II (1) G [EEx ia] IIC PTB 01 ATEX 2059 current loop intrinsically safe For further details see certificates of conformity page 147
EMC ²⁾	EMC directive 89/336/EEC, EN 61326, NAMUR NE 21

Other data

Ambient temperature	Operation: – 10 ... +60 °C Transport and storage: – 30 ... +80 °C
Version	Modular case, width 22.5 mm, screw terminals, see dimension drawings for further measurements
Protection class	Case IP 40, terminals IP 20
Mounting	With snap-on mounting for 35 mm top hat rail according to EN 50022, see dimension drawings for conductor cross section
Weight	Approx. 250 g

2) Slight transmission errors are possible while there is interference

Schematic diagram

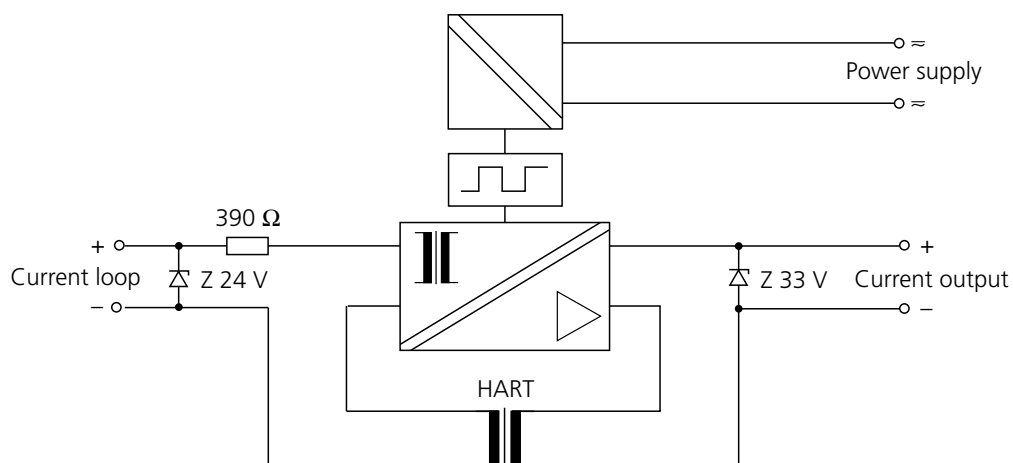

Application example

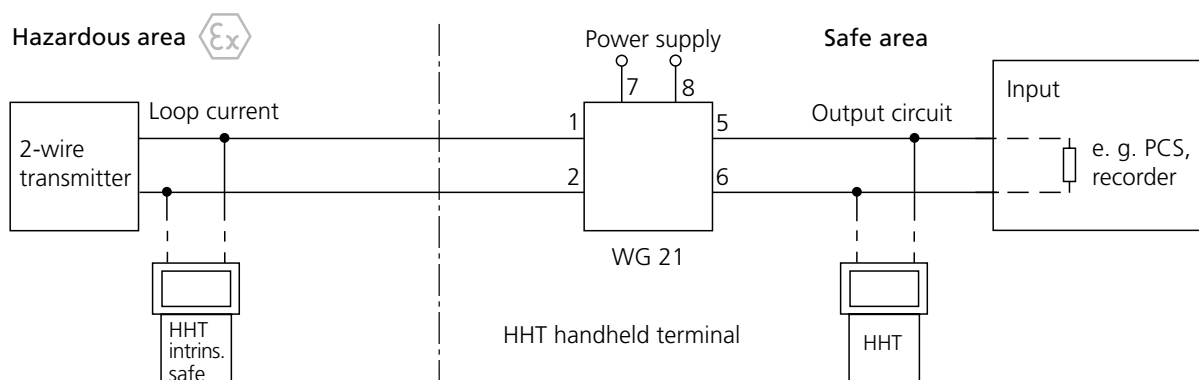

HART communication between transmitter and HHT on intrinsically safe current loop.

The communication signals are also transmitted to the non-intrinsically safe output circuit. A HART resistor of $390\ \Omega$ is integrated in the WG 21.

HART communication between transmitter and PLC, HHT at non-intrinsically safe output circuit.

The communication signals are transmitted bidirectionally via the WG 21. A minimum load resistance of $230\ \Omega$ is required that should also be connected in addition.

Dimension drawings and terminal assignments

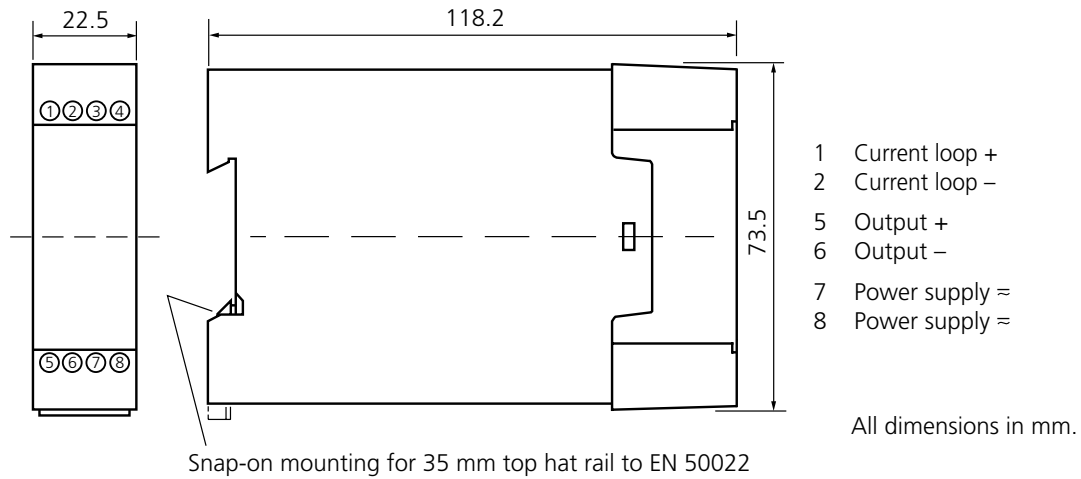

Captive M3x8 clamp screws, box terminals with self-releasing wire protection,
 max. conductor cross section 1 x 4 mm² solid
 1 x 2.5 mm² stranded wire with ferrule
 2 x 1.5 mm² stranded wire with ferrule

Installation, commissioning and maintenance may only be carried out by trained personnel.

Certificates of Conformity

print preview

Physikalisch-Technische Bundesanstalt
Braunschweig und Berlin

PTB

EC-TYPE-EXAMINATION CERTIFICATE
(Translation)

(1) Equipment and Protective Systems Intended for Use in Potentially Explosive Atmospheres - Directive 94/9/EC

(2) EC-type-examination Certificate Number: **PTB 01 ATEX 2009**

(3) Equipment: Resistor power supply, type WG 21 A7 Opt. ...

(4) Manufacturer: Krick Elektronische Meßgeräte GmbH & Co.

(5) Address: Beuckestraße 22, 14183 Berlin, Deutschland

(6) This equipment and any acceptable variation thereto are specified in the schedule to this certificate and the documents therein referred to.

(7) The Physikalisch-Technische Bundesanstalt, notified body No. 0102 in accordance with Article 9 of the Council Directive 94/9/EC of 23 March 1994, certifies that this equipment has been found to comply with the Essential Health and Safety Requirements relating to the design and construction of equipment and protective systems intended for use in potentially explosive atmospheres, given in Annex I to the Directive.

The examination and test results are recorded in the confidential report PTB-Ex 01-21018.

(8) Compliance with the Essential Health and Safety Requirements has been assured by compliance with:
EN 50214:1997 + A1 + A2 **EN 50220:1994**

(10) If the sign "X" is placed after the certificate number, it indicates that the equipment is subject to special conditions for safe use specified in the schedule to this certificate.

(11) This EC-type-examination Certificate relates only to the design and construction of the specified equipment in accordance with Directive 94/9/EC. Further requirements of this Directive apply to the manufacture and supply of this equipment.

(12) The marking of the equipment shall include the following:

CE (1) X [EEEx] II IC

Zertifizierungsinstitut Exploreschule
By order:
Dr.-Ing. U. Jähres
Regierungsdirektor

Braunschweig, July 19, 2001

sheet 1/3

EC-type-examination Certificates without signature and official stamp shall not be valid. The certificate may be divided only without alteration. Extracts or alterations are subject to approval by the Physikalisch-Technische Bundesanstalt, in case of dispute, the German national court.
Physikalisch-Technische Bundesanstalt • Bundesallee 100 • D-38110 Braunschweig

Physikalisch-Technische Bundesanstalt
Braunschweig und Berlin

PTB

SCHEDULE

(13) **EC-TYPE-EXAMINATION CERTIFICATE PTB 01 ATEX 2009**

(14) **Description of equipment**

The resistor power supply, type WG 21 A7 Opt. ... is mainly used for the supply of intrinsically safe 2-wire measuring transmitters and for the transmission of a measuring current into the electrically isolated output circuit.
Optionally data protocols for SMART transmitters are transmitted bi-directionally between the supply measuring circuit and the output circuit.

The apparatus will be installed outside the hazardous area.
The maximum permissible ambient temperature is 50 °C.

Electrical data

Auxiliary power circuit (Annexes 1, 8)

20 ... 250 V AC, approx. 5 VA
24 V AC -15 % +10 %, approx. 3.5 VA
24 V DC -15 % +30 %, approx. 2.8 W
U₀ = 250 V

Supply measuring circuit (Annexes 1, 2)

type of protection Intrinsic Safety **EEEx** II IC
resp. **EEEx** II IC

Maximum values:
U₀ = 25.1 V
I₀ = 82 mA
P₀ = 643 mW
R₀ = 398 Ω

Impedance characteristics:
C: negligibly low
L: negligibly low

The correlation between type of protection and maximum permissible values for the external capacitance and inductance is shown in the following table.

	EEEx II IC	EEEx II IB	EEEx II IIB
C ₀	27 nF	300 nF	200 nF
L ₀	0.5 mH	1 mH	5 mH

sheet 2/3

EC-type-examination Certificates without signature and official stamp shall not be valid. The certificate may be divided only without alteration. Extracts or alterations are subject to approval by the Physikalisch-Technische Bundesanstalt, in case of dispute, the German national court.
Physikalisch-Technische Bundesanstalt • Bundesallee 100 • D-38110 Braunschweig

Physikalisch-Technische Bundesanstalt
Braunschweig und Berlin

PTB

SCHEDULE TO EC-TYPE-EXAMINATION CERTIFICATE PTB 01 ATEX 2009

Output circuit (Annexes 1, 8)

I₀ = 0 - 20 mA
U₀ = 15 V
U₀ = 250 V AC

The intrinsically safe supply measuring circuit is safely electrically isolated from the other non-intrinsically safe circuits up to a peak value of the nominal voltage of 575 V.

(16) **Test report** PTB-Ex 01-21018

(17) **Special conditions for safe use**
none

(18) **Essential health and safety requirements**
will be met by cited standards

Zertifizierungsinstitut Exploreschule
By order:
Dr.-Ing. U. Jähres
Regierungsdirektor

Braunschweig, July 19, 2001

sheet 3/3

EC-type-examination Certificates without signature and official stamp shall not be valid. The certificate may be divided only without alteration. Extracts or alterations are subject to approval by the Physikalisch-Technische Bundesanstalt, in case of dispute, the German national court.
Physikalisch-Technische Bundesanstalt • Bundesallee 100 • D-38110 Braunschweig

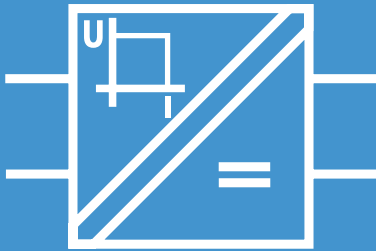

WG 25

For supply of intrinsically safe 2-wire transmitters and SMART transmitters

The passive WG 25 repeater power supply is loop-powered. It is used for galvanic hazardous area isolation of a 2-wire supply line and transmits both 4 ... 20 mA and HART® signals in each direction. With a voltage drop of just 4.2 V, the WG 25 uses the supply optimally so that all common 2-wire transmitters can be connected.

Compared with active repeater power supplies, it has considerable price and reliability advantages.

For example, only a central, safe-area power supply that does not even need safe isolation is required for multi-channel systems.

Using Knick TransShield® technology, the WG 25 has specifications that have not yet been achieved by passive repeater power supplies:

- Extremely high reliability, MTF of 300 years
- Safe isolation, transient protection
- 10 kV test voltage (optional)
- High electromagnetic compatibility
- Extremely low residual ripple and common-mode interference
- Excellent pulse formation
- HART® transmission
- Hazardous/safe-area isolation

The facts

- **Low-cost**
good price due to omission of integrated power supply
- **No mains supply required**
cost saving due to lower wiring requirement, no mains influences
- **Low power loss**
no unnecessary heating in switch cabinet
- **Safe isolation in accordance with EN 61140**
protection of the maintenance staff and the subsequent devices against non-permitted high voltages
- **HART® transmission**
bidirectional point-to-point transmission of digital data according to HART® specifications
- **EMC tested**
RFI suppressed and surge proof, reliable operation even with electromagnetic interference
- **Maximum reliability**
no maintenance work, therefore the related costs are not incurred
- **5-year warranty**

HART® is a registered trademark of the HART Communication Foundation

Warranty
5 years!

Defects occurring within 5 years from delivery are remedied free of charge at our plant (carriage and insurance paid by sender).

Product line

Devices

WG 25

Order no.

WG 25 A7

Power supply

None, supply from output signal

Options

Increased test voltage 10 kV AC

471

Specifications

Input data

Input (current loop)	4 ... 20 mA (transmission up to 22 mA possible), intrinsically safe
Supply voltage	≥ 17 V, short-circuit-proof, see diagram on page 149
Operating current	< 1 mA
Input short-circuit current	≤ 28 mA
Voltage drop	< 4.2 V at 20 mA and supply ≤ 20 V, see diagram on page 151

Output data

Output	4 ... 20 mA, 1:1 transmission (22 mA)
Overload	50 mA, 30 V (corresponds to 600 Ohm load)
Offset	< 20 μA
Residual ripple V_{rms}	< 1.5 mV/mA

Transmission behavior

Transmission errors	0.2 % meas. val.
Supply voltage influence	< 15 μA/V
HART attenuation	< 10 dB

Specifications, continued

Isolation

Test voltage	4.4 kV AC 10 kV AC with option 471
Working voltages (basic isolation)	1000 V AC/DC with overvoltage category II and pollution degree 2 according to EN 61010-1. For applications with high working voltages, you should ensure there is sufficient spacing or isolation from neighboring devices and protection against electrical shocks. Permitted working voltage for other overvoltage categories and pollution degrees on request. When used in hazardous areas, the max. working voltage is 250 V.
Protection against electrical shock	Safe isolation according to EN 61140 by reinforced insulation according to EN 61010-1. Working voltage with overvoltage category II and pollution degree 2 up to 600 V AC/DC. For applications with high working voltages, you should ensure there is sufficient spacing or isolation from neighboring devices and protection against electrical shocks. When used in hazardous areas, the max. working voltage is 250 V.

Standards and approvals

Explosion protection	II (2) G [Ex ib] IIC PTB 02 ATEX 2063, for further details see certificates of conformity on page 154
EMC	EMC directive 89/336/EEC, EN 61326, NAMUR NE 21

Other data

Ambient temperature	Operation: –10 ... +50 °C Transport and storage: –30 ... +80 °C
Version	Modular case, width 22.5 mm, screw terminals See dimension drawings for further measurements
Protection class	Case IP 40, terminals IP 20
Mounting	With snap-on mounting for 35 mm top hat rail according to EN 50022, see dimension drawings for conductor cross section
Weight	Approx. 120 g

Supply voltage dependent on supply

Supply voltage
on 2-wire
transmitter [V]

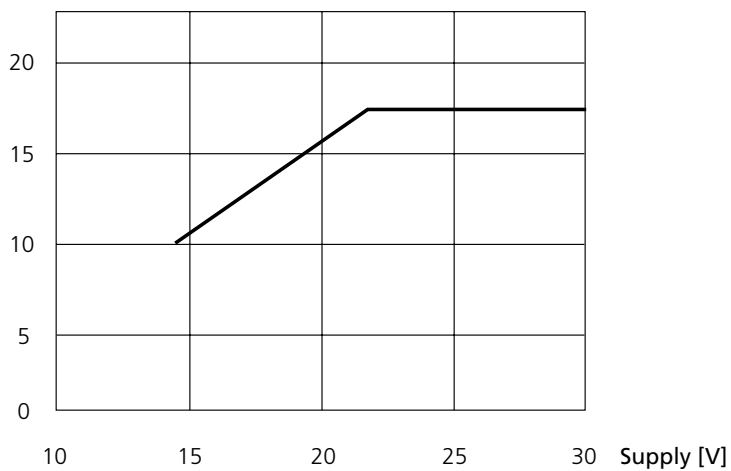

Schematic diagram

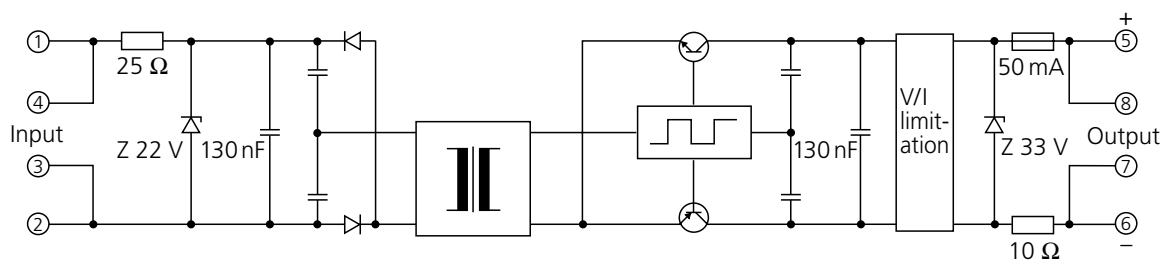

Wiring examples

Without HART communication

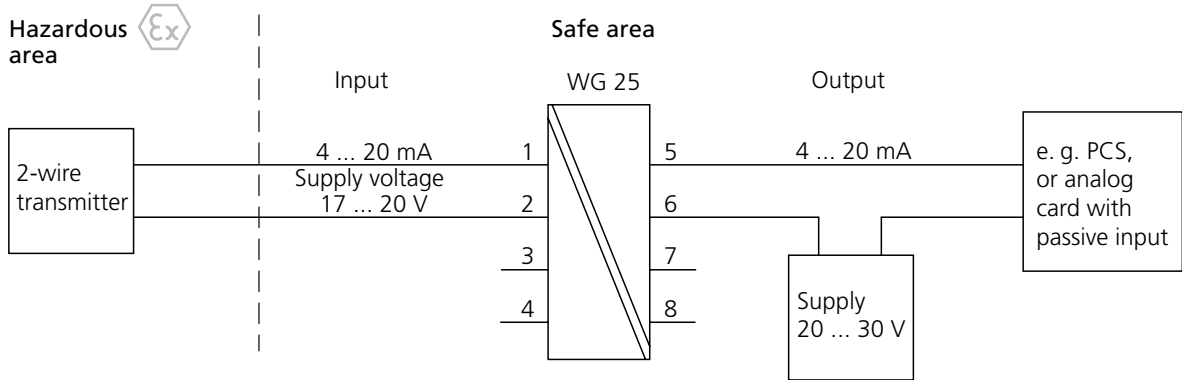

With HART communication

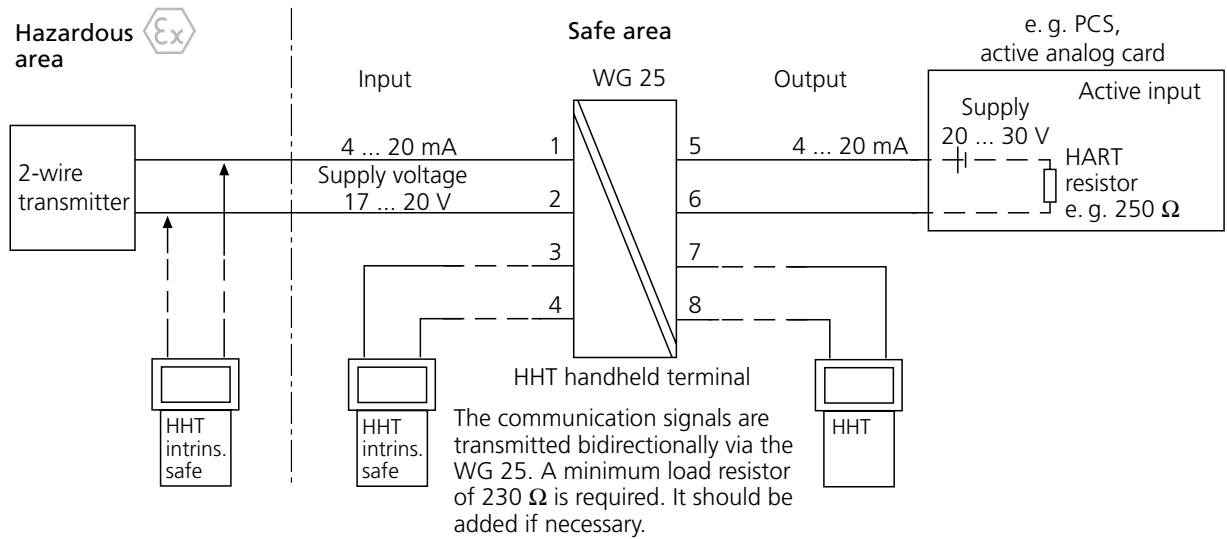

Dimension drawings and terminal assignments

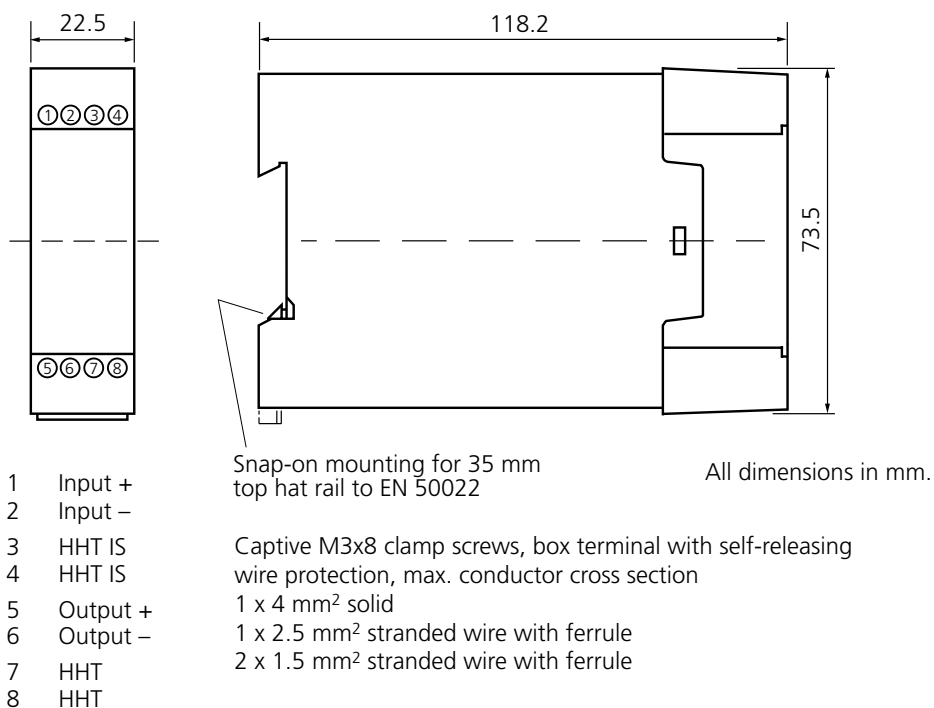

Installation, commissioning and maintenance may only be carried out by trained personnel.

Certificates of Conformity

print preview

Physikalisch-Technische Bundesanstalt **PTB**
 Braunschweig und Berlin

(1) **EC-TYPE-EXAMINATION CERTIFICATE**
 (Translation)

(2) Equipment and Protective Systems Intended for Use in Potentially Explosive Atmospheres - Directive 94/9/EC

(3) EC-Type-examination Certificate Number: **PTB 02 ATEX 2063**

(4) Equipment: Supply and isolating unit, passive, type WG 25 A7 resp. isolator without auxiliary power, type IsoTrans 37 A7

(5) Manufacturer: Knick Elektronische Messtechnik GmbH & Co.

(6) Address: Beckweg 22, 14163 Berlin, Germany

(7) The equipment and any acceptable variation thereto are specified in the schedule to this certificate and the documents therein referred to.

(8) The Physikalisch-Technische Bundesanstalt, notified body No. 0102 in accordance with Article 9 of the Council Directive 94/9/EC of 23 March 1994, certifies that the equipment has been found to comply with the Essential Health and Safety Requirements relating to the design and construction of equipment and protective systems intended for use in potentially explosive atmospheres, given in Annex 9 to the Directive.

The examination and test results are recorded in the confidential report PTB Ex 02-21/08

(9) Compliance with the Essential Health and Safety Requirements has been assured by compliance with:

(10) If the sign "II" is placed after the certificate number, it indicates that the equipment is subject to special conditions for safe use specified in the schedule to this certificate.

(11) This EC-type-examination Certificate relates only to the design, examination and tests of the specified equipment in accordance to the Directive 94/9/EC. Further requirements of the Directive apply to the manufacturing process and supply of this equipment. These are not covered by this certificate.

(12) The marking of the equipment shall include the following:

II (2) G [EEx B] IC

Zertifizierungsbüro Explosionschutz Braunschweig, May 23, 2002

By order:
 Dr.-Ing. U. Johannmeyer
 Regierungsdirektor

sheet 1/3

EC-type-examination Certificates without signature and official stamp shall not be valid. The certificate may be checked only without alteration. Extracts or alterations are subject to approval by the Physikalisch-Technische Bundesanstalt. In case of dispute, the German text shall prevail.
 Physikalisch-Technische Bundesanstalt - Bundesallee 100 - D-38110 Braunschweig

Physikalisch-Technische Bundesanstalt **PTB**
 Braunschweig und Berlin

SCHEDULE

(13) **EC-TYPE-EXAMINATION CERTIFICATE PTB 02 ATEX 2063**

(14) **DESCRIPTION OF EQUIPMENT**

The supply and isolating unit, type WG 25 A7 is preferably used as passive supply and isolating unit for 2-wire measuring transducers.

When designed as isolator without auxiliary power, type IsoTrans 37 A7 it is preferably used as isolating transformer for 4 ... 20-mA signal circuits.

The unit is installed outside of hazardous areas.

The permissible temperature range is -10 °C up to +50 °C.

Electrical data

WG 25 A7

Operating values:
 U₀ = 30 V, I₀ = 22 mA
 U_L = 253 V

Output circuit (terminals 5,6 and 6,7): type of protection Intrinsic Safety EEx i IC

Input/Supply measuring circuit (terminals 1,4 and 2,3): type of protection Intrinsic Safety EEx i IC

Maximum values:
 U₀ = 23.1 V
 I₀ = 28 mA
 P₀ = 647 mW

rectangular characteristic
 C: negligibly low
 L: negligibly low

IsoTrans 37 A7

Operating values:
 U₀ = 30 V, I₀ = 22 mA
 U_L = 253 V

Input circuit (terminals 1,4 and 2,3): type of protection Intrinsic Safety EEx i IC

Output circuit (terminals 5,6 and 6,7): type of protection Intrinsic Safety EEx i IC

Maximum values:
 U₀ = 23.1 V
 I₀ = 28 mA
 P₀ = 647 mW

rectangular characteristic
 C: negligibly low
 L: negligibly low

sheet 2/3

EC-type-examination Certificates without signature and official stamp shall not be valid. The certificate may be checked only without alteration. Extracts or alterations are subject to approval by the Physikalisch-Technische Bundesanstalt. In case of dispute, the German text shall prevail.
 Physikalisch-Technische Bundesanstalt - Bundesallee 100 - D-38110 Braunschweig

Physikalisch-Technische Bundesanstalt **PTB**
 Braunschweig und Berlin

SCHEDULE TO EC-TYPE-EXAMINATION CERTIFICATE PTB 02 ATEX 2063

WG 25 A7 and IsoTrans 37 A7

The assignment of explosion group and external capacitance and inductance is shown in the following table:

EEx B	IC	IC	IB	IB
C _e	140 nF	90 nF	940 nF	480 nF
L _e	0.1 mH	0.5 mH	0.1 mH	10 mH

The output circuit is safely electrically isolated from the input circuit/supply measuring circuit up to a peak value of the nominal voltage of 375 V.

(16) Test report PTB Ex 02-21/08

(17) Special conditions for safe use: none

(18) Essential health and safety requirements will be met by the standards quoted

Zertifizierungsbüro Explosionschutz Braunschweig, May 23, 2002

By order:
 Dr.-Ing. U. Johannmeyer
 Regierungsdirektor

sheet 3/3

EC-type-examination Certificates without signature and official stamp shall not be valid. The certificate may be checked only without alteration. Extracts or alterations are subject to approval by the Physikalisch-Technische Bundesanstalt. In case of dispute, the German text shall prevail.
 Physikalisch-Technische Bundesanstalt - Bundesallee 100 - D-38110 Braunschweig

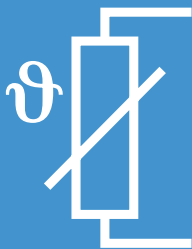

ThermoTrans® 205/206

The practical solution for temperature measurement with resistance thermometers.

The ThermoTrans® 205/206 temperature transmitters provide you with the flexibility you need:

- Adjustment work where it is only really necessary, instead of complicated parameter tables.

- High level of reliability and compact design due to digital signal processing specially developed for the measuring task instead of unnecessary reduction in reliability due to overburdening with complicated technology.

For the majority of the standard applications with fixed preset parameters, you simply select one of the numerous preconfigured standard models.

You can solve special measuring tasks with a transmitter that we configure according to your specifications.

Configuration or adaptation to the measuring task is also not a problem "on site" via the optical interface. The user-friendly, menu-guided Paraly® communication software is supplied together with a fiber-optic cable incl. PC adapter.

The ThermoTrans® 205/206 temperature transmitters provide safe isolation and high insulation resistance between the input, output and power supply. They meet the strict NAMUR EMC-requirements and can easily be used for measurements in hazardous areas.

Vacuum encapsulation protects the devices against aggressive environmental influences, shock and vibrations.



Warranty
5 years!

Defects occurring within 5 years from delivery are remedied free of charge at our plant (carriage and insurance paid by sender).

ThermoTrans® 205/206 for resistance thermometers

Resistance thermometers are highly accurate temperature sensors with long-term stability for measuring temperatures up to max. 850 °C.

They are mainly used to measure low and medium temperatures, for example, in air-conditioning, process engineering and the food industry.

The ThermoTrans® 205/206 transmitters allow connection of all common resistance thermometers either in 2, 3 or 4-wire circuits.

The possibility for connecting resistance-type sensors and potentiometers creates a wide range of application possibilities, for example, in the field of position measurement. Converting the input signal into a proportional current/voltage signal allows simple further processing.

The facts

- Explosion protection [EEx ia] IIC**
 according to ATEX, trouble-free use in hazardous areas
- Extensive range of standard models**
 for standard applications, configuration not necessary
- Adjustable via optical interface**
 universal for a wide range of measuring tasks, can also be configured on site
- Paraly® PC configuration software with tag database**
 simple, menu-guided configuration in accordance with VDI/VDE 2187, archiving of configuration data
- EMC-tested according to European EMC regulations and NAMUR NE 21**
 reliable operation even with electromagnetic interference in the mains or in the environment
- Safe isolation in accordance with EN 61140**
 protection of the maintenance staff and the subsequent devices against non-permitted high voltages
- 22.5 mm wide modular case with 73.5 mm standard height**
 compact design means easy installation, also easy to fit in standard cabinets
- 5-year warranty**



- ▲ You can use the menu-guided Paraly® communication software (according to VDI/VDE 2187) to configure the transmitters. Data from different measuring points can be easily archived and managed in the corresponding tag database.

Product line

		ThermoTrans® 205 with current output	ThermoTrans® 206 with voltage output
Adjustable models	Order no.	205 A7 000 000 Opt. 444	206 A7 000 000 Opt. 444
Adjustable via interface. See Configuration Schedule for factory setting.			
Fixed range standard models	Order no.	205 A7 x xx xx x Opt. 444	206 A7 x xx xx V Opt. 444
Sensors	Pt 100 (–200 ... +850 °C) Pt 1000 (–200 ... +850 °C) Ni 100 (–60 ... +180 °C) 1000 Ohms 5000 Ohms	A B C D E	A B C D E
Span	50 K 100 K 150 K 200 K 300 K 400 K 1000 Ohms 5000 Ohms	05 10 15 20 30 40 70 88	05 10 15 20 30 40 70 88
Start of scale	–100 °C –50 °C 0 °C 50 °C 100 °C 200 °C 0 Ohm	02 01 00 11 12 14 30	02 01 00 11 12 14 30
Output	0 ... 20 mA 4 ... 20 mA 0 ... 10 V	D L	V

Standard model with 4-wire connection (3-wire connection Opt. 494), rising output curve, without filter constant
 ThermoTrans® 205: open circuit recognition 22 mA. ThermoTrans® 206: open circuit recognition 11 V

Power supply	Order no.
230 V AC	
24 V AC/DC	336
115 V AC	363

Options

ThermoTrans® 205/206 standard model with 3-wire connection	494
--	-----

Accessories

Communications kit	For configuration of the temperature transmitter, with tag database according to VDI/VDE 2187, consisting of: – Optical fibre connecting cable 3 m – Adapter D-Sub 9-pole – D-Sub 25-pole – Optical interface adapter – RS 232 – Paraly® configuration software and tag database	ZU 0254
--------------------	--	---------

Product line

		ThermoTrans® 205 with current output	ThermoTrans® 206 with voltage output
Customer-specific models	Order no.	205 A7 999 999 Opt. 444	206 A7 999 999 Opt. 444

Configuration schedule

Important! Please fill in the configuration schedule completely and enclose it with your order. If entries are missing, the value entered in square brackets or the dark-colored setting will be set.

ThermoTrans® 205/206

Sensor ¹⁾	Temperature probe: <input checked="" type="checkbox"/> Pt 100 according to IEC 751 <input type="checkbox"/> Pt 500 <input type="checkbox"/> Pt 1000 <input type="checkbox"/> Ni 100 according to IEC 43 760 <input type="checkbox"/> Ni 120 <input type="checkbox"/> Ni 500 <input type="checkbox"/> Ni 1000
	Resistance sensor or potentiometers: <input type="checkbox"/> ≤500 Ohms <input type="checkbox"/> ≤5000 Ohms
Connection	<input type="checkbox"/> 2-wire connection Line resistance ²⁾ _____ . _____ Ohms <input type="checkbox"/> 3-wire connection <input checked="" type="checkbox"/> 4-wire connection
Range	Start of scale ²⁾ _____ °C [0 °C] or _____ Ohms Span ²⁾ _____ K [100 K] or _____ Ohms
Output ³⁾	<input checked="" type="checkbox"/> 0 ... 20 mA <input type="checkbox"/> 4 ... 20 mA <input type="checkbox"/> 0 ... 10 V
Curve	<input checked="" type="checkbox"/> Rising <input type="checkbox"/> Falling
Error messages	Message: <input checked="" type="checkbox"/> only with open circuit <input type="checkbox"/> with open circuit and overrange
	Signal: <input checked="" type="checkbox"/> 22 mA or 11 V <input type="checkbox"/> -1 mA or -0.5 V
Filter constant T ₉₉	_____ s ²⁾ (1st order filter) [0 s]
Tag number	_____ [None]

1) Other models on request
 3) Other values on request

2) See specifications for the possible parameter range

Specifications

Input data	Sensor type	Measurement range	Span (user-defined)
Intrinsically safe	Pt 100 to IEC 751 Pt 500 Pt 1000	-200 ... +850 °C	25 ... 1050 K
	Ni 100 to DIN 43760 Ni 120 Ni 500 Ni 1000	-60 ... +180 °C	25 ... 240 K
	Remote resistance sensors and potentiometers	0 ... 500 Ohms or 0 ... 5000 Ohms	9 ... 500 Ohms or 90 ... 5000 Ohms
Connection	<p>2-wire connection: configured line resistance is calculated in the measured value</p> <p>3-wire connection: $R_{L1} = R_{L4}$</p> <p>4-wire connection</p>		
Max. line resistance	$R_{L1} + R_{L4} = 100$ Ohms		
Sensor current	Approx. 1 mA or 0.1 mA depending on the measurement range		
Open-circuit voltage	<5 V		
Sensor failure monitoring	All inputs for open circuit		
Input error limits	Resistance: Range 0 ... 500 Ohms ± 0.05 Ohm Range 0 ... 5 kOhms ± 0.5 Ohm with Pt: Range -200 ... +850 °C ± 0.2 K with Ni: Range -60 ... +180 °C ± 0.2 K		
Temperature coefficient at input	0.0025 %/K full scale (average TC in permitted operating temperature range, reference temperature 23 °C)		
Output data			
Output signal (0 ... 100 %)	Model 205: 0/4 ... 20 mA, impressed current, load voltage ≤ 10 V Model 206: 0 ... 10 V, impressed voltage, load current ≤ 10 mA		
Resolution	Approx. 8000 steps (for 0 ... 100 %)		
Control range	-2.5 % ... 102.5 % of span		
Overrange with error message	Model 205: -1.0 mA or 22 mA Model 206: -0.5 V or 11 V		
Output error limits	0.1 % full scale		
Temperature coefficient at output	0.01 %/K full scale (average TC in permitted operating temperature range, reference temperature 23 °C)		
Residual ripple at output	<10 mV _{pp} + digitalization error of input		

Specifications, continued

Transmission behavior

Characteristic	Resistance or temperature-linear rising or falling
Meas. rate	Approx. 1/s
Response time T_{99}	≤ 900 ms
Digital output filter	$T_{99} = 0 \dots 100$ s (1st order filter)

Power supply

Power supply	230 V AC $-15\% +10\%$, 48 ... 62 Hz, approx. 2 VA
Option 336:	24 V AC/DC AC: $-15\% +10\%$, 48 ... 500 Hz, approx. 1.5 VA DC: $-15\% +20\%$, approx. 1.2 W
Option 363:	115 V AC $-15\% +10\%$, 48 ... 62 Hz, approx. 2 VA

Isolation

Galvanic isolation	3-port isolation between input, output and power supply
Test voltage	4 kV AC (input against output and power supply) 3 kV AC (output against power supply)
Working voltage (basic isolation)	1000 V AC/DC input against output and power supply with overvoltage category II and pollution degree 2, 330 V AC/DC output against power supply with overvoltage category II and pollution degree 2, according to EN 61010-1 For applications with high working voltages, you should ensure there is sufficient spacing or isolation from neighboring devices and protection against electrical shocks. When used in hazardous areas, the max. working voltage is 250 V.
Protection against electrical shock	Safe isolation according to EN 61140 by reinforced insulation according to EN 61010-1. Working voltages with overvoltage category II and pollution degree 2: 600 V AC/DC for input against output and power supply with overvoltage category II and pollution degree 2: 300 V AC/DC for output against power supply. For applications with high working voltages, you should ensure there is sufficient spacing or isolation from neighboring devices and protection against electrical shocks. When used in hazardous areas, the max. working voltage is 250 V.

Standards and approvals

Explosion protection (opt. 444)	II (1) G [EEx ia] II C PTB 02 ATEX 2107 For further details see certificates of conformity page 164
Surge withstand	5 kV 1.2/50 μ s according to IEC 255-4
EMC 1)	EMC directive 89/336/EEC, EN 61326; NAMUR recommendation NE 21

1) Slight deviations are possible while there is interference from RF radiation

Specifications, continued

Other data

Interface (only user-definable models)	Optical, interface adapter on RS 232 interface (PC) is included in the ZU 0254 communications kit
Ambient temperature	Operation: -10 ... +60 °C Transport and storage: -30 ... +80 °C
Enclosure	Modular case A7, width 22.5 mm, screw terminals, see dimension drawings for further measurements
Protection class	Case IP 40, terminals IP 20
Mounting	With snap-on mounting for 35 mm top hat rail according to EN 50022-35, width 22.5 mm, see dimension drawings for conductor cross section
Weight	Approx. 300 g

Schematic diagram

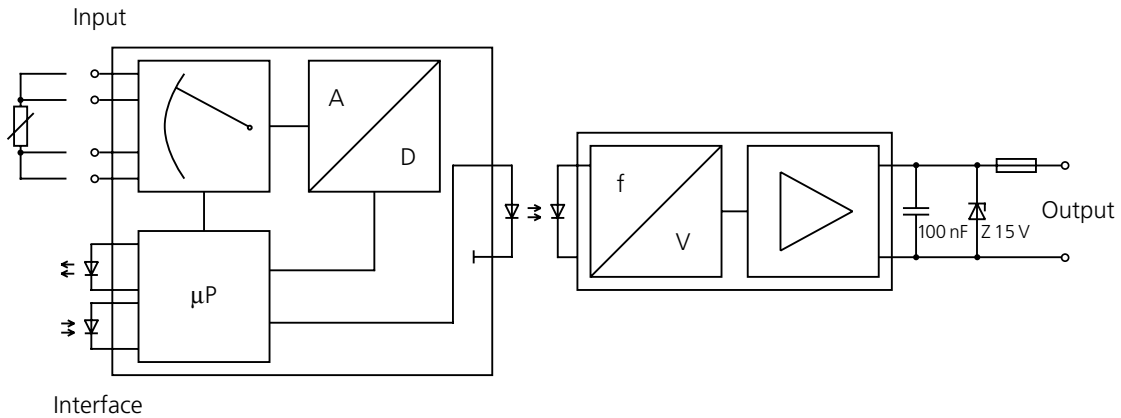

Application examples

2-wire circuit

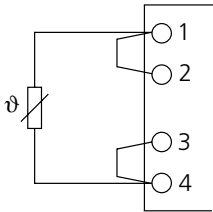

3-wire circuit

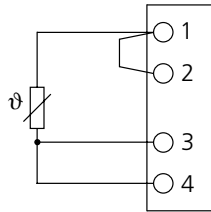

4-wire circuit

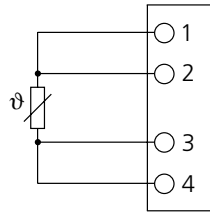

Dimension drawings and terminal assignments

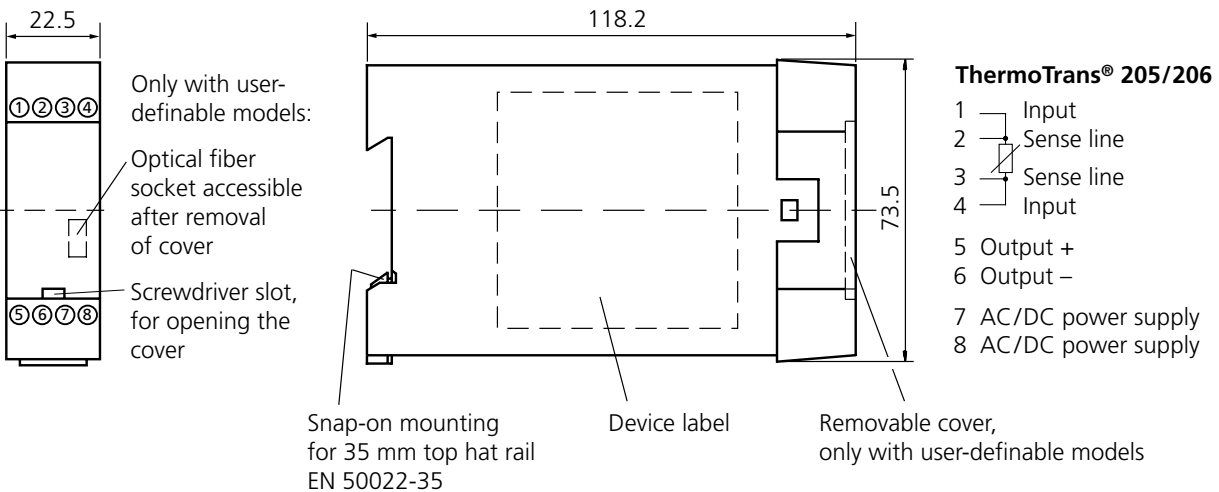

Captive M3x8 clamp screws, box terminals with self-releasing wire protection,
 max. conductor cross section 1 x 4 mm² solid
 1 x 2.5 mm² stranded wire with ferrule
 2 x 1.5 mm² stranded wire with ferrule

All dimensions in mm.

Certificates of Conformity

print preview

Physikalisch-Technische Bundesanstalt
Braunschweig und Berlin

PTB

EC-TYPE-EXAMINATION CERTIFICATE
(Translation)

(2) Equipment and Protective Systems Intended for Use in Potentially Explosive Atmospheres – Directive 94/9/EC

(3) EC-type examination Certificate Number:
PTB 02 ATEX 2107

(4) Equipment: Temperature Transmitter ThermoTrans Model 27 AT Opt. ...

(5) Manufacturer: Kistek Elektronische Messtechnik GmbH & Co.

(6) Address: Beckstraße 22, 14193 Berlin, Germany

(7) This equipment and any acceptable variation thereto are specified in the schedule to this certificate and the documents therein referred to.

(8) The Physikalisch-Technische Bundesanstalt, notified body No. 0102 in accordance with Article 9 of the Council Directive 94/9/EC of 23 March 1994, certifies that this equipment has been found to comply with the Essential Health and Safety Requirements relating to the design and construction of equipment and protective systems intended for use in potentially explosive atmospheres, given in Annex II to the Directive.

The examination and test results are recorded in the confidential report PTB Ex 02-22171.

(9) Compliance with the Essential Health and Safety Requirements has been assumed by compliance with:
EN 50514:1997 + A1 + A2 **EN 50520:1994**

(10) If the sign "C" is placed after the certificate number, it indicates that the equipment is subject to special conditions for safe use specified in the schedule to this certificate.

(11) This EC-type-examination Certificate relates only to the design, examination and tests of the specified equipment in accordance to the Directive 94/9/EC. Further requirements of the Directive apply to the manufacturing process and supply of this equipment. These are not covered by this certificate.

(12) The marking of the equipment shall include the following:

Ex (I) G [EEx ia] IIC

Zertifizierungs- und Examinationsstelle
By order:
Dr.-Ing. U. Johannsmann
Regierungsdirektor

Braunschweig, August 27, 2002

sheet 1/4

EC-type-examination Certificate without signature and official stamp shall not be valid. The certificate may be consulted only without alteration. Extracts or abridgements are subject to approval by the Physikalisch-Technische Bundesanstalt. In case of dispute, the German text shall prevail.
Physikalisch-Technische Bundesanstalt • Bundesallee 100 • D-38116 Braunschweig

Physikalisch-Technische Bundesanstalt
Braunschweig und Berlin

PTB

SCHEDULE

(13)

(14) **EC-TYPE-EXAMINATION CERTIFICATE PTB 02 ATEX 2107**

(15) **Description of equipment**
The temperature transmitter ThermoTrans Model 27 AT Opt. ... with its different variants is used for the detection of resistance-proportional measuring signals and of thermo-electromotive forces and their conversion to injected current and voltage signals into the output circuit. The apparatus is installed outside hazardous areas. The permissible range of the ambient temperature is: -10 °C ... 60 °C.

Electrical data

Auxiliary power circuit: 230 V AC -15 % +10 %, approx. 2 VA (terminals 1, 6)
115 V AC -15 % +10 %, approx. 2 VA
24 V AC -15 % +10 %, approx. 1.5 VA
24 V DC -15 % +20 %, approx. 1.2 W

Output circuit: I = 0 ... 20 mA (terminals 5, 6)
U = 10 V
U₀ = 253 V

Types IP ...
Resistance measuring circuit: type of protection intrinsic Safety EEx ia IIC (terminals 1, 2, 3, 4)

Maximum values:
U₀ = 6 V
I₀ = 15 mA
P₀ = 20 mW
R₀ = 480 Ω
linear characteristic
L₀ = 3 nH
C₀ = 2300 nF
L: negligibly low
C: negligibly low

The resistance measuring circuit is safely electrically isolated from the auxiliary power circuit and from the output circuit up to a peak value of the nominal voltage of 275 V.

sheet 2/4

EC-type-examination Certificate without signature and official stamp shall not be valid. The certificate may be consulted only without alteration. Extracts or abridgements are subject to approval by the Physikalisch-Technische Bundesanstalt. In case of dispute, the German text shall prevail.
Physikalisch-Technische Bundesanstalt • Bundesallee 100 • D-38116 Braunschweig

Physikalisch-Technische Bundesanstalt
Braunschweig und Berlin

PTB

SCHEDULE TO EC-TYPE-EXAMINATION CERTIFICATE PTB 02 ATEX 2107

Types 27* ...
Thermocouple measuring circuit: type of protection intrinsic Safety EEx ia IIC (terminals 1, 2)

Maximum values:
U₀ = 6 V
I₀ = 2.3 mA
P₀ = 3.5 mW
R₀ = 2600 Ω
linear characteristic
L₀ = 3 nH
C₀ = 2300 nF
L: negligibly low
C: 1100 nF

resp.

for connection to a certified intrinsically safe circuit

Maximum values:
U₀ = 12 V
I₀ = 100 mA
P₀ = 250 mW
L: negligibly low
C: 1100 nF

PI 100-measuring circuit: type of protection intrinsic Safety EEx ia IIC (terminals 3, 4)

Maximum values:
U₀ = 6 V
I₀ = 5.5 mA
P₀ = 5.5 mW
R₀ = 1000 Ω
linear characteristic
L₀ = 3 nH
C₀ = 2300 nF
L: negligibly low
C: 1100 nF

The thermocouple measuring circuit and the PI 100-measuring circuit are electrically interconnected and safely electrically isolated from the auxiliary power circuit and the output circuit up to a peak value of the nominal voltage of 275 V.

sheet 2/4

EC-type-examination Certificate without signature and official stamp shall not be valid. The certificate may be consulted only without alteration. Extracts or abridgements are subject to approval by the Physikalisch-Technische Bundesanstalt. In case of dispute, the German text shall prevail.
Physikalisch-Technische Bundesanstalt • Bundesallee 100 • D-38116 Braunschweig

Physikalisch-Technische Bundesanstalt
Braunschweig und Berlin

PTB

SCHEDULE TO EC-TYPE-EXAMINATION CERTIFICATE PTB 02 ATEX 2107

(16) **Test report** PTB Ex 02-22171

(17) **Special conditions for safe use**
none

(18) **Essential health and safety requirements met by the standards quoted**

Zertifizierungs- und Examinationsstelle
By order:
Dr.-Ing. U. Johannsmann
Regierungsdirektor

Braunschweig, August 27, 2002

sheet 3/4

EC-type-examination Certificate without signature and official stamp shall not be valid. The certificate may be consulted only without alteration. Extracts or abridgements are subject to approval by the Physikalisch-Technische Bundesanstalt. In case of dispute, the German text shall prevail.
Physikalisch-Technische Bundesanstalt • Bundesallee 100 • D-38116 Braunschweig



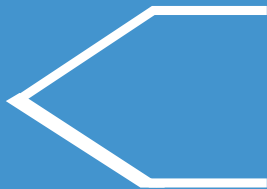

ThermoTrans® 210/211

The practical solution for temperature measurement with thermocouples.

The ThermoTrans® 210/211 temperature transmitters provide you with the flexibility you need:

- Adjustment work where it is only really necessary, instead of complicated parameter tables.

- High level of reliability and compact design due to digital signal processing specially developed for the measuring task instead of unnecessary reduction in reliability due to overburdening with complicated technology.

For the majority of the standard applications with fixed preset parameters, you simply select one of the numerous fixed range standard models.

You can solve special measuring tasks with a transmitter that we configure according to your specifications.

Configuration or adaptation to the measuring task is also not a problem "on site" via the optical interface. The user friendly, menu-guided Paraly® communication software is supplied together with a fiber-optic cable incl. PC adapter.

The ThermoTrans® 210/211 temperature transmitters provide safe isolation and high insulation resistance between the input, output and power supply. They meet the strict NAMUR EMC-requirements and can easily be used for measurements in hazardous areas.

Vacuum encapsulation protects the devices against aggressive environmental influences, shock and vibrations.



Warranty
5 years!

Defects occurring within 5 years from delivery are remedied free of charge at our plant (carriage and insurance paid by sender).

ThermoTrans® 210/211 for thermocouples

Thermocouples are very low-resistance and thus noise-free. Their preferred field of application is high temperature ranges, for example, for measurements in ovens, smelting plants and plastic machines.

The range of standard thermocouples is very wide. The ThermoTrans® 210/211 transmitters therefore provide consistent connection possibilities for all regular thermocouples.

To avoid long extension wires, an external reference junction can also be used in addition to the internal one. For thermostatic reference junctions, the reference temperature can be fixed or measured with a Pt 100.

The ThermoTrans® 210/211 transmitters can also be used to measure voltages in the range $-20 \dots +100$ mV with a transfer rate of 1/s. Due to the transfer curve freely configured with various functions or interpolation points, they are intended for difficult measuring tasks, for example, the level in spherical tanks.

The facts

- **Explosion protection [EEx ia] IIC**
according to ATEX, trouble-free use in hazardous areas
- **Extensive range of standard models**
for standard applications, configuration not necessary
- **Adjustable via optical interface**
universal for a wide range of measuring tasks, can also be configured on site
- **Paraly® PC configuration software with tag database**
simple, menu-guided configuration in accordance with VDI/VDE 2187, archiving of configuration data
- **EMC-tested according to European EMC regulations and NAMUR NE 21**
reliable operation even with electromagnetic interference in the mains or in the environment
- **Safe isolation in accordance with EN 61140**
protection of the maintenance staff and the subsequent devices against non-permitted high voltages
- **22.5 mm wide modular case with 73.5 mm standard height**
compact design means easy installation, also easy to fit in standard cabinets
- **5-year warranty**



- ▲ You can use the menu-guided Paraly® communication software (according to / VDE 2187) to configure the transmitters. The data from different measuring points can be easily archived and managed in the corresponding tag database.

Product line

		ThermoTrans® 210 with current output	ThermoTrans® 211 with voltage output
Adjustable models	Order no.	210 A7 000 000 Opt. 444	211 A7 000 000 Opt. 444
Adjustable via interface. See Configuration Schedule for factory setting.			
Fixed range standard models	Order no.	210 A7 x xx xx x Opt. 444	211 A7 x xx xx V Opt. 444
Sensors	J K S	J K S	J K S
Span	700 K 1000 K 1700 K	60 75 97	60 75 97
Start of scale	0 °C	00	00
Output	0 ... 20 mA 4 ... 20 mA 0 ... 10 V	D L	V

Output curve rising, without filter constant, internal reference junction
 ThermoTrans® 210: open circuit recognition 22 mA. ThermoTrans® 211: open circuit recognition 11 V

Power supply

230 V AC	
24 V AC/DC	336
115 V AC	363

Accessories

Communications kit	For configuration of the temperature transmitter, with tag database according to VDI/VDE 2187, consisting of: – Optical fibre connecting cable 3 m – Optical interface adapter – RS 232 – Adapter D-Sub 9-pole – D-Sub 25-pole – Paraly® configuration software and tag database	ZU 0254
--------------------	--	---------

Product line

		ThermoTrans® 210 with current output	ThermoTrans® 211 with voltage output
Customer-specific models	Order no.	210 A7 999 999 Opt. 444	211 A7 999 999 Opt. 444

Configuration schedule

Important! Please fill in the configuration schedule completely and enclose it with your order. If entries are missing, the value entered in square brackets or the dark-colored setting will be set.

ThermoTrans® 210/211

Sensors	Thermocouples: <input type="checkbox"/> Model B <input type="checkbox"/> Model E <input type="checkbox"/> Model J <input checked="" type="checkbox"/> Model K <input type="checkbox"/> Model L <input type="checkbox"/> Model N <input type="checkbox"/> Model R <input type="checkbox"/> Model S <input type="checkbox"/> Model T <input type="checkbox"/> Model U <input type="checkbox"/> Voltage	
Range	Start of scale ¹⁾ ___ ___ °C [0 °C] or ___ ___ mV Span ¹⁾ ___ ___ K [1000 K] or ___ ___ mV	
Reference junction	<input checked="" type="checkbox"/> Internal <input type="checkbox"/> External Pt 100 <input type="checkbox"/> Internal/external switching (via jumper) <input type="checkbox"/> Fixed range temperature ²⁾ ___ . ___ °C [25 °C]	
Output ³⁾	<input checked="" type="checkbox"/> 0 ... 20 mA <input type="checkbox"/> 4 ... 20 mA <input type="checkbox"/> 0 ... 10 V	
Curve	<input checked="" type="checkbox"/> Rising <input type="checkbox"/> Falling	
Error messages	Message: <input checked="" type="checkbox"/> only with open circuit <input type="checkbox"/> with open circuit and overrange	
	Signal: <input checked="" type="checkbox"/> 22 mA or 11 V <input type="checkbox"/> -1 mA or -0.5 V	
Filter constant T ₉₉	___ ___ s ¹⁾ (1st order filter)	[0 s]
Tag number	_____	[None]

1) See specifications for possible parameter range

2) Compensation range -10 ... 80 °C

3) Other values on request

Specifications

Input data	Sensor type	Range
Intrinsically safe	Type B DIN/IEC 584-1 Type E DIN/IEC 584-1 Type J DIN/IEC 584-1 Type K DIN/IEC 584-1 Type L DIN 43710 Type N ASTM E 230-87 Type R DIN/IEC 584-1 Type S DIN/IEC 584-1 Type T DIN/IEC 584-1 Type U DIN 43710	0 ... +1820 °C -270 ... +1000 °C -210 ... +1200 °C -270 ... +1372 °C -200 ... +900 °C -270 ... +1300 °C -50 ... +1767 °C -50 ... +1767 °C -270 ... +400 °C -200 ... +600 °C
Voltage input	-20 ... +100 mV	
Input resistance	> 10 MOhms	
Span (configurable)	≤2 mV, max. measuring end – measuring start	
Sensor failure monitoring	All inputs for open circuit (not for voltage measurement)	
Input error limits	± 10 μV + 0.05 % of meas. val.	
Temperature coefficient at input	0.01 %/K full scale (average TC in permitted operating temperature range, reference temperature 23 °C)	
Reference junction input (user-defined)	Internal Pt 100 < ±1.0 K External Pt 100 < ±0.3 K + error of Pt 100 used	
Output data		
Output signal (0 ... 100 %)	Model 210: 0/4 ... 20 mA, impressed current, load voltage ≤10 V Model 211: 0 ... 10 V, impressed voltage, load current ≤10 mA	
Resolution	Approx. 8000 steps (for 0 ... 100 %)	
Control range	-2.5 % ... 102.5 % of span	
Overload range with error message	Model 210: -1.0 mA or 22 mA Model 211: -0.5 V or 11 V	
Output error limits	0.1 % full scale	
Temperature coefficient at output	0.01 %/K full scale (average TC in permitted operating temperature range, reference temperature 23 °C)	
Residual ripple at output	< 10 mV _{pp} + digitalization error of input	

Specifications, continued

Transmission behavior

Characteristic	Temperature, voltage-linear or customer-specific rising or falling
Meas. rate	Approx. 1/s
Response time T_{99}	≤ 900 ms
Digital output filter	$T_{99} = 0 \dots 100$ s (1st order filter)

Power supply

Power supply	230 V AC $-15\% +10\%$, 48 ... 62 Hz, approx. 2 VA
Option 336:	24 V AC/DC AC: $-15\% +10\%$, 48 ... 500 Hz, approx. 1.5 VA DC: $-15\% +20\%$, approx. 1.2 W
Option 363:	115 V AC $-15\% +10\%$, 48 ... 62 Hz, approx. 2 VA

Isolation

Galvanic isolation	3-port isolation between input, output and power supply
Test voltage	4 kV AC (input against output and power supply) 3 kV AC (output against power supply)
Working voltage (basic isolation)	1000 V AC/DC input against output and power supply with overvoltage category II and pollution degree 2, 330 V AC/DC output against power supply with overvoltage category II and pollution degree 1, according to EN 61010-1 For applications with high working voltages, you should ensure there is sufficient spacing or isolation from neighboring devices and protection against electrical shocks. When used in hazardous areas, the max. working voltage is 250 V.
Protection against electrical shock	Safe isolation according to EN 61140 by reinforced insulation according to EN 61010-1. Working voltages with overvoltage category II and pollution degree 2: 600 V AC/DC for input against output and power supply with overvoltage category II and pollution degree 2: 300 V AC/DC for output against power supply. For applications with high working voltages, you should ensure there is sufficient spacing or isolation from neighboring devices and protection against electrical shocks. When used in hazardous areas, the max. working voltage is 250 V.

Standards and approvals

Explosion protection (Opt. 444)	II (1) G [EEx ia] II C PTB 02 ATEX 2107 For further details see certificates of conformity page 174
Surge withstand	5 kV 1.2/50 μ s according to IEC 255-4
EMC ¹⁾	EMC directive 89/336/EEC, EN 61326; NAMUR recommendation NE 21

¹⁾ Slight deviations are possible while there is interference from RF radiation

Specifications, continued

Other data

Interface (only user-definable models)	Optical, interface adapter on RS 232 interface (PC) is included in the ZU 0254 communications kit
Ambient temperature	Operation: -10 ... +60 °C Transport and storage: -30 ... +80 °C
Enclosure	Modular case A7, width 22.5 mm, screw terminals See dimension drawings for further measurements
Protection class	Case IP 40, terminals IP 20
Mounting	With snap-on mounting for 35 mm top hat rail according to EN 50022-35, width 22.5 mm, See dimension drawings for conductor cross section
Weight	Approx. 300 g

Schematic diagram

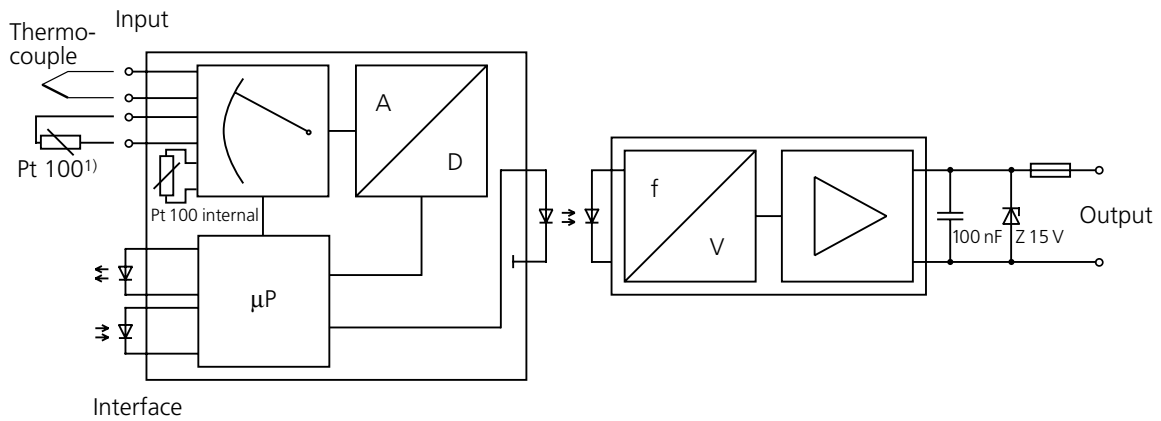

¹) For temperature measurement of external reference junctions

Application examples

With external reference junction

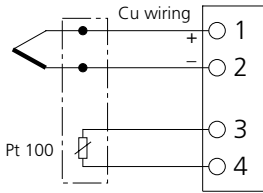

Summing connection with external reference junction

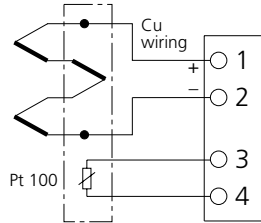

Differential connection

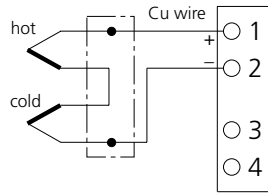

Internal/external reference junction selectable

Pt 100 external

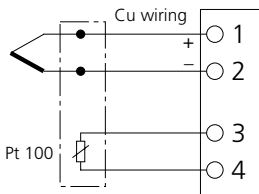

Pt 100 internal

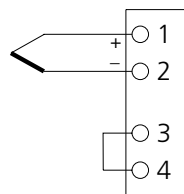

Dimension drawings and terminal assignments

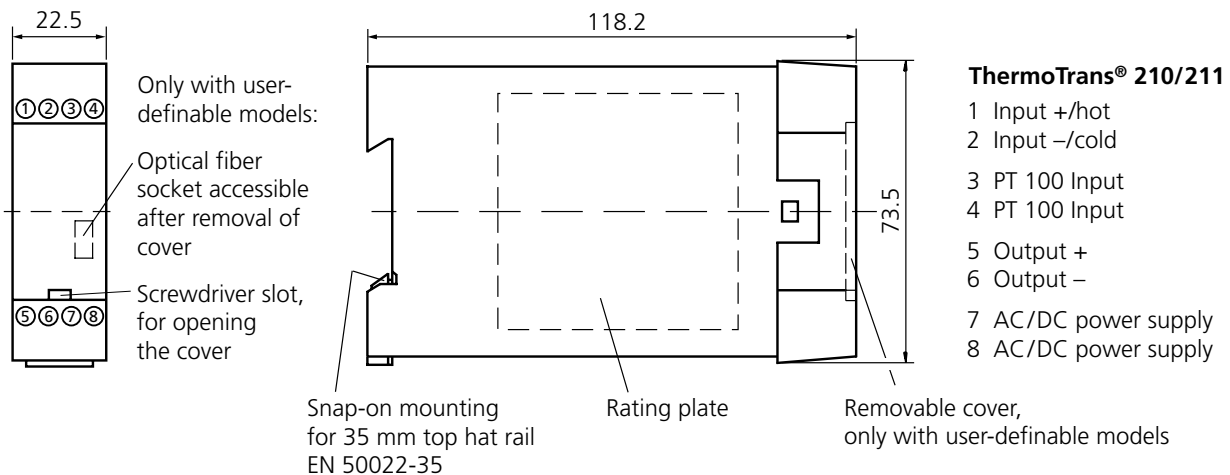

All dimensions in mm.

Captive M3x8 clamp screws, box terminals with self-releasing wire protection, max. conductor cross section

- 1 x 4 mm² solid
- 1 x 2.5 mm² stranded wire with ferrule
- 2 x 1.5 mm² stranded wire with ferrule

Certificates of Conformity

print preview

Physikalisch-Technische Bundesanstalt **PTB**
Braunschweig und Berlin

EC-TYPE-EXAMINATION CERTIFICATE
(Translation)

(2) Equipment and Protective Systems Intended for Use in Potentially Explosive Atmospheres - Directive 94/9/EC

(3) EC-type examination Certificate Number:
PTB 02 ATEX 2107

(4) Equipment: Temperature Transmitter ThermoTrans Model 27 AT Opt. ...

(5) Manufacturer: Knick Elektronische Messgeräte GmbH & Co.

(6) Address: Beckswald 22, 14163 Berlin, Germany

(7) This equipment and any acceptable variation thereto are specified in the schedule to this certificate and the documents therein referred to.

(8) The Physikalisch-Technische Bundesanstalt, notified body No. 2102 in accordance with Article 9 of the Council Directive 94/9/EC of 23 March 1994, certifies that this equipment has been found to comply with the Essential Health and Safety Requirements relating to the design and construction of equipment and protective systems intended for use in potentially explosive atmospheres, given in Annex II to the Directive.

The examination and test results are reported in the confidential report PTB Ex 02-22171.

(9) Compliance with the Essential Health and Safety Requirements has been assessed by compliance with **EN 50514:1997 + A1 + A2** **EN 50520:1994**

(10) If the sign "C" is placed after the certificate number, it indicates that the equipment is subject to special conditions for safe use specified in the schedule to this certificate.

(11) This EC-type-examination Certificate relates only to the design, examination and tests of the specified equipment in accordance to the Directive 94/9/EC. Further requirements of the Directive apply to the manufacturing process and supply of this equipment. These are not covered by the certificate.

(12) The marking of the equipment shall include the following:

Ex **II** **1** **G** **ExEx ia** **IC**

Zertifizierungsstelle Explosionsrecht
By order:
Dr.-Ing. U. Johannsmeyer
Regierungsdirektor

Braunschweig, August 27, 2002

sheet 1/4

EC-type-examination Certificate without signature and official stamp shall not be valid. The certificate may be checked only without alteration. Errors or alterations are subject to approval by the Physikalisch-Technische Bundesanstalt. In case of dispute, the German text shall prevail.
Physikalisch-Technische Bundesanstalt - Bundesallee 110 - D-38110 Braunschweig

Physikalisch-Technische Bundesanstalt **PTB**
Braunschweig und Berlin

SCHEDULE

(13) **EC-TYPE-EXAMINATION CERTIFICATE PTB 02 ATEX 2107**

(13) **Description of equipment**
The temperature transmitter ThermoTrans Model 27 AT Opt. ... with its different variants is used for the detection of resistance-proportional measuring signals and of thermo-electromotive forces and their conversion to injected current and voltage signals into the output circuit. The apparatus is installed outside hazardous areas. The permissible range of the ambient temperature is -10 °C ... 80 °C.

Electrical data

Auxiliary power circuit: 230 V AC -15 % +10 %, approx. 2 VA (terminals 1, 6)
115 V AC -15 % +10 %, approx. 2 VA
24 V AC -15 % +10 %, approx. 1.5 VA
24 V DC -15 % +20 %, approx. 1.2 VA

Output circuit: I = 0 ... 20 mA (terminals 5, 6)
U = 10 V
U₀ = 253 V

Types 2P ...

Resistance measuring circuit: type of protection Intrinsic Safety EEx ia IC (terminals 1, 2, 3, 4)

Maximum values:
U₀ = 6 V
I₀ = 13 mA
P₀ = 20 mW
R₀ = 480 Ω

Linear characteristic:
L₀ = 3 mΩ
C₀ = 2300 nF
L: negligibly low
C: negligibly low

The resistance measuring circuit is safely electrically isolated from the auxiliary power circuit and from the output circuit up to a peak value of the nominal voltage of 275 V.

sheet 2/4

EC-type-examination Certificate without signature and official stamp shall not be valid. The certificate may be checked only without alteration. Errors or alterations are subject to approval by the Physikalisch-Technische Bundesanstalt. In case of dispute, the German text shall prevail.
Physikalisch-Technische Bundesanstalt - Bundesallee 110 - D-38110 Braunschweig

Physikalisch-Technische Bundesanstalt **PTB**
Braunschweig und Berlin

SCHEDULE TO EC-TYPE-EXAMINATION CERTIFICATE PTB 02 ATEX 2107

Types 2P ...

Thermocouple measuring circuit: type of protection Intrinsic Safety EEx ia IC (terminals 1, 2)

Maximum values:
U₀ = 6 V
I₀ = 2.3 mA
P₀ = 3.5 mW
R₀ = 2000 Ω

Linear characteristic:
L₀ = 3 mΩ
C₀ = 2300 nF
L: negligibly low
C: = 1100 nF

resp.

for connection to a certified intrinsically safe circuit

Maximum values:
U₀ = 12 V
I₀ = 100 mA
P₀ = 250 mW
L: negligibly low
C: = 1100 nF

Pn 100-measuring circuit: type of protection Intrinsic Safety EEx ia IC (terminals 3, 4)

Maximum values:
U₀ = 6 V
I₀ = 5.5 mA
P₀ = 8.5 mW
R₀ = 1000 Ω

Linear characteristic:
L₀ = 3 mΩ
C₀ = 2300 nF
L: negligibly low
C: = 1100 nF

The thermocouple measuring circuit and the Pn 100-measuring circuit are electrically interconnected and safely electrically isolated from the auxiliary power circuit and the output circuit up to a peak value of the nominal voltage of 275 V.

sheet 3/4

EC-type-examination Certificate without signature and official stamp shall not be valid. The certificate may be checked only without alteration. Errors or alterations are subject to approval by the Physikalisch-Technische Bundesanstalt. In case of dispute, the German text shall prevail.
Physikalisch-Technische Bundesanstalt - Bundesallee 110 - D-38110 Braunschweig

Physikalisch-Technische Bundesanstalt **PTB**
Braunschweig und Berlin

SCHEDULE TO EC-TYPE-EXAMINATION CERTIFICATE PTB 02 ATEX 2107

(16) **Test report PTB Ex 02-22171**

(17) **Special conditions for safe use**
none

(18) **Essential health and safety requirements met by the standards quoted**

Zertifizierungsstelle Explosionsrecht
By order:
Dr.-Ing. U. Johannsmeyer
Regierungsdirektor

Braunschweig, August 27, 2002

sheet 4/4

EC-type-examination Certificate without signature and official stamp shall not be valid. The certificate may be checked only without alteration. Errors or alterations are subject to approval by the Physikalisch-Technische Bundesanstalt. In case of dispute, the German text shall prevail.
Physikalisch-Technische Bundesanstalt - Bundesallee 110 - D-38110 Braunschweig

Eurocards



IsoAmp® 11000/12000

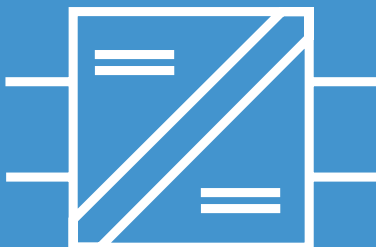

Universal isolation amplifiers

Knick's IsoAmp® 11000/12000 series features a tried and tested range of powerful DC isolators that have excellent specifications despite small dimensions and have a symmetrical input with high common mode rejection.

When conventional unsymmetrical isolation amplifiers are used, signal interferences can occur that seem inexplicable to the user at first. If, for example, there are several subsequent devices in a current output loop, an isolation amplifier can meet a LO output with its HI input which can cause the above-mentioned signal interferences.

On the Knick IsoAmp® 11000/12000 DC isolation amplifiers, the input is symmetrical, i. e. both input terminals can be exchanged without undesired effects on the common mode rejection.

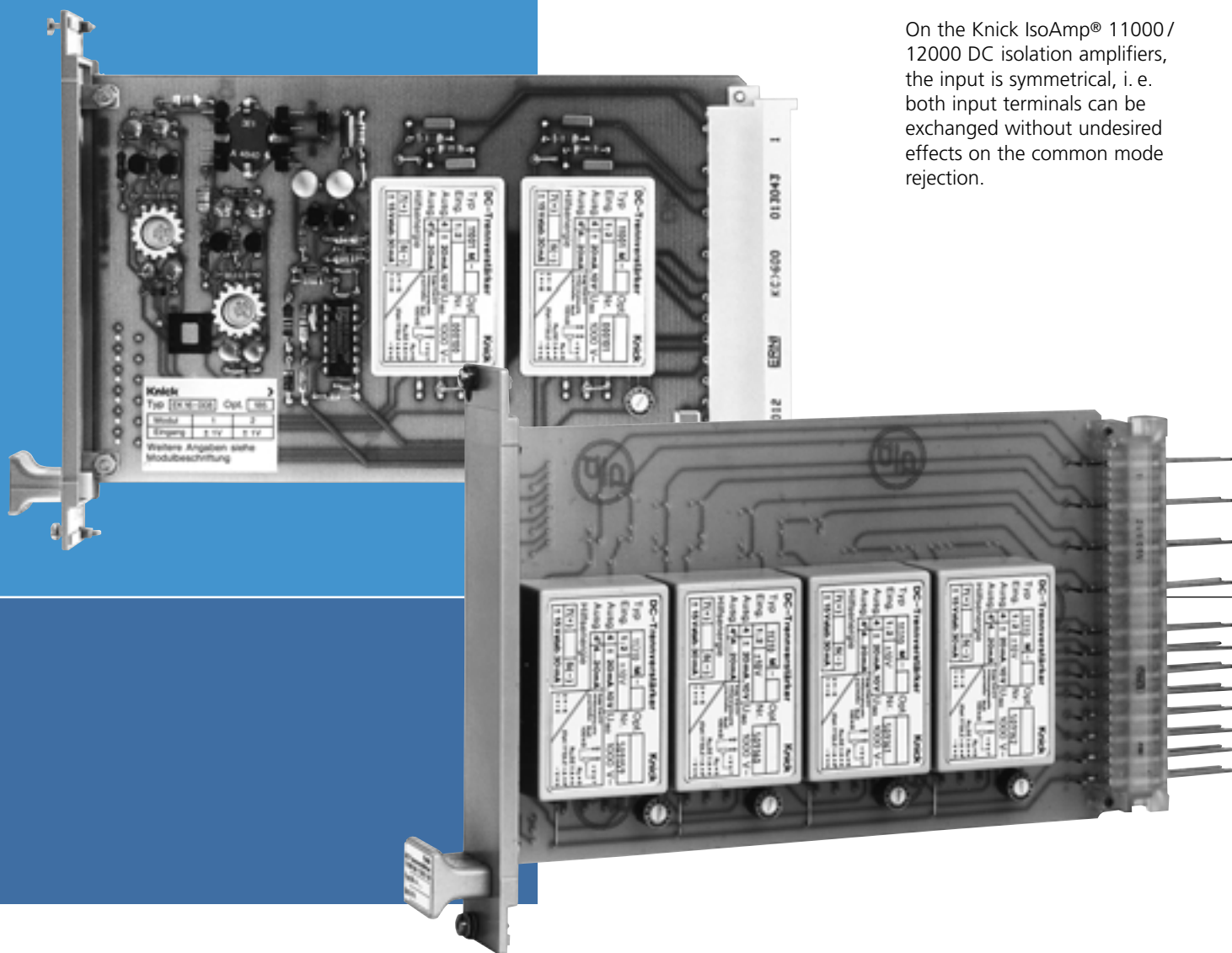

Models with connections for external gain adjustment, zeroing and live-zero switching (0 ... 20 mA/4 ... 20 mA) are available for special tasks.

The isolation amplifiers are easy to use and can be used anywhere where small dimensions are needed together with high isolation voltage, highly accurate measuring and maximum reliability.

Warranty
5 years!

Defects occurring within 5 years from delivery are remedied free of charge at our plant (carriage and insurance paid by sender).

The facts

- **Symmetrical input with high common mode rejection**
- **Excellent specifications**
- **High isolation voltage**
- **High output power**
- **Optional external gain adjustment with just one resistor**
- **Live-zero switching**
- **Complete modules without external connection**
- **Eurocard up to 4 channels**
- **Eurocard up to 2 channels, floating outputs**
- **High quality and reliability**
- **100 % computer-supported production monitoring and final check**
- **5-year warranty**

Product line

Eurocards

	Order no.
For up to 4 channels	EK 14–... ¹⁾
With isolation transformer for isolated supply, for up to 2 channels	EK 16–... ¹⁾

1) Please indicate the required channel configuration when ordering. Any channel combination possible.

Channels for Eurocards

	Input symmetric	Output impressed	Load capability	Order no.
Free wiring	Up to ± 500 mV depending on wiring	± 20 mA	10 V ²⁾	11001 M
	Up to ± 500 mV depending on wiring	± 10 V ²⁾	20 mA	12001 m
Fixed setting	± 20 mV	± 20 mA	10 V ¹⁾	11202 M
	± 60 mV	± 20 mA	10 V ¹⁾	11206 M
	± 150 mV	± 20 mA	10 V ¹⁾	11215 M
	± 500 mV	± 20 mA	10 V ¹⁾	11250 M
	± 10 V	± 20 mA	10 V ¹⁾	11310 M
	± 20 mA	± 20 mA	10 V ¹⁾	11820 M
	± 20 mV	± 10 V	20 mA	12202 M
	± 60 mV	± 10 V	20 mA	12206 M
	± 150 mV	± 10 V	20 mA	12215 M
	± 500 mV	± 10 V	20 mA	12250 M
	± 10 V	± 10 V	20 mA	12310 M
	± 20 mA	± 10 V	20 mA	12820 M

2) EK 14: ± 10 V or 20 V unipolar (note power supply)

Options

	Order no.	
Eurocard	INTERMAS front panel for EK 14 or EK 16 Eurocard, mounted	174
	Eurocard EK 14 or EK 16 m. Wiring to customer requirements in range $V_I \geq 20$ mV ... ≤ 200 V or $I_I \geq 100$ μ A ... ≤ 50 mA	185 ³⁾
Channels for Eurocard	Output ± 0 ... 20 mA and +4 ... 20 mA Switchable (additional error at live-zero: ± 10 μ A)	173
	Gain error <0.1 % of measured value (not Model 11202)	04 ³⁾

3) Options 04 and 185 cannot be combined

Specifications

Input data

Input	see Product line
Configuration	EK 14 max. 4 channels also in combined version EK 16 max. 2 channels also in combined version (EK 16 with isolation transformer for isolated supply)
Input resistance	> 1 MOhm, for models with $I_i \pm 20$ mA: 7.5 Ohm
Overload	$V_i \leq 25$ V, $I_i \leq 300$ mA

Output data

Output	see Product line
Offset current ²⁾	< 50 nA
Offset voltage ²⁾ Drift	< 500 nA, external zeroing < 5 μ V/month
Residual ripple	≤ 10 mV _{pp}

Transmission behavior

Gain error	< 0.2 % meas. val., Opt. 04: < 0.1 % meas.val.
Cut-off frequency ¹⁾	> 1.5 ... 5 kHz –3 dB (20 mV ... 500 mV or 10 V) (different values on request)
Temperature coefficient ^{2) 3)}	< 1 nA/K, < 2 μ V/K (reference temperature 23 °C)

Power supply

EK 14	± 14.5 ... 15.5 V stabilized, approx. 30 mA for unipolar operation up to 20 V output voltage: –5, +25 V stabilized
EK 16 with isolation transformer for isolated supply	24 V DC ± 10 %, approx. 80 mA 30 V ⁴⁾ – ± 10 %, approx. 60 mA selectable

1) Current output up to 250 Ohm load, models 11310 and 12310 up to 10 V_{pp}

2) x 10 for models 11310, 12310

3) Offset set to zero

4) For operation with ± 15 V without 0 V line

Specifications, continued

Isolation

Galvanic isolation

3-port isolation between input, output and power supply

Test voltage between input and output/power supply:

4 kV AC

Working voltage (basic isolation)

EK 14: 600 V AC/DC**EK 16:** 900 V DC each input against all other inputs and outputs
250 V DC power supply against all other circuits with overvoltage category II and pollution degree 2 according to EN 61010-1

For applications with high working voltages, you should ensure there is sufficient spacing or isolation from neighboring devices and protection against electrical shocks.

Standards and approvals

EMC

EMC directive 89/336/EEC

Other data

Ambient temperature

-10 ... +70 °C

Version

Eurocard 5 TE

Pin connector

Type F according to DIN 41612,
see also dimension drawingsSocket connector⁵⁾Type F according to DIN 41612 (wire-wrap connection),
see also dimension drawings

Front panel

Opt. 174: INTERMAS SP/K 3-n 05 T plastic, gray,
see also dimension drawings

Weight

Approx. 45 g per channel

5) The socket connector belongs to package contents

Dimension drawing and pin assignment

EK 14, configuration with 11000 M

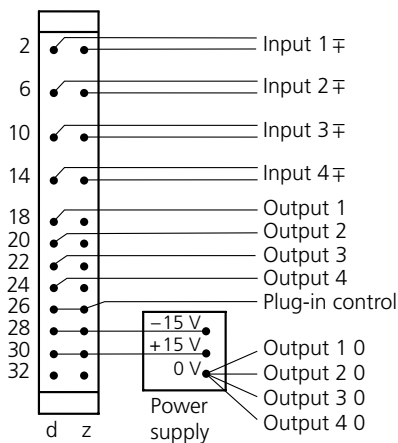
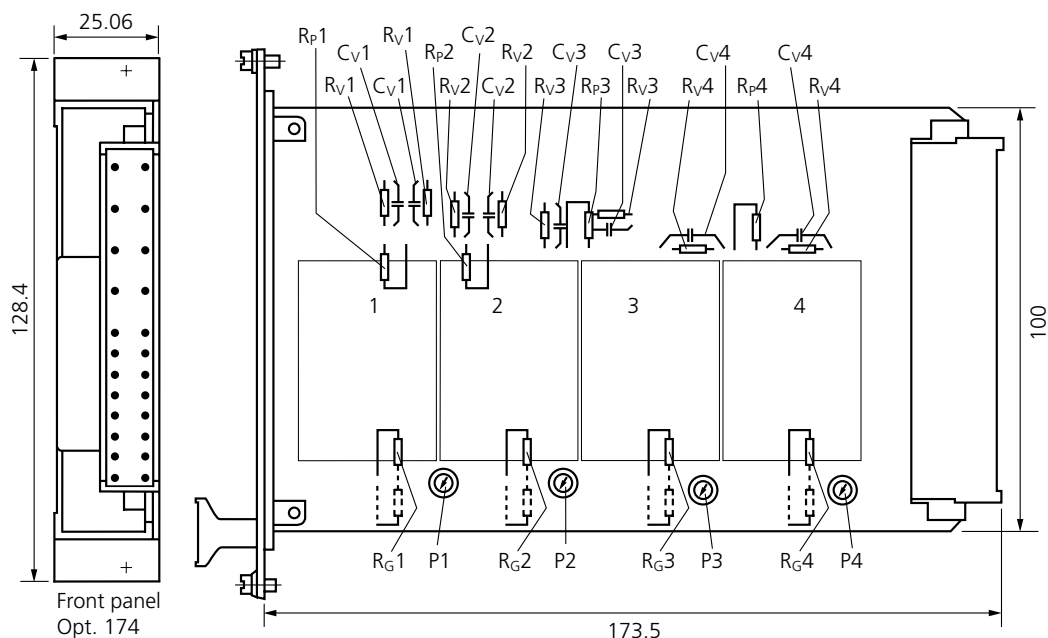

When using fixed-range models, no wiring is necessary!

When used with R_V , C_V separate strip conductors.

R_G : Negative feedback resistor

R_P : Shunt resistor

R_V : Sym. voltage divider (R_V , R_P , R_V)

C_V : Frequency compensation

P1 ... P4 = Nulling potentiometers

$$\text{Model 11001: } R_G = \frac{V_I}{20} [\Omega, \text{mV}] \quad (1 \dots 25 \Omega)$$

Output with Option 173

	$\pm 0 \dots 20 \text{ mA}$	$+4 \dots 20 \text{ mA}$
Output 1	d 18	z 18
Output 2	d 20	z 20
Output 3	d 22	z 22
Output 4	d 24	z 24

All dimensions in mm.

Dimension drawing and pin assignment

EK 14, configuration with 12000 M

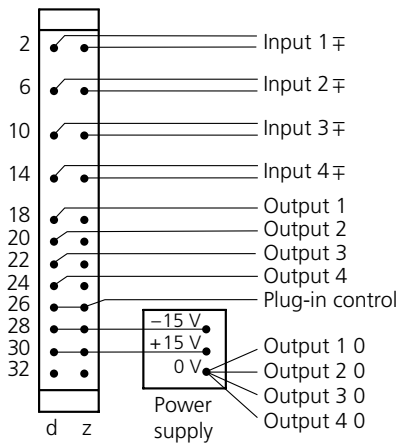
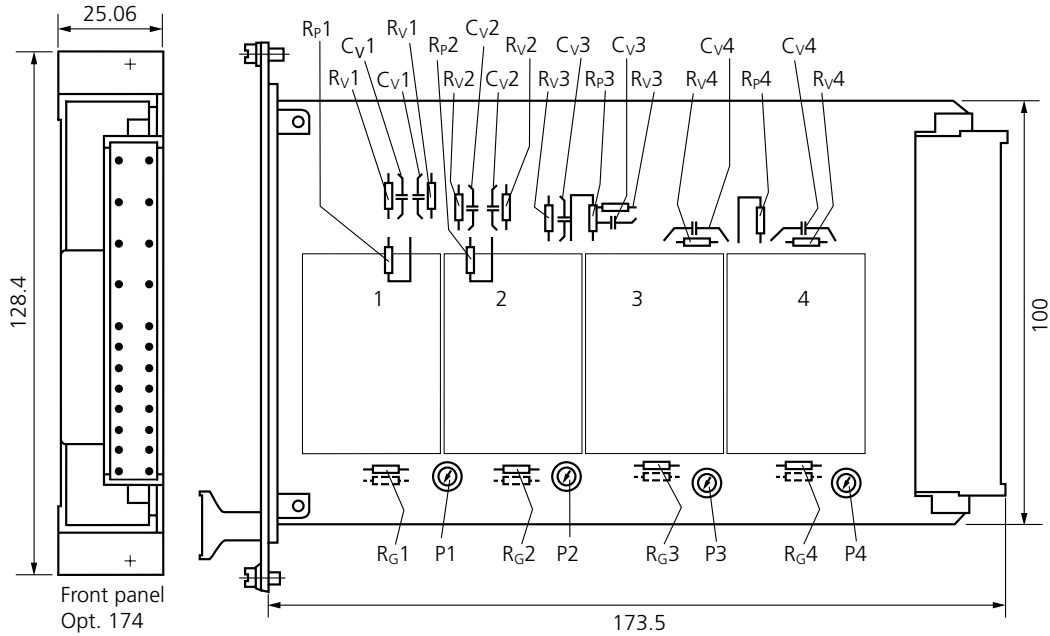

When using fixed-range models, no wiring is necessary!

When R_v , C_v are mounted, separate the strip conductors.

R_G : Negative feedback resistor

R_P : Shunt resistor

R_v : Sym. voltage divider (R_v , R_P , R_v)

C_v : Frequency compensation

P1 ... P4 = Nulling potentiometers

$$\text{Model 12001: } R_G = \frac{20500 V_I}{10000 - V_I} [\Omega, \text{mV}] (41.1 \dots 1079 \Omega)$$

All dimensions in mm.

Dimension drawing and pin assignment

EK 16, configuration with 11000 M / 12000 M

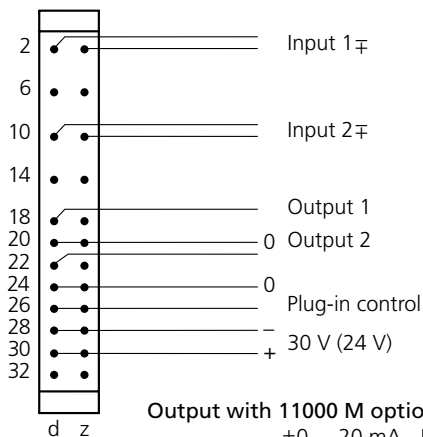
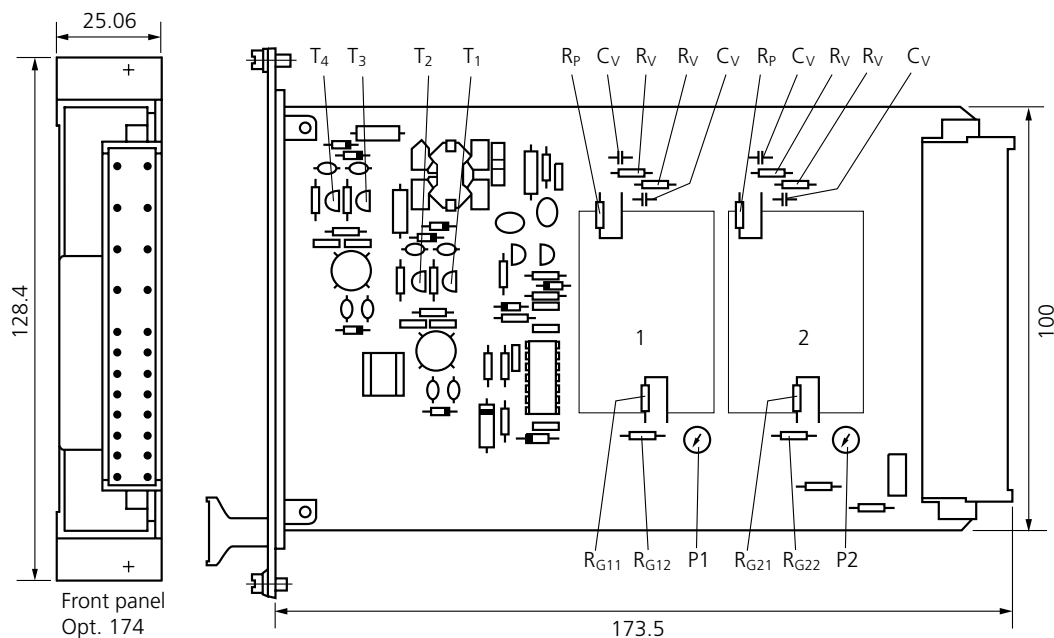

Output with 11000 M option 173

	±0 ... 20 mA	+4 ... 20 mA
Output 1	d 18/dz 20	d 18/dz 20
Output 2	d 22/dz 24	d 22/dz 24

When using fixed-range models, no wiring is necessary!

R_{G11}, R_{G21}: Negative feedback resistor 11000 M

R_{G12}, R_{G22}: Negative feedback resistor 12000 M

R_P: Shunt resistor

R_V: Sym. voltage divider (R_V, R_P, R_V)

C_V: Frequency compensation

P1, P2 = Nulling potentiometer

Separate the strip conductors when R_V, P1, P2 are mounted!

12000 M: Base emitters of T₁, T₂ or T₃, T₄ must be jumpered.

All dimensions in mm.

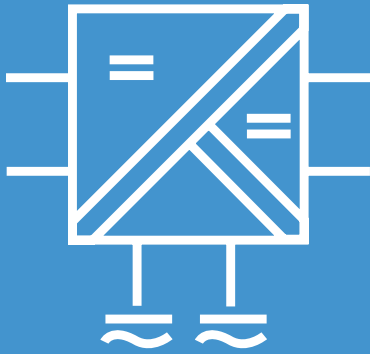

IsoAmp® 3000/4000

For transmission and conversion of impressed measuring signals

The DC isolation amplifiers from the IsoAmp® 3000/4000 series transmit and convert impressed 0(4) ... 20 mA or 0 ... 10 V standard signals according to our DBP 34 12 843 patent with maximum accuracy.

They provide safe isolation and high insulation from input to output to power supply.

The control range extends into the negative values and allows strict linear transmission in the zero range. Compared with conventional unipolar amplifiers, this has a great advantage: The often asymptotic setting of the zero point, for example, when calibrating together with a sensor, is ruled out.

The transmission accuracy is unusually high. The reason for this is mainly a negative feedback circuit that is incorporated in the electrical isolation. It has no measuring resistor with 1:1 transmission and just one measuring resistor for current/voltage conversion. Differentiated signal return allows the circuit to remain stable even with strong complex loads.

The components required in conventional concepts for matching amplifiers and resistor networks are omitted. The reliability is accordingly high.

The computer-controlled production monitoring and final check ensure high and constant quality. The full encapsulation guarantees maximum safety and reliability even in extreme conditions.



Warranty
5 years!

Defects occurring within 5 years from delivery are remedied free of charge at our plant (carriage and insurance paid by sender).

The devices can be used for many galvanic isolation applications, for example:

- in measuring and control engineering
- for linking measured signals to different potentials
- for removal of double ground compensation currents
- for isolation of dangerous touch voltages
- for computer interfacing
- for increasing the load voltage and decoupled signal transmission

Each Eurocard can carry a maximum of 4 channels.

The 16 mm high channel design even allows just 4 TE rack width. Therefore 21 cards with 84 channels can be accommodated per 19" rack.

For safe isolation in accordance with EN 61140, the required clearance and creepage distance should be taken into consideration.

Model overview

IsoAmp® 3820
transforms the input current 1 : 1 into an impressed output current without negative feedback resistors by means of negative-feedback current transformation.

IsoAmp® 4820
converts the input current 2 : 1 into an impressed output voltage with just a precision resistor after current transformation.

IsoAmp® 3310
converts the input voltage 3 : 1 into an impressed output current with just a precision resistor after voltage transformation.

IsoAmp® 4310
converts the input voltage 1 : 1 into an impressed output voltage without negative-feedback resistors after voltage transformation.

The facts

- **Safe isolation in accordance with EN 61140**
protection of the maintenance staff and the subsequent devices against non-permitted high voltages
- **3-port isolation**
protection against incorrect measurements or damage to the measuring system due to parasitic voltages
- **Decoupled**
no load impedance effect on the signal source
- **Maximum reliability**
no maintenance work, therefore the related costs are not incurred
- **High accuracy**
no falsification of measured signal
- **Simple live zero/dead zero switching option**
multiple application possibilities due to optional switching of input or output
- **5-year warranty**

Product line

Eurocards

For up to 3 channels
For up to 4 channels

Order no.

EK 8–¹⁾²⁾
EK 9–¹⁾²⁾

1) Any module combination possible

2) 'Card disconnected' safety circuit on request

Channels for Eurocards

Input: 0 ... 20 mA, output: 0 ... 20 mA
Input: 0 ... 20 mA, output: 0 ... 10 V

3820 Mh
4820 Mh

Input: 0 ... 10 V, output: 0 ... 20 mA
Input: 0 ... 10 V, output: 0 ... 10 V

3310 Mg
4310 Mg

Power supply

24 V AC/DC

Options

Input 0 ... 20 mA or 4 ... 20 mA, switchable

250³⁾

Output 0 ... 20 mA or 4 ... 20 mA, switchable

251³⁾

INTERMAS front panel, width 25 mm, for EK 8 or EK 9 Eurocard, mounted

174

INTERMAS front panel, width 20 mm, for EK 8 or EK 9 Eurocard, mounted
when equipped with 3820 Mh and 4820 Mh, only

301

3) Options 250 and 251 cannot be combined; additional error at output: $\pm 10 \mu\text{A}$, with Model 4820: $\pm 10 \text{ mV}$

Accessories

Inspection Certificate 3.1 B according to EN 10204

ZU 0267

Inspection Certificate 3.1 B according to EN 10204, with description and results
from inspections

ZU 0202

Selection aid for modules and options

		Output		
		0 ... 20 mA	0...20 mA/4...20 mA ⁴⁾	0 ... 10 V
Input	0 ... 20 mA	3820 Mh	3820 Mh Opt. 251	4820 Mh
	0/4 ... 20 mA ⁴⁾	3820 Mh Opt. 250	3820 Mh ⁵⁾	4820 Mh Opt. 250
	0 ... 10 V	3310 Mg	3310 Mg Opt. 251	4310 Mg

4) Switchable

5) Transmission 1:1

Specifications

Input data	3820 Mh	4820 Mh	3310 Mg	4310 Mg
Input ⁶⁾	0 ... 20 mA impressed current Opt. 250: 0/4 ... 20 mA switchable ⁷⁾		0 ... 10 V	
Input voltage drop	Approx. 100 mV At open output: approx. 750 mV Upon power failure: approx. 750 mV	Approx. 150 mV Upon power failure: approx. 750 mV	–	
Input resistance	–		>5 MOhms	>2 MOhms
Offset current ⁸⁾	–		<500 nA ± 10 nA/K	<1 µA ± 10 nA/K
Overload	≤300 mA Limitation to 750 mV with diode		≤100 mA Limitation to 13 V with suppressor diode	
Output data	3820 Mh	4820 Mh	3310 Mg	4310 Mg
Output ⁶⁾	0 ... 20 mA, 14 V ⁹⁾ Opt. 251: 0/4 ... 20 mA Switchable ⁷⁾	0 ... 10 V, 10 mA	0 ... 20 mA, 10 V Opt. 251: 0/4 ... 20 mA Switchable ⁷⁾	0 ... 10 V, 20 mA
Residual ripple	<10 mV _{pp}			
Transmission errors	0.01 % meas. val.	0.1 % meas. val.	0.1 % meas. val.	0.02 % meas. val.
Offset	<2 µA	<2 mV	<5 µA	<2 mV
Cut-off frequency	5 kHz –3 dB	10 kHz –3 dB/ V _O ≤ 3 V _{pp} 3 kHz –3 dB/ V _O ≤ 10 V _{pp}	10 kHz –3 dB	10 kHz –3 dB/ V _O ≤ 3 V _{pp} 3 kHz –3 dB/ V _O ≤ 10 V _{pp}
Temperature coefficient ⁸⁾	<10 nA/K	<40 µV/K ±0.0025 %/ K meas. val.	<100 nA/K ±0.0025 %/ K meas. val.	<40 µV/K
Power supply				
Power supply	24 V AC/DC	AC: –15 % +10 %, 48 ... 500 Hz, approx. 1.3 VA DC: –15 % +20 %, approx. 0.6 VA		
Isolation				
Test voltage	4 kV AC (input/output/power supply)			
Galvanic isolation	3-port isolation between input, output and power supply			

6) Transmission of negative measuring signals up to approx. –3 % of the full scale

7) Options 250 and 251 cannot be combined

8) Reference temperature for TC specifications: 23 °C

9) Opt. 250 and 251: 12 V

Specifications, continued

IsolationWorking voltages
(basic isolation)

According to EN 61010-1

Type EK8**Overvoltage category /
perm. pollution degree****Permitted
working voltage**Each input against
all other circuitsII / degree 2
II / degree 31000 V DC
660 V DC / 630 V ACEach output against
all other circuitsI / degree 1
II / degree 21000 V DC
660 V AC/DCPower supply against
all other circuitsII / degree 1
III / degree 21000 V DC
600 V AC/DC**Type EK9****Overvoltage category /
perm. pollution degree****Permitted
working voltage**Each input against
all other circuitsII / degree 1
III / degree 21000 V DC
600 V AC/DCEach output against
all other circuitsI / degree 1
II / degree 11000 V DC
600 V AC/DCPower supply against
all other circuitsII / degree 1
II / degree 21000 V DC
600 V AC/DC

Permissible working voltages for other overvoltage categories and pollution degrees and for reinforced insulation / safe isolation on request.

For applications with high working voltages, you should ensure there is sufficient spacing or isolation from neighboring devices and protection against electrical shocks.

Protection against electrical
shock

Safe isolation according to EN 61140 by reinforced insulation in accordance with EN 61010-1.

For applications with high working voltages, you should ensure there is sufficient spacing or isolation from neighboring devices and protection against electrical shocks.

Standards and approvals

Surge withstand

5 kV, 1.2/50 μ s according to IEC 255-4

EMC

According to EMC directive 89/336/EEC¹⁰⁾**Other data**

Ambient temperature

Operation: -10 ... +70 °C
Transport and storage: -30 ... +80 °C

Version

Eurocard 5 TE (Opt. 174) / 4 TE (Opt. 301)

Pin connector

Type F according to DIN 41612, see also dimension drawings

Socket connector¹¹⁾

Type F according to DIN 41612 (wire-wrap connection), see also dimension drawings

Front panel

Opt. 174: INTERMAS, SP/K3-n05T plastic, gray, see also dimension drawings
Opt. 301: INTERMAS, SP/K3-n04T plastic, gray, see also dimension drawings

Weight

Approx. 60 g to 73 g per channel

Schematic diagrams

Model 3820

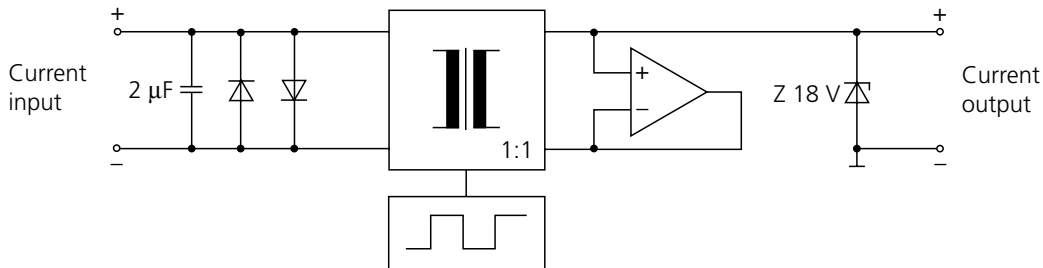

Model 4820

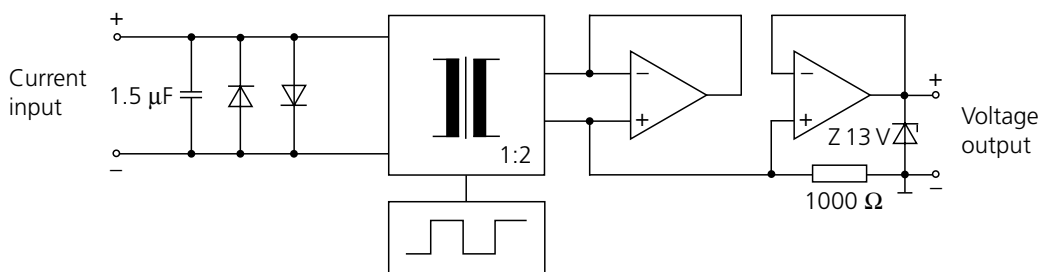

Model 3310

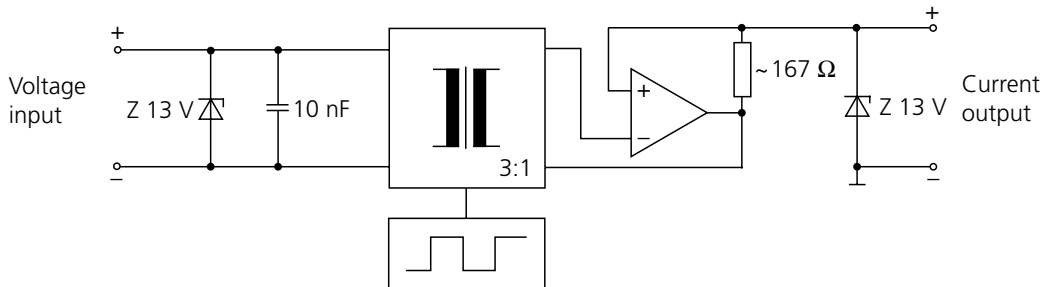

Model 4310

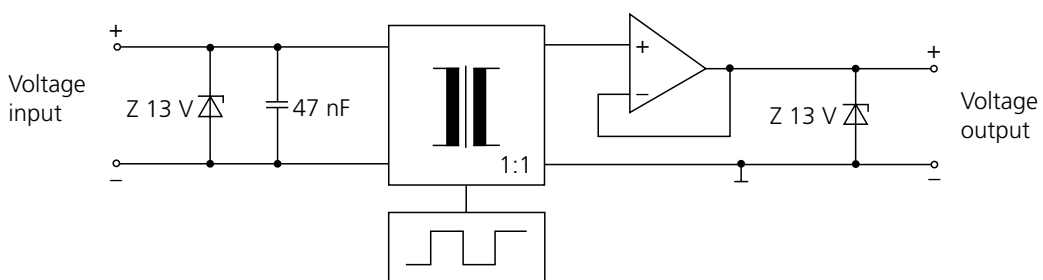

Dimension drawing and pin assignment

for EK 8 Eurocard

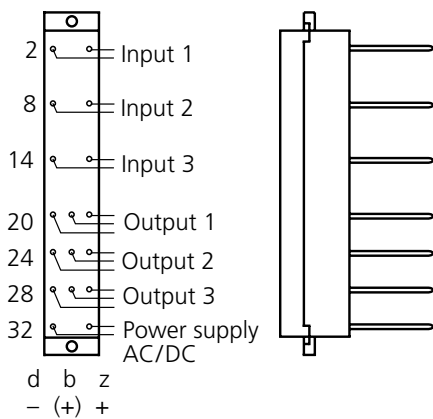
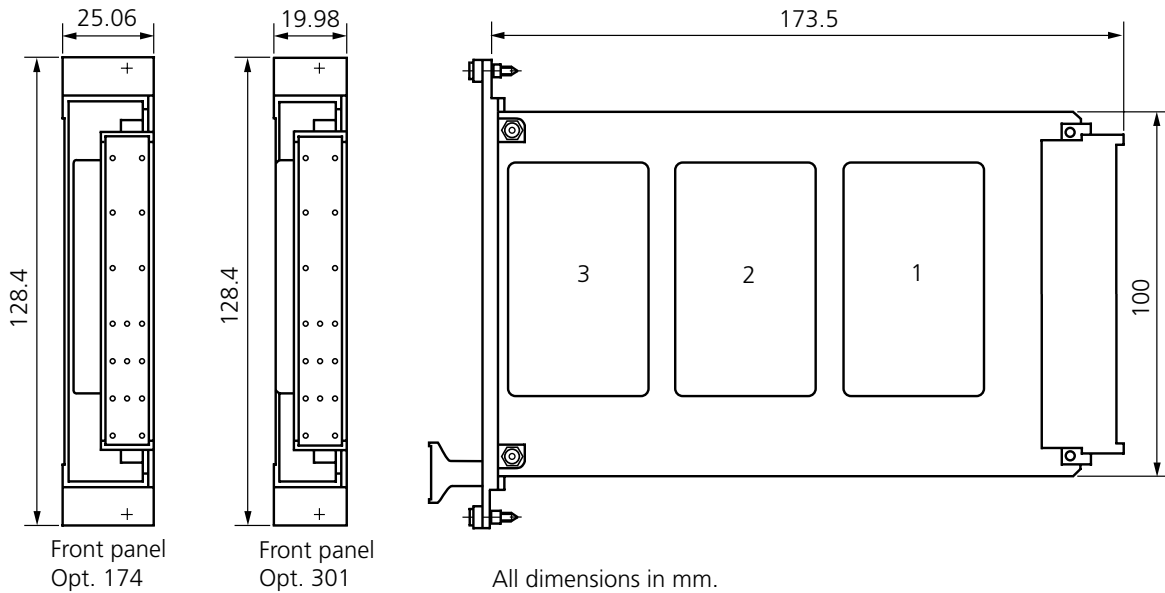

Plug-in connection: Type F according to DIN 41612

Front panel Opt. 174: INTERMAS SP/K3-n05T plastic, gray

Front panel Opt. 301: INTERMAS SP/K3-n04T plastic, gray

Installation, commissioning and maintenance may only be carried out by trained personnel.

Dimension drawings and pin assignment

for EK 9 Eurocard

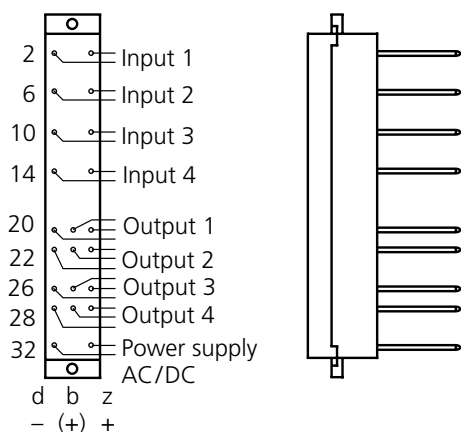
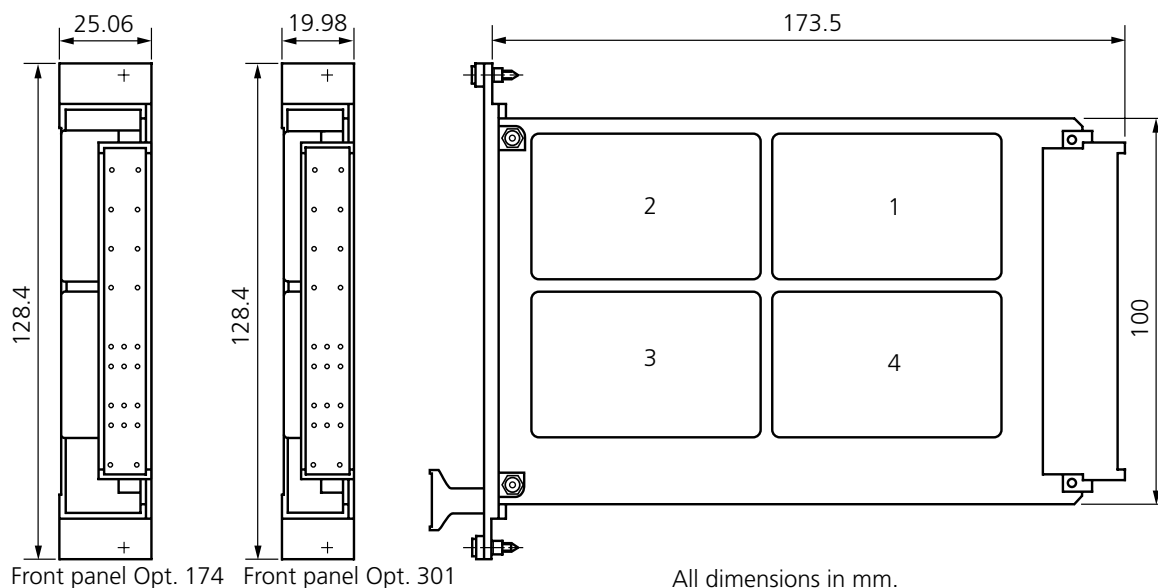

Plug-in connection: Type F according to DIN 41612

Front panel Opt. 174: INTERMAS SP/K3-n05T plastic, gray

Front panel Opt. 301: INTERMAS SP/K3-n04T plastic, gray

Installation, commissioning and maintenance may only be carried out by trained personnel.

Terminal assignments for Options 250 or 251

Model	Option	Input*)	Output	Output connection	Jumper (output)
3820	250	0 ... 20 mA	0 ... 20 mA	dz	db
		4 ... 20 mA	0 ... 20 mA	dz	
3820	251	0 ... 20 mA	0 ... 20 mA	dz	
		0 ... 20 mA	4 ... 20 mA	db	
4820	250	0 ... 20 mA	0 ... 10 V	dz	db
		4 ... 20 mA	0 ... 10 V	dz	
3310	251	0 ... 10 V	0 ... 20 mA	dz	
		0 ... 10 V	4 ... 20 mA	db	

*) See dimension drawing

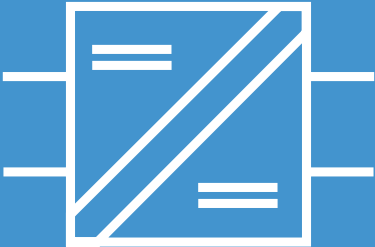

IsoTrans® 41

For separation of 0(4) ... 20 mA standard signals without a power supply in 19" format

The task

Galvanic isolation of measuring signals using 19" technology, cost cutting by means of minimum cabling in series production

The problems

The application possibilities for loop-powered isolators are mainly defined by the following critical data:

- Voltage drop
- Operating current
- Accuracy
- Load voltage
- Signal delay
- Isolation voltage
- Dimensions

The solution

Knick's IsoTrans® 41 isolator has unmatched technical specifications. The isolator draws its power as voltage drop from the measured signal without influencing it noticeably. This saves on supply units and cabling and increases the reliability accordingly.

The enclosure

The integration of several modules on a Eurocard means minimum cabling, compact design and a low price. The full encapsulation of the modules guarantees a high level of reliability even in extreme conditions.

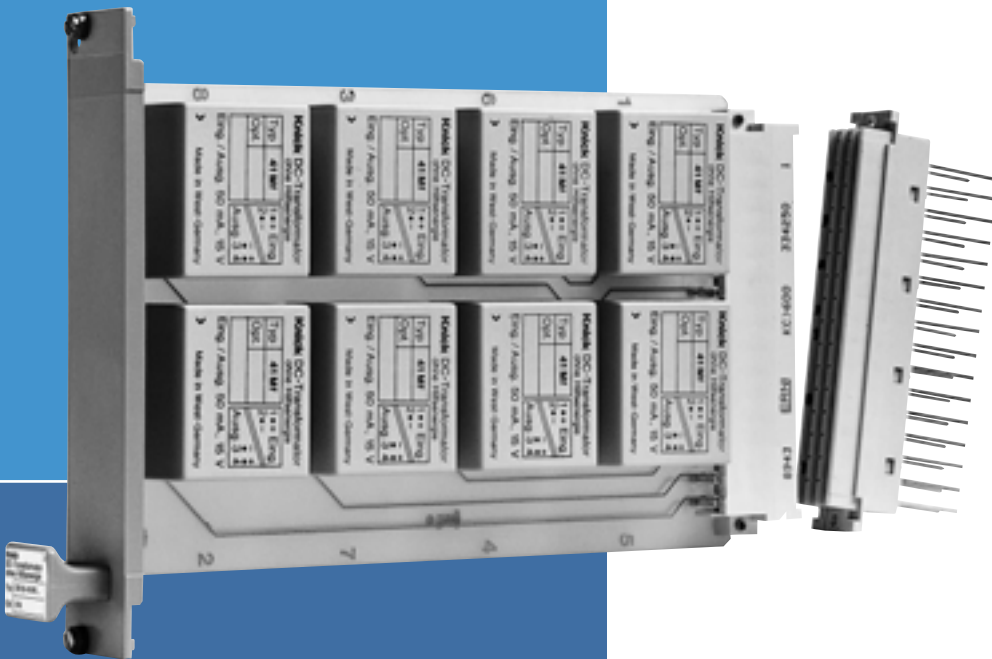

The advantages

IsoTrans® 41 with a voltage drop of 1.2 V is the 1:1 isolator for all applications where loop-powered isolators are not suitable because of technical problems, for example, voltage drop too high.

The application

Galvanic isolation

- of input and output circuits
- of the supply voltage for 2-wire transmitters
- in the case of addition or another coupling of signals at different potentials
- for eliminating double ground compensation currents
- when there is an insufficient insulation and test voltage
- of high-potential signal sources
- for battery-powered devices with a central battery

The technology

Knick's IsoTrans® 41 DC isolators with transformer isolation have specifications well beyond any other loop-powered isolators. They feature a chopper generator connected in series into a current path and current conversion which gradually changes from sine to square wave over the measuring range. This avoids the accuracy-reducing power losses of normal parallel connected generators, reduces the voltage drop accordingly and also ensures accurate transmission of the smallest currents.

The facts

- **Lower costs due to multichannel design**
Eurocard up to a maximum of 8 channels
- **Minimum loading**
Voltage drop from 1.2 V, current transmission from 2 µA to 50 mA
- **Good signal transmission**
Low signal delay
- **No power supply required**
Cost saving due to lower wiring requirement, no mains influences
- **Maximum reliability**
No repair and failure costs
- **Extremely high accuracy**
- **5-year warranty**

Warranty
5 years!

Defects occurring within 5 years from delivery are remedied free of charge at our plant (carriage and insurance paid by sender).

Product line

Eurocards

For up to 8 channels

Power supply

None, supply from input signal

Order no.

EK 15–41Mi...¹⁾

Options

INTERMAS SP/K3-n04T front panel, plastic, gray, width 20 mm

301

¹⁾ Please indicate the required channel number when ordering. Model EK 5–... is still available for replacement purposes.

Specifications

Input data

Input	0 ... 20 mA 0 ... 50 mA
Operating current	< 2 μ A
Configuration	Max. 8 modules
Voltage drop	Approx. 1.2 V (20 mA) Approx. 1.6 V (50 mA)
Overload	100 mA, 20 V (see also page 193)

Output data

Output	0 ... 20 mA/max. 15 V (corresponds to 750 Ohm load) 0 ... 50 mA/max. 15 V (corresponds to 300 Ohm load)
Offset	< 5 μ A
Residual ripple ²⁾	< 1.5 mV _{pp} /mA

Transmission behavior

Transformation error ³⁾	0.02 % meas. val.
Load error	< 0.02 % measured value per 100 Ohms
Rise or fall time	Approx. 2.5 ms at 500 Ohm load resistance

²⁾ Slightly increased residual ripple can occur when load < 5 Ohms

³⁾ Temperature range –10 ... +70 °C

Specifications, continued

Isolation

Test voltage	2.5 kV AC
Working voltage (basic isolation)	<p>≤ 4 channels 500 V DC with overvoltage category II and pollution degree 2</p> <p>≥ 5 channels 500 V DC with overvoltage category II and pollution degree 1 according to EN 61010-1</p> <p>For applications with high working voltages, you should ensure there is sufficient spacing or isolation from neighboring devices and protection against electrical shocks.</p>

Standards and approvals

Surge withstand	5 kV 1.2/50 μs according to IEC 255-4
Immunity to ESD	8 kV according to IEC 801-2

Other data

Ambient temperature	-25 ... +80 °C
Version	Eurocard 4 TE
Pin connector	Type F according to DIN 41612, see also dimension drawings
Socket connector ⁴⁾	Type F according to DIN 41612 (wire-wrap connection), see also dimension drawings
Weight	Approx. 40 g per channel

4) Included in package contents.

Transfer functions

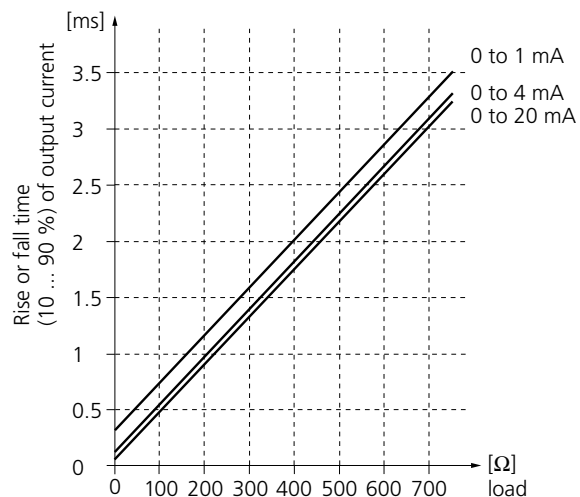
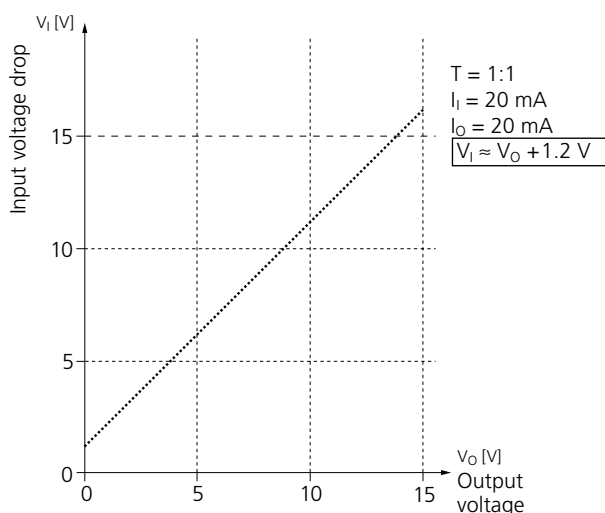

Schematic diagram

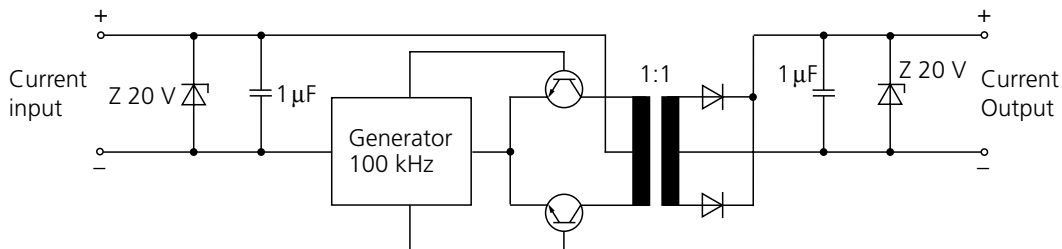

Typical configurations

Electrical isolation

With impressed current, current output

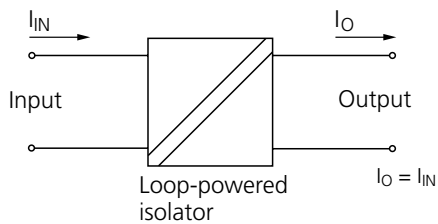

Electrical isolation

With impressed input current, current output

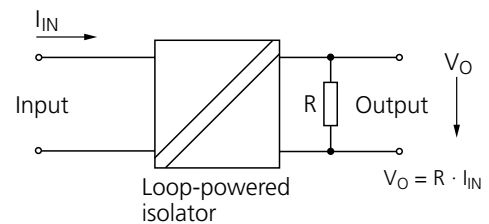

Electrical isolation

in two-wire technology

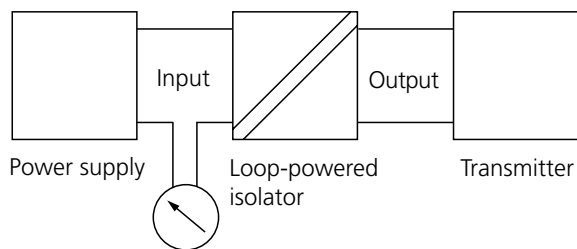

Electrical isolation

For current addition with impressed currents

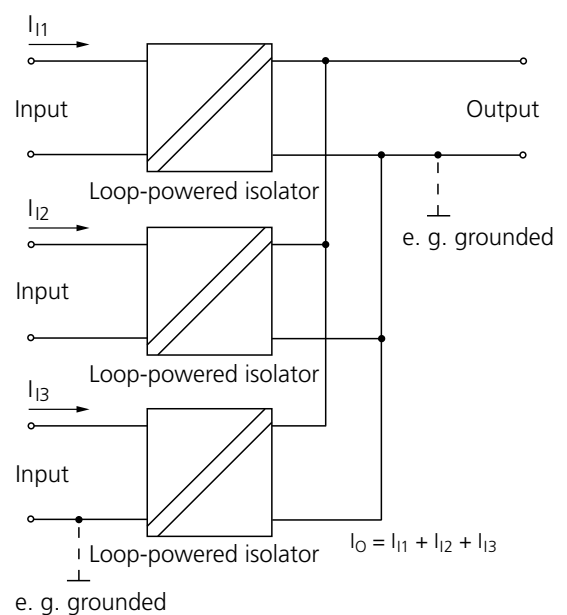

Dimension drawing and pin assignment

for EK 15 Eurocard

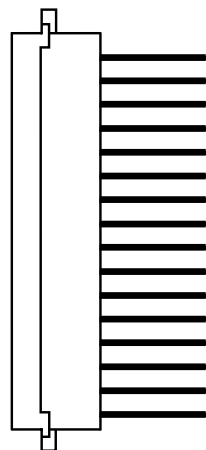
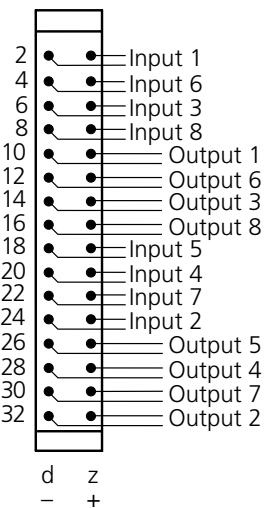
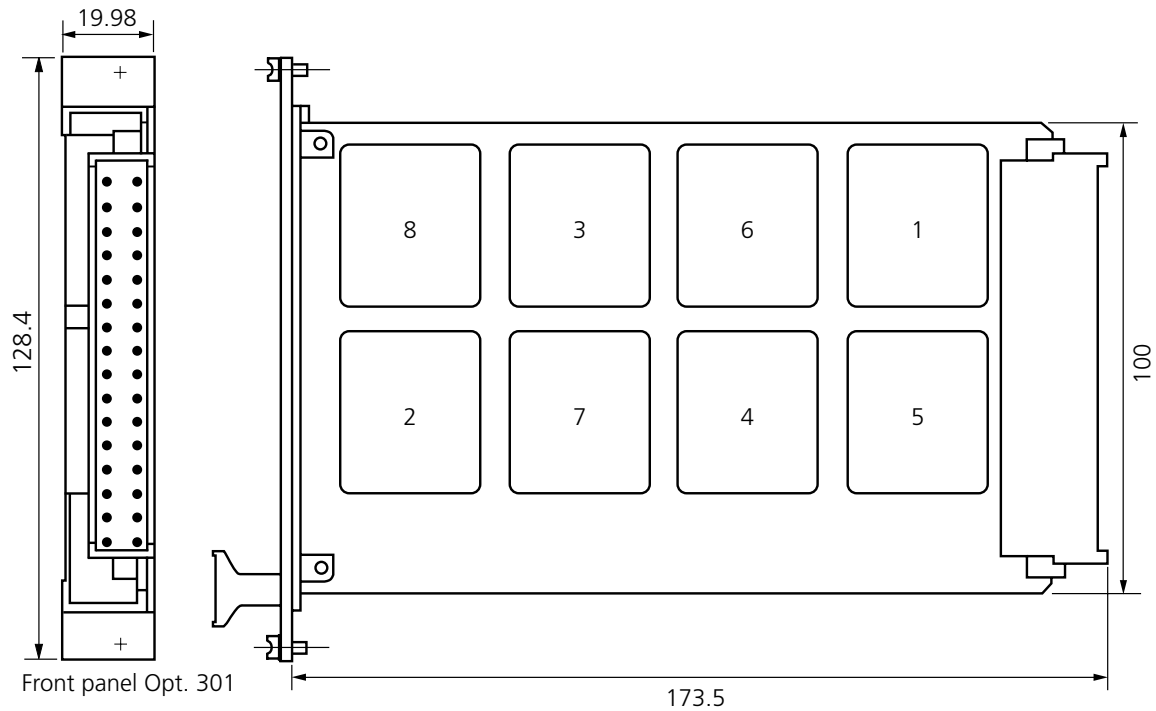

All dimensions in mm.

Plug-in connection
Front panel Opt. 301

Type F according to DIN 41612
INTERMAS SP/K3-n04 T,
plastic, gray

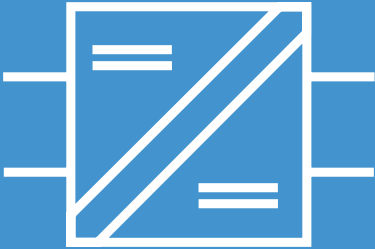

IsoTrans® 46

For isolation of 0 ... 20 mA standard signals

Complementing Knick's series of loop-powered isolators, the IsoTrans® 46 is a competitively priced compact model.

The IsoTrans® 46 isolates 0 ... 20 mA standard current signals avoiding parasitic voltages or currents and eliminating grounding problems. It is also optionally available with safe isolation to EN 61140.

The facts

- **No mains supply required**
cost saving due to lower wiring requirement, no mains influences
- **Low power loss**
no unnecessary heating in switch cabinet
- **Safe isolation in accordance with EN 61140**
protection of the maintenance staff and the subsequent devices against non-permitted high voltages
- **Maximum reliability**
no maintenance work therefore the related costs are not incurred
- **5-year warranty**

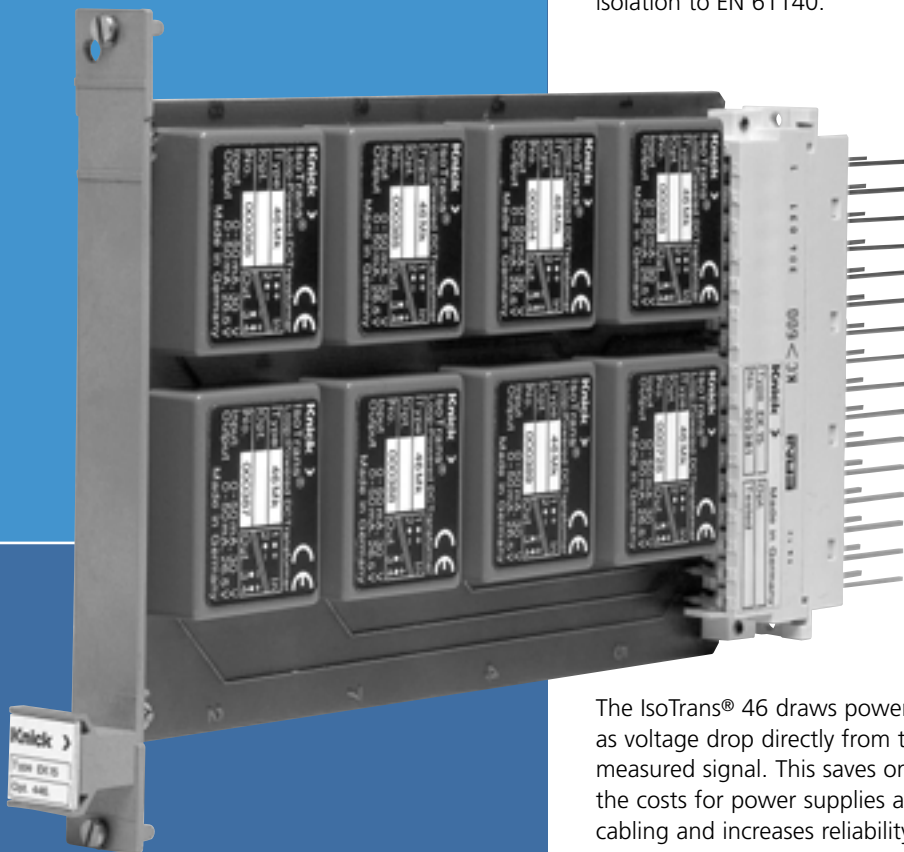

The IsoTrans® 46 draws power as voltage drop directly from the measured signal. This saves on the costs for power supplies and cabling and increases reliability.

The low height allows use of up to 8 channels on a Eurocard with just 3 TE front panel. This means 224 channels can be accommodated in a 19" rack.

Warranty
5 years!

Defects occurring within 5 years from delivery are remedied free of charge at our plant (carriage and insurance paid by sender).

Product line

Eurocards

For up to 8 channels

Order no.

EK 15-46Mk/...¹⁾

Power supply

None, supply from input signal

Options

INTERMAS SP/K3-n04T front panel, plastic, gray, width 15 mm, for EK 15 Eurocard, mounted

446

Safe electrical isolation to VDE 0100 Part 410

453

1) Please indicate the required module number when ordering.

Specifications

Input data

Input 0 ... 20 mA²⁾

Operating current < 20 µA

Configuration Max. 8 channels

Overload 100 mA, 30 V

Voltage drop Approx. 2.5 V³⁾

Output data

Output 0 ... 20 mA, max. 27.5 V
(corresponds with 1375 Ohm load)

Load error < 0.02 % meas. val. / 100 Ohm

Residual ripple < 5 mV

2) Linear transmission up to 50 mA

3) Approx. 3.5 V at 50 mA

Specifications, continued

Transmission behavior

Transmission errors	<0.1 % full scale
Rise and fall time	Approx. 5 ms at 500 Ohm load
Temperature coefficient ⁴⁾	0.002 %/K full scale per 100 Ohm load

Isolation

Test voltage	510 V AC 4 kV AC with option 453
--------------	-------------------------------------

Working voltages
(basic isolation)

According to EN 61010-1

Type EK15**Overvoltage category /
perm. pollution degree****Permitted
working voltage**

Input against output
of the same channel

I / degree 4
II / degree 4
III / degree 4

150 V AC/DC
100 V AC/DC
50 V AC/DC

With ≤4 channels
Inputs/outputs against
inputs or outputs of
external channels

III / degree 2
IV / degree 3

600 V AC/DC
300 V AC/DC

With ≥5 channels
Inputs/outputs against
inputs or outputs of
external channels

III / degree 2
III / degree 2

600 V AC/DC
300 V

Permitted working voltages for modules with protective separation (Opt. 453) and other overvoltage categories and pollution degrees on request.

For applications with high working voltages, you should ensure there is sufficient spacing or isolation from neighboring devices and protection against electrical shocks.

Protection against
electrical shock (Opt. 453)

Safe isolation according to EN 61140 by reinforced insulation according to EN 61010-1. For applications with high working voltages, you should ensure there is sufficient spacing or isolation from neighboring devices and protection against electrical shocks.

Standards and approvals

Surge withstand according to IEC 255-4	5 kV 1.2/50 μs (only with Opt. 453)
Surge withstand according to EN 61010-1	850 V >6 kV with option 453
EMC ⁵⁾	NAMUR NE 21, European EMC regulations

4) Average TC, reference temperature 23 °C

5) Valid for 4 ... 20 mA, slight deviations possible during interference.

Specifications, continued

Other data

Ambient temperature	Operation: -10 ... +70 °C Transport and storage: -30 ... +80 °C
Version	Eurocard 3 TE
Pin connector	Type F according to DIN 41612, see also dimension drawings
Socket connector	Type F according to DIN 41612, wire-wrap connection (included in package contents), see also dimension drawings
Front panel (Opt. 446)	INTERMAS SP/K3-n03T, plastic, gray, see also dimension drawings
Weight	Approx. 13 g per channel

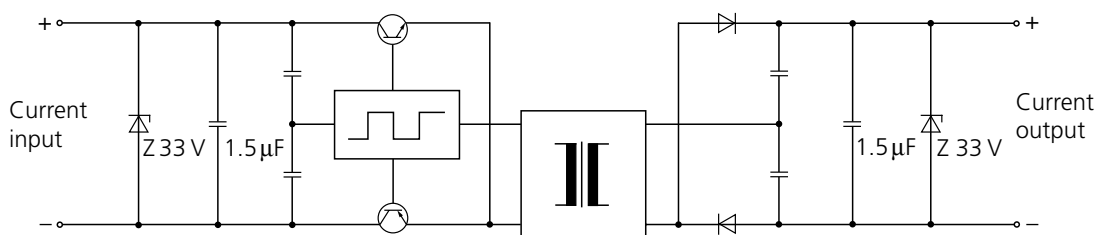
Schematic diagram

Dimension drawing and pin assignment

for EK 15 Eurocard

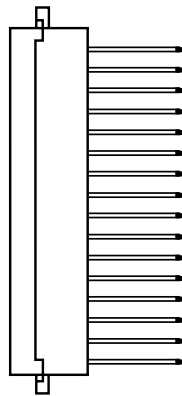
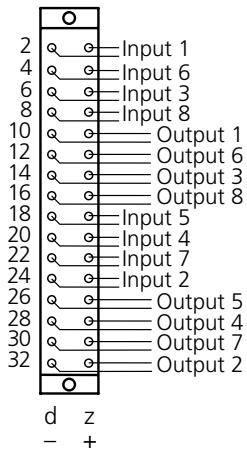
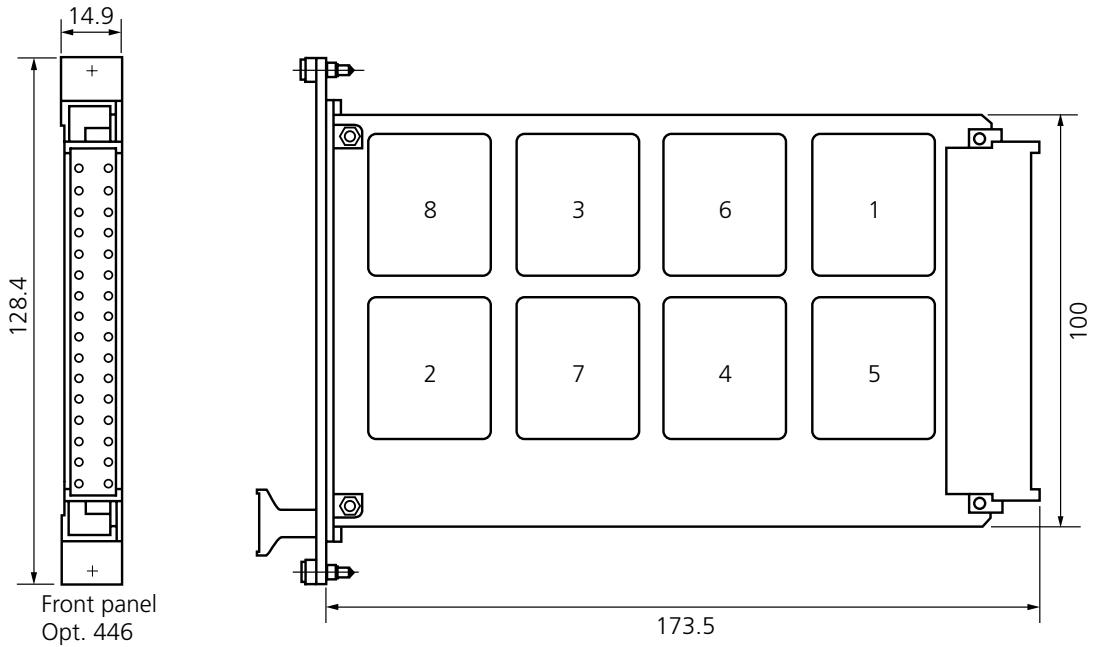

All dimensions in mm.

Plug-in connection Type F according to DIN 41612
 Front panel Opt. 446 INTERMAS SP/K3-n3 T, plastic, gray

IsoAmp® EK 30/31

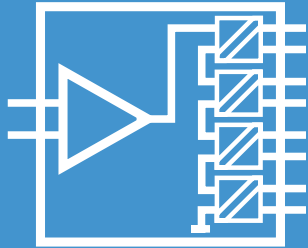

For isolation and conversion of impressed measured signals

The task

Reliable transmission and conversion of (0) 4 ... 20 mA and 0 ... 10 V signals with high accuracy in up to four 0(4) ... 20 mA output signals.

The problems

Almost perfect signal transmission with avoidance of dangerous electrical shock.

The solution

The Knick standard-signal multipliers provide perfect solutions for

- the signal multiplication to up to four output channels with galvanic isolation,
- increasing the output load to a max. of 40 V (series connection of the output circuits),
- the conversion of the standard current or of the voltage input signal into any standard current output signals,
- the prevention of dangerous electrical shocks by means of safe isolation.

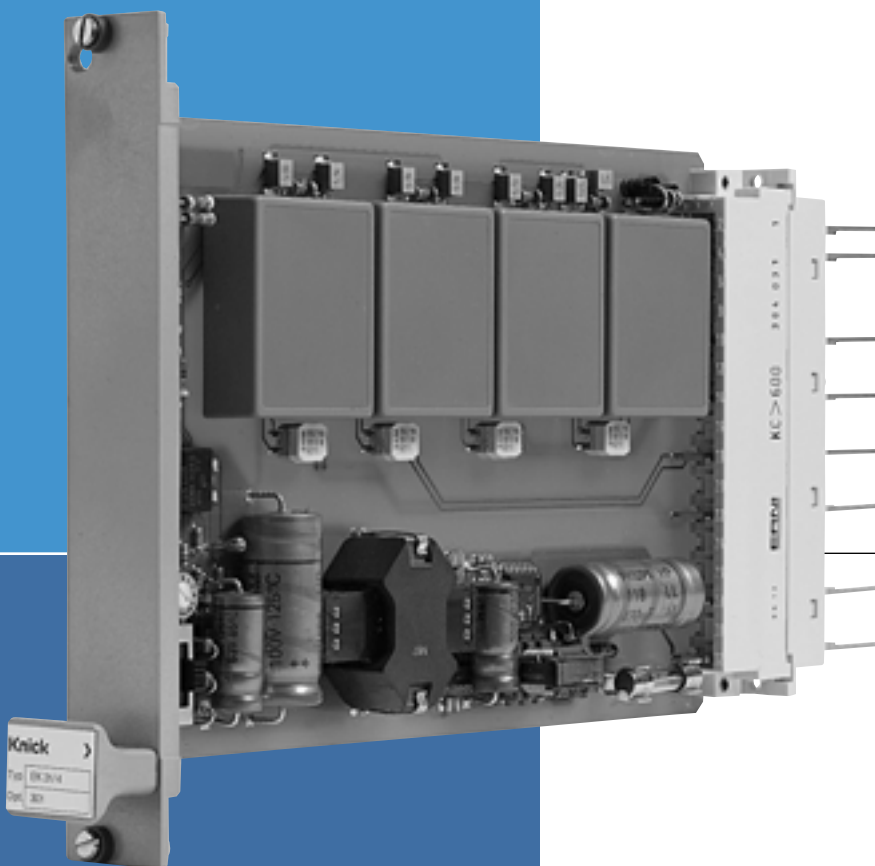

The enclosure

The compact design allows the use of a Eurocard with a width of just 4 TE. This means up to 84 channels can be accommodated in a 19" rack.

The advantages

There are no negative feedback resistors as normally required in conventional amplifiers. The number of components is thus reduced to a minimum. Accuracy and reliability are increased accordingly.

The modular concept allows simple retrofitting of output channels. Your measuring point is therefore also expandable for future measuring tasks.

The technology

With an optimized signal concept, the Knick standard-signal multipliers achieve almost perfect signal transmission.

The facts

- **Simple signal switching**
universal use for numerous signal combinations
- **3-port isolation**
protection against incorrect measurements or damage to the measuring system due to parasitic voltages
- **Safe isolation**
protection against unpermitted high voltages
- **Compact design**
Eurocard with width of just 4 TE, up to 84 output channels in a 19" rack
- **High accuracy**
no falsification of measured signal
- **Maximum reliability**
no repair and failure costs
- **Expandable**
outputs can be retrofitted, expandable for future measuring tasks
- **5-year warranty**

Warranty
5 years!

Defects occurring within 5 years from delivery are remedied free of charge at our plant (carriage and insurance paid by sender).

Product line

Eurocards	Configuration	Order no.
EK 30	2 output channels 3 output channels 4 output channels	EK 30/2 EK 30/3 EK 30/4
EK 31 with safe isolation also of the outputs	2 output channels 3 output channels 4 output channels	EK 31/2 EK 31/3 EK 31/4
Power supply		
24 V AC/DC		
Option		
INTERMAS SP/K3-n04T front panel, width 20 mm, plastic, gray, mounted		301
Accessories		
Output module for EK 30, individually retrofittable		46 Mk
Output module with safe isolation, for EK 31, individually retrofittable		46 Mk Opt. 453

Specifications

Input data

Input ¹⁾	0 ... 20 mA or 4 ... 20 mA, voltage drop approx. 400 V 0 ... 10 V, input resistance 1 MOhm
Configuration	Max. 4 output channels
Overload	100 mA

Output data

Output	Up to 4 channels, 0 ... 20 mA or 4 ... 20 mA (selectable via slide switches for all channels together)
Load	≤500 Ohm per channel at 20 mA
Load error	<0.02 % meas. val./100 Ohms
Offset	20 μA at input 0 (4) ... 20 mA 25 μA at input 0 ... 10 V
Residual ripple	<5 mV

¹⁾ Other ranges on request

Specifications, continued

Transmission behavior

Transmission error ²⁾	0.1 % meas. val. at input 0 (4) ... 20 mA 0.25 % meas. val. at input 0 ... 10 V
Rise or fall time	Approx. 5 ms at 500 Ohm load
Temperature coefficient ³⁾	0.01 % meas. val./K at input 0 (4) ... 20 mA; 0.015 % meas. val./K at input 0 ... 10 V

Power supply

Power supply	24 V DC –15 % +20 %, approx. 2.7 W 24 V AC –15 % +10 %, 48 ... 500 Hz, approx. 3.5 VA
--------------	--

Isolation

Galvanic isolation	3-port isolation between input, output and power supply		
Test voltage	EK 30	Power supply against all other circuits Outputs among each other and against input	4 kV AC 510 V AC
	EK 31	All isolating distances	4 kV AC
Working voltages (basic isolation)	According to EN 61010-1		
	Type EK30	Overvoltage category / perm. pollution degree	Permitted working voltage
	Outputs against each other and against input	I / degree 4 II / degree 4 I / degree 4	150 V AC/DC 100 V AC/DC 50 V AC/DC
	Power supply against input and against output	II / degree 2 III / degree 2 III / degree 3 IV / degree 3	1000 V AC/DC 600 V AC/DC 410 V AC/DC 300 V AC/DC
	Type EK31	Overvoltage category / perm. pollution degree	Permitted working voltage
	All isolating distances	II / degree 2 III / degree 2 III / degree 3 IV / degree 3	1000 V AC/DC 600 V AC/DC 410 V AC/DC 300 V AC/DC

For applications with high working voltages, you should ensure there is sufficient spacing or isolation from neighboring devices and protection against electrical shocks.

Protection against electrical shock	Safe isolation according to EN 61140 through reinforced insulation according to EN 61010-1. Working voltage up to overvoltage category III and pollution degree 2 with EK 30: 300 V AC/DC between power supply and all other circuits, with EK 31 between each output and all other circuits as well as between power supply and all other circuits For applications with high working voltages, you should ensure there is sufficient spacing or isolation from neighboring devices and protection against electrical shocks.
-------------------------------------	--

2) Additional faults in live-zero operation (mode selector position 2 and 3) 20 µA

3) Average TC, reference temperature 23 °C; additional faults in live-zero operation (mode selector position 2 and 3) 1 µA/K

Specifications, continued

Standards and approvals

EMC	EMC directive 89/336/EEC, EN 61326; NAMUR NE 21
-----	---

Other data

Ambient temperature	Operation: $-10 \dots +70 \text{ }^\circ\text{C}$ Transport and storage: $-30 \dots +80 \text{ }^\circ\text{C}$
---------------------	--

Version	Eurocard, 4 TE, see also dimension drawing
---------	--

Pin connector	Type F according to DIN 41612, see also dimension drawings
---------------	--

Socket connector	Type F according to DIN 41612 (included in package contents), see also dimension drawings
------------------	---

Weight	Approx. 170 g with 2 channels, approx. 185 g with 3 channels, approx. 200 g with 4 channels
--------	---

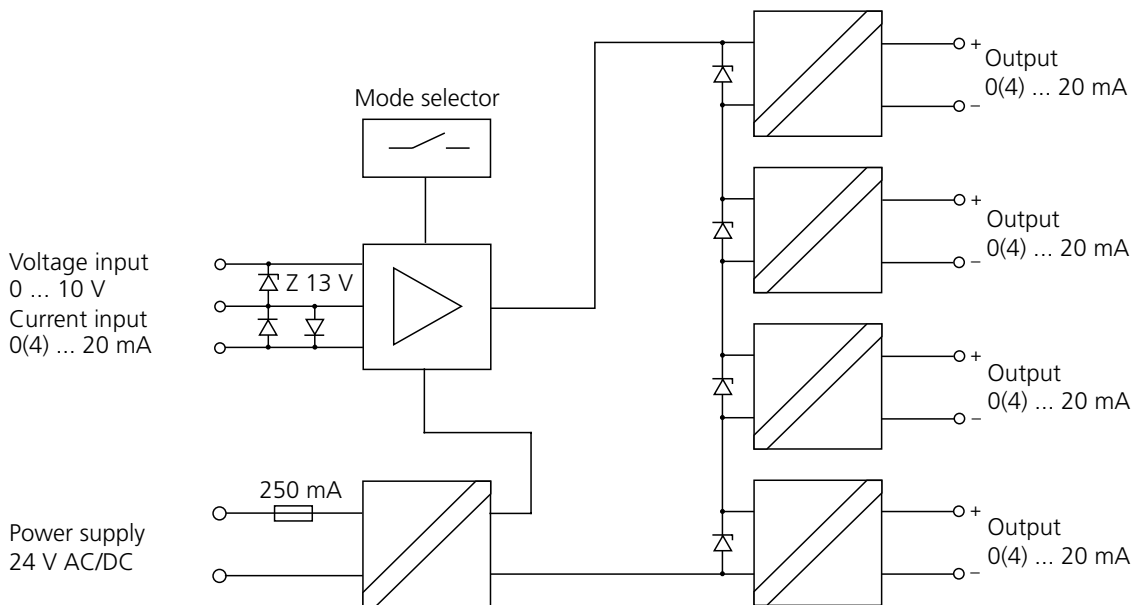
Schematic diagram

Application examples

Galvanically isolated actuation of computer, recorder and indicator with additional measuring output

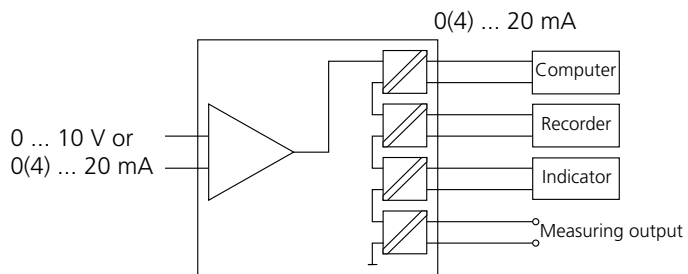

Series connection for increasing the load voltage

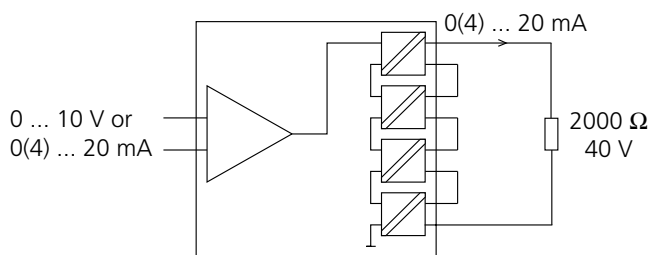

Dimension drawing and pin assignment

For Eurocard EK 30/31

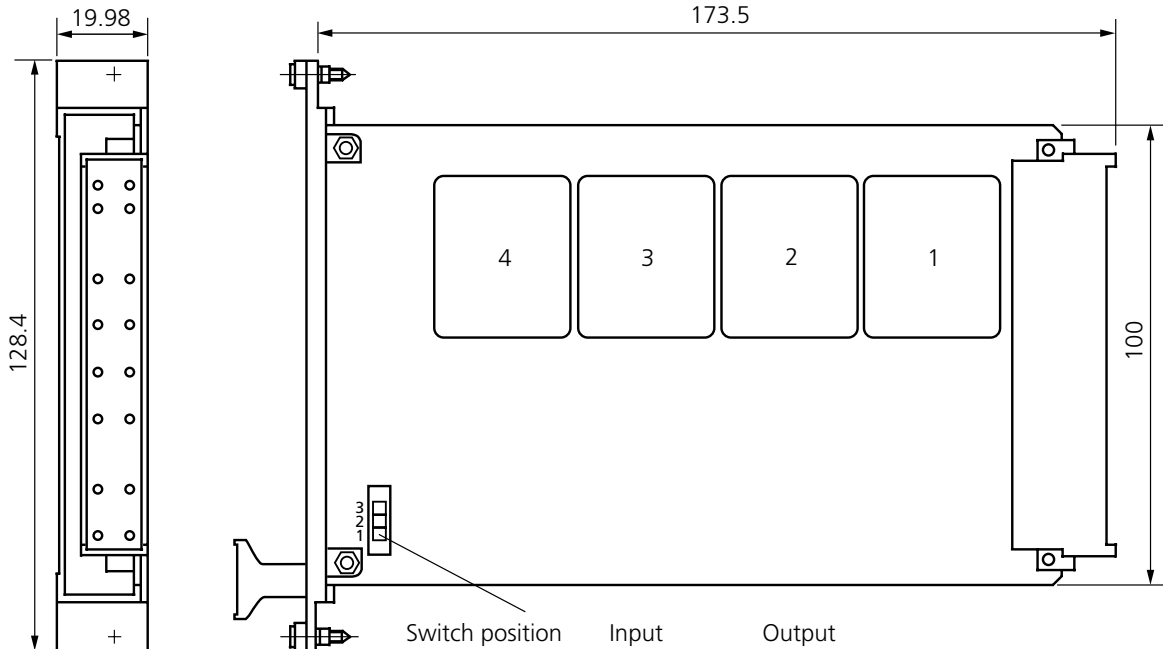

Front panel
Opt. 301

Switch position	Input	Output
1	0 – 10 V 0 – 20 mA	0 – 20 mA
2	0 – 10 V 0 – 20 mA	4 – 20 mA
3	4 – 20 mA	0 – 20 mA

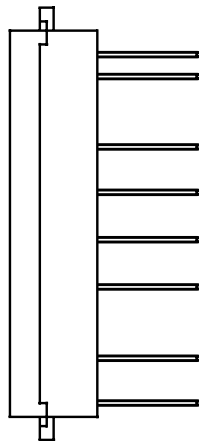
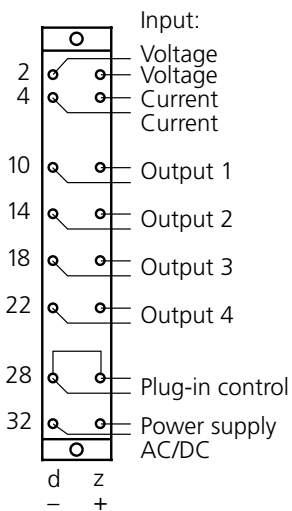

Plug-in connection: Type F according to DIN 41612

Front panel Opt. 301: INTERMAS SP/K3-n04T, plastic, gray

Installation, commissioning and maintenance may only be carried out by trained personnel.

All dimensions in mm.

Knick > IsoAmp®
DC Isolation Amplifier

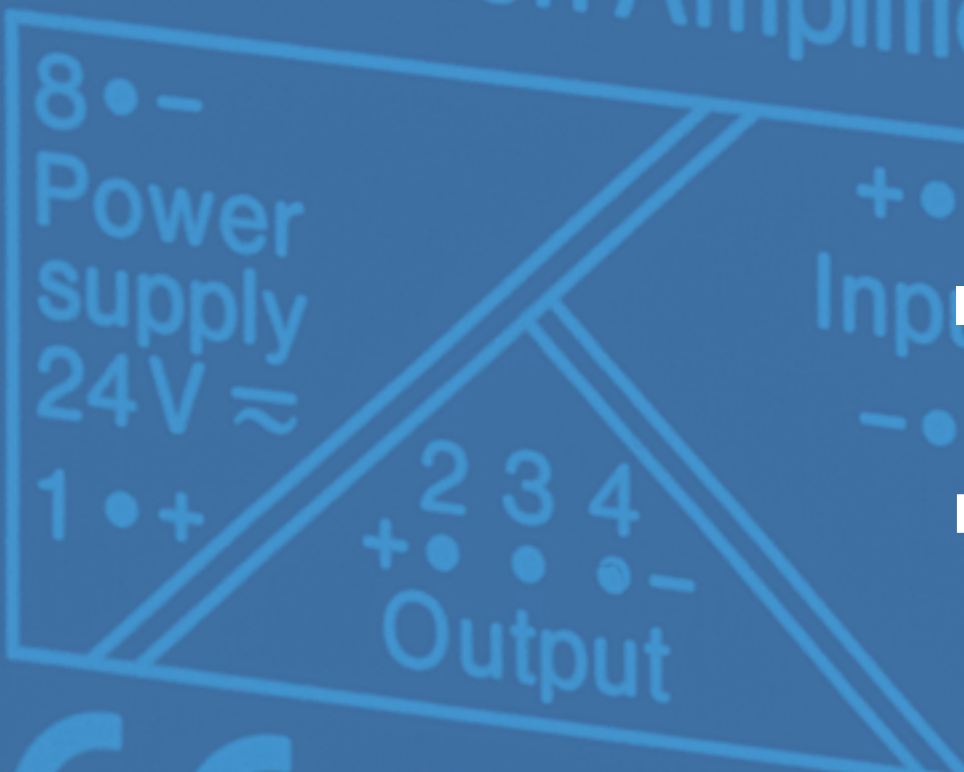

Made
Germany

Modules

Type

Opt.

No.

In | 7+

In | 7-

Wire

Out | 2-

Out | 3-

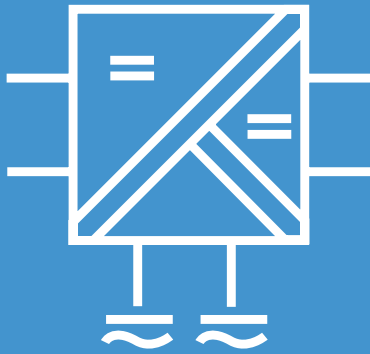

IsoAmp® 11000/12000

Universal Isolation Amplifiers

Knick's IsoAmp® 11000/12000 series features a tried and tested range of powerful DC isolation amplifiers that have excellent specifications despite small dimensions and have a symmetrical input with high common mode rejection.

When conventional unsymmetrical isolation amplifiers are used, signal interferences can occur that seem inexplicable to the user at first. If, for example, there are several subsequent devices in a current output loop, an isolation amplifier can meet a LO output with its HI input which can cause the above-mentioned signal interferences.

On the Knick IsoAmp® 11000 / 12000 DC isolation amplifiers, the input is symmetrical, i. e. both input terminals can be exchanged without undesired effects on the common mode rejection.

Models with connections for external gain setting, zeroing and live-zero switching (0 ... 20 mA / 4 ... 20 mA) are available for special tasks.

The isolation amplifiers are easy to use and can be used anywhere where small dimensions are needed together with high isolation voltage, highly accurate measuring and maximum reliability.

The facts

- Symmetrical input with high common mode rejection
- Excellent specifications
- High isolation voltage
- High output power
- Optional external gain adjustment with just one resistor
- Live-zero switching (0 ... 20 mA / 4 ... 20 mA)
- Complete modules without external connection
- Miniature flat design for pcb mounting
- High quality and reliability
- 100 % computer-supported production monitoring and final check
- 5-year warranty

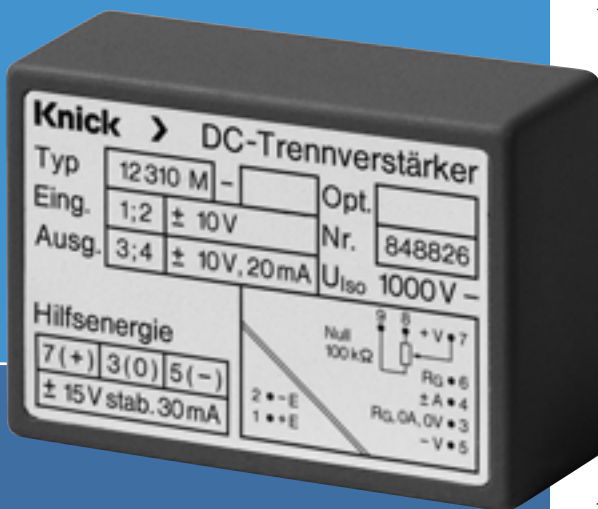

Warranty
5 years!

Defects occurring within 5 years from delivery are remedied free of charge at our plant (carriage and insurance paid by sender).

Product line

Devices	Symmetrical input	Impressed output	Load capability	Order no.
Free wiring	Up to ± 500 mV depending on wiring	± 20 mA	10 V ¹⁾	11001 M
	Up to ± 500 mV depending on wiring	± 10 V ¹⁾	20 mA	12001 M
Fixed setting	± 20 mV	± 20 mA	10 V ¹⁾	11202 M
	± 60 mV			11206 M
	± 150 mV			11215 M
	± 500 mV			11250 M
	± 10 V			11310 M
	± 20 mA	11820 M		
	± 20 mV	± 10 V	20 mA	12202 M
	± 60 mV			12206 M
	± 150 mV			12215 M
	± 500 mV			12250 M
± 10 V	12310 M			
± 20 mA	12820 M			
Power supply				
15 V DC				
Options				Order no.
Output $\pm 0 \dots 20$ mA and $+4 \dots 20$ mA, switchable (with live-zero: unipolar input, additional error $\pm 10 \mu\text{A}$)				173
Gain error < 0.1 % of measured value (not Model 11202)				04

1) ± 10 V or 20 V unipolar (check power supply!)

Specifications

Input data

Input	See Product line
Input resistance	> 1 MOhm, for models with $I_I \pm 20$ mA: 7.5 Ohm
Overload	$V_I = 25$ V, $I_I = 300$ mA

Output data

Output	see Product line
Offset current ³⁾	< 50 nA

Specifications, continued

Output data

Offset voltage³⁾ < 500 μ V, external zeroing
 Drift < 5 μ V/month

Residual ripple \leq 10 mV_{pp}

Transmission behavior

Gain error < 0.2 % meas. val., Opt. 04: <0.1% meas. val.

Cut-off frequency²⁾ > 1.5 ... 5 kHz –3 dB (20 mV ... 500 mV or 10 V); different values on request

Temperature coefficient^{3) 4)} < 1 nA/K, < 2 μ V/K (reference temperature 23 °C)

Power supply

Power supply \pm 14.5 ... 15.5 V DC stabilized, approx. 30 mA
 for unipolar operation up to 20 V output voltage: –5, +25 V stabilized

Isolation

Galvanic isolation 3-port isolation between input, output and power supply

Test voltage 4 kV AC between input and output/power supply

Working voltages (basic isolation) 1000 V DC with overvoltage category II and pollution degree 3 according to EN 61010-1.
 For applications with high working voltages, you should ensure there is sufficient spacing or isolation from neighboring devices and protection against electrical shocks.

Standards and approvals

EMC EMC directive 89/336/EEC

Other data

Ambient temperature –10 ... +70 °C

Version Module, encapsulated, see dimension drawings for measurements

Weight Approx. 45 g

2) Current output up to 250 Ohm load, Models 11310 and 12310 up to 10 V_{pp}

3) x 10 for Models 11310, 12310

4) Offset set to zero

Connection diagrams

11000 M connection diagram

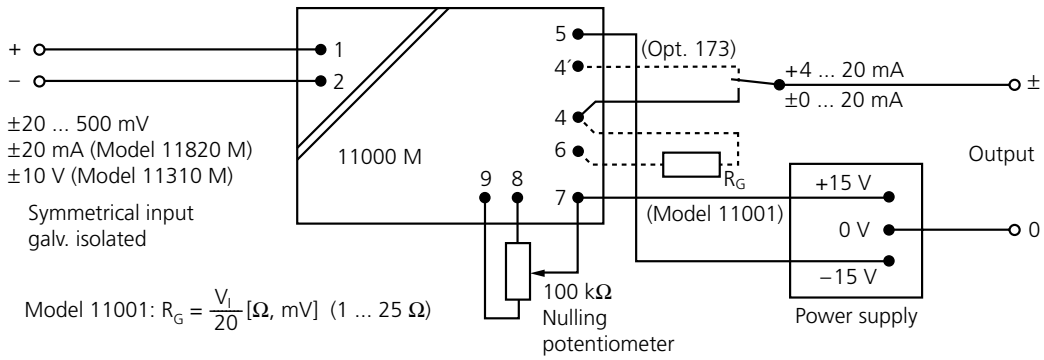

12000 M connection diagram

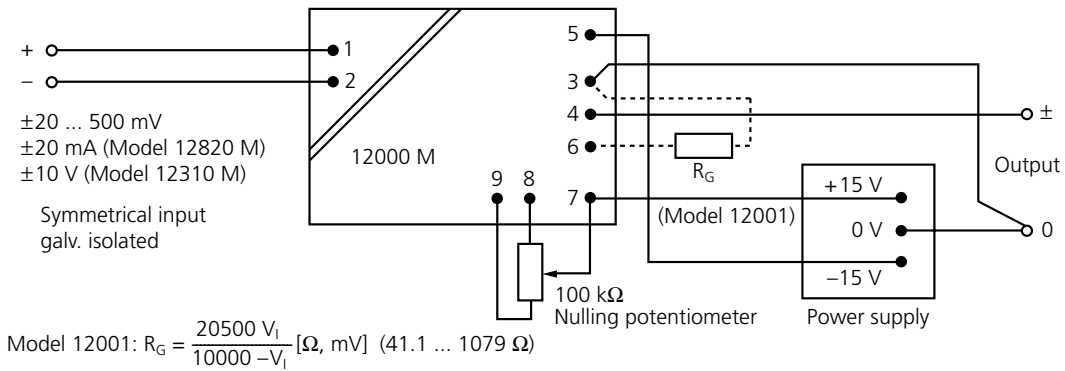

Dimension drawings and pin assignment

11000 M

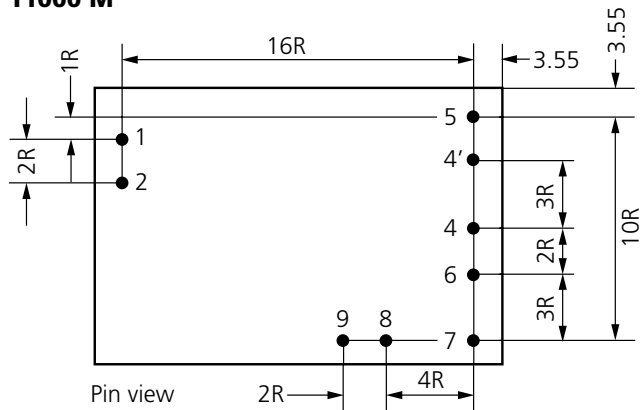

- 1 Input +
- 2 Input -
- 4 Output $\pm 0 \dots 20 \text{ mA}$, R_G
- 4 Output $+ 4 \dots 20 \text{ mA}$, (Opt. 173)
- 5 Power supply -
- 6 R_G (Model 11 001)
- 7 Nulling Power supply +
- 8 potentiometer
- 9 100 k Ω

Connect 0 output to 0 V power supply.

12000 M

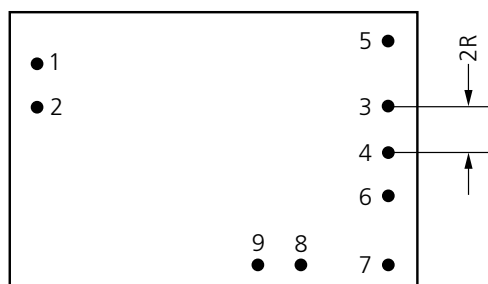

R = spacing = 2.54
Pin view

- 1 Input +
- 2 Input -
- 3 Output 0, Power supply 0 V, R_G
- 4 Output \pm
- 5 Power supply -
- 6 R_G (Model 12 001)
- 7 Nulling Power supply +
- 8 potentiometer
- 9 100 k Ω

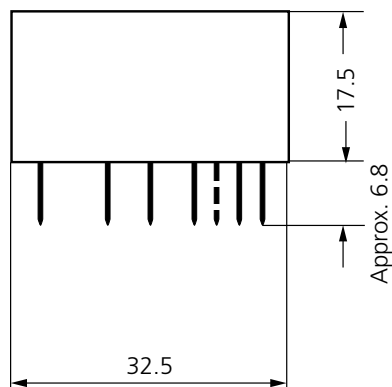
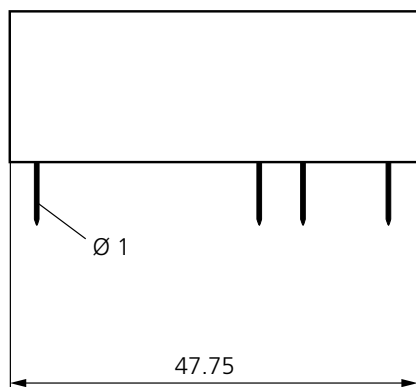

All dimensions in mm.

IsoAmp® 3000/4000

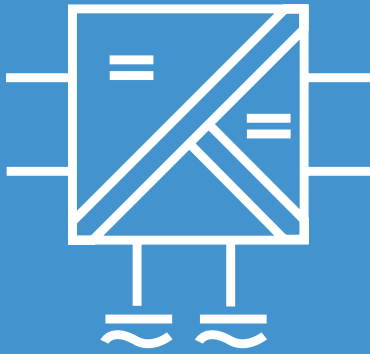

For transmission and conversion of impressed measuring signals

The DC isolation amplifiers from the IsoAmp® 3000/4000 series transmit and convert impressed 0(4) ... 20 mA or 0 ... 10 V standard signals according to our DBP 34 12 843 patent with a high level of accuracy.

They provide safe isolation and high insulation from input to output to power supply.

The control range extends into the negative values and allows strict linear transmission in the zero range. Compared with conventional unipolar amplifiers, this has a great advantage: The often asymptotic setting of the zero point, for example, when calibrating with a sensor, is ruled out.

The transmission accuracy is unusually high. The reason for this is mainly a negative feedback circuit that is incorporated in the electrical isolation. It has no measuring resistor for 1:1 transmission and just one measuring resistor for current/voltage conversion. Differentiated signal return allows the circuit to remain stable even with strong complex loads.

The components required in conventional concepts for matching amplifiers and resistor networks are omitted. The reliability is accordingly high.

The computer-controlled production monitoring and final check ensure high and constant quality. The full encapsulation guarantees maximum safety and reliability even in extreme conditions.



The devices can be used for many galvanic isolation applications, for example:

- In measuring and control engineering across the world
- For linking measured signals to different potentials
- For removal of double ground compensation currents
- For isolation of dangerous touch voltages
- For computer interfacing
- For increasing the load voltage and decoupled signal transmission

The DC isolation amplifier is available as a module for universal 24 V AC/DC power supply for use on printed circuit boards.

For safe isolation in accordance with EN 61140, the required clearance and creepage distance should be taken into consideration.

Warranty
5 years!

Defects occurring within 5 years from delivery are remedied free of charge at our plant (carriage and insurance paid by sender).

Model overview

IsoAmp® 3820
transforms the input current 1 : 1 into an impressed output current without negative feedback resistors by means of negative-feedback current transformation.

IsoAmp® 4820
converts the input current 2 : 1 into an impressed output voltage with just one precision resistor after current transformation.

IsoAmp® 3310
converts the input voltage 3 : 1 into an impressed output current with just one precision resistor after voltage transformation.

IsoAmp® 4310
converts the input voltage 1 : 1 into an impressed output voltage without negative-feedback resistors after voltage transformation.

The facts

- **Safe isolation in accordance with EN 61140**

protection of the maintenance staff and the subsequent devices against non-permitted high voltages

- **3-port isolation**

protection against incorrect measurements or damage to the measuring system due to parasitic voltages

- **Decoupled**

no load impedance effect on the signal source

- **Maximum reliability**

no maintenance work, therefore the related costs are not incurred

- **Full encapsulation**

reliable functioning also in aggressive atmospheres or with considerable mechanical loading, for example, due to vibrations

- **High accuracy**

no falsification of measured signal

- **Simple live zero/dead zero switching option**

multiple application possibilities due to optional switching of input or output 0 ... 20 mA, 4 ... 20 mA

- **5-year warranty**

Product line

Devices

Input: 0 ... 20 mA, output, 0 ... 20 mA
 Input: 0 ... 20 mA, output, 0 ... 10 V

Order no.

3820 Mh
 4820 Mh

Input: 0 ... 10 V; output, 0 ... 20 mA
 Input: 0 ... 10 V; output, 0 ... 10 V

3310 Mg
 4310 Mg

Power supply

24 V AC/DC

Options

Input 0 ... 20 mA or 4 ... 20 mA, switchable

250¹⁾

Output 0 ... 20 mA or 4 ... 20 mA, switchable

251¹⁾

1) Options 250 and 251 cannot be combined; additional error at output: ±10 µA, at Model 4820: ±10 mV

Accessories

Inspection Certificate 3.1 B according to EN 10204

ZU 0267

Inspection Certificate 3.1 B according to EN 10204, with description and results from inspections

ZU 0202

Selection aid for modules and options

		Output		
		0 ... 20 mA	0...20 mA/4...20 mA ²⁾	0 ... 10 V
Input	0 ... 20 mA	3820 Mh	3820 Mh Opt. 251	4820 Mh
	0/4 ... 20 mA ²⁾	3820 Mh Opt. 250	3820 Mh ³⁾	4820 Mh Opt. 250
	0 ... 10 V	3310 Mg	3310 Mg Opt. 251	4310 Mg

2) Switchable

3) Transmission 1:1

Specifications

Input data	3820 Mh	4820 Mh	3310 Mg	4310 Mg
Input ¹⁾	0 ... 20 mA impressed current Opt. 250: 0/4 ... 20 mA switchable ²⁾		0 ... 10 V	
Input resistance	–		>5 MOhms	>2 MOhms
Input voltage drop	Approx. 100 mV With open output: approx. 750 mV Upon power failure: approx. 750 mV	Approx. 150 mV Upon power failure: approx. 750 mV	–	
Offset current ³⁾	–		< 500 nA ± 10 nA/K	< 1 µA ± 10 nA/K
Overload	≤ 300 mA Limitation to 750 mV with diode		≤ 100 mA Limitation to 13 V with suppressor diode	
Output data	3820 Mh	4820 Mh	3310 Mg	4310 Mg
Output ¹⁾	0 ... 20 mA, 14 V ⁴⁾ Opt. 251: 0/4 ... 20 mA switchable ²⁾	0 ... 10 V, 10 mA	0 ... 20 mA, 10 V Opt. 251: 0/4 ... 20 mA switchable ²⁾	0 ... 10 V, 20 mA
Offset	< 2 µA	< 2 mV	< 5 µA	< 2 mV
Residual ripple	< 10 mV _{pp}			
Transmission error	0.01 % meas. val.	0.1 % meas. val.	0.1 % meas. val.	0.02 % meas. val.
Cut-off frequency	5 kHz –3 dB	10 kHz –3 dB/ $V_O \leq 3 V_{pp}$ 3 kHz –3 dB/ $V_O \leq 10 V_{pp}$	10 kHz –3 dB	10 kHz –3 dB/ $V_O \leq 3 V_{pp}$ 3 kHz –3 dB/ $V_O \leq 10 V_{pp}$
Temperature coefficient ³⁾	< 10 nA/K	< 40 µV/K 0.0025 %/K meas. val.	< 100 nA/K	< 40 µV/K 0.0025 %/K meas. val.
Power supply				
Power supply	24 V AC/DC	AC: –15 % +10 %, 48 ... 500 Hz, approx. 1.3 VA DC: –15 % +20 %, approx. 0.6 VA		

1) Transmission of negative measuring signals up to approx. –3 % of the full scale

2) Options 250 and 251 cannot be combined

3) Reference temperature for TC specifications: 23 °C

4) Options 250 and 251: 12 V

Specifications, continued

Isolation

Galvanic isolation	3-port isolation between input, output and power supply
Test voltage	4 kV AC (input/output/power supply)
Working voltages (basic isolation)	1000 V DC with overvoltage category II and pollution degree 3 according to EN 61010-1. For applications with high working voltages, you should ensure there is sufficient spacing or isolation from neighboring devices and protection against electrical shocks.
Protection against electrical shock	Safe isolation according to EN 61140 by reinforced insulation according to EN 61010-1. For applications with high working voltages, you should ensure there is sufficient spacing or isolation from neighboring devices and protection against electrical shocks.

Standards and approvals

Surge withstand	5 kV 1.2/50 µs according to IEC 255-4
EMC	EMC directive 89/336/EEC ⁵⁾

Other data

Ambient temperature	Operation: -10 ... +70 °C Transport and storage: -30 ... +80 °C
Version	Height: Module Mg (Models 3310/4310): 19 mm, Module Mh (Models 3820/4820): 15.9 mm See dimension drawings for further measurements
Weight	Approx. 45 g

⁵⁾ Deviations are possible while there is interference

Schematic diagrams

Model 3820

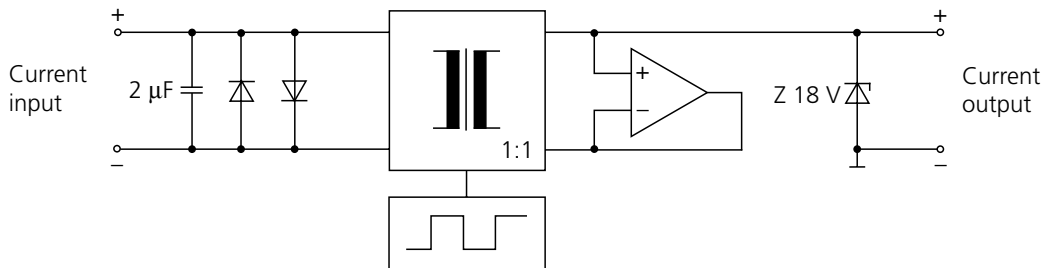

Model 4820

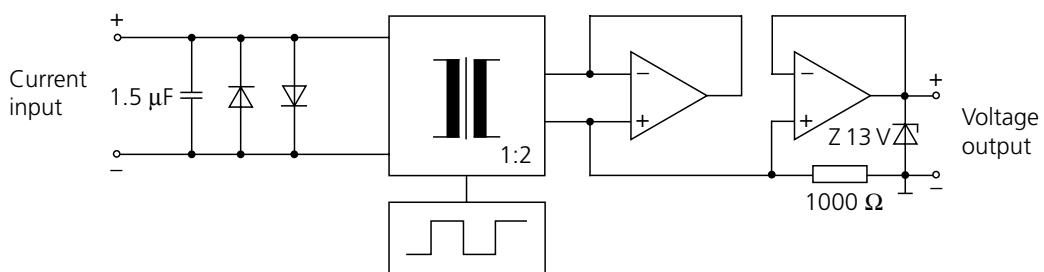

Model 3310

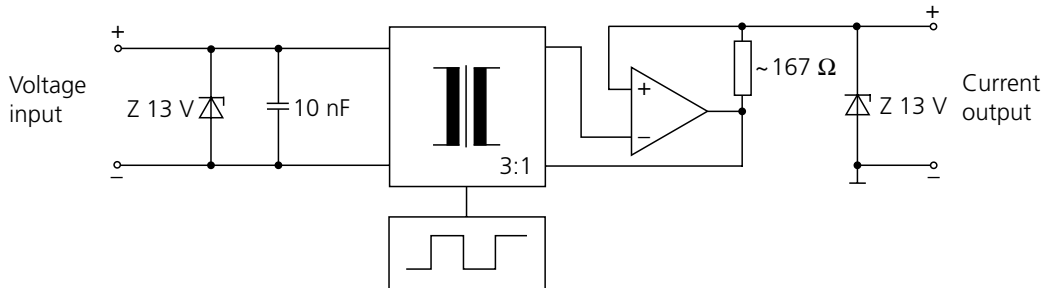

Model 4310

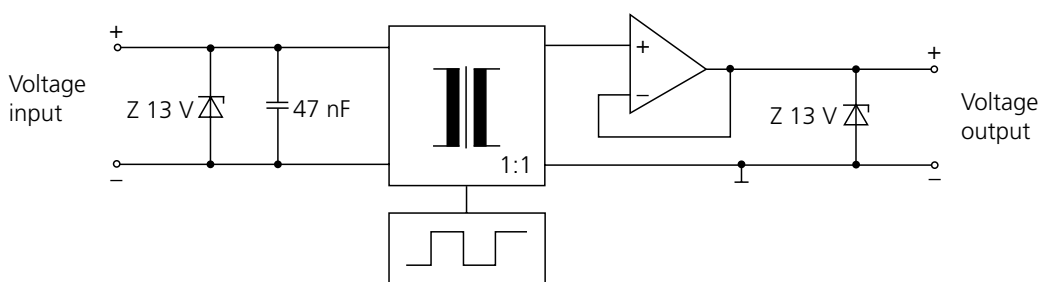

Dimension drawings and pin assignment

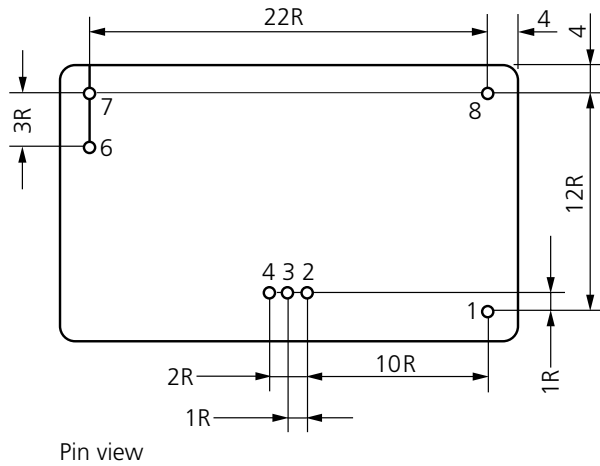

- 1 Power supply +
 - 2 Output +
 - 3 Output +, jumper
 - 4 Output -, jumper
 - 6 Input -
 - 7 Input +
 - 8 Power supply -
- R = spacing = 2.54 mm

	Mg	Mh
A	19	15.9
B	Appr. 6.8	Appr. 9.8

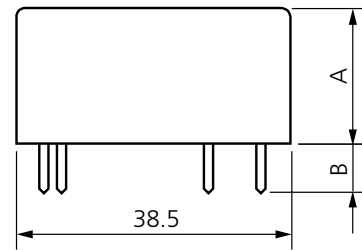
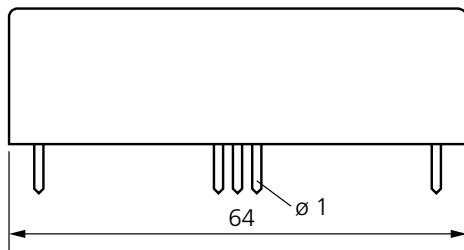

All dimensions in mm.

Terminal assignments of Options 250 or 251

Model	Option	Input *)	Output	Output connection	Jumper (output)
3820	250	0 ... 20 mA	0 ... 20 mA	2-4	
		4 ... 20 mA	0 ... 20 mA	2-4	3-4
3820	251	0 ... 20 mA	0 ... 20 mA	2-4	
		0 ... 20 mA	4 ... 20 mA	3-4	
4820	250	0 ... 20 mA	0 ... 10 V	2-4	
		4 ... 20 mA	0 ... 10 V	2-4	3-4
3310	251	0 ... 10 V	0 ... 20 mA	2-4	
		0 ... 10 V	4 ... 20 mA	3-4	

*) See dimension drawing

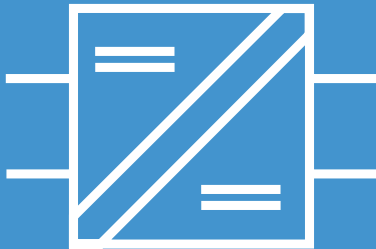

IsoTrans® 41

**For isolation of
0 ... 20 standard signals**

The task

Galvanic isolation of measured signals on circuit boards, cost cutting by means of minimum work in series production.

The problems

The application possibilities for loop-powered isolators are mainly defined by the following critical data:

- Voltage drop
- Operating current
- Accuracy
- Load voltage
- Signal delay
- Isolation voltage
- Dimensions

The solution

Knick's IsoTrans® 41 isolator has unmatched technical specifications. The isolator draws its power as voltage drop from the measured signal without influencing it noticeably. This saves on supply units and cabling and increases the reliability accordingly.

The enclosure

The full encapsulation guarantees a high level of reliability even in extreme conditions.

The advantages

The IsoTrans® 41 with a voltage drop of 1.2 V is the 1:1 isolator for all applications where loop-powered isolators are not suitable because of technical problems, for example.



The application

- Galvanic isolation
 - of input and output circuits
- of the supply voltage of 2-wire transformers
- in the case of addition or other coupling of signals on different potential
- or eliminating double ground compensation currents
- when there is an insufficient insulation and test voltage
- of high-potential signal sources
- for battery-powered devices with a central battery

The technology

Knick's IsoTrans® 41 DC isolators with transformer isolation have specifications well beyond any other loop-powered isolators. They feature a chopper generator connected in series into a current path and current conversion which gradually changes from sine to square wave over the measuring range. This avoids the accuracy-reducing power losses of normal parallel connected generators, reduces the voltage drop accordingly and also ensures accurate transmission of the smallest currents.

The facts

- **Minimum loading**
Voltage drop from 1.2 V, current transmission from 2 µA to 50 mA
- **Good signal transmission**
low signal delay
- **No power supply required**
cost saving due to lower wiring requirement, no mains influences
- **Maximum reliability**
no repair and failure costs
- **Extremely high accuracy**
- **5-year warranty**

Warranty
5 years!

Defects occurring within 5 years from delivery are remedied free of charge at our plant (carriage and insurance paid by sender).

Product line

Devices

IsoTrans® 41

Order no.

41 Mi

Power supply

None, supply from input signal

Specifications

Input data

Input 0 ... 20 mA
0 ... 50 mA

Operating current <2 μ A

Overload 100 mA, 20 V (see also page 229)

Voltage drop Approx. 1.2 V (20 mA)
Approx. 1.6 V (50 mA)

Output data

Output 0 ... 20 mA/max. 15 V (corresponds to 750 Ohm load)
0 ... 50 mA/max. 15 V (corresponds to 300 Ohm load)

Load error <0.02 % meas. val. per 100 Ohm

Offset <5 μ A

Residual ripple¹⁾ < 1.5 mV_{pp}/mA

Transmission behavior

Transformation error²⁾ 0.02 % meas. val.

Rise or fall time Approx. 2.5 ms at 500 Ohm load resistance

Isolation

Test voltage 2.5 kV AC

Working voltages (basic isolation) 500 V DC with overvoltage category II and pollution degree 4 according to EN 61010-1.
For applications with high working voltages, you should ensure there is sufficient spacing or isolation from neighboring devices and protection against electrical shocks.

1) Slightly increased residual ripple can occur when load < 5 Ohms

2) Temperature range -10 ... +70 °C

Specifications, continued

Standards and approvals

Surge withstand	5 kV 1.2/50 μ s according to IEC 255-4
Immunity to ESD	8 kV according to IEC 801-2

Other data

Ambient temperature	-25 ... +80 °C
Version	Module Mi height 16 mm, see also dimension drawings

Transfer functions

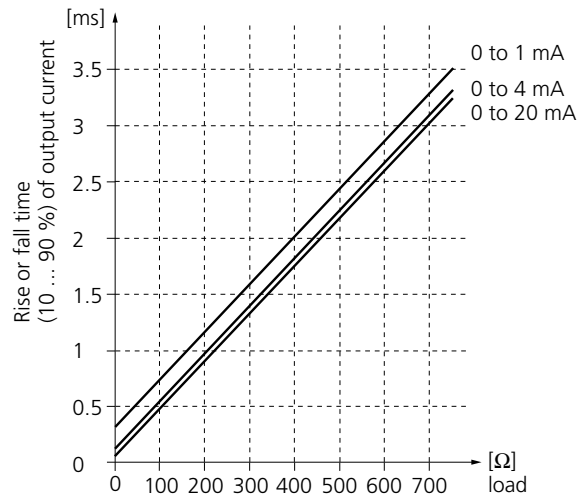
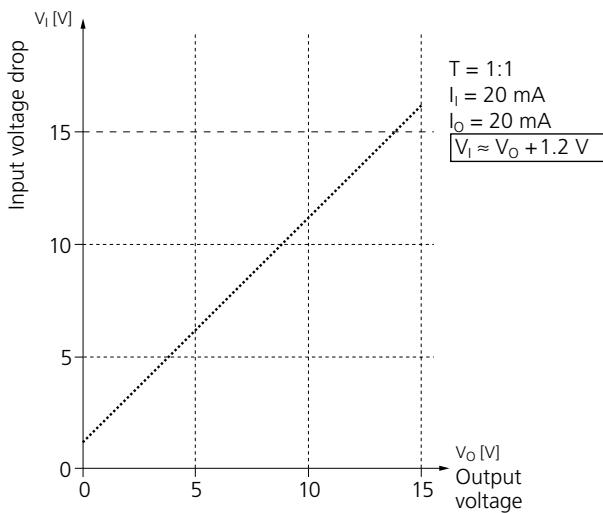

Schematic diagram

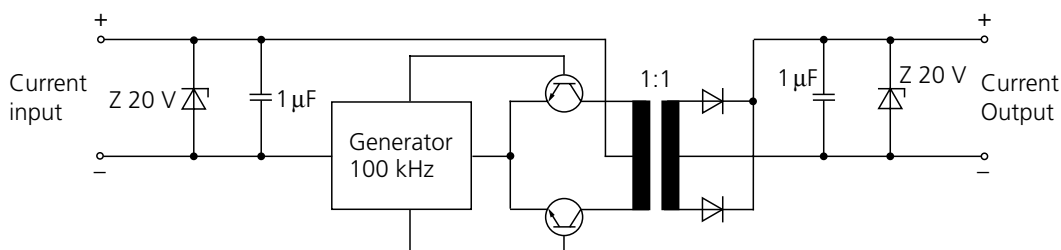

Application examples

Electrical isolation

With impressed current, current output

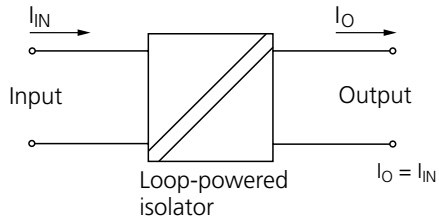

Electrical isolation

With impressed input current, current output

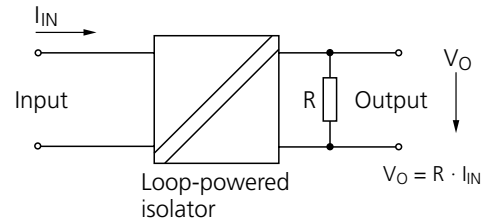

Electrical isolation

in two-wire technology

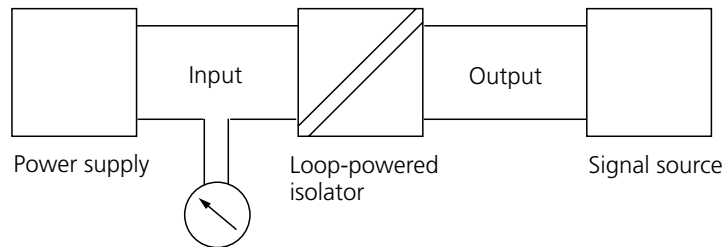

Electrical isolation

For current addition with impressed currents

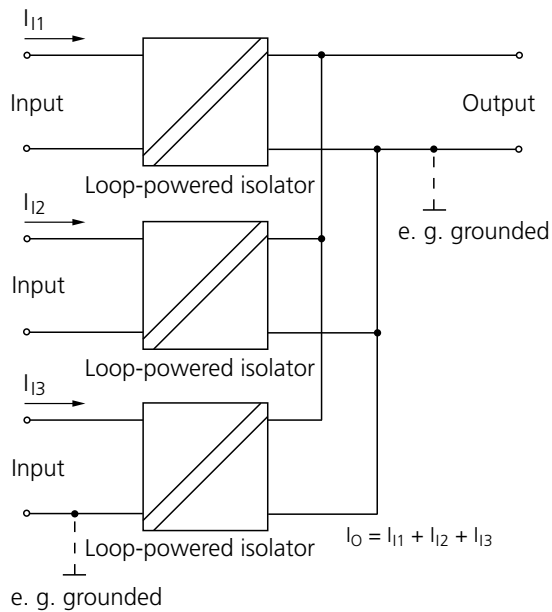

Application examples, continued

Electrical isolation

in short-circuit operation,
current output referred to ground

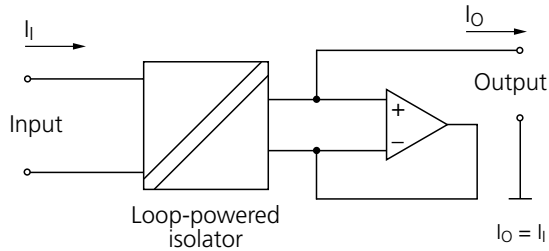

Electrical isolation

with impressed input current and low-
resistance voltage output

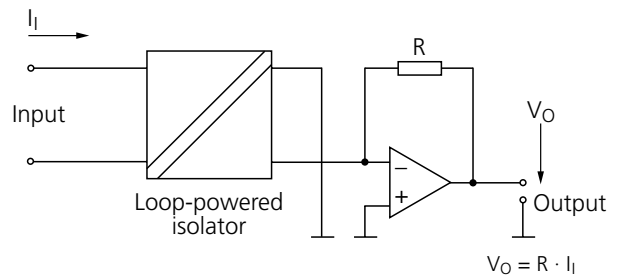

Electrical isolation

with high-resistance voltage input and
impressed output current

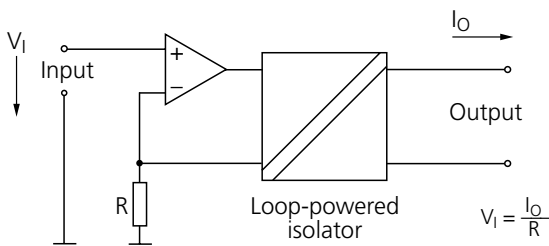

Electrical isolation

with precision full wave rectifier,
impressed input and output current

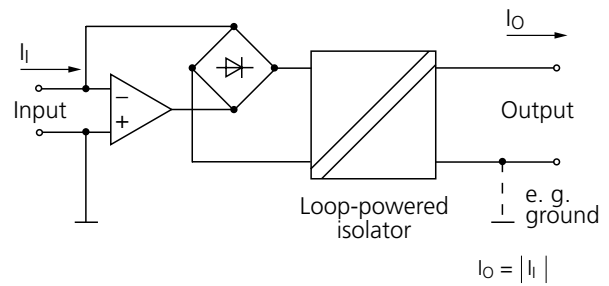

Electrical isolation

with precision rectification, high-resistance voltage
input, impressed output current

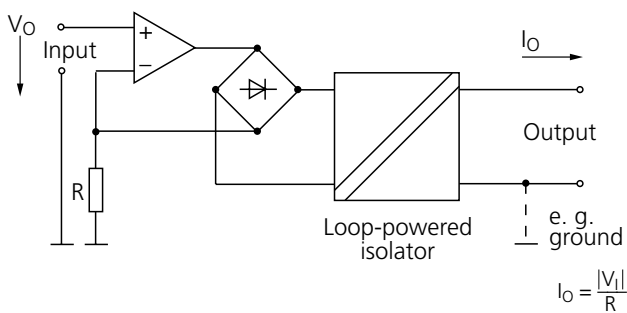

Dimension drawing and pin assignment

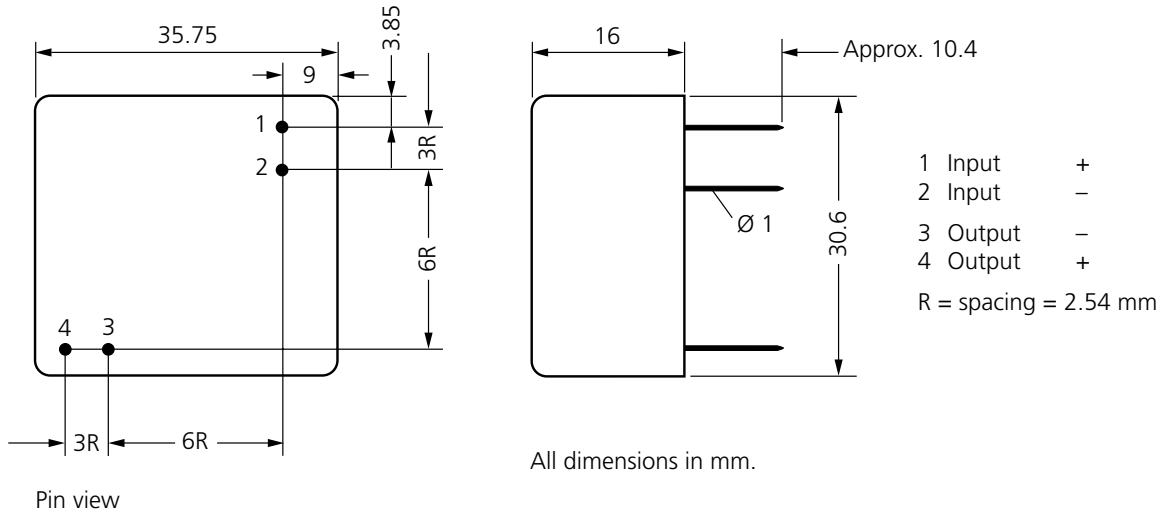

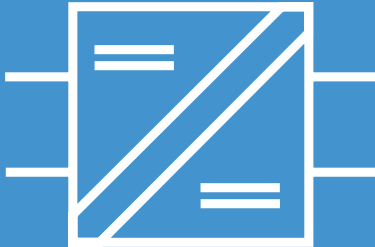

IsoTrans® 46

For isolation of 0 ... 20 standard signals

Knick has expanded its range of loop-powered isolators with the IsoTrans® 46, a competitively priced compact model with a modular design.

The IsoTrans® 46 isolates 0 ... 20 mA standard current signals avoiding parasitic voltages or currents and eliminating grounding problems. It is also optionally available with safe isolation to EN 61140.

The IsoTrans® 46 draws power as voltage drop directly from the measured signal. This saves on the costs for power supplies and cabling and increases reliability.



The facts

- **Galvanic isolation between input and output signal**
protection against measuring errors caused by grounding problems and accidental interference voltage
- **Safe isolation in accordance with EN 61140**
protection of the maintenance staff and the subsequent devices against non-permitted high voltages
- **Module mounting height 11 mm**
extremely low mounting height, mounting on Euro-card with width of just 3 TE
- **No power supply required**
cost saving due to lower wiring requirement, no mains influences
- **Maximum reliability**
no maintenance work, therefore the related costs are not incurred
- **5-year warranty**

Warranty 5 years!

Defects occurring within 5 years from delivery are remedied free of charge at our plant (carriage and insurance paid by sender).

Product line

Devices

IsoTrans® 46, module

Order no.

46 Mk

Power supply

None, supply from input signal

Options

Safe isolation to VDE 0100 Part 410, test voltage 4 kV AC

453

Specifications

Input data

Input 0 ... 20 mA¹⁾

Operating current < 20 µA

Overload 100 mA, 30 V

Voltage drop Approx. 2.5 V²⁾

Output data

Output 0 ... 20 mA, max. 27.5 V

Load error < 0.02 % meas. val. / 100 Ohms

Residual ripple < 5 mV

Transmission behavior

Transmission error < 0.1 % full scale

Rise and fall time Approx. 5 ms at 500 Ohm load

Temperature coefficient³⁾ < 0.002 %/K meas. val. per 100 Ohm load

1) Linear transmission up to 50 mA

2) Approx. 3.5 V at 50 mA

3) Average TC, reference temperature 23 °C

Specifications, continued

Isolation

Test voltage	510 V AC 4 kV AC with option 453
Working voltages (basic isolation)	150 V AC with overvoltage category I and pollution degree 4 according to EN 61010-1. Permissible working voltages for other overvoltage categories and pollution degrees and for reinforced insulation / safe isolation on request. For applications with high working voltages, you should ensure there is sufficient spacing or isolation from neighboring devices and protection against electrical shocks.
Protection against electrical shock (Opt. 453)	Safe isolation according to EN 61140 through reinforced insulation according to EN 61010-1. For applications with high working voltages, you should ensure there is sufficient spacing or isolation from neighboring devices and protection against electrical shocks.

Standards and approvals

Surge withstand according to IEC 255-4	5 kV 1.2/50 μ s (only with Opt. 453)
Surge withstand according to EN 61010-1	850 V > 6 kV with option 453
EMC ⁴⁾	According to NAMUR NE 21, EMC directive 89/336/EEC, EN 61326

Other data

Ambient temperature	Operation: -10 ... +70 °C Transport and storage: -30 ... +80 °C
Version	Module Mk, encapsulated
Weight	Approx. 13 g

4) Valid for 4 ... 20 mA, slight deviations possible during interference.

Schematic diagram

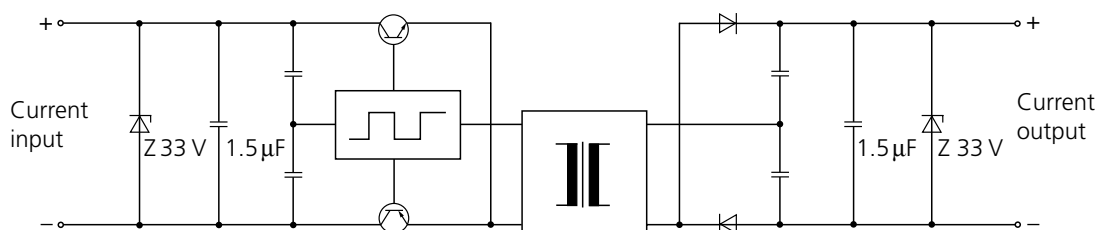

Dimension drawing and pin assignment

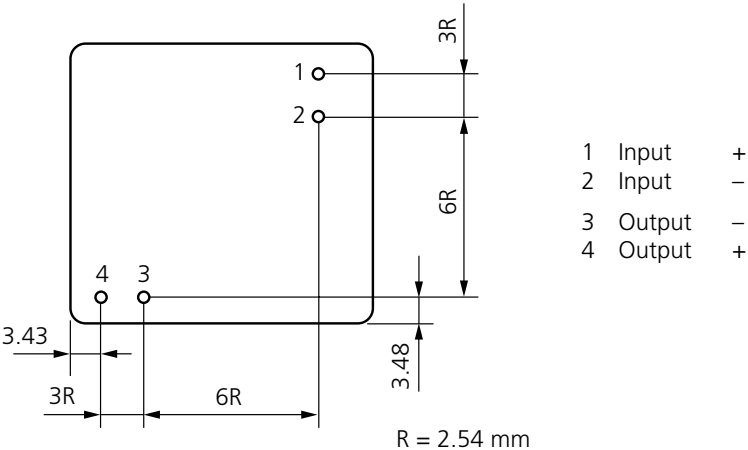

Pin view

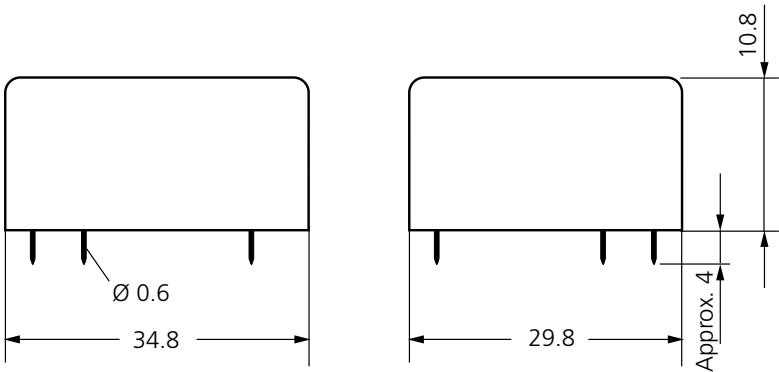

All dimensions in mm.

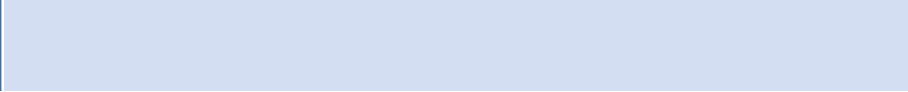

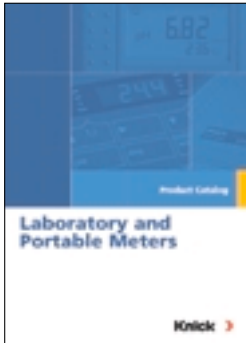

**Knick
Elektronische Messgeräte
GmbH & Co. KG**

Beuckestrasse 22, 14163 Berlin
P. O. Box 37 04 15, 14134 Berlin
Germany

Phone: +49 30-801 91-0

Fax: +49 30-801 91-200

E-Mail: knick@knick.de

Internet: www.knick.de

Knick. Always better.