

V _{RSM}	V _{RRM}	(dv/dt) _{cr}	I _{TRMS} (maximum value for continuous operation)			
	V _{DRM}		150 A			
V	V	V/μs	I _{TAV} (sin. 180; T _{case} = 85°C)			
			95 A			
500	400	500	–	–	SKKH 91/04 D	–
700	600	500	SKKT 91/06 D	SKKT 92/06 D	SKKH 91/06 D	SKKH 92/06 D
900	800	500	SKKT 91/08 D	SKKT 92/08 D	SKKH 91/08 D	SKKH 92/08 D
1300	1200	1000	SKKT 91/12 E	SKKT 92/12 E ¹⁾	SKKH 91/12 E	SKKH 92/12 E
1500	1400	1000	SKKT 91/14 E	SKKT 92/14 E ¹⁾	SKKH 91/14 E	SKKH 92/14 E
1700	1600	1000	SKKT 91/16 E	SKKT 92/16 E ¹⁾	SKKH 91/16 E	SKKH 92/16 E
1900	1800	1000	SKKT 91/18 E	SKKT 92/18 E ¹⁾	SKKH 91/18 E	SKKH 92/18 E

SEMIPACK® 1 Thyristor / Diode Modules

SKKT 91 SKKH 91
SKKT 92 SKKH 92
SKKT 92B SKMT 92²⁾
SKKL 92²⁾

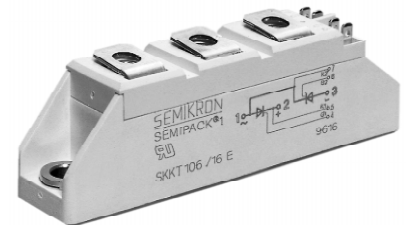

Symbol	Conditions	SKKT 91 SKKH 91	SKKT 92 SKKT 92B SKKH 92	Units
I _{TAV}	sin. 180; T _{case} = 85°C	95		A
I _D	B2/B6 T _{amb} = 45 °C; P 3/180	70 / 85		A
	T _{amb} = 35 °C; P 3/180 F	140/ 175		A
I _{RMS}	W1/W3 T _{amb} = 35 °C; P 3/180 F	190 / 3 x 135		A
I _{TSM}	T _{vj} = 25 °C; 10 ms	2 000		A
	T _{vj} = 125 °C; 10 ms	1 750		A
i ² t	T _{vj} = 25 °C; 8,3 ... 10 ms	20 000		A ² s
	T _{vj} = 125 °C; 8,3 ... 10 ms	15 000		A ² s
t _{gd}	T _{vj} = 25 °C; I _G = 1 A; di _G /dt = 1 A/μs	1		μs
t _{gr}	V _D = 0,67 · V _{DRM}	2		μs
(di/dt) _{cr}	T _{vj} = 125 °C	150		A/μs
t _q	T _{vj} = 125 °C	typ. 100		μs
I _H	T _{vj} = 25 °C; max.	250		mA
I _L	T _{vj} = 25 °C; R _G = 33 Ω; max.	600		mA
V _T	T _{vj} = 25 °C; I _T = 300 A	max. 1,65		V
V _{T(TO)}	T _{vj} = 125 °C	0,9		V
r _T	T _{vj} = 125 °C	2		mΩ
I _{DD} ; I _{RD}	T _{vj} = 125 °C; V _{RD} = V _{RRM} V _{DD} = V _{DRM}	max. 20		mA
V _{GT}	T _{vj} = 25 °C; d.c.	3		V
I _{GT}	T _{vj} = 25 °C; d.c.	150		mA
V _{GD}	T _{vj} = 125 °C; d.c.	0,25		V
I _{GD}	T _{vj} = 125 °C; d.c.	6		mA
R _{thjc}	cont. } per thyristor / sin. 180 } per module rec. 120 }	0,28 / 0,14		°C/W
		0,30 / 0,15		°C/W
		0,32 / 0,16		°C/W
R _{thch}		0,2 / 0,1		°C/W
T _{vj}		– 40 ... + 125		°C
T _{stg}		– 40 ... + 125		°C
V _{isol}	a. c. 50 Hz; r.m.s.; 1 s/1 min	3600 / 3000		V~
M ₁	to heatsink } SI (US) units	5 (44 lb. in.) ± 15 % ³⁾		Nm
M ₂	to terminals }	3 (26 lb. in.) ± 15 %		Nm
a		5 · 9,81		m/s ²
w	approx.	95		g
Case	→ page B 1 – 95	SKKT 91: A 5	SKKL 92: A 59	
		SKKH 91: A 6	SKKT 92: A 46	
		SKMT 92: A 72	SKKH 92: A 47	
			SKKT 92B: A 48	



SKKT 91 SKKH 91



SKKT 92
SKKT 92B SKKH 92



SKMT 92 SKKL 92

Features

- Heat transfer through aluminium oxide ceramic isolated metal baseplate
- Hard soldered joints for high reliability
- UL recognized, file no. E 63 532

Typical Applications

- DC motor control (e.g. for machine tools)
- AC motor soft starters
- Temperature control (e.g. for ovens, chemical processes)
- Professional light dimming (studios, theaters)

1) Also available in SKKT 92B configuration (case A 48)

2) SKKL 92, SKMT 92 available on request

3) See the assembly instructions

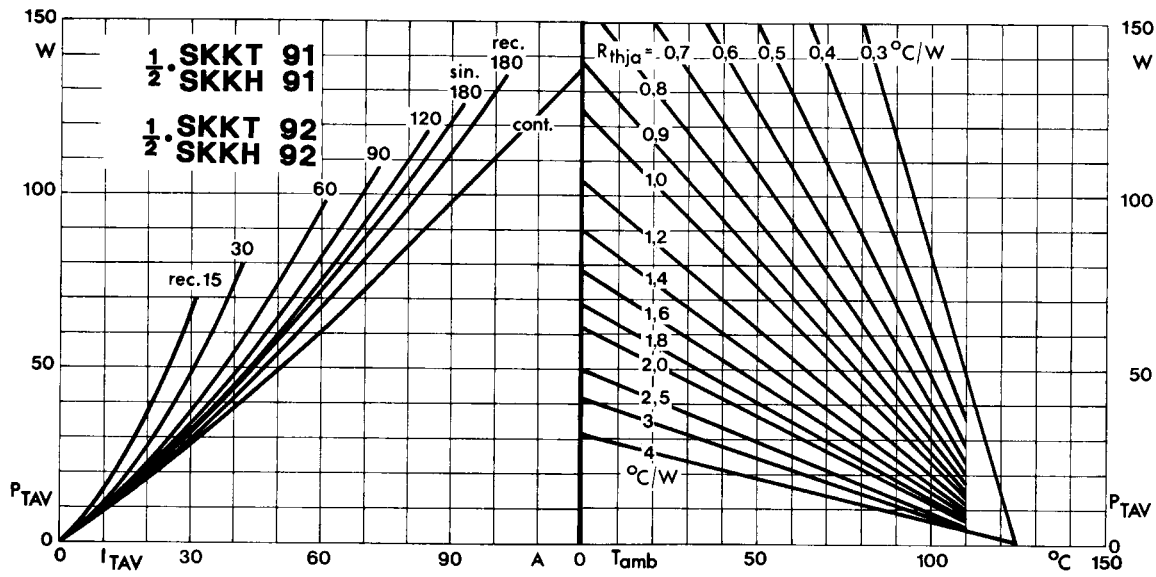

Fig. 1 Power dissipation per thyristor vs. on-state current and ambient temperature

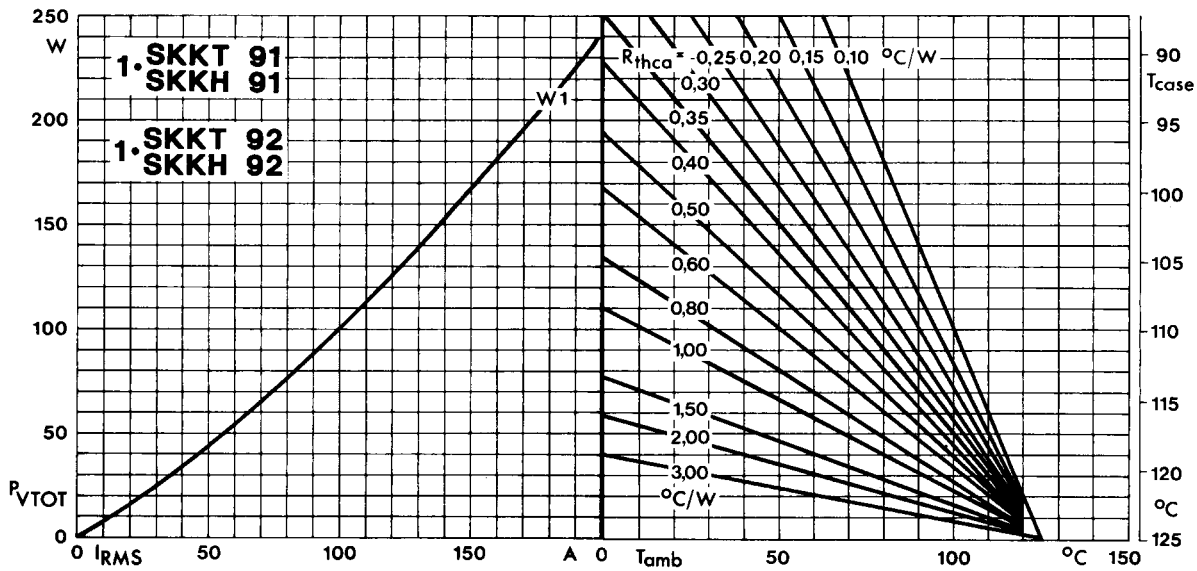

Fig. 2 Power dissipation per module vs. rms current and case temperature

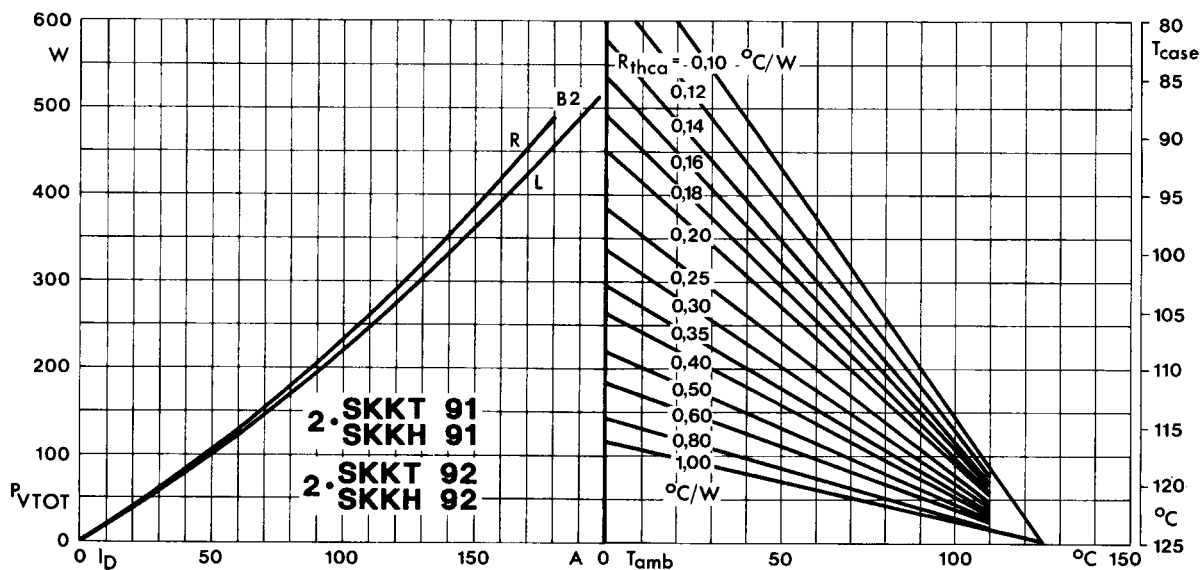

Fig. 3 Power dissipation of two modules vs. direct current and case temperature

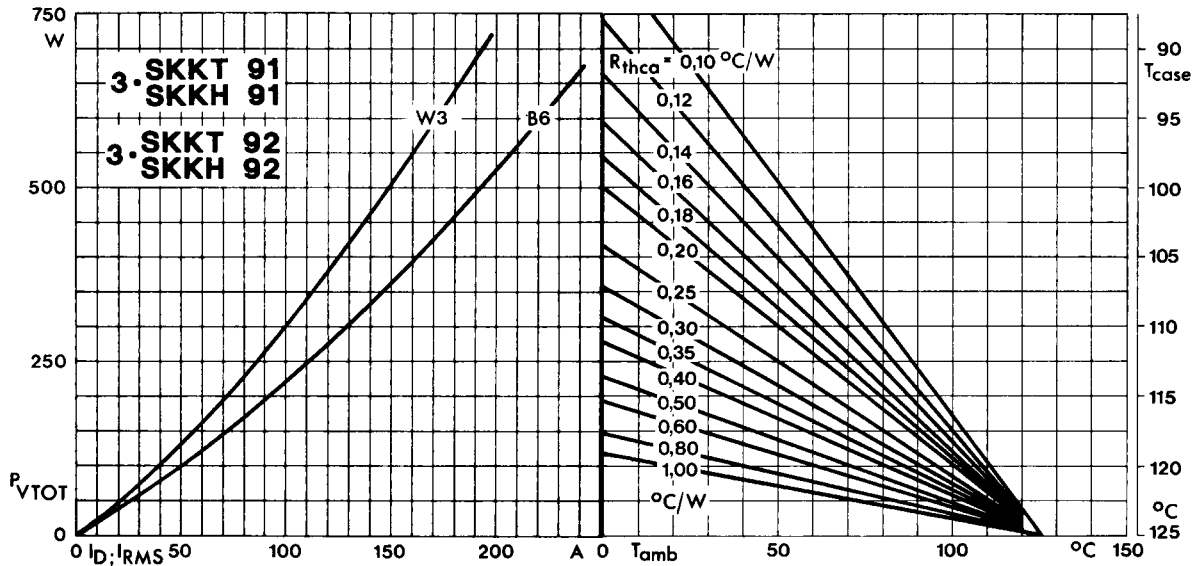

Fig. 4 Power dissipation of three modules vs. direct and rms current and case temperature

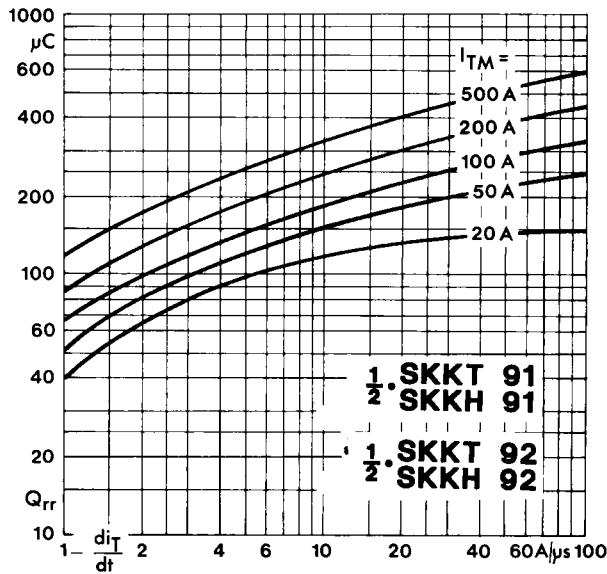

Fig. 5 Recovered charge vs. current decrease

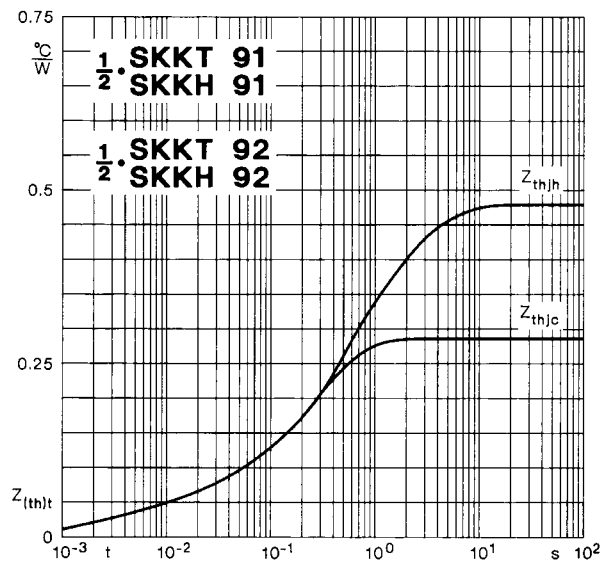

Fig. 6 Transient thermal impedance vs. time

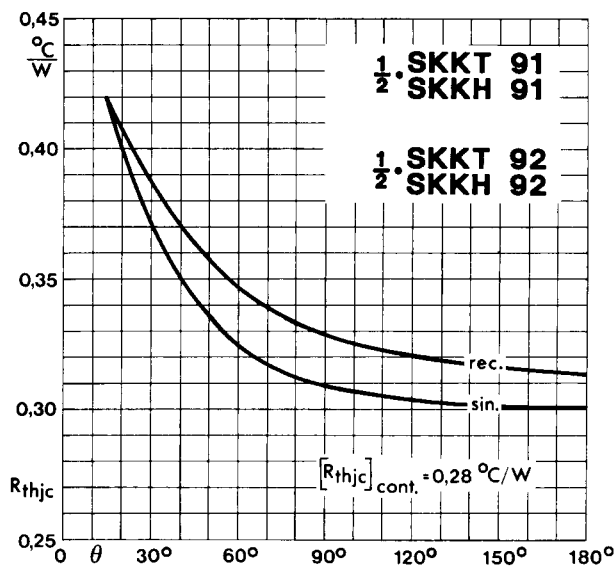

Fig. 7 Thermal resistance vs. conduction angle

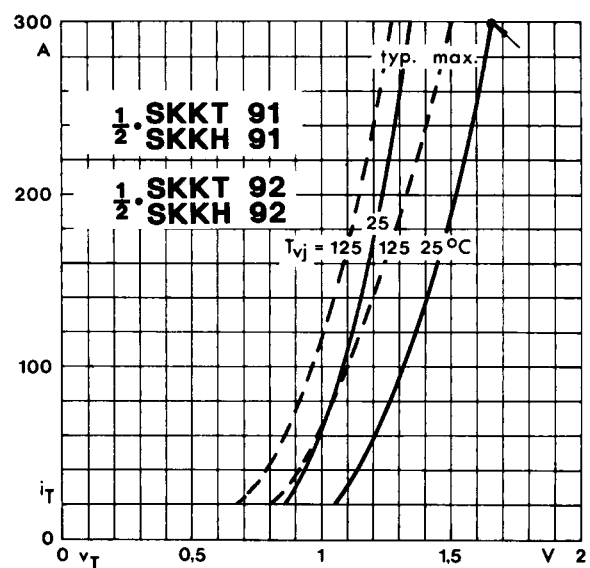

Fig. 8 On-state characteristics

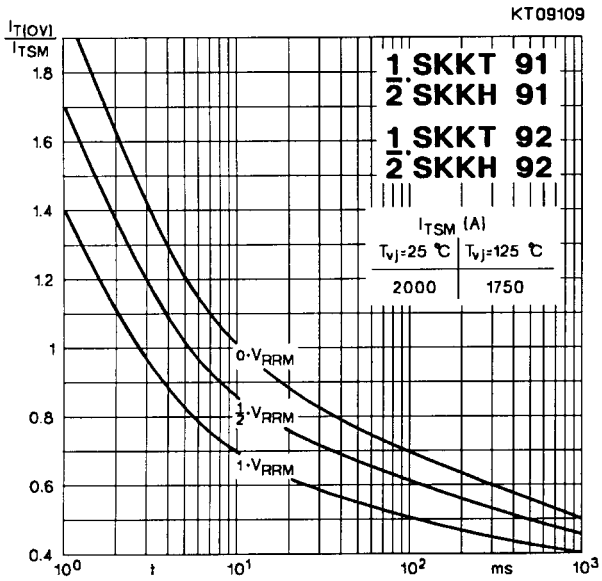

Fig. 9 Surge overload current vs. time

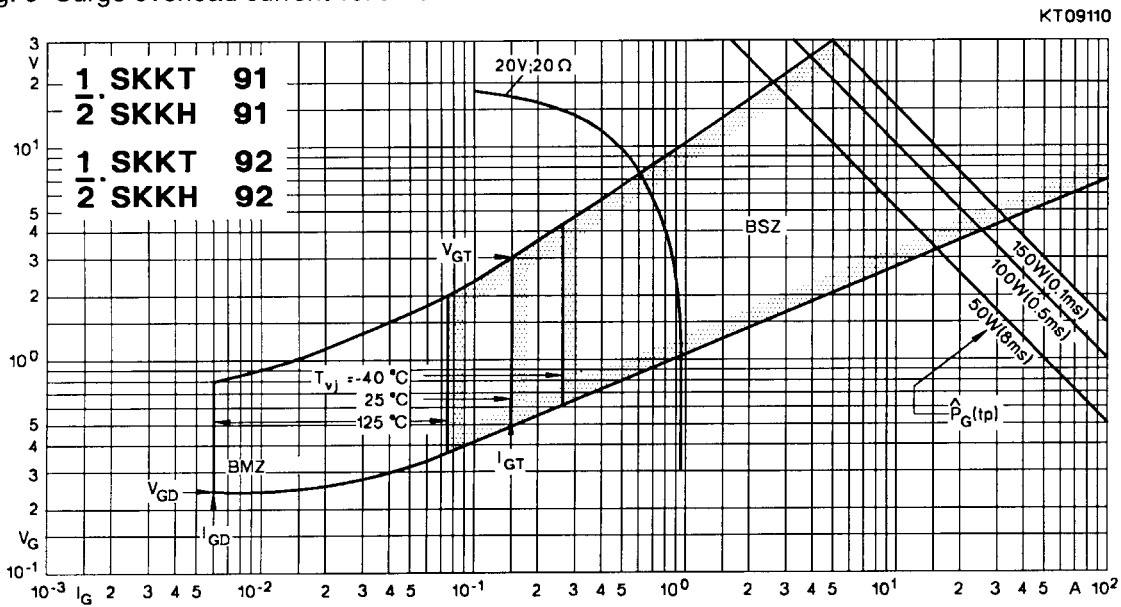

Fig. 10 Gate trigger characteristics

SKKT 19 ... 105

Case A 5

IEC 192-2: A 77 A

JEDEC: TO-240 AA

SEMIPACK® 1

UL recognized, file no. E 63 532



Dimensions in mm

SKKT 20/ ... 106/

Case A 46

IEC 192-2: A 77 A

JEDEC: TO-240 AA

SEMIPACK® 1

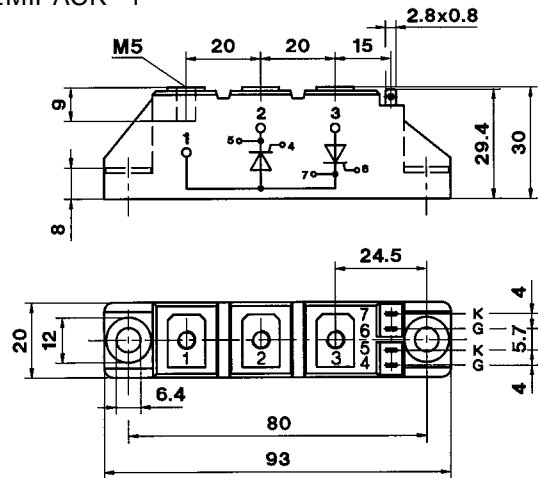

Dimensions in mm

SKKH 26 ... 105

Case A 6

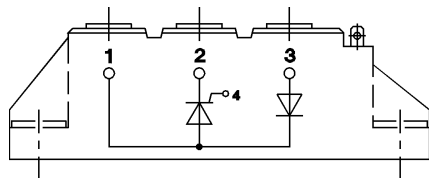

SKKD 26 ... 100

Case A 10

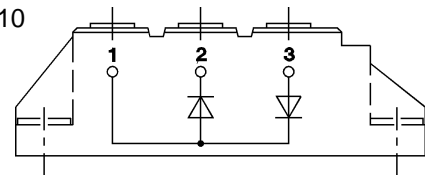

SKNH 56 ... 91

Case A 7

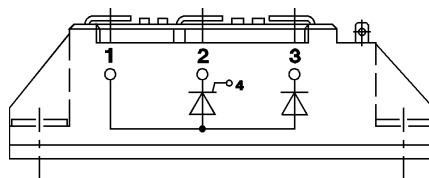

SKKE 81

Case A 12

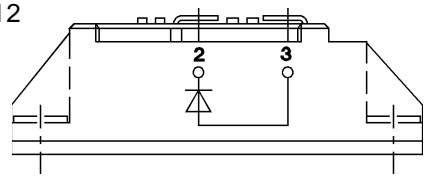

SKKL 56 ... 105

Case A 9

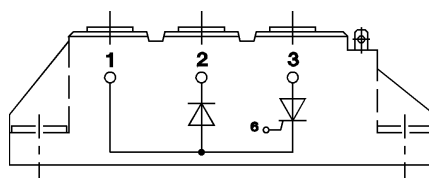

SKKH 27 ... 106

Case A 47

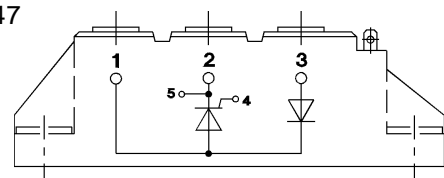

SKND 46 ... 81

Case A 19

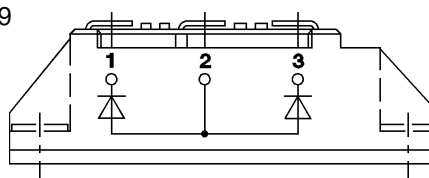

SKKT 20 B ... 106 B

Case A 48

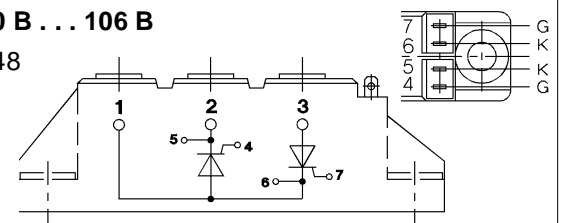

SKMT 92

Case A 72

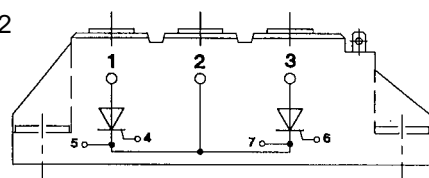

SKKL 42 ... 106

Case A 59

