

**NAiS**

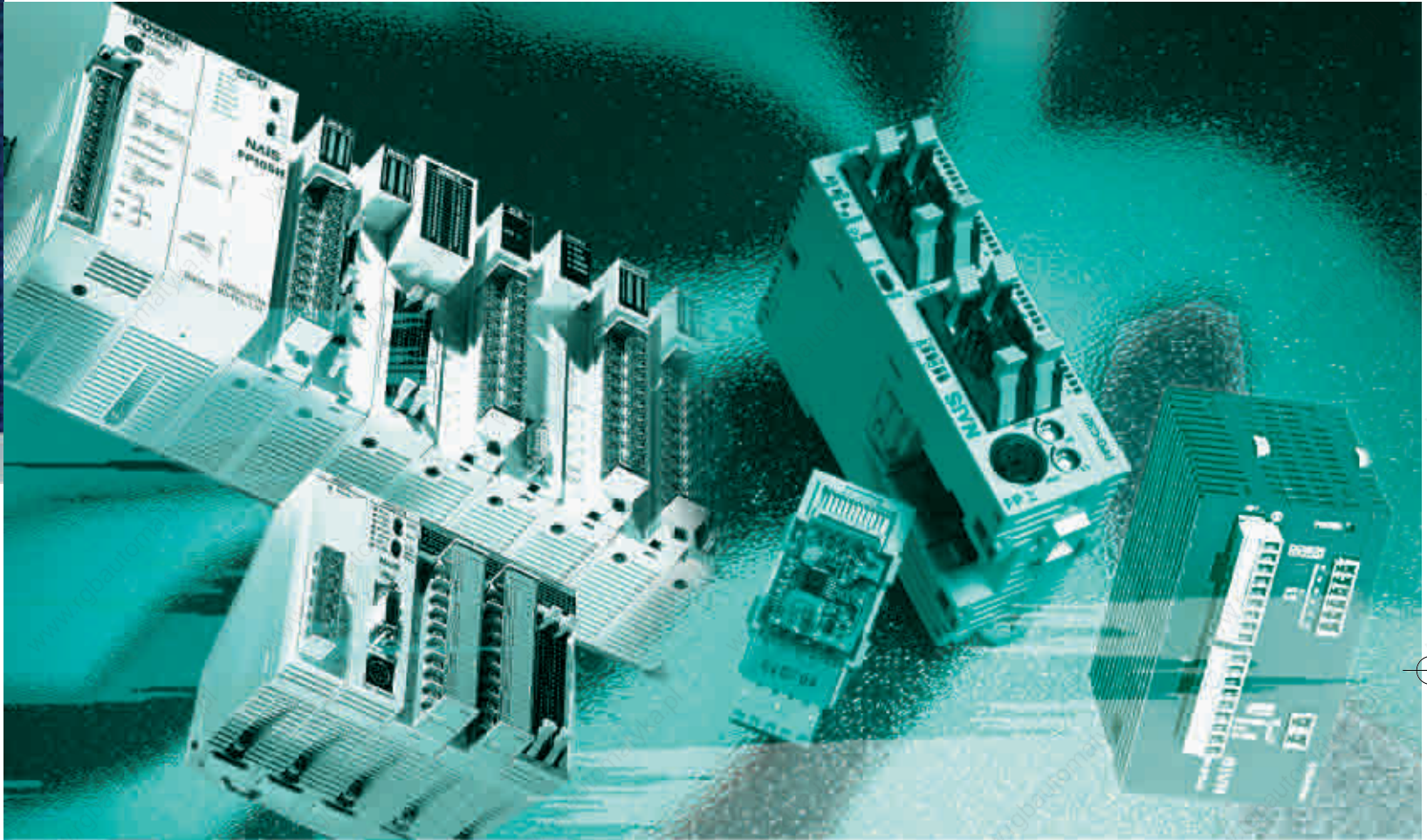

# Matsushita Programmable Logic Controllers

Smart Solutions by **NAiS**



# The Matsushita FP

## Advantages of

### Powerful Hardware Solutions

**NAIS** PLCs offer an outstanding price-performance ratio which incorporates numerous functions into a very compact body. Even in the smallest size they provide a powerful instruction set which allows the system to handle demanding tasks such as analogue control, networking and positioning control.

### Innovative Programming Software

Our PLC programming software was one of the first on the market according to the international standard IEC 61131-3. Numerous libraries that incorporate a lot of our know-how ensure the reusability of ready-made functions and function blocks and save time for programming and debugging.

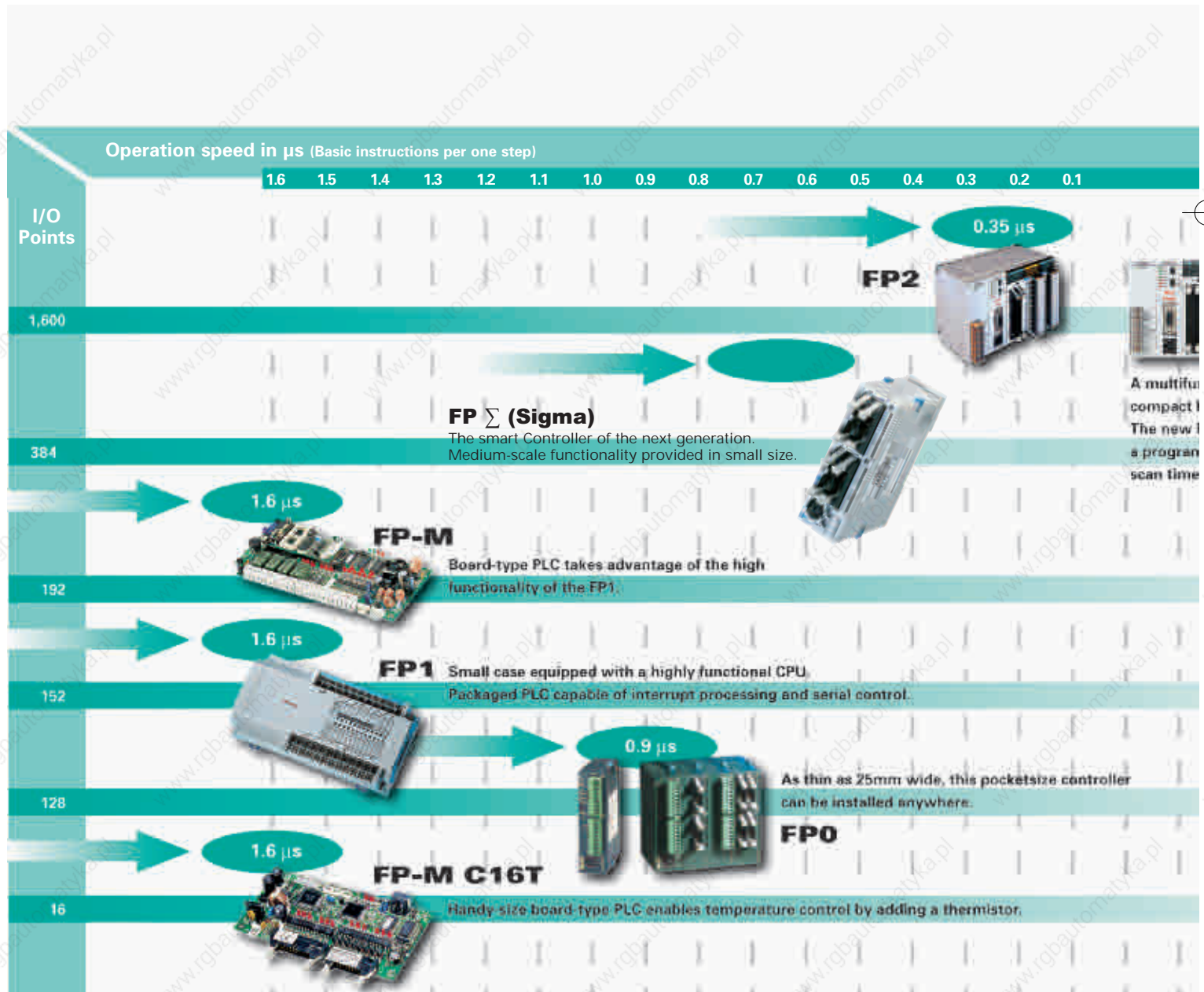

# a PLC Range

## s of PLC Control

### Long-Life Quality

As with all Matsushita products, the PLCs undergo extremely rigorous testing during development that far exceeds the demands that will actually be placed on them. This is a guaranty for the long life of the product in the application.

### Benefit from good service

In addition to a comprehensive PLC range, Matsushita also offers the high-quality care demanded from a service-oriented company certified according to ISO 9001. Highly trained application engineers can provide custom designed systems. A sales staff regularly participates in hardware and software training courses.



### Contents:

FP0 Series .....	5-9
FP $\Sigma$ (Sigma).....	10-11
Microcontroller FP-M.....	13-15
FP1 Series .....	17-19
FP2 Series .....	21-27
Networking Technology.....	28-29
FP Web-Server .....	30
FP Modem-EU.....	31
Programming Software FPWIN Pro.....	32
Programming Software FPWIN GR.....	33
PCWAY.....	34
Control CommX.....	35
G-Series Operator Terminals.....	36-37
Power Supplies.....	38

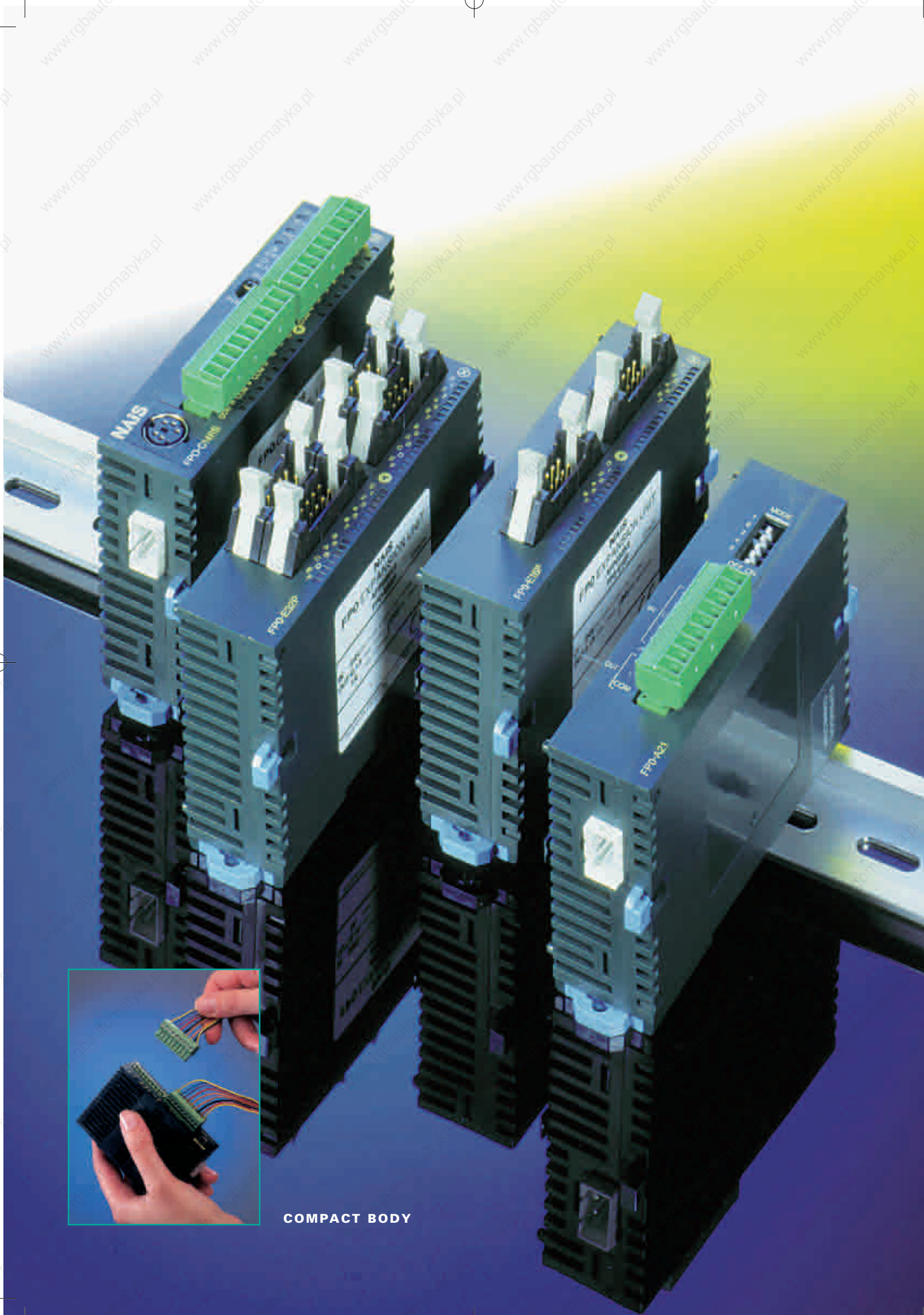

**COMPACT BODY**

# FPO Series

Incredibly small, as single or even as multiple combined units

## Perfect for small devices

The control unit's dimensions of the FPO are W25 x H90 x D60mm. With up to 3 expansion units the FPO can be expanded to a maximum of 128 points. Even so, the size is still only W105 x H90 x D60mm, a super compact design that breaks all previous common sense rules on small-scale PLCs. With the smallest-ever attachment area, the FPO is perfect for installation in machines, facilities, and control boards where miniaturization is progressing even further.

The FPO offers outstanding performance and flexibility:

- Flexible configuration from 10 I/O up to 128 I/O
- 0.9µs per step ultra fast CPU processing
- Large capacity with 2.7k, 5k and 10k memory size
- Programme memory uses EEPROM or RAM
- Analogue modules featuring 2 input and 1 output channels or 8 input channels
- A second RS232 serial port for connection to intelligent devices or modems for telemetry applications
- Built-in functions for interrupt processing, high speed counting and pulse output for axis control

### PERFORMANCE SPECIFICATIONS

PLC type	FPO-C10RS FPO-C10CRS	FPO-C14RS FPO-C14CRS	FPO-C16 P/T FPO-C16C P/T	FPO-C32 P/T FPO-C32C P/T	FPO-T32C P/T
Control method	Cyclic operation				
Inputs / outputs	total: 10 6 inputs/4 outputs	total: 14 8 inputs/6 outputs	total: 16 8 inputs/8 outputs	total: 32 16 inputs/16 outputs	total: 32 16 inputs/16 outputs
Max. inputs/outputs: same as CPU mixed (relay / transistor)	58 106	62 110	112 112	128 128	128 128
Programme memory	EEPROM (no back-up battery required)				RAM (battery backup)
Programme capacity	2,720 steps			5,000 steps	10,000 steps
Instructions	Basic 83 / High-level 111				...-level 115
Processing speed	0.9µs/step (basic instruction)				
Memory					
Internal relay (R)	1,008 points				
Timer/Counter (T/C)	144 points				
Data register (DT)	1,660 words		6,144 words		16,384 words
Master Control Relays (MCR)	32 points				
Labels (JMP + LOOP)	64			255	
Number of step ladder	128			704	
Number of subroutines	16			100	
Special functions					
High speed counter	1 phase / 4 points (10KHz) or 2 phases / 2 points (2KHz)				
Pulse output	-		2 points (output frequency up to 10KHz)		
Pulse catch input/ Interrupt input	6 inputs (catches pulses of 50µs)				
Interrupt programme	7 programmes (external 6 inputs + periodical interrupt)				
Periodical interrupt	0.5ms to 30s				
Constant scan	available				
Other functions	Run time editing, password setting				
Real Time Clock	Not available			available	

### GENERAL SPECIFICATIONS

Rated operating voltage	24VDC
Operating voltage range	21.6 to 26.4VDC
Ambient temperature	0°C to +55°C
Storage temperature	-20°C to +70°C

### INPUT SPECIFICATIONS

Input type	+/- switching
Rated input voltage	24VDC
ON voltage range	> 19.2VDC
OFF voltage range	< 2.4VDC

### OUTPUT SPECIFICATIONS - Relay

Output type	Normally open (1 form A)
Rated control capacity	2A 250VAC, 2A 30VDC

### OUTPUT SPECIFICATIONS - Transistor

Insulation method	Optical coupler
Output type	Open collector (P=PNP, T=NPN transistor)
Rated load voltage	24VDC (5 to 24VDC)
Max. load current	0.1A

# FP0 Series

A wide variety of both single and combined units

## Control Units

### Relay output type

<b>10 points</b> Input 6 points Output 4 points Terminal type	<b>10 points</b> Input 6 points Output 4 points Terminal type with 2nd RS232C	<b>14 points</b> Input 8 points Output 6 points Terminal type	<b>14 points</b> Input 8 points Output 6 points Terminal type with 2nd RS232C

### Transistor output type

<b>16 points</b> Input 8 points Output 8 points NPN output type PNP output type	<b>16 points</b> Input 8 points Output 8 points NPN output type PNP output type with 2nd RS232C	<b>32 points</b> Input 16 points Output 16 points NPN output type PNP output type	<b>32 points</b> Input 16 points Output 16 points NPN output type PNP output type with 2nd RS232C

## Control Unit 10k

### FP0-T32



This advanced FP0 CPU offers additional features:

- 10,000 steps programme memory
- Battery backed RAM
- Real-time clock
- 16,383 words data register

<b>32 points</b>	
Input 16 points	Output 16 points
PNP and NPN output type with 2nd RS232C	

## FP Memory Loader

- Read or write programs from or to a PLC
- Personal computer is not required.
- Applicable with FP0, FPΣ (Sigma), FP-M, FP2 and FP2SH



## AC Power Supply

### FP0-PSA2



Input 85 to 265VAC	Output 24DC/0.7A
Terminal type	

From 10 I/Os...

...up to 128 I/Os

The photo shows an example of expanding by adding three I/O 32-point expansion units to an I/O 32-point control unit to make a max. of 128 points.

Labels: Control unit, Expansion unit, Expansion unit, Expansion unit, input/output terminal, Tool port.

Dimensions: 25mm, 90mm, 106mm.

Hooks up by using the programming software **NAIS Control FFWIN Pro** or **FFWIN GR** and a single cable.

The photo shows an I/O 14-point control unit. This size is uniform for all except the I/O 32-point control unit.

**COM Port: 2nd RS232C Interface**  
(optional for all CPU units for serial communication)

# FP0 Series

A maximum of 3 expansion units can be added to the CPU unit

## Digital I/O Units

### Relay output type



8 points	
Input 4 points	Output 4 points
Terminal type	

#### Option:

Output 8 points

### Input only type



16 points	
Input 8 points	Output 8 points
Terminal type	



8 points	
Input 8 points	



16 points	
Input 16 points	

### Transistor output type



8 points	
Input 8 points	
NPN output type	
PNP output type	



16 points	
Input 8 points	Output 8 points
NPN output type	
PNP output type	



16 points	
Output 16 points	
NPN output type	
PNP output type	



32 points	
Input 16 points	Output 16 points
NPN output type	
PNP output type	

## Analogue I/O Units



3 points	
Input 2 points	Output 1 point
Terminal type	

- analogue input:  $\pm 10V, 0 - 5V, 0 - 20mA$
- analogue output:  $\pm 10V, 0 - 20mA$
- resolution: 12 bits



8 points	
Input 8 points	
Terminal type	

- analogue input:  $\pm 10V, \pm 100mV$
- $0 - 5V, 0 - 20mA$
- resolution: 12 bits



4 points	
Input 4 points	

- K, J, T, R type thermocouples can be used
- Resolution: 0.1 °C
- Accuracy: 0.8 °C (R type: 3 °C)
- Temperature range: -100 to 500 °C



8 points	
Input 8 points	



PROFIBUS FP0-DPS (DP Slave)	
-----------------------------	--



MEWNET-F FP0-IOL (MEWNET-F Slave)	
-----------------------------------	--



S-Link CPU FP0-SL1 (S-Link Master)	
------------------------------------	--

## Easy Expansion

The expansion unit can be attached easily without any cables.

The expansion unit can easily be attached directly to the control unit. Special expansion cables, backplanes, and so forth, are unnecessary as the expansion unit employs a stacking system that uses expansion connectors and lock levers on the surface of the unit itself.

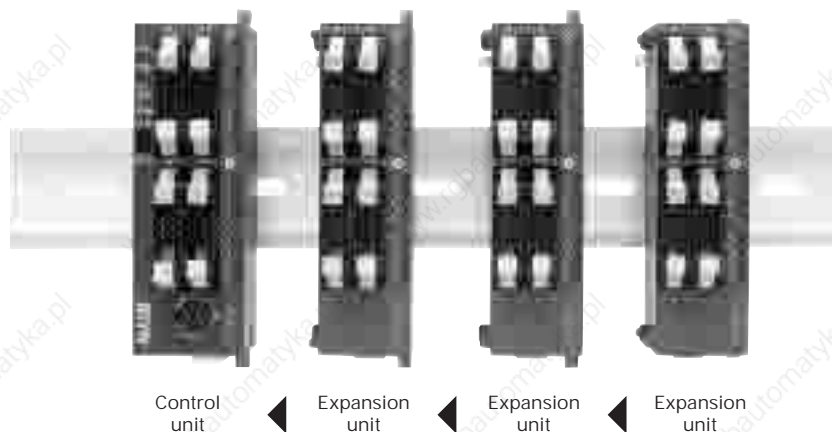

(Maximum possible expansion is with a total of three units)



# FP0 Series

## Highlights of the FP0

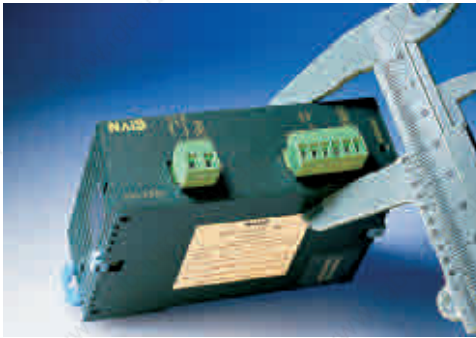

### ULTRA SMALL SIZE

The control unit measures just 25mm wide – even when fully expanded to 128 I/O points the width is only 105mm.

### INTERRUPT INPUT FUNCTION

Accurate processing unaffected by programme scan time.

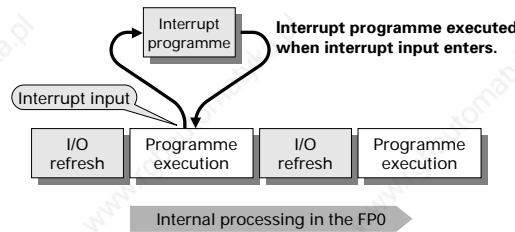

### ANALOGUE I/O FUNCTION

Analogue control is made simple with two analogue modules featuring 2 input and 1 output channels or 8 input channels. Highest performance is offered with 12-bit resolution and high-speed A/D, D/A conversion.

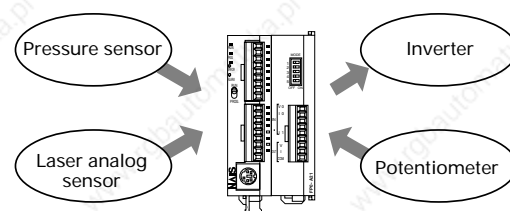

### PULSE OUTPUT AND PWM FUNCTION

The FP0 unit comes equipped with 2 channels for the output of up to 10KHz pulses. Settings for automatic trapezoid control, automatic return home position and JOG operation make 2-axis independent positioning possible. Its PWM (Pulse Width Modulation output) makes it possible to provide temperature and proportional valve control with a single compact FP0 controller.

### HIGH CAPACITY

Large capacity with 2.5k, 5k and 10k memory size. Programme memory uses EEPROM or RAM.



### HIGH-SPEED COUNTER FUNCTION

The high-speed counter has four single phase and two 2-phase channels which make the unit suitable for controlling conveyers and inverters when using an encoder. In single phase the maximum counting speed is 10KHz.



# FP0 Series

## Outstanding performance and flexibility

### SERIAL COMMUNICATION FUNCTION

Communication – simple and efficient via two serial interfaces: Tool port and COM port.

#### Tool Port

Programming and Master/Slave communication, using MEWTOCOL.COM (Matsushita protocol).

#### COM Port

Communication with different RS232C peripheral devices is possible using the COM port:

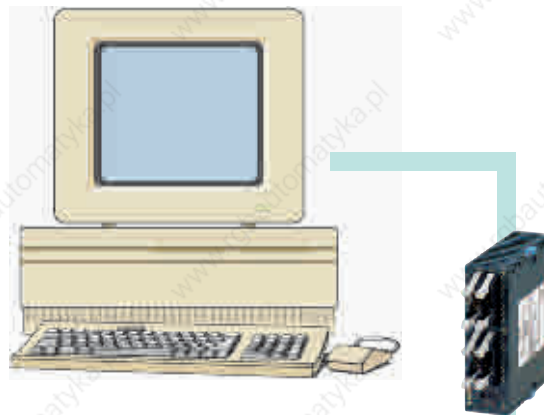

### NETWORK FUNCTIONS

#### PROFIBUS

In the PROFIBUS network the FP0 is an intelligent, remote slave and can even continue the control function safely if fieldbus communication is interrupted. The FP0 has its own powerful set of commands and operates independently.



#### S-LINK

FP0 connects directly to the S-LINK for reduced wiring and simple installation. It can control up to 128 points for S-LINK-related devices.

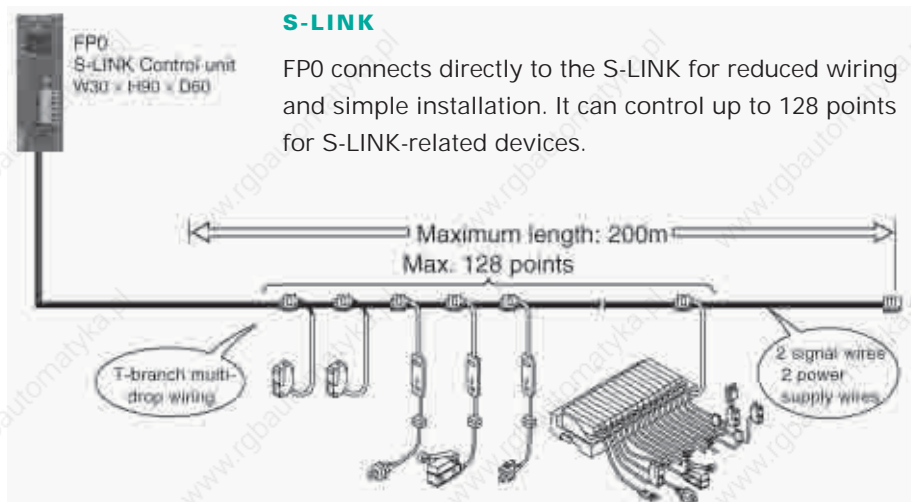



# FP $\Sigma$ (Sigma)

## The next generation compact PLC

FP  $\Sigma$  (Sigma) – The next generation's smart controller

► **HIGH PROGRAM CAPACITY**

– 12k steps

► **HIGH DATA MEMORY CAPACITY**

– 32k words

► **STRONG COMMUNICATION FEATURES**

– up to 3 serial interfaces

► **POWERFUL POSITIONING FUNCTION**

– 50 kHz high speed input

– 100 kHz pulse output

► **HIGH EXPANSION CAPABILITY**

– up to 384 I/O

► **SHORT CIRCUIT PROTECTED TRANSISTOR OUTPUTS**

– 12 points out of 16

► **2-POINT ANALOGUE VOLUME INPUT**

– NPN: 12 points out of 16

– PNP: 8 points out of 12

► **FAST PROCESSING SPEED**

– 0.4  $\mu$ s/basic instruction

► **POWERFUL INSTRUCTION SET**

► **SMALLEST SIZE**

– W 30 x H 90 x D 60 mm

**FP  $\Sigma$  (Sigma) – Transistor output type**



28 points	
Input	Output PNP
16 points	12 points
Connector type	
FPG-C28P2	



32 points	
Input	Output NPN
16 points	16 points
Connector type	
FPG-C32T2	

**FP  $\Sigma$  (Sigma) Relay output type**



24 points	
Input	Output
16 points	8 points
Terminal type	
FPG-C24R2	

**FP  $\Sigma$  (Sigma) Expansion Unit**



64 points	
Input	Output
32 points	32 points
Connector type	
FPG-XY64D2T	

### High Expansion Capability

FP  $\Sigma$  (Sigma) can use the expansion units of the FP0 on the right-hand side. New FP  $\Sigma$  (Sigma) units can be added to the left-hand side.

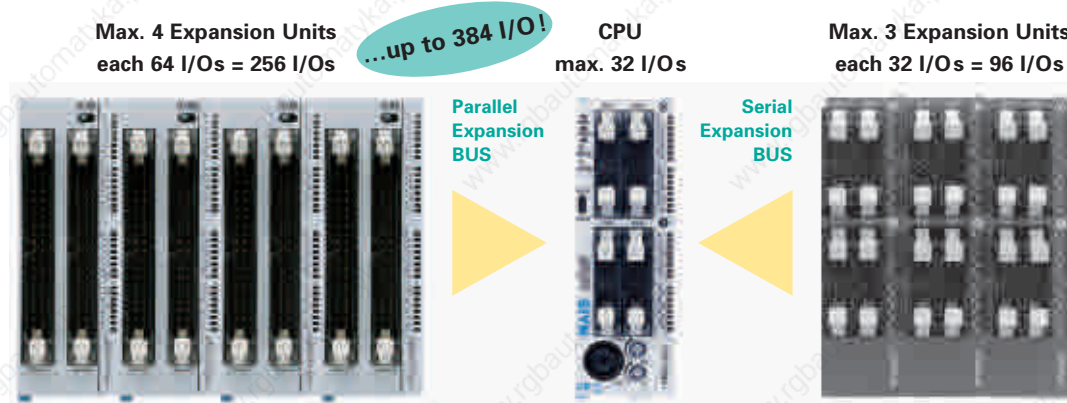

# FP $\Sigma$ (Sigma)

## Outstanding performance in a super compact design

FP  $\Sigma$  (SIGMA) – Strong in communication and positioning

### Optimised Communication Functions

- 3 choices of communication cassettes.

#### 1-channel RS232C type

Ability to connect with low-cost serial devices. RS-CS signals can be used for control.

#### 2-channel RS232C type

Effective connection with multiple serial devices including operation display panels and image-processing devices.

#### 1-channel RS485 type

Realise reduced wiring to powerful PLC links or devices that have an RS485 interface.

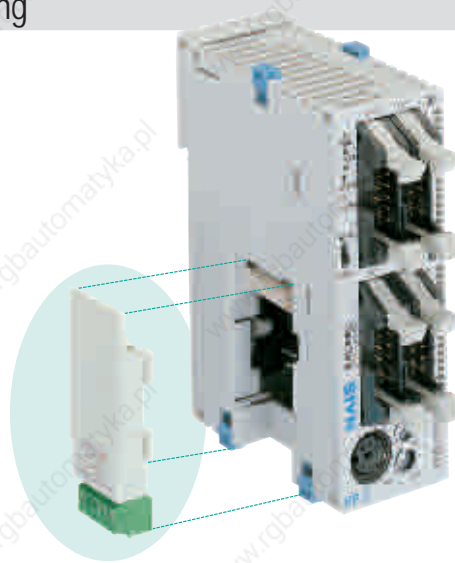

### Optimised Analog Control

- Functions and instructions convenient for temperature control are built in.

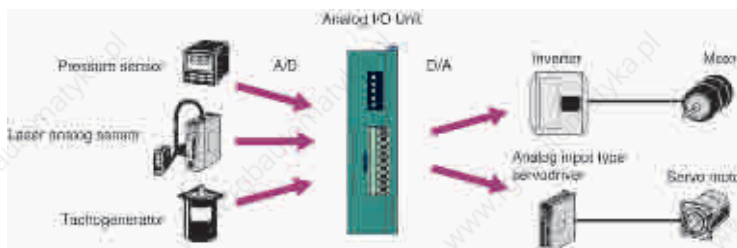

### Large Memory Capacity

- One unit can store up to 256k words data
- Up to 4 units can be added to the CPU unit enabling up to 1024k words of data to be stored
- Backup battery ensures that data stored will be available for a long time



**FP  $\Sigma$  (Sigma)  
Memory expansion unit**

FPG-EM1

### Optimised Positioning Functions

- Pulse Output Max. 100 kHz
- Rapid 0.02 ms start
- Linear and circular interpolation enable simultaneous control in two axes.
- Smooth acceleration/deceleration

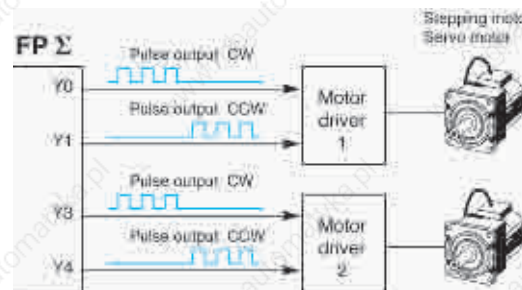

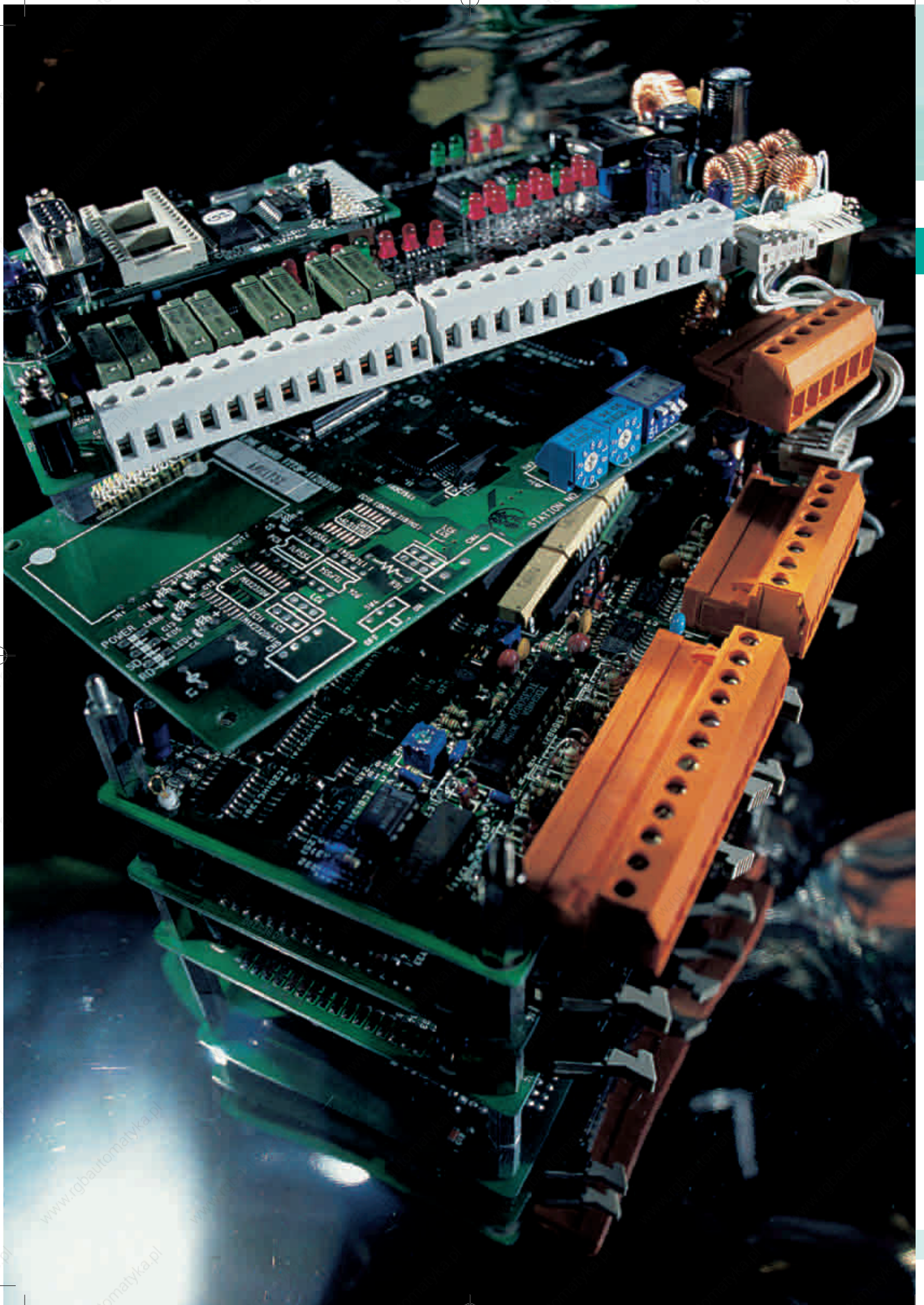

# FP-M Microcontroller

## Board type PLCs offer new solutions

Succeeding the advanced functions of the FP1 programmable controller, FP-M is designed to meet machine building applications. Incorporating features such as high-speed counter, pulse catch input, password setting, potentiometer inputs, input time filtering etc. as standard. Designed to meet applications today and tomorrow, the FP-M offers expandability and advanced functions with superbly integrated communication capability minimizing the complexity and bulk of add-on upgrade components.

### The powerful FP-M CPU:

- 1.6 $\mu$ s processing speed per logic instruction
- Pulse catch function for 500 $\mu$ s pulses
- 8 interrupt inputs and time interrupt
- High speed counter up to 10KHz
- Pulse output up to 5KHz
- Serial RS232C interface available for communicating with barcode readers / operating devices
- Realtime clock
- 2 analogue value adjusters for timer or variable data register
- Computer communication and networking capability

### Compatible with FP series:

- Command set identical with other FP Series
- Programmable with IBM-AT-compatible PC and NAIS Control FPWIN Pro/GR

### Various expansion options:

- Vertical, space-saving expansion
- Expansion facility for up to 192 inputs / outputs
- Many different expansion boards to allow individual system configuration

### Simple connection:

- Rapid wiring using ribbon connectors – makes servicing simple
- 24VDC or 12VDC power supply



FP-Microcontroller C20R with 12 inputs and 8 relay outputs (2A/220VAC)



FP-Microcontroller C16T with 8 inputs and 8 transistor outputs (not expandable!)



FP-Microcontroller C20T with 12 inputs and 8 transistor outputs



FP-Microcontroller C32T with 16 inputs and 16 transistor outputs



# FP-M Microcontroller

## Expansion options



### Expansion Options

A large selection of expansion boards permit individual system configuration. A maximum of 4 expansion boards are possible. This means that, for example, up to 192 digital I/Os or 20 analogue I/Os can be configured.

**C-NET adapter Slave (S2 type), up to 32 stations in multidrop to RS 485**

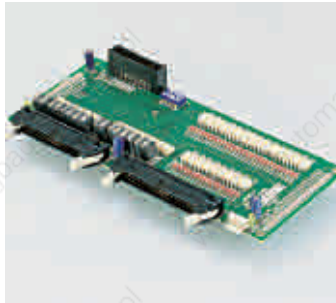

**Input output board**  
24 inputs,  
16 transistor outputs, 0.8A



**Input board**  
36 inputs



**Output board**  
32 transistor outputs 0.8A



**Analogue I/O board**  
4 inputs/1 output, 8bit resolution



**Analogue input board**  
4 inputs, 10bit resolution



**Analogue output board**  
2 outputs, 10bit resolution



**Relay expansion board**  
12 inputs, 8 relay outputs, 2.0A



**MEWNET-F**  
I/O link board  
for networking with RS485



**High speed counter board**  
2 inputs, up to 20KHz

# FP-M Microcontroller

## Specifications

<b>PERFORMANCE SPECIFICATIONS</b>				
PLC type	FPM C20R (relay) FPM C20CR	FPM C20T (trans.) FPM C20CT	FPM C32T (trans.) FPM C32CT	FPM C16T (transistor)
Control method	Cyclic operation			
Inputs / outputs	total: 20 12 inputs/8 outputs		total: 32 16 inputs/16 outputs	total: 16 8 inputs/8 outputs
Max. inputs/outputs:	180		192	16
Programme memory	built-in ROM (EPROM and EEPROM optional)			
Programme capacity	std. types 2,720 steps, C-types 5,000 steps		900 steps	
Instructions Basic/High-level	81 / 111		43 / 71	
Processing speed	1.6µs/step (basic instruction)			
Memory				
Internal relay (R)	1,008 points		256 points	
Timer/Counter (T/C)	144 points		128 points	
Data register (DT)	std. types 1,660 words, C-types 6,144 words		256 words	
Master Control Relays (MCR)	32 points		16 points	
Labels (JMP + LOOP)	64		32	
Number of step ladder	128		64	
Number of subroutines	16		8	
Special functions				
High speed counter	1 phase / 1 point (10KHz) or 2 phases / 1 point (5KHz)			
Pulse output	2 points (output frequency up to 5KHz)		1 point	
Pulse catch input/ Interrupt input	8 inputs (catches pulses of 500µs)		4 inputs	
Interrupt programme	8 inputs (for pulses of 200µs)		2 inputs	
Periodical interrupt	9 programmes (external 8 inputs + periodical interrupt)		2 programmes	
Constant scan	10ms to 30s		no	
Other functions	available password setting			

### GENERAL SPECIFICATIONS

Rated operating voltage	24VDC
also available	12VDC
Operating voltage range	21.6 to 26.4VDC
also available	10.8 to 13.2VDC
Ambient temperature	0°C to +55°C
Storage temperature	-20°C to +70°C

### INPUT SPECIFICATIONS

Input type +/- switching	
Rated input voltage	24VDC
also available	12VDC
ON voltage range	> 19.2VDC
also available	> 9.6VDC
OFF voltage range	< 2.4VDC
also available	< 1.2VDC

### OUTPUT SPECIFICATIONS - Relay

Output type	Normally open (1 form A)
Rated control capacity	2A 250VAC, 2A 30VDC

### OUTPUT SPECIFICATIONS - Transistor

Insulation method	Optical coupler
Output type	Open collector (PNP or NPN transistor)
Rated load voltage	24VDC (for 12V types: 12VDC)
Max. load current	0.8A (for 12V types: 0.8A)



MEWNET TR sensor/actuator bus (master board and slave terminals)





# FP1 Series

## More intelligence in the smallest space

Even in applications with up to 14 inputs/outputs, the FP1 series offers a variety of options for automating processes rapidly and reliably. With its compact design, it takes up the smallest space. "Mobile" use (in transportation systems etc) is also possible, thanks to the 24VDC power supply. The FP1 is therefore not just an intelligent alternative to simple relay or contactor circuits, but a complete control system that, owing to its efficiency and simplicity of use, contributes to a logical reduction in costs.

Some common-features data:

- **Processing rate of 1.6µs per logic instruction**
- **32bit word processing**
- **Up to 16 freely programmable sub-programmes**
- **RS422 interface / RS232C interface (C24 upwards)**
- **Super visory remote control and diagnosis**
- **Plug-in screw terminal strips (C24 upwards)**
- **Pulse catch inputs from 500µs upwards**
- **Pulse output**
- **DIN busbar assembly**
- **Universal power supply AC or DC**
- **IEC61131: 5 languages**
- **Networking capability with larger PLC systems – FP3 / FP10SH**
- **Different analogue modules available to solve your control task**

### PERFORMANCE SPECIFICATIONS

PLC type	FP1-C14	FP1-C16	FP1-C24	FP1-C40	FP1-C56	FP1-C72
Control method	Cyclic operation					
Inputs / outputs	total: 14 8 / 6	total: 16 8 / 8	total: 24 16 / 8	total: 40 24 / 16	total: 56 32 / 24	total: 72 40 / 32
Max. inputs/outputs:	54	56	104	120	136	152
Programme memory	EEPROM (no battery required) built in ROM (EPROM and EEPROM optional)					
Programme capacity	900 steps		2,720 steps		5,000 steps	
Instructions	41 / 85		80 / 111		81 / 111	
Processing speed	1.6µs/step (basic instruction)					
Memory						
Internal relay (R)	256 points			1,008 points		
Timer/Counter (T/C)	128 points			144 points		
Data register (DT)	256 words			1,660 words		6,144 words
Master Control Relays (MCR)	16 points			32 points		
Labels (JMP + LOOP)	32 labels			64 labels		
Number of step ladder	64			128		
Number of subroutines	8			16		
Special functions						
High speed counter	1 phase / 1 point (10KHz) or 2 phases / 1 point (5KHz)					
Pulse output	1 point (output frequency up to 4.9KHz)			2 points (up to 4.9KHz)		
Pulse catch input/	4 inputs (500µs)			8 inputs (catches pulses of 500µs)		
Interrupt input	-			8 inputs (for pulses of 200µs)		
Interrupt programme	-			9 programmes (external 6 inputs + periodical interrupt)		
Periodical interrupt	-			10ms to 30s		
Constant scan	available					
Other functions	password setting					
Real Time Clock	-			available		

### GENERAL SPECIFICATIONS

Rated operating voltage	
DC types:	24VDC
AC types:	100 to 240VAC
Operating voltage range	
DC types:	20.4 to 26.4VDC
AC types:	85V to 264VAC
Ambient temperature	0°C to +55°C
Storage temperature	-20°C to +70°C

### INPUT SPECIFICATIONS

Input type	+/- switching
Rated input voltage	24VDC
ON voltage range	> 10VDC
OFF voltage range	< 2.5VDC

### OUTPUT SPECIFICATIONS – Relay

Output type	Normally open (1 form A)
Rated control capacity	2A 250VAC, 2A 30VDC

### OUTPUT SPECIFICATIONS – Transistor

Insulation method	Optical coupler
Output type	Open collector (PNP or NPN transistor)
Rated load voltage	24VDC (5 to 24VDC)
Max. load current	0.5A

# FP1 Expansion / Special Modules

## Expandable intelligence

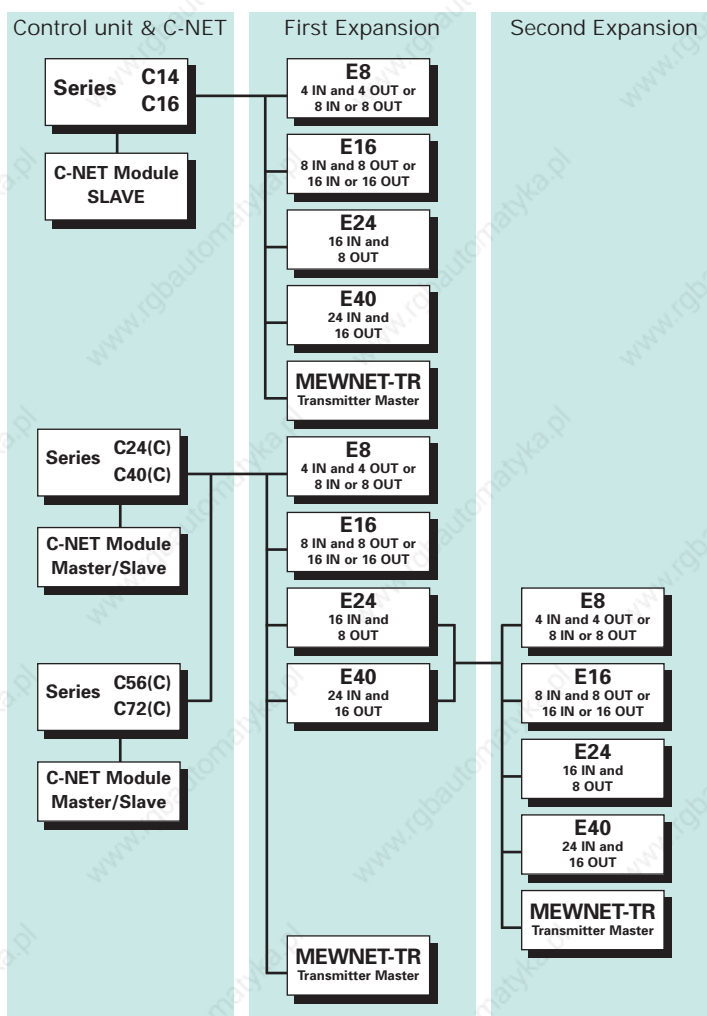

### MODULE E8

4 inputs / 4 outputs  
8 inputs or 8 outputs  
relays, transistor or triac  
80 x 81 x 45mm (DC)

### MODULE E16

8 inputs / 8 outputs  
16 inputs or 16 outputs  
relays or transistor  
120 x 81 x 45mm (DC)

### MODULE E24

16 inputs / 8 outputs  
relays or transistor  
190 x 96 x 45/74mm (DC/AC)

### MODULE E40

24 inputs / 16 outputs  
relays or transistor  
260 x 96 x 45/74mm (DC/AC)

### ANALOGUE INPUT MODULE

One module per CPU  
4 Inputs, 10bit  
0 - 5VDC, 0 - 10VDC, 0 - 20mA



### ANALOGUE OUTPUT MODULE

Maximum of two modules per CPU  
Each with 2 outputs, 10bit  
0 - 5VDC, 0 - 10VDC, 0 - 20mA



# MEWNET-TR

## Sensor / Actuator Bus

### NAIS PROFIBUS...

...implies manufacturer – independent communication at field level. The European Profibus standard EN50170 guarantees compatibility of all certified devices.

The FP1 DP-Slave Unit (AFP 17910) allows Matsushita's FP1 miniature control to be connected to the Profibus as a slave unit. The FP1 has its own powerful set of commands, operates independently and can continue to exercise control even if communication is interrupted. The configurable address area is 0 to 125. The baudrates 9.6kBd up to 1.5MBd can be detected automatically.



#### C-NET ADAPTER

Linking of up to 32 stations  
Multidrop network via  
RS485  
Low-cost wiring  
Standard type:  
RS422, RS232C  
S1-type: RS422 (slave)



#### MEWNET-F

**I/O Coupling Module**  
Decentralised connection  
to a master station.  
The FP1 serves as a slave  
via RS485

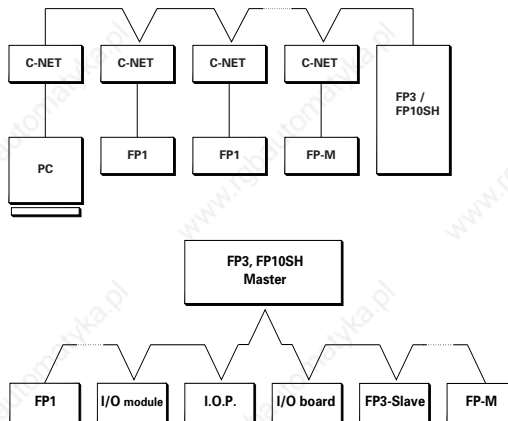

### MEWNET-TR

#### Sensor / Actuator Bus

(master-module and slave terminals)  
Connection of up to 80 digital, decentralised I/Os  
(up to 20 stations) via RS485

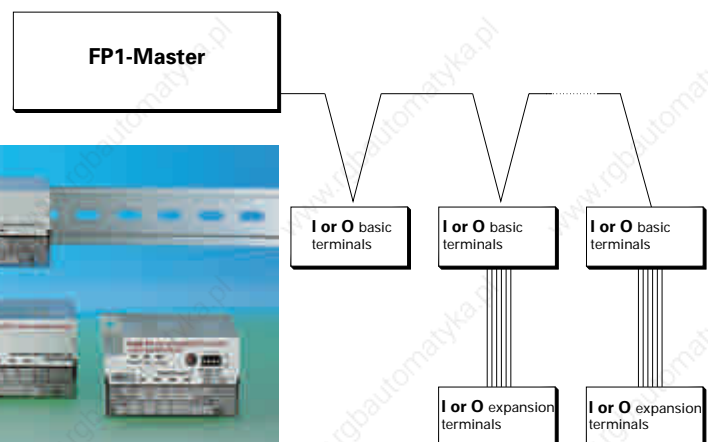

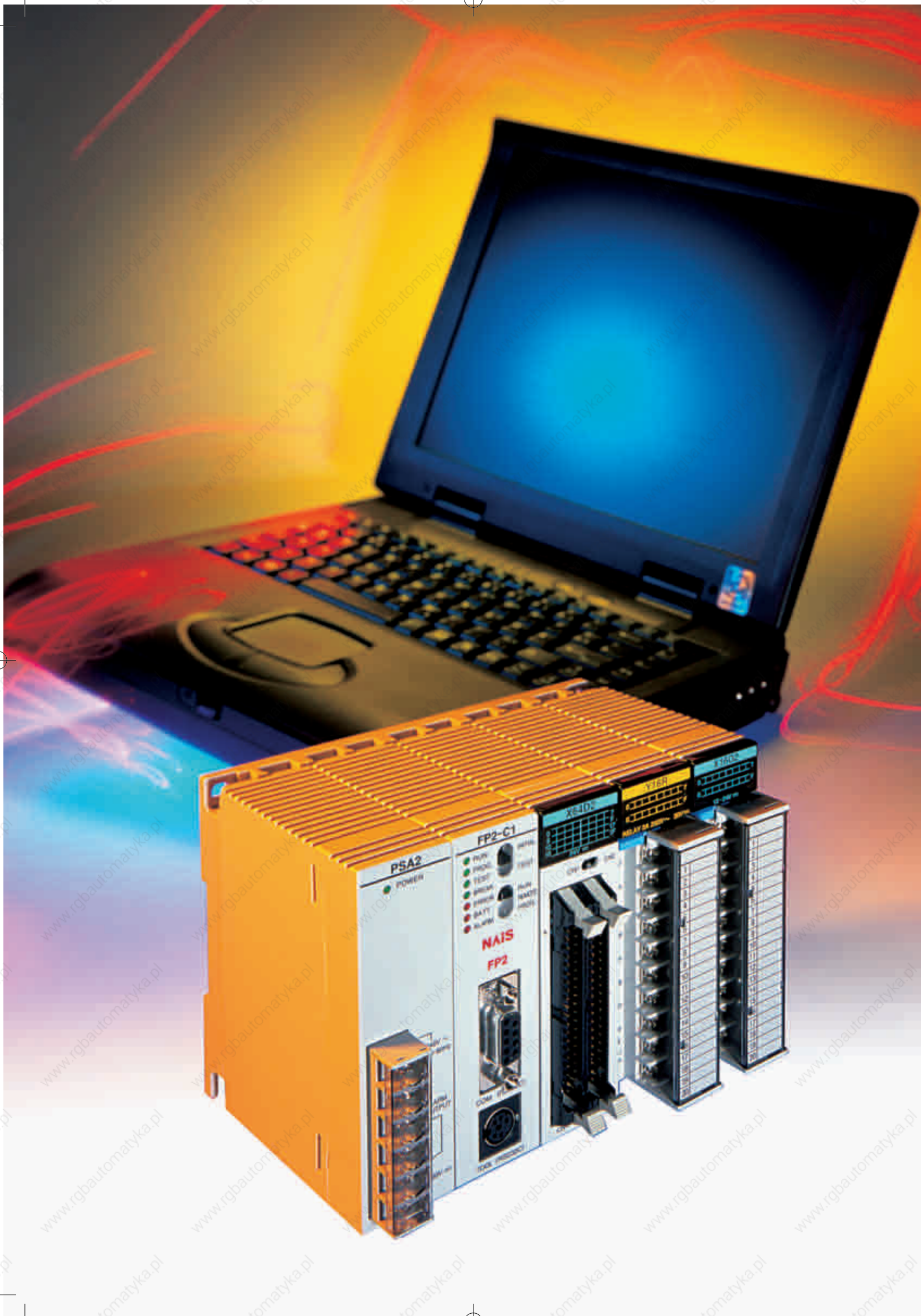

# FP2 Series

## Basic CPUs

### A new dimension

The FP2 offers top performance and a full range of functions at just 36% of the volume of comparable controllers.

### COMBINATION CPU WITH INTEGRATED PERFORMANCE

- Standard-CPU's
- CPU with integrated S-LINK
- Combination CPU with 64 inputs
- Combination CPU with 4 analogue inputs and 1 analogue output

### UP TO 28 MODULES OR 1,600 (2,048) INPUTS AND OUTPUTS

- The system allows standard module racks for 5, 7, 9, 12 or 14 modules to be combined.
- To give a total of up to 1,600 inputs and outputs (2,048 via remote I/O)

### TWO RS232C INTERFACES (TOOL port and COM port) included as standard in the CPU

- Simple communication with operation display panels or a host PC
- 115.2 kbit/s max. data rate
- The FP2 is of course ready for telecontrol via a modem and offers full remote access functionality.



Standard type CPU unit  
FP2-C1



CPU unit with 64-point input  
FP2-C1D



CPU unit with analog I/O  
FP2-C1A



CPU unit with S-LINK  
FP2-C1SL

### PERFORMANCE SPECIFICATIONS

PLC type	FP2-C1, FP2-C1D, FP2-C1A, FP2-C1SL
Inputs / outputs	central: max. 1,600 (with 25 modules) locally expanded: max. 2,048 (via MEWNET-F or S-Link)
Memory	RAM (EPROM or FROM optional)
Programme memory	16,000 steps, expandable to 32,000 steps
No. of instructions	
basic instructions	96
high-level instructions	428
Operating speed	0.35µs per basic instruction
internal relay (R)	4,048
Memory	
timer/counter (T/C)	1,024
data register (DT)	6,000 words
file register (FL)	0 to 14,333 words, optionally up to 30,717 words
Master control relay (MCR)	256
Jump labels (JMP + LOOP)	256
Max. main memory programme steps	1,000
Number of subroutines	100
Interrupt programme	1
Time interrupt	0.5ms to 1.5s
Other functions	runtime editing, watchdog function, I/O error check, battery, syntax, memory and password functions, test mode, machine code memory, constant cycle time



# FP2SH

## Ultra-high performance

### A High-Performance Model...

#### ... for high speed operation.

Scanning time of 1ms for 20k steps. With an operating speed at the top of its class, super high-speed processing is made possible. The result is a dramatically decreased tact time and high-speed device.

#### LARGE PROGRAMMING CAPACITY OF UP TO 120K STEPS

Both the large programming capacities of 60k and 120k are available depending on the model.

#### THE BUILDING-BLOCK TYPE FOR FREEDOM IN THE COMBINATION OF DEVICES

I/O units, intelligent units, powersupply unit and backplanes can be commonly used for the FP2 and the FP2SH. I/O unit can be freely located on each backplane.

#### OPTIONAL SMALL PC CARD IS ALSO AVAILABLE

The small PC card is available for programming backup or data memory expansion. This allows data processing of great amounts of data.

#### BUILT-IN COMMENT AND CALENDAR TIMER FUNCTIONS

These functions, options with the FP2, are built right into the FP2SH.



#### THE CPU FOR IC MEMORY CARD INTERFACE IS ALSO AVAILABLE



IC memory card  
2MB SRAM



IC memory card  
2MB F-ROM



#### Compact body!

The overall dimension of the 5-module combination is: 140x100x108.3mm (WxHxD)

# FP2SH

## Specifications



### LARGE PROGRAMME CAPACITY

**120k** (60k or 120k depending on model)

### HIGH-SPEED OPERATION

**30ns** (per basic instruction step)

### SHORT SCAN TIME

**1ms** (when executing a programme of approx. 20k steps)

### PERFORMANCE SPECIFICATIONS

PLC type	FP2-C2, FP2-C2P, FP2-C3P
Inputs / outputs	central: max. 1,600 (with 25 modules) locally expanded: max. 2,048 (via MEWNET-F or S-Link)
Memory	RAM (EPROM or FROM and IC memory card optional)
Programme memory	FP2-C2, FP2-C2P: 60,000 steps, FP2-C3P: 120,000 steps
No. of instructions	
basic instructions	95
high-level instructions	434
Operating speed	0.03µs per basic instruction
internal relay (R)	14,192
Memory	
timer/counter (T/C)	3,072
data register (DT)	10,240 words
file register (FL)	32,765 words x 3 banks
Master control relay (MCR)	256 (1st programme: 256 points / 2nd programme: 256 points)
Jump labels (JMP + LOOP)	256 (1st programme: 256 points / 2nd programme: 256 points)
Max. main memory programme steps	1,000
Number of subroutines	100
Interrupt programme	1
Time interrupt	0.5ms to 1.5s
Other functions	test run operation, forced input/output, interrupt processing, Batch conversion, function for multiple instructions in RUN mode, calendar time, computer link and modem control by the TOOL and COM port, IC card, 2MB SRAM, Flash-EEPROM, ROM operation, comment input function



# FP2 Series / FP2SH

## Expansion modules and special intelligent modules



POWER SUPPLY MODULES		
P/N	Voltage	Rating (at 5V side)
FP2-PSA1	100-120VAC	2.5A
FP2-PSA2	200-240VAC	2.5A
FP2-PSA3	100-240VAC	5A
FP2-PSD2	24VDC	5A



INPUT MODULES		
I/O Number	Voltage	Connection
16	12-24VDC	terminal
32	24VDC	connector
64	24VDC	connector



OUTPUT MODULES			
I/O Number	Voltage	Connection	Rating
6 relay	250VAC	terminal	5A
16 relay	250VAC	terminal	2A
16 transistor	12-24VDC	terminal	0.5A
32 transistor	5-24VDC	connector	0.1A
64 transistor	5-24VDC	connector	0.1A



# FP2 Series / FP2SH

## Expansion modules and special intelligent modules

### I/O MIXED MODULES

I/O Number	Voltage	Connection	Rating
32 In / 32 Out	12-24VDC	connector	0.1A

Additional an input/output mixed unit with ON pulse catch function is available. This useful function makes possible to read ON pulses with extremely small widths.



### ANALOGUE INPUT MODULE

Inputs	8
Resolution	up to 16bit
Conversion time	0.5ms

### ANALOGUE OUTPUT MODULE

Outputs	4
Resolution	12bit
Conversion time	0.5ms

The range settings, such as voltage and current, can be specified either for all of the channels at once using dip switches or individually using shared memory settings. The analogue input unit can be directly coupled to a thermocouple and a resistance thermometer element (R.T.D.).

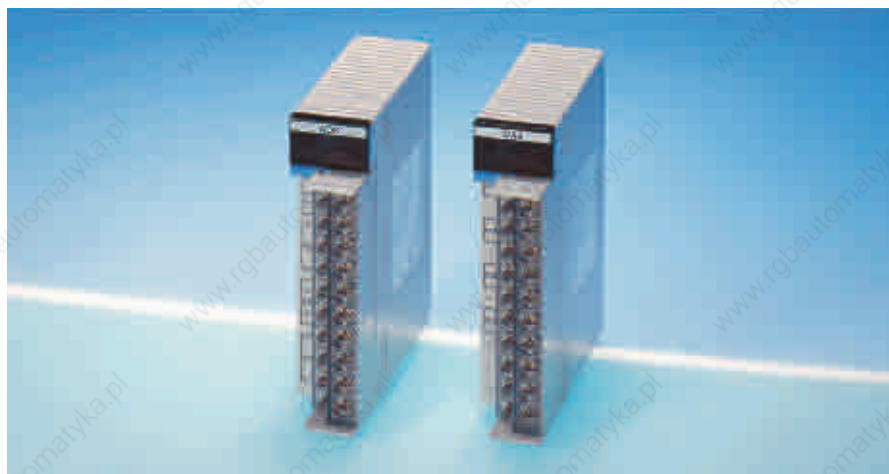

### POSITIONING MODULES

For system-integrated 2 and 4-axis path control. Maximum 4 Mpps speed commands gives high-speed and high-accuracy positioning.

0.005ms high-speed drive reduces tact time.

Feedback pulse count function makes output pulse counting possible for encoders, etc.

4 types of S-curve acceleration / deceleration control make smooth startup and stopping possible.





## FP2 Series / FP2SH

### Expansion modules and special intelligent modules



#### HIGH-SPEED COUNTER MODULE

Counter	4 channel, max. 200KHz
Interrupt input	8 points
PWM output	-
Pulse output	-

#### PULSE I/O MODULE

Counter	4 channel, max. 200KHz
Interrupt input	8 points
PWM output	4 points, 1Hz to 30KHz
Pulse output	4 points, 100KHz



#### SERIAL COMMUNICATION MODULES

##### Computer Communication Module

Through two RS232C ports the unit can be directly connected with a PC to collect and write data from it.

Economical peer-to-peer communication with a PC is possible.

Connectable with operation display panels (HMI).

##### Serial Data Module

Reading data can be performed simply using applied command F 150 and writing using command F 151. Up to 500 characters can be received at one time.

It is possible to use the module in three ways: input only, output only, input and output.



#### MULTI WIRE-LINK MODULE

**PLC Link Function.** Link communication can be carried out between various programmable controllers using link relays and link registers.

**Data Transfer Function.** PLCs in the same system send and receive information pertaining to contacts and registers, using programmes.

**Remote Programming Function.** If the PLCs are in the same system which is connected by the link unit, the programming PLC can be used to programme other PLCs, and for monitoring the various contacts and registers.

#### S-LINK MODULE

The S-Link unit is used by assigning inputs (X) and outputs (Y). The inputs/outputs on the FP2 side that result from these assignments are treated as corresponding to the I/O-addresses (S-Link I/O-devices in the S-Link).

It controls up to 2,048 remote I/Os per FP2 system

# FP2 Series / FP2SH

## Expansion modules and special intelligent modules

### ETHERNET-LAN MODULE

The FP2 ET-LAN module enables data exchange between different types of PLC with a vendor independent protocol and a short processing time.

TCP/IP establishes logical point-to-point communication between two devices and provides the basis for exchanging information among all areas of production.

You can connect 8 Ethernet segments with each other at a transmission speed of up to 100Mbits/sec.

Three communication interface types are supported:  
10 BASE 5, 10 BASE-T, 100 BASE-TX



### PROFIBUS FMS AND DP MODULES

#### FMS/DP master module

PROFIBUS FMS and DP communications can be used simultaneously.

Powerful and flexible data exchange in extensive, higher-level multi-master networks with up to 12Mbaud.

#### DP master module

For easy and cost-effective networking between FP2 and distributed devices from simple I/Os (e.g. sensors, panels) to FP0 and FP1 programmable controllers.



### APPLICATION EXAMPLE: S-LINK

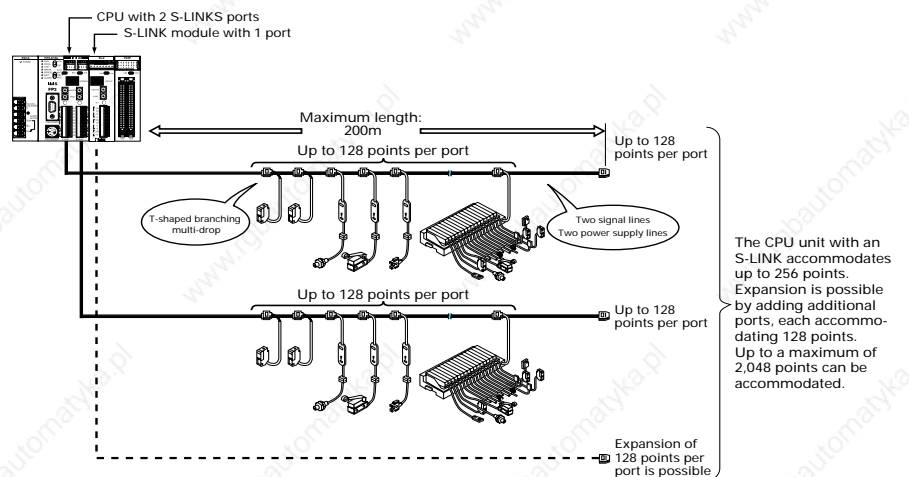

# Networking / Decentralisation

## The Networks of FP Controllers

### MEWNET-W

#### RS485-Two-Wire-Circuit

Communication at process level between PLC systems using low-cost two-wire circuitry. Data exchange via RS485 interface (Token Bus).

Transmission rate: 500KBd

Max. number of stations: 32

Max. distance: 800m

Max. distance between stations: 200m

### MEWNET-F

#### Decentralised I/O

Network for optimum-cost decentralisation. Minimum possible wiring outlay. Diagnosis, analysis and programming of master unit can be conveniently done "in situ".

Transmission rate: 500KBd

Max. number of stations: 32

Max. distance: 700m

Max. distance between stations: 700m

### MEWNET-TR

#### The sensor/actuator bus

MEWNET-TR provides low-cost transmission of digital I/O information at sensor/actuator and field level between a master connection assembly and decentralised terminals (slaves).

Transmission rate: 500KBd,

Max. number of stations: 32

Max. distance: 700m

Max. distance between stations: 700m

### TR-NET

The intelligent sensor/actuator bus terminals in the TR-NET from Matsushita make cost-intensive network masters superfluous in compact automation projects. Digital information from a sensor station is transmitted via two-wire circuitry directly to the associated station.

Transmission rate: 500KBd

Max. number of stations: 32

Max. distance: 700m

Max. distance between stations: 700m

## Matsushita Industrial Networks for in Industrial Applications

### Company level

Total Quality, production planning, etc.

### Control level

Production computer, cell computer, control centre

### Process level

Machines, plant  
(operate, observe, control)

### Field level

Sensors/actuators

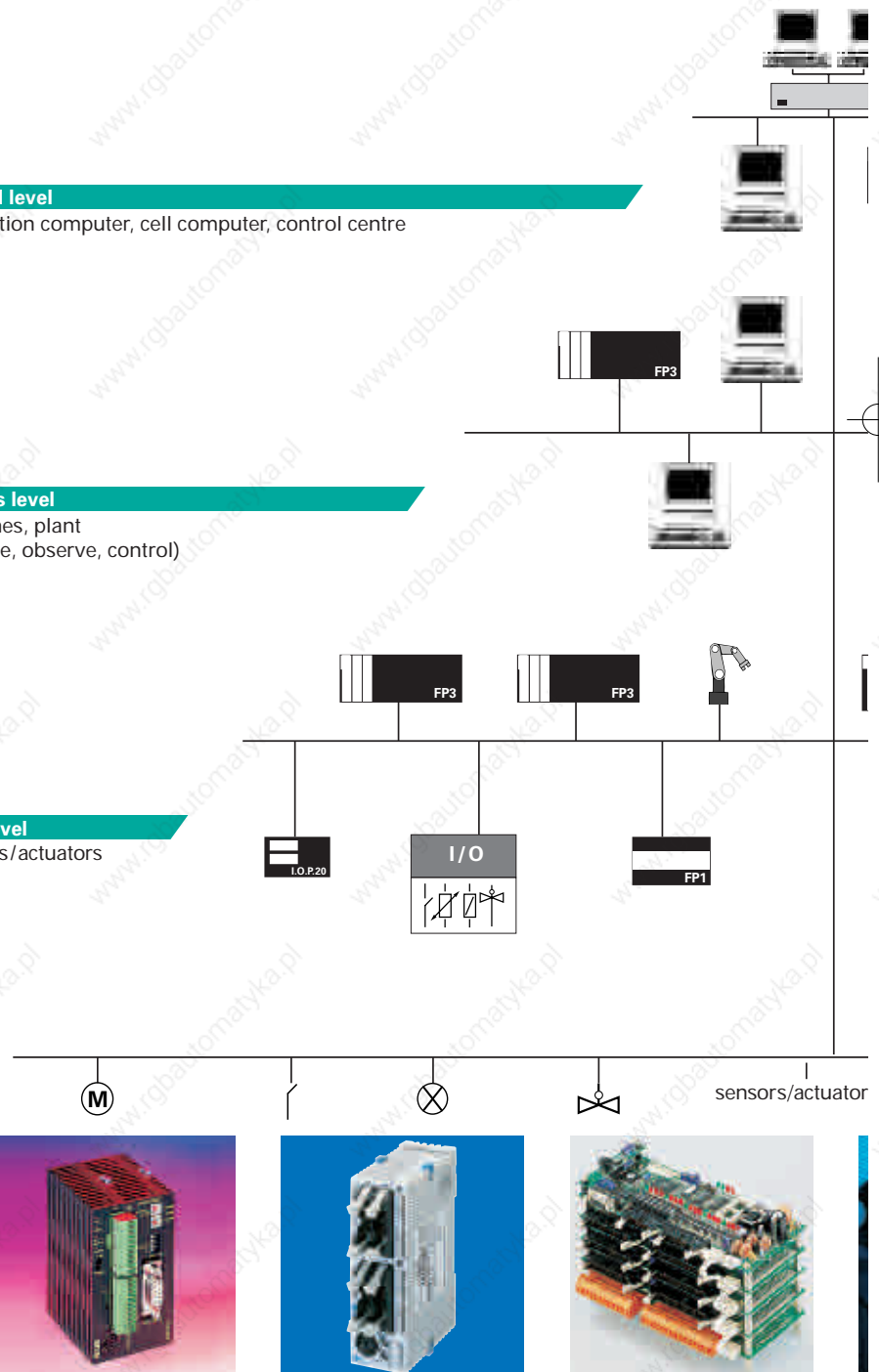

# Networking / Decentralisation

## The Networks of FP Controllers

### Applications for Continuous Communication

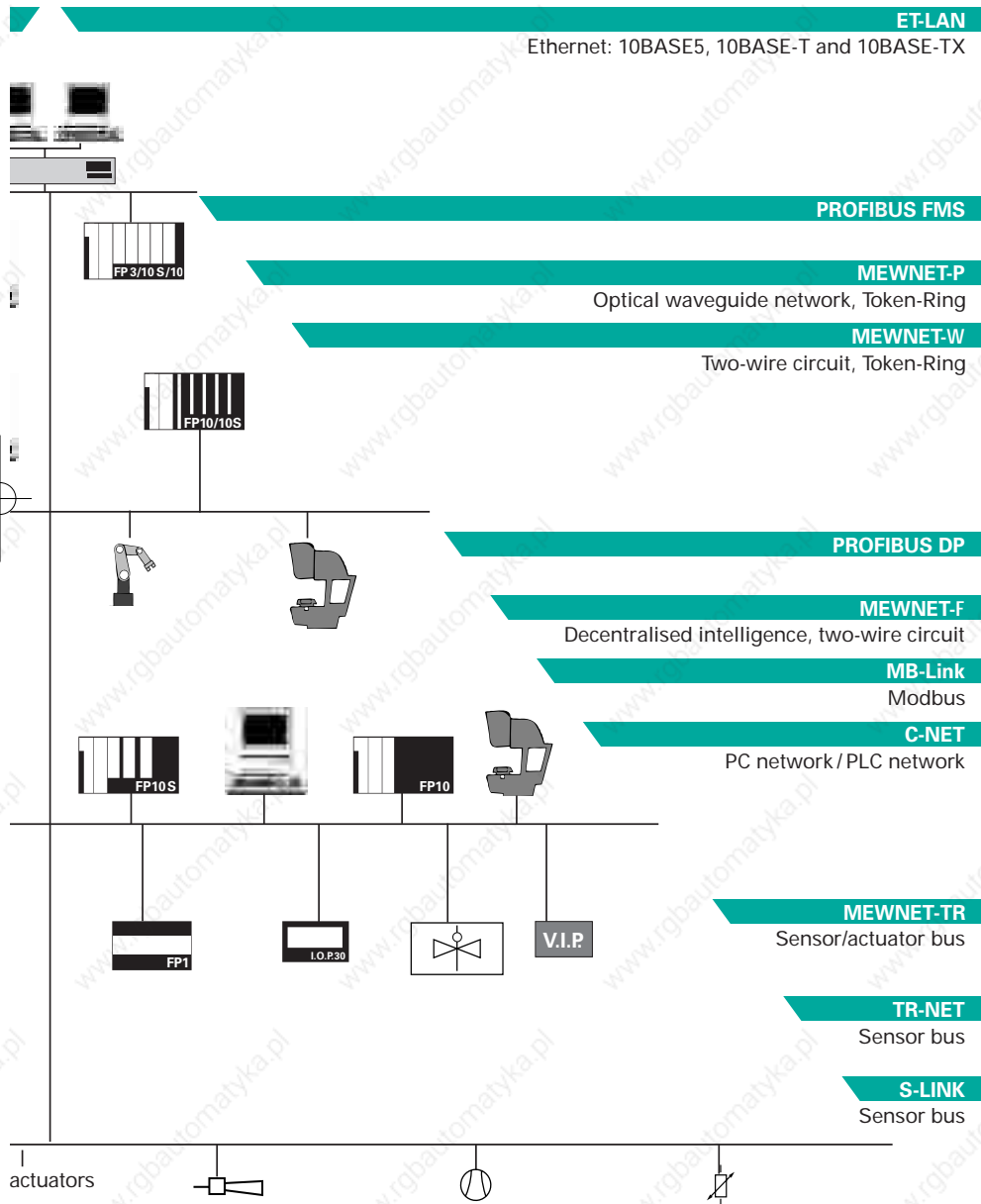

#### Ethernet

Ethernet is the standard network for office and industry. Several mainframe computers or "control level" PC units communicate via ET-LAN with FP-Series systems at process level. Transmission rate: 10MBd, 100MBd  
10 BASE 5, 10 BASE-T, 100 BASE-TX  
TCP/IP protocols or UDP/IP protocols.

#### FP Web-Server

Brings together all FP Series PLCs via Ethernet. It offers remote access from your PC using only a standard browser, e. g. MS Internet Explorer or Netscape.

#### FP Modem – EU

Comprises many communication monitoring and control functionalities. By calling up to the Web Server via modem, a local network access can be established.

#### NAIS PROFIBUS

Implies manufacturer-independent communication at field level. The standard EN50170 guarantees compatibility of all certified devices. Several hundred companies offers more than 2000 products with PROFIBUS interfaces.

Specification according to the standard EN50170:

- FP0/FP Sigma/FP1 DP Slave
- FP2/FP2SH/FP3/FP10SH FMS-DP combi master
- FP2/FP2SH/FP3/FP10SH DP master

#### C-NET

##### Computer-Network

LOW COST network in master / slave process for communication between computer and control systems.

Transmission rate: 9.6/19.2KBd

Max. number of stations: 32

Max. distance: 1.2km

Max. distance between stations: 1.2km

#### S-LINK

The serial I/O bus for up to 128 components per port uses two-wire signaling circuits and connects components in the multidrop system to reduce networking costs.

Transmission rate: 28.5Kbit/s,

Max. number I/Os: 128/ch.

Max. distance: 200m (400m)





# FP Web-Server

## Internet / Intranet

### Worldwide Communications

The FP Web-Server module connects all FP Series controllers to the Ethernet. No changes to the PLC programs are necessary. Simply assign an IP address to the FP Web-Server and connect the PLC to the FP Web-Server via the serial RS232 interface. A standard browser, e.g. MS Internet Explorer or Netscape Navigator, can be used for access at the PC.

#### FP WEB-SERVER ADVANTAGES:

- uses existing Intranet, saves wiring
- uses standard browser, saves Scada software
- remote control
- remote monitoring
- remote programming
- alarm information via Email

#### FP WEB-SERVER MAIN FEATURES:

##### ① Web-Server:

- PLC data presented as HTML pages
- Access via standard Internet browser
- HTML entry field for PLC data change
- Optional password protection

##### ② Email:

- PLC can send Email
- PLC defined or pre-stored mail text

##### ③ RS232C redirection:

- Ethernet / RS232C conversion (MEWTOCOL)
- Programming and visualisation access via Ethernet

##### ④ Modem / Ethernet gateway:

- FP Web-Server can be dialled up via modem for local or network access
- One remote gateway for multiple FP Web-Servers in a local Ethernet network
- Remote password handling



#### SPECIFICATIONS

Dimensions (WxHxD)	25 x 90 x 64
Rated operating voltage	24 VDC (10.8-24.4 VDC)
Power operating voltage	2 to 3 Watt
LEDs	Power, COM (Ethernet connection / data exchange)
Power connection	24 VDC Molex 35 connector
Ethernet connection	Ethernet-COM: 10 BaseT (via RJ45 connector)
PLC connection	PLC-COM: RS232C (via 3-pin Phoenix screw terminal)
Modem connection	Modem-COM: RS232C (via 9-pin SUB-D with RTS, CTS)
Memory	512 kByte
Standards	CE declaration

# FP Modem-EU

## Telecontrol

### Control from a distance

Matsushita PLCs of the types FP0, FP1, FP-M and FP2, FP2SH and FP10SH with a second RS232C interface (COM port) become a telecontrol station when the FP MODEM-EU modem is used.

This industrial quality analogue modem, the size of a cigarette packet, is suitable for a great many communication, monitoring and control tasks with numerous professional functions.



### Standard specifications:

- Dial-up mode: European approval CTR21 including pulse dial option.
- Leased line mode: European approval CTR 15, max. distance 20 km.
- Multipoint mode: Intelligent multidrop data transfer.
- Fax mode: Fax group 3 supported (command class 2)
- Test mode: V.54 analog and digital Test loop.
- Password protection and call back function.

### Interface specifications:

- Transmission rate: up to 57600 bits/s
- Transmission standards: V.32bis, V.32, V22bis, V.22, V.23, V.21, V.17, V.27ter, V.29
- Error correction: V.42, V.42bis, LAPM, MNP4, MNP5, MNP10
- Data compression: MNP5, V.42bis
- AT instruction set (Hayes compatible).

### Example: Combination of LAN and Dial-up Gateway

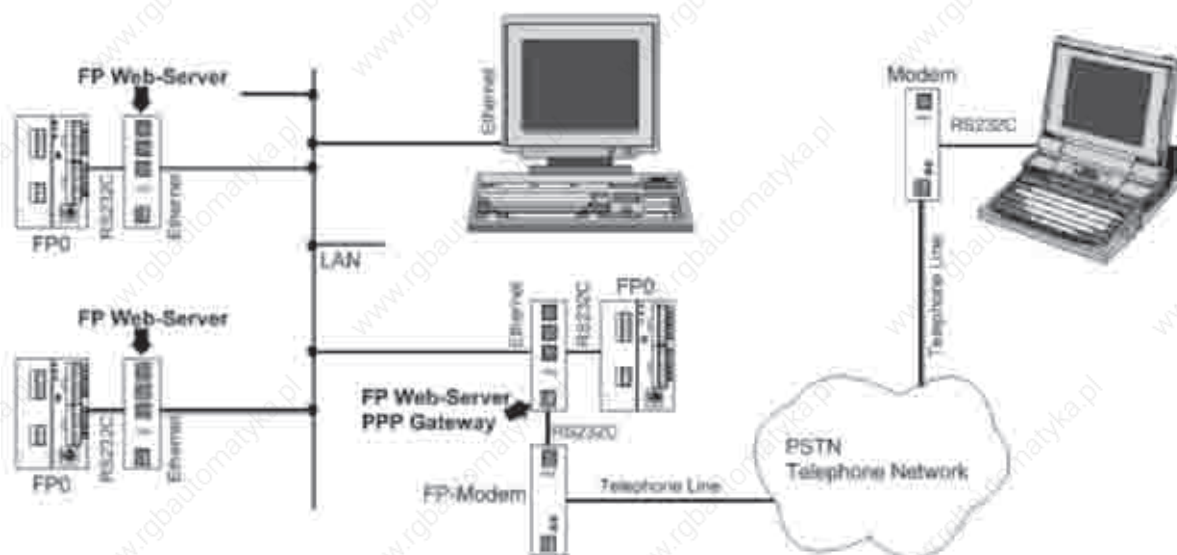

# NAIS Control FPWIN Pro

## Programming software

**NAIS Control FPWIN programming tools works with any FP series programmable controller under Windows environment.**

### NAIS control FPWIN Pro

is the Matsushita programming software according to the international standard IEC 61131-3 (for Windows 95/98, NT or 2000). **NAIS Control FPWIN Pro** works with any FP series programmable controller. Also, since the tool port is an RS232C, connection to a PC is easy – it only requires a single cable. No converter or adapter is required.

Programm upload of former Matsushita programming software is available. (NPST-GR, FP-Soft, FPWIN-GR).

### Support 5 Programming languages

The programmer can choose the programming language he is familiar with, or the language most suitable for the task: IL, ST, SFC, FBD or LD.

The user interface is available in six languages: English, German, French, Italian, Spanish, Japanese.

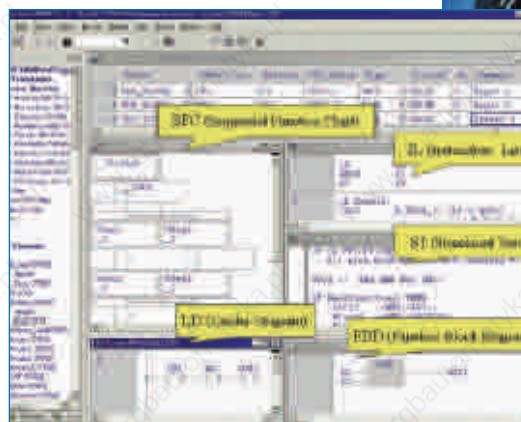
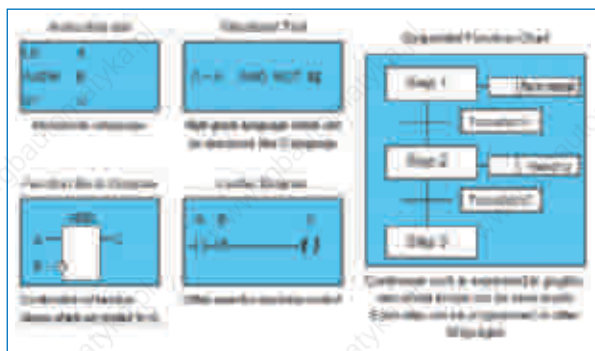

### The most important highlights at a glance:

- Reuse of ready made functions and function blocks saves time for programming and debugging
- 5 programming languages (instruction list, ladder diagram, function block diagram, sequential function chart, structured text)
- Convenient comment application in 6 languages (English, German, French, Italian, Spanish, Japanese)
- 2 standard libraries (IEC-standard library, Matsushita library)
- Fewer errors through defined data types and encapsulation
- Well-structured through programme organisation units, task- and projectmanagement
- Online monitoring and diagnostic
- Ethernet and Modem communication for remote-programming, -service, and -diagnostic
- Password protection with different levels
- Many additional application libraries available
- IEC 61131-3 protects your investments for the future





# NAIS Control FPWIN GR

## Programming software

### NAIS Control FPWIN GR for Windows

#### Features

FP Series programming software for Windows.

1. To facilitate operation on site, a mouse is not required for input, search, write, monitor and timer edit operations. Everything can be accomplished with a keyboard, alone.
2. Standard Windows operations, such as copy and paste, are included.
3. Supports all FP series machines. Software created with NPST-GR Ver. 3 or 4 can also be used.
4. Inherits convenient functions developed for NPST-GR.

#### Usage environment

<b>OS</b>	<b>Windows 95/98/NT (ver. 4.0 or later)</b>
<b>Required hard disc capacity</b>	<b>at least 30MB</b>
<b>Recommended CPU</b>	<b>Pentium 100MHz or higher</b>
<b>Recommended installed memory</b>	<b>32MB or more</b>
<b>Recommended screen resolution</b>	<b>800 x 600 or higher</b>
<b>Recommended display colors</b>	<b>High color (16bit or higher)</b>

#### Applicable PLC types

All products on the market as of June 2000 are supported. All FP series types are supported: FP0, FP1, FP2, FP2SH, FP3, FP10SH, FP-M, FP-Sigma

#### Menu

**Programme status display** →

**Programme display** →

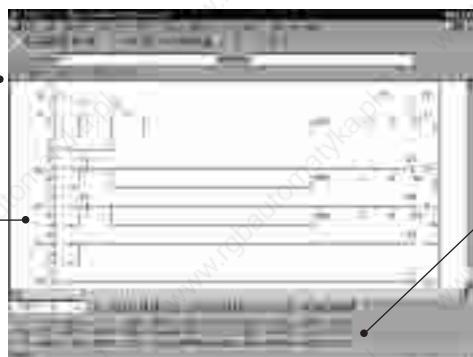

#### Tool bar

Access often-used functions using icons.

#### Function bar

Provides information regarding command input and confirmation, on-line/off-line selection and PLC mode selection.

### Compatibility between the DOS version NPST-GR and the FPWIN-GR

- Files created with the NPST-GR Ver. 4 or Ver. 3 can be loaded (including I/O comments, remarks and block comments).
- Programmes created with Microsoft Windows software can be read by NPST-GR using the export function. However, comments cannot be read by NPST-GR using this method.
- When programmes and comments created with the *FPWIN GR* are downloaded to the PLC, comments cannot be loaded with the NPST-GR, but programmes can be loaded.
- There are no merge registration or loading functions. Instead, the "Copy and Paste function" in Windows should be used.
- Verifications cannot be carried out targeting files. The files to be verified must first be loaded, and then verified.
- There are no multi-point monitoring or multi-data monitoring functions.
- You cannot display the network status on the online status display.



# PCWAY

## Data monitoring, logging and setting software with **NAIS** FP series PLC

### EASY Setting Data on EXCEL

By setting the necessary items at the (Cell Settings) dialog box, it is possible to READ or WRITE the PLC data.

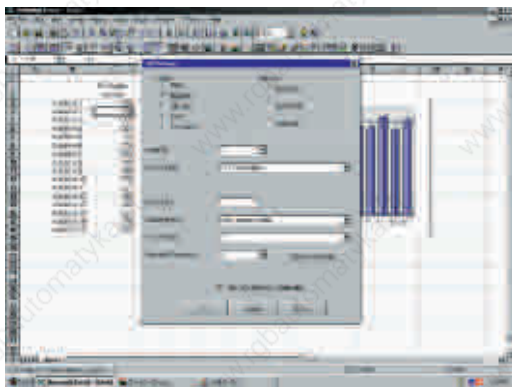

### Data Storage / Printing...

... in automatic operation.

Register the data at periodical or non-periodical, in accordance to the relay or PCWAY event turning to ON.

Save the data with the TEXT format. The file format can be registered flexibly. Also, the data can be written-in and processed at a different application, other than the Excel one.

### Interactive Data Exchange

... (PLC → PC).

Possible to download the displayed data to the PLC.

### EASY OPERATIONAL ENVIRONMENT

For those who do not want to use the macro programme...

- (Character Change): Changes the display character/colour by the ON/OFF of the relay.
- (Operation Formula): perform an operation during the displaying and the operation of the register.

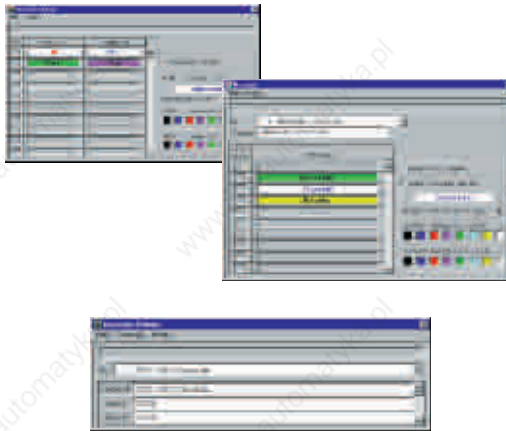

### Versatility

- (Automatic Macro Startup): Starts the registered macro (registered by the User) by the event turning to ON.
- (Sound File): The sound will be out-putted by the PLC relay and event turning ON.

### Remote Data Management...

... via modem.

(Modem Support): Connects with the PLCs located in distant regions with the public phone line.

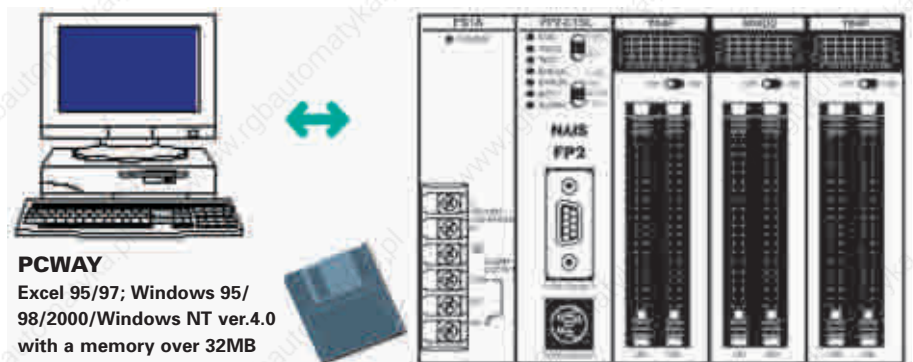

**PCWAY**  
Excel 95/97; Windows 95/  
98/2000/Windows NT ver.4.0  
with a memory over 32MB

# Control CommX

## The connection in ActiveX technology

Connects your Visual Basic application to Matsushita PLCs

### Features

No need for knowledge of Matsushita's PLC communication Protocol (MEWTOCOL)  
Communication programs can be made simply by dropping a Control on to a form.

Ethernet modem connection is possible  
Can be started simply by inputting a command

Your own application and Matsushita software can communicate at the same time.  
Length of time for starting is shortened drastically by using Matsushita PLC software.

### Setup Process

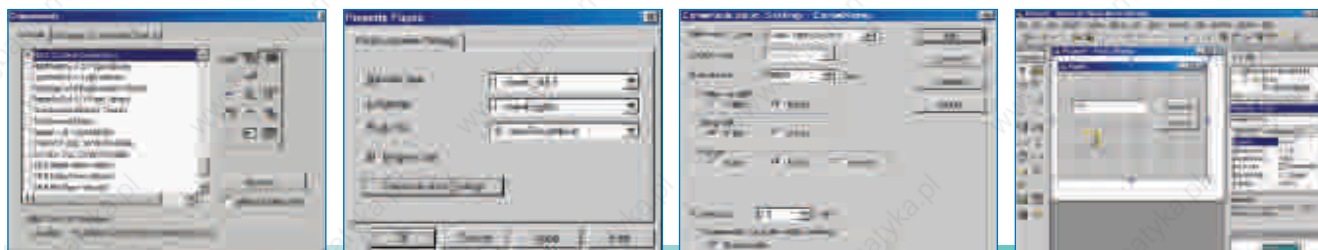

Initial Setup in Visual Basic

Configuration of Communication

Register of Various Communication Types

Programming

Completion

### Principal communicating function

Continuous read/write	Read/write information of continuous contacts or registers in PLC and IC cards mounted in PLC.
Random read	Read in information of various types of devices and fragmentary contacts or registers.
PLC's status read	Display status of PLC (such as RUN/PROG).
PLC RUN/PROG switching	Change status of PLC (RUN/PROG).
Set communication window	Display and change the configuration of communication.
Communicating condition searching function	Automatically search communicating condition matching with RS232C connection.
Modem receiving connection	Generate the event by receiving the data from PLCs in Modem connection.
Conversion function	Has each conversion function for binary decimal octal hexadecimal

### Usage environment

OS	Windows95 OSR2 (Ver.4.00.950B) or later Versions. Windows NT (Ver.4.0 or later) /2000
Required hard disk space	5MB or more
Available CPU grade	Pentium100MHz or higher
Lowest capacity memory	64MB or more
Available resolution	800 600 or higher
Color grade	High Color (16 bits) or more
Applicable PLC types (As of August 2001)	FP series PLC FP0 / FP (SIGMA) / FP1 / FP-M / FP2 / FP2SH / FP3 / FP10SH
Available Networks	RS232C(C-NET) connection Ethernet connection Modem connection



# Human Machine interfaces

## G-Series

### KEY TERMINALS

#### GK KEY TERMINALS

- Graphics and text display
- Up to 22 function keys
- Communication interfaces  
RS422/485, RS232C
- Audible signal/ alarm management up to 16 groups
- Trend diagrams/ report creation
- Up to 8 levels of password protection
- Time channels/ real-time clock
- Recipe management
- Expansion cards
- Oil and water resistant



**GK60**  
240 x 128 pixel

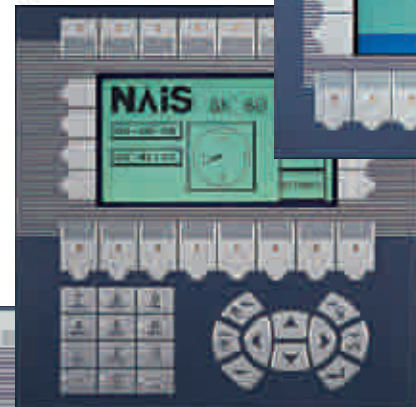

**GK30**  
240 x 64 pixel



**GK20**  
4 lines x 20 characters



**GK10**  
2 lines x 20 characters



**GK05**  
2 lines x 16 characters



**GT30**  
5.7" monochrome or colour display



**GT10** – 4" monochrome display



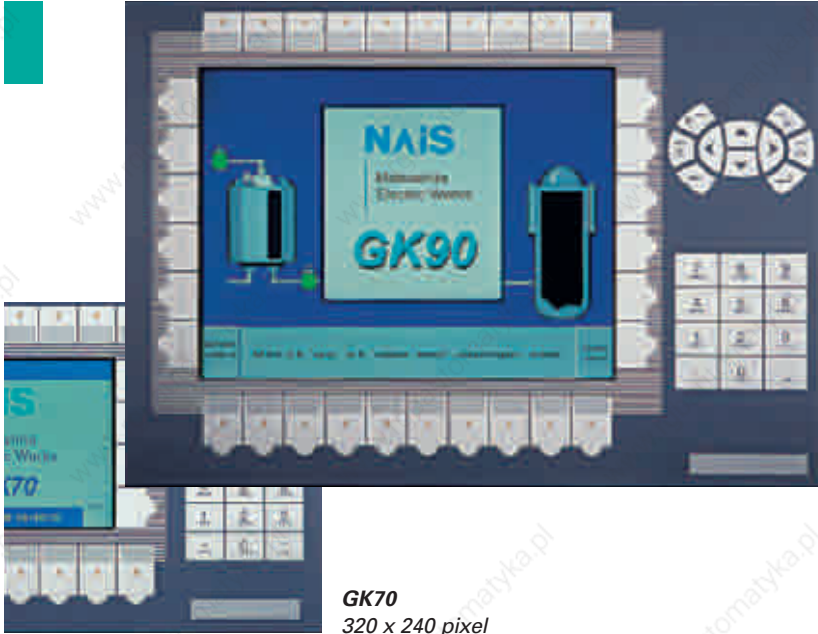

**GK90**  
640 x 480 pixel

**MESSAGE RUNNER KP3H**



- Easy to read 8-character display
- Up to 64 messages can be saved and easily displayed
- Messages can be scrolled to 32 characters in length
- Green and orange character display
- Compact DIN 36x72 profile
- Maintenance free



**GK70**  
320 x 240 pixel

**GV60**  
12.1" colour TFT display



**GV50**  
10.4" colour STN or TFT display



**GV40**  
7.7" colour STN display

**GT-/ GV TOUCH TERMINALS**

- Brilliant graphics
- 4 to 12.1 inch screen size
- Displays with up to 128 vivid colours
- Beautifully formed true type fonts
- Notepad function
- Up to 2.8MB flash memory
- Connectable to PLCs from a variety of manufacturers

**TOUCH TERMINALS**

# FP0-PSA2 / FP-PS24-050E

## 24 VDC Power Supplies

### Features

#### ■ Incredibly small size:

- FP0 power supply: 90 x 60 x 30.4mm
- FP power supply: 115 x 75 x 42mm

#### ■ Maximum output current:

- FP0 power supply: 0.7A (24VDC)
- FP power supply: 2.1A (24VDC)

#### ■ Multiple voltage input:

85 to 265VAC

#### ■ Optimal protection:

overvoltage, overcurrent, overheating, etc.

#### ■ Global approvals

(UL/cUL, EN, CE-marking)

#### ■ DIN-rail mounting

(FP0 power supply also side mounting)

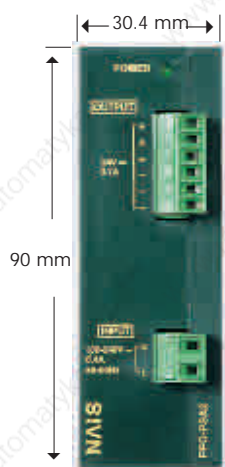

**FP0 Power supply  
FP0-PSA2**



**FP Power supply  
FP-PS24-050 E**

#### NOTE:

- 1) Mounting distance between the FP0 power supply and the FP0 CPU is needed to permit heat radiation for the FP0-CPU
- 2) For side mounting, 2 additional blue clips are needed: order part-no. 677-021-17101 (1pc.) for FP0-PSA2
- 3) Mounting distance between the power supply FP-PS24-050E and other devices is needed for cooling/heat radiation.

### ■ Performance specifications

Order No:	FP0-PSA2	FP-PS24-050E
Primary side:		
Rated operating voltage	115/230VAC	
Operating voltage range	85 to 265VAC	
Rated operating frequency	50/60Hz	
Operating frequency range	40 to 70Hz	
Inrush current	< 50A at 55°C	< 50A at 25°C / < 70A at 55°C
Current consumption	145mA (at 230VAC and 0.7A output current)	400mA (at 230VAC and 2.1A output current)
Over voltage protection	PROTECTED	
Secondary side:		
Rated output voltage	24VDC	
Output voltage range	23.5V to 24.5VDC	
Nominal output current	0.7A	2.1A
Output current range	0 to 0.7A	0 to 2.1A
Output ripple	< 60mV <sub>pp</sub>	< 240mV <sub>pp</sub>
Short circuit protected	electronic, automatic restart mode	continuous
Over voltage protected	Yes	
Over load protected	Yes (switch off at approx. 0.8A and more)	Yes (switch off at approx. 3.5A and more)
Holding time	min. 20ms at 230VAC	min. 110ms at 230VAC
Power OK signal	-	Yes

### ■ General specifications

Ambient temperature	0°C to +55°C	
Storage temperature	-20°C to +70°C	
Ambient humidity	5 to 95% non-condensing	
Storage humidity	5 to 95% non-condensing	
Vibration resistance	10 to 55Hz, 1 cycle/min.: double amplitude of 0.75mm, 10 min. on 3 axes	
Shock resistance	10g min., 4 times on 3 axes	
Life time min.	7 years at nom. load, 25°C ambient temperature, 20000 h at 55°C with full load/continuous operation	
Mounting	DIN rail or FP0 flat attachment plate	DIN rail
Size	90 x 60 x 30.4mm	115 x 75 x 42mm
Input connection AC side	MC connector, 2 pin	2 pin
Output connection DC side	MC connector, 6 pin, 3 pin for „+“ and 3 pin for „-“	5 pin, 2 pin for „+“ and 2 pin for „-“; 1 pin Power OK
Status display	LED (green) at the front side for the secondary voltage indication	

### ■ Standards

EMC	EN 50082-2, EN50082-1, EN 50081-2, EN 50081-1	EN 55011/B, EN 55022/B, EN 61000-4-2, -4-3, -4-4, -4-5, -4-6, -4-11
LVD	EN 60950, EN 50178 (overvoltage category 3)	EN 60950, EN 50178 (overvoltage category 2)
Others	UL Recognized according to UL 508, UL 1950, cUL Recognized according to CAN/CSA-C22.2 No. 950.95	
Protection	IP30	IP20 outside/IP67 inside



# Global Network Services



North America	Europe	Asia Pacific	China	Japan
Aromat Corporation	Matsushita Electric Works	Matsushita Electric Works	Matsushita Electric Works	Matsushita Electric Works, Ltd. Automation Controls Group

## Matsushita Electric Works

Please contact our Global Sales Companies in:



### Europe

▶ Europe	Matsushita Electric Works (Europe) AG	Rudolf-Diesel-Ring 2, D-83607 Holzkirchen, Tel. (08024) 648-0, Fax (08024) 648-111, <a href="http://www.mew-europe.com">www.mew-europe.com</a>
▶ Austria	Matsushita Electric Works Austria GmbH	Josef Madersperger Straße 2, A-2362 Biedermannsdorf, Tel. (02236) 26846, Fax (02236) 46133, <a href="http://www.matsushita.at">www.matsushita.at</a>
▶ Benelux	Matsushita Electric Works Benelux B.V.	De Rijn 4, (Postbus 211), 5684 PJ Best, (5680 AE Best), Netherlands, Tel. (0499) 372727, Fax (0499) 372185, <a href="http://www.matsushita.nl">www.matsushita.nl</a> , <a href="http://www.matsushita.be">www.matsushita.be</a>
▶ France	Matsushita Electric Works France S.A.R.L.	B.P. 44, F-91371 Verrières le Buisson CEDEX, Tél. 01 60135757, Fax 01 60135758, <a href="http://www.matsushita-france.fr">www.matsushita-france.fr</a>
▶ Germany	Matsushita Electric Works Deutschland GmbH	Rudolf-Diesel-Ring 2, D-83607 Holzkirchen, Tel. (08024) 648-0, Fax (08024) 648-555, <a href="http://www.matsushita.de">www.matsushita.de</a>
▶ Ireland	Matsushita Electric Works UK Ltd.	Irish Branch Office, Waverley, Old Naas Road, Bluebell, Dublin 12, Republic of Ireland, Tel: (01) 4600969, Fax: (01) 4601131, <a href="http://www.matsushita.ie">www.matsushita.ie</a>
▶ Italy	Matsushita Electric Works Italia s.r.l.	Via del Commercio 3-5 (Z.I. Ferlina), I-37012 Bussolengo (VR), Tel. (045) 6752711, Fax (045) 6700444, <a href="http://www.matsushita.it">http://www.matsushita.it</a>
▶ Portugal	Matsushita Electric Works España S.A.	Portuguese Branch Office, Avda 25 de Abril, Edificio Alvorada 5ªE, 2750-512 Cascais, Portugal, Tel. (21) 4828266, Fax (21) 4827421
▶ Scandinavia	Matsushita Electric Works Scandinavia AB	Sjöängsvägen 10, 19272 Sollentuna, Sweden, Tel. (08) 59476680, Fax (08) 59476690, <a href="http://www.matsushita.se">www.matsushita.se</a>
▶ Spain	Matsushita Electric Works España S.A.	Parque Empresarial Barajas, San Severo 20, E-28042 Madrid, Tel. (91) 3293875, Fax (91) 3292976, <a href="http://www.matsushita.es">www.matsushita.es</a>
▶ Switzerland	Matsushita Electric Works Schweiz AG	Grundstrasse 8, CH-6343 Rotkreuz, Tel. (041) 7997050, Fax (041) 7997055, <a href="http://www.matsushita.ch">www.matsushita.ch</a>
▶ United Kingdom	Matsushita Electric Works UK Ltd.	Sunrise Parkway, Linfood Wood East, Milton Keynes, MK14 6LF, England, Tel. (01908) 231555, Fax (01908) 231599, <a href="http://www.matsushita.co.uk">www.matsushita.co.uk</a>

### North & South America

▶ USA	Aromat Corporation Head Office USA	629 Central Avenue, New Providence, N.J. 07974, Tel. 1-908-464-3550, Fax 1-908-464-8513, <a href="http://www.aromat.com">www.aromat.com</a>
-------	------------------------------------	---

### Asia

▶ China	Matsushita Electric Works Ltd. China Office	2013, Beijing Fortune, Building No. 5, Dong San Huan Bei Lu, Chaoyang District, Beijing, Tel. 86-10-6590-8646, Fax 86-10-6590-8647
▶ Hong Kong	Matsushita Electric Works Ltd. Hong Kong	Rm1601, 16/F, Tower 2, The Gateway, 25 Canton Road, Tsimshatsui, Kowloon, Hong Kong, Tel. (852) 2956-3118, Fax (852) 2956-0398
▶ Japan	Matsushita Electric Works Ltd.	1048 Kadoma, Kadoma-shi, Osaka 571-8686, Japan, Tel. 06-6908-1050, Fax 06-6908-5781, <a href="http://www.mew.co.jp/e-acg/">www.mew.co.jp/e-acg/</a>
▶ Singapore	Matsushita Electric Works (Asia Pacific) Pte. Ltd.	101 Thomson Road, #25-03/05, United Square, Singapore 307591, Tel. (65) 6255-5473, Fax (65) 6253-5689