



DIAX02 DDS02.1/03.1 Drive Controller - Basic Unit

Project Planning Manual

DOK-DIAX02-DDS02.1/3.1-PRJ1-EN-P



Title	DIAX02 DDS02.1/03.1 Drive Controller - Basic Unit
Type of documentation	Project Planning Manual
Document code	DOK-DIAX02-DDS02.1/3.1-PRJ1-EN-E1,44 • 04.97
Internal file reference	<ul style="list-style-type: none"> • Mappe 11a • DDS_1-PJ.pdf • 209-0069-4317-02
Reference	This electronic document based on the hardcopy document with document desig.: DOK-DIAX02-DDS02.1/3.1-PRJ1-EN-P.

Editing sequence

Document designation of previous editions	Status	Comments
209-0069-4317-01 EN/12.93	Dec. 93	1st edition DDS02.1
209-0069-4362-00 EN/01.94	Jan. 94	1st edition DDS03.1
DOK-DIAX02-DDS02.1/3.1-PRJ1-EN-P	Jan. 97	rev. edition DDS02.1/03.1
DOK-DIAX02-DDS02.1/3.1-PRJ1-EN-E1,44	Apr. 97	E-Doc Release

Copyright

© INDRAMAT GmbH, 1993

Copying this document, and giving it to others and the use or communication of the contents thereof without express authority are forbidden. Offenders are liable for the payment of damages. All rights are reserved in the event of the grant of a patent or the registration of a utility model or design (DIN 34-1).

The electronic documentation (E-doc) may be copied as often as needed if such are to be used by the consumer for the purpose intended.

Published by

INDRAMAT GmbH • Bgm.-Dr.-Nebel-Str. 2 • D-97816 Lohr a. Main
Telefon 09352/40-0 • Tx 689421 • Fax 09352/40-4885
Abt. ENA (JH)

Service-Hotline: Tel. **0172 - 660 040 6** or **0171 - 333 882 6**

Validity

All rights are reserved with respect to the content of this documentation and the availability of the product.

Contents

1 Introducing the System	1-1
1.1 Individual components of the digital AC servo drive.....	1-2
1.2 Supply units for DDS02.1/03.1 drive controllers.....	1-2
2 Safety guidelines for electrical drives	2-1
2.1 General information.....	2-1
2.2 Guidelines for protection against contact with electrical parts	2-1
2.3 Guidelines on "protective low voltages"	2-3
2.4 Guidelines for protection against dangerous movements.....	2-3
2.5 Guidelines for protection when handling and installing	2-5
3 DDS02.1/03.1 drive controllers	3-1
3.1 Configured drive controllers	3-1
3.2 Drive controller, basic unit.....	3-4
Cooling methods.....	3-4
Motor feedback.....	3-4
3.3 Software module	3-7
Firmware.....	3-7
3.4 Firmware configuration.....	3-9
3.5 Plugin module.....	3-10
3.6 Configuration rating plate	3-12
3.7 Summary of components fitted in a configuration.....	3-13
4 Technical data	4-1
4.1 Power section.....	4-1
4.2 Current consumed during signal processing.....	4-2
4.3 Ambient and environmental conditions	4-4
4.4 Drive controller energy loss.....	4-5
Energy loss in the DDS02.1-W.....	4-5
Energy loss in the DDS02.1-A.....	4-6
Energy loss in the DDS02.1-F.....	4-7
Energy loss in the DDS03.1-W.....	4-8
4.5 Weight	4-8
5 Planning the construction of the control cabinet	5-1
5.1 Mounting the DDS02.1-W... drive controller.....	5-4
5.2 Mounting the DDS02.1-A... drive controller.....	5-5
5.3 Mounting the DDS02.1-F... drive controller	5-10
5.4 Mounting the DDS03.1-W...-... drive controller	5-12

5.5 Interference suppression and EMC.....	5-13
5.6 Using heat-exchanger units in control cabinets	5-13
6 Electrical connections of the drive controller	6-1
6.1 General notes.....	6-1
6.2 Connecting the basic unit.....	6-2
① Chassis earth connections to the supply unit	6-4
②③④ Connecting the motor power cable to the drive controller.....	6-4
④ Connector X6: Holding brake, motor temperature monitoring.....	6-7
⑤ DC bus voltage connection.....	6-7
⑥ Connector X1: Bus connections	6-8
⑦ Connector X3.....	6-9
⑧ Connector X2: interface RS232.....	6-11
⑨ Connector X4: Motor feedback.....	6-12
⑩ Connectors X13, X14a, X14b: heatsink blower only with DDS02.1-A.....	6-14
Summary terminal diagram	6-15
6.3 Connecting the plugin module.....	6-16
7 Accessories	7-1
7.1 Electrical connecting kit E..-DDS 2.....	7-2
7.2 Electrical accessories kit E..-DDS 3.....	7-4
7.3 Connector kit for various configurations.....	7-6
7.4 Service cable - IKS0391	7-7
7.5 Selecting the fiber optic cable connections	7-7
7.6 Mechanical accessories for DDS02.1-A***-*	7-8
7.7 Mechanical accessories for DDS02.1-F***-* drive controllers (with liquid cooling).....	7-9
8 Powering up the power sections via charging resistors	8-1
9 Condition at delivery	9-1
10 Identifying the merchandise	10-1
11 Storage and transportation	11-1
12 Index	12-1

1 Introducing the System



Fig. 1-1: A digital drive system with DDS

The modular concept makes it possible to flexibly combine AC servo and main drives to create one compact drive package which uses one supply unit.

In conjunction with the MDD, MKD and LAR AC motors, the DDS drive controller is a rapid-response drive. These drives are particularly well suited for use in machine tool, textile, printing and packaging machinery as well as robotics and handling machines.

1.1 Individual components of the digital AC servo drive

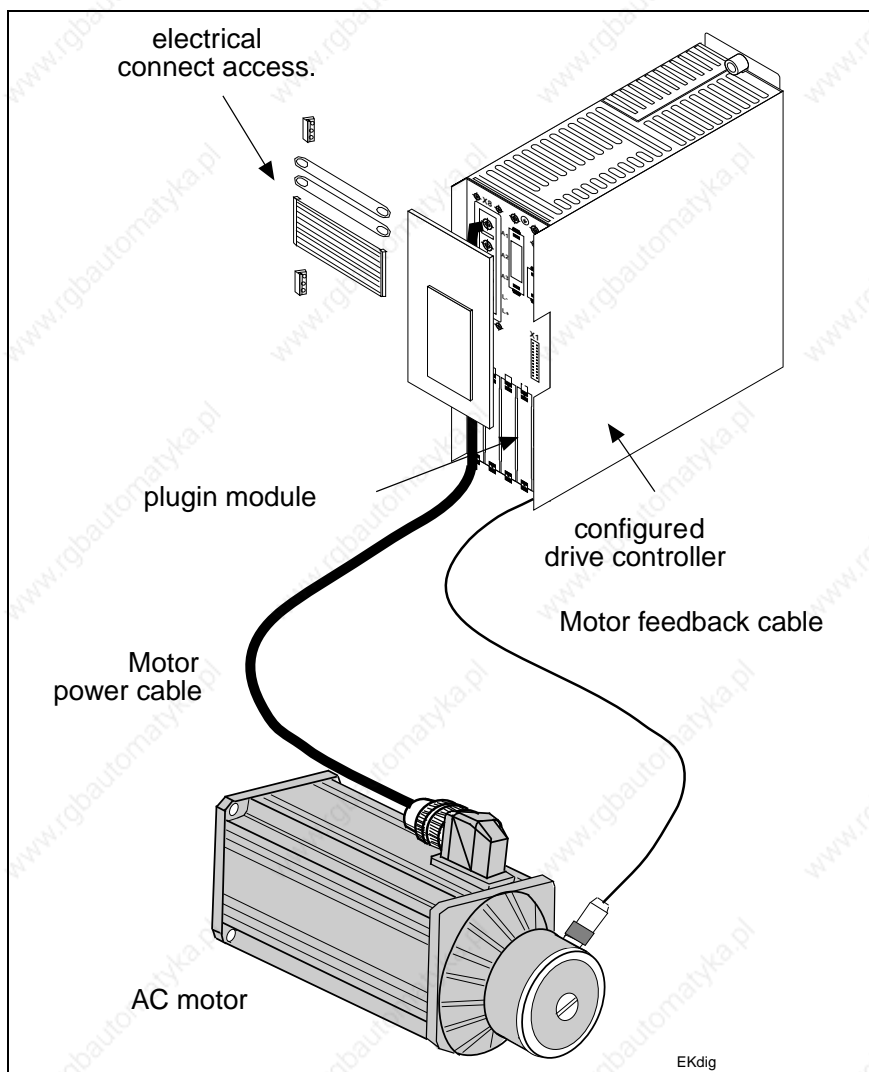

Fig. 1-2: Individual components of the digital AC drive

1.2 Supply units for DDS02.1/03.1 drive controllers

DDS drive controllers can be connected to all INDRAMAT supply units with a regulated DC 24V voltage.

Note: Do not operate the DDS with a TVM 1.2 supply unit. The DC 24V of the TVM 1.2 is not regulated.

If TVM 2.1, TVM 2.4 supply units or a KDV 1.3 are used with a DDS drive controller, then note the information in Section 8 when powering up the power section via charging resistors. The application descriptions for each individual supply units must also be noted.

2 Safety guidelines for electrical drives

Prior to using the units, please note the following guidelines on personnel safety.

2.1 General information

- The safety instructions in these user guidelines must be observed at all times. Improper use of this equipment and disregarding the warnings given here can lead to property damage, cause bodily injury or, in extreme cases, lead to death.

INDRAMAT is not liable for damages resulting from non-observance of the warnings given in these operating instructions.

- Documentation in the local language must be obtained prior to commissioning, if the language of the documentation at hand is not understood.
- Proper transport, correct storage, assembly and installation as well as careful operation are the prerequisites for optimal and safe operation of this equipment.
- Qualified personnel:

Only appropriately qualified personnel may work on this equipment or within its vicinity. Personnel are qualified if they have sufficient knowledge of the assembly, installation and operation of the product as well as of all warnings and safety measures in these operating instructions.

Furthermore, they should be trained, instructed or qualified to switch electrical circuits and equipment on and off, to earth and label them according to engineering regulations on safety. They should have adequate safety equipment and be trained in first aid.

- Only use spare parts approved by the manufacturer.
- The safety instructions and regulations for the application must be observed.
- The equipment is designed for installation in machines which are intended for commercial use.
- Start-up is only permitted once it is sure that the machine in which the products are installed complies with EC directive 89/392/EWG (machine directives).
- Operation is only permitted if the national EMC directives for the specific application permit it. Within the EU, EMC directive 89/336/EWG applies.

Guidelines for EMC compliant installation are outlined in the document "EMC for AC drives and controls".

Maintaining the national standards is the responsibility of the manufacturer of the machine or plant.

- Technical data, connection and installation conditions are outlined in the respective product documentation and must be maintained.

2.2 Guidelines for protection against contact with electrical parts

If live parts with voltages exceeding 50 volts are in any way open to contact, then this could lead to bodily injury. To operate electrical equipment it is necessary to apply certain parts of it with such dangerous voltages.

**DANGER****High electrical voltages!**

Danger to life and risk of injury!

- ⇒ Observe the general construction and safety guidelines for work on electrical power installations.
- ⇒ After installation, check that the earth wire is permanently connected to all electrical units as specified in the connection diagram.
- ⇒ Operation, even for brief measuring and test purposes, is only permitted when the earth wire is permanently connected to all electrical components.
- ⇒ Disconnect the equipment from the mains or the voltage source before working on electrical parts with voltages exceeding 50 volts. Secure the equipment against being switched back on again.
- ⇒ Wait five minutes after powering down before starting work on the equipment. This is due to the capacitors fitted in the equipment.
- ⇒ Do not touch the electrical connecting points of a component while it is switched on.
- ⇒ Cover live parts properly before switching the equipment on so that no contact is possible.
- ⇒ Provide protection against indirect contact (as per DIN EN 50178/ ed. 11/94, section 5.3.2.3).

**WARNING****High discharge current!**

Danger to life and risk of serious injury!

- ⇒ All units and the motor are to be connected to the earth wire at the earthable point or they must be earthed first before switching on.
- ⇒ The discharge current exceeds 3.5 mA. A permanent connection to the supply system is thus required for all units (as per DIN EN 50178/ ed. 11.94, sect. 5.3.2.3).
- ⇒ Always connect earth wire before starting up even when just testing. High voltages could otherwise be applied to the housing.

2.3 Guidelines on "protective low voltages"

The connections on the drive components and interfaces for the signal voltages range from 5 to 30 volts. These electrical circuits belong to the safely isolated electrical circuits (protective low voltages).



WARNING

High electrical voltages from incorrect connections!

Danger of life and limb or serious bodily injury!

⇒ Only those units, electrical components or cables which have, as per the standards, sufficient and safe isolation of connected electrical circuits may be attached to the signal voltages (per DIN EN 50178/ ed. 11.94, sect. 5.3.2.3).

2.4 Guidelines for protection against dangerous movements

Dangerous movements can occur for various reasons:

- as a result of an incorrect velocity command,
- a software error,
- physical component problems,
- faulty wiring or cable,
- an error in the value or signal encoder and
- incorrect use of components.

These errors can occur just after the equipment is turned on or after an indefinite period of time.

**Dangerous movements!**

Danger to life and risk of injury or of property damage!

⇒ The drive components monitoring devices make malfunctions in the connected drives almost impossible. In view of operator safety, however, this cannot be solely relied upon. An incorrect movement, the size of which depends on the kind of malfunction and operating status, must in any case be anticipated before the built-in monitoring devices are activated. Operator safety must thus be ensured with the use of monitoring devices or measures taken which are superordinate on the plant side. These are provided according to the specific conditions of the plant after a danger and error analysis by the plant constructor has been completed. The safety requirements which apply to the plant are included here.

⇒ Keep clear of the machine in that area in which movements could occur. Possible measures to take to prevent access are:

- protective fences
- protective railings
- covers
- light curtains

⇒ Fences and coverings should have sufficient strength to withstand the maximum possible momentum.

⇒ E-stop switches must be mounted in the immediate vicinity of an operator for easy reach. Check to make sure it is functional before starting up.

⇒ Isolate the drive power connection via an emergency stop circuit or use a starting lockout to protect against unintentional start ups.

⇒ Make sure that the drives are standing still before accessing or entering the danger zone.

⇒ De-energize electrical equipment using the master switch and secure against switching on again for:

- maintenance and repair work
- cleaning work
- or prior to long breaks in operation

⇒ Avoid operating high-frequency, remote control and radio equipment near the equipment electronics and supply leads. If use of such a unit cannot be avoided, check the system and the plant for possible malfunctions at all positions of normal use before the first start-up. If necessary, carry out a special EMC test on the plant.

2.5 Guidelines for protection when handling and installing



CAUTION

Risk of injury during handling!

Bodily injury caused by crushing, shearing, cutting and thrusting movements!

- ⇒ Observe the general construction and safety regulations for handling and installation.
- ⇒ Use suitable installation and transport equipment in a proper fashion. If necessary, use special tools.
- ⇒ Take suitable precautions to prevent pinching and crushing.
- ⇒ If necessary, wear suitable protective clothing, for example, protective eyewear, shoes or gloves.
- ⇒ Do not stand under suspended loads.
- ⇒ Wipe up liquids spilled onto the floor to prevent slipping.

3 DDS02.1/03.1 drive controllers

3.1 Configured drive controllers

The drive controllers are modular in design. The basic unit is adapted to different functions with the use of various modules. The drive controllers are delivered by INDRAMAT already configured in terms of the desired function.

A configured drive controller is made up of both hardware and firmware. The firmware fixes the functions of the drive controller.

A configured drive controller is made up of:

- basic unit of the drive controller
- plugin modules
- software modules
- firmware (in the software and plugin modules)

Configured DDS02.1-**_****_**-
FW drive controller**

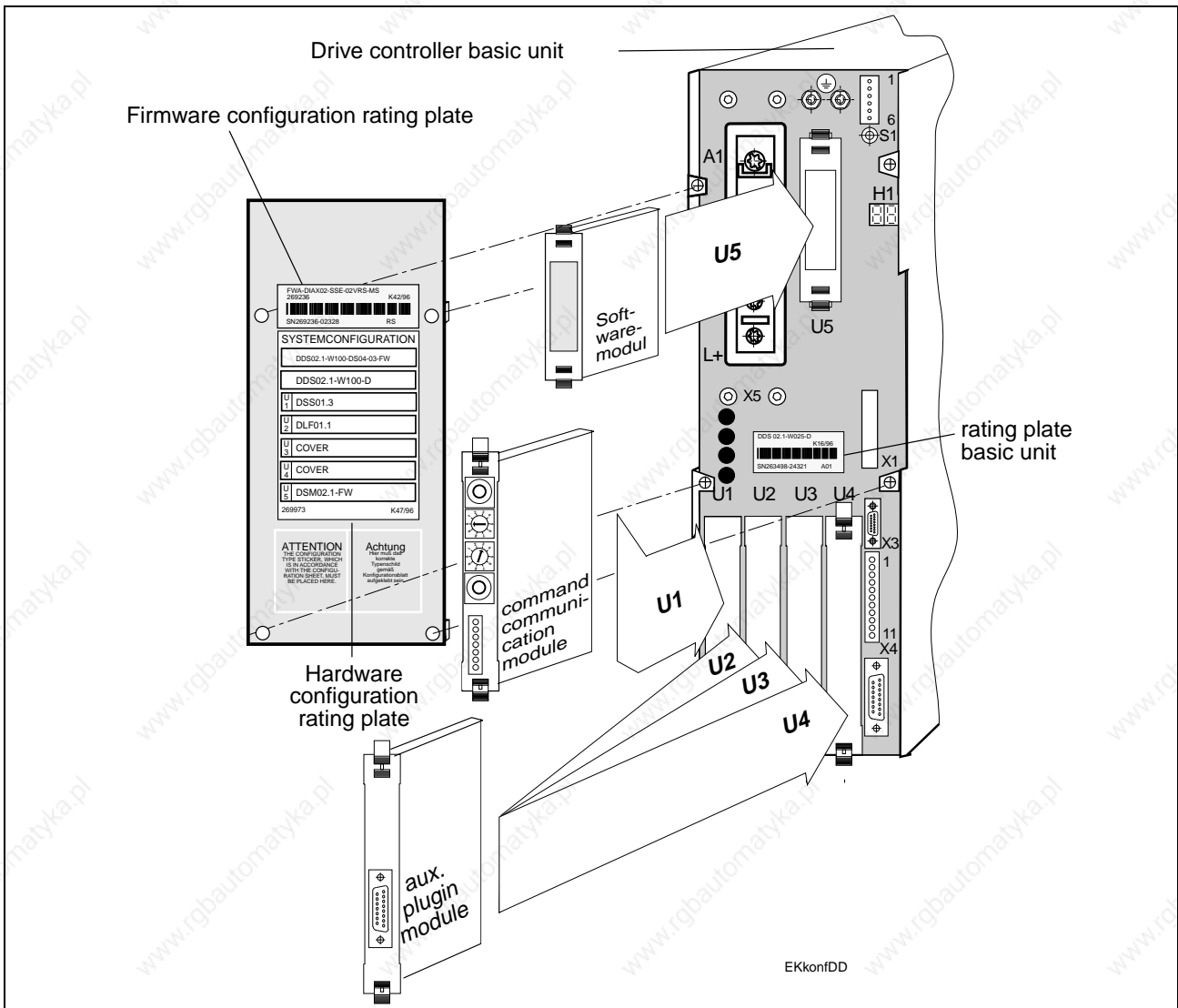

Fig. 3-1: The components of the configured DDS02.1-*** drive controller

Configured DDS03.1-**-****-**-
FW drive controller**

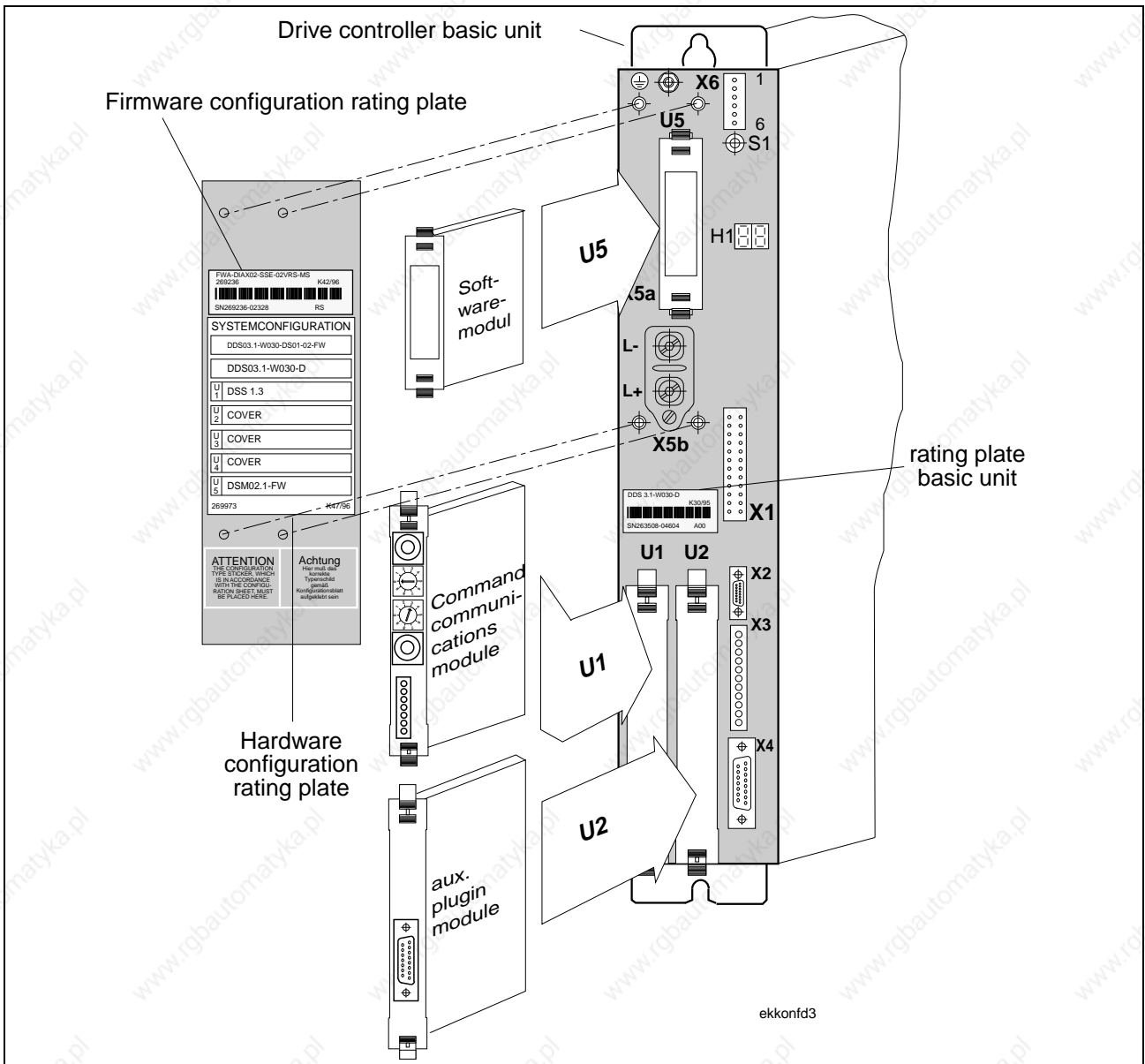

Fig. 3-2: The components of the configured DDS03.1-*** drive controller

Type codes

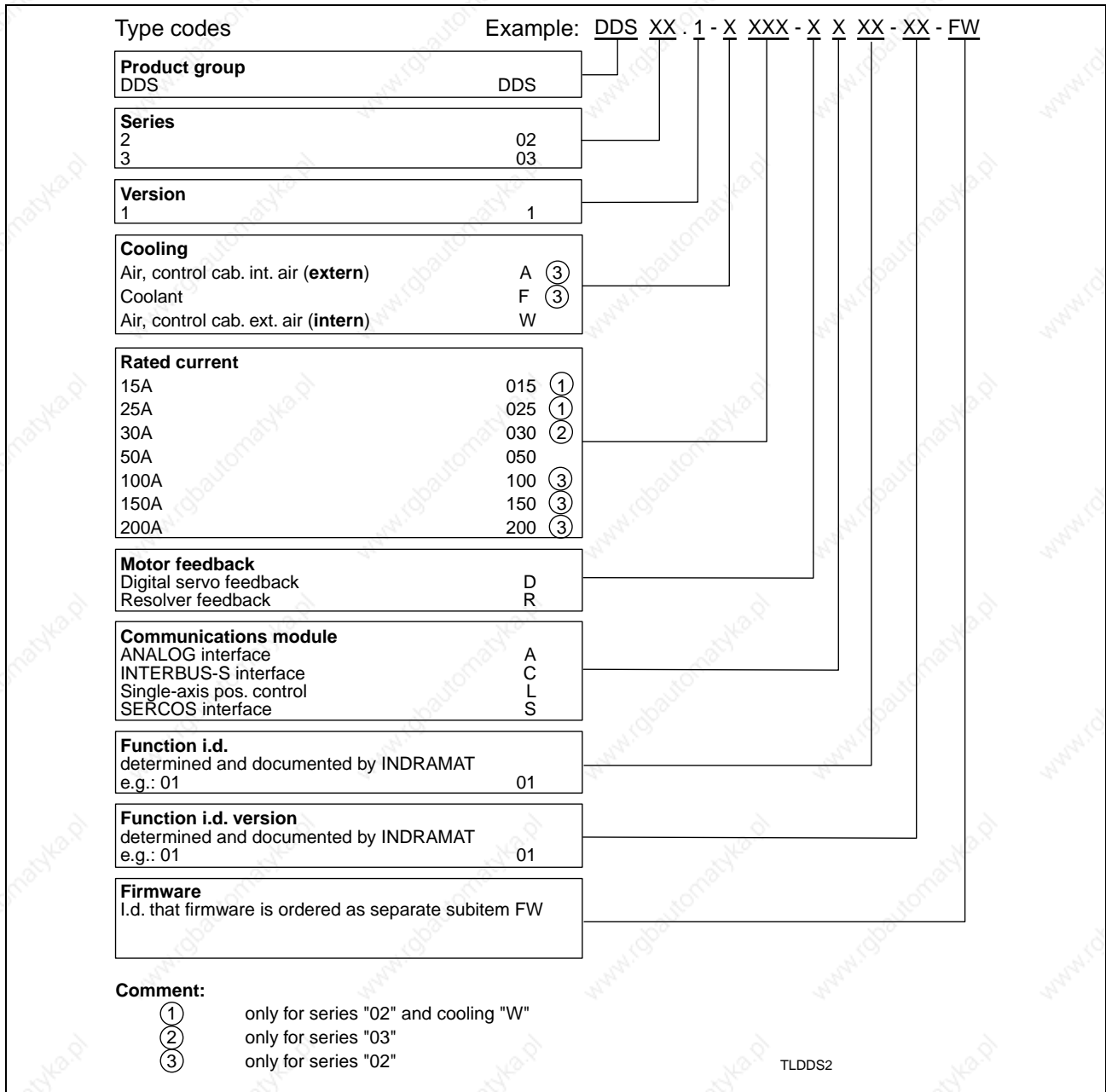

Fig. 3-3: Type codes of the configured DDS drive controller

3.2 Drive controller, basic unit

The slots of the basic unit are empty.

Cooling methods

INDRAMAT offers various cooling methods for the DDS02.1 drive controllers (see Fig. 3-4) .

Cooling methods:

- heat technology (cooling airflow inside the control cabinet)
- cold technology (cooling airflow outside the control cabinet)
- liquid cooling

Heat Technology

Units implementing heat technology dissipate heat within the control cabinet.

Consequentially:

- large control cabinet
- air conditioning may be needed

This requires the least amount of mounting and installation efforts.

Cold technology, liquid cooling

These units have the advantage that a large part of the heat is lost outside the control cabinet. As a result, these units can be mounted in small cabinets or housing.

Units with liquid cooling offer the additional advantage of regaining lost energy.

Motor feedback

i There are, independent of the rated current, two types of drive controllers (basic units). Only motors with **Digital Servo Feedback (DSF)** can be connected to the one type and only motors with **Resolver feedback (RSF)** (see Fig. 3-5 „Motor feedback“) can be connected at X4 of the other type.

Note: When selecting the motor/controller combination make sure that the motor feedback data type codes of motor and drive controller agree.

Cooling methods



Fig. 3-4: Cooling methods in DDS02.1 drive controller illustrated

Type codes



Fig. 3-5: Type codes of the DDS basic unit

3.3 Software module

Different functions require different software modules. The software module contains both firmware and drive parameters. The software module needed depends on the selected hardware configuration and the functions of the drive.

The software module guarantees that if the unit needs to be replaced, the already entered parameters can be carried over to the new unit.

Type codes



Fig. 3-6: Software module type codes

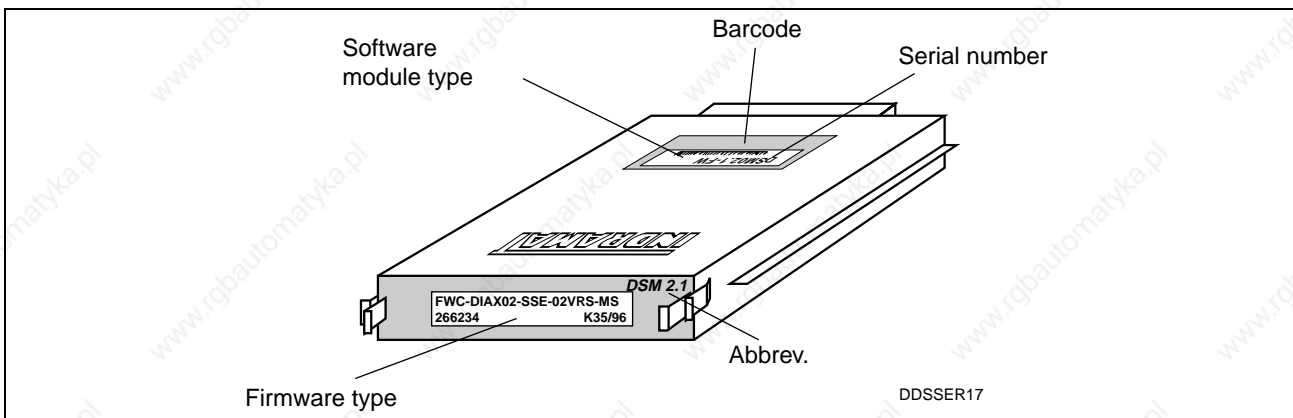

Fig. 3-7: Rating plates on the software module

Firmware

The functional features of the drive controllers are fixed by the firmware.

The firmware must be ordered as a separate item. This means that it is always possible to reorder the same firmware version.

The firmware is continuously being updated to function more accurately without, however, changing the functions. This designation is indicated in the type code as the firmware release status.

If new functions are added, then the index number of the firmware version is increased (see Fig. 3-8).

Type codes



Fig. 3-8: Firmware type codes

3.4 Firmware configuration

The firmware configuration identifies which firmware is used in the configured drive controller.

This means that the firmware configuration is used to determine which firmware the software module has and, if applicable, which firmware is in a plugin module. The rating plate of the firmware configuration is on the face plate.

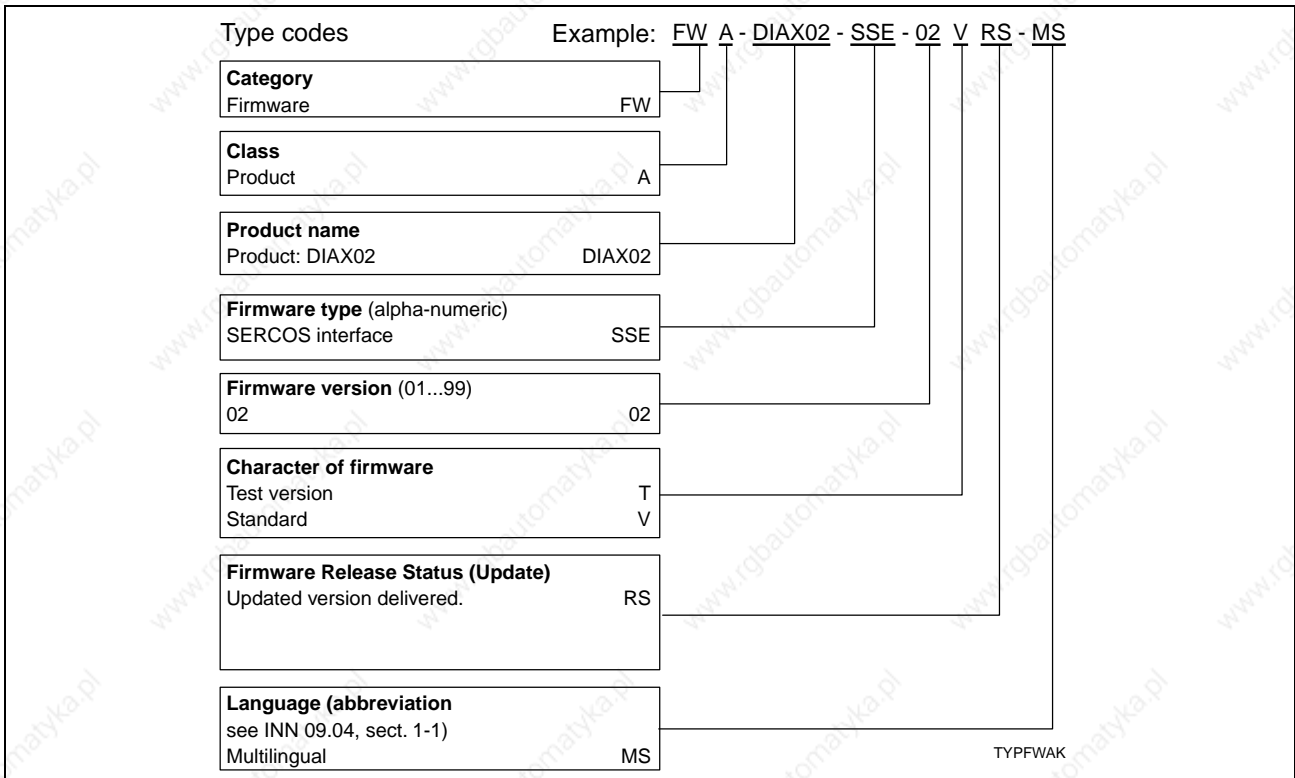

Fig. 3-9: Firmware configuration type codes

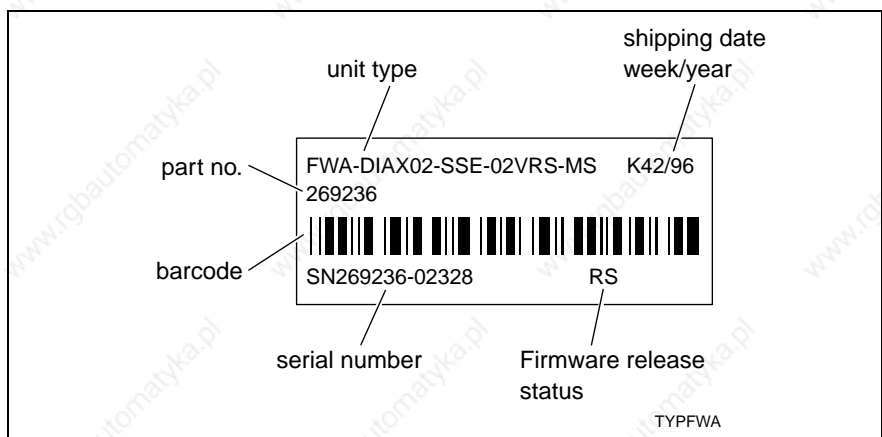

Fig. 3-10: Firmware configuration rating plate

3.5 Plugin module

Only a few of the plugin modules are introduced below. The precise functions offered by a specific firmware version are outlined in the respective function description.

SERCOS interface

Type: DSS01.1, DSS01.3

The plugin module "SERCOS interface DSS" makes it possible to operate the digital drive with SERCOS interface compatible controls via a fiber optic cable. It also offers inputs for evaluating reference switches, travel range limit switches and sensor inputs.

ANALOG interface with incremental encoder emulator

Type: DAE01.1

The plugin module "ANALOG interface with incremental encoder emulator" makes it possible to operate digital intelligent AC servo drives with conventional controls via an analog interface. It also contains control inputs and signal outputs for communicating with a connected control and generates incremental encoder signals for use as actual position values.

ANALOG interface with absolute encoder emulator

Type: DAA01.1

The plugin module "ANALOG interface with absolute encoder emulator" makes it possible to operate digital intelligent AC servo drives with conventional controls via an analog interface. It also contains control inputs and signal outputs for communicating with a connected control and generates actual position values which meet the SSI standard (synchronous serial interface).

Single axis positioning module

Type: DLC01.1, DLC02.1

The plugin module "single axis positioning module" expands the drive controller to create a standalone single axis positioning unit. This control can be programmed with up to 3000 program blocks. Each program block describes one motion sequence or a specific state of the inputs to be monitored or the outputs to be set. The DLC02.1 is functionally compatible with the DLC01.1. The DLC02.1, however, also has an additional interface to connect an INTERBUS-S module DBS02.2 .

Interbus S Slave interface

Type: DBS02.1

The interbus S slave interface DBS02.1 makes it possible to directly load speed values as per the DRIVECOM standard profile 21.

Interbus-S-Slave Interface

Type: DBS02.2

The interbus S slave interface DBS02.2 means that a DLC02.1 single positioning module can be connected which directly loads target positions as per DRIVECOM standard profile 22 and can handle the I/O level of the DLC.

Command card

Type: CLC-...

The CLC-... command card supports the central control of the drive units for the implementation of the "electronic shaft".

ARCNET coupler card

Type: DAK01.1

The DAK01.1 plugin module is a stackable card for the CLC-D02... command card and creates the interface to an ARCNET bus system.

Input/output interface

Type: DEA04.1, DEA05.1, DEA06.1

These plugin modules each have 15 inputs and 16 outputs via which the drive can exchange binary signals with a PLC. They are differentiated in terms of the address set.

Incremental position interface

Type: DEF01.1, DEF02.1

The plugin module "incremental position interface" supports the transmission of square wave signals for evaluating an external scale directly mounted to the moving machine component in the drive controller. They are differentiated in terms of the address set.

High resolution position interface

Type: DLF01.1

The plugin module "high resolution position interface" supports the transmission of sinusoidal signals for evaluating an external scale directly mounted to the moving machine component in the drive controller.

Summing input interface

Type: DSE01.1

The plugin module "summing input interface" makes two summing inputs available in addition to the differential input for a configuration with analogue interface. It is possible, via these summing inputs, to apply additional command values for the differential input at the analog interface.

Gearwheel encoder interface

Type: DZF01.1, DZF02.1

The plugin module „gearwheel interface“ supports the evaluation of the high-resolution main spindle position encoder.

Note: The technical data and the terminal diagrams of the plugin modules can be found in the document "DIAX02 plugin module for digital intelligent drive controllers".

3.6 Configuration rating plate

The type designations are on the configuration rating plate:

- the configured drive controller,
- the basic unit,
- the software module in slot U5
- and the plugin modules in slots U1 to U4.

These type designations can be used to determine which components ought to be in which slots.

In the event of a breakdown, the information on this plate can be used to quickly and efficiently obtain the correct replacement parts.

Note: The configuration rating plate supplies information about which modules of the drive controllers are in place. Please check, prior to commissioning the controller, that the correct modules are in place.

Note: When mounting the drive controller, the face plate is removed from the controller with the rating plate. Please make sure that the face plate is remounted to the drive controller from which it was removed.

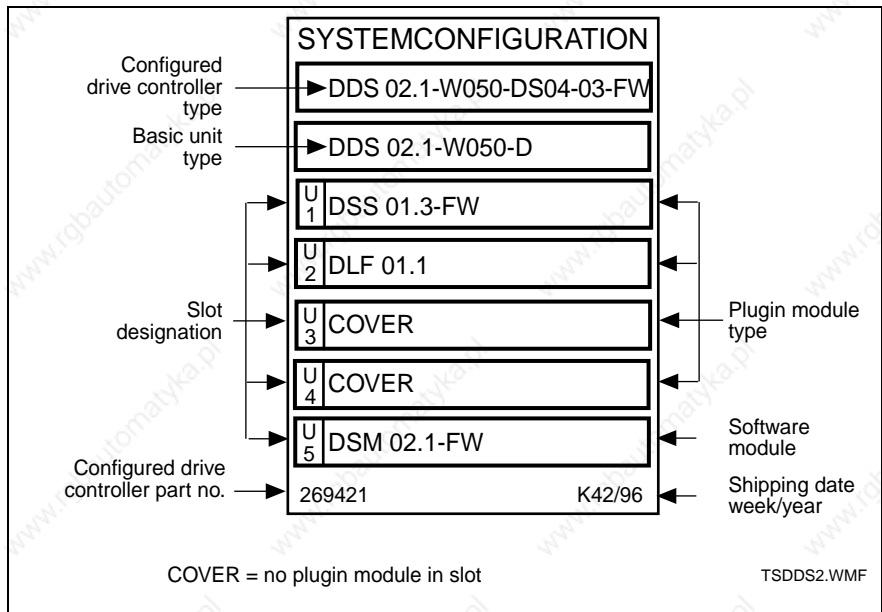

Fig. 3-11: An example of a configuration rating plate

3.7 Summary of components fitted in a configuration

Use this summary to identify which plugin module ought to be in a specific drive controller configuration.

Compare the configuration in the summary with the type of the configured drive controller.

If the suffix of the type designation agrees with a configuration in the summary, then the summary should list what is fitted into slots 1 through 4 of the basic unit.

This summary is no selection list for available configurations.

Configuration	Basic unit	Slot U1	Slot U2	Slot U3	Slot U4	Slot U5
DA01-01-FW	DDS0*.1-****-D	DAE01.1	COVER	COVER	COVER	DSM02.1-FW
DA02-01-FW	DDS0*.1-****-D	DAA01.1	COVER	COVER	COVER	DSM02.1-FW
DA03-01-FW	DDS0*.1-****-D	DAE01.1	DEA04.2	COVER	COVER	DSM02.1-FW
DA06-01-FW	DDS0*.1-****-D	DAE01.1	DLF01.1	COVER	COVER	DSM02.1-FW
DA07-02-FW	DDS0*.1-****-D	DAE01.1	DZF02.1	COVER	COVER	DSM02.1-FW
DA10-01-FW	DDS0*.1-****-D	DAE01.1	DEF01.1	COVER	COVER	DSM02.1-FW
DA11-01-FW	DDS0*.1-****-D	DAE01.1	DSE01.1	COVER	COVER	DSM02.1-FW
DA12-01-FW	DDS0*.1-****-D	DAA01.1	DSE01.1	COVER	COVER	DSM02.1-FW
DA14-01-FW	DDS0*.1-****-D	DAE01.1	DRF01.1	COVER	COVER	DSM02.1-FW
DC01-01-FW	DDS0*.1-****-D	DBS02.1-FW	COVER	COVER	COVER	DSM02.1-FW
DC02-01-FW	DDS0*.1-****-D	DBS02.1-FW	DEA04.1	COVER	COVER	DSM02.1-FW
DC03-01-FW	DDS0*.1-****-D	DBS02.1-FW	DEA04.1	DEA05.1	COVER	DSM02.1-FW
DC04-01-FW	DDS0*.1-****-D	DBS02.1-FW	DZF01.1	COVER	COVER	DSM02.1-FW
DL01-01-FW	DDS0*.1-****-D	DLC01.1-FW	DEA04.1	COVER	COVER	DSM02.1-FW
DL02-01-FW	DDS0*.1-****-D	DLC01.1-FW	DEA04.1	DEA05.1	COVER	DSM02.1-FW
DL03-01-FW	DDS0*.1-****-D	DLC01.1-FW	DEA04.1	DEA05.1	DEA06.1	DSM02.1-FW
DL04-01-FW	DDS0*.1-****-D	DLC01.1-FW	DEA04.1	DEF01.1	COVER	DSM02.1-FW
DL05-01-FW	DDS0*.1-****-D	DLC01.1-FW	DEA04.1	DEA05.1	DEF01.1	DSM02.1-FW
DL08-01-FW	DDS0*.1-****-D	DLC01.1-FW	DEA04.1	DFF01.1	COVER	DSM02.1-FW
DL09-01-FW	DDS0*.1-****-D	DLC01.1-FW	DEA04.1	DEA05.1	DFF01.1	DSM02.1-FW
DL10-01-FW	DDS0*.1-****-D	DLC01.1-FW	DEA04.1	DEF01.1	DEF02.1	DSM02.1-FW
DL11-01-FW	DDS0*.1-****-D	DLC01.1-FW	DEA04.1	DZF01.1	COVER	DSM02.1-FW
DL12-01-FW	DDS0*.1-****-D	DLC01.1-FW	DEA04.1	DEA05.1	DZF01.1	DSM02.1-FW
DL13-01-FW	DDS0*.1-****-D	DLC01.1-FW	DEA04.1	DEF02.1	DLF01.1	DSM02.1-FW
DL14-01-FW	DDS0*.1-****-D	DLC01.1-FW	DEA04.1	DLF01.1	COVER	DSM02.1-FW
DL20-01-FW	DDS0*.1-****-D	DLC02.1-FW	DBS02.2-FW	COVER	COVER	DSM02.1-FW
DL21-01-FW	DDS0*.1-****-D	DLC02.1-FW	COVER	DBS02.2-FW	COVER	DSM02.1-FW
DL22-01-FW	DDS0*.1-****-D	DLC02.1-FW	DBS02.2-FW	DEA04.1	COVER	DSM02.1-FW
DL23-01-FW	DDS0*.1-****-D	DLC02.1-FW	DEA04.1	DBS02.2-FW	COVER	DSM02.1-FW
DL24-01-FW	DDS0*.1-****-D	DLC02.1-FW	DBS02.2-FW	DEA04.1	DEA05.1	DSM02.1-FW
DL25-01-FW	DDS0*.1-****-D	DLC02.1-FW	DEA04.1	DBS02.2-FW	DEA05.1	DSM02.1-FW
DL26-01-FW	DDS0*.1-****-D	DLC02.1-FW	DBS02.2-FW	DEA04.1	DEF01.1	DSM02.1-FW
DL27-01-FW	DDS0*.1-****-D	DLC02.1-FW	DEA04.1	DBS02.2-FW	DEF01.1	DSM02.1-FW
DL28-01-FW	DDS0*.1-****-D	DLC02.1-FW	DBS02.2-FW	DFF01.1	COVER	DSM02.1-FW
DL29-01-FW	DDS0*.1-****-D	DLC02.1-FW	DFF01.1	DBS02.2-FW	COVER	DSM02.1-FW
DL30-01-FW	DDS0*.1-****-D	DLC02.1-FW	DBS02.2-FW	DEF01.1	COVER	DSM02.1-FW
DL31-01-FW	DDS0*.1-****-D	DLC02.1-FW	DEF01.1	DBS02.2-FW	COVER	DSM02.1-FW

Configuration	Basic unit	Slot U1	Slot U2	Slot U3	Slot U4	Slot U5
DL40-01-FW	DDS0*.1-****-D	DLC01.1-FW	DPF02.1	COVER	COVER	DSM02.1-FW
DL41-01-FW	DDS0*.1-****-D	DLC01.1-FW	DPF02.1	DEF01.1	COVER	DSM02.1-FW
DL42-01-FW	DDS0*.1-****-D	DLC01.1-FW	DPF02.1	DFF01.1	COVER	DSM02.1-FW
DL43-01-FW	DDS0*.1-****-D	DLC01.1-FW	DPF02.1	DPF03.1	COVER	DSM02.1-FW
DL45-01-FW	DDS0*.1-****-D	DLC01.1-FW	DPF02.1	DEA05.1	COVER	DSM02.1-FW
DS01-02-FW	DDS0*.1-****-D	DSS01.3-FW	COVER	COVER	COVER	DSM02.1-FW
DS03-02-FW	DDS0*.1-****-D	DSS01.3-FW	DEF01.1	COVER	COVER	DSM02.1-FW
DS04-03-FW	DDS0*.1-****-D	DSS01.3-FW	DLF01.1	COVER	COVER	DSM02.1-FW
DS05-01-FW	DDS0*.1-****-D	DSS01.1-FW	DEF01.1	DEF02.1	COVER	DSM02.1-FW
DS06-02-FW	DDS0*.1-****-D	DSS01.1-FW	DLF01.1	DFF01.1	CLC-D02.1A-FW	DSM02.1-FW
DS08-01-FW	DDS0*.1-****-D	DSS01.1-FW	DLF01.1	DFF01.1	COVER	DSM02.1-FW
DS09-01-FW	DDS0*.1-****-D	DSS01.3-FW	DFF01.1	COVER	COVER	DSM02.1-FW
DS13-01-FW	DDS0*.1-****-D	DSS01.1-FW	DLF01.1	COVER	COVER	DSM02.1-FW
DS22-02-FW	DDS0*.1-****-D	DSS01.3-FW	DLF01.1	DEA04.2	COVER	DSM02.1-FW
DS24-03-FW	DDS0*.1-****-D	DSS01.3-FW	CLC-D02.1A-FW	DEA04.2	COVER	DSM02.1-FW
DS25-01-FW	DDS0*.1-****-D	DSS01.1-FW	DLF01.1	DSS02.1	COVER	DSM02.1-FW
DS37-01-FW	DDS0*.1-****-D	DSS01.3-FW	DZF02.1	COVER	COVER	DSM02.1-FW
DS40-02-FW	DDS0*.1-****-D	DSS01.3-FW	DRF01.1	COVER	COVER	DSM02.1-FW
DS41-00-FW	DDS0*.1-****-D	DSS01.3-FW	CLC-D02.1A-FW	COVER	COVER	DSM02.1-FW
DS45-00-FW	DDS0*.1-****-D	DSS01.3-FW	CLC-D02.1A-FW	DEA04.2	DEA05.2	DSM02.1-FW
DS46-00-FW	DDS0*.1-****-D	DSS01.3-FW	CLC-D02.2A-FW	DBS03.1-FW	COVER	DSM02.1-FW
DS46-01-FW	DDS0*.1-****-D	DSS01.3-FW	CLC-D02.2A-FW	COVER	DBS03.1-FW	DSM02.1-FW
DS47-00-FW	DDS0*.1-****-D	DSS01.3-FW	CLC-D02.2A-FW	DBS03.1-FW	DLF01.1	DSM02.1-FW
DS47-01-FW	DDS0*.1-****-D	DSS01.3-FW	CLC-D02.2A-FW	DLF01.1	DBS03.1-FW	DSM02.1-FW
DS48-00-FW	DDS0*.1-****-D	DSS01.1-FW	DLF01.1	DEF02.1	COVER	DSM02.1-FW
DS50-00-FW	DDS0*.1-****-D	DSS01.3-FW	CLC-D02.2A-FW	DEA04.2	COVER	DSM02.1-FW
DS51-00-FW	DDS0*.1-****-D	DSS01.3-FW	CLC-D02.2A-FW	DEA04.2	DLF01.1	DSM02.1-FW
DS51-01-FW	DDS0*.1-****-D	DSS01.3-FW	CLC-D02.1A-FW	DEA04.2	DLF01.1	DSM02.1-FW
DS53-00-FW	DDS0*.1-****-D	DSS01.3-FW	CLC-D02.1A-FW	DEA04.2	DEF02.1	DSM02.1-FW
DS54-00-FW	DDS0*.1-****-D	DSS01.3-FW	DEA04.2	DEA05.2	COVER	DSM02.1-FW
DS55-00-FW	DDS0*.1-****-D	DSS01.3-FW	DEF01.1	DEA04.2	COVER	DSM02.1-FW
DS56-00-FW	DDS0*.1-****-D	DSS01.3-FW	DEA04.2	COVER	COVER	DSM02.1-FW
DS57-00-FW	DDS0*.1-****-D	DSS01.3-FW	CLC-D02.2A-FW	DBS03.1-FW	DEF01.1	DSM02.1-FW
DS57-01-FW	DDS0*.1-****-D	DSS01.3-FW	CLC-D02.2A-FW	DEF01.1	DBS03.1-FW	DSM02.1-FW
DS58-00-FW	DDS0*.1-****-D	DSS01.3-FW	CLC-D02.2A-FW	DPF05.1-FW	COVER	DSM02.1-FW
DS58-50-FW	DDS0*.1-****-D	DSS01.3-FW	CLC-D02.2A-FW	COVER	DPF05.1-FW	DSM02.1-FW
DS59-00-FW	DDS0*.1-****-D	DSS01.3-FW	CLC-D02.2A-FW	DPF05.1-FW	DLF01.1	DSM02.1-FW
DS59-50-FW	DDS0*.1-****-D	DSS01.3-FW	CLC-D02.2A-FW	DLF01.1	DPF05.1-FW	DSM02.1-FW
DS60-00-FW	DDS0*.1-****-D	DSS01.3-FW	CLC-D02.2A-FW	DPF05.1-FW	DEF01.1	DSM02.1-FW
DS60-50-FW	DDS0*.1-****-D	DSS01.3-FW	CLC-D02.2A-FW	DEF01.1	DPF05.1-FW	DSM02.1-FW
DS61-00-FW	DDS0*.1-****-D	DSS01.3-FW	DEA04.2	DEA05.2	DLF01.1	DSM02.1-FW
RA01-02-FW	DDS0*.1-****-R	DAE01.1	COVER	COVER	COVER	DSM02.1-FW
RA02-02-FW	DDS0*.1-****-R	DAA01.1	COVER	COVER	COVER	DSM02.1-FW
RA11-01-FW	DDS0*.1-****-R	DAE01.1	DSE01.1	COVER	COVER	DSM02.1-FW
RA12-01-FW	DDS0*.1-****-R	DAA01.1	DSE01.1	COVER	COVER	DSM02.1-FW
RC01-01-FW	DDS0*.1-****-R	DBS02.1-FW	COVER	COVER	COVER	DSM02.1-FW
RC02-01-FW	DDS0*.1-****-R	DBS02.1-FW	DEA04.1	COVER	COVER	DSM02.1-FW
RC03-01-FW	DDS0*.1-****-R	DBS02.1-FW	DEA04.1	DEA05.1	COVER	DSM02.1-FW
RL01-01-FW	DDS0*.1-****-R	DLC01.1-FW	DEA04.1	COVER	COVER	DSM02.1-FW
RL02-01-FW	DDS0*.1-****-R	DLC01.1-FW	DEA04.1	DEA05.1	COVER	DSM02.1-FW

Configuration	Basic unit	Slot U1	Slot U2	Slot U3	Slot U4	Slot U5
RL03-01-FW	DDS0*.1-****-R	DLC01.1-FW	DEA04.1	DEA05.1	DEA06.1	DSM02.1-FW
RL04-01-FW	DDS0*.1-****-R	DLC01.1-FW	DEA04.1	DEF01.1	COVER	DSM02.1-FW
RL05-01-FW	DDS0*.1-****-R	DLC01.1-FW	DEA04.1	DEA05.1	DEF01.1	DSM02.1-FW
RL08-01-FW	DDS0*.1-****-R	DLC01.1-FW	DEA04.1	DFF01.1	COVER	DSM02.1-FW
RL09-01-FW	DDS0*.1-****-R	DLC01.1-FW	DEA04.1	DEA05.1	DFF01.1	DSM02.1-FW
RL10-01-FW	DDS0*.1-****-R	DLC01.1-FW	DEA04.1	DEF01.1	DEF02.1	DSM02.1-FW
RL20-01-FW	DDS0*.1-****-R	DLC02.1-FW	DBS02.2-FW	COVER	COVER	DSM02.1-FW
RL21-01-FW	DDS0*.1-****-R	DLC02.1-FW	COVER	DBS02.2-FW	COVER	DSM02.1-FW
RL22-01-FW	DDS0*.1-****-R	DLC02.1-FW	DBS02.2-FW	DEA04.1	COVER	DSM02.1-FW
RL23-01-FW	DDS0*.1-****-R	DLC02.1-FW	DEA04.1	DBS02.2-FW	COVER	DSM02.1-FW
RL24-01-FW	DDS0*.1-****-R	DLC02.1-FW	DBS02.2-FW	DEA04.1	DEA05.1	DSM02.1-FW
RL25-01-FW	DDS0*.1-****-R	DLC02.1-FW	DEA04.1	DBS02.2-FW	DEA05.1	DSM02.1-FW
RL26-01-FW	DDS0*.1-****-R	DLC02.1-FW	DBS02.2-FW	DEA04.1	DEF01.1	DSM02.1-FW
RL27-01-FW	DDS0*.1-****-R	DLC02.1-FW	DEA04.1	DBS02.2-FW	DEF01.1	DSM02.1-FW
RL28-01-FW	DDS0*.1-****-R	DLC02.1-FW	DBS02.2-FW	DFF01.1	COVER	DSM02.1-FW
RL29-01-FW	DDS0*.1-****-R	DLC02.1-FW	DFF01.1	DBS02.2-FW	COVER	DSM02.1-FW
RL30-01-FW	DDS0*.1-****-R	DLC02.1-FW	DBS02.2-FW	DEF01.1	COVER	DSM02.1-FW
RL31-01-FW	DDS0*.1-****-R	DLC02.1-FW	DEF01.1	DBS02.2-FW	COVER	DSM02.1-FW
RS01-03-FW	DDS0*.1-****-R	DSS01.3-FW	COVER	COVER	COVER	DSM02.1-FW
RS03-03-FW	DDS0*.1-****-R	DSS01.3-FW	DEF01.1	COVER	COVER	DSM02.1-FW
RS04-03-FW	DDS0*.1-****-R	DSS01.3-FW	DLF01.1	COVER	COVER	DSM02.1-FW
RS16-02-FW	DDS0*.1-****-R	DSS01.3-FW	DZF02.1	COVER	COVER	DSM02.1-FW
RS18-02-FW	DDS0*.1-****-R	DSS01.3-FW	DEA04.2	COVER	COVER	DSM02.1-FW

Fig. 3-12: Summary of components of the basic units fitted in different configurations

4 Technical data

4.1 Power section

DC bus voltage

Designation	Value	Unit
DC bus voltage	300 +/- 15%	V

Fig. 4-1: DC bus voltage

Allocation of peak and continuous currents

An "overload factor" can be found in the motor/controller selection list. Using this overload factor it is possible to set the continuous current of the controller at the time of commissioning in terms of the motor. The controller peak current is set as dependent upon the continuous controller current.

In the second column, the possible continuous current is listed for the maximum peak current and in the third column, the possible peak current is given for the maximum continuous current in the following list.

Drive controller	Maximum peak current / continuous current	Peak current / maximum continuous current
DDS02.1-W015-...	15A / 15A	15A / 15A
DDS02.1-W025-...	25A / 25A	25A / 25A
DDS03.1-W030-...	30A / 10A	15A / 15A
DDS03.1-W050-...	50A / 20A	50A / 20A
DDS02.1-W050-...	50A / 40A	50A / 40A
DDS02.1-A050-...	50A / 50A	50A / 50 A
DDS02.1-F050-...	50A / 50A	50A / 50A
DDS02.1-W100-...	100A / 40A	60A / 60A
DDS02.1-A100-...	100A / 80A	90A / 90A
DDS02.1-F100-...	100A / 100A	100A / 100A
DDS02.1-W150-...	150A / 65A	80A / 80A
DDS02.1-A150-...	150A / 105A	150A / 105A
DDS02.1-F150-...	150A / 105A	150A / 105A
DDS02.1-W200-...	200A / 65A	90A / 90A
DDS02.1-A200-...	200A / 85A	160A / 105A
DDS02.1-F200-...	200A / 105A	200A / 105A

Fig. 4-2: Allocating peak and continuous currents

4.2 Current consumed during signal processing

Current consumed during signal processing

The supply unit makes available the DC +24V - and DC +/- 15V - voltages for all connected drive controllers. The sum of the current consumed by all the controllers connected to the supply unit may not exceed the permissible current output of the supply unit.

Generally applicable for the current consumption of the drive controller is DC +/-15V ea. 200 mA , for DC +24V 1100 mA.

For detailed calculations, the current consumption for one drive unit can be determined as follows:

Current consumption of the basic unit

+ current consumption of the plugin module in the basic unit

+ current consumption of the motor feedback with MDD and MKD motors

= current consumption for one drive unit

Current consumption of the basic unit

Controller types	Current consumption DC +15V in mA	Current consumption DC -15V in mA	Current consumption DC +24V in mA
DDS02.1-...	150	150	500
DDS03.1-...	150	150	500

Fig. 4-3: Current consumption of the basic unit

Current consumption of the motor feedback

Use the type code of the motor to locate the designation of the motor feedback.

Motor feedback	Current consumption DC +15V in mA	Current consumption DC -15V in mA	Current consumption DC +24V in mA
G	25	5	0
K	25	5	0
L	0	0	40
M	0	0	60
S	0	0	40
T	20	0	0

Fig. 4-4: Motor feedback current consumption

**Current consumption of the
plugin modules**

Plugin module type	Current con- sumption DC +15V in mA	Current con- sumption DC -15V in mA	Current con- sumption DC +24V in mA
CLC-D02.1A-FW	0	0	200
CLC-D02.2A-FW	0	0	200
DAA01.1	30	30	70
DAE01.1	30	30	70
DAK01.1A	0	0	70
DBS02.1-FW	0	0	130
DBS02.2-FW	0	0	130
DBS03.1-FW	0	0	130
DEA04.1	0	0	40
DEA04.2	0	0	40
DEA05.1	0	0	40
DEA05.2	0	0	40
DEA06.1	0	0	40
DEF01.1	0	0	150
DEF02.1	0	0	150
DFF01.1	45	45	45
DLC01.1	0	0	80
DLC02.1	0	0	80
DLC02.1-FW	0	0	80
DLF01.1	40	40	130
DPF05.1-FW	0	0	100
DRF01.1	50	50	15
DSE01.1	20	10	0
DSS01.1	0	0	110
DSS01.3-FW	0	0	110
DSS02.1	0	0	110
DZF01.1	30	40	150
DZF02.1	30	40	150

Fig. 4-5: Current consumption of the plugin module

4.3 Ambient and environmental conditions

Designation	Value	Unit
Permissible ambient temperature with rated data	+0...+45	°C
Max. Permissible ambient temperature with derated data	+55	°C
Storage and transport temperature	-30...+85	°C
Max. Installation elevation with rated data	1000	m
Max. Permissible relative air humidity	95	%
Max. Permissible absolute air humidity	25	g/m ³
Protection category	IP20, per EN 60529 = DIN VDE 0470-1-1992 (IEC 529-1989)	

Fig. 4-6: Ambient and environmental conditions

Deviating ambient conditions

Selection data are listed for each motor/controller combination.

These data apply within the indicated ambient temperature and installation elevations.

If conditions differ, then the continuous torque at standstill M_{dN} and short-term torque M_{KB} drop as illustrated. If both occur simultaneously, then both load factors must be multiplied.



Fig. 4-7: Load capacity as dependent on ambient temperature and installation elevation

4.4 Drive controller energy loss

Determining energy loss in the controller by adding the maximum energy loss to the controller type does not account for the actual continuous load of the controller.

Over an average period of time, the maximum amount of the continuous current at standstill I_{dN} of the motor flows through the controller (see motor documentation).

The actually resulting energy loss depends on the continuous current at standstill I_{dN} of the connected motor. The continuous current at standstill I_{dN} is listed in the motor documentation.

Example: determining energy loss

Controller:	DDS 2.1 - W050 - ...
Motor:	MDD 093A-N-020-...
Standstill current I_{dN} of the motor:	9.5A
Energy loss as determined in Fig. 4-8:	approx.. 80 W

Energy loss in the DDS02.1-W...

Energy loss in the control cabinet



Fig. 4-8: Determining the energy lost in the control cabinet

Energy loss in the DDS02.1-A...

Energy loss in the control cabinet



Fig. 4-9: Determining the energy lost in the control cabinet

Energy loss outside the control cabinet



Fig. 4-10: Determining the energy lost via the heatsink and conducted outside the control cabinet

Energy loss in the DDS02.1-F...

Energy loss in the control cabinet

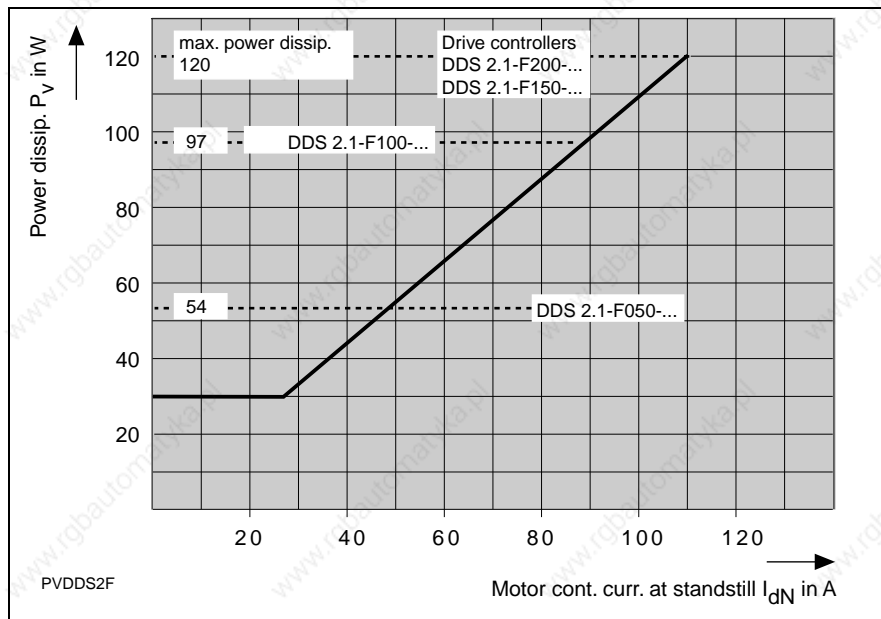

Fig. 4-11: Determining energy lost in the control cabinet

Energy loss via the coolant

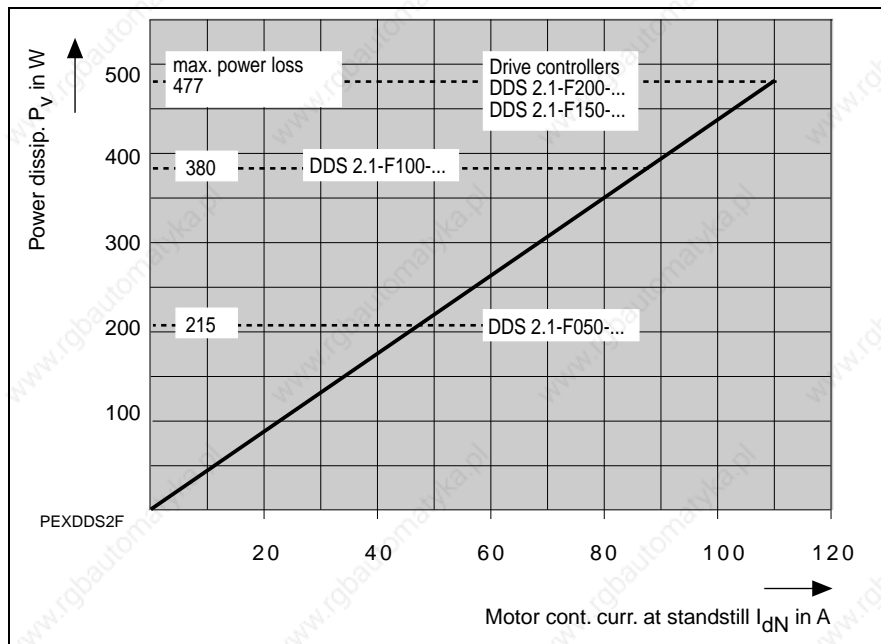

Fig. 4-12: Determining energy lost via the coolant

Energy loss in the DDS03.1-W...

Energy loss in the control cabinet



Fig. 4-13: Determining energy lost in the control cabinet

4.5 Weight

Drive controller type	Weight in kg
DDS02.1-W...-. (heat technology)	approx. 7.5
DDS02.1-A...-. (cold technology)	approx. 11
DDS02.1-F...-. (liquid cooling)	approx. 11
DDS03.1-W...-. (heat technology)	approx. 5.5

Fig. 4-14: Drive controller weight

5 Planning the construction of the control cabinet

Mounting conditions

The drive controller and its supply unit are designed for mounting into a control cabinet or a closed housing and meet the demands of protection category IP 10, as per DIN 40 050.

The unit is protected against penetration by a solid extrinsic object with a diameter exceeding 50 mm.

The unit is not protected against

- penetration by water
- intentional accessing by a hand, for example, but it will keep larger body surfaces out.

Arranging the controller

Position the drive with high output and excessive current levels as close to the supply unit as possible.

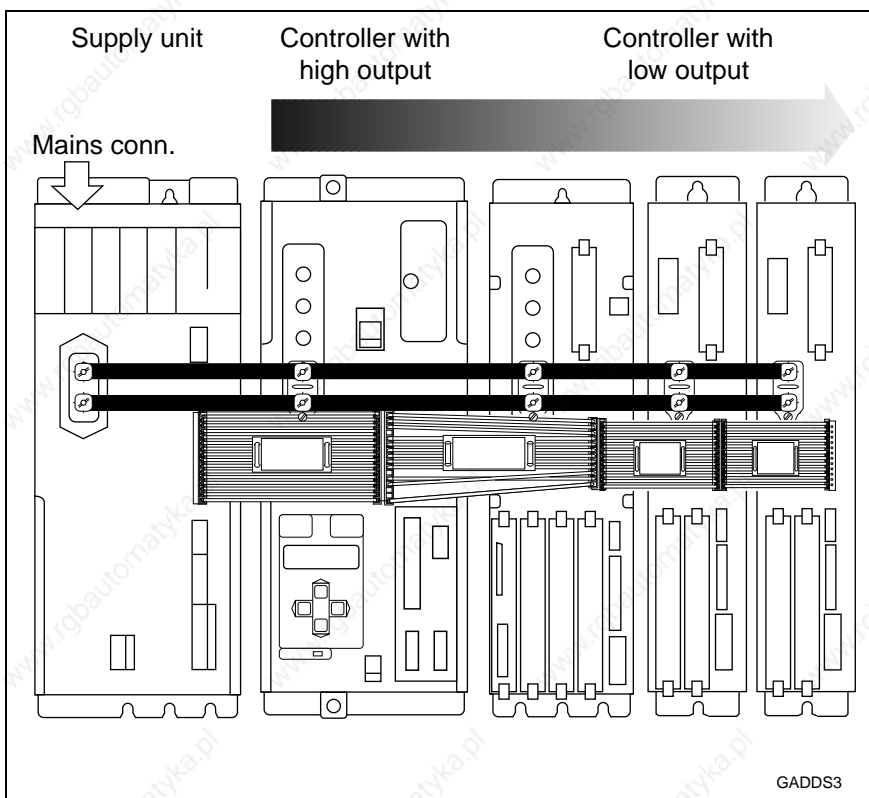

Fig. 5-1: Recommended position of the unit inside the control cabinet

Clearance dimensions DDS02.1



Fig. 5-2: Clearance dimensions of the DDS02.1 within the control cabinet

**Clearance dimensions for
DDS03.1**



Fig. 5-3: Clearance dimensions for the DDS03.1 within the control cabinet

5.1 Mounting the DDS02.1-W... drive controller



Fig. 5-4: Dimensional sheet - DDS02.1-W...

5.2 Mounting the DDS02.1-A... drive controller

Drive controller mounted into the control cabinet

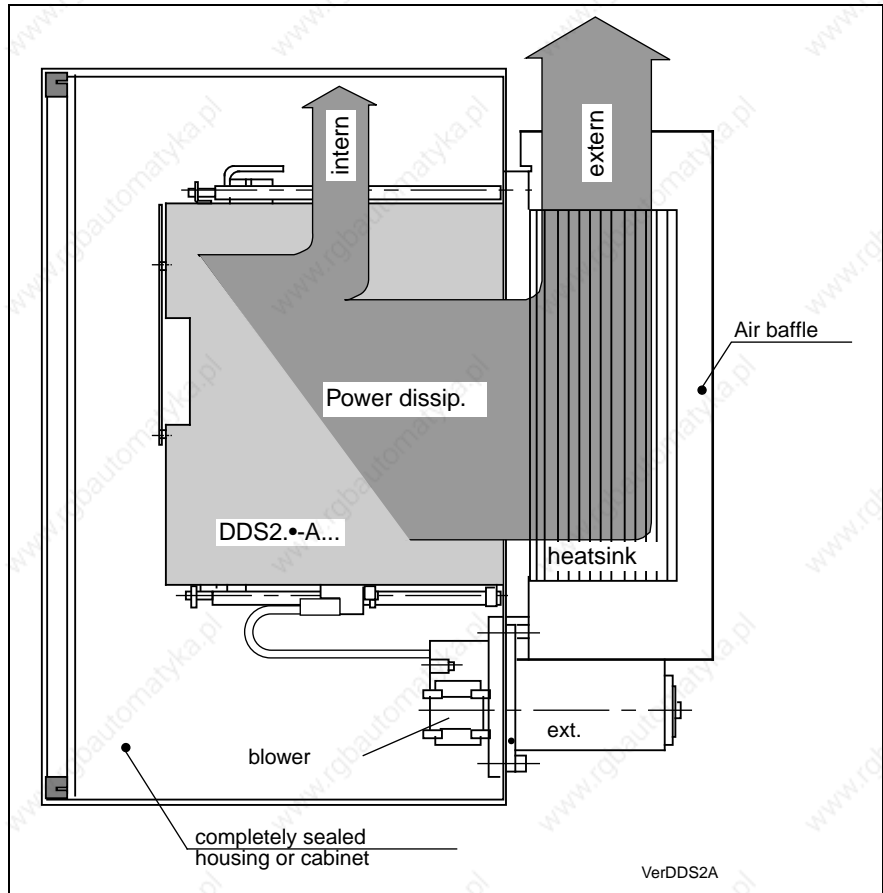

Fig. 5-5: The DDS02.1-A... drive controller mounted in the control cabinet

Power dissipation

The DS02.1-A... drive controller has the advantage that most of the energy lost by the unit is directly conducted outside thus not accumulating within the control cabinet. These units can therefore be mounted into small control cabinets or housing without requiring extensive heat conductance or expensive heat-exchanging units.

Blower unit

The electrical section of the blower is protected within the control cabinet (see Fig. 5-5). The heatsink of the power section and the blower impeller are outside the control cabinet or housing.

Mounting panel

Using a mounting panel, the units are mounted into the therefore provided space on the backwall of the cabinet in such a way that the heatsink with casing sticks out of the cabinet. The opening within the cabinet is sealed with a seal ring at the mounting flange of the unit after mounting (see Fig. 5-7). Mounting and exchange of the drive controller and external blower can be performed on the inside of the control cabinet.

Dimensional sheet

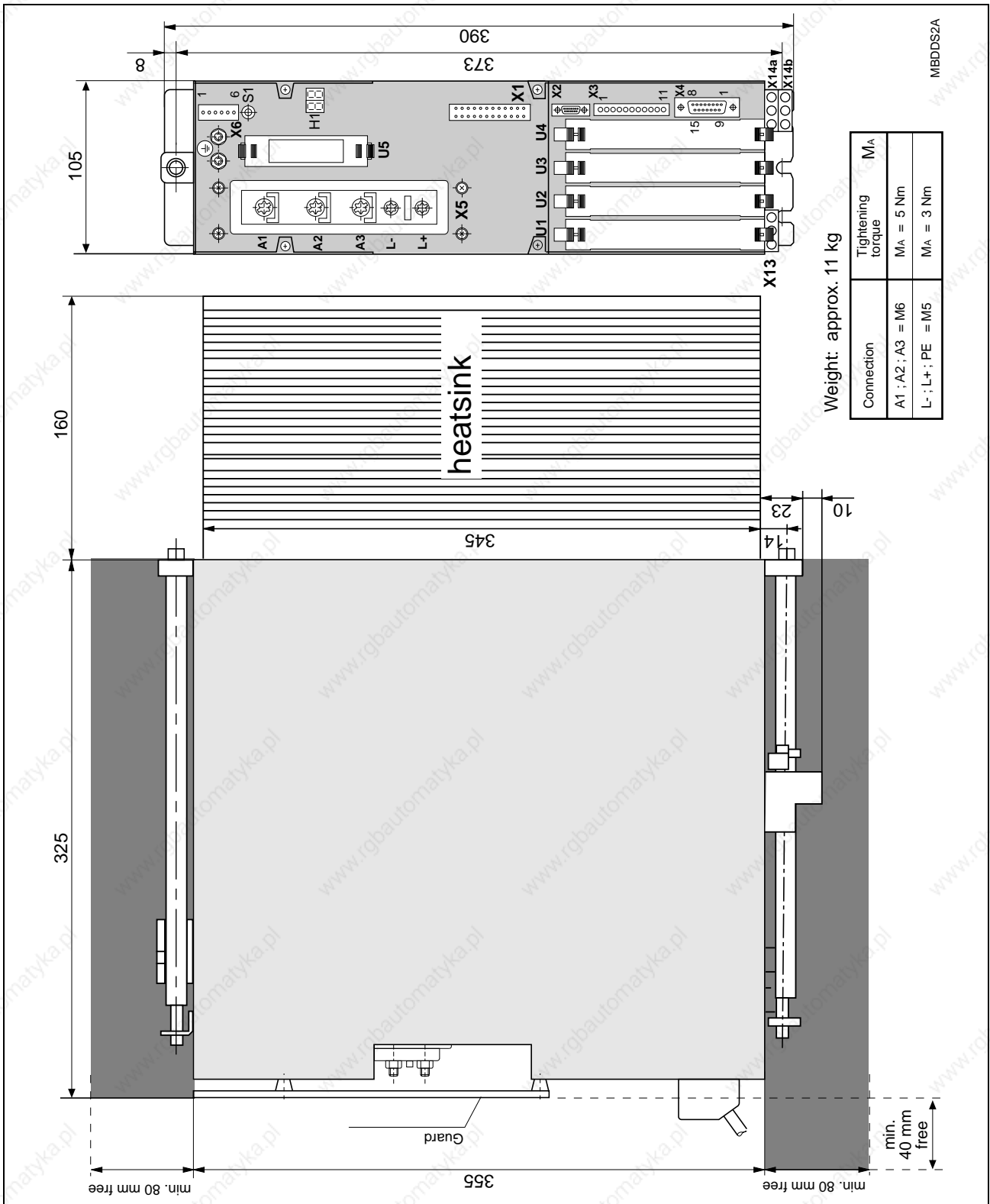

Fig. 5-6: Dimensional sheet of the DDS02.1-A... drive controller

Mounting plans - DDS02.1-A...



Fig. 5-7: Mounting the DDS02.1-A... drive controller

Installation dimensions -
DDS02.1-A...

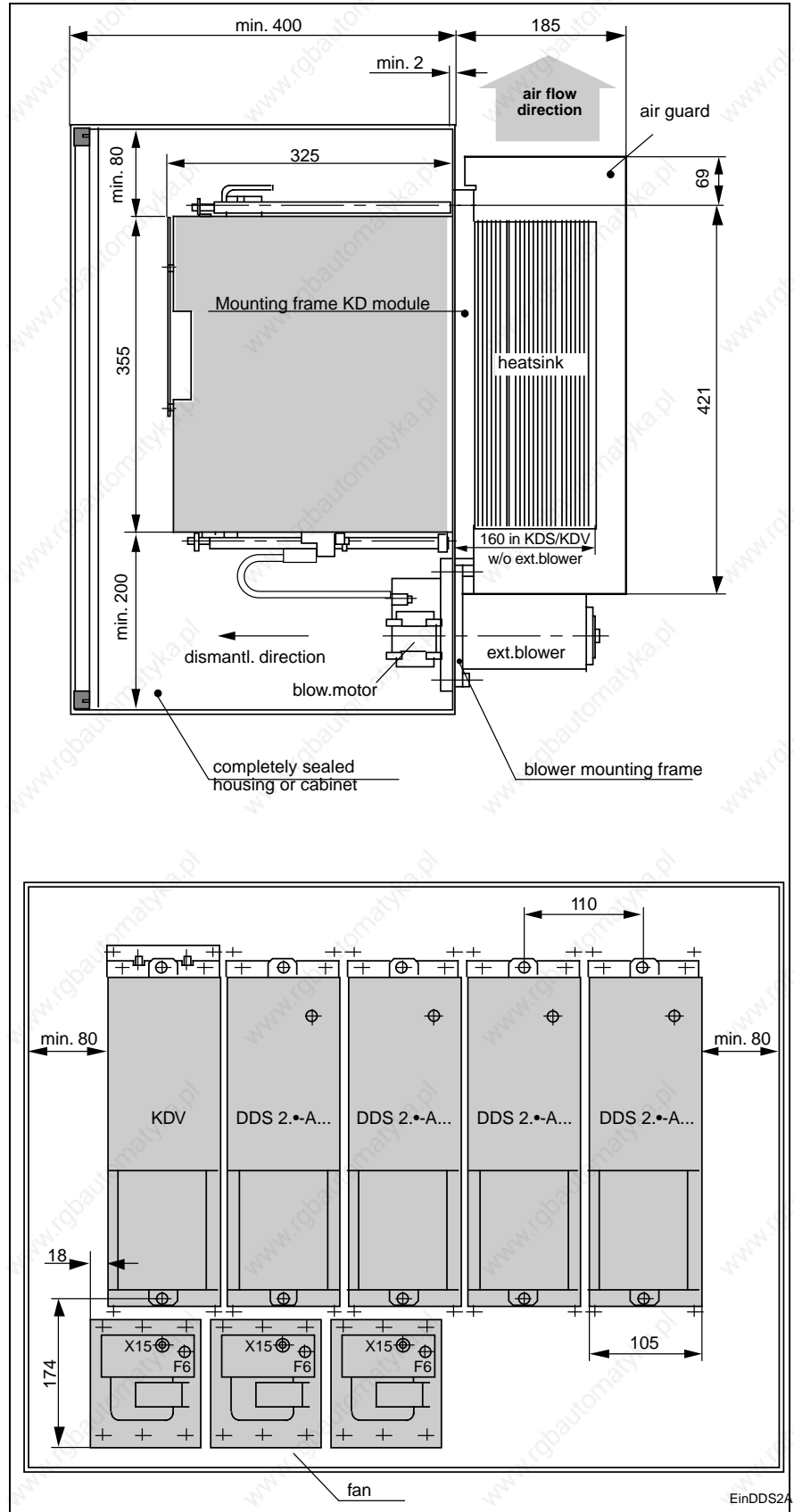

Fig. 5-8: Installation dimensions

Spacing and clearance dimensions -DDS02.1-A...

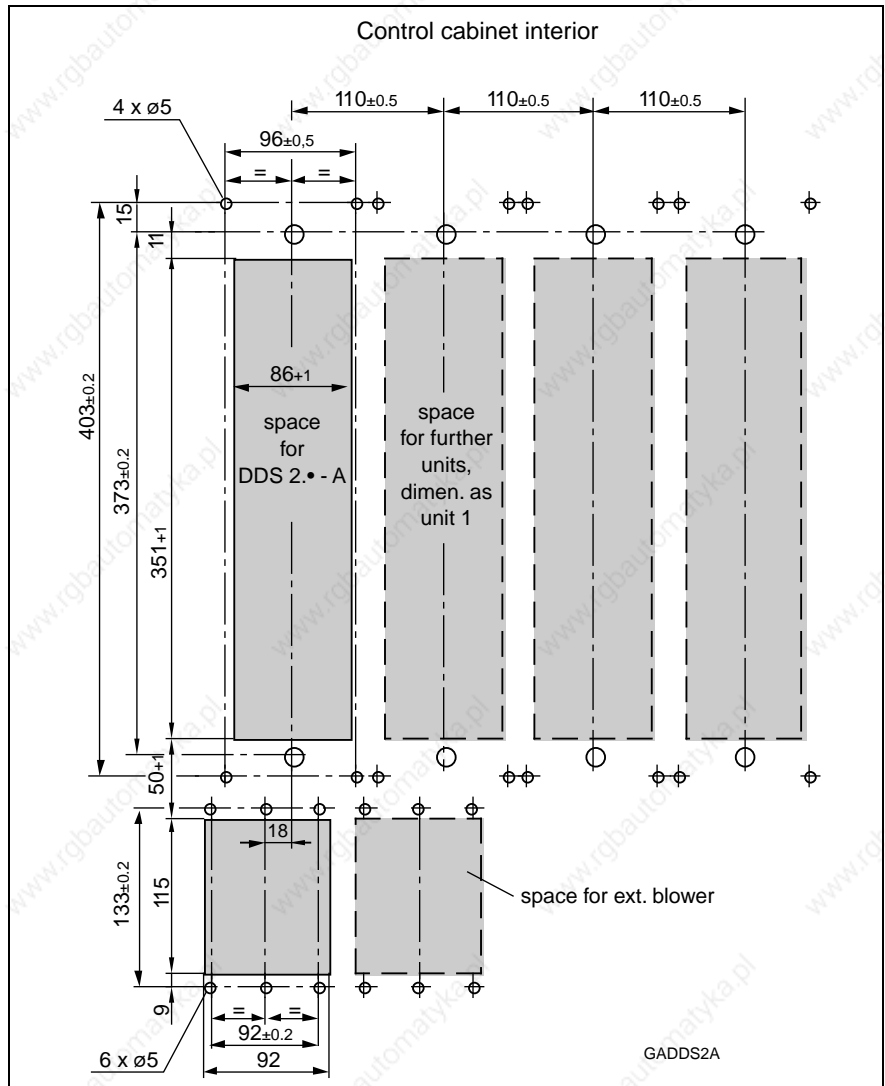

Fig. 5-9: Spacing and clearance dimensions - DDS02.1-A ...

5.3 Mounting the DDS02.1-F... drive controller



Fig. 5-10: Dimensional sheet DDS02.1-F... drive controller

**Dimensional sheet
of accessory kit SH-FL**



Fig. 5-11: Dimensional sheet - SH-FL accessory kit

**Dimensional sheet
of accessory kit M2-F**

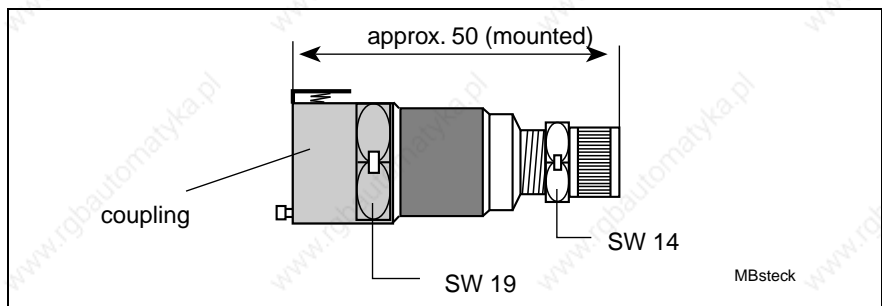

Fig. 5-12: Dimensional sheet - M2-F accessory kit

Note: Please note the mounting and installation guidelines outlined in the document on "Liquid cooling Indramat drive components" (doc. no.: 209-0042-4131-00).

5.4 Mounting the DDS03.1-W...-. drive controller

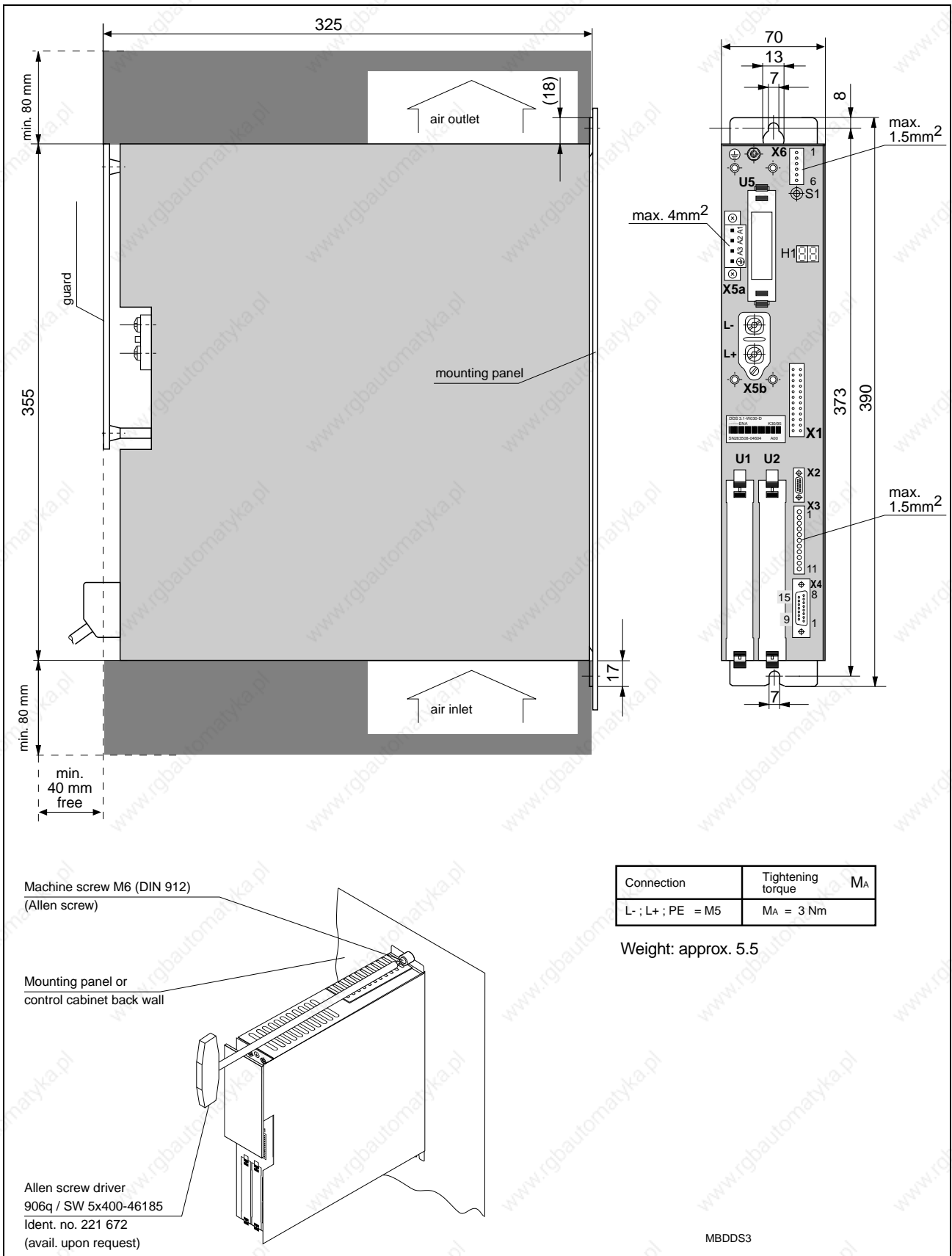

Fig. 5-13: Dimensional sheet - DDS03.1-W...-. drive controller

5.5 Interference suppression and EMC

The mounting and installation guidelines in the Project Planning Manual on "EMC in drive and control systems" must be noted to maintain the legal EMC requirements.

5.6 Using heat-exchanger units in control cabinets

If heat-exchanging units are not installed and operated properly, then the drive components inside the control cabinet could be damaged by moisture and condensation!

DANGER from condense water

Humid air penetrates the control cabinet and, when it cools, condenses onto the drive components installed in there.

DANGER from condensation

If the heat-exchanging unit is not located properly in the control cabinet, then the water constantly condensing on it can drip into the installed components or be sprayed into them by the cold air current.

Avoiding moisture

Proper use of heat-exchanging units:

- Only use heat-exchanging units in well-sealed control cabinets so that moisture cannot be brought in by any humid outside air.
- If the control cabinets are operated with opened doors, for startup, servicing and so on, then make sure, once the doors are closed, that the drive components are not at any time cooler than the air in the control cabinet. Moisture can otherwise occur. For this reason, the heat-exchanging unit must continue to operate even when the plant is switched off so that the temperature of the control cabinet air and the drive components installed remains at the same level.
- Set heat-exchanger units with permanent temperature adjustment to 40 °C. not lower!
- Set heat-exchanger units with temperature correction so that the inside temperature of the control cabinet is not lower than the outside air temperature. Set the limit to 40 °C!

Avoiding dripping and spraying water

Always situate heat-exchanging units so that any condensation cannot drip into the installed drive components. Heat-exchangers on the control cabinet roof require special control cabinet design!

Design the control cabinet in such a way that the unit fan cannot spray condensation deposits onto the drive components after periods during which the unit was not operational!

Summary

- Make sure that no condensation drips from the heat-exchanging unit into the installed drive components!
- Make sure the temperature is set correctly on the heat-exchanger unit!

Heat-exchanger unit on the roof of the control cabinet



Fig. 5-14: Arranging the heat-exchanger unit on the roof of the control cabinet

Heat-exchanger unit on the front of the control cabinet

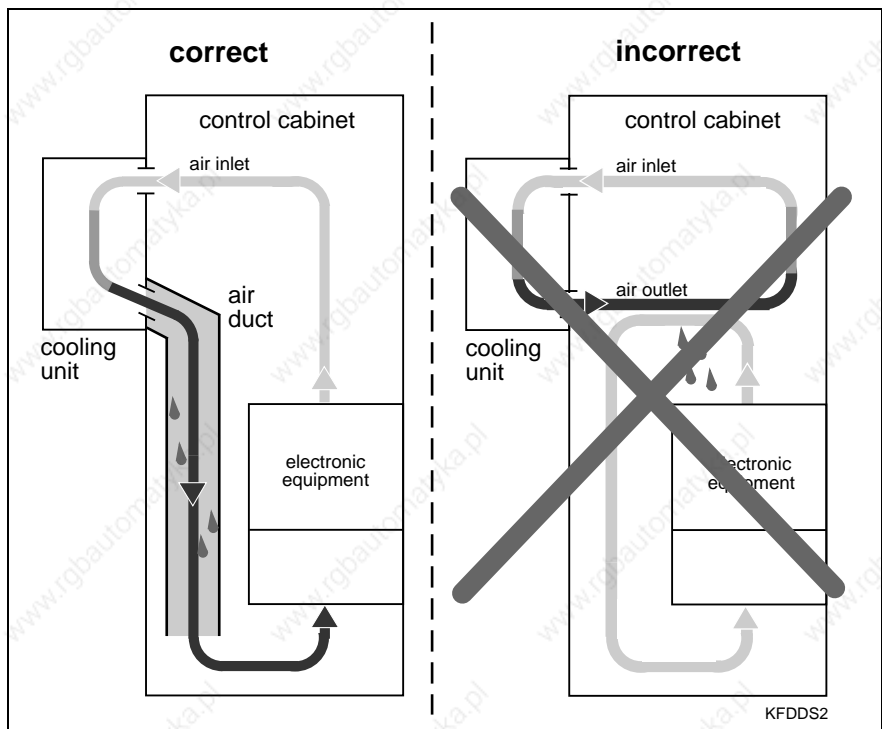

Fig. 5-15: Arranging the heat-exchanger unit on the front of the control cabinet

6 Electrical connections of the drive controller

6.1 General notes

- The signal lines must be routed separately of the supply lines due to the interference.
- All signal lines should use plugin clamps or D subminiature plugin connectors to facilitate any unit replacement that might be needed.
- Analog signals must be routed via shielded leads and their shields mounted only to the drive controller.
- Mains, DC bus and motor leads may not be permitted to come into contact with or be connected to the DC $\pm 15V$ and DC $+24V$ low voltages.
- If a high or interference voltage test of the electrical equipment of the machine is to be conducted, then all connections must be clamped off or removed entirely to avoid damage to the electronic components (permissible per VDE 0113). The INDRAMAT drive components are tested in accordance with the VDE 0160 high-voltage test.
- Electrostatic loads endanger electronic components. Body parts that come into contact with these components or printed circuits, must first be discharged by grounding. This means that the human body must be discharged by touching a grounded object, soldering iron and parts and tools must be placed on a conductive surface.
- Endangered components such as plugin modules must be stored or transported in special packaging.
- Maintaining limit values for the transmission of interference (noise reduction) at the points of connection of the machine or plant, particularly when operating in residential or light industrial areas, requires a shielded routing of the motor power cable or the use of a shielded motor power cable. Proper installation of an interference filter, as recommended by INDRAMAT, into the mains supply conductors of the machine or plant is also advisable. The limit values as per class B (rf interference suppression grade N) as per EN 55011/3.91 and Table I per EN 55014/1987 at the machine must be maintained. Further information can be found in the project planning manual „EMC in drive and control systems“ (doc. no: 209-0049-4305-..).

6.2 Connecting the basic unit

Basic unit DDS02.1-...



Fig. 6-1: Front with designated connections for basic unit DDS02.1-...

For details on points ①...⑩ see the following pages.

Basic unit DDS03.1-...



Fig. 6-2: Front with connections designated of the basic unit DDS03.1-...

For details on points ①...⑩ see the following pages.

① Chassis earth connections to the supply unit

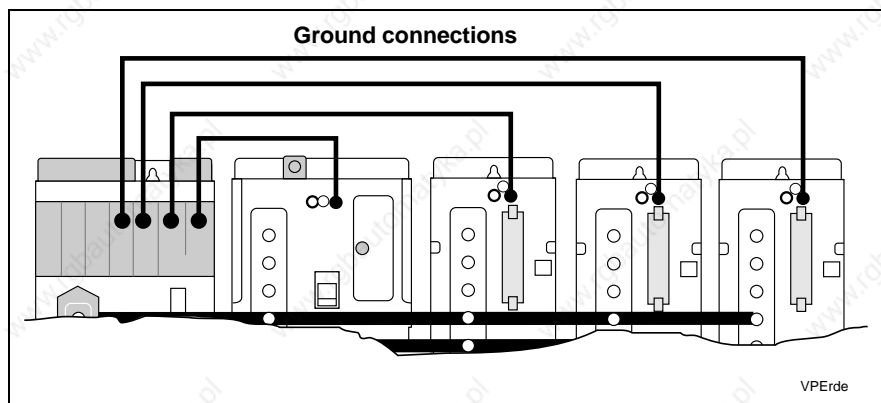

Fig. 6-3: Chassis earth connection to the supply module

Core cross section

The cross section of the chassis earth connection

- must be as big as the cross section of the mains supply line
- but not smaller than 10 mm^2

Earth loops should be avoided, if possible, as intermeshing causes interference and can make fault clearance more difficult.

②③④ Connecting the motor power cable to the drive controller

Motor power cable

Use INDRAMAT motor power cables for the lines between the drive controller and the AC motors.

The INDRAMAT motor power cable contains:

- three lines for the motor power connection
- one line for the protective conductor connection
- a separately shielded pair of cables for motor temperature monitoring (PTC resistor in the motor)
- a separately shielded pair of cables for the motor brake
- a total shield for power cables IKG. Applies if being operated within residential or light industrial areas to maintain the limit values for the emission of interference (rf interference suppression). Otherwise, a totally shielded routing of the power supply may be necessary.

The motor power cable is a ready-made cable and available from Indramat. A cable can also be made out of four individual leads (three phases, 1 protective conductor), with a separately conducted, shielded thermal resistance and brake connection cable. For further information on technical data, connections and cross sections, please check the motor description and the cable catalog.

Maximum cable length

The maximum cable length equals 75 meters if INDRAMAT cables are used.

DDS02 motor power connection



Fig. 6-4: Motor power, holding brake and motor temperature monitoring connections in the DDS02.1

DDS02 power cable connection



Fig. 6-5: Motor power cable connection to the DDS02

DDS03 motor power cable connection



Fig. 6-6: Motor power, holding brake and motor temperature monitor connections with the DDS03.1

DDS03 power cable connections

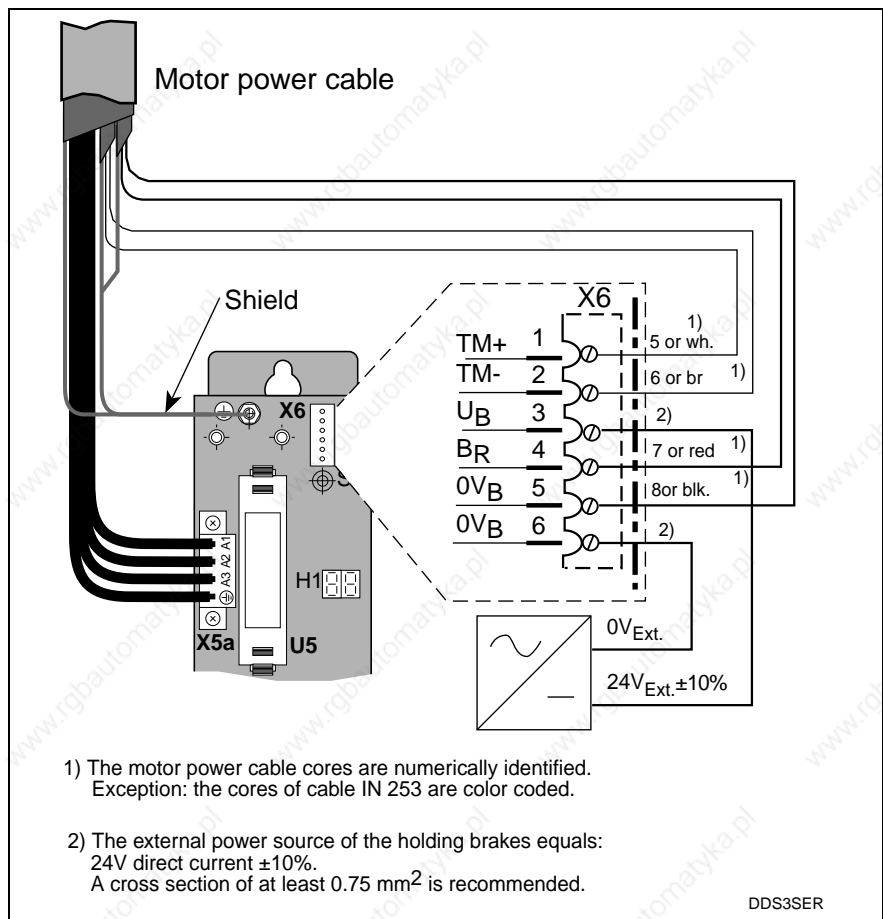

Fig. 6-7: Motor power cable connections to the DDS03 drive controller

Connecting the power cable to the motor

In terms of the motor, the connection takes the form of either a connector or terminal box.

The DDS drive controller connections are outlined in the motor documentation as well as the circuitry with precise clamp designations.

④ Connector X6: Holding brake, motor temperature monitoring

It is only necessary to connect external DC 24V if a motor holding brake is used.

The current consumption of the holding brake is listed in the motor documentation.

The holding brake of the MDD/MKD motors is not a service brake. It wears down after approximately 20,000 motor revolutions against the closed brake disc.

Note: To release the holding brake it is necessary to apply DC +24V +/- 10 % directly to the motor. The voltage to release the motor brake is applied at X6/3 and X6/6. It must be certain that the brake will effectively release even if longer motor power cables are used (voltage drop with longer motor power cables can be compensated by higher voltages (to DC +28V) at X6/3 and X6/6).

Controlling the motor holding brake

The drive controller controls the motor holding brake.

⑤ DC bus voltage connection

Adjacent drive controllers are normally connected via the DC bus rails which are in the accessories kit E .. - DDS 2. If DC bus rails are not needed for a specific connection, then the connection can be established via stranded leads that are as short as possible (maximum length of 1 meter). The cross section of the lead depends on the supply unit or the DC bus continuous output.

DC bus rails must be used with the DDS02.1-.150-... and DDS02.1-.200-... drive controllers.

Supply unit	DC bus continuous output in kW	Lead cross section in mm ²
TVM 1.2-...	7.5	4
TVM 2.2-.../TVM 2.4-...	7.5	4
KDV 1.3-...	30	25
KDV 2.2-.../KDV 2.3-...	30	25
KDV 3.1-...	30	25
KDV 4.1-...	30	25
TVD 1.2-08-3	7.5	4
TVD 1.2-15-3	15	10

Fig. 6-8: DC bus connection - required cross sections

⑥ Connector X1: Bus connections

The control electronics of the drive controllers are supplied via connector X1. The connection starts at the supply unit and runs to the drive controllers with the help of the bus cable. The bus cable is part of the electrical connecting kit E . . -DDS 2. Insert the bus cable, with the black core at the bottom, into connector X1. Insert the end connector supplied in the kit (e.g.,: E3-TVD) of the supply unit into the last unit (the unit physically furthest away from the supply unit). In special cases it is possible to use a special bus cable with a maximum length of one meter.



Fig. 6-9: Connecting the units via flat-ribbon cables and DC bus rails



Fig. 6-10: Connector assignment X1

⑦ Connector X3

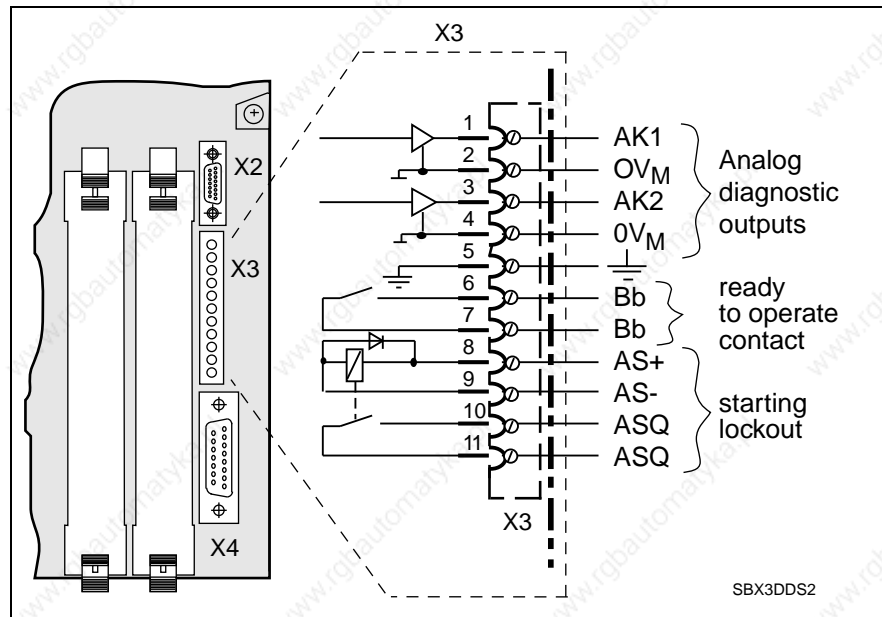

Fig. 6-11: Connector assignment X3

Analog diagnostic outputs AK1, AK2

The analog diagnostic outputs are analog outputs via which drive-internal variables are generated for test purposes, e.g., when commissioning. For further details on analog diagnostic outputs, please see the application description.

Current load capacity: 4 mA

Output voltage: DC 10 V

Ready to operate contact Bb

If ready to operate contact „Bb“ closes, then the drive controller is ready to receive power. The „Bb“ closes if the control voltage is on and all monitoring functions are signalling a ready state.

The „Bb“ can be evaluated in the control, for example, so that the control immediately recognizes which drive controller in the drive package has had a power failure.

Switching capacity: DC 24 V, 1 A (short-term and continuous)

Note: The direct connection of a contactor coil to the Bb contact is not permitted as the contact could be overloaded by excessive short-term currents after frequent switching sequences thus causing it to break down.

The use of varistors as protective circuits is not acceptable as these require ever-higher levels of current over the course of their service life. This could cause early failures of the connected components and ultimately the unit as well.

**Starting lockout
AS+, AS-, ASQ, ASQ**

The starting lockout represents a safety device to prevent unintentional startups of the connected motors in the event of a fault. It makes sure that the separately working areas of a machine or plant are securely switched off.

Note: The starting lockout is not intended to bring to a standstill axes that are moving.

For further information on this topic, see the documentation on „Starting lockout - functions in drive controller DDS“ (doc. no: 209-0069-4313-XX).

AS+,AS-: control input for relay coils
voltage: DC 20 30 V
power: 1.5 W

ASQ, ASQ: potential-free response contact which acknowledges the activation of a starting lockout to an external control.
Switching power: DC 24 V, 1 A (short-term and continuous)

To activate the starting lockout, apply a voltage of DC +20 ... 30 V between input terminals AS+, AS-. The switching of the startup relay in the drive controller is confirmed by closing the potential-free response contact (output ASQ - ASQ) at the external control.

⑧ Connector X2: interface RS232



Fig. 6-12: Service cable

Service cable IKS0391 is needed to commission drive controllers with ANALOG interface (configurations: DA...-FW and RA...-FW), as this interface is used for parametrization during startup with the use of a terminal / terminal program.

⑨ Connector X4: Motor feedback

The motor feedback is connected at terminal X4.

i Independent of the rated current, there are two types of drive controllers (basic units). **Digital Servo Feedbacks (DSF)** only may be connected to motor feedback terminal X4, of the type, whilst only **Resolver feedbacks (RSF)** may be connected to the other.

Pre-requisites:

- The motors with a digital servo feedback (DSF) must be operated with DDSxx.1-xxxx-**D** drive controllers.
- Motors with a resolver feedback (RSF) must be operated with DDSxx.1-xxxx-**R** drive controllers.

Motor	Drive controllers DDSxx.1-xxxx-D	Drive controllers DDSxx.1-xxxx-R
MDDxxx-x-xxx-xxL-xxxx	can be connected	-
MDDxxx-x-xxx-xxM-xxxx	can be connected	-
MDDxxx-x-xxx-xxG-xxxx	-	can be connected
MDDxxx-x-xxx-xxK-xxxx	-	can be connected
MDDxxx-x-xxx-xxS-xxxx	can be connected	-
MDDxxx-x-xxx-xxT-xxxx	can be connected	-
MKDxxx-x-xxx-xxG-xxxx	-	can be connected
MKDxxx-x-xxx-xxK-xxxx	-	can be connected
LAF	can be connected	-
LAR	can be connected	-

L, S = digital servo feedback (DSF)
M, T = digital servo feedback with integrated multiturn absolute encoder (DSF)
G = resolver feedback (RSF)
K = resolver feedback with integrated pulse generator absolute encoder (RSF)

Fig. 6-13: Permitted motor/controller combinations

The use of INDRAMAT feedback cables is recommended to connect drive controller and servo motor feedback.

The LAF linear motor and the LAR linear motor (with housing) have no motor feedback of their own. These motors are operated via an external linear scale. These linear scales are not connected to the feedback terminal X4 of the basic unit but rather to the plugin module needed for the linear scale. For further information, please see the motor documentation.

Maximum cable length

If INDRAMAT feedback cables are used, then maximum length is 75 meters.

For further information on these cables, see the motor documentation.

Feedback connection X4 with DDSxx.1-xxxx-D for digital servo feedbacks



Fig. 6-14: Connector assignment of X4 in the DDSxx.1-xxxx-D

Feedback connection X4 with DDSxx.1-xxxx-R for resolver feedback

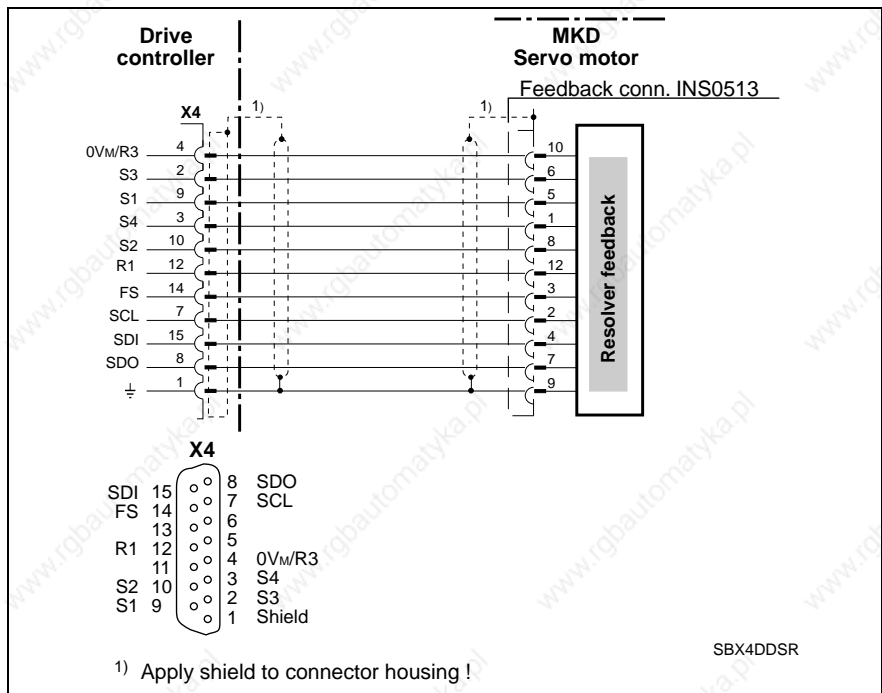

Fig. 6-15: Connector assignment of X4 with the DDSxx.1-xxxx-R

⑩ Connectors X13, X14a, X14b: heatsink blower only with DDS02.1-A...

Connectors X13, X14a, X14b can only be found in DDS 2.1 - A... drive controllers (see dimensional sheet illustration).



Fig. 6-16: Connecting the blower to the DDS 2.1-A... drive controller

The DDS 2.1-A... should preferably be connected to an adjacent unit with a 230 V or 115 V blower connection. If this is not possible, then a connector is required (part no. 219118). This connector will be delivered as of calendar week 10/95 along with the LE4 blower unit.

Blower unit

Type	Supply voltage in V	Frequency in Hz	Maximum power consumption in VA	Fuse F6
LE4 220	AC 230 (+6/-10%)	50...60	70	0.630A/250 E
LE4 115	AC 115 (±10%)	50...60	70	1.250A/250 E

Fig. 6-17: Technical data of the LE4 blower unit

Summary terminal diagram



Fig. 6-18: Summary terminal diagram for basic unit DDS02.1-... with MDD motor

The summary terminal diagram of the DDS02.1-...-D shows that a MDD motor with digital servo feedback (DSF) has been connected (see Fig. 6-18). This total terminal diagram serves as an example for this motor/controller combination.

The summary terminal diagram must, of course, be altered with different motor/controller combinations.

Nr.	Motor	Controller	Difference to summary terminal diagram (see Fig. 6-18)
1	MDD with DSF and connector	DDS02.1-...-D	no difference
2	MDD with DSF and connector	DDS03.1-...-D	no slots U3 and U4
3	MDD with RSF and connector	DDS02.1-...-R	terminal designations for X4 see Fig. 6-15
4	MDD with RSF and connector	DDS03.1-...-R	no slots U3 and U4 terminal designations for X4 see Fig. 6-15
5	MKD with RSF and terminal box	DDS02.1-...-R	terminal designations for X4 see Fig. 6-15 See motor documentation for details on connecting motor feedback and motor power connection.
6	MKD with RSF and terminal box	DDS03.1-...-R	terminal designations for X4 see Fig. 6-15 no slots U3 and U4 See motor documentation for details on connecting motor feedback and motor power connection.
7	LAF	DDS02.1-...-D	X4 free, the scale is connected to the plugin module. See motor documentation for details on connecting motor scale and motor power connection.
8	LAR with connector	DDS02.1-...-D	X4 free, the scale is connected to the plugin module. See motor documentation for details on connecting motor scale and motor power connection.
DSF = digital servo feedback		RSF = resolver feedback	

Fig. 6-19: Differences to the summary terminal diagram

6.3 Connecting the plugin module

Both the terminal diagrams and the technical data on the plugin modules are outlined in document „DIAX02 Plugin modules for digital intelligent drive controllers“.

7 Accessories

Connection accessories kit E..-DDS..

The electrical connecting accessories kit E..-DDS.. simplifies the task of connecting a drive package made up of various units with various allocations.

To be able to select this kit E..-DDS.. the precise allocation of the units inside the control cabinet must be known.

The DDS02 drive controller generally needs kit E..-DDS 2.

The DDS03 drive controller generally needs kit E..-DDS 3.

Connector kit S..-DDS 2

Connector kit S..-DDS 2 is also needed. It depends on the unit configuration. Connector kit S..-DDS 2 can be selected for the respective configuration as per Fig. 8.3.

Connector kit S..-DDS 2 is identical for both DDS02 and DDS03.

7.1 Electrical connecting kit E..-DDS 2

The following illustration is intended to assist in determining which E..-DDS 2 kit is needed to connect adjacent units.

Electrical connection accessories for drive controller types:				
DDS 2.● - W DDS 2.● - F DDS 2.● - A				
connection to following units	orientation to the right		orientation to the left	
	DDS 2.● - W DDS 2.● - F	DDS 2.● - A	DDS 2.● - W DDS 2.● - F	DDS 2.● - A
Type designation	Type designation		Type designation	
KDV 1	E9-DDS 2	E11-DDS 2	E5-DDS 2	E12-DDS 2
KDV 2	E9-DDS 2	E11-DDS 2	E5-DDS 2	E12-DDS 2
KDV 3	E1-DDS 2	E13-DDS 2	E2-DDS 2	E14-DDS 2
KDV 4	E1-DDS 2	E13-DDS 2	E2-DDS 2	E14-DDS 2
KVR 1	E6-DDS 2	E15-DDS 2	E7-DDS 2	E16-DDS 2
TVD	E1-DDS 2	E1-DDS 2	E2-DDS 2	E2-DDS 2
TVM	E3-DDS 2	E17-DDS 2	E3-DDS 2	E17-DDS 2
TVR 2	E6-DDS 2	E6-DDS 2	E7-DDS 2	E7-DDS 2
TVR 3	E1-DDS 2	E1-DDS 2	E2-DDS 2	E2-DDS 2
DDS 2.● - W	E3-DDS 2	E3-DDS 2	E3-DDS 2	E3-DDS 2
DDS 2.● - F	E3-DDS 2	E3-DDS 2	E3-DDS 2	E3-DDS 2
DDS 2.● - A	E3-DDS 2	E17-DDS 2	E3-DDS 2	E17-DDS 2
DDS 3	E8-DDS 2	E8-DDS 2	E10-DDS 2	E10-DDS 2
KDA	E4-DDS 2	E18-DDS 2	E5-DDS 2	E12-DDS 2
KDF	E9-DDS 2	E11-DDS 2	E5-DDS 2	E12-DDS 2
KDS	E9-DDS 2	E11-DDS 2	E5-DDS 2	E12-DDS 2
TDA	E4-DDS 2	E4-DDS 2	E5-DDS 2	E5-DDS 2
TDM 1	E3-DDS 2	E3-DDS 2	E3-DDS 2	E3-DDS 2
TFM	E3-DDS 2	E3-DDS 2	E3-DDS 2	E3-DDS 2
TDM 3/4	E8-DDS 2	E8-DDS 2	E10-DDS 2	E10-DDS 2
TDM 6/7	E8-DDS 2	E8-DDS 2	E10-DDS 2	E10-DDS 2

The DDS 2.● - A should preferably be connected to an adjacent unit with 220 V or 115 V blower connection. If this is not possible, then connector 219 118 will be needed for the blower connection to DDS 2.● - A. This connector will be included with the LE4 blower unit as of calendar week 10/95.

ZubDDS2

Fig. 7-1: Summary of electrical kits E..-DDS 2

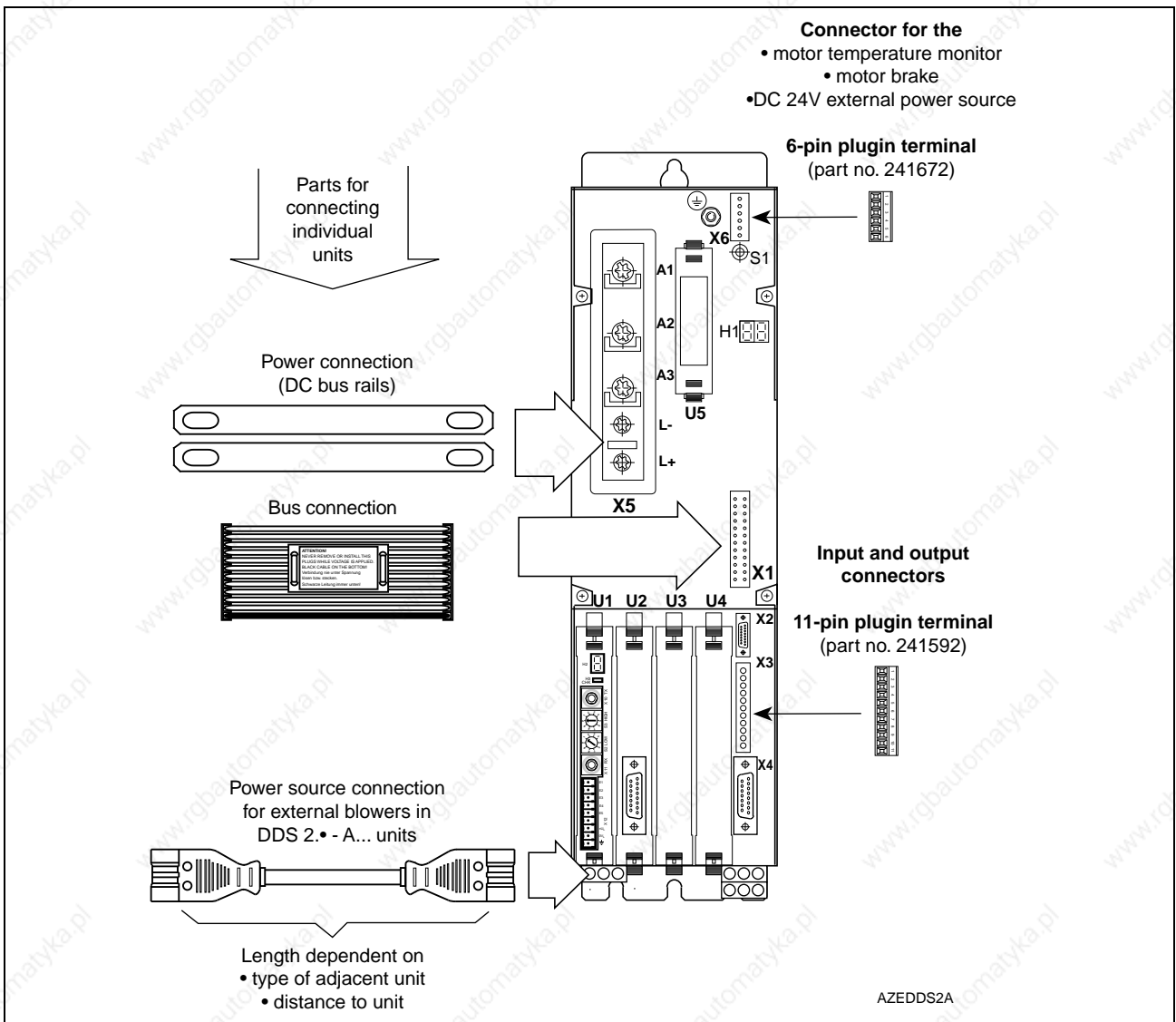

Fig. 7-2: Parts of the electrical accessories kit E...DDS 2

7.2 Electrical accessories kit E..-DDS 3

The following illustration is intended to assist in determining which E..-DDS 3 kit is needed to connect adjacent units.

The electrical connecting accessories required		
*) the unit to which the DDS 3 drive controller is to be connected	orientation to the right	orientation to the left
		
Type designation	Type designation	Type designation
KDV 1 KDV 2 KDV 3 KDV 4 KVR 1 TVD TVM TVR 3 TVR 2 DDS 2 DDS 3 KDA KDF KDS TDA TDM 1 TFM TDM 3/4 TDM 6/7	E10-DDS 3 E10-DDS 3 E1-DDS 3 E1-DDS 3 E7-DDS 3 E1-DDS 3 E3-DDS 3 E1-DDS 3 E7-DDS 3 E3-DDS 3 E9-DDS 3 E5-DDS 3 E10-DDS 3 E10-DDS 3 E5-DDS 3 E3-DDS 3 E3-DDS 3 E9-DDS 3 E9-DDS 3	E6-DDS 3 E6-DDS 3 E2-DDS 3 E2-DDS 3 E8-DDS 3 E2-DDS 3 E4-DDS 3 E2-DDS 3 E8-DDS 3 E4-DDS 3 E9-DDS 3 E6-DDS 3 E6-DDS 3 E6-DDS 3 E4-DDS 3 E4-DDS 3 E9-DDS 3 E9-DDS 3

AZDDS3

Fig. 7-3: Summary of electrical connecting kit E..-DDS 3



Fig. 7-4: Parts of the connecting kit E...DDS 3

7.3 Connector kit for various configurations

There is a connector kit S . . . - DDS 2 for each unit configuration. The connector for the plugin modules inserted into the configured drive controllers and the motor feedback connector (X4) are in this kit.

Configuration	Connector kit	Configuration	Connector kit	Configuration	Connector kit
DA01-01-FW	S 1-DDS 2	DL41-01-FW	S81-DDS 2 2) 3)	DS60-50-FW	S57-DDS 2 1) 3)
DA02-01-FW	S 1-DDS 2	DL42-01-FW	S82-DDS 2 2) 3)	DS61-00-FW	S87-DDS 2 1)
DA03-01-FW	S 8-DDS 2	DL43-01-FW	S80-DDS 2 2) 3)	DS62-00-FW	S87-DDS 2 1)
DA06-01-FW	S14-DDS 2	DL45-01-FW	S 9-DDS 2 2) 3)	DS63-00-FW	S53-DDS 2 1)
DA07-02-FW	S86-DDS 2	DS01-02-FW	S 2-DDS 2 1)	RA01-02-FW	S 1-DDS 2
DA10-01-FW	S14-DDS 2	DS03-02-FW	S 3-DDS 2 1)	RA02-02-FW	S 1-DDS 2
DA11-01-FW	S84-DDS 2	DS04-03-FW	S 3-DDS 2 1)	RA11-01-FW	S84-DDS 2
DA12-01-FW	S84-DDS 2	DS05-01-FW	S 7-DDS 2 1)	RA12-01-FW	S84-DDS 2
DA14-01-FW	S14-DDS 2	DS06-02-FW	S62-DDS 2 1)	RC01-01-FW	S32-DDS 2
DC01-01-FW	S32-DDS 2	DS08-01-FW	S22-DDS 2 1)	RC02-01-FW	S37-DDS 2
DC02-01-FW	S37-DDS 2	DS09-01-FW	S21-DDS 2 1)	RC03-01-FW	S35-DDS 2
DC03-01-FW	S35-DDS 2	DS13-01-FW	S 3-DDS 2 1)	RL01-01-FW	S 9-DDS 2 2)
DC04-01-FW	S76-DDS 2	DS22-02-FW	S29-DDS 2 1)	RL02-01-FW	S10-DDS 2 2)
DL01-01-FW	S 9-DDS 2 2)	DS24-03-FW	S63-DDS 2 1)	RL03-01-FW	S11-DDS 2 2)
DL02-01-FW	S10-DDS 2 2)	DS25-01-FW	S27-DDS 2 1)	RL04-01-FW	S12-DDS 2 2)
DL03-01-FW	S11-DDS 2 2)	DS37-01-FW	S65-DDS 2 1)	RL05-01-FW	S13-DDS 2 2)
DL04-01-FW	S12-DDS 2 2)	DS40-02-FW	S 3-DDS 2 1)	RL08-01-FW	S17-DDS 2 2)
DL05-01-FW	S13-DDS 2 2)	DS41-00-FW	S66-DDS 2 1)	RL09-01-FW	S18-DDS 2 2)
DL08-01-FW	S17-DDS 2 2)	DS45-00-FW	S53-DDS 2 1)	RL10-01-FW	S33-DDS 2 2)
DL09-01-FW	S18-DDS 2 2)	DS46-00-FW	S78-DDS 2 1)	RL20-01-FW	S32-DDS 2 2)
DL10-01-FW	S33-DDS 2 2)	DS46-01-FW	S78-DDS 2 1)	RL21-01-FW	S32-DDS 2 2)
DL11-01-FW	S12-DDS 2 2)	DS47-00-FW	S85-DDS 2 1)	RL22-01-FW	S37-DDS 2 2)
DL12-01-FW	S13-DDS 2 2)	DS47-01-FW	S85-DDS 2 1)	RL23-01-FW	S37-DDS 2 2)
DL13-01-FW	S33-DDS 2 2)	DS48-00-FW	S 7-DDS 2 1)	RL24-01-FW	S35-DDS 2 2)
DL14-01-FW	S12-DDS 2 2)	DS50-00-FW	S63-DDS 2 1)	RL25-01-FW	S35-DDS 2 2)
DL20-01-FW	S32-DDS 2 2)	DS51-00-FW	S60-DDS 2 1)	RL26-01-FW	S34-DDS 2 2)
DL21-01-FW	S32-DDS 2 2)	DS51-01-FW	S60-DDS 2 1)	RL27-01-FW	S34-DDS 2 2)
DL22-01-FW	S37-DDS 2 2)	DS53-00-FW	S60-DDS 2 1)	RL28-01-FW	S36-DDS 2 2)
DL23-01-FW	S37-DDS 2 2)	DS54-00-FW	S77-DDS 2 1)	RL29-01-FW	S36-DDS 2 2)
DL24-01-FW	S35-DDS 2 2)	DS55-00-FW	S29-DDS 2 1)	RL30-01-FW	S76-DDS 2 2)
DL25-01-FW	S35-DDS 2 2)	DS56-00-FW	S30-DDS 2 1)	RL31-01-FW	S76-DDS 2 2)
DL26-01-FW	S34-DDS 2 2)	DS57-00-FW	S85-DDS 2 1)	RS01-03-FW	S 2-DDS 2 1)
DL27-01-FW	S34-DDS 2 2)	DS57-01-FW	S85-DDS 2 1)	RS03-03-FW	S 3-DDS 2 1)
DL28-01-FW	S36-DDS 2 2)	DS58-00-FW	S66-DDS 2 1) 3)	RS04-03-FW	S 3-DDS 2 1)
DL29-01-FW	S36-DDS 2 2)	DS58-50-FW	S66-DDS 2 1) 3)	RS16-02-FW	S65-DDS 2 1)
DL30-01-FW	S76-DDS 2 2)	DS59-00-FW	S57-DDS 2 1) 3)	RS18-02-FW	S30-DDS 2 1)
DL31-01-FW	S76-DDS 2 2)	DS59-50-FW	S57-DDS 2 1) 3)		
DL40-01-FW	S80-DDS 2 2) 3)	DS60-00-FW	S57-DDS 2 1) 3)		

1) If drive controllers with SERCOS interface are used, then the fiber optic cable connections (cables and connectors or ready-made cables) must be ordered.

2) If drive controllers with integrated single-axis positioning controls are used, then the connectors for the positioning module DLC 1.1 are not in kit S.-DDS 2. They must be ordered if needed.

3) If drive controllers with profibus interfaces are used, then the connector for the profibus is not part of the kit.

Fig. 7-5: Determining the connector kit for a specific unit configuration

7.4 Service cable - IKS0391

Service cable IKS0391 is needed to startup drive controllers with ANALOG interface (configuration: DA...-FW and RA...-FW) (see Fig. 6-12), as via this interface parametrization during startup is conducted via a terminal / terminal program.

7.5 Selecting the fiber optic cable connections

The SERCOS interface implements a fiber optic cable to communicate between drive and control.

For further information on the topic „Fiber optic cables“ please see in the application description „Fiber optic cable handling“ (doc. no. 209-0090-4101-xx).

In this document, the following points are discussed:

- general information about such cables
- basic planning guidelines for optical transmission systems
- routing guidelines
- damping measurements of ready-made fiber optic cables
- available FSMA plugin connectors and fiber optic cables
- guidelines on making FSMA connectors
- tools for making fiber optic cables

Use the following illustration to determine the order data of the fiber optic cables for the entire system.

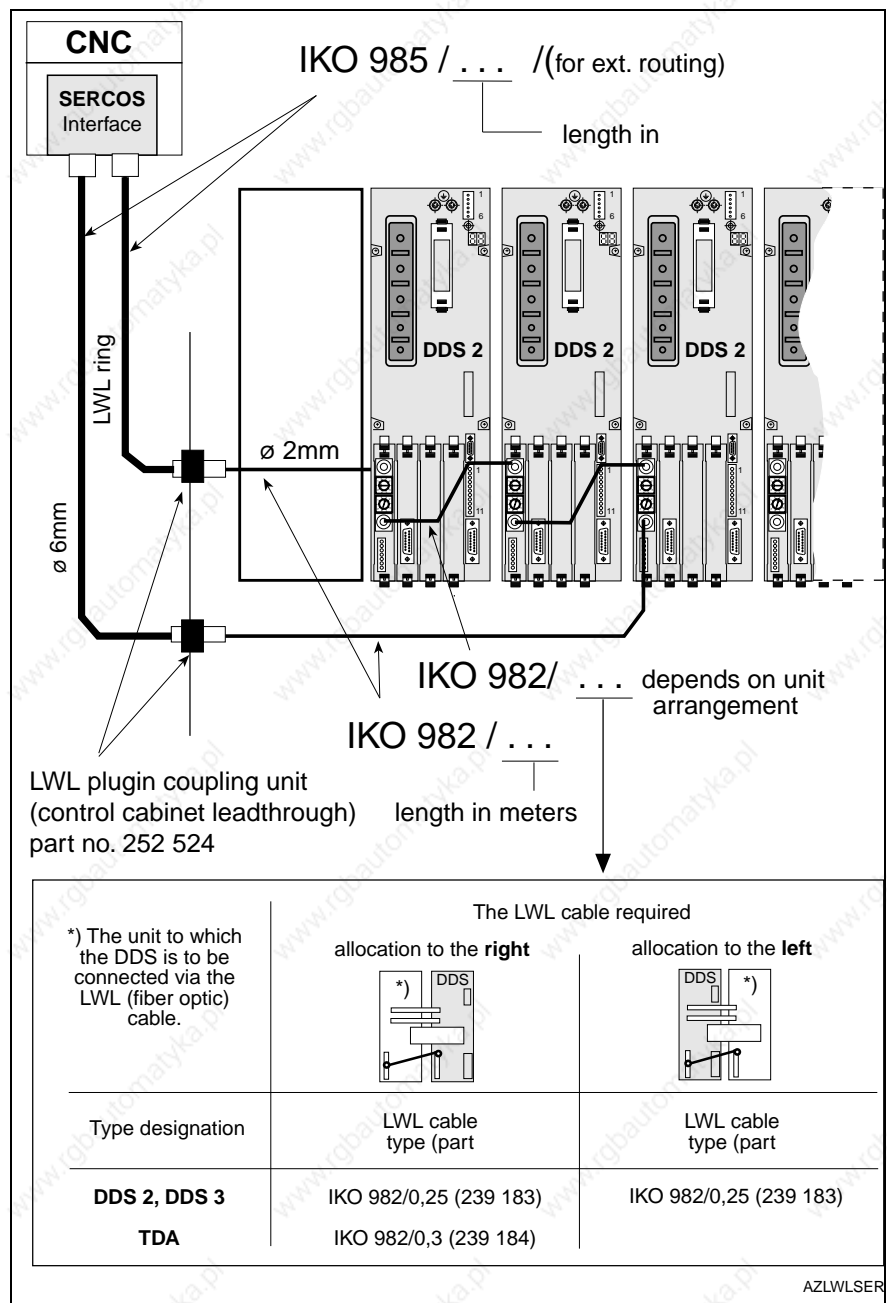

Fig. 7-6: Selecting the ready-made fiber optic cables for a SERCOS ring

7.6 Mechanical accessories for DDS02.1-A***-*

Blower unit LE4 220, LE4 115

The blower unit LE4 contains the parts labelled with (1) in Fig. 5-7.

- LE4 220 for a supply voltage of AC 220V, 50...60 Hz
- LE4 115 for a supply voltage of AC 115V, 50...60 Hz

Mechanical accessories M1-KD

Accessories M1-KD contain the parts labelled with a (2) Fig. 5-7.

7.7 Mechanical accessories for DDS02.1-F***-* drive controllers (with liquid cooling)

Accessories kit SH - FL

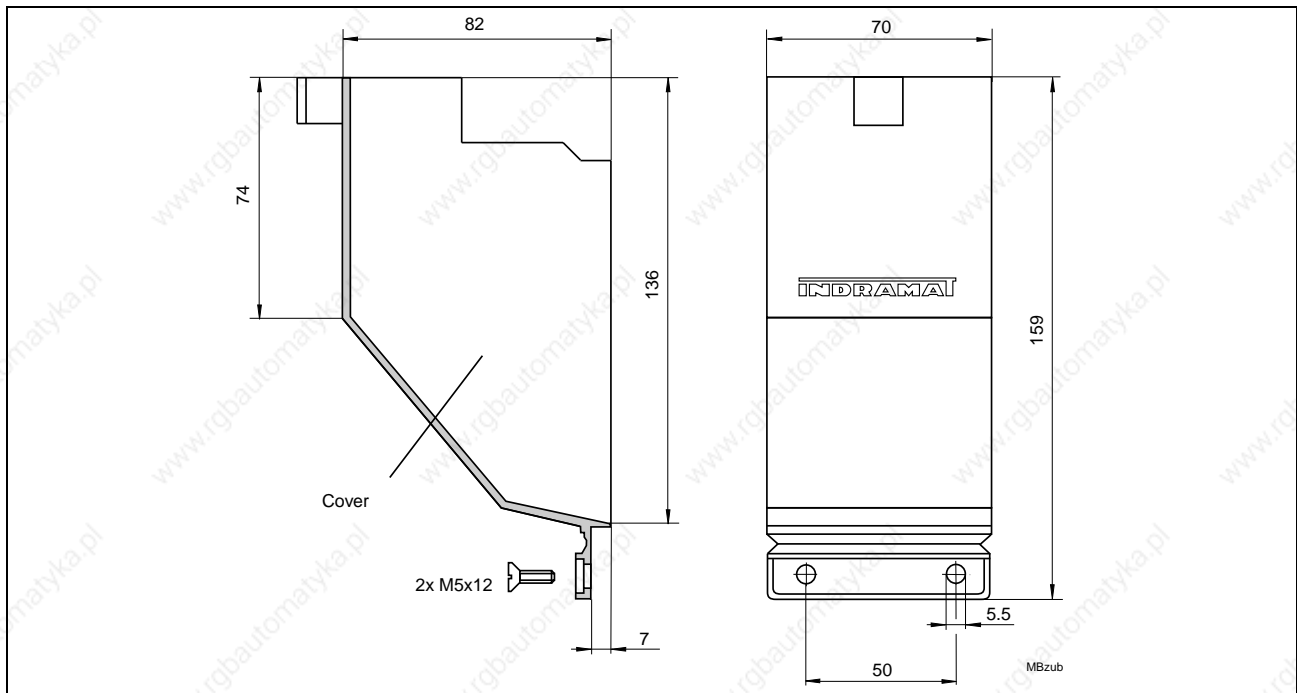

Fig. 7-7: Dimensional sheet for accessories kit SH - FL

Accessories kit M2-F



Fig. 7-8: Dimensional sheet for accessories kit M2-F

Accessories kit M2-F contains two coupling units to connect the coolant equipment to the drive controller.

8 Powering up the power sections via charging resistors

Powering up the power section via charging resistor „RL “ is an option which must be selected:

Use supply unit TVM 2.1 / 2.4 under the following conditions:

- Power transformer > 10 KVA
- Power transformer > 2.5 KVA and auxiliary capacitance
- Power transformer is dropped because of 220 V three-phase mains

Use supply unit KDV 1.3 under the following conditions:

- Power transformer > 50 KVA
- Power transformer > 35 KVA and auxiliary capacitance
- Power transformer is dropped because of 220 V three-phase mains

Note: The Bb contact of the DDS2 drive controller closes if all monitoring functions signal a ready steady. Unlike the analog drive controllers TDM and KDS, the Bb contact can no longer be used to bridge the charging resistors.

Compare ready to operate

Bb contact is closed with TDM and KDS drive controllers if:	Bb contact closed with DDS drive controllers if:
<p>Drive controller ready to output power.</p> <p>(Bb can be used as signal to bridge charging resistors.)</p> <p>Contact „Bb“ closes if power is switched on and all monitoring functions are signalling that all is in order.</p> <p>Diagnosis: any unit that has failed in the drive package cannot be determined via the Bb contact.</p>	<p>DDS drive controller ready for power to be switched on.</p> <p>Bb cannot be used as signal to bridge charging resistors.)</p> <p>Contact „Bb“ closes if control voltage is switched on and all monitoring functions are signalling that all is in order.</p> <p>Diagnosis: any unit that has failed in the drive package can be determined via the Bb contact</p>

Fig. 8-1: Compare ready to operate

Control circuits for KDV 1.3, TVM 2.1 and TVM 2.4 supply units:

- with charging resistors
- with DC bus dynamic brake



Attention: make sure the connection is phase

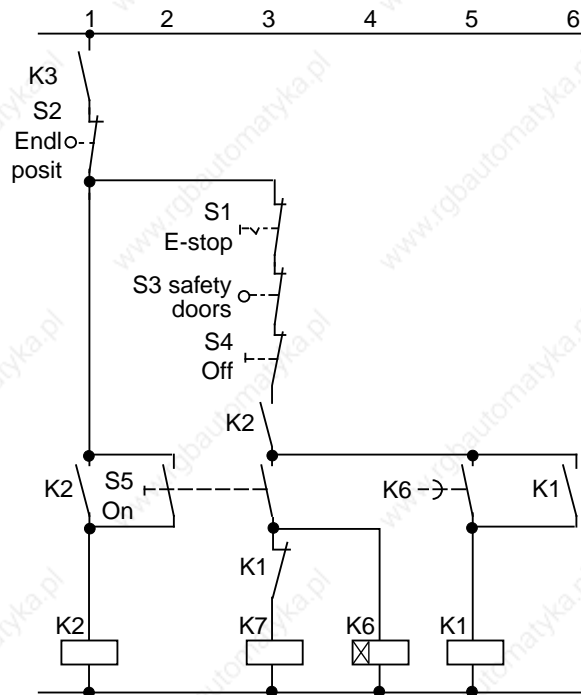
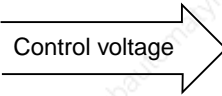

- Bb1 = Supply module ready (drive system)
- F1 = Power supply fuse
- K1 = Mains contactor
- K2 = DC bus dynamic brake contactor
- K3 = Bb1 isolated
- K6 = Pickup delay approx. 500 ms
- K7 = Charging contactor
- NC = Controller error message
 - open with fault in drive (servo error)
 - closed with E-stop

- RF = Control drive enable signal
- RK = DC bus dynamic brake resistor
- RL = Charging resistor
- S1 = E-stop
- S2 = End position of axis
- S3 = Safety door
- S4 = Power Off
- S5 = Power on, cancel DC bus dyn. brake
- T1 = Matching transformer, dropped with 3 x AC 220 V

ATTENTION: With the release of K2 do not switch contactor back on for 0.5s.

K2 must be prevented from dropping out and picking up due to the successive opening and closing of S2 or K3, as otherwise K2 could be damaged. Contactor K2 may only be switched back, once switched off, with a defined command (e.g., S5).

SSDDS2

Fig. 8-2: Control circuit with indirect power on of power section via charging resistor with DDS drive controllers

9 Condition at delivery

The merchandise is packed into cartons at the time of delivery. In the case of individual or mixed orders (several different units), all units are packed in individual one-way cartons. Accessories are in a separate carton. All individual cartons are combined in one large transport container at the time of delivery (on a carton or pallet).

If several units are delivered, then return-packaging can be used.

There is an envelope containing two delivery slips on the transport container. There are no other papers, unless specifically requested.

Packaging can be opened without causing damage by simply separating the glued strips!

10 Identifying the merchandise

In the case of a mixed order, the transport container contains the individually packaged controllers and accessories. In the case of a multiple order of the same units, the accessories may be placed in a separate transport container.

There is a barcode sticker on the DDS package. It identifies the contents in type and order processing.



Fig. 10-1: Barcode sticker on the DDS packaging (example)

If several identical units are in one package, then the serial numbers of all the units contained therein are under the barcode sticker (only in the case of return packaging).

There is a rating plate on the front of the DDS.



Fig. 10-2: Rating plate of the basic DDS unit

Accessories

The accessories are packaged in bags. The order designation is written on the bag. There is a slip in the bag which lists order number and the accessory parts. In the case of ready-made cables, the order number is affixed to the cable, any other types of cables have the cable number printed on them.

<p>Page 1</p> <p style="text-align: right;">INDRAMAT</p> <p style="text-align: center;">S1 - DDS 2</p>  <p style="text-align: center;">250 811</p> <p>for configuration of units:</p> <p>DA01-00 DA02-00</p>		<p>Page 2</p> <table border="1"> <thead> <tr> <th>No.</th> <th>Designation</th> <th>Part</th> </tr> </thead> <tbody> <tr> <td>1</td> <td>D-subm. conn., 15 pin female </td> <td>223008</td> </tr> <tr> <td>1</td> <td>D-subm. connector, 15 pin </td> <td>220623</td> </tr> <tr> <td>4</td> <td>Screw </td> <td>221657</td> </tr> <tr> <td>2</td> <td>15 pin housing </td> <td>221661</td> </tr> <tr> <td>1</td> <td>10 pin plugin clamp </td> <td>241647</td> </tr> </tbody> </table>		No.	Designation	Part	1	D-subm. conn., 15 pin female 	223008	1	D-subm. connector, 15 pin 	220623	4	Screw 	221657	2	15 pin housing 	221661	1	10 pin plugin clamp 	241647
No.	Designation	Part																			
1	D-subm. conn., 15 pin female 	223008																			
1	D-subm. connector, 15 pin 	220623																			
4	Screw 	221657																			
2	15 pin housing 	221661																			
1	10 pin plugin clamp 	241647																			
<p>Page 3</p>		<p>Page 4</p>																			
		<p>Date: 04.11.92 File: S1-DDS2 Part no. BPZ:</p>																			
		<p>Deliver slip for S1-DDS2 No.:109-0852-4206-00</p>																			
		BPZDDS3																			

Fig. 10-3: Examples of a delivery slip

11 Storage and transportation

The controllers must be stored in a dry, dust and shock free environment within a permissible temperature range of -30 to +85 degrees Celsius.

Use shock-damping supports during transport if necessary!

Transport notes found on the packaging:



Fig. 11-1: Safety guidelines for transportation

12 Index

A

- Accessories 7-1, 10-2
 - mechanical 7-9
- Accessories kit
 - M2-F 7-9
 - SH-FL 7-9
- Ambient conditions 4-4

B

- Blower 5-5
- Blower unit 6-14, 7-8
- Bus connection 6-8

C

- Cable length 6-4
- Cable lengths 6-12
- Condense water 5-13
- Configuration rating plate 3-12
- Configurations 3-13
- Configured drive controllers 3-1
- Connector kit 7-1
- Continuous current 4-1

D

- DC bus voltage 6-7
- Diagnostic outputs 6-9
- Digital Servo Feedback 6-12
- Dimensional sheet
 - DDS02.1-A... 5-6
 - DDS02.1-W... 5-4
 - DDS03.1-W... 5-12
 - M2-F 5-11
 - SH-FL 5-11
- Drive controller
 - basic unit 3-4
- Drive controller components 3-2
- Drive controller cooling modes 3-5
- Drive controller type codes 3-3, 3-6

E

- EMC 5-13
- Environmental conditions 4-4

F

- Feedback connection 6-13
- Firmware 3-7, 3-9

M

- Motor feedback 6-12
- Motor power cable 6-4
- Motor temperature monitoring 6-7
- Mounting conditions 5-1
- Mounting panel 5-5

P

- Peak current 4-1
- Plugin module 3-10
- Power dissipation 5-5
 - DDS02.1-A... 4-6
 - DDS02.1-F... 4-7
 - DDS02.1-W... 4-5
 - DDS03.1-W... 4-8

R

- Rating plate basic unit 10-1
- Ready to operate contact Bb 6-9
- Resolver feedback 6-12
- RS232 6-11

S

- Software module 3-7
- Starting lockout 6-10
- Supply units 1-2, 8-1

T

- Technical data 4-1
- Terminal diagram 6-16
- Transportation 11-1

Customer Service Location Directory

Germany

<p>Central sales region</p> <p>INDRAMAT GmbH D-97816 Lohr am Main Bgm.-Dr.-Nebel-Str. 2 Telefon: 09352/40-0 Telefax: 09352/40-4885</p>	<p>Sales region east</p> <p>INDRAMAT GmbH D-09120 Chemnitz Beckerstraße 31 Telefon: 0371/3555-0 Telefax: 0371/3555-230</p>	<p>Sales region west</p> <p>INDRAMAT GmbH D-40849 Ratingen Hansastraße 25 Telefon: 02102/4318-0 Telefax: 02102/41315</p>	<p>Sales region north</p> <p>INDRAMAT GmbH D-22085 Hamburg Fährhausstraße 11 Telefon: 040/227126-16 Telefax: 040/227126-15</p>
<p>Sales region south</p> <p>INDRAMAT GmbH D-80339 München Ridlerstraße 75 Telefon: 089/540138-30 Telefax: 089/540138-10</p>	<p>Sales region southwest</p> <p>INDRAMAT GmbH D-71229 Leonberg Böblinger Straße 25 Telefon: 07152/972-6 Telefax: 07152/972-727</p>		<p>INDRAMAT Service-Hotline</p> <p>INDRAMAT GmbH Telefon: D-0172/660 040 6 -oder- Telefon: D-0171/333 882 6</p>

Kundenbetreuungsstellen in Deutschland

Europe

<p>Austria</p> <p>G.L.Rexroth Ges.m.b.H. Geschäftsbereich INDRAMAT A-1140 Wien Hägelingasse 3 Telefon: 1/9852540-400 Telefax: 1/9852540-93</p>	<p>Austria</p> <p>G.L.Rexroth Ges.m.b.H. Geschäftsbereich INDRAMAT A-4061 Pasching Randlstraße 14 Telefon: 07229/4401-36 Telefax: 07229/4401-80</p>	<p>Belgium</p> <p>Mannesmann Rexroth N.V.-S.A. Geschäftsbereich INDRAMAT B-1740 Ternat Industrielaan 8 Telefon: 02/5823180 Telefax: 02/5824310</p>	<p>Denmark</p> <p>BEC Elektronik AS DK-8900 Randers Zinkvej 6 Telefon: 086/447866 Telefax: 086/447160</p>
<p>England</p> <p>Mannesmann Rexroth Ltd. INDRAMAT Division Cirencester, Glos GL7 1YG 4 Esland Place, Love Lane Telefon: 01285/658671 Telefax: 01285/654991</p>	<p>Finnland</p> <p>Rexroth Mecman OY SF-01720 Vantaa Riihimiehentie 3 Telefon: 0/848511 Telefax: 0/846387</p>	<p>France</p> <p>Rexroth - Sigma S.A. Division INDRAMAT F-92632 Gennevilliers Cedex Parc des Barbanniers 4, Place du Village Telefon: 1/41475430 Telefax: 1/47946941</p>	<p>France</p> <p>Rexroth - Sigma S.A. Division INDRAMAT F-69634 Venissieux - Cx 91, Bd 1 Joliot Curie Telefon: 78785256 Telefax: 78785231</p>
<p>France</p> <p>Rexroth - Sigma S.A. Division INDRAMAT F-31100 Toulouse 270, Avenue de l'ardenne Telefon: 61499519 Telefax: 61310041</p>	<p>Italy</p> <p>Rexroth S.p.A. Divisione INDRAMAT I-20063 Cernusco S/N.MI Via G. Di Vittoria, 1 Telefon: 02/92365-270 Telefax: 02/92108069</p>	<p>Italy</p> <p>Rexroth S.p.A. Divisione INDRAMAT Via Borgomanero, 11 I-10145 Torino Telefon: 011/7712230 Telefax: 011/7710190</p>	<p>Netherlands</p> <p>Hydraudyne Hydrauliek B.V. Kruisbroeksestraat 1a P.O. Box 32 NL-5280 AA Bostel Telefon: 04116/51951 Telefax: 04116/51483</p>
<p>Spain</p> <p>Rexroth S.A. Centro Industrial Santiago Obradors s/n E-08130 Santa Perpetua de Mo- goda (Barcelona) Telefon: 03/718 68 51 Telex: 591 81 Telefax: 03/718 98 62</p>	<p>Spain</p> <p>Goimendi S.A. División Indramat Jolastokieta (Herrera) Apartado 11 37 San Sebastian, 20017 Telefon: 043/40 01 63 Telex: 361 72 Telefax: 043/39 93 95</p>	<p>Sweden</p> <p>AB Rexroth Mecman INDRAMAT Division Varuvägen 7 S-125 81 Stockholm Telefon: 08/727 92 00 Telefax: 08/64 73 277</p>	<p>Switzerland</p> <p>Rexroth SA Département INDRAMAT Chemin de l'Ecole 6 CH-1036 Sullens Telefon: 021/731 43 77 Telefax: 021/731 46 78</p>
<p>Switzerland</p> <p>Rexroth AG Geschäftsbereich INDRAMAT Gewerbstraße 3 CH-8500 Frauenfeld Telefon: 052/720 21 00 Telefax: 052/720 21 11</p>	<p>Russia</p> <p>Tschudnenko E.B. Arsenia 22 153000 Ivanovo Rußland Telefon: 093/22 39 633</p>		

European customer service locations without Germany

Outside of Europe

<p>Argentina</p> <p>Mannesmann Rexroth S.A.I.C. Division INDRAMAT Acassusso 48 41/7 1605 Munro (Buenos Aires) Argentina</p> <p>Telefon: 01/756 01 40 01/756 02 40 Telex: 262 66 rexro ar Telefax: 01/756 01 36</p>	<p>Argentina</p> <p>Nakase Asesoramiento Tecnico Diaz Velez 2929 1636 Olivos (Provincia de Buenos Aires) Argentina Argentina</p> <p>Telefon 01/790 52 30</p>	<p>Australia</p> <p>Australian Industrial Machinery Services Pty. Ltd. Unit 3/45 Horne ST Campbellfield VIC 2061 Australia</p> <p>Telefon: 03/93 59 0228 Telefax: 03/93 59 02886</p>	<p>Brazil</p> <p>Mannesmann Rexroth Automação Ltda. Divisão INDRAMAT Rua Georg Rexroth, 609 Vila Padre Anchieta BR-09.951-250 Diadema-SP Caixa Postal 377 BR-09.901-970 Diadema-SP</p> <p>Telefon: 011/745 90 65 011/745 90 70 Telefax: 011/745 90 50</p>
<p>Canada</p> <p>Basic Technologies Corporation Burlington Division 3426 Mainway Drive Burlington, Ontario Canada L7M 1A8</p> <p>Telefon: 905/335-55 11 Telefax: 905/335-41 84</p>	<p>China</p> <p>Rexroth (China) Ltd. Shanghai Office Room 206 Shanghai Intern. Trade Centre 2200 Yanan Xi Lu Shanghai 200335 P.R. China</p> <p>Telefon: 021/627 55 333 Telefax: 021/627 55 666</p>	<p>China</p> <p>Rexroth (China) Ltd. Shanghai Parts & Service Centre 199 Wu Cao Road, Hua Cao Minhang District Shanghai 201 103 P.R. China</p> <p>Telefon: 021/622 00 058 Telefax: 021/622 00 068</p>	<p>China</p> <p>Rexroth (China) Ltd. 1430 China World Trade Centre 1, Jianguomenwai Avenue Beijing 100004 P.R. China</p> <p>Telefon: 010/50 50 380 Telefax: 010/50 50 379</p>
<p>China</p> <p>Rexroth (China) Ltd. A-5F., 123 Lian Shan Street Sha He Kou District Dalian 116 023 P.R. China</p> <p>Telefon: 0411/46 78 930 Telefax: 0411/46 78 932</p>	<p>Honkong</p> <p>Rexroth (China) Ltd. 19 Cheung Shun Street 1st Floor, Cheung Sha Wan, Kowloon, Honkong</p> <p>Telefon: 741 13 51/-54 und 741 14 30 Telex: 3346 17 GL REX HX Telefax: 786 40 19 786 07 33</p>	<p>India</p> <p>Mannesmann Rexroth (India) Ltd. INDRAMAT Division Plot. 96, Phase III Peenya Industrial Area Bangalore - 560058</p> <p>Telefon: 80/839 21 01 80/839 73 74 Telex: 845 5028 RexB Telefax: 80/839 43 45</p>	<p>Japan</p> <p>Rexroth Co., Ltd. INDRAMAT Division I.R. Building Nakamachidai 4-26-44 Tsuzuki-ku, Yokohama 226 Japan</p> <p>Telefon: 045/942-72 10 Telefax: 045/942-03 41</p>
<p>Korea</p> <p>Rexroth-Seki Co Ltd. 1500-12 Da-Dae-Dong Saha-Gu, Pusan, 604-050</p> <p>Telefon: 051/264 90 01 Telefax: 051/264 90 10</p>	<p>Korea</p> <p>Seo Chang Corporation Ltd. Room 903, Jeail Building 44-35 Yoido-Dong Youngdeungpo-Ku Seoul, Korea</p> <p>Telefon: 02/780-82 07 -9 Telefax: 02/784-54 08</p>	<p>Mexico</p> <p>Motorización y Diseño de Controles, S.A. de C.V. Av. Dr. Gustavo Baz No. 288 Col. Parque Industrial la loma Apartado Postal No. 318 54060 Tlalnepanltla Estado de Mexico</p> <p>Telefon: 5/397 86 44 Telefax: 5/398 98 88</p>	
<p>USA</p> <p>Rexroth Corporation INDRAMAT Division 5150 Prairie Stone Parkway Hoffman Estates, Illinois 60192</p> <p>Telefon: 847/645-36 00 Telefax: 857/645-62 01</p>	<p>USA</p> <p>Rexroth Corporation INDRAMAT Division 2110 Austin Avenue Rochester Hills, Michigan 48309</p> <p>Telefon: 810/853-82 90 Telefax: 810/853-82 90</p>		

Customer service locations outside of Europe

