

ACOPOSmulti User's Manual

Perfection in Automation
www.br-automation.com





ACOPOSmulti

User's Manual

Version: **0.41 (April 2011)**

Model number: **MAACPM-ENG**

All information contained in this manual is current as of its creation/publication. We reserve the right to change the contents of this manual without warning. The information contained herein is believed to be accurate as of the date of publication; however, Bernecker + Rainer Industrie-Elektronik Ges.m.b.H. makes no warranty, expressed or implied, with regards to the products or the documentation contained within this book. In addition, Bernecker + Rainer Industrie-Elektronik Ges.m.b.H. shall not be liable in the event of incidental or consequential damages in connection with or resulting from the furnishing, performance, or use of these products. The software names, hardware names, and trademarks used in this document are registered by the respective companies.



Chapter 1: General information

Chapter 2: Technical data

Chapter 3: Installation

Chapter 4: Dimensioning

Chapter 5: Wiring

Chapter 6: Safety technology



Chapter 7: Standards and certifications

Figure index

Table index

Index

Model number index



Chapter 1: General information	21
1. Manual history	21
2. Safety guidelines	31
2.1 Safety notices	31
2.2 General information	31
2.3 Intended use	32
2.4 Protection against electrostatic discharges	32
2.4.1 Packaging	32
2.4.2 Guidelines for proper ESD handling	33
2.5 Transport and storage	33
2.6 Handling and installation	34
2.7 Operation	34
2.7.1 Protection against touching electrical parts	34
2.7.2 Protection from dangerous movements	36
2.8 Specifications for functional safety	37
2.9 Environmentally-friendly disposal	37
2.9.1 Separation of materials	37
Chapter 2: Technical data	39
1. Configuration of an ACOPOSmulti drive system	39
2. Indicators	40
2.1 8B0P power supply modules	40
2.1.1 Status LEDs	40
2.2 8BVP power supply modules	41
2.2.1 Status LEDs	41
2.3 8B0C auxiliary supply modules	43
2.3.1 Status LEDs	43
2.4 8BVI inverter modules	44
2.4.1 Single-axis modules	44
2.4.2 Two-axis modules	45
2.5 8BVE expansion modules	46
2.5.1 Status LEDs	46
2.6 8B0K capacitor modules	47
2.6.1 Status LEDs	47
2.7 LED status RDY, RUN, ERR (8BVI, 8BVP, 8B0P)	48
2.8 LED status - POWERLINK	48
2.9 LED status - Backup battery	49
2.10 Status changes when booting the operating system loader	49
3. Module overview	50
3.1 Line filter	50
3.2 Regeneration chokes	50
3.3 Mounting plates	50
3.3.1 Wall mounting	50
3.3.2 Cold-plate installation	51
3.3.3 Feed-through mounting	52
3.4 Power supply modules	53

Table of contents

3.4.1 Wall mounting	53
3.4.2 Cold plate or feed-through mounting	53
3.5 Control supply units	53
3.5.1 Wall mounting	53
3.5.2 Cold plate or feed-through mounting	54
3.6 Inverter modules	54
3.6.1 Single-axis modules	54
3.6.2 Two-axis modules	55
3.7 Expansion modules	55
3.7.1 Wall mounting	55
3.7.2 Cold plate or feed-through mounting	55
3.8 Capacitor modules	56
3.8.1 Wall mounting	56
3.8.2 Cold plate or feed-through mounting	56
3.9 Plug-in modules	56
3.9.1 Encoder modules	56
3.9.2 IO modules	56
4. 8B0F passive line filters	57
4.1 Order data	57
4.2 Technical data	58
5. 8BVF line filter	60
5.1 Order data	60
5.2 Technical data	61
6. 8BVR regeneration chokes	64
6.1 Order data	64
6.2 Technical data	65
7. 8B0M mounting plates	67
7.1 Order data	67
7.2 Technical data	68
8. 8B0P power supply modules	71
8.1 Order data	71
8.2 Technical data	72
8.2.1 POWERLINK station number settings	76
9. 8BVP power supply modules	77
9.1 Order data	77
9.2 Technical data	80
9.2.1 POWERLINK station number settings	84
10. 8BVP power supply modules, 120kW	85
10.1 Order data	85
10.2 Technical data	87
10.2.1 POWERLINK station number settings	91
11. 8B0C 400W auxiliary supply modules	92
11.1 Order data	92
11.2 Technical data	93
12. 8B0C 800W auxiliary supply module	98
12.1 Order data	98
12.2 Technical data	99

13. 8B0C 800W auxiliary supply modules with 24V In	104
13.1 General information	104
13.2 Order data	105
13.3 Technical data	106
14. Inverter modules 8BVI 1.4kW ... 11kW (single-axis modules)	110
14.1 Order data	110
14.2 Technical data	112
14.2.1 POWERLINK station number settings	117
15. 8BVI inverter modules 1.4kW ... 5.5kW (two-axis modules)	118
15.1 General information	118
15.2 Order data	118
15.3 Technical data	120
15.3.1 POWERLINK station number settings	125
16. 8BVI inverter modules 16kW ... 32kW	126
16.1 Order data	126
16.2 Technical data	128
16.2.1 POWERLINK station number settings	133
17. 8BVI inverter modules 11kW ... 16kW (two-axis modules)	134
17.1 General information	134
17.2 Order data	134
17.3 Technical data	136
17.3.1 POWERLINK station number settings	141
18. 8BVI inverter modules, 64kW	142
18.1 Order data	142
18.2 Technical data	144
18.2.1 POWERLINK station number settings	149
19. 8BVI inverter modules, 120kW	150
19.1 Order data	150
19.2 Technical data	152
19.2.1 POWERLINK station number settings	157
20. 8BVE expansion modules	158
20.1 Order data	158
20.2 Technical data	160
21. 8B0K capacitor modules	164
21.1 Order data	164
21.2 Technical data	164
22. EnDat 2.1 plug-in module 8BAC0120.000-1	166
22.1 General description	166
22.2 Order data	167
22.3 Technical data	168
22.4 Indicators	169
22.5 Firmware	169
23. EnDat 2.2 plug-in module 8BAC0120.001-2	170
23.1 General description	170
23.2 Order data	171
23.3 Technical data	172
23.3.1 Indicators	173

Table of contents

23.3.2 Firmware	173
24. HIPERFACE plug-in module 8BAC0121.000-1	174
24.1 General description	174
24.2 Order data	175
24.3 Technical data	175
24.4 Indicators	177
24.5 Firmware	177
25. Resolver plug-in module 8BAC0122.000-1	178
25.1 General description	178
25.2 Order data	178
25.3 Technical data	180
25.4 Indicators	181
25.5 Firmware	181
26. Incremental/SSI encoder plug-in module 8BAC0123.000-1	182
26.1 General description	182
26.2 Order data	185
26.3 Technical data	185
26.4 Indicators	187
26.5 Firmware	187
27. Incremental encoder plug-in module 8BAC0123.001-1	188
27.1 General description	188
27.2 Order data	190
27.3 Technical data	190
27.4 Indicators	192
27.5 Firmware	192
28. Incremental encoder plug-in module 8BAC0123.002-1	193
28.1 General description	193
28.2 Order data	195
28.3 Technical data	196
28.4 Indicators	197
28.5 Firmware	197
29. SinCos plug-in module 8BAC0124.000-1	198
29.1 General description	198
29.2 Order data	198
29.3 Technical data	199
29.4 Indicators	201
29.5 Firmware	201
30. Digital I/O plug-in module 8BAC0130.000-1	202
30.1 General description	202
30.2 Order data	202
30.3 Technical data	203
30.4 Indicators	204
30.5 Firmware	205
31. Digital Out plug-in module 8BAC0130.001-1	206
31.1 General description	206
31.2 Order data	206
31.3 Technical data	207

31.4 Indicators	208
31.5 Firmware	208
32. Analog In plug-in module 8BAC0132.000-1	209
32.1 General description	209
32.2 Order data	209
32.3 Technical data	210
32.4 Indicators	211
32.5 Firmware	211
33. 8B0W external braking resistors	212
33.1 Order data	212
33.2 Technical data	212
34. Cables	214
34.1 General information	214
34.1.1 Assembled cables	214
34.2 8BCM motor cables	215
34.2.1 Motor cables 1.5 mm ²	215
34.2.2 Motor cables 4 mm ²	217
34.2.3 4 mm ² motor cables with motor plug, size 1.5	219
34.2.4 Motor cables 10 mm ²	221
34.3 8BCE EnDat cables	223
34.3.1 Order data	223
34.3.2 Technical data	223
34.4 8BCF EnDat 2.2 cables	225
34.4.1 Order data	225
34.4.2 Technical data	225
34.5 8BCR resolver cables	227
34.5.1 Order data	227
34.5.2 Technical data	227
34.6 8BCS SinCos cables	229
34.6.1 Order data	229
34.6.2 Technical data	229
34.7 8BCA expansion cables	231
34.7.1 Expansion cables, 1.5 mm ²	231
34.7.2 Expansion cables, 4 mm ²	233
34.7.3 Expansion cables, 10 mm ²	235
35. Plugs	237
35.1 General information	237
35.2 8BPM motor plugs	238
35.2.1 Order data	238
35.2.2 Technical data	239
35.3 8BPE EnDat plugs	240
35.3.1 Order data	240
35.3.2 Technical data	240
35.4 8BPR resolver plugs	242
35.4.1 Order data	242
35.4.2 Technical data - 8BPR0001.0000-00 resolver plug	242

Chapter 3: Installation	245
1. General information	245
1.1 8B0M mounting plates	245
1.1.1 8B0MxxxxHW00.000-1 (wall mounting)	245
1.1.2 8B0MxxxxHF00.000-1 (feed-through mounting)	245
1.1.3 8B0MxxxxHC00.000-1 (cold plate)	246
1.2 Mounting ACOPOSmulti modules	247
1.3 8BVI inverter modules	248
1.3.1 Changing the backup battery	248
1.4 Expansion module - 8BVE0500Hx00.000-1	250
1.4.1 Installing the devices fuses	250
1.4.2 Exchanging device fuses	251
1.5 8BVR regeneration chokes	254
1.6 8B0W external braking resistors	255
1.6.1 Mounting orientation	256
2. Motor cables	257
2.1 Assembly example (module-side) of a 1.5 mm ² motor cable	257
3. Shield component set 8SCS002.0000-00	262
3.1 Preparation	262
3.2 Installation	263
4. Dimension diagrams and installation dimensions	264
4.1 General information	264
4.1.1 Swivel range of the connector cover	264
4.2 8B0F passive line filter	265
4.2.1 8B0F0300H000.000-1	265
4.2.2 8B0F0550H000.000-1	266
4.3 8BVF line filter	267
4.3.1 8BVF0220H000.000-1, 8BVF0440H000.001-2	267
4.3.2 8BVF0880H000.000-1	268
4.4 8BVR regeneration chokes	269
4.4.1 8BVR0220H000.100-1	269
4.4.2 8BVR0440H000.100-1	270
4.4.3 8BVR0880H000.100-1	271
4.5 Wall mounting	273
4.5.1 Mounting plate 8B0MnnnnHW00.000-1	273
4.5.2 Power supply modules 8BxP0220HW00.000-1, 8BxP0440HW00.000-1	274
4.5.3 Power supply module 8BVP0880HW00.000-1	275
4.5.4 Control supply units	276
4.5.5 Single-width inverter modules (single-axis modules)	278
4.5.6 Single-width inverter modules (two-axis modules)	279
4.5.7 Inverter modules 8BVI0220HWSx.000-1, 8BVI0440HWSx.000-1	280
4.5.8 Inverter modules 8BVI0110HWDx.000-1, 8BVI0220HWDx.000-1	281
4.5.9 Inverter module 8BVI0880HWSx.000-1	282
4.5.10 Expansion module 8BVE0500HW00.000-1	283
4.5.11 Capacitor module 8B0K1650HW00.000-1	284
4.6 Cold-plate installation	285
4.6.1 Mounting plate 8B0MnnnnHC00.000-1	285

4.6.2 Power supply module 8BxP0220HC00.000-1, 8BxP0440HC00.000-1	286
4.6.3 Power supply module 8BVP0880HC00.000-1	287
4.6.4 Power supply module 8BVP1650HC00.000-1	288
4.6.5 Control supply units	289
4.6.6 Single-width inverter modules (single-axis modules)	291
4.6.7 Single-width inverter modules (two-axis modules)	292
4.6.8 Inverter modules 8BVI0220HCSx.000-1, 8BVI0440HCSx.000-1	293
4.6.9 Inverter modules 8BVI0110HCDx.000-1, 8BVI0220HCDx.000-1	294
4.6.10 Inverter module 8BVI0880HCSx.000-1	295
4.6.11 Inverter module 8BVI1650HCS0.000-1	296
4.6.12 Expansion module 8BVE0500HC00.000-1	297
4.6.13 Capacitor module 8B0K1650HC00.000-1	298
4.7 Feed-through mounting	299
4.7.1 Mounting plate 8B0MnnnnHF00.000-1	299
4.7.2 Power supply module 8BxP0220HC00.000-1, 8BxP0440HC00.000-1	300
4.7.3 Power supply module 8BVP0880HC00.000-1	301
4.7.4 Power supply module 8BVP1650HC00.000-1	302
4.7.5 Control supply units	304
4.7.6 Single-width inverter modules (single-axis modules)	306
4.7.7 Single-width inverter modules (two-axis modules)	307
4.7.8 Inverter modules 8BVI0220HCSx.000-1, 8BVI0440HCSx.000-1	308
4.7.9 Inverter modules 8BVI0110HCDx.000-1, 8BVI0220HCDx.000-1	309
4.7.10 Inverter module 8BVI0880HCSx.000-1	310
4.7.11 Inverter module 8BVI1650HCS0.000-1	311
4.7.12 Expansion module 8BVE0500HC00.000-1	313
4.7.13 Capacitor module 8B0K1650HC00.000-1	314
4.8 External braking resistors	315
4.8.1 8B0W0045H000.001-1, 8B0W0079H000.001-1	315
4.9 Fan module 8B0M0040HFF0.000-1	317
5. Using cooling systems in switching cabinets	318
5.1 Natural convection	318
5.2 Using filter fans	318
5.3 Using air/air heat exchangers	319
5.4 Using air/water heat exchangers	320
5.5 Using cooling aggregates	321
5.5.1 General information	321
5.5.2 Placing a cooling aggregate on top of the switching cabinet	322
5.5.3 Placing a cooling aggregate on the front of the switching cabinet	323
Chapter 4: Dimensioning	325
1. Power mains connection	325
1.1 General information	325
1.1.1 System configuration	325
1.1.2 Supply Voltage Range	326
1.1.3 Protective ground connection (PE)	327
1.2 Dimensioning	329

Table of contents

1.2.1 Design of the ACOPOSmulti power mains connections	329
1.3 Fault current protection	332
1.3.1 Rated fault current	332
1.3.2 Estimating possible ACOPOSmulti drive system configurations	332
1.3.3 Manufacturers of fault current protection devices that can be used	334
1.3.4 Examples	334
2. Motor connector	336
3. Braking resistor	338
3.1 General information	338
3.2 External braking resistor connection	338
3.2.1 Fuse protection	339
3.3 Sizing the braking resistor	340
3.3.1 Calculation basics	340
3.3.2 Example	343
3.4 Setting brake resistor parameters	351
4. Cooling water circuit	352
4.1 Cooling system	352
4.1.1 Piping	352
4.1.2 Gaskets	352
4.1.3 Schematic diagram of the cooling water circuit	353
4.2 Cooling medium	359
4.2.1 Preparation and maintenance	359
4.2.2 Hydrologic data	360
4.2.3 Corrosion protection	361
4.2.4 Biocide additive	362
4.2.5 Condensation	362
5. Dimensioning cooling systems for cooling switching cabinets	364
5.1 General dimensioning criteria	364
5.1.1 Basic selection of the cooling system	364
5.2 Natural convection	365
5.2.1 Dimensioning	365
5.2.2 Example	366
5.3 Filter fans	367
5.3.1 Dimensioning	367
5.3.2 Example	368
5.4 Air/air heat exchanger	369
5.4.1 Dimensioning	369
5.4.2 Example	370
5.5 Air/water heat exchanger, cooling aggregates	371
5.5.1 Dimensioning	371
5.5.2 Example	372
Chapter 5: Wiring	373
1. General information	373
1.1 Electromagnetic compatibility of the installation	373
1.1.1 General information	373

1.1.2 Installation notes	374
1.1.3 Overview	375
1.1.4 Connection diagrams for ground and shield connections	377
1.2 Isolation and high-voltage test	387
1.2.1 Insulation resistance according to EN 60204	387
1.2.2 High voltage test	389
1.2.3 Typical procedure	391
1.3 Overview of clampable diameter ranges	392
1.3.1 8BVF line filter	392
1.3.2 8BVR regeneration chokes	392
1.3.3 8B0P power supply modules	393
1.3.4 8BVP power supply units	394
1.3.5 8B0C auxiliary supply modules	395
1.3.6 8BVI inverter modules	396
1.3.7 8BVE expansion modules	397
2. 8B0F line filters	398
2.1 Pin assignments - X1	399
2.2 Pin assignments - X2	399
2.3 Protective ground connection (PE) (mains and load side)	400
2.4 Input/output circuit diagram	400
3. 8BVF line filter	401
3.1 8BVF0220H000.000-1, 8BVF0440H000.001-2	401
3.1.1 Pin assignments - X1 plug	402
3.1.2 Pin assignments - X2 plug	402
3.1.3 Pin assignments - X3 plug	403
3.1.4 Additional protective ground connection (PE) (mains and load side)	403
3.1.5 Input/output circuit diagram	404
3.2 8BVF0880H000.000-1	405
3.2.1 Pin assignments - X1	406
3.2.2 Pin assignments - X2	406
3.2.3 Pin assignments - X3 plug	406
3.2.4 Input/output circuit diagram	407
4. 8BVR regeneration chokes	408
4.1 8BVR0220H000.100-1	408
4.1.1 Input/output circuit diagram	409
4.2 8BVR0440H000.100-1	410
4.2.1 Input/output circuit diagram	411
4.3 8BVR0880H000.100-1	412
4.3.1 Input/output circuit diagram	413
5. 8B0P power supply modules	414
5.1 8B0P0220Hx00.000-1, 8B0P0440Hx00.000-1	414
5.1.1 Pin assignments - X1 plug	415
5.1.2 Pin assignments - X3A, X3B plugs	415
5.1.3 Pin assignments - X5A plug	416
5.1.4 Pin assignments - X5B plug	416
5.1.5 Additional protective ground connection (PE)	417
5.1.6 Input/output circuit diagram	418

Table of contents

6. 8BVP power supply units	420
6.1 8BVP0220Hx00.000-1, 8BVP0440Hx00.000-1	420
6.1.1 Pin assignments - X1 plug	421
6.1.2 Pin assignments - X2 plug	421
6.1.3 Pin assignments - X3A, X3B plugs	422
6.1.4 Pin assignments - X4A plug	422
6.1.5 Pin assignments - X5A plug	423
6.1.6 Additional protective ground connection (PE)	424
6.1.7 Input/output circuit diagram	425
6.2 8BVP0880Hx00.000-1	428
6.2.1 Pin assignments - X1 plug	429
6.2.2 Pin assignments - X2 plug	429
6.2.3 Pin assignments - X3A, X3B plugs	430
6.2.4 Pin assignments - X4A plug	430
6.2.5 Pin assignments - X5A plug	431
6.2.6 Input/output circuit diagram	433
6.3 8BVP1650HC00.000-1	436
6.3.1 Pin assignments - X1 plug	437
6.3.2 Pin assignments - X2 plug	437
6.3.3 Pin assignments - X3A, X3B plugs	438
6.3.4 Pin assignments - X4A plug	438
6.3.5 Pin assignments - X5A plug	439
6.3.6 Input/output circuit diagram	441
7. 8B0C auxiliary supply modules	444
7.1 8B0C0160Hx00.000-1, 8B0C0320Hx00.000-1	444
7.1.1 Pin assignments - X1 plug	445
7.1.2 Input/output circuit diagram	445
7.2 8B0C0160Hx00.001-1, 8B0C0320Hx00.002-1	446
7.2.1 Pin assignments - X1 plug	447
7.2.2 Pin assignments - X2 plug	447
7.2.3 Pin assignments - X3 plug	447
7.2.4 Input/output circuit diagram	448
7.2.5 Parallel connection of multiple 8B0C auxiliary supply modules	448
7.3 8B0C0160HC00.A01-1	449
7.3.1 Pin assignments - X1 plug	450
7.3.2 Pin assignments - X2 plug	450
7.3.3 Pin assignments - X3 plug	450
7.3.4 Input/output circuit diagram	451
7.3.5 Parallel connection of multiple 8B0C auxiliary supply modules	451
7.4 8B0C0320Hx00.00A-1	452
7.4.1 Pin assignments - X1 plug	453
7.4.2 Pin assignments - X2 plug	453
7.4.3 Pin assignments - X3 plug	453
7.4.4 Input/output circuit diagram	454
7.4.5 Parallel connection of multiple 8B0C auxiliary supply modules	454
8. 8BVI inverter modules	455
8.1 8BVI0014HxS0.000-1, 8BVI0028HxS0.000-1, 8BVI0055HxS0.000-1,	

8BVI0110HxS0.000-1	455
8.1.1 Pin assignments - X1 plug	456
8.1.2 Pin assignments - X2 plug	457
8.1.3 Pin assignments - X3A, X3B plugs	457
8.1.4 Pin assignments - X4A plug	458
8.1.5 Pin assignments - X5A plug	458
8.1.6 Input/output circuit diagram	459
8.2 8BVI0014HxD0.000-1, 8BVI0028HxD0.000-1, 8BVI0055HxD0.000-1	461
8.2.1 Pin assignments - X1 plug	462
8.2.2 Pin assignments - X2 plug	463
8.2.3 Pin assignments - X3A, X3B plugs	463
8.2.4 Pin assignments - X4A plug	464
8.2.5 Pin assignments - X4B plug	465
8.2.6 Pin assignments - X5A plug	466
8.2.7 Pin assignments - X5B plug	466
8.2.8 Input/output circuit diagram	467
8.3 8BVI0220HxS0.000-1, 8BVI0440HxS0.000-1	471
8.3.1 Pin assignments - X1 plug	472
8.3.2 Pin assignments - X2 plug	473
8.3.3 Pin assignments - X3A, X3B plugs	473
8.3.4 Pin assignments - X4A plug	474
8.3.5 Pin assignments - X5A plug	474
8.3.6 Input/output circuit diagram	475
8.4 8BVI0110HxD0.000-1, 8BVI0220HxD0.000-1	477
8.4.1 Pin assignments - X1 plug	478
8.4.2 Pin assignments - X2 plug	479
8.4.3 Pin assignments - X3A, X3B plugs	479
8.4.4 Pin assignments - X4A plug	480
8.4.5 Pin assignments - X4B plug	481
8.4.6 Pin assignments - X5A plug	482
8.4.7 Pin assignments - X5B plug	482
8.4.8 Input/output circuit diagram	483
8.5 8BVI0880HxS0.000-1	487
8.5.1 Pin assignments - X1 plug	488
8.5.2 Pin assignments - X2 plug	489
8.5.3 Pin assignments - X3A, X3B plugs	489
8.5.4 Pin assignments - X4A plug	490
8.5.5 Pin assignments - X5A plug	491
8.5.6 Input/output circuit diagram	493
8.6 8BVI1650HxS0.000-1	495
8.6.1 Pin assignments - X1 plug	496
8.6.2 Pin assignments - X2 plug	497
8.6.3 Pin assignments - X3A, X3B plugs	497
8.6.4 Pin assignments - X4A plug	498
8.6.5 Pin assignments - X5A plug	499
8.6.6 Input/output circuit diagram	501
9. 8BVE expansion modules	503

Table of contents

9.1 8BVE0500Hx00.000-1	503
9.1.1 Pin assignments - X2 plug	504
9.1.2 Pin assignments - X3A plug	504
9.1.3 Pin assignments - X3B plug	504
9.1.4 Pin assignments - X4A plug	505
9.1.5 Pin assignments - X4B plug ¹⁾	505
10. 8B0W external braking resistors	506
11. Plug-in modules	507
11.1 EnDat 2.1 interface 8BAC0120.000-1	507
11.1.1 Pin assignments	507
11.1.2 Input/output circuit diagram	508
11.2 EnDat 2.2 interface 8BAC0120.001-2	509
11.2.1 Pin assignments	509
11.2.2 Input/output circuit diagram	510
11.3 HIPERFACE interface 8BAC0121.000-1	511
11.3.1 Pin assignments	511
11.3.2 Input/output circuit diagram	512
11.4 Resolver interface 8BAC0122.000-1	513
11.4.1 Pin assignments	513
11.4.2 Input/output circuit diagram	514
11.5 Incremental/SSI encoder interface 8BAC0123.000-1	515
11.5.1 Pin assignments	515
11.5.2 Input/output circuit diagram	516
11.5.3 Tracer pin connection (in preparation)	517
11.6 Incremental encoder interface 8BAC0123.001-1	518
11.6.1 Pin assignments	518
11.6.2 Input/output circuit diagram	519
11.6.3 Configuration of the pull-up and pull-down resistances in the module	520
11.6.4 Configuration of wire break monitoring	520
11.7 Incremental encoder interface 8BAC0123.002-1	521
11.7.1 Pin assignments	521
11.7.2 Input/output circuit diagram	522
11.7.3 Tracer pin connection (in preparation)	523
11.7.4 Configuration of the pull-up and pull-down resistances in the module	524
11.7.5 Configuration of wire break monitoring	524
11.8 SinCos interface 8BAC0124.000-1	525
11.8.1 Pin assignments	525
11.8.2 Input/output circuit diagram	526
11.9 Digital I/O Interface 8BAC0130.000-1	527
11.9.1 Pin assignments	527
11.9.2 Input/output circuit diagram	528
11.10 Digital Out Interface 8BAC0130.001-1	529
11.10.1 Pin assignments	529
11.10.2 Input/output circuit diagram	530
11.11 Analog interface 8BAC0132.000-1	531
11.11.1 Pin assignments	531
11.11.2 Input/output circuit diagram	532

12. Cables	533
12.1 8BCM motor cable	533
12.1.1 8BCMxxxx.1111A-0, 8BCMxxxx.1312A-0	533
12.1.2 8BCMxxxx.1523A-0	535
12.2 8BCE EnDat cable	537
12.2.1 Construction	537
12.2.2 Pin assignments	537
12.2.3 Cable schematic	538
12.3 8BCF EnDat 2.2 cable	539
12.3.1 Construction	539
12.3.2 Pin assignments	539
12.3.3 Cable schematic	540
12.4 8BCR resolver cables	541
12.4.1 Construction	541
12.4.2 Pin assignments	541
12.4.3 Cable schematic	542
12.5 8BCS SinCos cables	543
12.5.1 Construction	543
12.5.2 Pin assignments	543
12.5.3 Cable schematic	544
12.6 8BCA expansion cable	545
12.6.1 Construction	545
12.6.2 Cable schematic	545
13. Fan modules	546
13.1 8B0M0040HFF0.000-1	546
13.1.1 Pin assignments - X1 plug	547
13.1.2 Pin assignments - X2 plug	547

Chapter 6: Safety technology 548

1. Standard safety technology ("Wired safety technology")	548
1.1 General information	548
1.2 Principle - Implementing the safety function	550
1.2.1 Additional function	551
1.3 Enable input circuit in accordance with the required Safety Category / SIL / PL	553
1.3.1 STO, Category 4 / SIL 3 / PL e (Variant A)	554
1.3.2 STO, Category 4 / SIL 3 / PL e (Variant B)	556
1.3.3 STO, Category 3 / SIL 2 / PL d	557
1.4 Enable input circuits according to the required Safety Category / SIL / PL and functionality (STO, SS1, SS2, SLS, SOS)	557
1.4.1 STO, SLS, SOS - Safety Category 4 / SIL 3 / PL e	558
1.4.2 SS1, SLS, SS2 - Safety Category 4 / SIL 3 / PL e (Variant A)	560
1.4.3 SS1, SLS, SS2 - Safety Category 4 / SIL 3 / PL e (Variant B)	563
1.4.4 STO, SLS, SOS - Safety category 3 / SIL 2 / PL d	567
1.4.5 SS1, SLS, SS2 - Safety Category 3 / SIL 2 / PL d (Variant A)	569
1.4.6 SS1, SLS, SS2 - Safety Category 3 / SIL 2 / PL d (Variant B)	572

Chapter 7: Standards and certifications	577
1. Applicable European directives	577
2. Applicable standards	577
3. Environmental limits	579
3.1 Mechanical conditions according to EN 61800-2	579
3.1.1 Operation	579
3.1.2 Transport	579
3.2 Climate conditions according to IEC 61800-2	580
3.2.1 Operation	580
3.2.2 Bearings	580
3.2.3 Transport	580
4. Requirements for immunity to disturbances (EMC)	581
4.1 Evaluation criteria (performance criteria)	581
4.2 Low frequency disturbances according to EN 61800-3	581
4.2.1 Power mains harmonics and commutation notches / voltage distortions	581
4.2.2 Voltage changes, fluctuations, drops and short-term interruptions	581
4.2.3 Asymmetric voltage und frequency changes	582
4.3 High frequency disturbances according to EN 61800-3	582
4.3.1 Electrostatic discharge	582
4.3.2 Electromagnetic fields	582
4.3.3 Burst	582
4.3.4 Surge	583
4.3.5 High frequency conducted disturbances	583
5. Requirements for emissions (EMC)	584
5.1 High frequency emissions according to EN 61800-3	584
5.1.1 Conducted emissions on the power connections	584
5.1.2 Electromagnetic emissions	584
6. Other environmental limit values according to IEC 61800-2	585
7. International certifications	586
8. Standards & definitions for safety techniques	587

Chapter 1 • General information

1. Manual history

Information:

B&R does its best to keep the printed versions of its user's manuals as current as possible. However, newer versions of the User's Manual are always available first for download in electronic form (PDF) from the B&R homepage www.br-automation.com.

Version	Date	Comment
0.41 Preliminary	26.03.2011	Changes / new features <ul style="list-style-type: none"> • Safety Guidelines: New section „Kennwerte für die Funktionale Sicherheit“ added • Safety Technology: Revision of safety functions/characteristics, Proof Test Interval adapted to 20 years

Table 1: Manual history

General information • Manual history

Version	Date	Comment
0.40 Preliminary	2010-07-31	<p>Changes / new features</p> <ul style="list-style-type: none"> • 8BVI0110HxD0.000-1 Inverter module added: <ul style="list-style-type: none"> - Technical data - Wiring • 8BAC0120.001-1 EnDat 2.2 insert card added: <ul style="list-style-type: none"> - Technical data - Wiring • Technical data - Installation/ 8BOM: Specification added regarding smoothness of the mounting surface for cold-plate and feed-through mounting • 8B0C0320Hx00.00A-1 auxiliary supply module added: <ul style="list-style-type: none"> - Technical data - Dimension diagrams and installation dimensions - Wiring • Wiring / 8BVI: Warning added (reverse polarity connection of permanent magnet holding brakes) Input/output circuit diagram: Detailed version added (IGBT) • Wiring / 8BVP: Input/output circuit diagram: Detailed version added (IGBT) • 8BVR regeneration chokes: Note regarding additional warning sticker added <ul style="list-style-type: none"> - Installation - Wiring • Technical data / DC bus voltage: Rated value 800 VDC --> 750 VDC • Technical data / 8BVE: Continuous power 32 kW --> 30 kW (UZK < 800 VDC --> 750 VDC) • Technical data / displays: Description of the displays for 8B0P/8BVP/8BVI modified (backup battery).

Table 1: Manual history (cont.)

Version	Date	Comment
0.40 Preliminary	2010-07-31	<ul style="list-style-type: none"> • 8B0P passive power supply modules added: <ul style="list-style-type: none"> - Technical data - Dimension diagrams and installation dimensions - Wiring • 8B0F passive line filters added: <ul style="list-style-type: none"> - Technical data • 8B0W external braking resistors added: <ul style="list-style-type: none"> - Technical data - Dimension diagrams and installation dimensions - Wiring • Technical data / 8BVF0220H000.000-1: Weight info added • Plug-in modules 8BAC0130.000-1 and 8BAC0130.001-1 added: <ul style="list-style-type: none"> - Technical data - Wiring • Installation / fan module 8B0M0040HFF0.000-1: Dimension diagram and installation dimensions added • Technical data / 8BAC0132.000-1: Value for differential input impedance corrected: "< 10kΩ" --> "> 10MΩ" • Wiring / 8BAC0123.000-1, 8BAC0123.002-1: Warning added (EnDat encoders will be critically damaged if accidentally connected to these modules) • Safety notices: Image of warning sticker added • Technical data / 8B0C: Missing weight information added. • Technical data / 8BVI: Missing input capacitances added. • Technical data / 8BVP: Values for installed load and starting current added. • Technical data / 8B0P: Values for installed load added. • Technical data / 8BVI: Continuous power consumption and power dissipation depending on the switching frequency added. • Installation / General information: Mounting of ACOPOSmulti modules modified • Wiring / 8BVI: Information added regarding wiring lengths for enable and motor holding brake.
0.39 Preliminary	2009-02-20	<p>Changes / new features</p> <ul style="list-style-type: none"> • Wiring / Standard safety technology: Section modified for re-certified safety technology according to EN ISO 13849.
0.38 Preliminary	2009-01-12	<p>Changes / new features</p> <ul style="list-style-type: none"> • Mounting / 8BVR: Tolerances in the dimension diagrams corrected • Technical data / 8BVR: Tolerances in the dimensions account for. • Technical data / 8BVI: Values for typical switching times on the Enable inputs replaced by maximum values

Table 1: Manual history (cont.)

General information • Manual history

Version	Date	Comment
0.37 Preliminary	2008-12-05	<p>Changes / new features</p> <ul style="list-style-type: none"> • Dimensioning / Power mains connection: Discharge capacities for 8BVF0220/8BVP0220/8BVI0220 updated • Wiring / 8BVP: Interior wiring added / updated. • Mounting / 8BVR: Updated mounting diagrams with tolerances added • Technical data / 8BVP: Derating specifications for wall and cold-plate mounting added. Specifications for possible switching frequencies (5 / 10 kHz) added. • Wiring / 8BVR: Interior wiring added • Technical data / 8BVI: Switching times for the enable inputs were specified incorrectly - Corrected
0.36 Preliminary	2008-10-09	<p>Changes / new features</p> <ul style="list-style-type: none"> • Technical data / 8BVI: Power ratings in chapter headings did not match the specifications in the technical data - Corrected • Technical data / 8BVR Wrong model number for 8BVF0220 - Corrected • Wiring / 8BVF0440: Input/output circuit diagram added. • Wiring / 8BVF0880: Input/output circuit diagram added. • Technical data / 8BACxxx: Units in formulas for max. power consumption were partially incorrect (W instead of mW) --> Corrected. • Technical data / 8BVI: Derating specifications for cold-plate mounting added.

Table 1: Manual history (cont.)

Version	Date	Comment
0.35 Preliminary	2008-09-04	<p>Changes / new features</p> <ul style="list-style-type: none"> • Wiring / Plug-in modules: Connection plug in image and photo were oriented differently - Corrected • Wiring / 8B0C0160Hx00.001-1, 8B0C0320Hx00.002-1, 8B0C0160Hx00.A01-1: X3 pin assignments modified (pin 1 and pin 4) • Technical data / 8B0M: Specifications about pressure drop on cold plates added. • Specifications for 8BVF0110 and 8BVR0110 canceled without replacement. • Technical data / 8BVI0014/0028/0055: Incorrect specifications about continuous and peak currents --> Corrected • Dimensioning: New section "Cooling water circuit" added. • Technical data / 8B0M: Optional accessories X67CA0P00.0002: Number corrected from max. 2 to max. 4 • Mounting / Wiring of 8BVR: Mounting guidelines / Not about protective ground connection added. • Technical data / Views for 8BVI: Additional LED states for axis 1 and axis 2 added. • Wiring / Standard safety technology ("Wired safety technology"): Expansion to section "STO, category 3 / SIL 2 / PL d". • Technical data / 8BVI: Note about effects of usage at higher switching frequencies added. • Wiring / 8BAC0121.000-1: Input/output circuit diagram added. • Technical data / 8BVF, 8BVR: Derating information added. • Technical data: C-UL-US Listing added. • Technical data / 8BVF: Data for 8BVF0220H000.000-1 added. • Technical data / 8BVR: Data for 8BVR0220H00P.100-1 added. • Technical data / 8BVR: Data for 8BVP0220Hx00.000-1 added. • Wiring / 8BVI: For all X1 / X4 pin assignments - Note about external activation of the holding brake added. • Mounting / 8BVR: Dimensional diagram for 8BVR0220H000.100-1 added. • Wiring / 8BVR: Pin assignments for 8BVR0220H000.000-1

Table 1: Manual history (cont.)

General information • Manual history

Version	Date	Comment
0.34 Preliminary	2008-01-18	<p>Changes / new features</p> <ul style="list-style-type: none"> • Wiring / Standard safety technology ("Wired safety technology"): <ul style="list-style-type: none"> The term "restart inhibit" replaced with "pulse disabling" in two places Section 1.3.4: Information about line contactor added • Wiring / Overview images 8BVP, 8BVI: <ul style="list-style-type: none"> Slot labeling added (detail view changed) • Technical data / General information / Views: <ul style="list-style-type: none"> This section was updated to make it easier to understand • Wiring / Fan modules: <ul style="list-style-type: none"> Image "Overview of pin assignments - 8B0M0040HFF0.000-1" was corrected (X1 and X2 plugs were switched) • Technical data / 8BAC0123: <ul style="list-style-type: none"> New section added • Wiring / 8BAC0123: <ul style="list-style-type: none"> New section added • Wiring / 8BVP0440Hx00.000-1: <ul style="list-style-type: none"> Image of plug X5A was incorrect --> corrected • Technical data / Inverter modules: <ul style="list-style-type: none"> Rate of rise in voltage value (10 kV/μs) was added. • Technical data / 8BVE: <ul style="list-style-type: none"> Terminal cross section for 24 VDC cable outlet was changed. • Wiring / Auxiliary supply module 8B0C: <ul style="list-style-type: none"> Interior wiring updated. • Technical data / 8BVF, 8BVR: <ul style="list-style-type: none"> Derating information (continuous current) was added. • Technical data: <ul style="list-style-type: none"> 24 VDC power consumption for modules/plug-in modules was added. • Technical data 8BVF: <ul style="list-style-type: none"> 24 VDC power consumption for the fan connection was added. Terminal cross sections for the temperature sensor and fan connection was added. • Technical data / plug-in modules: <ul style="list-style-type: none"> Images switched • Technical data / 8BVF: <ul style="list-style-type: none"> Derating information (continuous current) for 8BVF0880 was added. • Technical data, installation, wiring / 8BVP: <ul style="list-style-type: none"> 8BVP0110 cancelled (will be later replaced with another type) • Installation / regeneration chokes 8BVR0440, 8BVR0880: <ul style="list-style-type: none"> dimension diagrams updated • General information / Safety notices: <ul style="list-style-type: none"> The "Installation" section was renamed ("Handling and installation") and updated (handling and installation of heavy B&R drive systems and servo motors)

Table 1: Manual history (cont.)

Version	Date	Comment
0.33 Preliminary	2007-10-25	<p>Changes / new features</p> <ul style="list-style-type: none"> • Installation: <ul style="list-style-type: none"> Dimension diagrams for cold plate mounting plates modified • Order data: <ul style="list-style-type: none"> New optional accessories added: <ul style="list-style-type: none"> 8BXF001.0000-00 (replacement fan for ACOPOSmulti modules) 8BVP/8B0C/8BVI/8BVE/8B0K • Mounting / dimension diagrams: <ul style="list-style-type: none"> Entries for missing ACOPOSmulti modules added • Technical data: <ul style="list-style-type: none"> Data 8BVE expansion modules added Data 8B0K expansion modules added Data for 8BVI0220 inverter module added • Wiring: <ul style="list-style-type: none"> Entries for missing ACOPOSmulti modules added • Wiring: <ul style="list-style-type: none"> Terminal cable cross sections for 8BVE expansion modules added Completion - 8BVI0220, 8BVP0440 • Technical data / displays: <ul style="list-style-type: none"> LED status for POWERLINK updated • Technical data 8BVF / 8BVR: <ul style="list-style-type: none"> Operating conditions updated. • Technical data 8B0MnnnnHF00.000-1: <ul style="list-style-type: none"> Maximum number of slots reduces (27 --> 20) • Technical data. <ul style="list-style-type: none"> Weights of ACOPOSmulti modules corrected / updated. • Installation: <ul style="list-style-type: none"> Mounting guidelines for mounting plates updated. • Dimensioning: <ul style="list-style-type: none"> "Dimensioning cooling systems for cooling switching cabinets" section added. • Technical data 8BVF / 8BVR: <ul style="list-style-type: none"> Storage and transport conditions updated. • Technical data: <ul style="list-style-type: none"> Operating conditions according to EN 61800-2 corrected. • Technical data 8BVI0110HxS0.000-1: <ul style="list-style-type: none"> Values for continuous current and peak current adjusted. • Technical data 8BVF0440H000.001-2: <ul style="list-style-type: none"> Reduction of continuous current according to the ambient temperature above 40°C added. • Technical data 8BVI0220: <ul style="list-style-type: none"> Terminal cross sections for motor and shield connections corrected • Wiring / terminal cross sections: <ul style="list-style-type: none"> Data for 8BVI0220 corrected. • Technical data 8BVI0440HxS0.000-1: <ul style="list-style-type: none"> Value for peak current adjusted. • Technical data 8B0M: <ul style="list-style-type: none"> Accessory added (replacement fan 8BXF002.0000-00).

Table 1: Manual history (cont.)

General information • Manual history

Version	Date	Comment
0.32 Preliminary	08.2007	<p>Changes / new features</p> <ul style="list-style-type: none"> • Technical data: Long texts for the ACOPOSMulti modules were modified (800V --> HV) • Wiring: Interior wiring for inverter modules added • Standards and certifications: Correction: Overvoltage cat. according to IEC 60364-4-443:1999 changed from II to III • Installation: Operating conditions for cold-plate mounting plates (8B0MxxxxHC00.000-1) added
0.31 Preliminary	2007-05-11	<p>Changes / new features</p> <ul style="list-style-type: none"> • Wiring for 8B0C0160HC00.A05-1: Pin 4 of X2 connection wired incorrectly (+42V) --> corrected to +24V • Technical data / wiring: HIPERFACE plug-in module 8BAC0121.000-1 added • Wiring / 8BAC0124.000-1 Interior wiring modified / corrected • Technical data 8BVI0440HxS0.000-1 / Required accessories: Model number of plug for X5 connection added • Wiring: Section "Wired safety technology" added • Wiring: Section "Overview of clampable diameter ranges" added • Wiring / General information: Section "General information" updated (shielding) • Technical data for 8BVI..., 8BVP... Electrical isolation of trigger inputs (8BVP, 8BVI) / Enable inputs (8BVP) corrected • Technical data / wiring / mounting of 8BVR0440: Changeover to 8BVR0110H000.100-1 and 8BVR0440H000.100-1 • Wiring of 8BVP0880 / 8BVI0880: Mounting instructions added for X5 connection • Wiring / General information: Section "General information" updated (shielding) • Technical data for 8BAC0120 / 0121 / 0122 / 0124: Corrections / updates made to the technical data. • Technical data for 8B0MxxxxHWxx / Dimensions: Calculation of the width of the mounting plates modified/simplified • Mounting / Wall mounting: Diagrams modified according to the change in width of the mounting plates (n * 53.5 mm) • General information / Safety notices: The term "Servo drive" replaced with "drive system". • Mounting / Cold-plate mounting, wall mounting: Diagrams adjusted (calculation of the width of the mounting plates)

Table 1: Manual history (cont.)

Version	Date	Comment
0.30 Preliminary	2007-01-31	<p>Changes / new features</p> <ul style="list-style-type: none"> • Installation: <ul style="list-style-type: none"> Installation diagrams for inverter module wall mounting • Wiring: <ul style="list-style-type: none"> Insulation and high voltage test • Wiring of plug-in modules: <ul style="list-style-type: none"> Interior wiring updated • Technical data: <ul style="list-style-type: none"> Indicator descriptions and LED status updated • Dimensioning: Power connection updated • Technical data, regeneration choke: <ul style="list-style-type: none"> Screw connector added • Technical data, inverter modules: <ul style="list-style-type: none"> Nominal currents and derating updated (8BVI0014, 8BVI0028, 8BVI0055) • Technical data, auxiliary supply modules: <ul style="list-style-type: none"> Peak current (>4 s) 24 VDC internal system supply voltage changed • Technical data, inverter: <ul style="list-style-type: none"> Dependency of the motor cable length on the switching frequency documented • Technical data, regeneration chokes: <ul style="list-style-type: none"> 8BVR0880H000.100-1 updated • Technical data, line filter: <ul style="list-style-type: none"> 8BVF0880H000.000-1 updated • Dimension diagrams and installation dimensions, wiring for regeneration chokes: <ul style="list-style-type: none"> 8BVR0880H000.100-1 updated • Dimension diagrams and installation dimensions, wiring for line filter: <ul style="list-style-type: none"> 8BVF0880H000.000-1 updated • Plug-in module pin assignments: <ul style="list-style-type: none"> Plug name changed from X1 to X11 • Fan module pin assignments added
0.29 Preliminary	xx.11.2006	<p>Changes / new features</p> <ul style="list-style-type: none"> • Technical data for inverter modules: <ul style="list-style-type: none"> Cable length depending on the switching frequency • Module images added • Cross references from modules to plug-in modules • Installation diagrams for mounting plate wall mounting • Weights/dimensions updated for line filter and regeneration choke • Figure index, Table index and Model number index added
0.28 Preliminary	xx.09.2006	<p>Changes / new features</p> <ul style="list-style-type: none"> • Pin assignments: <ul style="list-style-type: none"> Additional plug-in modules: EnDat 2.1, EnDat 2.2, SinCos
0.27 Preliminary	xx.08.2006	<p>Changes / new features</p> <ul style="list-style-type: none"> • Technical data: <ul style="list-style-type: none"> Revisions according to PA on 04.08.06 Additional plug-in modules: EnDat 2.1, EnDat 2.2, SinCos Inverter modules: Distribution of single and double-axis modules in different sections
0.26 Preliminary	2006-07-18	<p>Changes / new features</p> <ul style="list-style-type: none"> • Technical data: <ul style="list-style-type: none"> Revisions according to PA and discussion on July 05, 2006 New: EnDat plug-in module according to PA New: Distribution of inverter modules according to PA New: Additional auxiliary supply modules according to PA New: Additional power supply modules according to PA

Table 1: Manual history (cont.)

General information • Manual history

Version	Date	Comment
0.25 Preliminary	2006-07-06	Changes / new features <ul style="list-style-type: none"> Auxiliary supply modules: Numbering in the overview diagram for X3 plug corrected
0.24 Preliminary	2006-07-04	Changes / new features <ul style="list-style-type: none"> Additional shielding component set added (8SCS005.0000-00) Model numbers for plugs: 8TB3104.201A-00 --> 8TB3104.201A-10 8TB4104.202D-00 --> 8TB4104.206D-10 8TB4104.202N-00 --> 8TB4104.202N-10 Technical data from exhibition brochures added Technical data: Layout changes made to the required optional accessories Auxiliary supply modules: New coding for X3 plug
0.23 Preliminary	2006-05-19	Changes / new features <ul style="list-style-type: none"> Order data in chapter 2 updated Required and optional accessories added Overview images revised in chapter 5
0.22 Preliminary	2006-05-16	Changes / new features <ul style="list-style-type: none"> Dummy chapter with technical data added Wiring: New overview images added, previous overview images deleted
0.21 Preliminary	2006-03-30	Changes / new features <ul style="list-style-type: none"> "Preliminary" deleted except in the manual history Images of the plug used for 8BVF.... changed (coding was not shown correctly)
0.20 Preliminary	2006-03-16	Changes / new features <ul style="list-style-type: none"> Pin assignments for the line filter and regeneration choke added Pins assignments for additional auxiliary power supplies added Safety guidelines updated to include guidelines for handling ESD
0.10 Preliminary	2006-03-16	Start of revision history publication

Table 1: Manual history (cont.)

2. Safety guidelines

2.1 Safety notices

The safety notices in this manual are organized as follows:

Safety notice	Description
Danger!	Disregarding the safety regulations and guidelines can be life-threatening.
Warning!	Disregarding the safety regulations and guidelines can result in severe injury or major damage to material.
Caution!	Disregarding the safety regulations and guidelines can result in injury or damage to material.
Information:	Important information for preventing errors.

Table 2: Description of the safety notices used

2.2 General information

B&R drive systems and servo motors have been designed, developed and manufactured for conventional use in industry. They were not designed, developed, and manufactured for any use involving serious risks or hazards that could lead to death, injury, serious physical damage, or loss of any kind without the implementation of exceptionally stringent safety precautions.

Such risks include in particular the use of these devices to monitor nuclear reactions in nuclear power plants, flight control systems, flight safety, the control of mass transportation systems, medical life support systems and the control of weapons systems.

Danger!

Drive systems and servo motors can have bare parts with voltages applied (e. g. terminals) or hot surfaces. Additional sources of danger result from moving machine parts. Improperly removing the required covers, inappropriate use, incorrect installation or incorrect operation can result in severe personal injury or damage to property.

All tasks, such as transport, installation, commissioning and service, are only permitted to be carried out by qualified personnel. Qualified personnel are persons familiar with transport, mounting, installation, commissioning and operation of the product and have the respective qualifications (e. g. IEC 60364). National accident prevention guidelines must be followed.

The safety guidelines, connection descriptions (type plate and documentation), and limit values listed in the technical data are to be read carefully before installation and commissioning and must be observed.

Danger!

Handling drive systems and servo motors incorrectly can cause severe personal injury or damage to property!

2.3 Intended use

Servo drives are components designed to be installed in electrical systems or machines. They are not being used as intended unless the machine meets EC directive 2006/42/EG (machine directive) as well as directive 2004/108/CE (EMC directive).

Drive systems are only permitted to be operated directly on grounded, three-phase industrial mains (TN, TT power mains). When used in living areas, shops and small businesses, additional filtering measures must be implemented by the user.

Danger!

Drive systems are not permitted to be operated directly on IT and TN-S mains with a grounded phase conductor and protective ground conductor!

Technical data as well as connection and environmental specifications can be found on the type plate and in the user's manual. The connection and environmental specifications must be met!

Danger!

Electronic devices are generally not failsafe. If the drive systems fails, the user is responsible for making sure that the motor is placed in a secure state.

2.4 Protection against electrostatic discharges

Electrical components that are vulnerable to electrostatic discharge (ESD) must be handled accordingly.

2.4.1 Packaging

Electrical components with housing do not require special ESD packaging, but must be handled properly (see "Electrical components with housing").

Electrical components without housing must be protected by ESD-suitable packaging.

2.4.2 Guidelines for proper ESD handling

Electrical components with housing

- Do not touch the connector contacts on connected cables.
- Do not touch the contact tips on the circuit boards.

Electrical components without housing

In addition to "Electrical components with housing", the following also applies:

- Any persons handling electrical components or devices that will be installed in the electrical components must be grounded.
- Components can only be touched on the small sides or on the front plate.
- Components should always be stored in a suitable medium (ESD packaging, conductive foam, etc.).
Metallic surfaces are not suitable storage surfaces!
- Electrostatic discharges should be avoided on the components (e.g. through charged plastics).
- A minimum distance of 10 cm must be kept from monitors and TV sets.
- Measurement devices and equipment must be grounded.
- Measurement probes on potential-free measurement devices must be discharged on sufficiently grounded surfaces before taking measurements.

Individual components

- ESD protective measures for individual components are thoroughly integrated at B&R (conductive floors, footwear, arm bands, etc.).
- The increased ESD protective measures for individual components are not necessary for our customers for handling B&R products.

2.5 Transport and storage

During transport and storage, devices must be protected from excessive stress (mechanical load, temperature, humidity, aggressive atmospheres, etc.).

Drive systems contain components sensitive to electrostatic charges which can be damaged by inappropriate handling. It is therefore necessary to provide the required safety precautions against electrostatic discharges during installation or removal of drive systems.

2.6 Handling and installation

Warning!

B&R drive systems and servo motors can be heavy.

Therefore, during handling and installation of heavy B&R drive systems or servo motors, there's danger of personal injury or damage to property (shearing, impact, cutting or crushing). Suitable protective equipment (e.g. safety glasses, protective gloves, safety shoes, etc.) should be used when necessary!

Installation must take place according to the user's manual using suitable equipment and tools.

Devices must be installed without voltage applied and by qualified personnel. Before installation, voltage to the switching cabinet should be switched off and prevented from being switched on again.

The general safety regulations and national accident prevention guidelines (e. g. VBG 4) must be observed when working with high voltage systems.

The electrical installation must be carried out according to the relevant guidelines (e.g. line cross section, fuse, protective ground connection, also see chapter 4 "Dimensioning").

2.7 Operation

2.7.1 Protection against touching electrical parts

Danger!

To operate drive systems, it is necessary for certain parts to carry dangerous voltages over 42 VDC. A life-threatening electrical shock could occur if you come into contact with these parts. This could result in death, severe injury or material damage.

Before turning on a drive system, make sure that the housing is properly connected to ground (PE rail). The ground connection must be made, even when testing the drive system or when operating it for a short time!

Before turning the device on, make sure that all parts with voltage applied are securely covered. During operation, all covers and switching cabinet doors must remain closed.

Danger!

If an application uses safety functions integrated in the drive system, then the safety functions must be fully validated before being turned on for the first time. This could result in death, severe injury or material damage.

Control and high power contacts can have voltage applied, even when the motor is not turning. Touching the contacts when the device is switched on is not permitted.

Before working on drive systems, they must be disconnected from the power mains and prevented from being switched on again.

Danger!

Risk of electric shock

Before servicing, disconnect supply and wait 5 minutes to be sure that the capacitors have discharged. See instructions!

The ACOPOSmulti modules are labeled with the following warning:

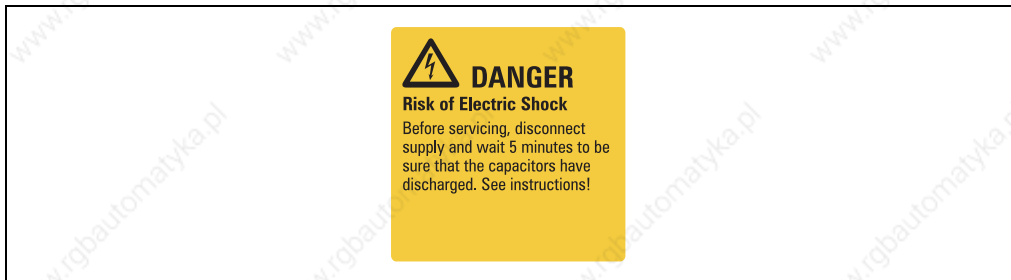


Figure 1: Warning label on the ACOPOSmulti module

The connections for the signal voltages (5 to 30 V) found on the drive system are isolated circuits. Therefore, the signal voltage connections and interfaces are only permitted to be connected to devices or electrical components that have sufficient isolation according to IEC 60364-4-41 or EN 61800-5-1 and that correspond to SELV / PELV.

Never remove the electrical connections from the drive system with voltage applied. In unfavorable conditions, arcs can occur causing personal injury and damage to contacts.

2.7.2 Protection from dangerous movements

Danger!

Incorrect control of motors can cause unwanted and dangerous movements! Such incorrect behavior can have various causes:

- **Incorrect installation or an error when handling the components**
- **Incorrect or incomplete wiring**
- **Defective devices (drive system, motor, position encoder, cable, brake)**
- **Incorrect control (e. g. caused by software error)**

Some of these causes can be recognized and prevented by the drive system using internal monitoring. However, it is generally possible for the motor shaft to move every time the device is switched on! Therefore protection of personnel and the machine can only be guaranteed using higher level safety precautions.

The movement area of machines must be protected to prevent accidental access. This type of protection can be obtained by using stable mechanical protection such as protective covers, protective fences, protective gates or photocells.

Removing, bridging or bypassing these safety features and entering the movement area is prohibited.

A sufficient number of emergency stop switches are to be installed directly next to the machine. The emergency stop equipment must be checked before commissioning the machine.

On free running motors, remove shaft keys or prevent them from being catapulted.

The holding brake built into the motors cannot prevent hoists from allowing the load to sink.

2.8 Specifications for functional safety

Specifications for functional safety are listed in chapter 6 "Safety technology".

The specifications are determined based on a proof test interval of maximum 20 years. A proof test cannot be carried out for B&R drive systems, so the proof test interval is the service life of the system.

According to the standards EN ISO 13849, EN 62061 and IEC 61508, the safety function described in Chapter 6 "Safety technology" cannot be used beyond the specified service life.

Danger!

The user must ensure that all B&R drive systems that fulfill a safety function are replaced with new B&R drive systems or removed from operation before their service life expires.

2.9 Environmentally-friendly disposal

All B&R drive systems and servo motors are designed to inflict as little harm on the environment as possible.

2.9.1 Separation of materials

It is necessary to separate different materials so the device can undergo an environmentally-friendly recycling process.

Component	Disposal
Drive systems, servo motors, cables	Electronics recycling
Cardboard box / paper packaging	Paper/cardboard recycling

Table 3: Environmentally-friendly separation of materials

Disposal must comply with the respective legal regulations.

Chapter 2 • Technical data

1. Configuration of an ACOPOSmulti drive system

The ACOPOSmulti drive system consists of a mounting plate, different modules (power supply, auxiliary supply and inverter, expansion and capacitor modules), plug-in modules as well as a line filter and - only in combination with 8BVP active power supply modules - a regeneration choke.

The configuration of an ACOPOSmulti drive system is done in 10 steps:

- 1) Determine the cooling method
- 2) Define and check supply voltage range and mains type
- 3) Select the ACOPOSmulti inverter modules according to application requirements
- 4) Select the ACOPOSmulti plug-in modules for motor encoder and external axis encoder according to the application requirements
- 5) If the ACOPOSmulti drive system should be expandable:
Determine the number of optional slots on the mounting plate for other ACOPOSmulti modules
- 6) Select ACOPOSmulti power supply modules according to the application requirements (active/passive power supply module) based on the total power of the ACOPOSmulti inverter modules needed (derating information must be taken into consideration if the supply voltage <math>< 3 \times 400 \text{ VAC}</math>)
- 7) Check the maximum chargeable DC bus capacitance
- 8) Select the ACOPOSmulti auxiliary supply module based on the total power required for the 24 VDC supply of the selected ACOPOSmulti module, ACOPOSmulti plug-in modules as well as the peripheral supply (e.g. PLC, actuators, motor holding brakes, sensors)
- 9) Determine the total number of slots by adding the width units of all selected ACOPOSmulti modules (including optional slots)
- 10) Select the ACOPOSmulti mounting plate according to the total number of slots required and specified cooling method

2. Indicators

The indicators are located on the black cover of each module.

2.1 8B0P power supply modules

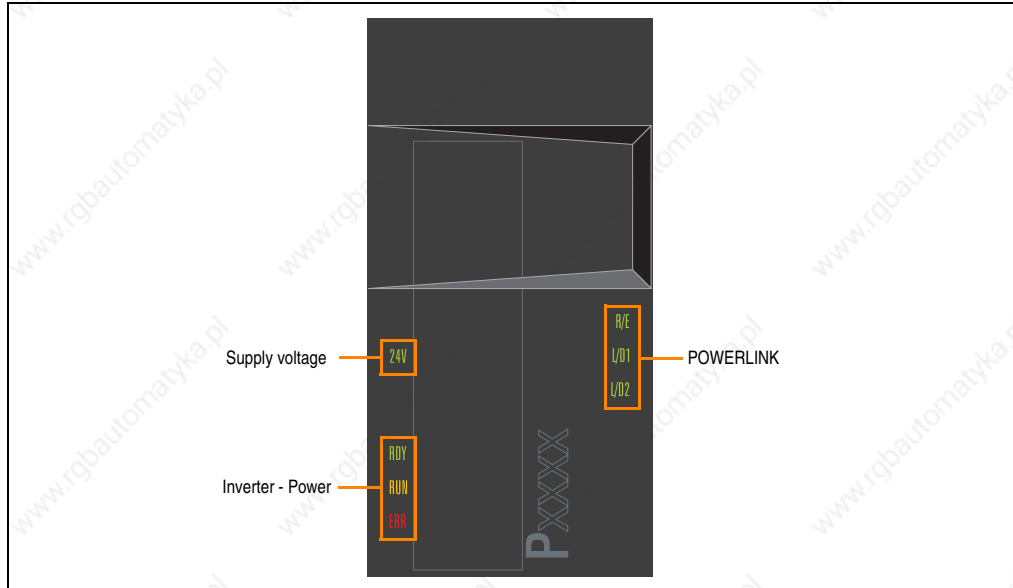


Figure 2: Indicator groups for 8B0P power supply units

2.1.1 Status LEDs

Indicator group	Labeling	Color	Function	Description
POWERLINK	R/E	Green/red	Ready/Error	See section 2.8 "LED status - POWERLINK", on page 48
	L/D1	Green	Link / Data activity Port 1	
	L/D2	Green	Link / Data activity Port 2	
Inverter - Power	RDY	Green	Ready	See 2.7 "LED status RDY, RUN, ERR (8BVI, 8BVP, 8B0P)", on page 48
	RUN	Orange	Run	
	ERR	Red	Error	
Supply voltage	24V	Green	24 V OK	24V internal system supply voltage is within the tolerance range and /or 24V module-internal supply voltage is within the tolerance range ¹⁾

Table 4 : LED status - 8BVP power supply modules

1) 8BxP power supply modules have an internal power supply, which generates 24 VDC right from the mains input voltage for module-internal purposes. The 24V LED is lit when this 24 VDC supply generated inside the module is present.

Therefore, the 24V LED could lite up even though the 24 VDC internal system voltage generated by the 24 VDC 8B0C auxiliary supply module is not present on the 8BxP power supply module via the mounting plate. For example, this is the case if the 24 VDC 8B0C auxiliary supply module on the ACOPOSmulti drive system is defective or has no electrical contact to the mounting plate.

2.2 8BVP power supply modules

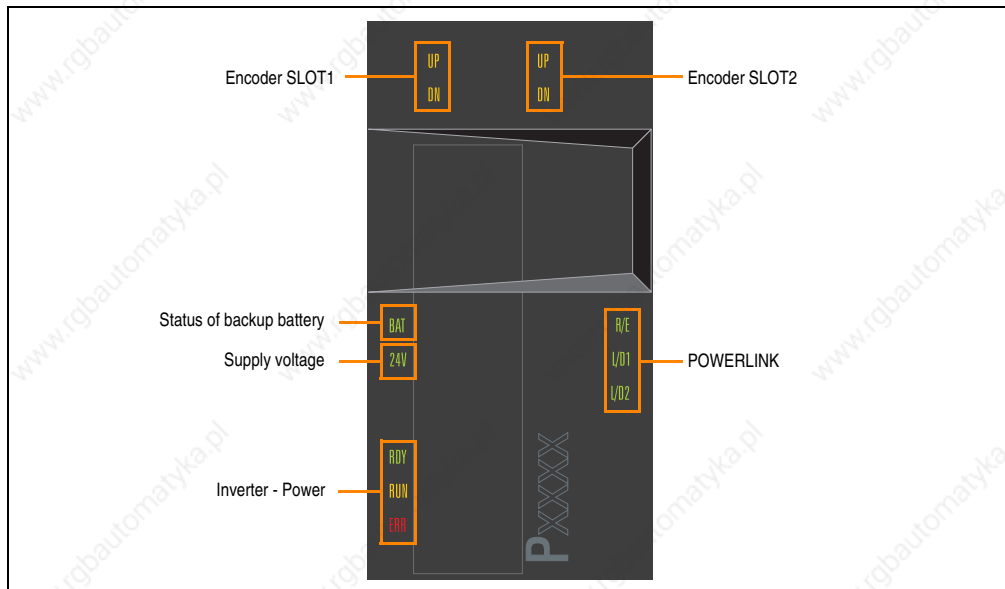


Figure 3: Indicator groups for 8BVP power supply units

2.2.1 Status LEDs

Indicator group	Labeling	Color	Function	Description
POWERLINK	R/E	Green/red	Ready/Error	See section 2.8 "LED status - POWERLINK", on page 48
	L/D1	Green	Link / Data activity Port 1	
	L/D2	Green	Link / Data activity Port 2	
Inverter - Power	RDY	Green	Ready	See 2.7 "LED status RDY, RUN, ERR (8BVI, 8BVP, 8B0P)", on page 48
	RUN	Orange	Run	
	ERR	Red	Error	
Status of backup battery	BAT	Green/red	Ready / Error	See 2.9 "LED status - Backup battery", on page 49
Supply voltage	24V	Green	24 V OK	24V internal system supply voltage is within the tolerance range and /or 24V module-internal supply voltage is within the tolerance range ¹⁾
Encoder SLOT1	UP	Orange	Encoder direction of rotation +	The encoder position of the connected encoder changed in the positive direction. The faster the encoder position changes, the brighter the LED is lit.
	DN	Orange	Encoder direction of rotation -	The encoder position of the connected encoder changed in the negative direction. The faster the encoder position changes, the brighter the LED is lit

Table 5 : LED status - 8BVP power supply modules

Technical data • Indicators

Indicator group	Labeling	Color	Function	Description
Encoder SLOT2	UP	Orange	Encoder direction of rotation +	see Encoder SLOT1
	DN	Orange	Encoder direction of rotation -	

Table 5 : LED status - 8BVP power supply modules (cont.)

- 1) 8BxP power supply modules have an internal power supply, which generates 24 VDC right from the mains input voltage for module-internal purposes. The 24V LED is lit when this 24 VDC supply generated inside the module is present.
Therefore, the 24V LED could lite up even though the 24 VDC internal system voltage generated by the 24 VDC 8B0C auxiliary supply module is not present on the 8BxP power supply module via the mounting plate. For example, this is the case if the 24 VDC 8B0C auxiliary supply module on the ACOPOSmulti drive system is defective or has no electrical contact to the mounting plate.

2.3 8B0C auxiliary supply modules

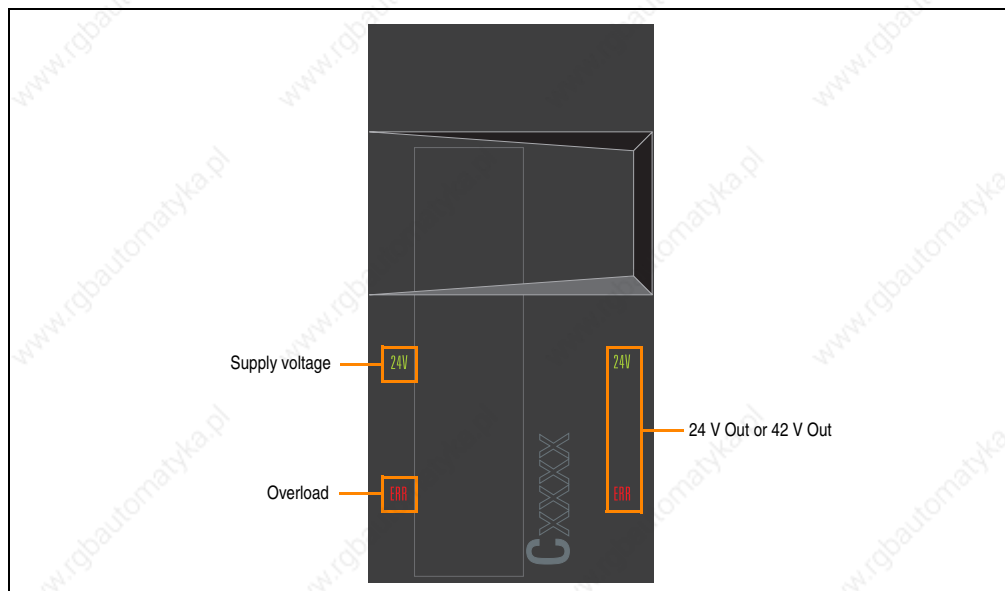


Figure 4: Indicator groups for 8B0C auxiliary supply modules

2.3.1 Status LEDs

Indicator group	Labeling	Color	Function	Description
Supply voltage	24V	Green	24 V OK	The 24 VDC internal system supply voltage is within the permissible tolerance
	42V ¹⁾		42 V OK	The 42 VDC supply is within the permissible tolerance
Overload	ERR	Red	Overload	The module is not supplied via the DC bus voltage. ²⁾ The 24 VDC internal system supply voltage or 42 VDC supply is outside of the permissible tolerance (overload, over-temperature, short-circuit, etc)
24 V Out or 42 V Out ³⁾	24V	Green	24 V Out OK	One of the switchable 24 VDC outputs or 42 VDC outputs is active and the output voltage is within the permissible tolerance The 24 VDC internal system supply voltage is within the permissible tolerance ⁴⁾
	42V ¹⁾		42 V Out OK	
	ERR	Red	24 V Out error 42 V Out error ¹⁾	The 24 VDC internal system supply voltage or 42 VDC supply is outside of the permissible tolerance (overload, over-temperature, short-circuit, etc) At least one of the switchable outputs is active and the electronic fuse has been triggered on one or more switchable outputs.

Table 6 : LED status - 8B0C auxiliary supply modules

1) Only on 8B0C0160HC00.A01-1.

2) The module is enabled via the input CR_OK, no electrical contact to the backplane module - check bottom mounting screws.

3) Only on 8B0C0160Hx00.001-1, 8B0C0160HC00.A01-1 and 8B0C0320Hx00.002-1.

4) Only on 8B0C0160Hx00.001-1 and 8B0C0320Hx00.002-1.

2.4 8BVI inverter modules

2.4.1 Single-axis modules

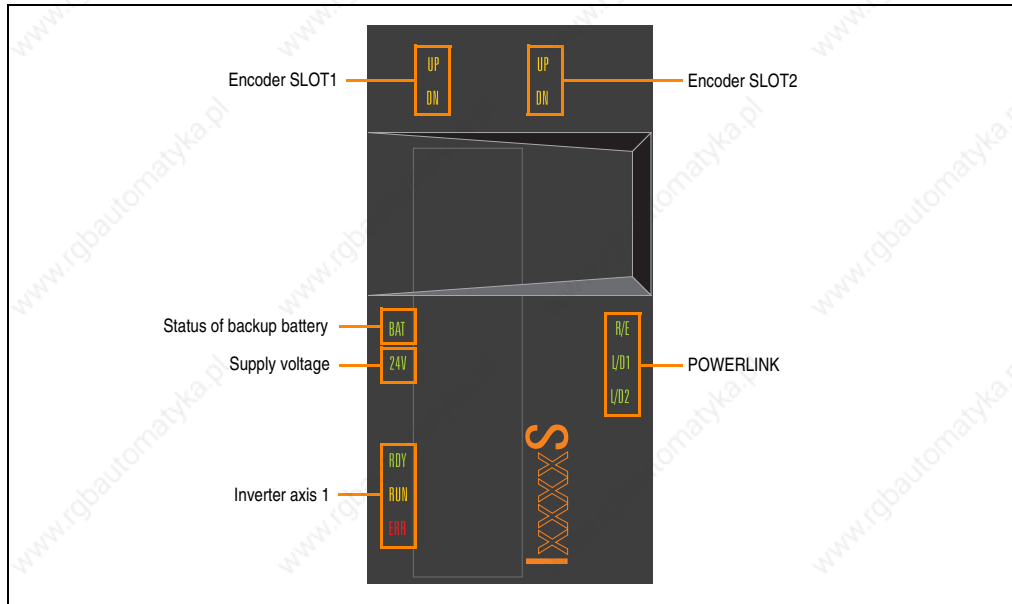


Figure 5: Indicator groups for 8BVI inverter modules (single-axis modules)

Status LEDs

Indicator group	Labeling	Color	Function	Description
POWERLINK	R/E	Green/red	Ready/Error	See 2.8 "LED status - POWERLINK", on page 48
	L/D1	Green	Link / Data activity Port 1	
	L/D2	Green	Link / Data activity Port 2	
Inverter axis 1	RDY	Green	Ready	See 2.7 "LED status RDY, RUN, ERR (8BVI, 8BVP, 8B0P)", on page 48
	RUN	Orange	Run	
	ERR	Red	Error	
Status of backup battery	BAT	Green/red	Ready / Error	See 2.9 "LED status - Backup battery", on page 49
Supply voltage	24V	Green	24 V OK	The 24V module supply voltage is within the tolerance range.
Encoder SLOT1	UP	Orange	Encoder direction of rotation +	The encoder position of the connected encoder changed in the positive direction. The faster the encoder position changes, the brighter the LED is lit.
	DN	Orange	Encoder direction of rotation -	The encoder position of the connected encoder changed in the negative direction. The faster the encoder position changes, the brighter the LED is lit.
Encoder SLOT2	UP	Orange	Encoder direction of rotation +	see Encoder SLOT1
	DN	Orange	Encoder direction of rotation -	

Table 7: LED status, 8BVI inverter modules (single-axis modules)

2.4.2 Two-axis modules

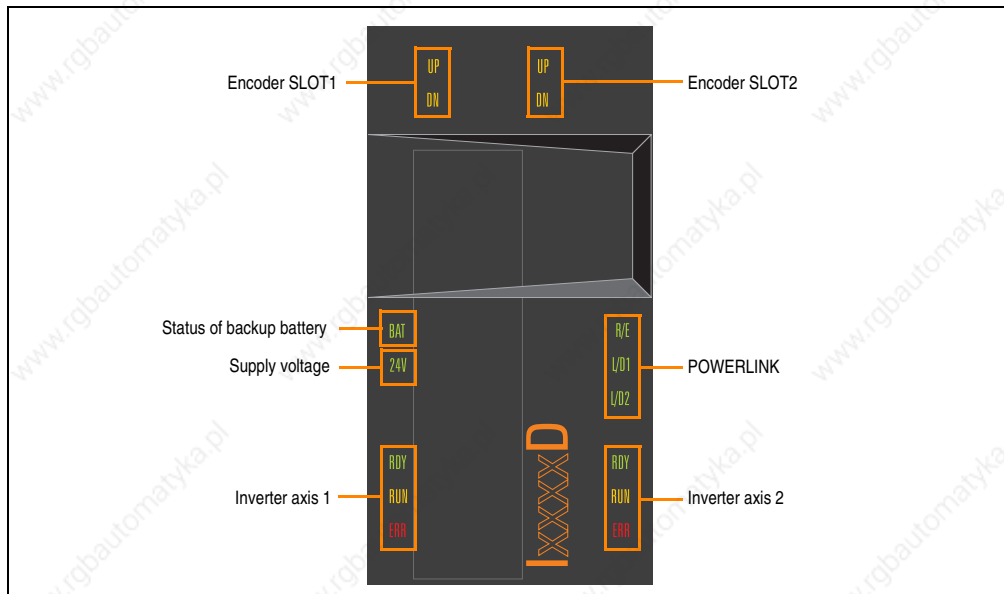


Figure 6: Indicator groups for 8BVI inverter modules (two-axis modules)

Status LEDs

Indicator group	Labeling	Color	Function	Description
POWERLINK	R/E	Green/red	Ready/Error	See 2.8 "LED status - POWERLINK", on page 48
	L/D1	Green	Link / Data activity Port 1	
	L/D2	Green	Link / Data activity Port 2	
Inverter axis 1	RDY	Green	Ready	See 2.7 "LED status RDY, RUN, ERR (8BVI, 8BVP, 8B0P)", on page 48
	RUN	Orange	Run	
	ERR	Red	Error	
Inverter axis 2	RDY	Green	Ready	See inverter axis 1
	RUN	Orange	Run	
	ERR	Red	Error	
Status of backup battery	BAT	Green/red	Ready / Error	See 2.9 "LED status - Backup battery", on page 49
Supply voltage	24V	Green	24 V OK	The 24V module supply voltage is within the tolerance range.
Encoder SLOT1	UP	Orange	Encoder direction of rotation +	The encoder position of the connected encoder changed in the positive direction. The faster the encoder position changes, the brighter the LED is lit.
	DN	Orange	Encoder direction of rotation -	
Encoder SLOT2	UP	Orange	Encoder direction of rotation +	see Encoder SLOT1
	DN	Orange	Encoder direction of rotation -	

Table 8: LED status, 8BVI inverter modules (two-axis modules)

2.5 8BVE expansion modules

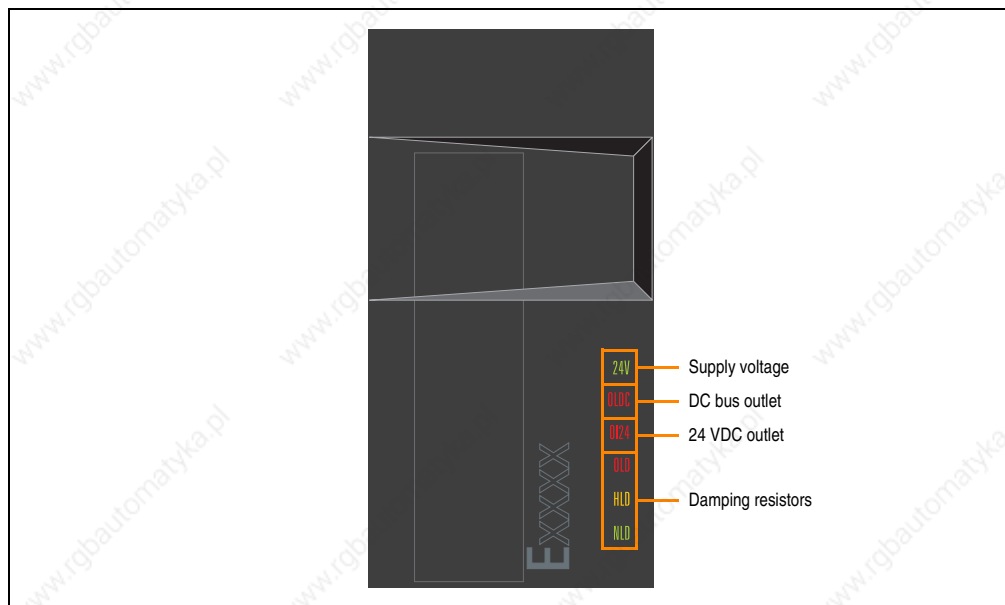


Figure 7: Indicator groups for 8BVE expansion modules

2.5.1 Status LEDs

Indicator group	Labeling	Color	Function	Description
Supply voltage	24V	Green	24 V OK	The 24V module supply voltage is within the tolerance range.
DC bus outlet	OLDC	Red	Overload	DC bus outlet is overloaded. <ul style="list-style-type: none"> The alarm contacts are triggered. Caution! After the OLDC LED is lit, both fuses must be exchanged!
24 VDC outlet	OL24	Red	Overload	The 24 VDC outlet is overloaded. <ul style="list-style-type: none"> The alarm contacts are triggered.
Damping resistors	OLD	Red	Load > 100%	The damping resistors are overloaded. <ul style="list-style-type: none"> The alarm contacts are triggered.
	HLD	Orange	75% < load < 100%	The load on the damping resistors is high. <ul style="list-style-type: none"> The alarm contacts are not triggered.
	NLD	Green	Load <75%	The load on the damping resistors is in the normal range. <ul style="list-style-type: none"> The alarm contacts are not triggered.

Table 9 : Status LEDs - 8BVE expansion modules

2.6 8B0K capacitor modules

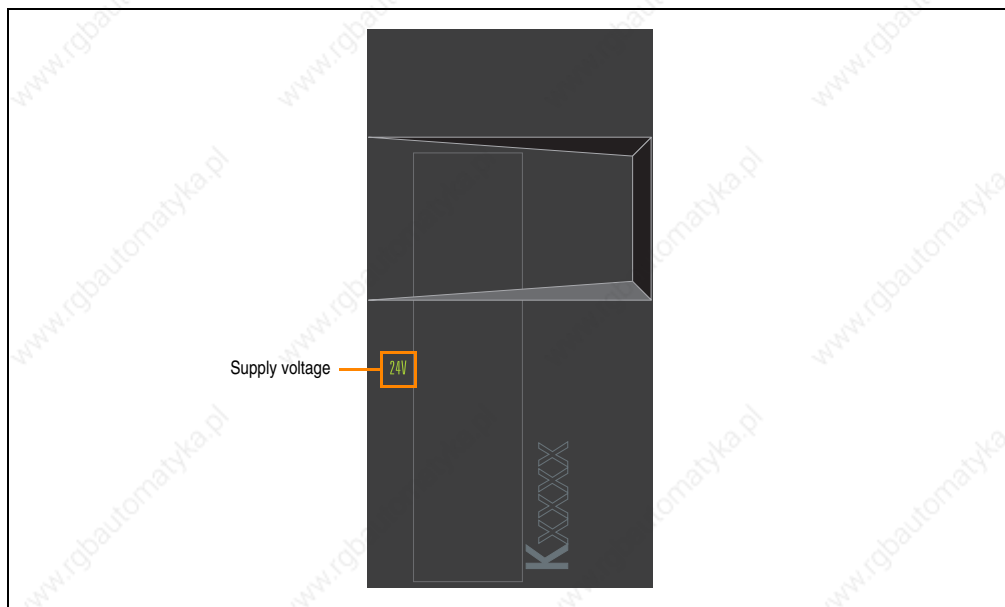


Figure 8: Indicator groups for 8B0K capacitor modules

2.6.1 Status LEDs

Indicator group	Labeling	Color	Function	Description
Supply voltage	24V	Green	24 V OK	The 24V module supply voltage is within the tolerance range.

Table 10 : Status LEDs - 8B0K capacitor modules

2.7 LED status RDY, RUN, ERR (8BVI, 8BVP, 8B0P)

Labeling	Color	Function	Description	
RDY	Green	Ready	Green (lit)	The module is operational and the power stage can be enabled (operating system present and booted, no permanent or temporary errors).
			Green (blinking) ¹⁾	Module is not ready for operation <u>Examples:</u> <ul style="list-style-type: none"> No signal on one or both enable inputs DC bus voltage exceeds the tolerance range Over-temperature on the motor (temperature sensor) Motor feedback not connected or defective Motor temperature sensor not connected or defective Over-temperature on the module (IGBT junction, heatsink, etc.) Network fault
RUN	Orange	Run	Orange (lit)	The module's power stage is enabled.
ERR	Red	Error	Red (lit) ¹⁾	There is a permanent error on the module. <u>Examples:</u> <ul style="list-style-type: none"> Permanent over-current Data in EPROM not valid

Table 11 : LED status RDY, RUN, ERR (8BVI, 8BVP, 8B0P)

1) Firmware V2.130 and higher.

2.8 LED status - POWERLINK

Labeling	Color	Function	Description	
R/E	Green/red	Ready/Error	LED isn't lit	Supply voltage is not applied to the module or initialization of the network interface has failed.
			Red (lit)	The POWERLINK node number of the module is 0.
			Red/green blinking	The client is in an error state (drops out of cyclic operation).
			Green blinking (1x)	The client recognizes a valid POWERLINK frame on the network.
			Green blinking (2x)	Cyclic operation on the network; however the client itself is not yet participating in cyclic operation.
			Green blinking (3x)	Cyclic operation of the client is in preparation.
			Green (lit)	The client is participating in cyclic operation.
			Green (flickering)	The client is not participating in cyclic operation and also does not detect any other stations on the network that are participating in cyclic operation.
L/D1	Green	Link / Data activity Port 1	Green (lit)	There is a physical connection to another station on the network.
			Green (blinking)	Activity Port 1
L/D2	Green	Link / Data activity Port 2	Green (lit)	There is a physical connection to another station on the network.
			Green (blinking)	Activity Port 2

Table 12 : LED status - POWERLINK

2.9 LED status - Backup battery

Labeling	Color	Function	Description	
BAT	Green/red	Ready / Error	LED isn't lit	<p><u>Possible causes:</u></p> <ul style="list-style-type: none"> The voltage of the installed backup battery is within the tolerance range, but an EnDat encoder with backup battery is not connected An EnDat encoder with backup battery is connected and registering "Battery ok", but the module's firmware version does not support EnDat encoders with battery backup
			Green (lit)	An EnDat encoder with battery backup is connected and registering "Battery ok" (voltage of the installed backup battery is within the tolerance range).
			Red (lit)	<p>An EnDat encoder with battery backup is connected and registering "Battery not ok".</p> <p><u>Possible causes:</u></p> <ul style="list-style-type: none"> Voltage of the installed backup battery outside of tolerance range No backup battery installed in module

Table 13 : LED status - Backup battery

2.10 Status changes when booting the operating system loader

The following timing is used for the indication diagram:

Block size: 50 ms
Repeats after: 3,000 ms

Status	LED	Display
1. Boot procedure for basic hardware active	RDY	[Vertical bars]
	RUN	[Vertical bars]
	ERR	[Red horizontal bar]
2. Configuration network active	RDY	[Green horizontal bar]
	RUN	[Vertical bars]
	ERR	[Red horizontal bar]
3. Waiting for network telegram	RDY	[Vertical bars]
	RUN	[Vertical bars]
	ERR	[Red horizontal bar]
4. Network communication active	RDY	[Vertical bars]
	RUN	[Vertical bars]
	ERR	[Red horizontal bar]
5. ACOPOS operating system being transferred/burned ¹⁾	RDY	[Vertical bars]
	RUN	[Vertical bars]
	ERR	[Red horizontal bar]

Table 14: Status changes when booting the operating system loader

1) Firmware V2.140 and higher.

3. Module overview

3.1 Line filter

Model number	Short description	Page
8B0F0300H000.000-1	ACOPOSmulti passive line filter, 30 A, 3 x 520/300 VAC, 50/60 Hz, IP20	57
8B0F0550H000.000-1	ACOPOSmulti passive line filter, 55 A, 3 x 520/300 VAC, 50/60 Hz, IP20	57
8BVF0220H000.000-1	ACOPOSmulti line filter, 22.5 A, 480 V	60
8BVF0440H000.001-2	ACOPOSmulti line filter 45 A, 480 V, increased peak current load capacity	60
8BVF0880H000.000-1	ACOPOSmulti line filter, 90 A, 480 V	60

Table 15: Module overview - Line filter

3.2 Regeneration chokes

Model number	Short description	Page
8BVR0220H000.100-1	ACOPOSmulti regeneration choke 22.5 A, 480 V, connection terminals	64
8BVR0440H000.100-1	ACOPOSmulti regeneration choke 45 A, 480 V, connection terminals	64
8BVR0880H000.100-1	ACOPOSmulti regeneration choke 90 A, 480 V, connection terminals	64

Table 16: Module overview - Regeneration chokes

3.3 Mounting plates

3.3.1 Wall mounting

Model number	Short description	Page
8B0M0040HW00.000-1	ACOPOSmulti mounting plate with backplane, 4 slots, HV, wall mounting, 75 mm ² and 22 mm ² , complete	67
8B0M0050HW00.000-1	ACOPOSmulti mounting plate with backplane, 5 slots, HV, wall mounting, 75 mm ² and 22 mm ² , complete	67
8B0M0060HW00.000-1	ACOPOSmulti mounting plate with backplane, 6 slots, HV, wall mounting, 75 mm ² and 22 mm ² , complete	67
8B0M0070HW00.000-1	ACOPOSmulti mounting plate with backplane, 7 slots, HV, wall mounting, 75 mm ² and 22 mm ² , complete	67
8B0M0080HW00.000-1	ACOPOSmulti mounting plate with backplane, 8 slots, HV, wall mounting, 75 mm ² and 22 mm ² , complete	67
8B0M0090HW00.000-1	ACOPOSmulti mounting plate with backplane, 9 slots, HV, wall mounting, 75 mm ² and 22 mm ² , complete	67
8B0M0100HW00.000-1	ACOPOSmulti mounting plate with backplane, 10 slots, HV, wall mounting, 75 mm ² and 22 mm ² , complete	67
8B0M0110HW00.000-1	ACOPOSmulti mounting plate with backplane, 11 slots, HV, wall mounting, 75 mm ² and 22 mm ² , complete	67
8B0M0120HW00.000-1	ACOPOSmulti mounting plate with backplane, 12 slots, HV, wall mounting, 75 mm ² and 22 mm ² , complete	67
8B0M0130HW00.000-1	ACOPOSmulti mounting plate with backplane, 13 slots, HV, wall mounting, 75 mm ² and 22 mm ² , complete	67
8B0M0140HW00.000-1	ACOPOSmulti mounting plate with backplane, 14 slots, HV, wall mounting, 75 mm ² and 22 mm ² , complete	67
8B0M0150HW00.000-1	ACOPOSmulti mounting plate with backplane, 15 slots, HV, wall mounting, 75 mm ² and 22 mm ² , complete	67
8B0M0160HW00.000-1	ACOPOSmulti mounting plate with backplane, 16 slots, HV, wall mounting, 75 mm ² and 22 mm ² , complete	67
8B0M0170HW00.000-1	ACOPOSmulti mounting plate with backplane, 17 slots, HV, wall mounting, 75 mm ² and 22 mm ² , complete	67

Table 17: Module overview - Mounting plates (wall mounting)

Model number	Short description	Page
8B0M0180HW00.000-1	ACOPOSmulti mounting plate with backplane, 18 slots, HV, wall mounting, 75 mm ² and 22 mm ² , complete	67
8B0M0190HW00.000-1	ACOPOSmulti mounting plate with backplane, 19 slots, HV, wall mounting, 75 mm ² and 22 mm ² , complete	67
8B0M0200HW00.000-1	ACOPOSmulti mounting plate with backplane, 20 slots, HV, wall mounting, 75 mm ² and 22 mm ² , complete	67
8B0M0210HW00.000-1	ACOPOSmulti mounting plate with backplane, 21 slots, HV, wall mounting, 75 mm ² and 22 mm ² , complete	67
8B0M0220HW00.000-1	ACOPOSmulti mounting plate with backplane, 22 slots, HV, wall mounting, 75 mm ² and 22 mm ² , complete	67
8B0M0230HW00.000-1	ACOPOSmulti mounting plate with backplane, 23 slots, HV, wall mounting, 75 mm ² and 22 mm ² , complete	67
8B0M0240HW00.000-1	ACOPOSmulti mounting plate with backplane, 24 slots, HV, wall mounting, 75 mm ² and 22 mm ² , complete	67
8B0M0250HW00.000-1	ACOPOSmulti mounting plate with backplane, 25 slots, HV, wall mounting, 75 mm ² and 22 mm ² , complete	67
8B0M0260HW00.000-1	ACOPOSmulti mounting plate with backplane, 26 slots, HV, wall mounting, 75 mm ² and 22 mm ² , complete	67
8B0M0270HW00.000-1	ACOPOSmulti mounting plate with backplane, 27 slots, HV, wall mounting, 75 mm ² and 22 mm ² , complete	67

Table 17: Module overview - Mounting plates (wall mounting) (cont.)

3.3.2 Cold-plate installation

Model number	Short description	Page
8B0M0040HC00.000-1	ACOPOSmulti mounting plate with backplane, 4 slots, HV, cold plate mounting, 75 mm ² and 22 mm ² , complete	67
8B0M0050HC00.000-1	ACOPOSmulti mounting plate with backplane, 5 slots, HV, cold plate mounting, 75 mm ² and 22 mm ² , complete	67
8B0M0060HC00.000-1	ACOPOSmulti mounting plate with backplane, 6 slots, HV, cold plate mounting, 75 mm ² and 22 mm ² , complete	67
8B0M0070HC00.000-1	ACOPOSmulti mounting plate with backplane, 7 slots, HV, cold plate mounting, 75 mm ² and 22 mm ² , complete	67
8B0M0080HC00.000-1	ACOPOSmulti mounting plate with backplane, 8 slots, HV, cold plate mounting, 75 mm ² and 22 mm ² , complete	67
8B0M0090HC00.000-1	ACOPOSmulti mounting plate with backplane, 9 slots, HV, cold plate mounting, 75 mm ² and 22 mm ² , complete	67
8B0M0100HC00.000-1	ACOPOSmulti mounting plate with backplane, 10 slots, HV, cold plate mounting, 75 mm ² and 22 mm ² , complete	67
8B0M0110HC00.000-1	ACOPOSmulti mounting plate with backplane, 11 slots, HV, cold plate mounting, 75 mm ² and 22 mm ² , complete	67
8B0M0120HC00.000-1	ACOPOSmulti mounting plate with backplane, 12 slots, HV, cold plate mounting, 75 mm ² and 22 mm ² , complete	67
8B0M0130HC00.000-1	ACOPOSmulti mounting plate with backplane, 13 slots, HV, cold plate mounting, 75 mm ² and 22 mm ² , complete	67
8B0M0140HC00.000-1	ACOPOSmulti mounting plate with backplane, 14 slots, HV, cold plate mounting, 75 mm ² and 22 mm ² , complete	67
8B0M0150HC00.000-1	ACOPOSmulti mounting plate with backplane, 15 slots, HV, cold plate mounting, 75 mm ² and 22 mm ² , complete	67
8B0M0160HC00.000-1	ACOPOSmulti mounting plate with backplane, 16 slots, HV, cold plate mounting, 75 mm ² and 22 mm ² , complete	67
8B0M0170HC00.000-1	ACOPOSmulti mounting plate with backplane, 17 slots, HV, cold plate mounting, 75 mm ² and 22 mm ² , complete	67
8B0M0180HC00.000-1	ACOPOSmulti mounting plate with backplane, 18 slots, HV, cold plate mounting, 75 mm ² and 22 mm ² , complete	67
8B0M0190HC00.000-1	ACOPOSmulti mounting plate with backplane, 19 slots, HV, cold plate mounting, 75 mm ² and 22 mm ² , complete	67
8B0M0200HC00.000-1	ACOPOSmulti mounting plate with backplane, 20 slots, HV, cold plate mounting, 75 mm ² and 22 mm ² , complete	67
8B0M0210HC00.000-1	ACOPOSmulti mounting plate with backplane, 21 slots, HV, cold plate mounting, 75 mm ² and 22 mm ² , complete	67
8B0M0220HC00.000-1	ACOPOSmulti mounting plate with backplane, 22 slots, HV, cold plate mounting, 75 mm ² and 22 mm ² , complete	67
8B0M0230HC00.000-1	ACOPOSmulti mounting plate with backplane, 23 slots, HV, cold plate mounting, 75 mm ² and 22 mm ² , complete	67
8B0M0240HC00.000-1	ACOPOSmulti mounting plate with backplane, 24 slots, HV, cold plate mounting, 75 mm ² and 22 mm ² , complete	67
8B0M0250HC00.000-1	ACOPOSmulti mounting plate with backplane, 25 slots, HV, cold plate mounting, 75 mm ² and 22 mm ² , complete	67
8B0M0260HC00.000-1	ACOPOSmulti mounting plate with backplane, 26 slots, HV, cold plate mounting, 75 mm ² and 22 mm ² , complete	67
8B0M0270HC00.000-1	ACOPOSmulti mounting plate with backplane, 27 slots, HV, cold plate mounting, 75 mm ² and 22 mm ² , complete	67

Table 18: Module overview - Mounting plates (cold-plate mounting)

3.3.3 Feed-through mounting

Model number	Short description	Page
8B0M0040HF00.000-1	ACOPOSmulti mounting plate with backplane 4 slots, HV, feed-through mounting, 75 mm ² and 22 mm ² , complete	67
8B0M0080HF00.000-1	ACOPOSmulti mounting plate with backplane 8 slots, HV, feed-through mounting, 75 mm ² and 22 mm ² , complete	67
8B0M0120HF00.000-1	ACOPOSmulti mounting plate with backplane 12 slots, HV, feed-through mounting, 75 mm ² and 22 mm ² , complete	67
8B0M0160HF00.000-1	ACOPOSmulti mounting plate with backplane 16 slots, HV, feed-through mounting, 75 mm ² and 22 mm ² , complete	67
8B0M0200HF00.000-1	ACOPOSmulti mounting plate with backplane 20 slots, HV, feed-through mounting, 75 mm ² and 22 mm ² , complete	67

Table 19: Module overview - Mounting plates (feed-through mounting)

3.4 Power supply modules

3.4.1 Wall mounting

Model number	Short description	Page
8B0P0220HW00.000-1	ACOPOSmulti power supply module, passive, 22 A, HV, wall mounting	71
8B0P0440HW00.000-1	ACOPOSmulti power supply module, passive, 44 A, HV, wall mounting	71
8BVP0220HW00.000-1	ACOPOSmulti power supply module 22 A, HV, wall mounting	77
8BVP0440HW00.000-1	ACOPOSmulti power supply module 44 A, HV, wall mounting	77
8BVP0880HW00.000-1	ACOPOSmulti power supply module 88 A, HV, wall mounting	77

Table 20: Module overview - Power supply modules (wall mounting)

3.4.2 Cold plate or feed-through mounting

Model number	Short description	Page
8B0P0220HC00.000-1	ACOPOSmulti power supply module, passive, 22 A, HV, cold plate or feed-through installation	71
8B0P0440HC00.000-1	ACOPOSmulti power supply module, passive, 44 A, HV, cold plate or feed-through installation	71
8BVP0220HC00.000-1	ACOPOSmulti power supply module, 22 A, HV, cold plate or feed-through mounting	77
8BVP0440HC00.000-1	ACOPOSmulti power supply module, 44 A, HV, cold plate or feed-through mounting	77
8BVP0880HC00.000-1	ACOPOSmulti power supply module, 88 A, HV, cold plate or feed-through mounting	77
8BVP1650HC00.000-1	ACOPOSmulti power supply module, 165 A, HV, cold plate or feed-through mounting	85

Table 21: Module overview - Power supply modules (cold-plate or feed-through mounting)

3.5 Control supply units

3.5.1 Wall mounting

Model number	Short description	Page
8B0C0160HW00.000-1	ACOPOSmulti auxiliary supply module 16 A, HV, wall mounting	92
8B0C0160HW00.001-1	ACOPOSmulti auxiliary supply module, 16 A, HV, wall mounting, 24VOut 1x 16 A, 1x 5 A	92
8B0C0160HW00.A01-1	ACOPOSmulti auxiliary supply module, 16 A, HV, wall mounting, 42VOut 1x 16A, 1x 3A	98
8B0C0320HW00.000-1	ACOPOSmulti auxiliary supply module 32 A, HV, wall mounting	98
8B0C0320HW00.002-1	ACOPOSmulti auxiliary supply module, 32 A, HV, wall mounting, 24VOut 1x 32 A, 1x 5 A	98
8B0C0320HW00.00A-1	ACOPOSmulti auxiliary supply module, 32 A, HV, wall mounting, 24VIn 1x 30 A, 24VOut 1x 30 A, 1x 5 A	104

Table 22: Module overview - Auxiliary supply modules (wall mounting)

3.5.2 Cold plate or feed-through mounting

Model number	Short description	Page
8B0C0160HC00.000-1	ACOPOSmulti auxiliary supply module 16 A, HV, cold plate or feed-through mounting	92
8B0C0160HC00.001-1	ACOPOSmulti auxiliary supply module, 16 A, HV, cold-plate or feed-through mounting, 24VOut 1x 16 A, 1x 5 A	92
8B0C0160HC00.A01-1	ACOPOSmulti auxiliary supply module, 16 A, HV, cold-plate or feed-through mounting, 42VOut 1x 16A, 1x 3A	98
8B0C0320HC00.000-1	ACOPOSmulti auxiliary supply module 32 A, HV, cold plate or feed-through mounting	98
8B0C0320HC00.002-1	ACOPOSmulti auxiliary supply module, 32 A, HV, cold-plate or feed-through mounting, 24VOut 1x 32 A, 1x 5 A	98
8B0C0320HC00.00A-1	ACOPOSmulti auxiliary supply module, 32 A, HV, cold-plate or feed-through mounting, 24VIn 1x 30 A, 24VOut 1x 30 A, 1x5 A	104

Table 23: Module overview - Auxiliary supply modules (cold-plate or feed-through mounting)

3.6 Inverter modules

3.6.1 Single-axis modules

Wall mounting

Model number	Short description	Page
8BVI0014HWS0.000-1	ACOPOSmulti inverter module, 1.9 A, HV, wall-mounting	110
8BVI0028HWS0.000-1	ACOPOSmulti inverter module, 3.8 A, HV, wall-mounting	110
8BVI0055HWS0.000-1	ACOPOSmulti inverter module, 7.6 A, HV, wall-mounting	110
8BVI0110HWS0.000-1	ACOPOSmulti inverter module, 15.1 A, HV, wall-mounting	110
8BVI0220HWS0.000-1	ACOPOSmulti inverter module, 22 A, HV, wall-mounting	126
8BVI0330HWS0.000-1	ACOPOSmulti inverter module, 33 A, HV, wall-mounting	126
8BVI0440HWS0.000-1	ACOPOSmulti inverter module, 44 A, HV, wall-mounting	126
8BVI0880HWS0.000-1	ACOPOSmulti inverter module, 88 A, HV, wall-mounting	142

Table 24: Module overview - Single-axis modules, single-width (wall mounting)

Cold plate or feed-through mounting

Model number	Short description	Page
8BVI0014HCS0.000-1	ACOPOSmulti inverter module, 1.9 A, HV, cold plate or feed-through mounting	110
8BVI0028HCS0.000-1	ACOPOSmulti inverter module, 3.8 A, HV, cold plate or feed-through mounting	110
8BVI0055HCS0.000-1	ACOPOSmulti inverter module, 7.6 A, HV, cold plate or feed-through mounting	110
8BVI0110HCS0.000-1	ACOPOSmulti inverter module, 15.1 A, HV, cold plate or feed-through mounting	110
8BVI0220HCS0.000-1	ACOPOSmulti inverter module, 22 A, HV, cold plate or feed-through mounting	126
8BVI0330HCS0.000-1	ACOPOSmulti inverter module, 33 A, HV, cold plate or feed-through mounting	126
8BVI0440HCS0.000-1	ACOPOSmulti inverter module, 44 A, HV, cold plate or feed-through mounting	126
8BVI0880HCS0.000-1	ACOPOSmulti inverter module, 88 A, HV, cold plate or feed-through mounting	142
8BVI1650HCS0.000-1	ACOPOSmulti inverter module, 165 A, HV, cold plate or feed-through mounting	150

Table 25: Module overview - Single-axis modules, single-width (cold-plate or feed-through mounting)

3.6.2 Two-axis modules

Wall mounting

Model number	Short description	Page
8BVI0014HWD0.000-1	ACOPOSMulti inverter module 1.9 A, HV, wall mounting, 2 axes	118
8BVI0028HWD0.000-1	ACOPOSMulti inverter module 3.8 A, HV, wall mounting, 2 axes	118
8BVI0055HWD0.000-1	ACOPOSMulti inverter module 7.6 A, HV, wall mounting, 2 axes	118
8BVI0110HWD0.000-1	ACOPOSMulti inverter module 15.1 A, HV, wall mounting, 2 axes	134
8BVI0220HWD0.000-1	ACOPOSMulti inverter module 22 A, HV, wall mounting, 2 axes	134

Table 26: Module overview - Two-axis modules, double-width (wall mounting)

Cold plate or feed-through mounting

Model number	Short description	Page
8BVI0014HCD0.000-1	ACOPOSMulti inverter module 1.9 A, HV, cold plate or feed-through mounting, 2 axes	118
8BVI0028HCD0.000-1	ACOPOSMulti inverter module 3.8 A, HV, cold plate or feed-through mounting, 2 axes	118
8BVI0055HCD0.000-1	ACOPOSMulti inverter module 7.6 A, HV, cold plate or feed-through mounting, 2 axes	118
8BVI0110HCD0.000-1	ACOPOSMulti inverter module 15.1 A, HV, cold plate or feed-through mounting, 2 axes	134
8BVI0220HCD0.000-1	ACOPOSMulti inverter module 22 A, HV, cold plate or feed-through mounting, 2 axes	134

Table 27: Module overview - Two-axis modules, double-width (cold-plate or feed-through mounting)

3.7 Expansion modules

3.7.1 Wall mounting

Model number	Short description	Page
8BVE0500HW00.000-1	ACOPOSMulti expansion module 50 A, HV, wall-mounting	158

Table 28: Module overview - Expansion modules (wall mounting)

3.7.2 Cold plate or feed-through mounting

Model number	Short description	Page
8BVE0500HC00.000-1	ACOPOSMulti expansion module 50 A, HV, cold plate or feed-through mounting	158

Table 29: Module overview - Expansion modules (cold-plate or feed-through mounting)

3.8 Capacitor modules

3.8.1 Wall mounting

Model number	Short description	Page
8B0K1650HW00.000-1	ACOPOSmulti capacitor module 1650 μ F, HV, wall-mounting	164

Table 30: Module overview - Capacitor modules (wall mounting)

3.8.2 Cold plate or feed-through mounting

Model number	Short description	Page
8B0K1650HC00.000-1	ACOPOSmulti capacitor module 1650 μ F, HV, cold plate or feed-through mounting	164

Table 31: Module overview - Capacitor modules (cold-plate or feed-through mounting)

3.9 Plug-in modules

3.9.1 Encoder modules

Model number	Short description	Page
8BAC0120.000-1	ACOPOSmulti plug-in module, EnDat 2.1 interface	166
8BAC0120.001-2	ACOPOSmulti plug-in module, EnDat 2.2 interface	170
8BAC0121.000-1	ACOPOSmulti plug-in module, HIPERFACE interface	174
8BAC0122.000-1	ACOPOSmulti plug-in module, resolver interface 10 kHz	178
8BAC0123.000-1	ACOPOSmulti plug-in module, incremental encoder and SSI absolute encoder interface for RS422 signals	182
8BAC0123.001-1	ACOPOSmulti plug-in module, incremental encoder interface for 5 V single-ended and 5 V differential signals	188
8BAC0123.002-1	ACOPOSmulti plug-in module, incremental encoder interface for 24 V single-ended and 24 V differential signals	193
8BAC0124.000-1	ACOPOSmulti plug-in module, SinCos interface	198

Table 32: Module overview - Encoder modules

3.9.2 IO modules

Model number	Short description	Page
8BAC0130.000-1	ACOPOSmulti plug-in module, 2 digital outputs, 50 mA, max. 62.5 kHz, 2 digital outputs, 500 mA, max. 1.25 kHz, 2 digital inputs 24 VDC	202
8BAC0130.001-1	ACOPOSmulti plug-in module, 2 digital outputs, 50 mA, max. 62.5 kHz, 4 digital outputs, 500 mA, max. 1.25 kHz	206
8BAC0132.000-1	ACOPOSmulti input module, 4 analog inputs \pm 10 V	209

Table 33: Module overview - IO modules

4. 8B0F passive line filters

4.1 Order data


Model number	Short description	Figure
	Line filter	
8B0F0300H000.000-1	ACOPOSmulti passive line filter, 30 A, 3 x 520/300 VAC, 50/60 Hz, IP20	 <p>8B0F0300H000.000-1</p>
8BVF0550H000.000-1	ACOPOSmulti passive line filter, 55 A, 3 x 520/300 VAC, 50/60 Hz, IP20	

Table 34: Order data - 8B0F passive line filters

4.2 Technical data

Product ID	8B0F0300H000.000-1	8B0F0550H000.000-1
General information		
C-UL-US listed	Yes	
Cooling and mounting methods	Wall mounting	
Power mains connection		
Mains input voltage	3 x 300 to 3 x 520 VAC	
Frequency	0 to 60 Hz	
Allocation to the power supply module 8BOP	22 kW	44 kW
Continuous current ¹⁾	30 A _{eff}	55 A _{eff}
Peak current	45 A _{eff} (< 1 min)	82.5 A _{eff} (< 1 min)
Reduction of continuous current according to the ambient temperature above 50°C	In preparation	
Power loss ²⁾	11.8 W	25.9 W
Line filter according to EN61800-3-A11, category 3 ³⁾	Yes	
Design L1, L2, L3 and L1', L2', L3' PE Shield connection on the mains on the device	Terminals M5 threaded bolt No No	Terminals M6 threaded bolt No No
Terminal connection cross section Flexible and fine wire lines with wire tip sleeves Approval data UL/cULus CSA	Max. 10 mm ² 8 8	Max. 16 mm ² 4 4
Operational conditions		
Permitted mounting orientations Hanging vertically Lying horizontally Standing horizontally	Yes Yes No	
Ambient temperature during operation Max. ambient temperature ⁴⁾	5 to 40°C +55°C	
Relative humidity during operation	5 to 85%, non-condensing	
Installation at altitudes above sea level Maximum installation altitude ⁵⁾	0 to 1,000 m 4,000 m	
Degree of pollution according to EN 60664-1	In preparation	
Overvoltage cat. according to IEC 60950	II	
EN 60529 protection	IP20	

Table 35: Technical data - 8B0F passive line filters

Technical data • 8B0F passive line filters


Product ID	8B0F0300H000.000-1	8B0F0550H000.000-1
Storage and transport conditions		
Storage temperature	-25 to +55°C	
Relative humidity during storage	5 to 95%, non-condensing	
Transport temperature	-25 to +70°C	
Relative humidity during transport	Max. 95% at +40°C	
Mechanical characteristics		
Dimensions		
Width	50 mm	85 mm
Height	270 mm	250 mm
Depth	85 mm	90 mm
Weight	1.2 kg	2 kg

Table 35: Technical data - 8B0F passive line filters (cont.)

- 1) Valid in the following conditions: 3 x 480 VAC mains input voltage, 50°C ambient temperature, $\cos \phi = 0.8$.
The exact value depends on the respective application.
- 2) Valid in the following conditions: 25°C ambient temperature, frequency 50 Hz.
- 3) Limit values from CISPR11, group 2, class A (second environment). To avoid exceeding the EMC limit values, the total length of all motor cables for each mounting plate (and therefore each line filter) should be limited to a maximum of 900 m. The cable length between the line filter and the power supply module is limited to a maximum of 5 m.
The maximum motor cable length per motor connection is also limited (see inverter modules).
- 4) Continuous operation at ambient temperatures ranging from 40°C to max. 55°C is possible (taking the continuous current reductions listed into consideration), but results in a shorter lifespan.
- 5) Continuous operation at altitudes ranging from 1000 m to 4,000 m above sea level is possible (taking the continuous current reductions listed into consideration). Additional requirements are to be arranged with B&R.

5. 8BVF line filter

5.1 Order data

Model number	Short description	Figure
	Line filter	
8BVF0220H000.000-1	ACOPOSMulti line filter, 22.5 A, 480 V	
8BVF0440H000.001-2	ACOPOSMulti line filter 45 A, 480 V, increased peak current load capacity	
8BVF0880H000.000-1	ACOPOSMulti line filter, 90 A, 480 V	

8BVF0440H000.001-2

Table 36: Order data - 8BVF line filter

Required accessories				
Model number	Amount	Short description	Comment	Page
8BZVF044000.001-2A ¹⁾	1	Screw clamp set for ACOPOSMulti Modules 8BVF0220H000.000-1 and 8BVF0440H000.001-2: 1x 8TB4104.202N-10, 1x 8TB4104.206D-10, 1x 8TB2104.204A-00	---	---
8BZVF088000.000-1A	1	Screw clamp set for ACOPOSMulti Modules 8BVF0880H000.000-1: 1x 8TB2104.204A-00	---	---

Table 37: Required accessory - 8BVF line filters

1) Only for 8BVF0220H000.000-1 and 8BVF0440H000.001-2.

Optional accessories				
Model number	Amount	Short description	Comment	Page
8TB4104.202N-10 ¹⁾	1	Screw clamp, 4-pin, single-row, spacing: 10.16 mm, Label 2: L1 L2 L3 PE, Coding N: 1100	Plug for X1 connection	---

Table 38: Optional accessory - 8BVF line filters

Optional accessories				
Model number	Amount	Short description	Comment	Page
8TB4104.206D-10 ¹⁾	1	Screw clamp, 4-pin, single-row, spacing: 10.16 mm, Label 6: L1' L2' L3' PE, D coding: 0011	Plug for X2 connection	---
8TB2104.204A-00	1	Screw clamp, 4-pin, single-row, spacing: 5.08 mm, Label 4: T- T+ F- F+, Coding A: 0000	Plug for X3 connection	---

Table 38: Optional accessory - 8BVF line filters (cont.)

1) Only for 8BVF0220H000.000-1 and 8BVF0440H000.001-2.

5.2 Technical data

Product ID	8BVF0220H000.000-1	8BVF0440H000.001-2	8BVF0880H000.000-1
General information			
C-UL-US listed	Yes		
Cooling and mounting methods	Wall mounting		
Power mains connection			
Mains input voltage	3 x 220 to 3 x 480 VAC ±10%		
Frequency	50 / 60 Hz ±4%		
Allocation to the power supply module	15 kW	30 kW	60 kW
Continuous current ¹⁾	22.5 A _{eff}	45 A _{eff}	90 A _{eff}
Peak current < 10 s	56 A _{eff}	180 A _{eff}	180 A _{eff}
Reduction of continuous current depending on ambient temperature	No reduction	0.4 A _{eff} per °C starting at 40°C	1 A _{eff} per °C starting at 40°C
Power loss at rated current	140 W	250 W	470 W
Line filter according to EN61800-3-A11, category 3 ²⁾	Yes		
Design L1, L2, L3, PE and L1', L2', L3', PE PE Shield connection on the mains on the device	Plugs M5 threaded bolt No Yes ³⁾	Plugs M5 threaded bolt No Yes ³⁾	Feed-through terminals No No Yes ³⁾
Terminal connection cross section Flexible and fine wire lines with wire tip sleeves UL/cULus CSA	0.5 - 16 mm ² 20 - 6 20 - 6		10- 50 mm ² 6-1/0 6-1/0
Terminal outer cross-section dimension of the shield connection	12 - 22 mm	23 - 35 mm	32 - 50 mm

Table 39: Technical data - 8BVF line filters

Technical data • 8BVF line filter

Product ID	8BVF0220H000.000-1	8BVF0440H000.001-2	8BVF0880H000.000-1
Temperature sensor			
Temperature sensor type	EPCOS B59100M1155A070		
Design T+, T-	Plugs		
Terminal connection cross section Flexible and fine wire lines with wire tip sleeves	0.25 - 2.5 mm ²		
UL/cULus	30 - 12		
CSA	28 - 12		
Fan connection			
Max. power consumption during operation (P _{Fan8BVF...})	8.25 W		
Design F+, F-	Plugs		
Terminal connection cross section Flexible and fine wire lines with wire tip sleeves	0.25 - 2.5 mm ²		
UL/cULus	30 - 12		
CSA	28 - 12		
Operational conditions			
Permitted mounting orientations			
Hanging vertically	Yes		
Lying horizontally	Yes		
Standing horizontally	No		
Ambient temperature during operation Max. ambient temperature ⁴⁾	5 to 40°C +55°C		
Relative humidity during operation	5 to 85%, non-condensing		
Installation at altitudes above sea level Maximum installation altitude ⁵⁾	0 to 500 m 4,000 m		
Degree of pollution according to EN 60664-1	2 (non-conductive material)		
Overvoltage cat. according to IEC 60364-4-443:1999	III		
EN 60529 protection	IP20		
Storage and transport conditions			
Storage temperature	-25 to +55°C		
Relative humidity during storage	5 to 95%, non-condensing		
Transport temperature	-25 to +70°C		
Relative humidity during transport	Max. 95% at +40°C		

Table 39: Technical data - 8BVF line filters (cont.)

Product ID	8BVF0220H000.000-1	8BVF0440H000.001-2	8BVF0880H000.000-1
Mechanical characteristics			
Dimensions			
Width		135 mm	175 mm
Height		378 mm	436 mm
Depth		212 mm	212 mm
Weight	11.6 kg	15 kg	23.5 kg

Table 39: Technical data - 8BVF line filters (cont.)

- 1) Valid in the following conditions: 40°C ambient temperature, installation altitude < 500 m above sea level.
- 2) Limit values from CISPR11, group 2, class A (second environment). To avoid exceeding the EMC limit values, the total length of all motor cables for each mounting plate (and therefore each line filter) should be limited to a maximum of 900 m. The cable length between the line filter and the power supply module is limited to a maximum of 5 m. The maximum motor cable length per motor connection is also limited (see inverter modules).
- 3) The cable does not require shielding up to a total cable length between the line filter, regeneration choke and power supply module of 3 m. Please contact B&R when using cable lengths > 3 m.
- 4) Continuous operation at ambient temperatures ranging from 40°C to max. 55°C is possible (taking the continuous current reductions listed into consideration), but results in a shorter lifespan.
- 5) Continuous operation at altitudes ranging from 500 m to 4,000 m above sea level is possible (taking the continuous current reductions listed into consideration). Additional requirements are to be arranged with B&R.

6. 8BVR regeneration chokes

6.1 Order data

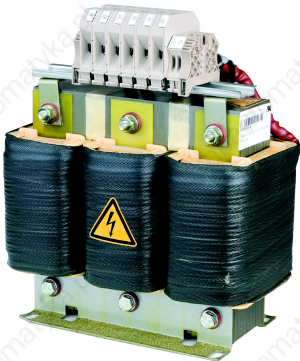
Model number	Short description	Figure
	Regeneration choke	 <p>8BVR0440H000.100-1</p>
8BVR0220H000.100-1	ACOPOSMulti regeneration choke 22.5 A, 480 V, connection terminals	
8BVR0440H000.100-1	ACOPOSMulti regeneration choke 45 A, 480 V, connection terminals	
8BVR0880H000.100-1	ACOPOSMulti regeneration choke 90 A, 480 V, connection terminals	

Table 40: Order data - 8BVR regeneration chokes

6.2 Technical data

Product ID	8BVR0220H000.100-1	8BVR0440H000.100-1	8BVR0880H000.100-1
General information			
C-UL-US listed	Yes		Yes ^{1) 2)}
Cooling and mounting methods	Wall mounting		
Power mains connection			
Mains input voltage	3 x 220 to 3 x 480 VAC ±10%		
Frequency	50 / 60 Hz ±4%		
Allocation to the power supply module	15 kW	30 kW	60 kW
Continuous current ³⁾	22.5 A _{eff}	45 A _{eff}	90 A _{eff}
Peak current < 10 s	56 A _{eff}	90 A _{eff}	180 A _{eff}
Reduction of continuous current depending on ambient temperature	---		0.6 A _{eff} per °C starting at 10°C
Horizontal mounting orientation	---		1 A _{eff} per °C starting at 40°C
Vertical mounting orientation	No reduction	0.4 A _{eff} per °C starting at 40°C	
Power loss at rated current	190 W	330 W	470 W
Design U1, V1, W1 U2, V2, W2 Shield connection ⁴⁾ on the mains on the device	Terminals Terminals No No		
Terminal connection cross section Flexible and fine wire lines with wire tip sleeves	1.5 - 16 mm ²		2.5 - 35 mm ²
UL/cULus	18 - 4		12 - 1
CSA	18 - 4		12 - 2
Terminal outer cross-section dimension of the shield connection	---		
Temperature sensor			
Temperature sensor type	EPCOS B59100M1155A070		
Design T+, T-	Terminals		
Terminal connection cross section Flexible and fine wire lines with wire tip sleeves	0.5 - 2.5 mm ²		
UL/cULus	30 - 12		
CSA	26 - 12		

Table 41: Technical data - 8BVR regeneration chokes

Technical data • 8BVR regeneration chokes

Product ID	8BVR0220H000.100-1	8BVR0440H000.100-1	8BVR0880H000.100-1
Operational conditions			
Permitted mounting orientations Hanging vertically Lying horizontally Standing horizontally	No No Yes	No Yes ¹⁾ Yes ²⁾	No Yes ¹⁾ Yes ²⁾
Ambient temperature during operation Max. ambient temperature ⁵⁾	5 to 40°C +55°C		
Relative humidity during operation	5 to 85%, non-condensing		
Installation at altitudes above sea level Maximum installation altitude ⁶⁾	0 to 500 m 4,000 m		
Degree of pollution according to EN 60664-1	2 (non-conductive material)		
Overvoltage cat. according to IEC 60364-4-443:1999	III		
EN 60529 protection	IP00		
Storage and transport conditions			
Storage temperature	-25 to +55°C		
Relative humidity during storage	5 to 95%, non-condensing		
Transport temperature	-25 to +70°C		
Relative humidity during transport	Max. 95% at +40°C		
Mechanical characteristics			
Dimensions			
Width	245 mm	251 mm	293 mm
Height	270 mm	285 mm	412 mm
Depth	103 mm	146 mm	165 mm
Weight	10.5 kg	24.1 kg	40.2 kg

Table 41: Technical data - 8BVR regeneration chokes (cont.)

- 1) The C-UL-US listing is only valid for the mounting orientation "lying horizontally".
- 2) A C-UL-US listing can be achieved for "standing horizontally" as follows:
The cabling of the regeneration choke must have lines with a temperature rating of at least 105°C. In addition, the switching cabinet must be tested and approved by UL.
- 3) Valid in the following conditions: Mounting orientation "standing horizontally", 40°C ambient temperature, installation altitude < 500 m above sea level.
- 4) The cable does not require shielding up to a total cable length between the line filter, regeneration choke and power supply module of 3 m. Please contact B&R when using cable lengths > 3 m.
- 5) Continuous operation at ambient temperatures ranging from 40°C to max. 55°C is possible (taking the continuous current reductions listed into consideration), but results in a shorter lifespan.
- 6) Continuous operation at altitudes ranging from 500 m to 4,000 m above sea level is possible (taking the continuous current reductions listed into consideration). Additional requirements are to be arranged with B&R.

7. 8B0M mounting plates

7.1 Order data




Model number ¹⁾	Short description	Figure
	Wall mounting	
8B0MnnnnHW00.000-1 ²⁾	ACOPOSMulti mounting plate with backplane nnnn slots, HV, wall mounting, 75 mm ² and 22 mm ² , complete	 <p>8B0M0060HW00.000-1</p>  <p>8B0M0060HC00.000-1</p>  <p>8B0M0060HF00.000-1</p>
	Cold-plate installation	
8B0MnnnnHC00.000-1 ²⁾	ACOPOSMulti mounting plate with backplane, nnnn slots, HV, cold plate mounting, 75 mm ² and 22 mm ² , complete	
	Feed-through mounting	
8B0MnnnnHF00.000-1 ³⁾	ACOPOSMulti mounting plate with backplane nnnn slots, HV, feed-through mounting, 75 mm ² and 22 mm ² , complete	

Table 42: Order data - 8B0M mounting plates

- 1) The desired number of slots must be specified in the model number by nnnn (0160 equals 16 slots).
- 2) Only mounting plates with 4 or more slots are possible.
- 3) The number of slots must be a multiple of 4.

Technical data • 8B0M mounting plates

Optional accessories				
Model number	Amount	Short description	Comment	Page
8B0M0040HFF0.000-1 ¹⁾	Up to 5	ACOPOSmulti fan module for mounting plate, 4 slots, HV, feed-through mounting	One fan module is required for every 4 slots	---
8BXF002.0000-00 ²⁾	---	ACOPOSmulti fan module, replacement fan for mounting plate with backplane module, wall mounting (8B0MxxxxHWxx.xxx-x)	Replacement fan for ACOPOSmulti mounting plates 8B0MnnnnHWxx.xxx-x	---
X67CA0P20.xxxx ^{1) 3)}	1	Power attachment cable, xxxx m	24 VDC connection cable for ACOPOSmulti fan modules 8B0M0040HFF0.000-1	---
X67CA0P00.0002 ¹⁾	Up to 4	Power connection cable, 0.2 m	24 VDC connection cable between two ACOPOSmulti fan modules 8B0M0040HFF0.000-1	---

Table 43: Optional accessory - 8B0M mounting plates

1) Only for 8B0MnnnnHF00.xxx-1.

2) Only for 8B0MnnnnHW00.xxx-1.

3) The cable length is specified in decimeters by xxxx (0010 equals a cable length of 1 m).

7.2 Technical data

Product ID ¹⁾	8B0MnnnnHW00.000-1	8B0MnnnnHC00.000-1	8B0MnnnnHF00.000-1
General information			
C-UL-US listed	---		
Cooling and mounting methods	Wall mounting	Cold-plate installation	Feed-through mounting
Number of slots nnnn			
Min.	4	4	4 ²⁾
Max.	27	27	20
DC bus			
Voltage	750VDC		
Max.	900 VDC		
Continuous power ³⁾	200 kW		
Reduction of continuous power according to ambient temperature above 40°C	In preparation	In preparation	In preparation
Reduction of continuous power depending on installation altitude Starting at 500 m above sea level	20 kW per 1,000 m		
Cross section			
DC+, DC-	72 mm ²		
PE	72 mm ²		

Table 44: Technical data - 8B0M mounting plates

Technical data • 8B0M mounting plates

Product ID ¹⁾	8B0MnnnnHW00.000-1	8B0MnnnnHC00.000-1	8B0MnnnnHF00.000-1
24 VDC auxiliary supply			
Voltage	25 VDC ±1.6%		
Continuous power ³⁾	1,500 W		
Max. power consumption per slot (P _{Fan8B0M...})	8.25 W ⁴⁾	---	8.25 W ⁵⁾
Reduction of continuous power according to ambient temperature above 40°C	In preparation	In preparation	In preparation
Reduction of continuous power depending on installation altitude Starting at 500 m above sea level	150 W per 1,000 m		
Cross section 24 VDC, COM	21.3 mm ²		
Operational conditions			
Permitted mounting orientations Hanging vertically Lying horizontally Standing horizontally	Yes Yes No		
Ambient temperature during operation Max. ambient temperature ⁶⁾	5 to 40°C +55°C		
Relative humidity during operation	5 to 85%, non-condensing		
Installation at altitudes above sea level Maximum installation altitude ⁷⁾	0 to 500 m 4,000 m		
Degree of pollution according to EN 60664-1	2 (non-conductive material)		
Overvoltage cat. according to IEC 60364-4-443:1999	III		
EN 60529 protection	IP20		IP64 Fan module IP54 (8B0M0040HFF0.000-1)
Smoothness of the mounting surface	Smoothness of 1 mm over the entire mounting surface		---
Flow volume minimum Maximum	--- ---	3 l/min 6 l/min	--- ---
Pressure drop depending on the flow volume 3 l/min 6 l/min	--- ---	typically 0.3 bar ⁸⁾ typically 0.7 bar ⁸⁾	--- ---
Test pressure	---	10 bar for 1 minute, air inside, water outside	---
Maximum continual pressure ⁹⁾	---	4 bar	---
Maximum return temperature	---	60°C	---
Storage and transport conditions			
Storage temperature	-25 to +55°C		
Relative humidity during storage	5 to 95%, non-condensing		
Transport temperature	-25 to +70°C		
Relative humidity during transport	Max. 95% at +40°C		

Table 44: Technical data - 8B0M mounting plates (cont.)

Technical data • 8B0M mounting plates

Product ID ¹⁾	8B0MnnnnHW00.000-1	8B0MnnnnHC00.000-1	8B0MnnnnHF00.000-1
Mechanical characteristics			
Dimensions ¹⁰⁾			
Width	(number of slots * 53.5) mm	(94 + (number of slots -1) * 53.5) mm	(64 + number of slots * 53.5) mm
Height	385 mm	378 mm	378 mm
Depth	13.5 mm	17 mm	14 mm
Weight	(0.53 * number of slots) kg	(0.94 * number of slots) kg	(1.6 * number of slots) kg

Table 44: Technical data - 8B0M mounting plates (cont.)

- 1) The desired number of slots must be specified in the model number by nnnn (0160 equals 16 slots).
- 2) The number of slots must be a multiple of 4.
- 3) Valid in the following conditions: 40°C ambient temperature, installation altitude < 500 m above sea level.
- 4) Corresponds to the attributable power consumption of the fan modules on the mounting plate.
- 5) Corresponds to the attributable power consumption of the fan module 8B0M0040HFF0.000-1.
- 6) Continuous operation at an ambient temperature ranging from 40 °C to max. 55 °C is possible (taking the continuous power reductions listed into consideration).
- 7) Continuous operation at altitudes ranging from 500 m to 4,000 m above sea level is possible (taking the continuous power reductions listed into consideration). Additional requirements are to be arranged with B&R.
- 8) Valid in the following conditions: Mounting plate with max. 27 slots, cooling medium tap water.
Values vary depending on the cooling medium and/or connection fitting being used!
- 9) The requirements for the entire system (tubing, heat exchangers, re-coiling systems, etc.) and possible application-specific requirements must be met.
- 10) The dimensions include the actual size of the mounting plate. Make sure to leave additional space above and below the mounting plate for mounting, connections and air circulation (see section 4 "Dimension diagrams and installation dimensions", on page 264).

8. 8B0P power supply modules

8.1 Order data


Model number	Short description	Figure
		 <p style="text-align: center;">8B0P0220HW00.000-1</p>
Wall mounting		
8B0P0220HW00.000-1	ACOPOSMulti power supply module, passive, 22 A, HV, wall mounting	
8B0P0440HW00.000-1	ACOPOSMulti power supply module, passive, 44 A, HV, wall mounting	
Cold plate or feed-through mounting		
8B0P0220HC00.000-1	ACOPOSMulti power supply module, passive, 22 A, HV, cold plate or feed-through installation	
8B0P0440HC00.000-1	ACOPOSMulti power supply module, passive, 44 A, HV, cold plate or feed-through installation	

Table 45: Order data - 8B0P power supply modules

Required accessories				
Model number	Amount	Short description	Comment	Page
8BZ0P044000.000-1A	1	Screw clamp set for ACOPOSMulti 8B0P0xx0Hx00.00x-1 modules: 1x 8TB4104.202L-10, 1x 8TB4103.202A-00, 1x 8TB2106.2010-00	---	---

Table 46: Required accessories - 8B0P power supply modules

Optional accessories				
Model number	Amount	Short description	Comment	Page
8TB2106.2010-00	1	Screw clamp, 6-pin, single-row, spacing: 5.08 mm, Label 1: numbered serially	Plug for X1 connection	---
8TB4104.202L-10	1	Screw clamp, 4-pin, single-row, spacing: 10.16 mm, Label 2: L1 L2 L3 PE, Coding L: 1010	Plug for X5A connection	---
8TB4103.202A-00	1	Screw clamp, 3-pin, single-row, spacing: 10.16 mm, Label 2: PE RB- RB+, Coding A: 000	Plug for X5B connection	---
8SCS002.0000-00	1	ACOPOSMulti shield component set: 1 clamping plate; 2 clamps D 4-13.5 mm; 4 screws	Shield component set for I/O cable with a cable diameter of 4 - 13.5 mm	---

Table 47: Optional accessories - 8B0P power supply modules

Technical data • 8B0P power supply modules

Optional accessories				
Model number	Amount	Short description	Comment	Page
8SCS007.0000-00	1	ACOPOSmulti shield component set: 1 shield mounting plate, 2x, 45°; 4 screws	Base plate for mounting shield component set 8SCS008.0000-00	---
8SCS008.0000-00	1	ACOPOSmulti shield component set: 1 shield plate, 2x, type 0; 1 hose clamp, W 9 mm, D 23-35 mm	Shield component set for power cables with a diameter of 23 - 35 mm	---
8BXF001.0000-00	1	ACOPOSmulti fan module Replacement fan for ACOPOSmulti modules (8BxP/8B0C/8BVI/8BVE/8B0K)	Replacement fan for ACOPOSmulti modules (8BxP/8B0C/8BVI/8BVE/8B0K)	---

Table 47: Optional accessories - 8B0P power supply modules (cont.)

8.2 Technical data

Product ID		
Wall mounting Cold plate or feed-through mounting	8B0P0220HW00.000-1 8B0P0220HC00.000-1	8B0P0440HW00.000-1 8B0P0440HC00.000-1
General information		
C-UL-US listed	Yes	
Available cooling and mounting methods		
Wall mounting	Yes	
Cold plate or feed-through mounting	Yes	
Module width	2	
Power mains connection		
Mains input voltage	3 x 380 to 3 x 500 VAC ±10%	
System configuration	TT, TN-S, TN-C-S	
Frequency	50 / 60 Hz ±4%	
Installed load	Max. 15.6 kVA	Max. 30.4 kVA
Power loss with continuous power	In preparation	In preparation
Starting current at 400 VAC	10 A	
Switch-on interval	> 120 s	
Max. chargeable DC bus capacitance	4 mF	
Integrated line filter according to EN61800-3-A11, category 3 ¹⁾	No	
Integrated regeneration choke	No	
Capable of regeneration	No	
Power Factor Control (PFC)	No	
Design		
L1, L2, L3, PE	Plugs	
PE	M5 threaded bolt	
Shield connection	Yes ²⁾	

Table 48: Technical data - 8B0P power supply modules

Technical data • 8B0P power supply modules

Product ID	8B0P0220HW00.000-1 8B0P0220HC00.000-1	8B0P0440HW00.000-1 8B0P0440HC00.000-1
Terminal connection cross sections Flexible and fine wire lines with wire tip sleeves Approval data UL/C-UL-US CSA	0.5 - 16 mm ² 20 - 6 20 - 6	
Terminal cable outer-cross-section dimension of the shield connection	23 - 35 mm	
DC bus connection		
Voltage Max.	537 to 707 VDC 900 VDC	
Continuous power ³⁾	8 kW	16 kW
Reduction of continuous power depending on mains input voltage Mains input voltage < 3 x 400VAC	20 W/V * (400 V - mains input voltage)	40 W/V * (400 V - mains input voltage)
Reduction of continuous power depending on cooling method	In preparation	In preparation
Reduction of continuous power depending on installation altitude Starting at 500 m above sea level	0.8 kW per 1,000 m	1.6 kW per 1,000 m
Peak power output (feed)	24 kW	48 kW
Power loss with continuous power	In preparation	In preparation
DC bus capacitance	660 µF	1320 µF
Protective measures Overload protection Short circuit and ground fault	Yes No	
Design	ACOPOSMulti backplane	

Table 48: Technical data - 8B0P power supply modules (cont.)

Technical data • 8B0P power supply modules

Product ID	8B0P0220HW00.000-1 8B0P0220HC00.000-1	8B0P0440HW00.000-1 8B0P0440HC00.000-1
Wall mounting Cold plate or feed-through mounting		
Braking resistor connection ⁴⁾		
Peak power output	40 kW (max. 1 s)	65 kW (max. 1 s)
Continuous power	3 kW	
Minimum permitted braking resistance	12 Ω	7.5 Ω
Rated current of the built-in fuse ⁵⁾	30 A (fast-acting)	
Design RB+, RB-, PE Shield connection	Plugs Yes	
Terminal connection cross sections Flexible and fine wire lines with wire tip sleeves Approbation data UL/C-UL-US CSA	0.5 - 16 mm ² 20 - 6 20 - 6	
Terminal cable outer-cross-section dimension of the shield connection	23 - 35 mm	
Protective measures Overload protection Short circuit and ground fault	Yes Yes (with RB+ through externally exchangeable blow-out fuse)	
24 VDC supply ⁶⁾		
Input voltage	25 VDC ±1.6%	
Input capacitance	In preparation	
Max. power consumption	In preparation	
Design	ACOPOSmulti backplane	
Operational conditions		
Permitted mounting orientations Hanging vertically Lying horizontally Standing horizontally	Yes Yes No	
Ambient temperature during operation Max. ambient temperature ⁷⁾	5 to 40°C +55°C	
Relative humidity during operation	5 to 85%, non-condensing	
Installation at altitudes above sea level Maximum installation altitude ⁸⁾	0 to 500 m 4,000 m	
Degree of pollution according to EN 60664-1	2 (non-conductive material)	
Overvoltage cat. according to IEC 60364-4-443:1999	III	
EN 60529 protection	IP20	

Table 48: Technical data - 8B0P power supply modules (cont.)

Technical data • 8B0P power supply modules

Product ID		
Wall mounting Cold plate or feed-through mounting	8B0P0220HW00.000-1 8B0P0220HC00.000-1	8B0P0440HW00.000-1 8B0P0440HC00.000-1
Storage and transport conditions		
Storage temperature	-25 to +55°C	
Relative humidity during storage	5 to 95%, non-condensing	
Transport temperature	-25 to +70°C	
Relative humidity during transport	Max. 95% at +40°C	
Mechanical characteristics		
Dimensions ⁹⁾		
Width	106.5 mm	
Height	317 mm	
Depth		
Wall mounting	263 mm	
Cold-plate	212 mm	
Feed-through mounting	209 mm	
Weight		
Wall mounting	Approx. 5.9 kg	Approx. 6.1 kg
Cold-plate	Approx. 4.7 kg	Approx. 4.9 kg
Feed-through mounting	Approx. 4.7 kg	Approx. 4.9 kg

Table 48: Technical data - 8B0P power supply modules (cont.)

- 1) Limit values from CISPR11, group 2, class A (second environment).
- 2) The cable does not require shielding up to a total cable length of 3 m between the line filter and power supply module. Please contact B&R when using cable lengths > 3 m.
- 3) Valid in the following conditions: Mains input voltage 3 x 400 VAC, switching frequency 5 kHz, 40°C ambient temperature, installation altitudes < 500 m above sea level, no derating dependent on cooling type.
- 4) The power calculations are based on a DC bus voltage of 700 VDC.

Danger!

A component malfunction in the passive power supply module 8B0P can lead to a continuous power output on the external braking resistor and cause it to overheat. This must be considered when selecting (e.g. intrinsic safety), organizing and operating the external braking resistor. Thermal monitoring and external turn-off devices should be implemented if necessary.

If B&R 8B0W braking resistors are used and the 8B0P power supply module is operated with a mains voltage of 3 x 380 to 3 x 500 VAC ±10%, there is no need for thermal monitoring since B&R 8B0W braking resistors are intrinsically safe under these conditions.

- 5) A Littelfuse KLK D 030 fuse must be used.
- 6) In the power supply modules a DC bus power supply is integrated for the electronic supply. The 24 VDC supply from the ACOPOSmulti backplane only feeds the +24 VDC of the trigger inputs and the encoder power supplies on the encoder modules.
- 7) Continuous operation at ambient temperatures ranging from 40°C to max. 55°C is possible (taking the continuous current reductions listed into consideration), but results in a shorter lifespan.
- 8) Continuous operation at altitudes ranging from 500 m to 4,000 m above sea level is possible (taking the continuous current reductions listed into consideration). Additional requirements are to be arranged with B&R.
- 9) The dimensions refer to the true device dimensions including the respective mounting plate. Make sure to leave additional space above and below the device for mounting, connections and air circulation (see section 4 "Dimension diagrams and installation dimensions", on page 264).

8.2.1 POWERLINK station number settings

The POWERLINK station number can be set using two HEX code switches that are located behind the black cover of the module:

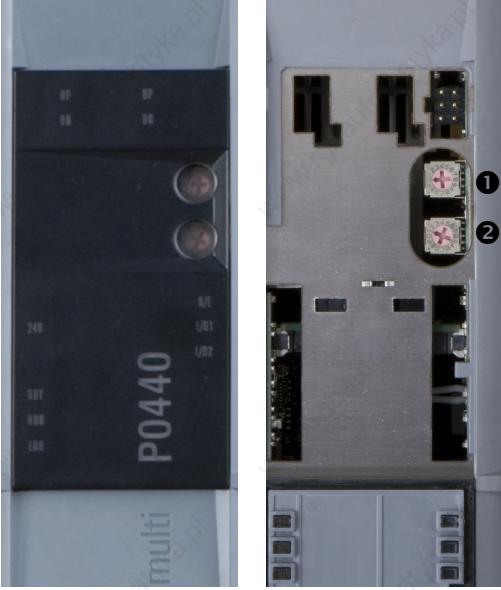
Figure	Code switch	POWERLINK station number
 <p data-bbox="211 922 302 943">Cover closed</p> <p data-bbox="481 922 572 943">Cover open</p>	❶	16s position (high)
	❷	1s position (low)
<p data-bbox="665 370 1128 407">The POWERLINK station number change takes effect the next time the ACOPOSmulti drive system is switched on.</p> <p data-bbox="665 423 795 451">Information:</p> <p data-bbox="665 464 1128 505">In principle, station numbers between \$01 and \$FD are permitted.</p> <p data-bbox="665 508 1128 570">However, station numbers between \$F0 and \$FD are reserved for future system expansions. For reasons of compatibility, we recommend avoiding these station numbers.</p> <p data-bbox="665 581 1128 621">Station numbers \$00, \$FE and \$FF are reserved and are therefore not allowed to be set.</p>		

Table 49: Setting the POWERLINK station number

9. 8BVP power supply modules

9.1 Order data


Model number	Short description	Figure
	Wall mounting	
8BVP0220HW00.000-1	ACOPOS multi power supply module 22 A, HV, wall mounting	 <p>8BVP0440HC00.000-1</p> <p>8BVP0880HC00.000-1</p>
8BVP0440HW00.000-1	ACOPOS multi power supply module 44 A, HV, wall mounting	
8BVP0880HW00.000-1	ACOPOS multi power supply module 88 A, HV, wall mounting	
	Cold plate or feed-through mounting	
8BVP0220HC00.000-1	ACOPOS multi power supply module, 22 A, HV, cold plate or feed-through mounting	
8BVP0440HC00.000-1	ACOPOS multi power supply module, 44 A, HV, cold plate or feed-through mounting	
8BVP0880HC00.000-1	ACOPOS multi power supply module, 88 A, HV, cold plate or feed-through mounting	

Table 50: Order data - 8BVP power supply modules

Technical data • 8BVP power supply modules

Required accessories				
Model number	Amount	Short description	Comment	Page
8BZVP044000.000-1A ¹⁾	1	Screw clamp set for ACOPOSmulti Modules 8BVP0220Hx00 and 8BVP0440Hx00: 1x 8TB2106.2010-00, 1x 8TB2108.2010-00, 1x 8TB2104.204A-00, 1x 8TB4104.202L-10	---	---
8BZVP165000.000-1A	1	Screw clamp set for ACOPOSmulti Modules 8BVP0880Hx00 and 8BVP1650Hx00: 1x 8TB2104.204A-00, 1x 8TB2106.2010-00, 1x 8TB2108.2010-00	---	---

Table 51: Required accessories - 8BVP power supply modules

1) Only for 8BVP0220Hx00.000-1 und 8BVP0440Hx00.000-1.

Optional accessories				
Model number	Amount	Short description	Comment	Page
8TB2106.2010-00	1	Screw clamp, 6-pin, single-row, spacing: 5.08 mm, Label 1: numbered serially	Plug for X1 connection	---
8TB2108.2010-00	1	Screw clamp, 8-pin, single-row, spacing: 5.08 mm, Label 1: numbered serially	Plug for X2 connection	---
8TB2104.204A-00	1	Screw clamp, 4-pin, single-row, spacing: 5.08 mm, Label 4: T- T+ F- F+, Coding A: 0000	Plug for X4A connection	---
8TB4104.202L-10 ¹⁾	1	Screwclamp, 4-pin, single-row, spacing: 10.16mm, Label 2: L1 L2 L3 PE, Coding L: 1010	Plug for X5A connection	---
8BAC0120.000-1	Max. 2	ACOPOSmulti plug-in module, EnDat 2.1 interface	---	166
8BAC0120.001-2	Max. 2	ACOPOSmulti plug-in module, EnDat 2.2 interface	---	170
8BAC0122.000-1	Max. 2	ACOPOSmulti plug-in module, Resolver interface 10 kHz	---	178
8BAC0123.000-1	Max. 2	ACOPOSmulti plug-in module, Incremental encoder and SSI absolute encoder interface for RS422 signals	---	182
8BAC0123.001-1	Max. 2	ACOPOSmulti plug-in module, Incremental encoder interface for 5 V single-ended and 5 V differential signals	---	188
8BAC0123.002-1	Max. 2	ACOPOSmulti plug-in module, Incremental encoder interface for 24 V single-ended and 24 V differential signals	---	193
8BAC0124.000-1	Max. 2	ACOPOSmulti plug-in module, SinCos interface	---	198
8BAC0130.000-1	Max. 1	ACOPOSmulti plug-in module, 2 digital outputs, 50 mA, max. 62.5 kHz, 2 digital outputs, 500 mA, max. 1.25 kHz, 2 digital inputs - 24 VDC	only SLOT 2	202
8BAC0130.001-1	Max. 1	ACOPOSmulti plug-in module, 2 digital outputs, 50 mA, max. 62.5 kHz, 4 digital outputs, 500 mA, max. 1.25 kHz	only SLOT 2	206
8BAC0132.000-1	Max. 2	ACOPOSmulti plug-in module, 4 analog inputs ± 10 V	---	209

Table 52: Optional accessories - 8BVP power supply modules

Technical data • 8BVP power supply modules

Optional accessories				
Model number	Amount	Short description	Comment	Page
8SCS005.0000-00	Up to 2	ACOPOSmulti shield component set: 1 slot cover shield sheet	Shield sheet for covering free plug-in module slots	---
8SCS002.0000-00	1	ACOPOSmulti shield component set: 1 clamping plate; 2 clamps D 4-13.5 mm; 4 screws	Shield component set for I/O cable with a cable diameter of 4 - 13.5 mm	---
8SCS008.0000-00 ¹⁾	1	ACOPOSmulti shield component set: 1 shield plate, 2x, type 0; 1 hose clamp, W 9 mm, D 23-35 mm	Shield component set for power cables with a diameter of 23 - 35 mm	---
8SCS003.0000-00 ²⁾	1	ACOPOSmulti shield component set: 1 shield mounting plate, 4x, 45°; 8 screws	Base plate for mounting shield component set 8SCS001.0000-00 or 8SCS004.0000-00	---
8SCS004.0000-00 ²⁾	1	ACOPOSmulti shield component set: 1 shield plate, 4x, type 0; 2 hose clamps, W 9 mm, D 32-50 mm	Shield component set for power cables with a diameter of 32 - 50 mm	---
8SCS001.0000-00 ²⁾	3	ACOPOSmulti shield component set: 1 shield plate, 4x, type 1; 1 hose clamp, W 9 mm, D 12-22 mm	Shield component set for individual wires with a diameter of 12 - 22 mm	---
8SCS007.0000-00 ¹⁾	1	ACOPOSmulti shield component set: 1 shield mounting plate, 2x, 45°; 4 screws	Base plate for mounting shield component set 8SCS008.0000-00	---
8BXF001.0000-00	---	ACOPOSmulti fan module Replacement fan for ACOPOSmulti modules (8BxP/8B0C/8BVI/8BVE/8B0K)	Replacement fan for ACOPOSmulti modules (8BxP/8B0C/8BVI/8BVE/8B0K)	---

Table 52: Optional accessories - 8BVP power supply modules (cont.)

1) Only for 8BVP0220Hx00.000-1 und 8BVP0440Hx00.000-1.

2) Only for 8BVP0880Hx00.000-1.

9.2 Technical data

Product ID	8BVP0220HW00.000-1 8BVP0220HC00.000-1	8BVP0440HW00.000-1 8BVP0440HC00.000-1	8BVP0880HW00.000-1 8BVP0880HC00.000-1
Wall mounting Cold plate or feed-through mounting			
General information			
C-UL-US listed	Yes		
Available cooling and mounting methods Wall mounting Cold plate or feed-through mounting	Yes Yes		
Module width	2		4
Power mains connection			
Mains input voltage	3 x 220 to 3 x 480 VAC ±10%		
System configuration	TT, TN-S, TN-C-S		
Frequency	50 / 60 Hz ±4%		
Installed load ¹⁾	Max. 15.6 kW	Max. 31.1 kW	Max. 62 kW
Starting current at 400 VAC	Max. 67 A		Max. 133 A
Switch-on interval Mains input voltage 3x 400 VAC Mains input voltage 3x 480 VAC	> 180 s > 300 s		
Max. chargeable DC bus capacitance	4 mF		8 mF
Rated switching frequency	5 kHz		
Possible switching frequencies ²⁾	5 / 10 kHz		
Integrated line filter according to EN61800-3-A11, category 3 ³⁾	No		
Integrated regeneration choke	No		
Capable of regeneration	Yes		
Power Factor Control (PFC)	Yes		
Design L1, L2, L3, PE PE Shield connection	Plugs M5 threaded bolt Yes ⁴⁾		M8 threaded bolt No Yes ⁴⁾
Terminal connection cross sections Flexible and fine wire lines with wire tip sleeves Approbation data UL/C-UL-US CSA	0.5 - 16 mm ² 20 - 6 20 - 6		6 - 50 mm ² ⁵⁾ In preparation In preparation
Terminal cable outer-cross-section dimension of the shield connection	23 - 35 mm		32 - 50 mm

Table 53: Technical data -8BVP power supply modules

Technical data • 8BVP power supply modules

Product ID	8BVP0220HW00.000-1 8BVP0220HC00.000-1	8BVP0440HW00.000-1 8BVP0440HC00.000-1	8BVP0880HW00.000-1 8BVP0880HC00.000-1
DC bus connection			
Voltage Max.	750 VDC 900 VDC		
Continuous power (supply and regeneration) ⁶⁾	15 kW	30 kW	60 kW
Reduction of continuous power depending on mains input voltage Mains input voltage < 3 x 400VAC	37.5 W/V * (400 V - mains input voltage)	75 W/V * (400 V - mains input voltage)	150 W/V * (400 V - mains input voltage)
Reduction of continuous power depending on switching frequency and cooling method ⁷⁾ Switching frequency 10 kHz Wall mounting ⁸⁾ Cold-plate installation ⁹⁾ Feed-through mounting Switching frequency 5 kHz Wall mounting ⁸⁾ Cold-plate installation ⁹⁾ Feed-through mounting	0.27 kW/K (from 31°C) 0.33 kW/K (from 49°C) In preparation No reduction No reduction In preparation	0.35 kW/K (from -10°C) ¹⁰⁾ 0.43 kW/K (from 6°C) ¹¹⁾ In preparation 1.11 kW/K (from 40°C) 0.56 kW/K (from 45°C) In preparation	0.64 kW/K (from -5°C) ¹⁰⁾ 0.95 kW/K (from 27°C) In preparation 0.97 kW/K (from 41°C) 1.3 kW/K (from 58°C) In preparation
Reduction of continuous power depending on installation altitude Starting at 500 m above sea level	1.5 kW per 1,000 m	3 kW per 1,000 m	6 kW per 1,000 m
Peak power (supply and regeneration)	37.5 kW	60 kW	120 kW
Power loss depending on the switching frequency ¹²⁾ Switching frequency 5 kHz Switching frequency 10 kHz	(0.28*P ² +7.9*P+40) W (0.9*P ² +5.3*P+110) W	(0.15*P ² +10.5*P+40) W (0.42*P ² +16*P+130) W	(0.065*P ² +11.4*P+90) W (0.22*P ² +16.1*P+185) W
DC bus capacitance	495 µF	825 µF	1650 µF
Protective measures Overload protection Short circuit and ground fault	Yes No		
Design	ACOPOSMulti backplane		
24 VDC supply ¹³⁾			
Input voltage	25 VDC ±1.6%		
Input capacitance	4.7 µF		
Max. power consumption	$P_{24\text{ V Out}} \{0 \dots 10\text{ W}\}^{14)} +$ $P_{\text{fan8BVF...}}^{15)} +$ $2 * P_{\text{fan8BOM...}}^{16)}$		$P_{24\text{ V Out}} \{0 \dots 10\text{ W}\}^{14)} +$ $P_{\text{Fan8BVF...}}^{15)} +$ $4 * P_{\text{fan8BOM...}}^{16)}$
Design	ACOPOSMulti backplane		
Line filter fan connection			
Output voltage	24V ±5.8 / -0.1%		
Continuous current	4.2 A		
Protective measures Overload protection Short circuit protection Cable breakage monitoring Undervoltage monitoring	No Yes No No		
Max. over-current limitation	10 A		

Table 53: Technical data -8BVP power supply modules (cont.)

Technical data • 8BVP power supply modules

Product ID	8BVP0220HW00.000-1 8BVP0220HC00.000-1	8BVP0440HW00.000-1 8BVP0440HC00.000-1	8BVP0880HW00.000-1 8BVP0880HC00.000-1
Wall mounting Cold plate or feed-through mounting			
Trigger inputs			
Number of inputs	2		
Wiring	Sink		
Electrical isolation			
Input - Power supply module	Yes		
Input - Input	Yes		
Input voltage			
Rated	24 VDC		
Maximum	30 VDC		
Switching threshold			
LOW	< 5 V		
HIGH	>15 V		
Input current at rated voltage	Approx. 10 mA		
Switching delay			
Positive edge	52 μ s \pm 0.5 μ s (digitally filtered)		
Negative edge	53 μ s \pm 0.5 μ s (digitally filtered)		
Modulation compared to ground potential	Max. \pm 38 V		
24 V Out			
Amount	2		
Output voltage			
DC bus voltage 260 ... 315 VDC	25 VDC * (DC bus voltage / 315)		
DC bus voltage 315 ... 900 VDC	24 VDC \pm 6%		
Fuse protection	500 mA (slow-blow) electronic, automatic reset		
Operational conditions			
Permitted mounting orientations			
Hanging vertically	Yes		
Lying horizontally	Yes		
Standing horizontally	No		
Ambient temperature during operation	5 to 40°C		
Max. ambient temperature ¹⁷⁾	+55°C		
Relative humidity during operation	5 to 85%, non-condensing		
Installation at altitudes above sea level	0 to 500 m		
Maximum installation altitude ¹⁸⁾	4,000 m		
Degree of pollution according to EN 60664-1	2 (non-conductive material)		
Overvoltage cat. according to IEC 60364-4-443:1999	III		
EN 60529 protection	IP20		
Storage and transport conditions			
Storage temperature	-25 to +55°C		
Relative humidity during storage	5 to 95%, non-condensing		
Transport temperature	-25 to +70°C		
Relative humidity during transport	Max. 95% at +40°C		

Table 53: Technical data -8BVP power supply modules (cont.)

Technical data • 8BVP power supply modules

Product ID			
Wall mounting	8BVP0220HW00.000-1	8BVP0440HW00.000-1	8BVP0880HW00.000-1
Cold plate or feed-through mounting	8BVP0220HC00.000-1	8BVP0440HC00.000-1	8BVP0880HC00.000-1
Mechanical characteristics			
Dimensions ¹⁹⁾			
Width		106.5 mm	213.5 mm
Height		317 mm	317 mm
Depth			
Wall mounting		263 mm	263 mm
Cold-plate		212 mm	212 mm
Feed-through mounting		209 mm	209 mm
Weight			
Wall mounting	Approx. 5.2 kg	Approx. 5.5 kg	Approx. 10.2 kg
Cold-plate	Approx. 4.2 kg	Approx. 4.5 kg	Approx. 7.9 kg
Feed-through mounting	Approx. 4.2 kg	Approx. 4.5 kg	Approx. 7.9 kg

Table 53: Technical data -8BVP power supply modules (cont.)

- 1) The specified value includes the power loss from the respective 8BVF line filter and 8BVR regeneration choke.
- 2) B&R recommends operating the module at nominal switching frequency. Operating the module at a higher switching frequency for application-specific reasons reduces the continuous power and increases the CPU load.
- 3) Limit values from CISPR11, group 2, class A (second environment).
- 4) The cable does not require shielding up to a total cable length between the line filter, regeneration choke and power supply module of 3 m. Please contact B&R when using cable lengths > 3 m.
- 5) The connection is made with cable lugs using an M8 threaded bolt.
- 6) Valid in the following conditions: Mains input voltage 3 x 400 VAC, switching frequency 5 kHz, 40°C ambient temperature, installation altitudes < 500 m above sea level, no derating dependent on cooling type.
- 7) Valid in the following conditions: DC bus voltage 750 VDC, minimum permissible coolant flow volume (3 l/min). The nominal switching frequency values for the respective ACOPOSmulti inverter module are marked in bold.
- 8) The temperature specifications are based on the ambient temperature.
- 9) The temperature specifications are based on the return temperature of the cold plate mounting plate.
- 10) The module cannot supply the full continuous current at this switching frequency. This unusual value for the ambient temperature, at which a derating of the continuous current must be accounted for, ensures that the derating of the continuous current can be determined in the same manner as at other switching frequencies.
- 11) The module cannot supply the full continuous current at this switching frequency. This unusual value for the return temperature, at which a derating of the continuous current must be accounted for, ensures that the derating of the continuous current can be determined in the same manner as at other switching frequencies.

Caution! Condensation can occur at low flow-temperatures and low return-temperatures. The designs in the section "Condensation", on page 362 must be taken into consideration!

- 12) Valid at a mains input voltage of 400 VAC. P ... Continuous power [kW].
- 13) In the power supply modules a DC bus power supply is integrated for the electronic supply. The 24 VDC supply from the ACOPOSmulti backplane only feeds the +24 VDC of the trigger inputs and the encoder power supplies on the encoder modules.
- 14) The power consumption $P_{24V\ Out}$ corresponds to the power that is output on the module's X2 / +24 V Out 1 and X2 / +24 V Out 2 connections (max. 10 W).
- 15) The power consumption $P_{Fan8BVF...}$ corresponds to the portion of the power that is output on the X4A / F- and X4A / F+ connectors on the module and can be found in the technical data for the respective line filter 8BVF... (fan connection).
- 16) The power consumption $P_{Fan8BOM...}$ corresponds to the portion of the power that is used by the fan modules in the mounting plate / by the 8BOM0040HFF0.000-1 fan module and can be found in the technical data for the respective 8BOM... mounting plate.
- 17) Continuous operation at ambient temperatures ranging from 40°C to max. 55°C is possible (taking the continuous current reductions listed into consideration), but results in a shorter lifespan.
- 18) Continuous operation at altitudes ranging from 500 m to 4,000 m above sea level is possible (taking the continuous current reductions listed into consideration). Additional requirements are to be arranged with B&R.
- 19) The dimensions refer to the true device dimensions including the respective mounting plate. Make sure to leave additional space above and below the device for mounting, connections and air circulation (see section 4 "Dimension diagrams and installation dimensions", on page 264).

9.2.1 POWERLINK station number settings

The POWERLINK station number can be set using two HEX code switches that are located behind the black cover of the module:

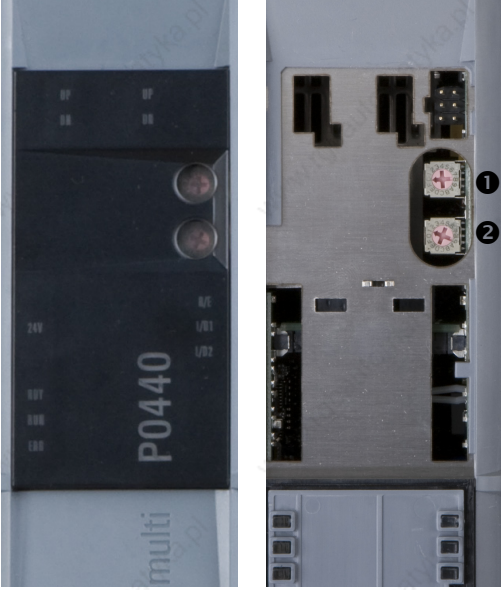
Figure	Code switch	POWERLINK station number
 <p data-bbox="211 922 302 943">Cover closed</p> <p data-bbox="481 922 572 943">Cover open</p>	<p data-bbox="733 300 748 329">❶</p>	<p data-bbox="917 300 1050 321">16s position (high)</p>
	<p data-bbox="733 336 748 365">❷</p>	<p data-bbox="924 336 1043 357">1s position (low)</p>
<p data-bbox="665 375 1128 418">The POWERLINK station number change takes effect the next time the ACOPOSmulti drive system is switched on.</p> <p data-bbox="665 435 796 462">Information:</p> <p data-bbox="665 475 1128 516">In principle, station numbers between \$01 and \$FD are permitted.</p> <p data-bbox="665 518 1128 581">However, station numbers between \$F0 and \$FD are reserved for future system expansions. For reasons of compatibility, we recommend avoiding these station numbers.</p> <p data-bbox="665 594 1128 634">Station numbers \$00, \$FE and \$FF are reserved and are therefore not allowed to be set.</p>		

Table 54: Setting the POWERLINK station number

10. 8BVP power supply modules, 120kW

10.1 Order data


Model number	Short description	Figure
	Cold plate or feed-through mounting	
8BVP1650HC00.000-1	ACOPOSMulti power supply module, 165 A, HV, cold plate or feed-through mounting	 <p style="text-align: center;">8BVP1650HC00.000-1</p>

Table 55: Order data - 8BVP power supply modules, 120kW

Required accessories				
Model number	Amount	Short description	Comment	Page
8BZVP165000.000-1A	1	Screw clamp set for ACOPOSMulti Modules 8BVP0880Hx00 and 8BVP1650Hx00: 1x 8TB2104.204A-00, 1x 8TB2106.2010-00, 1x 8TB2108.2010-00	---	---

Table 56: Required accessories - 8BVP power supply modules, 120kW

Optional accessories				
Model number	Amount	Short description	Comment	Page
8TB2106.2010-00	1	Screw clamp, 6-pin, single-row, spacing: 5.08 mm, Label 1: numbered serially	Plug for X1 connection	---
8TB2108.2010-00	1	Screw clamp, 8-pin, single-row, spacing: 5.08 mm, Label 1: numbered serially	Plug for X2 connection	---
8TB2104.204A-00	1	Screw clamp, 4-pin, single-row, spacing: 5.08 mm, Label 4: T- T+ F- F+, Coding A: 0000	Plug for X4A connection	---
8BAC0120.000-1	Max. 2	ACOPOSMulti plug-in module, EnDat 2.1 interface	---	166
8BAC0120.001-2	Max. 2	ACOPOSMulti plug-in module, EnDat 2.2 interface	---	170
8BAC0122.000-1	Max. 2	ACOPOSMulti plug-in module, Resolver interface 10 kHz	---	178

Table 57: Optional accessories - 8BVP power supply modules

Technical data • 8BVP power supply modules, 120kW

Optional accessories				
Model number	Amount	Short description	Comment	Page
8BAC0123.000-1	Max. 2	ACOPOSmulti plug-in module, Incremental encoder and SSI absolute encoder interface for RS422 signals	---	182
8BAC0123.001-1	Max. 2	ACOPOSmulti plug-in module, Incremental encoder interface for 5 V single-ended and 5 V differential signals	---	188
8BAC0123.002-1	Max. 2	ACOPOSmulti plug-in module, Incremental encoder interface for 24 V single-ended and 24 V differential signals	---	193
8BAC0124.000-1	Max. 2	ACOPOSmulti plug-in module, SinCos interface	---	198
8BAC0130.000-1	Max. 1	ACOPOSmulti plug-in module, 2 digital outputs, 50 mA, max. 62.5 kHz, 2 digital outputs, 500 mA, max. 1.25 kHz, 2 digital inputs - 24 VDC	only SLOT 2	202
8BAC0130.001-1	Max. 1	ACOPOSmulti plug-in module, 2 digital outputs, 50 mA, max. 62.5 kHz, 4 digital outputs, 500 mA, max. 1.25 kHz	only SLOT 2	206
8BAC0132.000-1	Max. 2	ACOPOSmulti plug-in module, 4 analog inputs ± 10 V	---	209
8SCS005.0000-00	Up to 2	ACOPOSmulti shield component set: 1 slot cover shield sheet	Shield sheet for covering free plug-in module slots	---
8SCS002.0000-00	1	ACOPOSmulti shield component set: 1 clamping plate; 2 clamps D 4-13.5 mm; 4 screws	Shield component set for I/O cable with a cable diameter of 4 - 13.5 mm	---
8SCS003.0000-00	1	ACOPOSmulti shield component set: 1 shield mounting plate, 4x, 45°; 8 screws	Base plate for mounting shield component set 8SCS001.0000-00 or 8SCS004.0000-00	---
8SCS004.0000-00	1	ACOPOSmulti shield component set: 1 shield plate, 4x, type 0; 2 hose clamps, W 9 mm, D 32-50 mm	Shield component set for power cables with a diameter of 32 - 50 mm	---
8SCS001.0000-00	3	ACOPOSmulti shield component set: 1 shield plate, 4x, type 1; 1 hose clamp, W 9 mm, D 12-22 mm	Shield component set for individual wires with a diameter of 12 - 22 mm	---
8BXF001.0000-00	---	ACOPOSmulti fan module Replacement fan for ACOPOSmulti modules (8BxP/8B0C/8BVI/8BVE/8B0K)	Replacement fan for ACOPOSmulti modules (8BxP/8B0C/8BVI/8BVE/8B0K)	---

Table 57: Optional accessories - 8BVP power supply modules (cont.)

10.2 Technical data

Product ID	
Cold plate or feed-through mounting	8BVP1650HC00.000-1
General information	
C-UL-US listed	In preparation
Available cooling and mounting methods	
Wall mounting	No
Cold plate or feed-through mounting	Yes
Module width	8
Power mains connection	
Mains input voltage	3 x 220 to 3 x 480 VAC ±10%
System configuration	TT, TN-S, TN-C-S
Frequency	50 / 60 Hz ±4%
Installed load ¹⁾	Max. 124 kW
Starting current at 400 VAC	Max. 34 A
Switch-on interval	
Mains input voltage 3x 400 VAC	>300 s
Mains input voltage 3x 480 VAC	>800 s
Max. chargeable DC bus capacitance	16 mF
Rated switching frequency	5 kHz
Possible switching frequencies ²⁾	5 / 10 kHz
Integrated line filter according to EN61800-3-A11, category 3 ³⁾	No
Integrated regeneration choke	No
Capable of regeneration	Yes
Power Factor Control (PFC)	Yes
Design	
L1, L2, L3, PE	M8 threaded bolt
PE	No
Shield connection	Yes ⁴⁾
Terminal connection cross sections	
Flexible and fine wire lines with wire tip sleeves	10 - 95 mm ² ⁴⁾
Approbation data	
UL/C-UL-US	In preparation
CSA	In preparation
Terminal cable outer-cross-section dimension of the shield connection	32 - 50 mm

Table 58: Technical data -8BVP power supply modules, 120kW

Technical data • 8BVP power supply modules, 120kW

Product ID	
Cold plate or feed-through mounting	8BVP1650HC00.000-1
DC bus connection	
Voltage Max.	750 VDC 900 VDC
Continuous power (supply and regeneration) ⁵⁾	120 kW
Reduction of continuous power depending on mains input voltage Mains input voltage < 3 x 400VAC	37.5 W/V * (400 - mains input voltage)
Reduction of continuous power depending on switching frequency and cooling method ⁶⁾ Switching frequency 10 kHz Cold-plate installation ⁷⁾ Feed-through mounting Switching frequency 5 kHz Cold-plate installation ⁷⁾ Feed-through mounting	In preparation In preparation In preparation In preparation
Reduction of continuous power depending on installation altitude Starting at 500 m above sea level	12 kW per 1,000 m
Peak power (supply and regeneration)	240 kW
Power loss depending on the switching frequency ⁸⁾ Switching frequency 5 kHz Switching frequency 10 kHz	In preparation In preparation
DC bus capacitance	3630 µF
Protective measures Overload protection Short circuit and ground fault	Yes No
Design	ACOPOSmulti backplane
24 VDC supply ⁹⁾	
Input voltage	25 VDC ±1.6%
Input capacitance	4.7 µF
Max. power consumption	$P_{24V Out} (0 \dots 10 \text{ W})^{10)} + P_{Fan8BVF...}^{11)}$
Design	ACOPOSmulti backplane
Line filter fan connection	
Output voltage	24V +5.8 / -0.1%
Continuous current	4.2 A
Protective measures Overload protection Short circuit protection Cable breakage monitoring Undervoltage monitoring	No Yes No No
Max. over-current limitation	10 A

Table 58: Technical data -8BVP power supply modules, 120kW (cont.)

Technical data • 8BVP power supply modules, 120kW

Product ID	8BVP1650HC00.000-1
Cold plate or feed-through mounting	
Trigger inputs	
Number of inputs	2
Wiring	Sink
Electrical isolation	
Input - Power supply module	Yes
Input - Input	Yes
Input voltage	
Rated	24 VDC
Maximum	30 VDC
Switching threshold	
LOW	< 5 V
HIGH	>15 V
Input current at rated voltage	Approx. 10 mA
Switching delay	
Positive edge	52 μ s \pm 0.5 μ s (digitally filtered)
Negative edge	53 μ s \pm 0.5 μ s (digitally filtered)
Modulation compared to ground potential	Max. \pm 38 V
24 V Out	
Amount	2
Output voltage	
DC bus voltage 260 ... 315 VDC	25 VDC * (DC bus voltage / 315)
DC bus voltage 315 ... 900 VDC	24 VDC \pm 6%
Fuse protection	500 mA (slow-blow) electronic, automatic reset
Operational conditions	
Permitted mounting orientations	
Hanging vertically	Yes
Lying horizontally	Yes
Standing horizontally	No
Ambient temperature during operation	5 to 40°C
Max. ambient temperature ¹²⁾	+55°C
Relative humidity during operation	5 to 85%, non-condensing
Installation at altitudes above sea level	0 to 500 m
Maximum installation altitude ¹³⁾	4,000 m
Degree of pollution according to EN 60664-1	2 (non-conductive material)
Overvoltage cat. according to IEC 60364-4-443:1999	III
EN 60529 protection	IP20
Storage and transport conditions	
Storage temperature	-25 to +55°C
Relative humidity during storage	5 to 95%, non-condensing
Transport temperature	-25 to +70°C
Relative humidity during transport	Max. 95% at +40°C

Table 58: Technical data -8BVP power supply modules, 120kW (cont.)

Technical data • 8BVP power supply modules, 120kW

Product ID	
Cold plate or feed-through mounting	8BVP1650HC00.000-1
Mechanical characteristics	
Dimensions ¹⁴⁾	
Width	427.5 mm
Height	317 mm
Depth	
Cold-plate	212 mm
Feed-through mounting	209 mm
Weight	Approx. 20 kg

Table 58: Technical data -8BVP power supply modules, 120kW (cont.)

- 1) The specified value includes the power loss from the respective 8BVF line filter and 8BVR regeneration choke.
- 2) B&R recommends operating the module at nominal switching frequency. Operating the module at a higher switching frequency for application-specific reasons reduces the continuous power and increases the CPU load.
- 3) Limit values from CISPR11, group 2, class A (second environment).
- 4) The connection is made with cable lugs using an M8 threaded bolt.
- 5) Valid in the following conditions: Mains input voltage 3 x 400 VAC, switching frequency 5 kHz, 40°C ambient temperature, installation altitudes < 500 m above sea level, no derating dependent on cooling type.
- 6) Valid in the following conditions: DC bus voltage 750 VDC, minimum permissible coolant flow volume (3 l/min). The nominal switching frequency values for the respective ACOPOSmulti inverter module are marked in bold.
- 7) The temperature specifications are based on the return temperature of the cold plate mounting plate.
- 8) Valid at a mains input voltage of 400 VAC. P ... Continuous power [kW].
- 9) In the power supply modules a DC bus power supply is integrated for the electronic supply. The 24 VDC supply from the ACOPOSmulti backplane only feeds the +24 VDC of the trigger inputs and the encoder power supplies on the encoder modules.
- 10) The power consumption $P_{24\text{ V Out}}$ corresponds to the power that is output on the module's X2 / +24 V Out 1 and X2 / +24 V Out 2 connections (max. 10 W).
- 11) The power consumption P_{Fan8BVF} corresponds to the portion of the power that is output on the X4A / F- and X4A / F+ connectors on the module and can be found in the technical data for the respective line filter 8BVF... (fan connection).
- 12) Continuous operation at ambient temperatures ranging from 40°C to max. 55°C is possible (taking the continuous current reductions listed into consideration), but results in a shorter lifespan.
- 13) Continuous operation at altitudes ranging from 500 m to 4,000 m above sea level is possible (taking the continuous current reductions listed into consideration). Additional requirements are to be arranged with B&R.
- 14) The dimensions refer to the true device dimensions including the respective mounting plate. Make sure to leave additional space above and below the device for mounting, connections and air circulation (see section 4 "Dimension diagrams and installation dimensions", on page 264).

10.2.1 POWERLINK station number settings

The POWERLINK station number can be set using two HEX code switches that are located behind the black cover of the module:

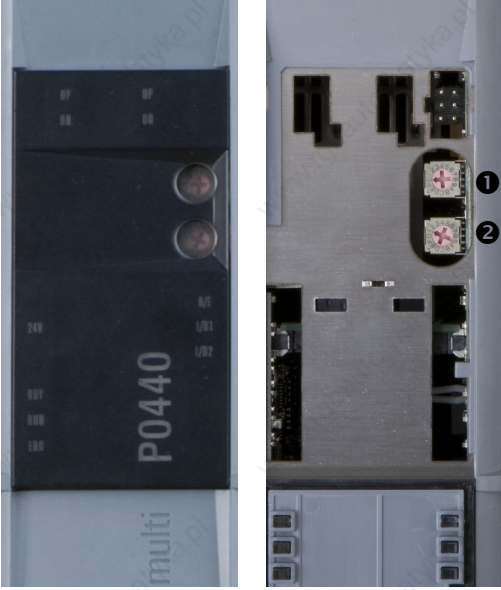
Figure	Code switch	POWERLINK station number
 <p data-bbox="209 922 299 943">Cover closed</p> <p data-bbox="480 922 570 943">Cover open</p>	❶	16s position (high)
	❷	1s position (low)
<p>The POWERLINK station number change takes effect the next time the ACOPOSmulti drive system is switched on.</p>		
<p>Information:</p>		
<p>In principle, station numbers between \$01 and \$FD are permitted.</p>		
<p>However, station numbers between \$F0 and \$FD are reserved for future system expansions. For reasons of compatibility, we recommend avoiding these station numbers.</p>		
<p>Station numbers \$00, \$FE and \$FF are reserved and are therefore not allowed to be set.</p>		

Table 59: Setting the POWERLINK station number

11. 8B0C 400W auxiliary supply modules

Warning!

8B0C auxiliary supply modules are components of and may only be used in connection with the ACOPOSmulti drive system.

Information:

Up to five auxiliary supply modules with any power rating can be set up in parallel.

11.1 Order data


Model number	Short description	Figure
	Wall mounting	 <p>8B0C0160HC00.001-1</p>
8B0C0160HW00.000-1	ACOPOSmulti auxiliary supply module 16 A, HV, wall mounting	
8B0C0160HW00.001-1	ACOPOSmulti auxiliary supply module, 16 A, HV, wall mounting, 24VOut 1x 16 A, 1x 5 A	
	Cold plate or feed-through mounting	
8B0C0160HC00.000-1	ACOPOSmulti auxiliary supply module 16 A, HV, cold plate or feed-through mounting	
8B0C0160HC00.001-1	ACOPOSmulti auxiliary supply module, 16 A, HV, cold-plate or feed-through mounting, 24VOut 1x 16 A, 1x 5 A	

Table 60: Order data - 8B0C control supply units 400W

Required accessories				
Model number	Amount	Short description	Comment	Page
8BZ0C032000.000-1	1	Screw clamp set for ACOPOSmulti 8B0C0xx0Hx00.000-1 modules: 1x 8TB2106.2010-00	---	---
8BZ0C016000.001-1A ¹⁾	1	Screw clamp set for ACOPOSmulti 8B0C0160Hx00.001-1 modules: 1x 8TB3104.201M-10, 1x 8TB2104.2010-00, 1x 8TB2106.2010-00	---	---

Table 61: Required accessories for 8B0C auxiliary supply modules 400W

1) Only for 8B0C0160Hx00.001-1.

Technical data • 8B0C 400W auxiliary supply modules

Optional accessories				
Model number	Amount	Short description	Comment	Page
8TB2106.2010-00	1	Screw clamp, 6-pin, single-row, spacing: 5.08 mm, Label 1: numbered serially	Plug for X1 connection	---
8TB2104.2010-00 ¹⁾	1	Screw clamp, 4-pin, single-row, spacing: 5.08 mm, Label 1: numbered serially	Plug for X2 connection	---
8TB3104.201M-10 ¹⁾	1	Screw clamp, 4-pin, single-row, spacing: 7.62 mm, Label 1: numbered serially, M coding: 1011	Plug for X3 connection	---
8BXF001.0000-00	---	ACOPOSmulti fan module Replacement fan for ACOPOSmulti modules (8BxP/8B0C/8BVI/8BVE/8B0K)	Replacement fan for ACOPOSmulti modules (8BxP/8B0C/8BVI/8BVE/8B0K)	---

Table 62: Optional accessories for auxiliary supply modules 8B0C 400W

1) Only for 8B0C0160Hx00.001-1.

11.2 Technical data

Product ID	8B0C0160HW00.000-1 8B0C0160HC00.000-1	8B0C0160HW00.001-1 8B0C0160HC00.001-1
Wall mounting Cold plate or feed-through mounting		
General information		
C-UL-US listed	Yes	
Available cooling and mounting methods		
Wall mounting	Yes	
Cold plate or feed-through mounting	Yes	
Module width	1	
DC bus connection		
Voltage	750 VDC	
Operating range in continuous operation	260 - 900 VDC	
Full continuous power	315 - 900 VDC	
Continuous power consumption	Max. 445 W	
Power loss with continuous power	45 W	
DC bus capacitance	220 nF	
Design	ACOPOSmulti backplane	

Table 63: Technical data - 8B0C control supply units 400W

Technical data • 8B0C 400W auxiliary supply modules

Product ID	8B0C0160HW00.000-1 8B0C0160HC00.000-1	8B0C0160HW00.001-1 8B0C0160HC00.001-1
Wall mounting Cold plate or feed-through mounting		
24 VDC output		
Continuous power ¹⁾	400 W	
Output voltage DC bus voltage 260 ... 315 VDC DC bus voltage 315 ... 900 VDC	25 VDC * (DC bus voltage / 315) 24 VDC ±6%	
Continuous current	16 ADC	
Reduction of continuous power according to ambient temperature above 40°C	No reduction	
Reduction of continuous power depending on installation altitude Starting at 500 m above sea level	40 W per 1,000 m	
Reduction of continuous power depending on cooling method Wall mounting Cold plate or feed-through mounting	In preparation In preparation	
Startup delay	Max. 1 sec.	
Startup time	Approx. 5 - 20 ms	
Residual ripple	Typ. 50 mV _{SS}	
24 VDC internal system supply voltage		
Output voltage	25 VDC ±1.6%	
Peak current (< 4 s) DC bus voltage (UDC): 350 ... 900 VDC	21 ADC	
Protective measures Open circuit protection Overload protection Short circuit protection Feedback protection Over-temperature protection Dielectric strength to ground Output / input isolation	Yes Yes Yes Max. 26 VDC (also when turned off) Yes ±50 VDC SELV / PELV requirements	
Design	ACOPOSmulti backplane	

Table 63: Technical data - 8B0C control supply units 400W (cont.)

Technical data • 8B0C 400W auxiliary supply modules

Product ID	8B0C0160HW00.000-1 8B0C0160HC00.000-1	8B0C0160HW00.001-1 8B0C0160HC00.001-1
Wall mounting Cold plate or feed-through mounting		
24 VDC Out		
Output voltage DC bus voltage 260 ... 315 VDC DC bus voltage 315 ... 900 VDC	--- ---	25 VDC * (DC bus voltage / 315) 24 VDC ±6%
Peak current (< 4 s) over the total operating range of the DC bus voltage.	---	---
Protection of 24 VDC Out 1 output	---	16 A (slow-blow) electronic, automatic reset
Protection of 24 VDC Out 2 output	---	5 A (slow-blow) electronic, automatic reset
Protective measures Open circuit protection Overload protection Short circuit protection Feedback protection Over-temperature protection Dielectric strength to ground Output / input isolation	--- --- --- --- --- --- ---	Yes Yes Yes Max. 35 VDC (also when turned off) Yes ±50 VDC SELV / PELV requirements
Design 24 VDC, COM	---	Plugs
Terminal connection cross section of the 24 VDC Out 1 output Flexible and fine wire lines with wire tip sleeves Approbation data UL/C-UL-US CSA	--- --- --- ---	0.5 - 6 mm ² 22 - 10 22 - 10
Terminal connection cross section of the 24 VDC Out 2 output Flexible and fine wire lines with wire tip sleeves Approbation data UL/C-UL-US CSA	--- --- --- ---	0.2 - 2.5 mm ² 22 - 12 22 - 12

Table 63: Technical data - 8B0C control supply units 400W (cont.)

Technical data • 8B0C 400W auxiliary supply modules

Product ID	8B0C0160HW00.000-1 8B0C0160HC00.000-1	8B0C0160HW00.001-1 8B0C0160HC00.001-1
Wall mounting Cold plate or feed-through mounting		
24 VDC Out 1 controller input		
Wiring	---	Sink
Electrical isolation Input - 24 VDC	---	Yes
Modulation compared to ground potential	---	Max. ±50 V
Input voltage Rated Maximum	--- ---	24 VDC 30 VDC
Switching threshold LOW (24 VDC Out 1 is switched on) HIGH (24 VDC Out 1 is switched off)	--- ---	< 5 V > 15 V
Input current at rated voltage	---	Approx. 10 mA
Switching delay ON (24 VDC Out 1 is switched on) OFF (24 VDC Out 1 is switched off) ²⁾	--- ---	Max. 25 ms Max. 0.25 ms
Design	---	Plugs
Terminal connection cross sections Flexible and fine wire lines with wire tip sleeves Approbation data UL/C-UL-US CSA	--- --- ---	0.2 - 2.5 mm ² 30 - 12 22 - 12
Operational conditions		
Permitted mounting orientations Hanging vertically Lying horizontally Standing horizontally		Yes Yes No
Ambient temperature during operation Max. ambient temperature		5 to 40°C +55°C
Relative humidity during operation		5 to 85%, non-condensing
Installation at altitudes above sea level Maximum installation altitude ³⁾		0 to 500 m 4,000 m
Degree of pollution according to EN 60664-1		2 (non-conductive material)
Overvoltage cat. according to IEC 60364-4-443:1999		III
EN 60529 protection		IP20
Storage and transport conditions		
Storage temperature		-25 to +55°C
Relative humidity during storage		5 to 95%, non-condensing
Transport temperature		-25 to +70°C
Relative humidity during transport		Max. 95% at +40°C

Table 63: Technical data - 8B0C control supply units 400W (cont.)

Technical data • 8B0C 400W auxiliary supply modules

Product ID		
Wall mounting	8B0C0160HW00.000-1	8B0C0160HW00.001-1
Cold plate or feed-through mounting	8B0C0160HC00.000-1	8B0C0160HC00.001-1
Mechanical characteristics		
Dimensions ⁴⁾		
Width		53 mm
Height		317 mm
Depth		
Wall mounting		263 mm
Cold-plate		212 mm
Feed-through mounting		209 mm
Weight		
Wall mounting	Approx. 3 kg	Approx. 3.2 kg
Cold-plate	Approx. 2.5 kg	Approx. 2.7 kg
Feed-through mounting	Approx. 2.5 kg	Approx. 2.7 kg

Table 63: Technical data - 8B0C control supply units 400W (cont.)

- 1) Valid in the following conditions: DC bus voltage 750 VDC, 55°C ambient temperature, installation altitudes < 500 m above sea level, no derating dependent on cooling type.
- 2) The output and any connected loads are not actively discharged when switching off.
- 3) Continuous operation at altitudes ranging from 500 m to 4,000 m above sea level is possible (taking the continuous power reductions listed into consideration). Additional requirements are to be arranged with B&R.
- 4) The dimensions refer to the true device dimensions including the respective mounting plate. Make sure to leave additional space above and below the device for mounting, connections and air circulation (see section 4 "Dimension diagrams and installation dimensions", on page 264).

12. 8B0C 800W auxiliary supply module

Warning!

8B0C auxiliary supply modules are components of and may only be used in connection with the ACOPOSmulti drive system.

Information:

Up to five auxiliary supply modules with any power rating can be set up in parallel.

12.1 Order data


Model number	Short description	Figure
	Wall mounting	 <p>8B0C0320HC00.002-1</p>
8B0C0320HW00.000-1	ACOPOSmulti auxiliary supply module 32 A, HV, wall mounting	
8B0C0320HW00.002-1	ACOPOSmulti auxiliary supply module, 32 A, HV, wall mounting, 24VOut 1x 32 A, 1x 5 A	
8B0C0160HW00.A01-1	ACOPOSmulti auxiliary supply module, 16 A, HV, wall mounting, 42VOut 1x 16A, 1x 3A	
	Cold plate or feed-through mounting	
8B0C0320HC00.000-1	ACOPOSmulti auxiliary supply module 32 A, HV, cold plate or feed-through mounting	
8B0C0320HC00.002-1	ACOPOSmulti auxiliary supply module, 32 A, HV, cold-plate or feed-through mounting, 24VOut 1x 32 A, 1x 5 A	
8B0C0160HC00.A01-1	ACOPOSmulti auxiliary supply module, 16 A, HV, cold-plate or feed-through mounting, 42VOut 1x 16A, 1x 3A	

Table 64: Order data - 8B0C control supply units 800W

Required accessories				
Model number	Amount	Short description	Comment	Page
8BZ0C032000.000-1A ¹⁾	1	Screw clamp set for ACOPOSmulti 8B0C0xx0Hx00.000-1 modules: 1x 8TB2106.2010-00	---	---
8BZ0C032000.002-1A ²⁾	1	Screw clamp set for ACOPOSmulti 8B0C0320Hx00.002-1 modules: 1x 8TB3104.201M-10, 1x 8TB2104.2010-00, 1x 8TB2106.2010-00	---	---
8BZ0C016000.A01-1A ³⁾	1	Screw clamp set for ACOPOSmulti 8B0C0160Hx00.A01-1 modules: 1x 8TB3104.201H-10, 1x 8TB2104.2010-00, 1x 8TB2106.2010-00	---	---

Table 65: Required accessories for 8B0C auxiliary supply modules 800W

1) Only for 8B0C0320Hx00.000-1.

2) Only for 8B0C0320Hx00.002-1.

3) Only for 8B0C0160HC00.A01-1.

Technical data • 8B0C 800W auxiliary supply module

Optional accessories				
Model number	Amount	Short description	Comment	Page
8TB2106.2010-00	1	Screw clamp, 6-pin, single-row, spacing: 5.08 mm, Label 1: numbered serially	Plug for X1 connection	---
8TB2104.2010-00 ¹⁾	1	Screw clamp, 4-pin, single-row, spacing: 5.08 mm, Label 1: numbered serially	Plug for X2 connection	---
8TB3104.201M-10 ²⁾	1	Screw clamp, 4-pin, single-row, spacing: 7.62 mm, Label 1: numbered serially, M coding: 1011	Plug for X3 connection	---
8TB3104.201H-10 ³⁾	1	Screw clamp, 4-pin, single-row, spacing: 7.62 mm, Label 1: numbered serially, Coding H: 0111	Plug for X3 connection	---
8BXF001.0000-00	---	ACOPOSmulti fan module Replacement fan for ACOPOSmulti modules (8BxP/8B0C/8BVI/8BVE/8B0K)	Replacement fan for ACOPOSmulti modules (8BxP/8B0C/8BVI/8BVE/8B0K)	---

Table 66: Optional accessories for 8B0C auxiliary supply units 800W

1) Only for 8B0C0320Hx00.002-1 and 8B0C0160HC00.A01-1.

2) Only for 8B0C0320Hx00.002-1.

3) Only for 8B0C0160HC00.A01-1.

12.2 Technical data

Product ID	8B0C0320HW00.000-1 8B0C0320HC00.000-1	8B0C0320HW00.002-1 8B0C0320HC00.002-1	8B0C0160HW00.A01-1 8B0C0160HC00.A01-1
Wall mounting Cold plate or feed-through mounting			
General information			
C-UL-US listed	Yes		
Available cooling and mounting methods			
Wall mounting	Yes		Yes
Cold plate or feed-through mounting	Yes		Yes
Module width	1		
DC bus connection			
Voltage	750 VDC		
Operating range in continuous operation	260 - 900 VDC		
Full continuous power	315 - 900 VDC		
Continuous power consumption	Max. 880 W		
Power loss with continuous power	80 W		
DC bus capacitance	220 nF		
Design	ACOPOSmulti backplane		

Table 67: Technical data - 8B0C control supply units 800W

Technical data • 8B0C 800W auxiliary supply module

Product ID	8B0C0320HW00.000-1 8B0C0320HC00.000-1	8B0C0320HW00.002-1 8B0C0320HC00.002-1	8B0C0160HW00.A01-1 8B0C0160HC00.A01-1
Wall mounting Cold plate or feed-through mounting			
24 VDC or 42 VDC output			
Continuous power ¹⁾	800 W		
Output voltage DC bus voltage 260 ... 315 VDC DC bus voltage 315 ... 900 VDC	25 VDC * (DC bus voltage / 315) 24 VDC ±6%		0 V 42 VDC
Continuous current	32 ADC		16 ADC
Reduction of continuous power according to ambient temperature above 40°C	No reduction		
Reduction of continuous power depending on installation altitude Starting at 500 m above sea level	80 W per 1,000 m		
Reduction of continuous power depending on cooling method Wall mounting Cold plate or feed-through mounting	In preparation In preparation	In preparation In preparation	--- In preparation
Startup delay	Max. 1 sec.		
Startup time	Approx. 5 - 20 ms		
Residual ripple	Typ. 50 mV _{SS}		
24 VDC internal system supply voltage			
Output voltage	25 VDC ±1.6%		---
Peak current (< 4 s) DC bus voltage (U _{DC}): 350 ... 900 VDC	42 ADC		---
Protective measures			
Open circuit protection	Yes		---
Overload protection	Yes		---
Short circuit protection	Yes		---
Feedback protection	Max. 26 VDC (also when turned off)		---
Over-temperature protection	Yes		---
Dielectric strength to ground	±50 VDC		---
Output / input isolation	SELV / PELV requirements		---
Design	ACOPOSmulti backplane		

Table 67: Technical data - 8B0C control supply units 800W (cont.)

Technical data • 8B0C 800W auxiliary supply module

Product ID	8B0C0320HW00.000-1 8B0C0320HC00.000-1	8B0C0320HW00.002-1 8B0C0320HC00.002-1	8B0C0160HW00.A01-1 8B0C0160HC00.A01-1
24 VDC or 42 VDC Out			
Output voltage	---	25 VDC * (DC bus voltage / 315)	0 V
DC bus voltage 260 ... 315 VDC	---	24 VDC ±6%	42 VDC ±6%
DC bus voltage 315 ... 900 VDC	---		
Peak current (< 4 s) over the total operating range of the DC bus voltage.	---	---	21 ADC
Protection of 24 VDC Out 1 output	---	32 A (slow-blow) electronic, automatic reset	---
Protection of 24 VDC Out 2 output	---	5 A (slow-blow) electronic, automatic reset	---
Protection of 42 VDC Out 1 output	---	---	16 A (slow-blow) electronic, automatic reset
Protection of 42 VDC Out 2 output	---	---	3 A (slow-blow) electronic, automatic reset
Protective measures			
Open circuit protection	---	Yes	Yes
Overload protection	---	Yes	Yes
Short circuit protection	---	Yes	Yes
Feedback protection	---	Max. 35 VDC (also when turned off)	Max. 60 VDC (also when turned off)
Over-temperature protection	---	Yes	Yes
Dielectric strength to ground	---	±50 VDC	±96 VDC
Output / input isolation	---	SELV / PELV requirements	SELV / PELV requirements
Design			
24 VDC or 42 VDC, COM	---	Plugs	
Terminal connection cross section of 24 VDC or 42 VDC Out 1 output			
Flexible and fine wire lines with wire tip sleeves	---	0.5 - 6 mm ²	
Approbation data UL/C-UL-US	---	22 - 10	
CSA	---	22 - 10	
Terminal connection cross section of 24 VDC or 42 VDC Out 2 output			
Flexible and fine wire lines with wire tip sleeves	---	0.2 - 2.5 mm ²	
Approbation data UL/C-UL-US	---	22 - 12	
CSA	---	22 - 12	

Table 67: Technical data - 8B0C control supply units 800W (cont.)

Technical data • 8B0C 800W auxiliary supply module

Product ID	8B0C0320HW00.000-1 8B0C0320HC00.000-1	8B0C0320HW00.002-1 8B0C0320HC00.002-1	8B0C0160HW00.A01-1 8B0C0160HC00.A01-1
24 VDC or 42 VDC Out 1 control input			
Wiring	---		Sink
Electrical isolation Input - 24 VDC or 42 VDC	---		Yes
Modulation compared to ground potential	---		Max. ± 50 V
Input voltage Rated Maximum	---		24 VDC 30 VDC
Switching threshold LOW (24 VDC or 42 VDC Out 1 is switched on) HIGH (24 VDC or 42 VDC Out 1 is switched off)	---		< 5 V > 15 V
Input current at rated voltage	---		Approx. 10 mA
Switching delay ON (24 VDC or 42 VDC Out 1 is switched on) OFF (24 VDC or 42 VDC Out 1 is switched off) ²⁾	---		Max. 25 ms Max. 0.25 ms
Design	---		Plugs
Terminal connection cross section of 24 VDC or 42 VDC Out 1 control input Flexible and fine wire lines with wire tip sleeves Approbation data UL/C-UL-US CSA	---		0.2 - 2.5 mm ² 30 - 12 22 - 12
Operational conditions			
Permitted mounting orientations Hanging vertically Lying horizontally Standing horizontally			Yes Yes No
Ambient temperature during operation Max. ambient temperature			5 to 40°C +55°C
Relative humidity during operation			5 to 85%, non-condensing
Installation at altitudes above sea level Maximum installation altitude ³⁾			0 to 500 m 4,000 m
Degree of pollution according to EN 60664-1			2 (non-conductive material)
Overvoltage cat. according to IEC 60364-4-443:1999			III
EN 60529 protection			IP20

Table 67: Technical data - 8B0C control supply units 800W (cont.)

Technical data • 8B0C 800W auxiliary supply module

Technical data • 8B0C 800W auxiliary supply module			
Product ID			
Wall mounting	8B0C0320HW00.000-1	8B0C0320HW00.002-1	8B0C0160HW00.A01-1
Cold plate or feed-through mounting	8B0C0320HC00.000-1	8B0C0320HC00.002-1	8B0C0160HC00.A01-1
Storage and transport conditions			
Storage temperature	-25 to +55°C		
Relative humidity during storage	5 to 95%, non-condensing		
Transport temperature	-25 to +70°C		
Relative humidity during transport	Max. 95% at +40°C		
Mechanical characteristics			
Dimensions ⁴⁾			
Width	53 mm		
Height	317 mm		
Depth			
Wall mounting	263 mm		
Cold-plate	212 mm		
Feed-through mounting	209 mm		
Weight			
Wall mounting	Approx. 3 kg	Approx. 3.2 kg	Approx. 3.2 kg
Cold-plate	Approx. 2.5 kg	Approx. 2.6 kg	Approx. 2.6 kg
Feed-through mounting	Approx. 2.5 kg	Approx. 2.6 kg	Approx. 2.6 kg

Table 67: Technical data - 8B0C control supply units 800W (cont.)

- 1) Valid in the following conditions: DC bus voltage 750 VDC, 55°C ambient temperature, installation altitudes < 500 m above sea level, no derating dependent on cooling type.
- 2) The output and any connected loads are not actively discharged when switching off.
- 3) Continuous operation at altitudes ranging from 500 m to 4,000 m above sea level is possible (taking the continuous power reductions listed into consideration). Additional requirements are to be arranged with B&R.
- 4) The dimensions refer to the true device dimensions including the respective mounting plate. Make sure to leave additional space above and below the device for mounting, connections and air circulation (see section 4 "Dimension diagrams and installation dimensions", on page 264).

13. 8B0C 800W auxiliary supply modules with 24V In

13.1 General information

8B0C0320Hx00.00A-1 ACOPOSmulti auxiliary supply modules provide an internal 24 VDC supply to ACOPOSmulti drive systems.

Additionally, the user is also provided with two 24 VDC outputs (one of which switchable) and one input for supplying 24VDC via an external voltage source (e.g. UPS).

Warning!

8B0C auxiliary supply modules are components of and may only be used in connection with the ACOPOSmulti drive system.

Information:

Up to five auxiliary supply modules with any power rating can be set up in parallel.

Limitation:

If 8B0C0320Hx00.00A-1 auxiliary supply modules are connected in parallel, then the total output power cannot exceed 80% of the total output power of the 8B0C0320Hx00.00A-1 units connected in parallel.

Area of application

ACOPOSmulti drive systems detect a power failure and are able to initiate immediate shutdown of the connected motors.

The brake energy that occurs when braking is returned to the DC bus and the auxiliary supply module can use it to create the 24 VDC supply voltage for the ACOPOSmulti drive system. This provides the ACOPOSmulti drive system as well as any connected encoders and sensors, control and visualization systems and any present safety system with 24 VDC during the braking procedure.

There are applications, in which the braking energy is not sufficient for supplying 24 VDC up until the motors have come to a stop or in which the 24 VDC supply is still required for a short time after the motors have come to a stop for properly shutting down any connected control and visualization systems or saving data from the ACOPOSmulti drive system.

In these cases, an external 24 VDC source (e.g. UPS), connected to the ACOPOSmulti 8B0C0320Hx00.00A-1 auxiliary supply module input, ensures a sufficient 24 VDC supply to the ACOPOSmulti drive system and any connected external 24 VDC consumers for a sufficient amount of time. ¹⁾

The ACOPOSmulti 8B0C0320Hx00.00A-1 auxiliary supply module also makes it possible to operate ACOPOSmulti drive systems using just an external 24 VDC supply without having to supply the DC bus. This provides an easy way to start up individual system components.

¹⁾ B&R recommends deactivating any 24 VDC consumers that are not necessary. This can be done using the switchable 24 VDC output on the auxiliary supply module.

13.2 Order data


Model number	Short description	Figure
	Wall mounting	
8B0C0320HW00.00A-1	ACOPOSMulti auxiliary supply module, 32 A, HV, wall mounting, 24VIn 1x 30 A, 24VOut 1x 30 A, 1x 5 A	
	Cold plate or feed-through mounting	
8B0C0320HC00.00A-1	ACOPOSMulti auxiliary supply module, 32 A, HV, cold-plate or feed-through mounting, 24VIn 1x 30 A, 24VOut 1x 30 A, 1x 5 A	
		8B0C0320HC00.00A-1

Table 68: Order data - 8B0C 800W auxiliary supply module with 24V In

Required accessories				
Model number	Amount	Short description	Comment	Page
8BZ0C032000.00A-1A	1	Screw clamp set for ACOPOSMulti 8B0C0320Hx00.00A-1 modules: 1x 8TB3104.201M-10, 1x 8TB2104.2010-00, 1x 8TB2106.2010-00	---	---

Table 69: Required accessories - 8B0C 800W auxiliary supply module with 24V In

Optional accessories				
Model number	Amount	Short description	Comment	Page
8TB2106.2010-00	1	Screw clamp, 6-pin, single-row, spacing: 5.08 mm, Label 1: numbered serially	Plug for X1 connection	---
8TB2104.2010-00	1	Screw clamp, 4-pin, single-row, spacing: 5.08 mm, Label 1: numbered serially	Plug for X2 connection	---
8TB3104.201M-10	1	Screw clamp, 4-pin, single-row, spacing: 7.62 mm, Label 1: numbered serially, M coding: 1011	Plug for X3 connection	---
8BXF001.0000-00	1	ACOPOSMulti fan module Replacement fan for ACOPOSMulti modules (8BxP/8B0C/8BVI/8BVE/8B0K)	Replacement fan for ACOPOSMulti modules (8BxP/8B0C/8BVI/8BVE/8B0K)	---

Table 70: Optional accessories - 8B0C 800W auxiliary supply module with 24V In

13.3 Technical data

Product ID	
Wall mounting Cold plate or feed-through mounting	8B0C0320HW00.00A-1 8B0C0320HC00.00A-1
General information	
C-UL-US listed	Yes
Available cooling and mounting methods Wall mounting Cold plate or feed-through mounting	Yes Yes
Module width	1
DC bus connection	
Voltage Operating range in continuous operation Full continuous power	750 VDC 260 - 900 VDC 315 - 900 VDC
Continuous power consumption	Max. 880 W
Power loss with continuous power	80 W
DC bus capacitance	220 nF
Design	ACOPOSmulti backplane
24 VDC output	
Continuous power ¹⁾	800 W
Output voltage DC bus voltage 260 ... 315 VDC DC bus voltage 315 ... 900 VDC	25 VDC * (DC bus voltage / 315) 24 VDC ±6%
Continuous current Normal mode (via DC bus) Supply mode (via +24 Vin)	32 ADC 30 ADC
Reduction of continuous power according to ambient temperature above 40°C	No reduction
Reduction of continuous power depending on installation altitude Starting at 500 m above sea level	80 W per 1,000 m
Reduction of continuous power depending on cooling method Wall mounting Cold plate or feed-through mounting	In preparation In preparation
Startup delay	Max. 1 sec.
Startup time	Approx. 5 - 20 ms
Residual ripple	Typ. 50 mV _{SS}

Table 71: Technical data - 8B0C 800W auxiliary supply modules with 24V In

Technical data • 8B0C 800W auxiliary supply modules with 24V In

Product ID	
Wall mounting	8B0C0320HW00.00A-1
Cold plate or feed-through mounting	8B0C0320HC00.00A-1
24 VDC internal system supply voltage	
Output voltage	25 VDC ±1.6%
Peak current (< 4 s) DC bus voltage (U _{DC}): 350 ... 900 VDC	42 ADC
Protective measures	
Open circuit protection	Yes
Overload protection	Yes
Short circuit protection	Yes
Feedback protection	Max. 26 VDC (also when turned off)
Over-temperature protection	Yes
Dielectric strength to ground	±50 VDC
Output / input isolation	SELV / PELV requirements
Design	ACOPOSMulti backplane
24 VDC Out	
Output voltage	
DC bus voltage 260 ... 315 VDC	25 VDC * (DC bus voltage / 315)
DC bus voltage 315 ... 900 VDC	24 VDC ±6%
Peak current (< 4 s) over the total operating range of the DC bus voltage	---
Protection of 24 VDC Out 1 output	30 A (slow-blow) electronic, automatic reset
Protection of 24 VDC Out 2 output	5 A (slow-blow) electronic, automatic reset (via PTC)
Protective measures	
Open circuit protection	Yes
Overload protection	Yes
Short circuit protection	Yes
Feedback protection	Max. 35 VDC (also when turned off)
Over-temperature protection	Yes
Dielectric strength to ground	±50 VDC
Output / input isolation	SELV / PELV requirements
Design	
24 VDC, COM	Plugs
Terminal connection cross section of the 24 VDC Out 1 output	
Flexible and fine wire lines with wire tip sleeves	0.5 - 6 mm ²
Approbation data	
UL/C-UL-US	22 - 10
CSA	22 - 10
Terminal connection cross section of the 24 VDC Out 2 output	
Flexible and fine wire lines with wire tip sleeves	0.2 - 2.5 mm ²
Approbation data	
UL/C-UL-US	22 - 12
CSA	22 - 12

Table 71: Technical data - 8B0C 800W auxiliary supply modules with 24V In (cont.)

Technical data • 8B0C 800W auxiliary supply modules with 24V In

Product ID	
Wall mounting Cold plate or feed-through mounting	8B0C0320HW00.00A-1 8B0C0320HC00.00A-1
24 VDC Out 1 controller input	
Wiring	Sink
Electrical isolation Input - 24 VDC	Yes
Modulation compared to ground potential	Max. ± 50 V
Input voltage Rated Maximum	24 VDC 30 VDC
Switching threshold LOW (24 VDC Out 1 is switched on) HIGH (24 VDC Out 1 is switched off)	< 5 V > 15 V
Input current at rated voltage	Approx. 10 mA
Switching delay ON (24 VDC Out 1 is switched on) OFF (24 VDC Out 1 is switched off) ²⁾	Max. 25 ms Max. 0.25 ms
Design	Plugs
Terminal connection cross sections Flexible and fine wire lines with wire tip sleeves Approval data UL/C-UL-US CSA	0.2 - 2.5 mm ² 30 - 12 22 - 12
24 VDC In	
Input voltage ³⁾ minimum Rated Maximum	23 VDC 24 VDC 26 VDC
Voltage drop between input and internal 24 VDC system voltage supply	< 0.5 V
Switch-on threshold	+24 VDC internal system supply voltage < 21.5 VDC
Maximum continuous current	30 A
Switching delay When switching to supply mode When starting up via 24 Vin	Typ. 5 ms Typ. 2 s
Indicators	24Vi LED ERRi LED
Under-voltage detection	Yes (< 20 VDC)
Over-voltage detection	Yes (> 26 VDC)
Protective measures Open circuit protection Overload protection Short circuit protection Over-temperature protection	Yes Yes, ticker operation when overload ($T_{ON} = 1$ s, $T_{OFF} = 2.4$ s) Yes Yes
Design 24 VDC In, COM	Plugs

Table 71: Technical data - 8B0C 800W auxiliary supply modules with 24V In (cont.)

Technical data • 8B0C 800W auxiliary supply modules with 24V In

Product ID	
Wall mounting Cold plate or feed-through mounting	8B0C0320HW00.00A-1 8B0C0320HC00.00A-1
Terminal connection cross section of the input "24 VDC In"	
Flexible and fine wire lines with wire tip sleeves	0.5 - 6 mm ²
Approbation data	
UL/C-UL-US	22 - 10
CSA	22 - 10
Operational conditions	
Permitted mounting orientations	
Hanging vertically	Yes
Lying horizontally	Yes
Standing horizontally	No
Ambient temperature during operation	5 to 40°C
Max. ambient temperature	+55°C
Relative humidity during operation	5 to 85%, non-condensing
Installation at altitudes above sea level	0 to 500 m
Maximum installation altitude ⁴⁾	4,000 m
Degree of pollution according to EN 60664-1	2 (non-conductive material)
Overvoltage cat. according to IEC 60364-4-443:1999	III
EN 60529 protection	IP20
Storage and transport conditions	
Storage temperature	-25 to +55°C
Relative humidity during storage	5 to 95%, non-condensing
Transport temperature	-25 to +70°C
Relative humidity during transport	Max. 95% at +40°C
Mechanical characteristics	
Dimensions ⁵⁾	
Width	53 mm
Height	317 mm
Depth	
Wall mounting	263 mm
Cold-plate	212 mm
Feed-through mounting	209 mm
Weight	
Wall mounting	Approx. 3.3 kg
Cold-plate	Approx. 2.9 kg
Feed-through mounting	Approx. 2.9 kg

Table 71: Technical data - 8B0C 800W auxiliary supply modules with 24V In (cont.)

- 1) Valid in the following conditions: DC bus voltage 750 VDC, 55°C ambient temperature, installation altitudes < 500 m above sea level, no derating dependent on cooling type.
- 2) The output and any connected loads are not actively discharged when switching off.
- 3) The module's +24 Vin input is resistant to damage in a voltage range from -32 VDC to +32 VDC.
- 4) Continuous operation at altitudes ranging from 500 m to 4,000 m above sea level is possible (taking the continuous power reductions listed into consideration). Additional requirements are to be arranged with B&R.
- 5) The dimensions refer to the true device dimensions including the respective mounting plate. Make sure to leave additional space above and below the device for mounting, connections and air circulation (see section 4 "Dimension diagrams and installation dimensions", on page 264).

14. Inverter modules 8BVI 1.4kW ... 11kW (single-axis modules)

14.1 Order data


Model number	Short description	Figure
	Wall mounting	 <p>8BVI0055HCS0.000-1</p>
8BVI0014HWS0.000-1	ACOPOSMulti inverter module, 1.9 A, HV, wall-mounting	
8BVI0028HWS0.000-1	ACOPOSMulti inverter module, 3.8 A, HV, wall-mounting	
8BVI0055HWS0.000-1	ACOPOSMulti inverter module, 7.6 A, HV, wall-mounting	
8BVI0110HWS0.000-1	ACOPOSMulti inverter module, 15.1 A, HV, wall-mounting	
	Cold plate or feed-through mounting	
8BVI0014HCS0.000-1	ACOPOSMulti inverter module, 1.9 A, HV, cold plate or feed-through mounting	
8BVI0028HCS0.000-1	ACOPOSMulti inverter module, 3.8 A, HV, cold plate or feed-through mounting	
8BVI0055HCS0.000-1	ACOPOSMulti inverter module, 7.6 A, HV, cold plate or feed-through mounting	
8BVI0110HCS0.000-1	ACOPOSMulti inverter module, 15.1 A, HV, cold plate or feed-through mounting	

Table 72: Order data - 8BVI inverter modules 1.4kW ... 11kW (single-axis modules)

Required accessories				
Model number	Amount	Short description	Comment	Page
8BZVI0055S0.000-1A	1	Screw clamp set for ACOPOSMulti Modules 8BVI00xxHxS0: 1x 8TB3104.204G-00, 1x 8TB2104.203L-00, 1x 8TB2106.2010-00, 1x 8TB2108.2010-00	---	---
8BZVI0110S0.000-1A	1	Screw clamp set for ACOPOSMulti Modules 8BVI0110HxS0: 1x 8TB3104.204G-00, 1x 8TB2104.203L-00, 1x 8TB2106.2010-00, 1x 8TB2108.2010-00	---	---

Table 73: Required accessories for 8BVI inverter modules 1.4kW ... 11kW (single-axis modules)

Optional accessories				
Model number	Amount	Short description	Comment	Page
8BAC0120.000-1	Max. 2	ACOPOSMulti plug-in module, EnDat 2.1 interface	---	166
8BAC0120.001-2	Max. 2	ACOPOSMulti plug-in module, EnDat 2.2 interface	---	170
8BAC0122.000-1	Max. 2	ACOPOSMulti plug-in module, Resolver interface 10 kHz	---	178
8BAC0123.000-1	Max. 2	ACOPOSMulti plug-in module, Incremental encoder and SSI absolute encoder interface for RS422 signals	---	182

Table 74: Optional accessories for 8BVI inverter modules 1.4kW ... 11kW (single-axis modules)

Technical data • Inverter modules 8BVI 1.4kW ... 11kW (single-axis modules)

Optional accessories				
Model number	Amount	Short description	Comment	Page
8BAC0123.001-1	Max. 2	ACOPOSMulti plug-in module, Incremental encoder interface for 5 V single-ended and 5 V differential signals	---	188
8BAC0123.002-1	Max. 2	ACOPOSMulti plug-in module, Incremental encoder interface for 24 V single-ended and 24 V differential signals	---	193
8BAC0124.000-1	Max. 2	ACOPOSMulti plug-in module, SinCos interface	---	198
8BAC0130.000-1	Max. 1	ACOPOSMulti plug-in module, 2 digital outputs, 50 mA, max. 62.5 kHz, 2 digital outputs, 500 mA, max. 1.25 kHz, 2 digital inputs - 24 VDC	only SLOT 2	202
8BAC0130.001-1	Max. 1	ACOPOSMulti plug-in module, 2 digital outputs, 50 mA, max. 62.5 kHz, 4 digital outputs, 500 mA, max. 1.25 kHz,	only SLOT 2	206
8BAC0132.000-1	Max. 2	ACOPOSMulti plug-in module, 4 analog inputs ± 10 V	---	209
8SCS005.0000-00	Up to 2	ACOPOSMulti shield component set: 1 slot cover shield sheet	Shield sheet for covering free plug-in module slots	---
8SCS002.0000-00	1	ACOPOSMulti shield component set: 1 clamping plate; 2 clamps D 4-13.5 mm; 4 screws	Shield component set for I/O cable with a cable diameter of 4 - 13.5 mm	---
8SCS000.0000-00	1	ACOPOSMulti shield component set: 1 shield plate 1x type 0; 1 hose clamp, W 9 mm, D 12-22 mm	Shield component set for motor cables with a cable diameter of 12 - 22 mm	---
8SCS009.0000-00	1	ACOPOSMulti shield component set: 1 ACOPOSMulti holding plate SK8-14 1 shield terminal SK14	Shield component set for motor cables with a cable diameter of up to 14 mm	---
8BXF001.0000-00	---	ACOPOSMulti fan module Replacement fan for ACOPOSMulti modules (8BxP/8B0C/8BVI/8BVE/8B0K)	Replacement fan for ACOPOSMulti modules (8BxP/8B0C/8BVI/8BVE/8B0K)	---
8TB2106.2010-00	1	Screw clamp, 6-pin, single-row, spacing: 5.08 mm, Label 1: numbered serially	Plug for X1 connection	---
8TB2108.2010-00	1	Screw clamp, 8-pin, single-row, spacing: 5.08 mm, Label 1: numbered serially	Plug for X2 connection	---
8TB2104.203L-00	1	Screw clamp, 4-pin, single-row, spacing: 5.08 mm, Label 3: T- T+ B- B+, Coding L: 1010	Plug for X4A connection	---
8TB3104.204G-00	1	Screw clamp, 4-pin, single-row, spacing: 7.62 mm, Label 4: PE W V U, Coding G: 0110	Plug for X5A connection	---

Table 74: Optional accessories for 8BVI inverter modules 1.4kW ... 11kW (single-axis modules) (cont.)

14.2 Technical data

Product ID	8BVI0014HWS0.000-1 8BVI0014HCS0.000-1	8BVI0028HWS0.000-1 8BVI0028HCS0.000-1	8BVI0055HWS0.000-1 8BVI0055HCS0.000-1	8BVI0110HWS0.000-1 8BVI0110HCS0.000-1
Wall mounting Cold plate or feed-through mounting				
General information				
C-UL-US listed	Yes			
Available cooling and mounting methods Wall mounting Cold plate or feed-through mounting	Yes Yes			
Module width	1			
DC bus				
Voltage Max.	750 VDC 900 VDC			
Continuous power consumption ¹⁾	1.46 kW	2.87 kW	5.6 kW	11.2 kW
Power loss depending on the switching frequency ²⁾ Switching frequency 5 kHz Switching frequency 10 kHz Switching frequency 20 kHz	(0.6*I _M ² +1.3*I _M +60) W (0.97*I _M ² +0.5*I _M +110) W (1.7*I _M ² -0.7*I _M +225) W			(0.16*I _M ² +5.6*I _M +55) W (0.49*I _M ² +4.7*I _M +95) W (0.87*I _M ² -1.0*I _M +200) W
DC bus capacitance	165 µF			330 µF
Design	ACOPOSMulti backplane			
24 VDC supply				
Input voltage	25 VDC ±1.6%			
Input capacitance	23.5 µF			
Max. power consumption	12 W + P _{24 V Out} (0 ... 10 W) ³⁾ + P _{holding brake} + P _{fan8B0M...} ⁴⁾			
Design	ACOPOSMulti backplane			
Motor connections				
Amount	1			
Continuous power per motor connection ¹⁾	1.4 kW	2.8 kW	5.5 kW	11 kW
Continuous current per motor connection ¹⁾	1.9 A _{eff}	3.8 A _{eff}	7.6 A _{eff}	15.1 A _{eff}
Reduction of continuous current depending on switching frequency and cooling method ⁵⁾ Switching frequency 20 kHz Wall mounting ⁶⁾ Cold-plate installation ⁷⁾ Feed-through mounting Switching frequency 10 kHz Wall mounting ⁶⁾ Cold-plate installation ⁷⁾ Feed-through mounting Switching frequency 5 kHz Wall mounting ⁶⁾ Cold-plate installation ⁷⁾ Feed-through mounting	0.11 A/K (from 33°C) 0.13 A/K (from 46°C) In preparation No reduction No reduction In preparation No reduction No reduction In preparation	0.12 A/K (from 33°C) 0.1 A/K (from 34°C) In preparation No reduction 0.6 A/K (from 58°C) In preparation No reduction No reduction In preparation	0.13 A/K (from 4°C) ⁸⁾ 0.14 A/K (from 5°C) ⁹⁾ In preparation 0.2 A/K (from 49°C) 0.28 A/K (from 46°C) In preparation No reduction 0.65 A/K (from 57°C) In preparation	0.15 A/K (from -28°C) ⁸⁾ 0.18 A/K (from -13°C) ⁹⁾ In preparation 0.26 A/K (from 33°C) 0.32 A/K (from 35°C) In preparation No reduction 0.73 A/K (from 55°C) In preparation

Table 75: Technical data - 8BVI inverter modules 1.4kW ... 11kW (single-axis modules)

Technical data • Inverter modules 8BVI 1.4kW ... 11kW (single-axis modules)

Product ID	8BVI0014HWS0.000-1 8BVI0014HCS0.000-1	8BVI0028HWS0.000-1 8BVI0028HCS0.000-1	8BVI0055HWS0.000-1 8BVI0055HCS0.000-1	8BVI0110HWS0.000-1 8BVI0110HCS0.000-1
Reduction of continuous power depending on altitude Starting at 500 m above sea level	0.19 A _{eff} per 1,000 m	0.38 A _{eff} per 1,000 m	0.76 A _{eff} per 1,000 m	1.51 A _{eff} per 1,000 m
Peak current	4.7 A _{eff}	9.5 A _{eff}	18.9 A _{eff}	37.7 A _{eff}
Rated switching frequency	5 kHz			
Possible switching frequencies ¹⁰⁾	5 / 10 / 20 kHz			
Electrical stress of the connected motor according to IEC TS 60034-25	Limit value curve A			
Protective measures Overload protection Short circuit and ground fault	Yes Yes			
Maximum motor line length depending on the switching frequency ¹¹⁾ Switching frequency 5 kHz Switching frequency 10 kHz Switching frequency 20 kHz	25 m 25 m 10 m			
Design U, V, W, PE Shield connection	Plugs Yes			
Terminal connection cross sections Flexible and fine wire lines with wire tip sleeves Approbation data UL/C-UL-US CSA	0.25 - 4 mm ² 30 - 10 28 - 10			
Terminal cable outer-cross-section dimension of the shield connection	12 - 22 mm			
Motor holding brake connections				
Amount	1			
Output voltage ¹²⁾	24 VDC +5.8% / -0% ¹³⁾			
Continuous current	1.1 A			2.1 A
Max. internal resistance	0.5 Ω			0.3 Ω
Extinction potential	Approx. 30 V			
Max. extinction energy per switching operation	1.5 Ws			3 Ws
Max. switching frequency	0.5 Hz			
Protective measures Overload and short circuit protection Cable breakage monitoring Undervoltage monitoring	Yes Yes Yes			
Response threshold for cable breakage monitoring	Approx. 0.25 A			Approx. 0.5 A
Response threshold for undervoltage monitoring	24 VDC +0% / -4%			

Table 75: Technical data - 8BVI inverter modules 1.4kW ... 11kW (single-axis modules) (cont.)

Technical data • Inverter modules 8BVI 1.4kW ... 11kW (single-axis modules)

Product ID	8BVI0014HWS0.000-1 8BVI0014HCS0.000-1	8BVI0028HWS0.000-1 8BVI0028HCS0.000-1	8BVI0055HWS0.000-1 8BVI0055HCS0.000-1	8BVI0110HWS0.000-1 8BVI0110HCS0.000-1
Wall mounting Cold plate or feed-through mounting				
Trigger inputs				
Amount	2			
Wiring	Sink			
Electrical isolation Input - inverter module Input - Input	Yes Yes			
Input voltage Rated Maximum	24 VDC 30 VDC			
Switching threshold LOW HIGH	< 5 V >15 V			
Input current at rated voltage	Approx. 10 mA			
Switching delay Positive edge Negative edge	52 μ s \pm 0.5 μ s (digitally filtered) 53 μ s \pm 0.5 μ s (digitally filtered)			
Modulation compared to ground potential	Max. \pm 38 V			
24 V Out				
Amount	2			
Output voltage DC bus voltage 260 ... 315 VDC DC bus voltage 315 ... 900 VDC	25 VDC * (DC bus voltage / 315) 24 VDC \pm 6%			
Fuse protection	500 mA (slow-blow) electronic, automatic reset			
Enable inputs				
Amount	2			
Wiring	Sink			
Electrical isolation Input - inverter module Input - Input	Yes Yes			
Input voltage Rated Maximum	24 VDC 30 VDC			
Switching threshold LOW HIGH	< 5 V >15 V			
Input current at rated voltage	Approx. 30 mA			
Switching delay @ 24 VDC Enable 1 -> 0, PWM off Enable 0 -> 1, Ready for PWM	Max. 20.5 ms Max. 100 μ s			
Modulation compared to ground potential	Max. \pm 38 V			

Table 75: Technical data - 8BVI inverter modules 1.4kW ... 11kW (single-axis modules) (cont.)

Technical data • Inverter modules 8BVI 1.4kW ... 11kW (single-axis modules)

Product ID				
Wall mounting	8BVI0014HWS0.000-1	8BVI0028HWS0.000-1	8BVI0055HWS0.000-1	8BVI0110HWS0.000-1
Cold plate or feed-through mounting	8BVI0014HCS0.000-1	8BVI0028HCS0.000-1	8BVI0055HCS0.000-1	8BVI0110HCS0.000-1
Operational conditions				
Permitted mounting orientations				
Hanging vertically	Yes			
Lying horizontally	Yes			
Standing horizontally	No			
Ambient temperature during operation	5 to 40°C			
Max. ambient temperature ¹⁴⁾	+55°C			
Relative humidity during operation	5 to 85%, non-condensing			
Installation at altitudes above sea level	0 to 500 m			
Maximum installation altitude ¹⁵⁾	4,000 m			
Degree of pollution according to EN 60664-1	2 (non-conductive material)			
Overvoltage cat. according to IEC 60364-4-443:1999	III			
EN 60529 protection	IP20			
Storage and transport conditions				
Storage temperature	-25 to +55°C			
Relative humidity during storage	5 to 95%, non-condensing			
Transport temperature	-25 to +70°C			
Relative humidity during transport	Max. 95% at +40°C			
Mechanical characteristics				
Dimensions ¹⁶⁾				
Width	53 mm			
Height	317 mm			
Depth				
Wall mounting	263 mm			
Cold-plate	212 mm			
Feed-through mounting	209 mm			
Weight				
Wall mounting	Approx. 2.6 kg	Approx. 2.6 kg	Approx. 2.7 kg	Approx. 2.9 kg
Cold-plate	Approx. 2.1 kg	Approx. 2.1 kg	Approx. 2.2 kg	Approx. 2.4 kg
Feed-through mounting	Approx. 2.1 kg	Approx. 2.1 kg	Approx. 2.2 kg	Approx. 2.4 kg

Table 75: Technical data - 8BVI inverter modules 1.4kW ... 11kW (single-axis modules) (cont.)

- 1) Valid in the following conditions: DC bus voltage 750 VDC, switching frequency 5 kHz, 40°C ambient temperature, installation altitudes < 500 m above sea level, no derating dependent on cooling type.
- 2) I_M ... Current on the motor connection [A].
- 3) The power consumption $P_{24V\ Out}$ corresponds to the power that is output on the module's X2 / +24 V Out 1 and X2 / +24 V Out 2 connections (max. 10 W).
- 4) The power consumption $P_{Fan8BOM...}$ corresponds to the portion of the power that is used by the fan modules in the mounting plate / by the 8BOM0040HFF0.000-1 fan module and can be found in the technical data for the respective 8BOM... mounting plate.
- 5) Valid in the following conditions: DC bus voltage 750 VDC, minimum permissible coolant flow volume (3 l/min). The nominal switching frequency values for the respective ACOPOSmulti inverter module are marked in bold.
- 6) The temperature specifications are based on the ambient temperature.
- 7) The temperature specifications are based on the return temperature of the cold plate mounting plate.
- 8) The module cannot supply the full continuous current at this switching frequency. This unusual value for the ambient temperature, at which a derating of the continuous current must be accounted for, ensures that the derating of the continuous current can be determined in the same manner as at other switching frequencies.

- 9) The module cannot supply the full continuous current at this switching frequency. This unusual value for the return temperature, at which a derating of the continuous current must be accounted for, ensures that the derating of the continuous current can be determined in the same manner as at other switching frequencies.

Caution! Condensation can occur at low flow-temperatures and low return-temperatures. The designs in the section "Condensation", on page 362 must be taken into consideration!

- 10) B&R recommends operating the module at nominal switching frequency. Operating the module at a higher switching frequency for application-specific reasons reduces the continuous current and increases the CPU load. When using double-axis modules, the increased CPU load causes a reduction of the functional range in the drive; if this is not taken into consideration then it can cause the computing time to be exceeded in extreme cases.
- 11) To avoid exceeding the EMC limit values, the maximum motor cable length per motor connection is reduced at switching frequencies > 10 kHz.

Information:

When using two motor cables that are connected in parallel, the maximum permissible motor cable lengths are reduced by half.

The total length of all motor cables per backplane module is limited (see section 5 "8BVF line filter", on page 60).

- 12) During project development, it is necessary to check if the minimum voltage can be maintained on the holding brake with the specified wiring. The operating voltage range of the holding brake can be found in the user's manual for the respective motor.
- 13) The specified values is only valid under the following conditions:
- The 24 VDC supply for the module is provided by an 8B0C auxiliary supply module, which is installed on the same mounting plate
 - Connection between S1 and S2 (activation of the external holding brake) using a jumper with a length of max. 10 cm.
- If the 24 VDC supply for the module is applied to the mounting plate using an 8BVE expansion module, then the output voltage is reduced because of voltage drops on the expansion cable. In this case, undervoltage monitoring must be deactivated.
- If jumpers longer than 10 cm are used to connect S1 and S2, the output voltage is reduced because of voltage drops on the jumpers.
- 14) Continuous operation at ambient temperatures ranging from 40°C to max. 55°C is possible (taking the continuous current reductions listed into consideration), but results in a shorter lifespan.
- 15) Continuous operation at altitudes ranging from 500 m to 4,000 m above sea level is possible (taking the continuous current reductions listed into consideration). Additional requirements are to be arranged with B&R.
- 16) The dimensions refer to the true device dimensions including the respective mounting plate. Make sure to leave additional space above and below the device for mounting, connections and air circulation (see section 4 "Dimension diagrams and installation dimensions", on page 264).

14.2.1 POWERLINK station number settings

The POWERLINK station number can be set using two HEX code switches that are located behind the black cover of the module:

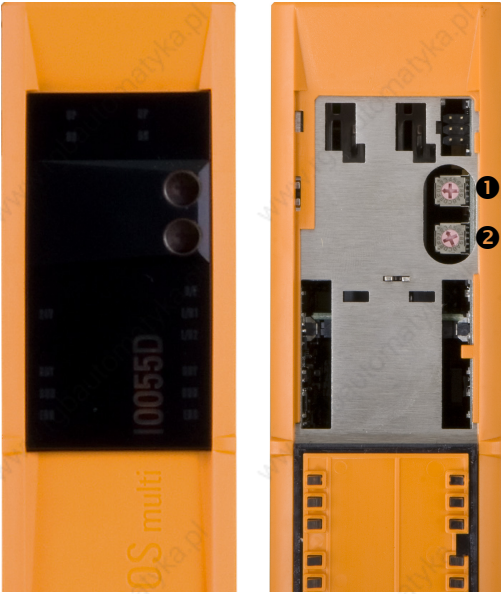
Figure	Code switch	POWERLINK station number
 <p data-bbox="209 919 299 938">Cover closed</p> <p data-bbox="481 919 572 938">Cover open</p>	<p data-bbox="733 295 748 315">❶</p>	<p data-bbox="917 295 1050 315">16s position (high)</p>
	<p data-bbox="733 334 748 354">❷</p>	<p data-bbox="924 334 1043 354">1s position (low)</p>
<p data-bbox="665 373 1127 418">The POWERLINK station number change takes effect the next time the ACOPOSmulti drive system is switched on.</p>		
<p data-bbox="665 425 796 457">Information:</p>		
<p data-bbox="665 464 1127 509">In principle, station numbers between \$01 and \$FD are permitted.</p>		
<p data-bbox="665 516 1127 574">However, station numbers between \$F0 and \$FD are reserved for future system expansions. For reasons of compatibility, we recommend avoiding these station numbers.</p>		
<p data-bbox="665 581 1127 626">Station numbers \$00, \$FE and \$FF are reserved and are therefore not allowed to be set.</p>		

Table 76: Setting the POWERLINK station number

15. 8BVI inverter modules 1.4kW ... 5.5kW (two-axis modules)

15.1 General information

Two-axis modules contain two complete standalone inverters in an inverter module.

15.2 Order data


Model number	Short description	Figure
		 <p>8BVI0014HCD0.000-1</p>
Wall mounting		
8BVI0014HWD0.000-1	ACOPOSMulti inverter module 1.9 A, HV, wall mounting, 2 axes	
8BVI0028HWD0.000-1	ACOPOSMulti inverter module 3.8 A, HV, wall mounting, 2 axes	
8BVI0055HWD0.000-1	ACOPOSMulti inverter module 7.6 A, HV, wall mounting, 2 axes	
Cold plate or feed-through mounting		
8BVI0014HCD0.000-1	ACOPOSMulti inverter module 1.9 A, HV, cold plate or feed-through mounting, 2 axes	
8BVI0028HCD0.000-1	ACOPOSMulti inverter module 3.8 A, HV, cold plate or feed-through mounting, 2 axes	
8BVI0055HCD0.000-1	ACOPOSMulti inverter module 7.6 A, HV, cold plate or feed-through mounting, 2 axes	

Table 77: Order data - 8BVI inverter modules 1.4kW ... 5.5kW (two-axis modules)

Required accessories				
Model number	Amount	Short description	Comment	Page
8BZVI0055D0.000-1A	1	Screw clamp set for ACOPOSMulti Modules 8BVI00xxHxD0: 1x 8TB2112.2010-00, 1x 8TB2108.2010-00, 1x 8TB2104.203L-00, 1x 8TB2104.203F-00, 1x 8TB3104.204G-00, 1x 8TB3104.204K-00	---	---

Table 78: Required accessories for 8BVI inverter modules 1.4kW ... 5.5kW (two-axis modules)

Technical data • 8BVI inverter modules 1.4kW ... 5.5kW (two-axis modules)

Optional accessories				
Model number	Amount	Short description	Comment	Page
8BAC0120.000-1	Max. 2	ACOPOSmulti plug-in module, EnDat 2.1 interface	---	166
8BAC0120.001-2	Max. 2	ACOPOSmulti plug-in module, EnDat 2.2 interface	---	170
8BAC0122.000-1	Max. 2	ACOPOSmulti plug-in module, Resolver interface 10 kHz	---	178
8BAC0123.000-1	Max. 2	ACOPOSmulti plug-in module, Incremental encoder and SSI absolute encoder interface for RS422 signals	---	182
8BAC0123.001-1	Max. 2	ACOPOSmulti plug-in module, Incremental encoder interface for 5 V single-ended and 5 V differential signals	---	188
8BAC0123.002-1	Max. 2	ACOPOSmulti plug-in module, Incremental encoder interface for 24 V single-ended and 24 V differential signals	---	193
8BAC0124.000-1	Max. 2	ACOPOSmulti plug-in module, SinCos interface	---	198
8BAC0130.000-1	Max. 1	ACOPOSmulti plug-in module, 2 digital outputs, 50 mA, max. 62.5 kHz, 2 digital outputs, 500 mA, max. 1.25 kHz, 2 digital inputs - 24 VDC	only SLOT 2	202
8BAC0130.001-1	Max. 1	ACOPOSmulti plug-in module, 2 digital outputs, 50 mA, max. 62.5 kHz, 4 digital outputs, 500 mA, max. 1.25 kHz,	only SLOT 2	206
8BAC0132.000-1	Max. 2	ACOPOSmulti plug-in module, 4 analog inputs ± 10 V	---	209
8SCS005.0000-00	Up to 2	ACOPOSmulti shield component set: 1 slot cover shield sheet	Shield sheet for covering free plug-in module slots	---
8SCS002.0000-00	1	ACOPOSmulti shield component set: 1 clamping plate; 2 clamps D 4-13.5 mm; 4 screws	Shield component set for I/O cable with a cable diameter of 4 - 13.5 mm	---
8SCS000.0000-00	Up to 2	ACOPOSmulti shield component set: 1 shield plate 1x type 0; 1 hose clamp, W 9 mm, D 12-22 mm	Shield component set for motor cables with a cable diameter of 12 - 22 mm	---
8SCS009.0000-00	Up to 2	ACOPOSmulti shield component set: 1 ACOPOSmulti holding plate SK8-14 1 shield terminal SK14	Shield component set for motor cables with a cable diameter of up to 14 mm	---
8BXF001.0000-00	---	ACOPOSmulti fan module Replacement fan for ACOPOSmulti modules (8BxP/8B0C/8BVI/8BVE/8B0K)	Replacement fan for ACOPOSmulti modules (8BxP/8B0C/8BVI/8BVE/8B0K)	---
8TB2112.2010-00	1	Screw clamp, 12-pin, single-row, spacing: 5.08 mm, Label 1: numbered serially	Plug for X1 connection	---
8TB2108.2010-00	1	Screw clamp, 8-pin, single-row, spacing: 5.08 mm, Label 1: numbered serially	Plug for X2 connection	---

Table 79: Optional accessories for 8BVI inverter modules 1.4kW ... 5.5kW (two-axis modules)

Technical data • 8BVI inverter modules 1.4kW ... 5.5kW (two-axis modules)

Optional accessories				
Model number	Amount	Short description	Comment	Page
8TB2104.203L-00	1	Screw clamp, 4-pin, single-row, spacing: 5.08 mm, Label 3: T- T+ B- B+, Coding L: 1010	Plug for X4A connection	---
8TB2104.203F-00	1	Screw clamp, 4-pin, single-row, spacing: 5.08 mm, Label 3: T- T+ B- B+, Coding F: 0101	Plug for X4B connection	---
8TB3104.204G-00	1	Screw clamp, 4-pin, single-row, spacing: 7.62 mm, Label 4: PE W V U, Coding G: 0110	Plug for X5A connection	---
8TB3104.204K-00	1	Screw clamp, 4-pin, single-row, spacing: 7.62 mm, Label 4: PE W V U, Coding K: 1001	Plug for X5B connection	---

Table 79: Optional accessories for 8BVI inverter modules 1.4kW ... 5.5kW (two-axis modules) (cont.)

15.3 Technical data

Product ID	8BVI0014HWD0.000-1 8BVI0014HCD0.000-1	8BVI0028HWD0.000-1 8BVI0028HCD0.000-1	8BVI0055HWD0.000-1 8BVI0055HCD0.000-1
General information			
C-UL-US listed	Yes		
Available cooling and mounting methods			
Wall mounting	Yes		
Cold plate or feed-through mounting	Yes		
Module width	1		
DC bus			
Voltage	750 VDC		
Max.	900 VDC		
Continuous power consumption ¹⁾	2.91 kW	5.73 kW	11.19 kW
Power loss depending on the switching frequency ²⁾			
Switching frequency 5 kHz	(1.2*I _M ² +2.62*I _M +100) W		
Switching frequency 10 kHz	(2.56*I _M ² +2.8*I _M +200) W		
Switching frequency 20 kHz	(6*I _M ² -9.4*I _M +430) W		
DC bus capacitance	165 µF		330 µF
Design	ACOPOSmulti backplane		
24 VDC supply			
Input voltage	25 VDC ±1.6%		
Input capacitance	23.5 µF		
Max. power consumption	16 W + P _{24 V Out} {0 ... 10 W} ³⁾ + P _{holding brake(s)}} + P _{fan8B0M...} ⁴⁾		
Design	ACOPOSmulti backplane		

Table 80: Technical data - 8BVI inverter modules 1.4kW ... 5.5kW (two-axis modules)

Technical data • 8BVI inverter modules 1.4kW ... 5.5kW (two-axis modules)

Product ID	8BVI0014HWD0.000-1 8BVI0014HCD0.000-1	8BVI0028HWD0.000-1 8BVI0028HCD0.000-1	8BVI0055HWD0.000-1 8BVI0055HCD0.000-1
Motor connections			
Amount	2		
Continuous power per motor connection ¹⁾	1.4 kW	2.8 kW	5.5 kW
Continuous current per motor connection ¹⁾	1.9 A _{eff}	3.8 A _{eff}	7.6 A _{eff}
Reduction of continuous current depending on switching frequency and cooling method ⁵⁾			
Switching frequency 20 kHz			
Wall mounting ⁶⁾	0.11 A/K (from 15°C)	0.12 A/K (from 13°C)	0.15 A/K (from -14°C) ⁸⁾
Cold-plate installation ⁷⁾	0.13 A/K (from 45°C)	0.12 A/K (from 34°C)	0.13 A/K (from 3°C) ⁹⁾
Feed-through mounting	In preparation	In preparation	In preparation
Switching frequency 10 kHz			
Wall mounting ⁶⁾	No reduction	No reduction	0.22 A/K (from 43°C)
Cold-plate installation ⁷⁾	No reduction	0.6 A/K (from 57°C)	0.28 A/K (from 43°C)
Feed-through mounting	In preparation	In preparation	In preparation
Switching frequency 5 kHz			
Wall mounting ⁶⁾	No reduction	No reduction	No reduction
Cold-plate installation ⁷⁾	No reduction	No reduction	0.72 A/K (from 56°C)
Feed-through mounting	In preparation	In preparation	In preparation
Reduction of continuous power depending on altitude			
Starting at 500 m above sea level	0.19 A _{eff} per 1,000 m	0.38 A _{eff} per 1,000 m	0.76 A _{eff} per 1,000 m
Peak current	4.7 A _{eff}	9.5 A _{eff}	18.9 A _{eff}
Rated switching frequency	5 kHz		
Possible switching frequencies ¹⁰⁾	5 / 10 / 20 kHz		
Electrical stress of the connected motor according to IEC TS 60034-25	Limit value curve A		
Protective measures			
Overload protection		Yes	
Short circuit and ground fault		Yes	
Maximum motor line length depending on the switching frequency ¹¹⁾			
Switching frequency 5 kHz		25 m	
Switching frequency 10 kHz		25 m	
Switching frequency 20 kHz		10 m	
Design			
U, V, W, PE		Plugs	
Shield connection		Yes	
Terminal connection cross sections			
Flexible and fine wire lines with wire tip sleeves		0.25 - 4 mm ²	
Approbation data			
UL/C-UL-US		30 - 10	
CSA		28 - 10	
Terminal cable outer-cross-section dimension of the shield connection	12 - 22 mm		

Table 80: Technical data - 8BVI inverter modules 1.4kW ... 5.5kW (two-axis modules) (cont.)

Technical data • 8BVI inverter modules 1.4kW ... 5.5kW (two-axis modules)

Product ID	8BVI0014HWD0.000-1 8BVI0014HCD0.000-1	8BVI0028HWD0.000-1 8BVI0028HCD0.000-1	8BVI0055HWD0.000-1 8BVI0055HCD0.000-1
Motor holding brake connections			
Amount	2		
Output voltage ¹²⁾	24 VDC +5.8% / +0% ¹³⁾		
Continuous current	1.1 A		
Max. internal resistance	0.5 Ω		
Extinction potential	Approx. 30 V		
Max. extinction energy per switching operation	1.5 Ws		
Max. switching frequency	0.5 Hz		
Protective measures			
Overload and short circuit protection	Yes		
Cable breakage monitoring	Yes		
Undervoltage monitoring	Yes		
Response threshold for cable breakage monitoring	Approx. 0.25 A		
Response threshold for undervoltage monitoring	24 VDC +0% / -4%		
Trigger inputs			
Amount	2		
Wiring	Sink		
Electrical isolation			
Input - inverter module	Yes		
Input - Input	Yes		
Input voltage			
Rated	24 VDC		
Maximum	30 VDC		
Switching threshold			
LOW	< 5 V		
HIGH	>15 V		
Input current at rated voltage	Approx. 10 mA		
Switching delay			
Positive edge	52 μs ± 0.5 μs (digitally filtered)		
Negative edge	53 μs ± 0.5 μs (digitally filtered)		
Modulation compared to ground potential	Max. ±38 V		
24 VDC Out			
Amount	2		
Output voltage			
DC bus voltage 260 ... 315 VDC	25 VDC * (DC bus voltage / 315)		
DC bus voltage 315 ... 900 VDC	24 VDC ±6%		
Fuse protection	500 mA (slow-blow) electronic, automatic reset		

Table 80: Technical data - 8BVI inverter modules 1.4kW ... 5.5kW (two-axis modules) (cont.)

Technical data • 8BVI inverter modules 1.4kW ... 5.5kW (two-axis modules)

Product ID	8BVI0014HWD0.000-1 8BVI0014HCD0.000-1	8BVI0028HWD0.000-1 8BVI0028HCD0.000-1	8BVI0055HWD0.000-1 8BVI0055HCD0.000-1
Wall mounting Cold plate or feed-through mounting			
Enable inputs			
Amount	4 (2 per axis)		
Wiring	Sink		
Electrical isolation			
Input - inverter module	Yes		
Input - Input	Yes		
Input voltage			
Rated	24 VDC		
Maximum	30 VDC		
Switching threshold			
LOW	< 5 V		
HIGH	>15 V		
Input current at rated voltage	Approx. 30 mA		
Switching delay @ 24 VDC			
Enable 1 -> 0, PWM off	Max. 20.5 ms		
Enable 0 -> 1, Ready for PWM	Max. 100 µs		
Modulation compared to ground potential	Max. ±38 V		
Operational conditions			
Permitted mounting orientations			
Hanging vertically	Yes		
Lying horizontally	Yes		
Standing horizontally	No		
Ambient temperature during operation	5 to 40°C		
Max. ambient temperature ¹⁴⁾	+55°C		
Relative humidity during operation	5 to 85%, non-condensing		
Installation at altitudes above sea level	0 to 500 m		
Maximum installation altitude ¹⁵⁾	4,000 m		
Degree of pollution according to EN 60664-1	2 (non-conductive material)		
Overvoltage cat. according to IEC 60364-4-443:1999	III		
EN 60529 protection	IP20		
Storage and transport conditions			
Storage temperature	-25 to +55°C		
Relative humidity during storage	5 to 95%, non-condensing		
Transport temperature	-25 to +70°C		
Relative humidity during transport	Max. 95% at +40°C		

Table 80: Technical data - 8BVI inverter modules 1.4kW ... 5.5kW (two-axis modules) (cont.)

Technical data • 8BVI inverter modules 1.4kW ... 5.5kW (two-axis modules)

Product ID	8BVI0014HWD0.000-1 8BVI0014HCD0.000-1	8BVI0028HWD0.000-1 8BVI0028HCD0.000-1	8BVI0055HWD0.000-1 8BVI0055HCD0.000-1
Wall mounting Cold plate or feed-through mounting			
Mechanical characteristics			
Dimensions ¹⁶⁾			
Width	53 mm		
Height	317 mm		
Depth			
Wall mounting	263 mm		
Cold-plate	212 mm		
Feed-through mounting	209 mm		
Weight			
Wall mounting	Approx. 2.8 kg		Approx. 2.9 kg
Cold-plate	Approx. 2.3 kg		Approx. 2.3 kg
Feed-through mounting	Approx. 2.3 kg		Approx. 2.3 kg

Table 80: Technical data - 8BVI inverter modules 1.4kW ... 5.5kW (two-axis modules) (cont.)

- Valid in the following conditions: DC bus voltage 750 VDC, switching frequency 5 kHz, 40°C ambient temperature, installation altitudes < 500 m above sea level, no derating dependent on cooling type.
- I_M ... Average value of the currents on both motor connectors [A].
- The power consumption $P_{24V_{Out}}$ corresponds to the power that is output on the module's X2 / +24 V Out 1 and X2 / +24 V Out 2 connections (max. 10 W).
- The power consumption $P_{Fan8BOM}$... corresponds to the portion of the power that is used by the fan modules in the mounting plate / by the 8B0M0040HFF0.000-1 fan module and can be found in the technical data for the respective 8B0M... mounting plate.
- Valid in the following conditions: DC bus voltage 750 VDC, minimum permissible coolant flow volume (3 l/min). The nominal switching frequency values for the respective ACOPOSmulti inverter module are marked in bold.
- The temperature specifications are based on the ambient temperature.
- The temperature specifications are based on the return temperature of the cold plate mounting plate.
- The module cannot supply the full continuous current at this switching frequency. This unusual value for the ambient temperature, at which a derating of the continuous current must be accounted for, ensures that the derating of the continuous current can be determined in the same manner as at other switching frequencies.
- The module cannot supply the full continuous current at this switching frequency. This unusual value for the return temperature, at which a derating of the continuous current must be accounted for, ensures that the derating of the continuous current can be determined in the same manner as at other switching frequencies.

Caution! Condensation can occur at low flow-temperatures and low return-temperatures. The designs in the section "Condensation", on page 362 must be taken into consideration!

- B&R recommends operating the module at nominal switching frequency. Operating the module at a higher switching frequency for application-specific reasons reduces the continuous current and increases the CPU load.
When using double-axis modules, the increased CPU load causes a reduction of the functional range in the drive; if this is not taken into consideration then it can cause the computing time to be exceeded in extreme cases.
- To avoid exceeding the EMC limit values, the maximum motor cable length per motor connection is reduced at switching frequencies > 10 kHz.

Information:

When using two motor cables that are connected in parallel, the maximum permissible motor cable lengths are reduced by half.

The total length of all motor cables per backplane module is limited (see section 5 "8BVF line filter", on page 60).

- During project development, it is necessary to check if the minimum voltage can be maintained on the holding brake with the specified wiring. The operating voltage range of the holding brake can be found in the user's manual for the respective motor.
- The specified values is only valid under the following conditions:
 - The 24 VDC supply for the module is provided by an 8B0C auxiliary supply module, which is installed on the same mounting plate
 - Connection between S1 and S2 (activation of the external holding brake) using a jumper with a length of max. 10 cm.

If the 24 VDC supply for the module is applied to the mounting plate using an 8BVE expansion module, then the output voltage is reduced because of voltage drops on the expansion cable. In this case, undervoltage monitoring must be deactivated.

If jumpers longer than 10 cm are used to connect S1 and S2 , the output voltage is reduced because of voltage drops on the jumpers.
- Continuous operation at ambient temperatures ranging from 40°C to max. 55°C is possible (taking the continuous current reductions listed into consideration), but results in a shorter lifespan.

Technical data • 8BVI inverter modules 1.4kW ... 5.5kW (two-axis modules)

- 15) Continuous operation at altitudes ranging from 500 m to 4,000 m above sea level is possible (taking the continuous current reductions listed into consideration). Additional requirements are to be arranged with B&R.
- 16) The dimensions refer to the true device dimensions including the respective mounting plate. Make sure to leave additional space above and below the device for mounting, connections and air circulation (see section 4 "Dimension diagrams and installation dimensions", on page 264).

15.3.1 POWERLINK station number settings

The POWERLINK station number can be set using two HEX code switches that are located behind the black cover of the module:

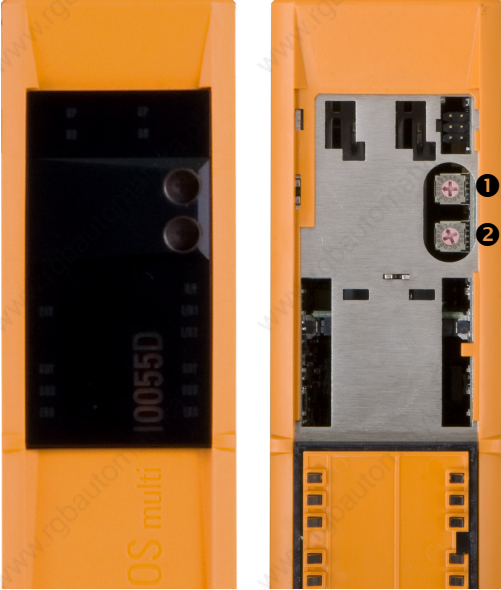
Figure	Code switch	POWERLINK station number
	❶	16s position (high)
	❷	1s position (low)
<p>The POWERLINK station number change takes effect the next time the ACOPOSmulti drive system is switched on.</p>		
<p>Information:</p> <p>In principle, station numbers between \$01 and \$FD are permitted. However, station numbers between \$F0 and \$FD are reserved for future system expansions. For reasons of compatibility, we recommend avoiding these station numbers.</p> <p>Station numbers \$00, \$FE and \$FF are reserved and are therefore not allowed to be set.</p>		
Cover closed	Cover open	

Table 81: Setting the POWERLINK station number

16. 8BVI inverter modules 16kW ... 32kW

16.1 Order data


Model number	Short description	Figure
	Wall mounting	 <p>8BVI0440HCS0.000-1</p>
8BVI0220HWS0.000-1	ACOPOSMulti inverter module, 22 A, HV, wall-mounting	
8BVI0330HWS0.000-1	ACOPOSMulti inverter module, 33 A, HV, wall-mounting	
8BVI0440HWS0.000-1	ACOPOSMulti inverter module, 44 A, HV, wall-mounting	
	Cold plate or feed-through mounting	
8BVI0220HCS0.000-1	ACOPOSMulti inverter module, 22 A, HV, cold plate or feed-through mounting	
8BVI0330HCS0.000-1	ACOPOSMulti inverter module, 33 A, HV, cold plate or feed-through mounting	
8BVI0440HCS0.000-1	ACOPOSMulti inverter module, 44 A, HV, cold plate or feed-through mounting	

Table 82: Order data - 8BVI inverter modules, 16kW ... 32kW

Required accessories				
Model number	Amount	Short description	Comment	Page
8BZVI0220S0.000-1A ¹⁾	1	Screw clamp set for ACOPOSMulti Modules 8BVI0220HxS0: 1x 8TB2106.2010-00, 1x 8TB2108.2010-00, 1x 8TB2104.203L-00, 1x 8TB4104.204G-00	---	---
8BZVI0440S0.000-1A ²⁾	1	Screw clamp set for ACOPOSMulti Modules 8BVI0440HxS0: 1x 8TB2106.2010-00, 1x 8TB2108.2010-00, 1x 8TB2104.203L-00, 1x 8TB4104.204G-10	---	---

Table 83: Required accessory - 8BVI inverter modules, 16kW ... 32kW

1) Only for 8BVI0220HxS0.000-1.

2) Only for 8BVI0330HxS0.000-1 and 8BVI0440HxS0.000-1.

Optional accessories				
Model number	Amount	Short description	Comment	Page
8BAC0120.000-1	Max. 2	ACOPOSMulti plug-in module, EnDat 2.1 interface	---	166
8BAC0120.001-2	Max. 2	ACOPOSMulti plug-in module, EnDat 2.2 interface	---	170
8BAC0122.000-1	Max. 2	ACOPOSMulti plug-in module, Resolver interface 10 kHz	---	178
8BAC0123.000-1	Max. 2	ACOPOSMulti plug-in module, Incremental encoder and SSI absolute encoder interface for RS422 signals	---	182

Table 84: Optional accessory - 8BVI inverter modules, 16kW ... 32kW

Technical data • 8BVI inverter modules 16kW ... 32kW

Optional accessories				
Model number	Amount	Short description	Comment	Page
8BAC0123.001-1	Max. 2	ACOPOSmulti plug-in module, Incremental encoder interface for 5 V single-ended and 5 V differential signals	---	188
8BAC0123.002-1	Max. 2	ACOPOSmulti plug-in module, Incremental encoder interface for 24 V single-ended and 24 V differential signals	---	193
8BAC0124.000-1	Max. 2	ACOPOSmulti plug-in module, SinCos interface	---	198
8BAC0130.000-1	Max. 2	ACOPOSmulti plug-in module, 2 digital outputs, 50 mA, max. 62.5 kHz, 2 digital outputs, 500 mA, max. 1.25 kHz, 2 digital inputs - 24 VDC	only SLOT 2	202
8BAC0130.001-1	Max. 2	ACOPOSmulti plug-in module, 2 digital outputs, 50 mA, max. 62.5 kHz, 4 digital outputs, 500 mA, max. 1.25 kHz,	only SLOT 2	206
8BAC0132.000-1	Max. 2	ACOPOSmulti plug-in module, 4 analog inputs ± 10 V	---	209
8SCS000.0000-00 ¹⁾	1	ACOPOSmulti shield component set: 1 shield plate 1x type 0; 1 hose clamp, W 9 mm, D 12-22 mm	Shield component set for motor cables with a cable diameter of 12 - 22 mm	---
8SCS009.0000-00 ¹⁾	1	ACOPOSmulti shield component set: 1 ACOPOSmulti holding plate SK8-14 1 shield terminal SK14	Shield component set for motor cables with a cable diameter of up to 14 mm	---
8SCS005.0000-00	Up to 2	ACOPOSmulti shield component set: 1 slot cover shield sheet	Shield sheet for covering free plug-in module slots	---
8SCS002.0000-00	1	ACOPOSmulti shield component set: 1 clamping plate; 2 clamps D 4-13.5 mm; 4 screws	Shield component set for I/O cable with a cable diameter of 4 - 13.5 mm	---
8SCS007.0000-00 ²⁾	1	ACOPOSmulti shield component set: 1 shield mounting plate, 2x, 45°; 4 screws	Base plate for mounting shield component set 8SCS008.0000-00	---
8SCS008.0000-00 ²⁾	1	ACOPOSmulti shield component set: 1 shield plate, 2x, type 0; 1 hose clamp, W 9 mm, D 23-35 mm	Shield component set for motor cables with a cable diameter of 23 - 35 mm	---
8SCS010.0000-00 ²⁾	1	ACOPOSmulti shield component set: 1 ACOPOSmulti holding plate SK14-20 1 shield terminal SK20	Shield component set for motor cables with a cable diameter of up to 21 mm	---
8BXF001.0000-00	---	ACOPOSmulti fan module Replacement fan for ACOPOSmulti modules (8BxP/8B0C/8BVI/8BVE/8B0K)	Replacement fan for ACOPOSmulti modules (8BxP/8B0C/8BVI/8BVE/8B0K)	---
8TB2106.2010-00	1	Screw clamp, 6-pin, single-row, spacing: 5.08 mm, Label 1: numbered serially	Plug for X1 connection	---
8TB2108.2010-00	1	Screw clamp, 8-pin, single-row, spacing: 5.08 mm, Label 1: numbered serially	Plug for X2 connection	---
8TB2104.203L-00	1	Screw clamp, 4-pin, single-row, spacing: 5.08 mm, Label 3: T- T+ B- B+, Coding L: 1010	Plug for X4A connection	---

Table 84: Optional accessory - 8BVI inverter modules, 16kW ... 32kW (cont.)

Technical data • 8BVI inverter modules 16kW ... 32kW

Optional accessories				
Model number	Amount	Short description	Comment	Page
8TB4104.204G-00	1	Screw clamp, 4-pin, single-row, spacing: 10.16 mm, Label 4: PE W V U, Coding G: 0110	Plug for X5A connection	---
8TB4104.204G-10	1	Screw clamp, 4-pin, single-row, spacing: 10.16 mm, Label 4: PE W V U, Coding G: 0110	Plug for X5A connection	---

Table 84: Optional accessory - 8BVI inverter modules, 16kW ... 32kW (cont.)

- 1) Only for 8BVI0220HxS0.000-1.
- 2) Only for 8BVI0330HxS0.000-1 and 8BVI0440HxS0.000-1.

16.2 Technical data

Product ID	8BVI0220HWS0.000-1 8BVI0220HCS0.000-1	8BVI0330HWS0.000-1 8BVI0330HCS0.000-1	8BVI0440HWS0.000-1 8BVI0440HCS0.000-1
General information			
C-UL-US listed	Yes	In preparation	Yes
Available cooling and mounting methods			
Wall mounting	Yes		
Cold plate or feed-through mounting	Yes		
Module width	2		
DC bus			
Voltage Max.	750 VDC 900 VDC		
Continuous power consumption ¹⁾	16.2 kW	24.4 kW	32.5 kW
Power loss depending on the switching frequency ²⁾			
Switching frequency 5 kHz	$(0.13 \cdot I_M^2 + 5.5 \cdot I_M + 40) \text{ W}$	$(0.07 \cdot I_M^2 + 7.3 \cdot I_M + 40) \text{ W}$	
Switching frequency 10 kHz	$(0.43 \cdot I_M^2 + 3.7 \cdot I_M + 110) \text{ W}$	$(0.2 \cdot I_M^2 + 11.1 \cdot I_M + 130) \text{ W}$	
Switching frequency 20 kHz	$(1.4 \cdot I_M^2 + 1.97 \cdot I_M + 230) \text{ W}$	$(1.85 \cdot I_M^2 + 3.8 \cdot I_M + 300) \text{ W}$	
DC bus capacitance	495 μF	990 μF	
Design	ACOPOSmulti backplane		
24 VDC supply			
Input voltage	25 VDC \pm 1.6%		
Input capacitance	32.9 μF		
Max. power consumption	$20 \text{ W} + P_{24 \text{ V Out}} \{0 \dots 10 \text{ W}\}^3 + P_{\text{holding brake}} + 2 \cdot P_{\text{fan8B0M...}}^4$	$25 \text{ W} + P_{24 \text{ V Out}} \{0 \dots 10 \text{ W}\}^3 + P_{\text{holding brake}} + 2 \cdot P_{\text{fan8B0M...}}^4$	
Design	ACOPOSmulti backplane		
Motor connections			
Amount	1		
Continuous power per motor connection ¹⁾	16 kW	24 kW	32 kW

Table 85: Technical data for inverter modules 16kW ... 32kW

Technical data • 8BVI inverter modules 16kW ... 32kW

Product ID	8BVI0220HWS0.000-1 8BVI0220HCS0.000-1	8BVI0330HWS0.000-1 8BVI0330HCS0.000-1	8BVI0440HWS0.000-1 8BVI0440HCS0.000-1
Continuous current per motor connection ¹⁾	22 A _{eff}	33 A _{eff}	44 A _{eff}
Reduction of continuous current depending on switching frequency and cooling method ⁵⁾			
Switching frequency 20 kHz			
Wall mounting ⁶⁾	0.31 A/K (from -16°C) ⁸⁾		0.36 A/K (from -77°C) ⁸⁾
Cold-plate installation ⁷⁾	0.36 A/K (from 5°C) ⁹⁾		0.32 A/K (from -82°C) ⁹⁾
Feed-through mounting	In preparation		In preparation
Switching frequency 10 kHz			
Wall mounting ⁶⁾	0.4 A/K (from 31°C)		0.5 A/K (from -10°C) ⁸⁾
Cold-plate installation ⁷⁾	0.5 A/K (from 49°C)		0.62 A/K (from 6°C) ⁹⁾
Feed-through mounting	In preparation		In preparation
Switching frequency 5 kHz			
Wall mounting ⁶⁾	No reduction		1.57 A/K (from 40°C)
Cold-plate installation ⁷⁾	No reduction		0.8 A/K (from 45°C)
Feed-through mounting	In preparation		In preparation
Reduction of continuous power depending on altitude			
Starting at 500 m above sea level	2.2 A _{eff} per 1,000 m	3.3 A _{eff} per 1,000 m	4.4 A _{eff} per 1,000 m
Peak current	55 A _{eff}	83 A _{eff}	88 A _{eff}
Rated switching frequency	5 kHz		
Possible switching frequencies ¹⁰⁾	5 / 10 / 20 kHz		
Electrical stress of the connected motor according to IEC TS 60034-25	Limit value curve A		
Protective measures			
Overload protection		Yes	
Short circuit and ground fault		Yes	
Maximum motor length depending on the switching frequency ¹¹⁾			
Switching frequency 5 kHz		25 m	
Switching frequency 10 kHz		25 m	
Switching frequency 20 kHz		25 m	
Design			
U, V, W, PE		Plugs	
Shield connection		Yes	
Terminal connection cross sections			
Flexible and fine wire lines with wire tip sleeves	0.5 - 6 mm ²		0.5 - 16 mm ²
Approbation data			
UL/C-UL-US	20 - 8		20 - 6
CSA	20 - 8		20 - 6
Terminal cable outer-cross-section dimension of the shield connection	12 - 22 mm		23 - 35 mm

Table 85: Technical data for inverter modules 16kW ... 32kW (cont.)

Technical data • 8BVI inverter modules 16kW ... 32kW

Product ID	8BVI0220HWS0.000-1 8BVI0220HCS0.000-1	8BVI0330HWS0.000-1 8BVI0330HCS0.000-1	8BVI0440HWS0.000-1 8BVI0440HCS0.000-1
Wall mounting Cold plate or feed-through mounting			
Motor holding brake connections			
Amount	1		
Output voltage ¹²⁾	24 VDC +5.8% / -0% ¹³⁾		
Continuous current	4.2 A		
Max. internal resistance	0.15 Ω		
Extinction potential	Approx. 30 V		
Max. extinction energy per switching operation	3 Ws		
Max. switching frequency	0.5 Hz		
Protective measures			
Overload and short-circuit protection	Yes		
Cable breakage monitoring	Yes		
Undervoltage monitoring	Yes		
Response threshold for cable breakage monitoring	Approx. 0.5 A		
Response threshold for undervoltage monitoring	24 VDC +0% / -4%		
Trigger inputs			
Amount	2		
Wiring	Sink		
Electrical isolation			
Input - inverter module	Yes		
Input - Input	No		
Input voltage			
Rated	24 VDC		
Maximum	30 VDC		
Switching threshold			
LOW	< 5 V		
HIGH	>15 V		
Input current at rated voltage	Approx. 10 mA		
Switching delay			
Positive edge	52 μs ± 0.5 μs (digitally filtered)		
Negative edge	53 μs ± 0.5 μs (digitally filtered)		
Modulation compared to ground potential	Max. ±38 V		
24 V Out			
Amount	2		
Output voltage			
DC bus voltage 260 ... 315 VDC	25 VDC * (DC bus voltage / 315)		
DC bus voltage 315 ... 900 VDC	24 VDC ±6%		
Fuse protection	500 mA (slow-blow) electronic, automatic reset		

Table 85: Technical data for inverter modules 16kW ... 32kW (cont.)

Technical data • 8BVI inverter modules 16kW ... 32kW

Product ID	8BVI0220HWS0.000-1 8BVI0220HCS0.000-1	8BVI0330HWS0.000-1 8BVI0330HCS0.000-1	8BVI0440HWS0.000-1 8BVI0440HCS0.000-1
Enable inputs			
Amount	2		
Wiring	Sink		
Electrical isolation Input - inverter module	Yes		
Input voltage Rated Maximum	24 VDC 30 VDC		
Switching threshold LOW HIGH	< 5 V >15 V		
Input current at rated voltage	Approx. 30 mA		
Switching delay @ 24 VDC Enable 1 -> 0, PWM off Enable 0 -> 1, Ready for PWM	Max. 20.5 ms Max. 100 µs		
Modulation compared to ground potential	Max. ±38 V		
Operational conditions			
Permitted mounting orientations Hanging vertically Lying horizontally Standing horizontally	Yes Yes No		
Ambient temperature during operation Max. ambient temperature ¹⁴⁾	5 to 40°C +55°C		
Relative humidity during operation	5 to 85%, non-condensing		
Installation at altitudes above sea level Maximum installation altitude ¹⁵⁾	0 to 500 m 4,000 m		
Degree of pollution according to EN 60664-1	2 (non-conductive material)		
Overvoltage cat. according to IEC 60364-4-443:1999	III		
EN 60529 protection	IP20		
Storage and transport conditions			
Storage temperature	-25 to +55°C		
Relative humidity during storage	5 to 95%, non-condensing		
Transport temperature	-25 to +70°C		
Relative humidity during transport	Max. 95% at +40°C		

Table 85: Technical data for inverter modules 16kW ... 32kW (cont.)

Technical data • 8BVI inverter modules 16kW ... 32kW

Product ID			
Wall mounting Cold plate or feed-through mounting	8BVI0220HWS0.000-1 8BVI0220HCS0.000-1	8BVI0330HWS0.000-1 8BVI0330HCS0.000-1	8BVI0440HWS0.000-1 8BVI0440HCS0.000-1
Mechanical characteristics			
Dimensions ¹⁶⁾			
Width	106.5 mm		
Height	317 mm		
Depth			
Wall mounting	263 mm		
Cold-plate	212 mm		
Feed-through mounting	209 mm		
Weight			
Wall mounting	Approx. 5.2 kg	Approx. 5.4 kg	
Cold-plate	Approx. 3.9 kg	Approx. 4.3 kg	
Feed-through mounting	Approx. 3.9 kg	Approx. 4.3 kg	

Table 85: Technical data for inverter modules 16kW ... 32kW (cont.)

- Valid in the following conditions: DC bus voltage 750 VDC, switching frequency 5 kHz, 40°C ambient temperature, installation altitudes < 500 m above sea level, no derating dependent on cooling type.
 - I_M ... Current on the motor connection [A].
 - The power consumption $P_{24V\ Out}$ corresponds to the power that is output on the module's X2 / +24 V Out 1 and X2 / +24 V Out 2 connections (max. 10 W).
 - The power consumption $P_{Fan8BOM...}$ corresponds to the portion of the power that is used by the fan modules in the mounting plate / by the 8B0M0040HFF0.000-1 fan module and can be found in the technical data for the respective 8BOM... mounting plate.
 - Valid in the following conditions: DC bus voltage 750 VDC, minimum permissible coolant flow volume (3 l/min). The nominal switching frequency values for the respective ACOPOSmulti inverter module are marked in bold.
 - The temperature specifications are based on the ambient temperature.
 - The temperature specifications are based on the return temperature of the cold plate mounting plate.
 - The module cannot supply the full continuous current at this switching frequency. This unusual value for the ambient temperature, at which a derating of the continuous current must be accounted for, ensures that the derating of the continuous current can be determined in the same manner as at other switching frequencies.
 - The module cannot supply the full continuous current at this switching frequency. This unusual value for the return temperature, at which a derating of the continuous current must be accounted for, ensures that the derating of the continuous current can be determined in the same manner as at other switching frequencies.
- Caution! Condensation can occur at low flow-temperatures and low return-temperatures. The designs in the section "Condensation", on page 362 must be taken into consideration!**
- B&R recommends operating the module at nominal switching frequency. Operating the module at a higher switching frequency for application-specific reasons reduces the continuous current and increases the CPU load. When using double-axis modules, the increased CPU load causes a reduction of the functional range in the drive; if this is not taken into consideration then it can cause the computing time to be exceeded in extreme cases.

11) Information:

When using two motor cables that are connected in parallel, the maximum permissible motor cable lengths are reduced by half.

The total length of all motor cables per backplane module is limited (see section 5 "8BVF line filter", on page 60).

- During project development, it is necessary to check if the minimum voltage can be maintained on the holding brake with the specified wiring. The operating voltage range of the holding brake can be found in the user's manual for the respective motor.
- The specified values is only valid under the following conditions:
 - The 24 VDC supply for the module is provided by an 8BOC auxiliary supply module, which is installed on the same mounting plate
 - Connection between S1 and S2 (activation of the external holding brake) using a jumper with a length of max. 10 cm.

If the 24 VDC supply for the module is applied to the mounting plate using an 8BVE expansion module, then the output voltage is reduced because of voltage drops on the expansion cable. In this case, undervoltage monitoring must be deactivated.

If jumpers longer than 10 cm are used to connect S1 and S2, the output voltage is reduced because of voltage drops on the jumpers.
- Continuous operation at ambient temperatures ranging from 40°C to max. 55°C is possible (taking the continuous current reductions listed into consideration), but results in a shorter lifespan.
- Continuous operation at altitudes ranging from 500 m to 4,000 m above sea level is possible (taking the continuous current reductions listed into consideration). Additional requirements are to be arranged with B&R.

16) The dimensions refer to the true device dimensions including the respective mounting plate. Make sure to leave additional space above and below the device for mounting, connections and air circulation (see section 4 "Dimension diagrams and installation dimensions", on page 264).

16.2.1 POWERLINK station number settings

The POWERLINK station number can be set using two HEX code switches that are located behind the black cover of the module:


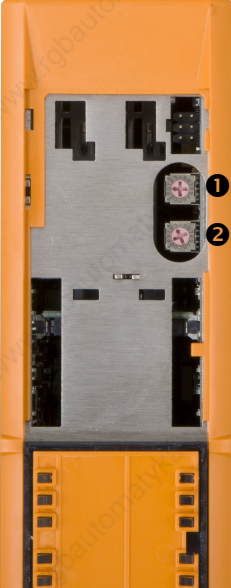
Figure	Code switch	POWERLINK station number
	❶	16s position (high)
	❷	1s position (low)
	<p>The POWERLINK station number change takes effect the next time the ACOPOSmulti drive system is switched on.</p> <p>Information:</p> <p>In principle, station numbers between \$01 and \$FD are permitted. However, station numbers between \$F0 and \$FD are reserved for future system expansions. For reasons of compatibility, we recommend avoiding these station numbers.</p> <p>Station numbers \$00, \$FE and \$FF are reserved and are therefore not allowed to be set.</p>	

Table 86: Setting the POWERLINK station number

17. 8BVI inverter modules 11kW ... 16kW (two-axis modules)

17.1 General information

Two-axis modules contain two complete standalone inverters in an inverter module.

17.2 Order data


Model number	Short description	Figure
		 <p>8BVI0110HCD0.000-1</p>
Wall mounting		
8BVI0110HWD0.000-1	ACOPOSMulti inverter module, 15.1 A HV, wall-mounting, 2 axes	
8BVI0220HWD0.000-1	ACOPOSMulti inverter module, 22 A HV, wall-mounting, 2 axes	
Cold plate or feed-through mounting		
8BVI0110HCD0.000-1	ACOPOSMulti inverter module 15.1 A, HV, cold plate or feed-through mounting, 2 axes	
8BVI0220HCD0.000-1	ACOPOSMulti inverter module 22 A, HV, cold plate or feed-through mounting, 2 axes	

Table 87: Order data - 8BVI inverter modules, 11kW ... 16kW (two-axis modules)

Required accessories				
Model number	Amount	Short description	Comment	Page
8BZVI0110D0.000-1A	1	Screw clamp set for ACOPOSMulti Modules 8BVI0110HxD0: 1x 8TB2112.2010-00, 1x 8TB2108.2010-00, 1x 8TB2104.203L-00, 1x 8TB2104.203F-00, 1x 8TB3104.204G-00, 1x 8TB3104.204K-00	---	---

Table 88: Required accessory - 8BVI inverter modules, 11kW ... 16kW (two-axis modules)

Optional accessories				
Model number	Amount	Short description	Comment	Page
8BAC0120.000-1	Max. 2	ACOPOSMulti plug-in module, EnDat 2.1 interface	---	166
8BAC0120.001-2	Max. 2	ACOPOSMulti plug-in module, EnDat 2.2 interface	---	170
8BAC0122.000-1	Max. 2	ACOPOSMulti plug-in module, Resolver interface 10 kHz	---	178
8BAC0123.000-1	Max. 2	ACOPOSMulti plug-in module, Incremental encoder and SSI absolute encoder interface for RS422 signals	---	182

Table 89: Optional accessory - 8BVI inverter modules, 11kW ... 16kW (two-axis modules)

Technical data • 8BVI inverter modules 11kW ... 16kW (two-axis modules)

Optional accessories				
Model number	Amount	Short description	Comment	Page
8BAC0123.001-1	Max. 2	ACOPOSMulti plug-in module, Incremental encoder interface for 5 V single-ended and 5 V differential signals	---	188
8BAC0123.002-1	Max. 2	ACOPOSMulti plug-in module, Incremental encoder interface for 24 V single-ended and 24 V differential signals	---	193
8BAC0124.000-1	Max. 2	ACOPOSMulti plug-in module, SinCos interface	---	198
8BAC0130.000-1	Max. 2	ACOPOSMulti plug-in module, 2 digital outputs, 50 mA, max. 62.5 kHz, 2 digital outputs, 500 mA, max. 1.25 kHz, 2 digital inputs - 24 VDC	only SLOT 2	202
8BAC0130.001-1	Max. 2	ACOPOSMulti plug-in module, 2 digital outputs, 50 mA, max. 62.5 kHz, 4 digital outputs, 500 mA, max. 1.25 kHz,	only SLOT 2	206
8BAC0132.000-1	Max. 2	ACOPOSMulti plug-in module, 4 analog inputs ± 10 V	---	209
8SCS005.0000-00	Up to 2	ACOPOSMulti shield component set: 1 slot cover shield sheet	Shield sheet for covering free plug-in module slots	---
8SCS002.0000-00	1	ACOPOSMulti shield component set: 1 clamping plate; 2 clamps D 4-13.5 mm; 4 screws	Shield component set for I/O cable with a cable diameter of 4 - 13.5 mm	---
8SCS000.0000-00	Up to 2	ACOPOSMulti shield component set: 1 shield plate 1x type 0; 1 hose clamp, W 9 mm, D 12-22 mm	Shield component set for motor cables with a cable diameter of 12 - 22 mm	---
8SCS009.0000-00	Up to 2	ACOPOSMulti shield component set: 1 ACOPOSMulti holding plate SK8-14 1 shield terminal SK14	Shield component set for motor cables with a cable diameter of up to 14 mm	---
8BXF001.0000-00	---	ACOPOSMulti fan module Replacement fan for ACOPOSMulti modules (8BxP/8B0C/8BVI/8BVE/8B0K)	Replacement fan for ACOPOSMulti modules (8BVP/8B0C/8BVI/8BVE/8B0K)	---
8TB2112.2010-00	1	Screw clamp, 12-pin, single-row, spacing: 5.08 mm, Label 1: numbered serially	Plug for X1 connection	---
8TB2108.2010-00	1	Screw clamp, 8-pin, single-row, spacing: 5.08 mm, Label 1: numbered serially	Plug for X2 connection	---
8TB2104.203L-00	1	Screw clamp, 4-pin, single-row, spacing: 5.08 mm, Label 3: T- T+ B- B+, Coding L: 1010	Plug for X4A connection	---
8TB2104.203F-00	1	Screw clamp, 4-pin, single-row, spacing: 5.08 mm, Label 3: T- T+ B- B+, Coding F: 0101	Plug for X4B connection	---

Table 89: Optional accessory - 8BVI inverter modules, 11kW ... 16kW (two-axis modules) (cont.)

Technical data • 8BVI inverter modules 11kW ... 16kW (two-axis modules)

Optional accessories				
Model number	Amount	Short description	Comment	Page
8TB3104.204G-00	1	Screw clamp, 4-pin, single-row, spacing: 7.62 mm, Label 4: PE W V U, Coding G: 0110	Plug for X5A connection	---
8TB3104.204K-00	1	Screw clamp, 4-pin, single-row, spacing: 7.62 mm, Label 4: PE W V U, Coding K: 1001	Plug for X5B connection	---

Table 89: Optional accessory - 8BVI inverter modules, 11kW ... 16kW (two-axis modules) (cont.)

17.3 Technical data

Product ID	8BVI0110HWD0.000-1 8BVI0110HCD0.000-1	8BVI0220HWD0.000-1 8BVI0220HCD0.000-1
Wall mounting Cold plate or feed-through mounting		
General information		
C-UL-US listed	Yes	
Available cooling and mounting methods Wall mounting Cold plate or feed-through mounting	Yes Yes	
Module width	2	
DC bus		
Voltage Max.	750 VDC 900 VDC	
Continuous power consumption ¹⁾	22.3 kW	In preparation
Power loss depending on the switching frequency ²⁾ Switching frequency 5 kHz Switching frequency 10 kHz Switching frequency 20 kHz	(0.33*I _M ² +11*I _M +90) W (0.97*I _M ² +9.5*I _M +170) W (1.66*I _M ² -21*I _M +380) W	In preparation In preparation In preparation
DC bus capacitance	330 µF	1320 µF
Design	ACOPOSmulti backplane	
24 VDC supply		
Input voltage	25 VDC ±1.6%	
Input capacitance	23.5 µF	
Max. power consumption	20 W + P _{24 V Out} (0 ... 10 W) ³⁾ + P _{holding brake(s)} + 2*P _{fan8BOM...} ⁴⁾	
Design	ACOPOSmulti backplane	

Table 90: Technical data - 8BVI inverter modules, 11kW ... 16kW (two-axis modules)

Technical data • 8BVI inverter modules 11kW ... 16kW (two-axis modules)

Product ID	8BVI0110HWD0.000-1 8BVI0110HCD0.000-1	8BVI0220HWD0.000-1 8BVI0220HCD0.000-1
Wall mounting Cold plate or feed-through mounting		
Motor connections		
Amount	2	
Continuous power per motor connection ¹⁾	11 kW	16 kW
Continuous current per motor connection ¹⁾	15.1 A _{eff}	22 A _{eff}
Reduction of continuous current depending on switching frequency and cooling method ⁵⁾		
Switching frequency 20 kHz		
Wall mounting ⁶⁾	In preparation	In preparation
Cold-plate installation ⁷⁾	In preparation	In preparation
Feed-through mounting	In preparation	In preparation
Switching frequency 10 kHz		
Wall mounting ⁶⁾	In preparation	In preparation
Cold-plate installation ⁷⁾	In preparation	In preparation
Feed-through mounting	In preparation	In preparation
Switching frequency 5 kHz		
Wall mounting ⁶⁾	In preparation	In preparation
Cold-plate installation ⁷⁾	In preparation	In preparation
Feed-through mounting	In preparation	In preparation
Reduction of continuous power depending on altitude Starting at 500 m above sea level	1.51 A _{eff} per 1,000 m	2.2 A _{eff} per 1,000 m
Peak current	37.7 A _{eff}	55 A _{eff} ⁸⁾
Rated switching frequency	5 kHz	
Possible switching frequencies ⁹⁾	5 / 10 / 20 kHz	5 / 10 kHz
Electrical stress of the connected motor according to IEC TS 60034-25	Limit value curve A	
Protective measures		
Overload protection	Yes	
Short circuit and ground fault	Yes	
Maximum motor line length depending on the switching frequency ¹⁰⁾		
Switching frequency 5 kHz	25 m	25 m
Switching frequency 10 kHz	25 m	25 m
Switching frequency 20 kHz	10 m	---
Design		
U, V, W, PE	Plugs	
Shield connection	Yes	
Terminal connection cross sections		
Flexible and fine wire lines with wire tip sleeves	0.25 - 4 mm ²	
Approbation data		
UL/C-UL-US	30 - 10	
CSA	28 - 10	
Terminal cable outer-cross-section dimension of the shield connection	12 - 22 mm	

Table 90: Technical data - 8BVI inverter modules, 11kW ... 16kW (two-axis modules) (cont.)

Technical data • 8BVI inverter modules 11kW ... 16kW (two-axis modules)

Product ID	8BVI0110HWD0.000-1 8BVI0110HCD0.000-1	8BVI0220HWD0.000-1 8BVI0220HCD0.000-1
Wall mounting Cold plate or feed-through mounting		
Motor holding brake connections		
Amount	2	
Output voltage ¹¹⁾	24 VDC +5.8% / +0% ¹²⁾	
Continuous current	2.1 A	
Max. internal resistance	0.3 Ω	
Extinction potential		
Max. extinction energy per switching operation	3 Ws	
Max. switching frequency	0.5 Hz	
Protective measures		
Overload and short circuit protection	Yes	
Cable breakage monitoring	Yes	
Undervoltage monitoring	Yes	
Response threshold for cable breakage monitoring	Approx. 0.5 A	
Response threshold for undervoltage monitoring	24 VDC +0% / -4%	
Trigger inputs		
Amount	2	
Wiring	Sink	
Electrical isolation		
Input - inverter module	Yes	
Input - Input	Yes	
Input voltage		
Rated	24 VDC	
Maximum	30 VDC	
Switching threshold		
LOW	< 5 V	
HIGH	>15 V	
Input current at rated voltage	Approx. 10 mA	
Switching delay		
Positive edge	52 μs ± 0.5 μs (digitally filtered)	
Negative edge	53 μs ± 0.5 μs (digitally filtered)	
Modulation compared to ground potential	Max. ±38 V	
24 VDC Out		
Amount	2	
Output voltage		
DC bus voltage 260 ... 315 VDC	25 VDC * (DC bus voltage / 315)	
DC bus voltage 315 ... 900 VDC	24 VDC ±6%	
Fuse protection	500 mA (slow-blow) electronic, automatic reset	

Table 90: Technical data - 8BVI inverter modules, 11kW ... 16kW (two-axis modules) (cont.)

Technical data • 8BVI inverter modules 11kW ... 16kW (two-axis modules)

Product ID	8BVI0110HWD0.000-1 8BVI0110HCD0.000-1	8BVI0220HWD0.000-1 8BVI0220HCD0.000-1
Enable inputs		
Amount	4 (2 per axis)	
Wiring	Sink	
Electrical isolation		
Input - inverter module	Yes	
Input - Input	Yes	
Input voltage		
Rated	24 VDC	
Maximum	30 VDC	
Switching threshold		
LOW	< 5 V	
HIGH	>15 V	
Input current at rated voltage	Approx. 30 mA	
Switching delay @ 24 VDC		
Enable 1 -> 0, PWM off	Max. 20.5 ms	
Enable 0 -> 1, Ready for PWM	Max. 100 µs	
Modulation compared to ground potential	Max. ±38 V	
Operational conditions		
Permitted mounting orientations		
Hanging vertically	Yes	
Lying horizontally	Yes	
Standing horizontally	No	
Ambient temperature during operation	5 to 40°C	
Max. ambient temperature ¹³⁾	+55°C	
Relative humidity during operation	5 to 85%, non-condensing	
Installation at altitudes above sea level	0 to 500 m	
Maximum installation altitude ¹⁴⁾	4,000 m	
Degree of pollution according to EN 60664-1	2 (non-conductive material)	
Overvoltage cat. according to IEC 60364-4-443:1999	III	
EN 60529 protection	IP20	
Storage and transport conditions		
Storage temperature	-25 to +55°C	
Relative humidity during storage	5 to 95%, non-condensing	
Transport temperature	-25 to +70°C	
Relative humidity during transport	95% at +40°C	

Table 90: Technical data - 8BVI inverter modules, 11kW ... 16kW (two-axis modules) (cont.)

Technical data • 8BVI inverter modules 11kW ... 16kW (two-axis modules)

Product ID	8BVI0110HWD0.000-1 8BVI0110HCD0.000-1	8BVI0220HWD0.000-1 8BVI0220HCD0.000-1
Wall mounting Cold plate or feed-through mounting		
Mechanical characteristics		
Dimensions ¹⁵⁾		
Width		106.5 mm
Height		317 mm
Depth		
Wall mounting		263 mm
Cold-plate		212 mm
Feed-through mounting		209 mm
Weight		
Wall mounting	Approx. 5.3 kg	Approx. 5.7 kg
Cold-plate	Approx. 4.1 kg	Approx. 4.4 kg
Feed-through mounting	Approx. 4.1 kg	Approx. 4.4 kg

Table 90: Technical data - 8BVI inverter modules, 11kW ... 16kW (two-axis modules) (cont.)

- Valid in the following conditions: DC bus voltage 750 VDC, switching frequency 5 kHz, 40°C ambient temperature, installation altitudes < 500 m above sea level, no derating dependent on cooling type.
- I_M ... Average value of the currents on both motor connectors [A].
- The power consumption $P_{24 V_{Out}}$ corresponds to the power that is output on the module's X2 / +24 V Out 1 and X2 / +24 V Out 2 connections (max. 10 W).
- The power consumption $P_{Fan8BOM...}$ corresponds to the portion of the power that is used by the fan modules in the mounting plate / by the 8B0M0040HFF0.000-1 fan module and can be found in the technical data for the respective 8B0M... mounting plate.
- Valid in the following conditions: DC bus voltage 750 VDC, minimum permissible coolant flow volume (3 l/min). The nominal switching frequency values for the respective ACOPOSmulti inverter module are marked in bold.
- The temperature specifications are based on the ambient temperature.
- The temperature specifications are based on the return temperature of the cold plate mounting plate.
- The thermal pulse load capacity is lower than for the single-axis module 8BVI0220HxS0.000-1. It is therefore not possible to simply replace two 8BVI0220HxS0.000-1 single-axis modules with one 8BVI0220HxD0.000-1 two-axis module. If this is required, the load cycle must be examined in detail.
- B&R recommends operating the module at nominal switching frequency. Operating the module at a higher switching frequency for application-specific reasons reduces the continuous current and increases the CPU load.
When using double-axis modules, the increased CPU load causes a reduction of the functional range in the drive; if this is not taken into consideration then it can cause the computing time to be exceeded in extreme cases.
- To avoid exceeding the EMC limit values, the maximum motor cable length per motor connection is reduced at switching frequencies > 10 kHz.

Information:

When using two motor cables that are connected in parallel, the maximum permissible motor cable lengths are reduced by half.

The total length of all motor cables per backplane module is limited (see section 5 "8BVF line filter", on page 60).

- During project development, it is necessary to check if the minimum voltage can be maintained on the holding brake with the specified wiring. The operating voltage range of the holding brake can be found in the user's manual for the respective motor.
- The specified values is only valid under the following conditions:
 - The 24 VDC supply for the module is provided by an 8B0C auxiliary supply module, which is installed on the same mounting plate
 - Connection between S1 and S2 (activation of the external holding brake) using a jumper with a length of max. 10 cm.

If the 24 VDC supply for the module is applied to the mounting plate using an 8BVE expansion module, then the output voltage is reduced because of voltage drops on the expansion cable. In this case, undervoltage monitoring must be deactivated.

If jumpers longer than 10 cm are used to connect S1 and S2, the output voltage is reduced because of voltage drops on the jumpers.
- Continuous operation at ambient temperatures ranging from 40°C to max. 55°C is possible (taking the continuous current reductions listed into consideration), but results in a shorter lifespan.
- Continuous operation at altitudes ranging from 500 m to 4,000 m above sea level is possible (taking the continuous current reductions listed into consideration). Additional requirements are to be arranged with B&R.
- The dimensions refer to the true device dimensions including the respective mounting plate. Make sure to leave additional space above and below the device for mounting, connections and air circulation (see section 4 "Dimension diagrams and installation dimensions", on page 264).

17.3.1 POWERLINK station number settings

The POWERLINK station number can be set using two HEX code switches that are located behind the black cover of the module:

Figure	Code switch	POWERLINK station number
 <p data-bbox="211 922 299 943">Cover closed</p> <p data-bbox="480 922 568 943">Cover open</p>	❶	16s position (high)
	❷	1s position (low)
<p>The POWERLINK station number change takes effect the next time the ACOPOSmulti drive system is switched on.</p>		
<p>Information:</p>		
<p>In principle, station numbers between \$01 and \$FD are permitted.</p>		
<p>However, station numbers between \$F0 and \$FD are reserved for future system expansions. For reasons of compatibility, we recommend avoiding these station numbers.</p>		
<p>Station numbers \$00, \$FE and \$FF are reserved and are therefore not allowed to be set.</p>		

Section 2
Technical data

Table 91: Setting the POWERLINK station number

18. 8BVI inverter modules, 64kW

18.1 Order data


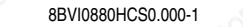
Model number	Short description	Figure
	Wall mounting	
8BVI0880HWS0.000-1	ACOPOSMulti inverter module, 88 A, HV, wall-mounting	
	Cold plate or feed-through mounting	
8BVI0880HCS0.000-1	ACOPOSMulti inverter module, 88 A, HV, cold plate or feed-through mounting	

Table 92: Order data - 8BVI inverter modules, 64kW

Required accessories				
Model number	Amount	Short description	Comment	Page
8BZVI1650S0.000-1A	1	Screw clamp set for ACOPOSMulti Modules 8BVI0880HxS0 and 8BVI16500HxS0: 1x 8TB2104.203L-00, 1x 8TB2106.2010-00, 1x 8TB2108.2010-00	---	---

Table 93: Required accessory - 8BVI inverter modules, 64kW

Optional accessories				
Model number	Amount	Short description	Comment	Page
8BAC0120.000-1	Max. 2	ACOPOSMulti plug-in module, EnDat 2.1 interface	---	166
8BAC0120.001-2	Max. 2	ACOPOSMulti plug-in module, EnDat 2.2 interface	---	170
8BAC0122.000-1	Max. 2	ACOPOSMulti plug-in module, Resolver interface 10 kHz	---	178
8BAC0123.000-1	Max. 2	ACOPOSMulti plug-in module, Incremental encoder and SSI absolute encoder interface for RS422 signals	---	182
8BAC0123.001-1	Max. 2	ACOPOSMulti plug-in module, Incremental encoder interface for 5 V single-ended and 5 V differential signals	---	188
8BAC0123.002-1	Max. 2	ACOPOSMulti plug-in module, Incremental encoder interface for 24 V single-ended and 24 V differential signals	---	193

Table 94: Optional accessory - 8BVI inverter modules, 64kW

Optional accessories				
Model number	Amount	Short description	Comment	Page
8BAC0124.000-1	Max. 2	ACOPOSMulti plug-in module, SinCos interface	---	198
8BAC0130.000-1	Max. 2	ACOPOSMulti plug-in module, 2 digital outputs, 50 mA, max. 62.5 kHz, 2 digital outputs, 500 mA, max. 1.25 kHz, 2 digital inputs - 24 VDC	only SLOT 2	202
8BAC0130.001-1	Max. 2	ACOPOSMulti plug-in module, 2 digital outputs, 50 mA, max. 62.5 kHz, 4 digital outputs, 500 mA, max. 1.25 kHz,	only SLOT 2	206
8BAC0132.000-1	Max. 2	ACOPOSMulti plug-in module, 4 analog inputs ± 10 V	---	209
8SCS005.0000-00	Up to 2	ACOPOSMulti shield component set: 1 slot cover shield sheet	Shield sheet for covering free plug-in module slots	---
8SCS002.0000-00	1	ACOPOSMulti shield component set: 1 clamping plate; 2 clamps D 4-13.5 mm; 4 screws	Shield component set for I/O cable with a cable diameter of 4 - 13.5 mm	---
8SCS003.0000-00	1	ACOPOSMulti shield component set: 1 shield mounting plate, 4x, 45°; 8 screws	Base plate for mounting shield component set 8SCS001.0000-00 or 8SCS004.0000-00	---
8SCS004.0000-00	1	ACOPOSMulti shield component set: 1 shield plate, 4x, type 0; 2 hose clamps, W 9 mm, D 32-50 mm	Shield component set for motor cables with a cable diameter of 32 - 50 mm	---
8SCS001.0000-00	3	ACOPOSMulti shield component set: 1 shield plate, 4x, type 1; 1 hose clamp, W 9 mm, D 12-22 mm	Shield component set for individual wires with a diameter of 12 - 22 mm	---
8BXF001.0000-00	---	ACOPOSMulti fan module Replacement fan for ACOPOSMulti modules (8BxP/8B0C/8BVI/8BVE/8B0K)	Replacement fan for ACOPOSMulti modules (8BxP/8B0C/8BVI/8BVE/8B0K)	---
8TB2106.2010-00	1	Screw clamp, 6-pin, single-row, spacing: 5.08 mm, Label 1: numbered serially	Plug for X1 connection	---
8TB2108.2010-00	1	Screw clamp, 8-pin, single-row, spacing: 5.08 mm, Label 1: numbered serially	Plug for X2 connection	---
8TB2104.203L-00	1	Screw clamp, 4-pin, single-row, spacing: 5.08 mm, Label 3: T- T+ B- B+, Coding L: 1010	Plug for X4A connection	---

Table 94: Optional accessory - 8BVI inverter modules, 64kW (cont.)

18.2 Technical data

Product ID	
Wall mounting	8BVI0880HWS0.000-1
Cold plate or feed-through mounting	8BVI0880HCS0.000-1
General information	
C-UL-US listed	Yes
Available cooling and mounting methods	
Wall mounting	Yes
Cold plate or feed-through mounting	Yes
Module width	4
DC bus	
Voltage	750 VDC
Max.	900 VDC
Continuous power consumption ¹⁾	89 kW
Power loss depending on the switching frequency ²⁾	
Switching frequency 5 kHz	$(0.03 \cdot I_M^2 + 7.9 \cdot I_M + 90) \text{ W}$
Switching frequency 10 kHz	$(0.11 \cdot I_M^2 + 11 \cdot I_M + 185) \text{ W}$
Switching frequency 20 kHz	$(0.17 \cdot I_M^2 + 27 \cdot I_M + 310) \text{ W}$
DC bus capacitance	1980 μF
Design	ACOPOSmulti backplane
24 VDC supply	
Input voltage	25 VDC $\pm 1.6\%$
Input capacitance	32.9 μF
Max. power consumption	$27 \text{ W} + P_{24 \text{ V Out}} [0 \dots 10 \text{ W}]^3 + P_{\text{holding brake}} + 4 \cdot P_{\text{fan8B0M...}}^4$
Design	ACOPOSmulti backplane
Motor connections	
Amount	1
Continuous power per motor connection ¹⁾	64 kW
Continuous current per motor connection ¹⁾	88 A _{eff}
Reduction of continuous current depending on switching frequency and cooling method ⁵⁾	
Switching frequency 20 kHz	
Wall mounting ⁶⁾	0.56 A/K (from -90°C) ⁸⁾
Cold-plate installation ⁷⁾	0.75 A/K (from -37°C) ⁹⁾
Feed-through mounting	In preparation
Switching frequency 10 kHz	
Wall mounting ⁶⁾	0.92 A/K (from -5°C) ⁸⁾
Cold-plate installation ⁷⁾	1.36 A/K (from 27°C)
Feed-through mounting	In preparation
Switching frequency 5 kHz	
Wall mounting ⁶⁾	1.4 A/K (from 41°C)
Cold-plate installation ⁷⁾	1.9 A/K (from 58°C)
Feed-through mounting	In preparation
Reduction of continuous power depending on altitude	
Starting at 500 m above sea level	8.8 A _{eff} per 1,000 m

Table 95: Technical data - 8BVI inverter modules, 64kW

Technical data • 8BVI inverter modules, 64kW

Product ID	
Wall mounting Cold plate or feed-through mounting	8BVI0880HWS0.000-1 8BVI0880HCS0.000-1
Peak current	176 A _{eff}
Rated switching frequency	5 kHz
Possible switching frequencies ¹⁰⁾	5 / 10 / 20 kHz
Electrical stress of the connected motor according to IEC TS 60034-25	Limit value curve A
Protective measures	
Overload protection	Yes
Short circuit and ground fault	Yes
Maximum motor line length depending on the switching frequency ¹¹⁾	
Switching frequency 5 kHz	25 m
Switching frequency 10 kHz	25 m
Switching frequency 20 kHz	25 m
Design	
U, V, W, PE	M8 threaded bolt
Shield connection	Yes
Terminal connection cross sections	
Flexible and fine wire lines with wire tip sleeves	6 - 50 mm ² ¹²⁾
Approbation data	
UL/C-UL-US	In preparation
CSA	In preparation
Terminal cable outer-cross-section dimension of the shield connection ¹³⁾	12 - 50 mm
Motor holding brake connections	
Amount	1
Output voltage ¹⁴⁾	24 VDC +5.8% / -0% ¹⁵⁾
Continuous current	4.2 A
Max. internal resistance	0.15 Ω
Extinction potential	Approx. 30 V
Max. extinction energy per switching operation	3 Ws
Max. switching frequency	0.5 Hz
Protective measures	
Overload and short circuit protection	Yes
Cable breakage monitoring	Yes
Undervoltage monitoring	Yes
Response threshold for cable breakage monitoring	Approx. 0.5 A
Response threshold for undervoltage monitoring	24 VDC +0% / -4%

Table 95: Technical data - 8BVI inverter modules, 64kW (cont.)

Technical data • 8BVI inverter modules, 64kW

Product ID	
Wall mounting Cold plate or feed-through mounting	8BVI0880HWS0.000-1 8BVI0880HCS0.000-1
Trigger inputs	
Amount	2
Wiring	Sink
Electrical isolation Input - inverter module Input - Input	Yes Yes
Input voltage Rated Maximum	24 VDC 30 VDC
Switching threshold LOW HIGH	< 5 V >15 V
Input current at rated voltage	Approx. 10 mA
Switching delay Positive edge Negative edge	52 μ s \pm 0.5 μ s (digitally filtered) 53 μ s \pm 0.5 μ s (digitally filtered)
Modulation compared to ground potential	Max. \pm 38 V
24 V Out	
Amount	2
Output voltage DC bus voltage 260 ... 315 VDC DC bus voltage 315 ... 900 VDC	25 VDC * (DC bus voltage / 315) 24 VDC \pm 6%
Fuse protection	500 mA (slow-blow) electronic, automatic reset
Enable inputs	
Amount	2
Wiring	Sink
Electrical isolation Input - inverter module Input - Input	Yes Yes
Input voltage Rated Maximum	24 VDC 30 VDC
Switching threshold LOW HIGH	< 5 V >15 V
Input current at rated voltage	Approx. 30 mA
Switching delay @ 24 VDC Enable 1 -> 0, PWM off Enable 0 -> 1, Ready for PWM	Max. 20.5 ms Max. 100 μ s
Modulation compared to ground potential	Max. \pm 38 V

Table 95: Technical data - 8BVI inverter modules, 64kW (cont.)

Technical data • 8BVI inverter modules, 64kW

Product ID	
Wall mounting Cold plate or feed-through mounting	8BVI0880HWS0.000-1 8BVI0880HCS0.000-1
Operational conditions	
Permitted mounting orientations	
Hanging vertically	Yes
Lying horizontally	Yes
Standing horizontally	No
Ambient temperature during operation	5 to 40°C
Max. ambient temperature ¹⁶⁾	+55°C
Relative humidity during operation	5 to 85%, non-condensing
Installation at altitudes above sea level	0 to 500 m
Maximum installation altitude ¹⁷⁾	4,000 m
Degree of pollution according to EN 60664-1	2 (non-conductive material)
Overvoltage cat. according to IEC 60364-4-443:1999	III
EN 60529 protection	IP20
Storage and transport conditions	
Storage temperature	-25 to +55°C
Relative humidity during storage	5 to 95%, non-condensing
Transport temperature	-25 to +70°C
Relative humidity during transport	Max. 95% at +40°C
Mechanical characteristics	
Dimensions ¹⁸⁾	
Width	213.5 mm
Height	317 mm
Depth	
Wall mounting	263 mm
Cold-plate	212 mm
Feed-through mounting	209 mm
Weight	
Wall mounting	Approx. 9.6 kg
Cold-plate	Approx. 7.1 kg
Feed-through mounting	Approx. 7.1 kg

Table 95: Technical data - 8BVI inverter modules, 64kW (cont.)

- 1) Valid in the following conditions: DC bus voltage 750 VDC, switching frequency 5 kHz, 40°C ambient temperature, installation altitudes < 500 m above sea level, no derating dependent on cooling type.
- 2) I_M ... Current on the motor connection [A].
- 3) The power consumption $P_{24 V_{Out}}$ corresponds to the power that is output on the module's X2 / +24 V Out 1 and X2 / +24 V Out 2 connections (max. 10 W).
- 4) The power consumption $P_{Fan8BOM...}$ corresponds to the portion of the power that is used by the fan modules in the mounting plate / by the 8B0M0040HFF0.000-1 fan module and can be found in the technical data for the respective 8B0M... mounting plate.
- 5) Valid in the following conditions: DC bus voltage 750 VDC, minimum permissible coolant flow volume (3 l/min). The nominal switching frequency values for the respective ACOPOSmulti inverter module are marked in bold.
- 6) The temperature specifications are based on the ambient temperature.
- 7) The temperature specifications are based on the return temperature of the cold plate mounting plate.
- 8) The module cannot supply the full continuous current at this switching frequency. This unusual value for the ambient temperature, at which a derating of the continuous current must be accounted for, ensures that the derating of the continuous current can be determined in the same manner as at other switching frequencies.

- 9) The module cannot supply the full continuous current at this switching frequency. This unusual value for the return temperature, at which a derating of the continuous current must be accounted for, ensures that the derating of the continuous current can be determined in the same manner as at other switching frequencies.

Caution! Condensation can occur at low flow-temperatures and low return-temperatures. The designs in the section "Condensation", on page 362 must be taken into consideration!

- 10) B&R recommends operating the module at nominal switching frequency. Operating the module at a higher switching frequency for application-specific reasons reduces the continuous current and increases the CPU load. When using double-axis modules, the increased CPU load causes a reduction of the functional range in the drive; if this is not taken into consideration then it can cause the computing time to be exceeded in extreme cases.

11) Information:

When using two motor cables that are connected in parallel, the maximum permissible motor cable lengths are reduced by half.

The total length of all motor cables per backplane module is limited (see section 5 "8BVF line filter", on page 60).

- 12) The connection is made with cable lugs using an M8 threaded bolt.
- 13) The maximum diameter that can be clamped depends on the shield component set.
- 14) During project development, it is necessary to check if the minimum voltage can be maintained on the holding brake with the specified wiring. The operating voltage range of the holding brake can be found in the user's manual for the respective motor.
- 15) The specified values is only valid under the following conditions:
- The 24 VDC supply for the module is provided by an 8B0C auxiliary supply module, which is installed on the same mounting plate
 - Connection between S1 and S2 (activation of the external holding brake) using a jumper with a length of max. 10 cm.
- If the 24 VDC supply for the module is applied to the mounting plate using an 8BVE expansion module, then the output voltage is reduced because of voltage drops on the expansion cable. In this case, undervoltage monitoring must be deactivated.
- If jumpers longer than 10 cm are used to connect S1 and S2, the output voltage is reduced because of voltage drops on the jumpers.
- 16) Continuous operation at ambient temperatures ranging from 40°C to max. 55°C is possible (taking the continuous current reductions listed into consideration), but results in a shorter lifespan.
- 17) Continuous operation at altitudes ranging from 500 m to 4,000 m above sea level is possible (taking the continuous current reductions listed into consideration). Additional requirements are to be arranged with B&R.
- 18) The dimensions refer to the true device dimensions including the respective mounting plate. Make sure to leave additional space above and below the device for mounting, connections and air circulation (see section 4 "Dimension diagrams and installation dimensions", on page 264).

18.2.1 POWERLINK station number settings

The POWERLINK station number can be set using two HEX code switches that are located behind the black cover of the module:

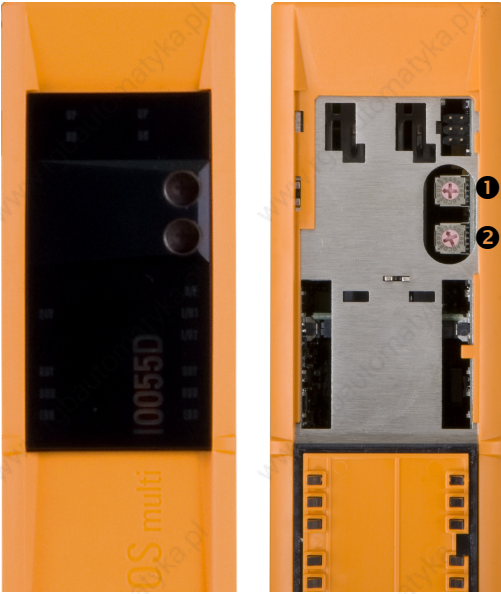
Figure	Code switch	POWERLINK station number
 <p data-bbox="209 922 299 943">Cover closed</p> <p data-bbox="480 922 564 943">Cover open</p>	<p data-bbox="732 298 748 319">❶</p>	<p data-bbox="917 298 1047 319">16s position (high)</p>
	<p data-bbox="732 339 748 360">❷</p>	<p data-bbox="927 339 1036 360">1s position (low)</p>
<p data-bbox="665 378 1125 418">The POWERLINK station number change takes effect the next time the ACOPOSmulti drive system is switched on.</p> <p data-bbox="665 435 795 459">Information:</p> <p data-bbox="665 475 1125 516">In principle, station numbers between \$01 and \$FD are permitted.</p> <p data-bbox="665 516 1125 581">However, station numbers between \$F0 and \$FD are reserved for future system expansions. For reasons of compatibility, we recommend avoiding these station numbers.</p> <p data-bbox="665 597 1125 638">Station numbers \$00, \$FE and \$FF are reserved and are therefore not allowed to be set.</p>		

Table 96: Setting the POWERLINK station number

19. 8BVI inverter modules, 120kW

19.1 Order data


Model number	Short description	Figure
	Cold plate or feed-through mounting	 <p>8BVI1650HCS0.000-1</p>
8BV1650HCS0.000-1	ACOPOSMulti inverter module 165A, HV, cold plate or feed-through mounting	

Table 97: Order data - 8BVI inverter modules, 120kW

Required accessories				
Model number	Amount	Short description	Comment	Page
8BZV11650S0.000-1A	1	Screw clamp set for ACOPOSMulti Modules 8BVI0880HxS0 and 8BVI16500HxS0: 1x 8TB2104.203L-00, 1x 8TB2106.2010-00, 1x 8TB2108.2010-00	---	---

Table 98: Required accessory - 8BVI inverter modules, 120kW

Optional accessories				
Model number	Amount	Short description	Comment	Page
8BAC0120.000-1	Max. 2	ACOPOSMulti plug-in module, EnDat 2.1 interface	---	166
8BAC0120.001-2	Max. 2	ACOPOSMulti plug-in module, EnDat 2.2 interface	---	170
8BAC0122.000-1	Max. 2	ACOPOSMulti plug-in module, Resolver interface	---	178
8BAC0123.000-1	Max. 2	ACOPOSMulti plug-in module, Incremental encoder and SSI absolute encoder interface for RS422 signals	---	182
8BAC0123.001-1	Max. 2	ACOPOSMulti plug-in module, Incremental encoder interface for 5V single-ended and 5V differential signals	---	188
8BAC0123.002-1	Max. 2	ACOPOSMulti plug-in module, Incremental encoder interface for 24V single-ended and 24V differential signals	---	193

Table 99: Optional accessory - 8BVI inverter modules, 120kW

Optional accessories				
Model number	Amount	Short description	Comment	Page
8BAC0124.000-1	Max. 2	ACOPOSMulti plug-in module, SinCos interface	---	198
8BAC0130.000-1	Max. 2	ACOPOSMulti plug-in module, 2 digital outputs, 50 mA, max. 62.5 kHz, 2 digital outputs, 500 mA, max. 1.25 kHz, 2 digital inputs 24 VDC	only SLOT2	202
8BAC0130.001-1	Max. 2	ACOPOSMulti plug-in module, 2 digital outputs, 50 mA, max. 62.5 kHz, 4 digital outputs, 500 mA, max 1.25 kHz	only SLOT2	206
8BAC0132.000-1	Max. 2	ACOPOSMulti plug-in module, 4 analog inputs ± 10 V	---	209
8SCS005.0000-00	Up to 2	Shield component set consisting of: 1 slot cover shield sheet	Shield sheet for covering free plug-in module slots	---
8SCS002.0000-00	1	Shield component set consisting of: 1 clamping plate 2 clamps D 4-13.5mm 2 screws	Shield component set for I/O cable with a cable diameter of 4 - 13.5 mm	---
8SCS003.0000-00	1	Shield component set consisting of: 1 shield mounting plate, 4x, 45° 8 screws	Base plate for mounting shield component set 8SCS001.0000-00 or 8SCS004.0000-00	---
8SCS004.0000-00	1	Shield component set consisting of: 1 shield plate, 4x, type 0 2 hose clamp, W 9mm, D 32-50mm	Shield component set for motor cables with a cable diameter of 32 - 50 mm	---
8SCS001.0000-00	3	Shield component set consisting of: 1 shield plate, 4x, type 1 1 hose clamp, W 9mm, D 12-22mm	Shield component set for individual wires with a diameter of 12 - 22 mm	---
8BXF001.0000-00	---	ACOPOSMulti fan module Replacement fan for ACOPOSMulti modules (8BVP/8B0C/8BVI/8BVE/8B0K)	Replacement fan for ACOPOSMulti modules (8BVP/8B0C/8BVI/8BVE/8B0K)	---
8TB2106.2010-00	1	Screw terminal 6 pins, 1 row RM5,08 Label 1: numbered serially	Plug for X1 connection	---
8TB2108.2010-00	1	Screw terminal 8 pins, 1 row RM5,08 Label 1: numbered serially	Plug for X2 connection	---
8TB2104.203L-00	1	Screw terminal 4 pins, 1 row RM5,08 Label 3: T- T+ B- B+ Coding L: 1010	Plug for X4A connection	---

Table 99: Optional accessory - 8BVI inverter modules, 120kW (cont.)

19.2 Technical data

Product ID	
Wall mounting Cold plate or feed-through mounting	--- 8BVI1650HCS0.000-1
General information	
C-UL-US listed	In preparation
Available cooling and mounting methods Wall mounting Cold plate or feed-through mounting	No Yes
Module width	8
DC bus	
Voltage Max.	750 VDC 900 VDC
Continuous power consumption ¹⁾	In preparation
Power loss depending on the switching frequency ²⁾ Switching frequency 5 kHz Switching frequency 10 kHz Switching frequency 20 kHz	In preparation In preparation In preparation
DC bus capacitance	3630 µF
Design	ACOPOSmulti backplane
24 VDC supply	
Input voltage	25 VDC ±1.6 %
Input capacitance	32.9 µF
Max. power consumption	$35 \text{ W} + P_{24 \text{ V Out}} [0 \dots 10 \text{ W}]^{3)} + P_{\text{holding brake}} + 8 * P_{\text{fan8B0M...}}^{4)}$
Design	ACOPOSmulti backplane
Motor connector	
Amount	1
Continuous power per motor connection ¹⁾	120 kW
Continuous current per motor connection ¹⁾	165 A _{eff}
Reduction of continuous current depending on switching frequency and cooling method ⁵⁾ Switching frequency 20 kHz Wall mounting ⁶⁾ Cold-plate installation ⁷⁾ Feed-through mounting Switching frequency 10 kHz Wall mounting ⁶⁾ Cold-plate installation ⁷⁾ Feed-through mounting Switching frequency 5 kHz Wall mounting ⁶⁾ Cold-plate installation ⁷⁾ Feed-through mounting	--- In preparation In preparation --- In preparation In preparation --- In preparation In preparation
Reduction of continuous power depending on altitude Starting at 500 m above sea level	16.5 A _{eff} per 1000 m

Table 100: Technical data - 8BVI inverter modules, 120kW

Technical data • 8BVI inverter modules, 120kW

Product ID	
Wall mounting Cold plate or feed-through mounting	--- 8BVI1650HCS0.000-1
Peak current	330 A _{eff}
Rated switching frequency	5 kHz
Possible switching frequencies ⁸⁾	5 / 10 / 20 kHz
Electrical stress of the connected motor according to IEC TS 60034-25	Limit value curve A
Protective measures	
Overload protection	Yes
Short circuit and ground fault	Yes
Maximum motor line length depending on the switching frequency ⁹⁾	
Switching frequency 5 kHz	25 m
Switching frequency 10 kHz	25 m
Switching frequency 20 kHz	25 m
Design	
U, V, W, PE	M8 threaded bolt
Shield connection	Yes
Terminal connection cross sections	
Flexible and fine wire lines with wire tip sleeves	6 - 95 mm ² ¹⁰⁾
Approbation data	
UL/C-UL-US	In preparation
CSA	In preparation
Terminal cable outer-cross-section dimension of the shield connection ¹¹⁾	12 - 50 mm
Motor holding brake connection	
Amount	1
Output voltage ¹²⁾	24 VDC +5.8 % / -0 % ¹³⁾
Continuous current	4.2 A
Max. internal resistance	0.15 Ω
Extinction potential	Approx. 30 V
Max. extinction energy per switching operation	3 Ws
Max. switching frequency	0.5 Hz
Protective measures	
Overload and short circuit protection	Yes
Cable breakage monitoring	Yes
Undervoltage monitoring	Yes
Response threshold for cable breakage monitoring	Approx. 0.5 A
Response threshold for undervoltage monitoring	24 VDC +0 % / -4 %

Table 100: Technical data - 8BVI inverter modules, 120kW (cont.)

Technical data • 8BVI inverter modules, 120kW

Product ID	
Wall mounting Cold plate or feed-through mounting	--- 8BVI1650HCS0.000-1
Trigger inputs	
Amount	2
Wiring	Sink
Electrical isolation Input - inverter module Input - Input	Yes Yes
Input voltage Rated Maximum	24 VDC 30 VDC
Switching threshold LOW HIGH	< 5 V >15 V
Input current at rated voltage	Approx. 10 mA
Switching delay Positive edge Negative edge	52 μ s \pm 0.5 μ s (digitally filtered) 53 μ s \pm 0.5 μ s (digitally filtered)
Modulation compared to ground potential	Max. \pm 38 V
24 V Out	
Amount	2
Output voltage DC bus voltage 260 ... 315 VDC DC bus voltage 315 ... 900 VDC	25 VDC * (DC bus voltage / 315) 24 VDC \pm 6 %
Fuse protection	500 mA (slow-blow) electronic, automatic reset
Enable inputs	
Amount	2
Wiring	Sink
Electrical isolation Input - inverter module Input - Input	Yes Yes
Input voltage Rated Maximum	24 VDC 30 VDC
Switching threshold LOW HIGH	< 5 V >15 V
Input current at rated voltage	Approx. 30 mA
Switching delay @ 24 VDC Enable 1 -> 0, PWM off Enable 0 -> 1, Ready for PWM	Max. 20.5 ms Max. 100 μ s
Modulation compared to ground potential	Max. \pm 38 V

Table 100: Technical data - 8BVI inverter modules, 120kW (cont.)

Technical data • 8BVI inverter modules, 120kW

Product ID	
Wall mounting Cold plate or feed-through mounting	--- 8BVI1650HCS0.000-1
Operational conditions	
Permitted mounting orientations	
Hanging vertically	Yes
Lying horizontally	Yes
Standing horizontally	No
Ambient temperature during operation Max. ambient temperature ¹⁴⁾	5 to 40 °C +55 °C
Relative humidity during operation	5 to 85 %, non-condensing
Installation at altitudes above sea level Maximum installation altitude ¹⁵⁾	0 to 500 m 4000 m
Degree of pollution according to EN 60664-1	2 (non-conductive material)
Overvoltage cat. according to IEC 60364-4-443:1999	III
EN 60529 protection	IP20
Storage and transport conditions	
Storage temperature	-25 to +55 °C
Relative humidity during storage	5 to 95 %, non-condensing
Transport temperature	-25 to +70 °C
Relative humidity during transport	95% at +40 °C
Mechanical characteristics	
Dimensions ¹⁶⁾	
Width	427.5 mm
Height	317 mm
Depth	
Wall mounting	---
Cold-plate	212 mm
Feed-through mounting	209 mm
Weight	
Wall mounting	---
Cold-plate	Approx. 19.5 kg
Feed-through mounting	Approx. 19.5 kg

Table 100: Technical data - 8BVI inverter modules, 120kW (cont.)

- 1) Valid in the following conditions: DC bus voltage 750 VDC, switching frequency 5 kHz, 40 °C ambient temperature, installation altitudes < 500 m above sea level, no derating dependent on cooling type.
- 2) I_M ... Current on the motor connection [A].
- 3) The power consumption $P_{24 V Out}$ corresponds to the power that is output on the module's X2 / +24 V Out 1 and X2 / +24 V Out 2 connections (max. 10 W).
- 4) The power consumption $P_{Fan8BOM...}$ corresponds to the portion of the power that is used by the fan modules in the mounting plate / by the 8B0M0040HFF0.000-1 fan module and can be found in the technical data for the respective 8B0M... mounting plate.
- 5) Valid in the following conditions: DC bus voltage 750 VDC, minimum permissible coolant flow volume (3 l/min). The nominal switching frequency values for the respective ACOPOSmulti inverter module are marked in bold.
- 6) The temperature specifications are based on the ambient temperature.
- 7) The temperature specifications are based on the return temperature of the cold plate mounting plate.
- 8) B&R recommends operating the module at nominal switching frequency. Operating the module at a higher switching frequency for application-specific reasons reduces the continuous current and increases the CPU load.
When using double-axis modules, the increased CPU load causes a reduction of the functional range in the drive; if this is not taken into consideration then it can cause the computing time to be exceeded in extreme cases.

9) Information:

When using two motor cables that are connected in parallel, the maximum permissible motor cable lengths are reduced by half.

The total length of all motor cables per backplane module is limited (see section 5 "8BVF line filter", on page 60).

- 10) The connection is made with cable lugs using an M8 threaded bolt.
- 11) The maximum diameter that can be clamped depends on the shield component set.
- 12) During project development, it is necessary to check if the minimum voltage can be maintained on the holding brake with the specified wiring. The operating voltage range of the holding brake can be found in the user's manual for the respective motor.
- 13) The specified values is only valid under the following conditions:
 - The 24 VDC supply for the module is provided by an 8BOC auxiliary supply module, which is installed on the same mounting plate
 - Connection between S1 and S2 (activation of the external holding brake) using a jumper with a length of max. 10 cm.

If the 24 VDC supply for the module is applied to the mounting plate using an 8BVE expansion module, then the output voltage is reduced because of voltage drops on the expansion cable. In this case, undervoltage monitoring must be deactivated.

If jumpers longer than 10 cm are used to connect S1 and S2, the output voltage is reduced because of voltage drops on the jumpers.
- 14) Continuous operation of ACOPOSmulti inverter modules at ambient temperatures ranging from 40°C to max. 55°C is possible (taking the continuous current reductions listed into consideration), but results in a shorter lifespan.
- 15) Continuous operation of ACOPOSmulti inverter modules at altitudes ranging from 500 m to 4000 m above sea level is possible (taking the continuous current reductions listed into consideration). Additional requirements are to be arranged with B&R.
- 16) The dimensions define the true device dimensions including the respective mounting plate. Make sure to leave additional space above and below the device for mounting, connections and air circulation (see section 4 "Dimension diagrams and installation dimensions", on page 264).

19.2.1 POWERLINK station number settings

The POWERLINK station number can be set using two HEX code switches that are located behind the black cover of the module:

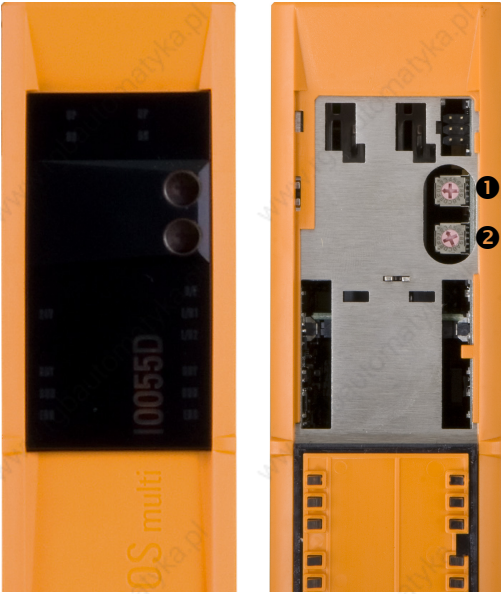
Figure	Code switch	POWERLINK station number
 <p data-bbox="209 919 299 938">Cover closed</p> <p data-bbox="481 919 572 938">Cover open</p>	<p data-bbox="733 297 748 316">❶</p>	<p data-bbox="917 297 1047 316">16s position (high)</p>
	<p data-bbox="733 334 748 354">❷</p>	<p data-bbox="927 334 1036 354">1s position (low)</p>
<p data-bbox="665 375 1126 418">The POWERLINK station number change takes effect the next time the ACOPOSmulti drive system is switched on.</p> <p data-bbox="665 431 795 456">Information:</p> <p data-bbox="665 472 1126 516">In principle, station numbers between \$01 and \$FD are permitted.</p> <p data-bbox="665 516 1126 578">However, station numbers between \$F0 and \$FD are reserved for future system expansions. For reasons of compatibility, we recommend avoiding these station numbers.</p> <p data-bbox="665 594 1126 638">Station numbers \$00, \$FE and \$FF are reserved and are therefore not allowed to be set.</p>		

Table 101: Setting the POWERLINK station number

20. 8BVE expansion modules

20.1 Order data


Model number	Short description	Figure
	Wall mounting	
8BVE0500HW00.000-1	ACOPOSMulti expansion module 50 A, HV, wall-mounting	
	Cold plate or feed-through mounting	
8BVE0500HC00.000-1	ACOPOSMulti expansion module 50 A, HV, cold plate or feed-through mounting	
		8BVE0500HC00.000-1

Table 102: Order data - 8BVE expansion modules

Required accessories				
Model number	Amount	Short description	Comment	Page
8BZVE050000.000-1A	1	Screw clamp set for ACOPOSMulti 8BVE0500Hx00.000-1 module: 1x 8TB3102.201C-10, 1x 8TB4103.203C-10, 1x 8TB2104.2010-00	---	---
8BXS000.0000-00	1	ACOPOSMulti fuse set: 2 fuses, 14 x 51 mm, 50 A, ultra fast-acting	Fuse set for cable outlet DC bus (DC+, DC-)	---
8BXS001.0000-00	1	ACOPOSMulti fuse set: 2 fuses, 14 x 51 mm, 20 A, ultra fast-acting	Only one fuse set can be used per expansion module!	---
8BXS002.0000-00	1	ACOPOSMulti fuse set: 2 fuses, 14 x 51 mm, 10 A, ultra fast-acting		---
8BXS003.0000-00	1	ACOPOSMulti fuse set: 1 fuse, 10 x 38 mm, 30 A, fast-acting		Fuse set for cable outlet 24 VDC auxiliary supply
8BXS004.0000-00	1	ACOPOSMulti fuse set: 1 fuse, 10 x 38 mm, 12 A, fast-acting	Only one fuse set can be used per expansion module!	---

Table 103: Required accessories - 8BVE expansion modules

Optional accessories				
Model number	Amount	Short description	Comment	Page
8BCA01X5.1111A-0	1	ACOPOSMulti expansion cable, length 1.5 m, 3 x 1.5 mm ² , can be used in cable drag chains, UL/CSA certified	Can only be used in combination with fuse set 8BXS002.0000-00!	231

Table 104: Optional accessories - 8BVE expansion modules

Optional accessories				
Model number	Amount	Short description	Comment	Page
8BCA0003.1111A-0	1	ACOPOSMulti expansion cable, length 3 m, 3 x 1.5 mm ² , can be used in cable drag chains, UL/CSA certified	Can only be used in combination with fuse set 8BXS002.0000-00!	231
8BCA0005.1111A-0	1	ACOPOSMulti expansion cable, length 5 m, 3 x 1.5 mm ² , can be used in cable drag chains, UL/CSA certified		
8BCA01X5.1312A-0	1	ACOPOSMulti expansion cable, length 1.5 m, 3 x 4 mm ² , can be used in cable drag chains, UL/CSA certified	Can only be used in combination with fuse set 8BXS001.0000-00!	231
8BCA0003.1312A-0	1	ACOPOSMulti expansion cable, length 3 m, 3 x 4 mm ² , can be used in cable drag chains, UL/CSA certified		
8BCA0005.1312A-0	1	ACOPOSMulti expansion cable, length 5 m, 3 x 4 mm ² , can be used in cable drag chains, UL/CSA certified		
8BCA01X5.1513A-0	1	ACOPOSMulti expansion cable, length 1.5 m, 3 x 10 mm ² , can be used in cable drag chains, UL/CSA certified	Can only be used in combination with fuse set 8BXS000.0000-00!	231
8BCA0003.1513A-0	1	ACOPOSMulti expansion cable, length 3 m, 3 x 10 mm ² , can be used in cable drag chains, UL/CSA certified		
8BCA0005.1513A-0	1	ACOPOSMulti expansion cable, length 5 m, 3 x 10 mm ² , can be used in cable drag chains, UL/CSA certified		
8SCS000.0000-00	1	ACOPOSMulti shield component set: 1 shield plate 1x type 0; 1 hose clamp, W 9 mm, D 12-22 mm	Shield component set for cables with a cable diameter of 12 - 22 mm Not required when using ACOPOSMulti 8BCA expansion cables (shield component set integrated in the cable)	---
8SCS009.0000-00	1	ACOPOSMulti shield component set: 1 ACOPOSMulti holding plate SK8-14 1 shield terminal SK14	Shield component set for motor cables with a cable diameter of up to 14 mm Not required when using ACOPOSMulti 8BCA expansion cables (shield component set integrated in the cable)	---
8BXF001.0000-00	---	ACOPOSMulti fan module Replacement fan for ACOPOSMulti modules (8BxP/8B0C/8BVI/8BVE/8B0K)	Replacement fan for ACOPOSMulti modules (8BxP/8B0C/8BVI/8BVE/8B0K)	---
8TB2104.2010-00	1	Screw clamp, 4-pin, single-row, spacing: 5.08 mm, Label 1: numbered serially	Plug for X2 connection	---
8TB3102.201C-10	1	Screw clamp, 2-pin, single-row, spacing: 7.62 mm, Label 1: numbered serially, C coding: 10	Plug for X3A, X3B connection	---
8TB4103.203C-10	1	Screw clamp, 3-pin, single-row, spacing: 10.16 mm, Label 3: +DC -DC PE, C coding: 010	Plug for X4A, X4B connection	---

Table 104: Optional accessories - 8BVE expansion modules (cont.)

20.2 Technical data

Product ID	
Wall mounting	8BVE0500HW00.000-1
Cold plate or feed-through mounting	8BVE0500HC00.000-1
General information	
C-UL-US listed	Yes
Available cooling and mounting methods	
Wall mounting	Yes
Cold plate or feed-through mounting	Yes
Module width	1
DC bus connection	
Voltage	750 VDC
Max.	900 VDC
Continuous power depending on the fuse ^{1) 2)}	
10 A	6 kW
20 A	12 kW
50 A	30 kW
Continuous current depending on the fuse ¹⁾	
10 A	8 A _{eff}
20 A	16 A _{eff}
50 A	40 A _{eff}
Reduction of continuous power according to the ambient temperature above 40°C	In preparation
Reduction of continuous power depending on installation altitude Starting at 500 m above sea level	10% per 1,000 m
Reduction of continuous power depending on cooling method	
Wall mounting	In preparation
Cold plate or feed-through mounting	In preparation
Continuous current depending on the fuse	
10 A	20 A
20 A	40 A
50 A	100 A
Power loss with continuous power	200 W
DC bus capacitance	---
Design	ACOPOSmulti backplane
24 VDC supply	
Input voltage	25 VDC ±1.6%
Continuous power depending on the fuse ^{1) 2)}	
12 A	240 W
30 A	600 W
Max. power consumption	5 W
Reduction of continuous power according to the ambient temperature above 40°C	In preparation
Support capacity	---
Design	ACOPOSmulti backplane

Table 105: Technical data - 8BVE expansion modules

Technical data • 8BVE expansion modules

Product ID	
Wall mounting	8BVE0500HW00.000-1
Cold plate or feed-through mounting	8BVE0500HC00.000-1
DC bus cable outlet ³⁾	
Number of cable outlets	2
Fuse protection: DC+ and DC- Type ⁴⁾ Tripping characteristics Rated current	2x blow-out fuse Ø 14 x 51 mm ultra fast-acting 10 / 20 / 50 A
Protective measures Overload protection depending on the fuse 10 A 20 A 50 A Short circuit and ground fault	No (overload indicated via LED, has potential-free alarm contacts) No (overload indicated via LED, has potential-free alarm contacts) No (overload indicated via LED, has potential-free alarm contacts) Yes
Max. dist. between two expansion modules	5 m
Design DC+, DC-, PE Shield connection	Plugs Yes
Terminal connection cross sections Flexible and fine wire lines with wire tip sleeves Approbation data UL/C-UL-US CSA	0.5 - 16 mm ² 20 - 6 20 - 6
Terminal cable outer-cross-section dimension of the shield connection	12 - 22 mm
24 VDC auxiliary supply cable outlet	
Number of cable outlets	2
Output voltage DC bus voltage 260 ... 315 VDC DC bus voltage 315 ... 900 VDC	25 VDC * (DC bus voltage / 315) 24 VDC ±6%
24 VDC fuse protection Type ⁵⁾ Tripping characteristics Rated current	Blow-out fuse Ø 10 x 38 mm fast-acting 12 / 30 A
Protective measures Overload protection Short circuit protection	Yes Yes
Max. dist. between two expansion modules	5 m
Design 24 VDC, COM Shield connection	Plugs No
Terminal connection cross sections Flexible and fine wire lines with wire tip sleeves Approbation data UL/C-UL-US CSA	0.5 - 6 mm ² 22 - 10 22 - 10
Terminal cable outer-cross-section dimension of the shield connection	---

Table 105: Technical data - 8BVE expansion modules (cont.)

Technical data • 8BVE expansion modules

Product ID	
Wall mounting	8BVE0500HW00.000-1
Cold plate or feed-through mounting	8BVE0500HC00.000-1
Alarm contacts ⁶⁾	
Amount	2
Type	
Alarm contact 1	Normally closed
Alarm contact 2	Normally open
Electrical isolation	
Alarm contact - Alarm contact	Yes
Alarm contact - expansion module	Yes
Rated voltage	30 VDC
Maximum current	1 A
Switching delay 1 -> 0 and 0 -> 1	3 ms
Max. number of switching cycles	100000
Protection	
Short circuit protection	No
Overload protection	No
Operational conditions	
Permitted mounting orientations	
Hanging vertically	Yes
Lying horizontally	Yes
Standing horizontally	No
Ambient temperature during operation	5 to 40°C
Max. ambient temperature ⁷⁾	+55°C
Relative humidity during operation	5 to 85%, non-condensing
Installation at altitudes above sea level	0 to 500 m
Maximum installation altitude ⁸⁾	4,000 m
Degree of pollution according to EN 60664-1	2 (non-conductive material)
Overvoltage cat. according to IEC 60364-4-443:1999	III
EN 60529 protection	IP20
Storage and transport conditions	
Storage temperature	-25 to +55°C
Relative humidity during storage	5 to 95%, non-condensing
Transport temperature	-25 to +70°C
Relative humidity during transport	Max. 95% at +40°C

Table 105: Technical data - 8BVE expansion modules (cont.)

Product ID	
Wall mounting	8BVE0500HW00.000-1
Cold plate or feed-through mounting	8BVE0500HC00.000-1
Mechanical characteristics	
Dimensions ⁹⁾	
Width	53 mm
Height	317 mm
Depth	
Wall mounting	263 mm
Cold-plate	212 mm
Feed-through mounting	209 mm
Weight	
Wall mounting	Approx. 3.1 kg
Cold-plate	Approx. 2.6 kg
Feed-through mounting	Approx. 2.6 kg

Table 105: Technical data - 8BVE expansion modules (cont.)

- 1) Valid in the following conditions: DC bus voltage 750 VDC, switching frequency 5 kHz, 40°C ambient temperature, installation altitudes < 500 m above sea level, no derating dependent on cooling type.
- 2) The values listed take into consideration a reserve of 17% of the rated current (recommended by fuse manufacturer).
- 3) Shielded cables must be used. B&R recommends the ACOPOSmulti 8BCA expansion cables.
- 4) For a 10 A rated current, fuses of type 5011806.10 from Siba (www.sibafuses.com) must be used.
For a 20 A rated current, fuses of type 5011806.20 from Siba (www.sibafuses.com) must be used.
For a 50 A rated current, fuses of type 5020106.50 from Siba (www.sibafuses.com) must be used.
- 5) For example, a type KLKD0xx fuse from Littelfuse (www.littelfuse.com) may be used (xx is the rated current for the fuse; only fuses with a rated current of 30 A or less may be used).
- 6) The alarm contacts are triggered if:
 - the load on the damping resistors is >100% (OLD LED lights up).
 - the expansion module's 24 VDC outlet is overloaded (OL24 LED lights up).
 - the expansion module's DC bus outlet is overloaded (OLDC LED lights up).
 When the load on the damping resistors is > 100%, or when the 24 VDC outlet or DC bus outlet is overloaded, internal components of the device are overloaded.
The alarm contacts must therefore be monitored externally. When activating the alarm contacts, the ACOPOSmulti drive system should be switched off in order to prevent damage to the expansion module.
- 7) Continuous operation at ambient temperatures ranging from 40°C to max. 55°C is possible (taking the continuous current reductions listed into consideration), but results in a shorter lifespan.
- 8) Continuous operation at altitudes ranging from 500 m to 4,000 m above sea level is possible (taking the continuous current reductions listed into consideration). Additional requirements are to be arranged with B&R.
- 9) The dimensions refer to the true device dimensions including the respective mounting plate. Make sure to leave additional space above and below the device for mounting, connections and air circulation (see section 4 "Dimension diagrams and installation dimensions", on page 264).

21. 8B0K capacitor modules

21.1 Order data


Model number	Short description	Figure
	Wall mounting	 <p>8B0K1650HC00.000-1</p>
8B0K1650HW00.000-1	ACOPOSMulti capacitor module 1650 µF, HV, wall-mounting	
	Cold plate or feed-through mounting	
8B0K1650HC00.000-1	ACOPOSMulti capacitor module 1650 µF, HV, cold plate or feed-through mounting	

Table 106: Order data - 8B0K capacitor modules

Optional accessories				
Model number	Amount	Short description	Comment	Page
8BXF001.0000-00	---	ACOPOSMulti fan module Replacement fan for ACOPOSMulti modules (8BxP/8B0C/8BVI/8BVE/8B0K)	Replacement fan for ACOPOSMulti modules (8BxP/8B0C/8BVI/8BVE/8B0K)	---

Table 107: Optional accessory - 8B0K capacitor modules

21.2 Technical data

Product ID	
Wall mounting	8B0K1650HW00.000-1
Cold plate or feed-through mounting	8B0K1650HC00.000-1
General information	
C-UL-US listed	Yes
Available cooling and mounting methods	
Wall mounting	Yes
Cold plate or feed-through mounting	Yes
Module width	1
DC bus connection	
Voltage	750 VDC
Max.	900 VDC
Power loss	In preparation
DC bus capacitance	1650 µF
Design	ACOPOSMulti backplane

Table 108: Technical data - 8B0K capacitor modules

Technical data • 8B0K capacitor modules

Product ID	
Wall mounting	8B0K1650HW00.000-1
Cold plate or feed-through mounting	8B0K1650HC00.000-1
24 VDC supply	
Input voltage	25 VDC +1.6% / -20%
Max. power consumption	3 W
Design	ACOPOSMulti backplane
Operational conditions	
Permitted mounting orientations	
Hanging vertically	Yes
Lying horizontally	Yes
Standing horizontally	No
Ambient temperature during operation	5 to 40°C
Max. ambient temperature ¹⁾	+55°C
Relative humidity during operation	5 to 85%, non-condensing
Installation at altitudes above sea level	0 to 500 m
Maximum installation altitude ²⁾	4,000 m
Degree of pollution according to EN 60664-1	2 (non-conductive material)
Overvoltage cat. according to IEC 60364-4-443:1999	III
EN 60529 protection	IP20
Storage and transport conditions	
Storage temperature	-25 to +55°C
Relative humidity during storage	5 to 95%, non-condensing
Transport temperature	-25 to +70°C
Relative humidity during transport	Max. 95% at +40°C
Mechanical characteristics	
Dimensions ³⁾	
Width	53 mm
Height	317 mm
Depth	
Wall mounting	263 mm
Cold-plate	212 mm
Feed-through mounting	209 mm
Weight	
Wall mounting	Approx. 3.2 kg
Cold-plate	Approx. 2.7 kg
Feed-through mounting	Approx. 2.7 kg

Table 108: Technical data - 8B0K capacitor modules (cont.)

- 1) Continuous operation at ambient temperatures ranging from 40°C to max. 55°C is possible (taking the continuous current reductions listed into consideration), but results in a shorter lifespan.
- 2) Continuous operation at altitudes ranging from 500 m to 4,000 m above sea level is possible (taking the continuous current reductions listed into consideration). Additional requirements are to be arranged with B&R.
- 3) The dimensions refer to the true device dimensions including the respective mounting plate. Make sure to leave additional space above and below the device for mounting, connections and air circulation (see section 4 "Dimension diagrams and installation dimensions", on page 264).

22. EnDat 2.1 plug-in module 8BAC0120.000-1

22.1 General description

The EnDat 2.1 plug-in module 8BAC0120.000-1 can be used in an ACOPOSmulti slot. The module is equipped with an EnDat 2.1 interface.

This module can be used to evaluate encoders which are built into B&R servo motors and also encoders for external axes (encoders that evaluate any machine movement). The input signals are monitored. This allows detection of broken connections, shorted lines and encoder supply failure.

EnDat 2.1 encoder:

EnDat 2.1 is a standard developed by Johannes Heidenhain GmbH (www.heidenhain.de), incorporating the advantages of absolute and incremental position measurement and also offers a read/write parameter memory in the encoder. With absolute position measurement (absolute position is read in serially), the homing procedure is usually not required. When necessary, a multi-turn encoder (4096 revolutions) should be installed. To save costs, a single-turn encoder and a reference switch can also be used. In this case, a homing procedure must be carried out.

The incremental process allows the short delay times necessary for position measurement on drives with exceptional dynamic properties. With the sinusoidal incremental signal and the fine resolution in the EnDat 2.1 module, a very high positioning resolution is achieved in spite of the moderate signal frequencies used.

The parameter memory in the EnDat encoder is used by B&R to store motor data (among other things). In this way, the ACOPOSmulti drive system is always automatically provided the correct motor parameters and limit values. This is referred to as the "embedded parameter chip".

During start-up, the module is automatically identified, configured and its parameters set by the ACOPOSmulti drive system's operating system.

22.2 Order data


Model number	Short description	Figure
8BAC0120.000-1	ACOPOSMulti plug-in module, EnDat 2.1 interface	

Table 109: Order data - EnDat 2.1 plug-in module 8BAC0120.000-1

Optional accessories				
Model number	Amount	Short description	Comment	Page
8BCE0005.1111A-0	1	ACOPOSMulti EnDat cable, length 5 m, 10 x 0.14 mm ² + 2 x 0.5 mm ² , EnDat plug, 17-pin SpeedTec socket, Servo plug, 15-pin DSUB plug, can be used in cable drag chains, UL/CSA Isited	---	223
8BCE0007.1111A-0	1	ACOPOSMulti EnDat cable, length 7 m, 10 x 0.14 mm ² + 2 x 0.5 mm ² , EnDat plug, 17-pin SpeedTec socket, Servo plug, 15-pin DSUB plug, can be used in cable drag chains, UL/CSA Isited	---	223
8BCE0010.1111A-0	1	ACOPOSMulti EnDat cable, length 10 m, 10 x 0.14 mm ² + 2 x 0.5 mm ² , EnDat plug, 17-pin SpeedTec socket, Servo plug, 15-pin DSUB plug, can be used in cable drag chains, UL/CSA Isited	---	223
8BCE0015.1111A-0	1	ACOPOSMulti EnDat cable, length 15 m, 10 x 0.14 mm ² + 2 x 0.5 mm ² , EnDat plug, 17-pin SpeedTec socket, Servo plug, 15-pin DSUB plug, can be used in cable drag chains, UL/CSA Isited	---	223
8BCE0020.1111A-0	1	ACOPOSMulti EnDat cable, length 20 m, 10 x 0.14 mm ² + 2 x 0.5 mm ² , EnDat plug, 17-pin SpeedTec socket, Servo plug, 15-pin DSUB plug, can be used in cable drag chains, UL/CSA Isited	---	223
8BCE0025.1111A-0	1	ACOPOSMulti EnDat cable, length 25 m, 10 x 0.14 mm ² + 2 x 0.5 mm ² , EnDat plug, 17-pin SpeedTec socket, Servo plug, 15-pin DSUB plug, can be used in cable drag chains, UL/CSA Isited	---	223

Table 110: Optional accessory - EnDat 2.1 plug-in module 8BAC0120.000-1

22.3 Technical data

Product ID	8BAC0120.000-1
General information	
C-UL-US listed	Yes
Module type	ACOPOSMulti plug-in module
Slot ¹⁾	Slots 1 and 2
Max. power consumption	
E0 ... EnDat single-turn, 512 lines	4 W
E1 ... EnDat multi-turn, 512 lines	4 W
E2 ... EnDat single-turn, 32 lines (inductive)	4 W
E3 ... EnDat multi-turn, 32 lines (inductive)	4 W
E4 ... EnDat single-turn, 512 lines	4 W
E5 ... EnDat multi-turn, 512 lines	4 W
Encoder connection ²⁾	
Connection, module-side	15-pin DSUB socket
Indicators	UP/DN LEDs
Electrical isolation Encoder - ACOPOSMulti	No
Encoder monitoring	Yes
Maximum encoder cable length	75 m
Encoder supply	
Output voltage	5 V ± 5%
Load capacity	250 mA ³⁾
Sense lines	2, compensation of max. 2 x 0.7 V
Sine-cosine inputs	
Signal transfer	Differential signals, symmetric
Differential voltage	0.5 to 1.25 V _{SS}
Common mode voltage	max. ± 7 V
Terminating resistor	120 Ω
Signal frequency (-5 dB)	DC up to 400 kHz
Signal frequency (-3 dB)	DC up to 300 kHz
ADC resolution	12-bit
Synchronous serial interface	
Signal transfer	RS485
Data transfer rate	781.25 kBit/s
Position	
Resolution @ 1 V _{SS} ⁴⁾	Number of encoder lines * 5700
Accuracy ⁵⁾	---
Noise ⁵⁾	---
Operational conditions	
Ambient temperature during operation	... ⁶⁾
Relative humidity during operation	... ⁶⁾

Table 111: Technical data - EnDat 2.1 plug-in module 8BAC0120

Product ID	8BAC0120.000-1
Storage and transport conditions	
Storage temperature	-25 to +55°C
Relative humidity during storage	5 to 95%, non-condensing
Transport temperature	-25 to +70°C
Relative humidity during transport	Max. 95% at +40°C

Table 111: Technical data - EnDat 2.1 plug-in module 8BAC0120 (cont.)

- 1) The 8BAC0120.000-1 is an encoder module. Up to two encoder modules can be connected. In this case, the encoder module in the first slot automatically serves as motor feedback for the first axis and the encoder module in the second slot serves as motor feedback for the second axis. The second slot can be used for other purposes when in single-axis operation.
- 2) The EnDat encoder must be wired using a cable with a single shield.
- 3) An additional reserve of 57 mA is available for terminating resistors.
- 4) This value does not correspond to the encoder resolution that must be configured in Automation Studio (16384 * number of encoder lines).
- 5) In the field, this is limited by the encoder.
- 6) ACOPOSmulti plug-in modules can be used in an ACOPOSmulti inverter or power supply module; the corresponding values can be found in the technical data of the respective ACOPOSmulti inverter or power supply module.

22.4 Indicators

The indicators (UP/DN LEDs) are located on the front of the ACOPOSmulti drive or power supply module where the plug-in module is installed.

The UP/DN LEDs are lit depending on the rotational direction and the speed of the connected encoder. ¹⁾

UP LED ... indicates when the encoder position changes in the positive direction.

DN LED ... indicates when the encoder position changes in the negative direction.

22.5 Firmware

The firmware is part of the operating system for the ACOPOSmulti drive system. The firmware is updated by updating the ACOPOSmulti operating system.

1) The count direction of the encoder can be configured in Automation Studio. However, changing the count direction in Automation Studio does not change the actual count direction of the encoder and therefore does not affect the UP/DN LEDs!

23. EnDat 2.2 plug-in module 8BAC0120.001-2

23.1 General description

The EnDat 2.2 plug-in module can be used in an ACOPOSmulti slot. The module is equipped with an EnDat 2.2 interface.

This module can be used to evaluate encoders which are built into B&R servo motors and also encoders for external axes (encoders that evaluate any machine movement). The input signals are monitored. This allows detection of broken connections, shorted lines and encoder supply failure.

EnDat 2.2 encoder:

EnDat 2.2 is a standard developed by Johannes Heidenhain GmbH (www.heidenhain.de). It is an advancement of EnDat 2.1, which incorporates the advantages of a true digital, bi-directional interface and also offers a read/write parameter memory in the encoder. With absolute position measurement, the homing procedure is generally not required. When necessary, a multi-turn encoder (4096 revolutions) should be installed. To save costs, a single-turn encoder and a reference switch can also be used. In this case, a homing procedure must be carried out.

Only 4 signal lines are needed because serial data transfer is used. The data is transferred synchronous to the clock signal defined by the subsequent electronics.

The parameter memory in the EnDat encoder is used by B&R to store motor data (among other things). In this way, the ACOPOSmulti drive system is always automatically provided the correct motor parameters and limit values. This is referred to as the "embedded parameter chip".

During start-up, the module is automatically identified, configured and its parameters set by the ACOPOSmulti drive system's operating system.

23.2 Order data

Model number	Short description	Figure
8BAC0120.001-2	ACOPOSMulti plug-in module, EnDat 2.2 interface	 <p>Symbol photo</p>

Table 112: Order data - EnDat 2.2 plug-in module 8BAC0120.001-2

Information:

The EnDat 2.2 plug-in module 8BAC0120.001-2 can only be used in combination with EnDat 2.2 cables 8BCF (see section 34.4 "8BCF EnDat 2.2 cables", on page 225)!

Required accessories				
Model number	Amount	Short description	Comment	Page
8BCF0005.1221B-0	1	EnDat 2.2 cable, length 5 m, 1 x 4 x 0.14 mm ² + 4 x 0.34 mm ² , EnDat Plug, 12-pin SpringTec socket, Servo plug, 9-pin DSUB plug, can be used in cable drag chains, UL/CSA Isited	---	225
8BCF0007.1221B-0	1	EnDat 2.2 cable, length 7 m, 1 x 4 x 0.14 mm ² + 4 x 0.34 mm ² , EnDat Plug, 12-pin SpringTec socket, Servo plug, 9-pin DSUB plug, can be used in cable drag chains, UL/CSA Isited	---	225
8BCF0010.1221B-0	1	EnDat 2.2 cable, length 10 m, 1 x 4 x 0.14 mm ² + 4 x 0.34 mm ² , EnDat Plug, 12-pin SpringTec socket, Servo plug, 9-pin DSUB plug, can be used in cable drag chains, UL/CSA Isited	---	225
8BCF0015.1221B-0	1	EnDat 2.2 cable, length 15 m, 1 x 4 x 0.14 mm ² + 4 x 0.34 mm ² , EnDat Plug, 12-pin SpringTec socket, Servo plug, 9-pin DSUB plug, can be used in cable drag chains, UL/CSA Isited	---	225

Table 113: Required accessory - EnDat 2.2 plug-in module 8BAC0120.001-2

Technical data • EnDat 2.2 plug-in module 8BAC0120.001-2

Required accessories				
Model number	Amount	Short description	Comment	Page
8BCF0020.1221B-0	1	EnDat 2.2 cable, length 20 m, 1 x 4 x 0.14 mm ² + 4 x 0.34 mm ² , EnDat Plug, 12-pin SpringTec socket, Servo plug, 9-pin DSUB plug, can be used in cable drag chains, UL/CSA Isited	---	225
8BCF0025.1221B-0	1	EnDat 2.2 cable, length 25 m, 1 x 4 x 0.14 mm ² + 4 x 0.34 mm ² , EnDat Plug, 12-pin SpringTec socket, Servo plug, 9-pin DSUB plug, can be used in cable drag chains, UL/CSA Isited	---	225

Table 113: Required accessory - EnDat 2.2 plug-in module 8BAC0120.001-2 (cont.)

23.3 Technical data

Product ID	8BAC0120.001-2
General information	
C-UL-US listed	Yes
Module type	ACOPOSmulti plug-in module
Slot ¹⁾	Slots 1 and 2
Power consumption	In preparation
Encoder connection ²⁾	
Connection, module-side	9-pin DSUB socket
Indicators	UP/DN LEDs
Electrical isolation Encoder - ACOPOSmulti	No
Encoder monitoring	Yes
Maximum encoder cable length	100 m Depending on the cross section of the supply wires on the encoder cable ³⁾
Encoder supply	
Output voltage	Typ. 12.5 V
Load capability	350 mA
Protective measures / safeguards Overload protection Short circuit protection	Yes Yes

Table 114: Technical data - EnDat 2.2 plug-in module 8BAC0120.001-2

Product ID	8BAC0120.001-2
Synchronous serial interface	
Signal transfer	RS485
Data transfer rate	6.25 Mbit/s
Operational conditions	
Ambient temperature during operation	... 4)
Relative humidity during operation	... 4)
Storage and transport conditions	
Storage temperature	-25 to +55°C
Relative humidity during storage	5 to 95 %, non-condensing
Transport temperature	-25 to +70°C
Relative humidity during transport	95% at +40°C

Table 114: Technical data - EnDat 2.2 plug-in module 8BAC0120.001-2 (cont.)

- 1) The 8BAC0120.001-2 is an encoder module. Up to two encoder modules can be connected. In this case, the encoder module in the first slot automatically serves as motor feedback for the first axis and the encoder module in the second slot serves as motor feedback for the second axis. The second slot can be used for other purposes when in single-axis operation.
- 2) The EnDat encoder must be wired using a cable with a single shield and twisted pair signal lines.
- 3) The maximum encoder cable length l_{\max} can be calculated as follows (the maximum permissible encoder length of 100 m must not be exceeded):

$$l_{\max} = \frac{7,9}{l_G} \cdot A \cdot \frac{1}{2 \cdot \rho}$$

l_G ... Max. current consumption of the encoder [A]

A ... Cross section of the supply wire [mm²]

ρ ... Specific resistance [Ω mm²/m] (e.g. for copper: $\rho = 0.0178$)

- 4) ACOPOSmulti plug-in modules can be used in an ACOPOSmulti inverter or power supply module; the corresponding values can be found in the technical data of the respective ACOPOSmulti inverter or power supply module.

23.3.1 Indicators

The indicators (UP/DN LEDs) are located on the front of the ACOPOSmulti drive or power supply module where the plug-in module is installed.

The UP/DN LEDs are lit depending on the rotational direction and the speed of the connected encoder. ¹⁾

UP LED ... indicates when the encoder position changes in the positive direction.

DN LED ... indicates when the encoder position changes in the negative direction.

23.3.2 Firmware

The firmware is part of the operating system for the ACOPOSmulti drive system. The firmware is updated by updating the ACOPOSmulti operating system.

- 1) The count direction of the encoder can be configured in Automation Studio. However, changing the count direction in Automation Studio does not change the actual count direction of the encoder and therefore does not affect the UP/DN LEDs!

24. HIPERFACE plug-in module 8BAC0121.000-1

24.1 General description

The HIPERFACE plug-in module 8BAC0121.000-1 can be used in an ACOPOSmulti slot. The module is equipped with a HIPERFACE encoder interface.

This module can be used to evaluate encoders which are built into OEM motors and also encoders for external axes (encoders that evaluate any machine movement). The input signals are monitored. This allows detection of broken connections, shorted lines and encoder supply failure.

HIPERFACE is a standard developed by Max Stegmann GmbH (www.stegmann.de), similar to EnDat, incorporating the advantages of absolute and incremental position measurement and also offers a read/write parameter memory in the encoder. With absolute position measurement (absolute position is read in serially), the homing procedure is usually not required. When necessary, a multi-turn encoder (4096 revolutions) should be installed. To save costs, a single-turn encoder and a reference switch can also be used. In this case, a homing procedure must be carried out.

The incremental process allows the short delay times necessary for position measurement on drives with exceptional dynamic properties. With the sinusoidal incremental signal and the fine resolution in the HIPERFACE module, a very high positioning resolution is achieved in spite of the moderate signal frequencies used.

The parameter memory contained in the HIPERFACE encoder is currently not used by B&R. Therefore, the "embedded parameter chip" function is currently not available. ¹⁾

During start-up, the module is automatically identified, configured and its parameters set by the ACOPOSmulti drive system's operating system.

1) "Embedded parameter chip" function available starting with Firmware version V1.221.

24.2 Order data


Model number	Short description	Figure
8BAC0121.000-1	ACOPOSMulti plug-in module, HIPERFACE interface	

Table 115: Order data - HIPERFACE plug-in module 8BAC0121.000-1

24.3 Technical data

Product ID	8BAC0121.000-1
General information	
C-UL-US listed	Yes
Module type	ACOPOSMulti plug-in module
Slot ¹⁾	Slots 1 and 2
Max. power consumption	$P_{\text{module}} [\text{mW}] = 25 \text{ V} \cdot I_{25\text{VDC}} [\text{mA}]$ $I_{25\text{VDC}} [\text{mA}] = I_{\text{encoder}} [\text{mA}] \cdot 0.48 + 50$
Encoder connection ²⁾	
Connection, module-side	15-pin DSub socket
Indicators	UP/DN LEDs
Electrical isolation Encoder - ACOPOSMulti	No
Encoder monitoring	Yes
Maximum encoder cable length	75 m
Encoder supply	
Output voltage	Typ. 10 V
Load capacity	130 mA ³⁾
Sense lines	... ⁴⁾
Protective measures / safeguards Overload protection Short circuit protection	Yes Yes

Table 116: Technical data - HIPERFACE plug-in module 8BAC0121

Technical data • HIPERFACE plug-in module 8BAC0121.000-1

Product ID	8BAC0121.000-1
Sine-cosine inputs	
Signal transfer	Differential signal, asymmetric
Differential voltage	0.5 to 1.25 V _{SS}
Common mode voltage	max. ± 7 V
Terminating resistor	120 Ω
Signal frequency	DC up to 200 kHz
ADC resolution	12-bit
Asynchronous serial interface	
Signal transfer	RS485
Data transfer rate	9600 bit/s
Position	
Resolution @ 1 V _{SS} ⁵⁾	Number of encoder lines * 5700
Accuracy ⁶⁾	---
Noise ⁶⁾	---
Operational conditions	
Ambient temperature during operation	... ⁷⁾
Relative humidity during operation	... ⁷⁾
Storage and transport conditions	
Storage temperature	-25 to +55°C
Relative humidity during storage	5 to 95%, non-condensing
Transport temperature	-25 to +70°C
Relative humidity during transport	Max. 95% at +40°C

Table 116: Technical data - HIPERFACE plug-in module 8BAC0121 (cont.)

- 1) The 8BAC0121.000-1 is an encoder module. Up to two encoder modules can be connected. In this case, the encoder module in the first slot automatically serves as motor feedback for the first axis and the encoder module in the second slot serves as motor feedback for the second axis. The second slot can be used for other purposes when in single-axis operation.
- 2) The HIPERFACE encoder must be wired using a cable with a single shield.
- 3) An additional reserve of 40 mA is available for terminating resistors.
- 4) No sense lines are present because the supply voltage for the HIPERFACE encoder is permitted to lie between 7 and 12 V.
- 5) This value does not correspond to the encoder resolution that must be configured in Automation Studio (16384 * number of encoder lines).
- 6) In the field, this is limited by the encoder.
- 7) ACOPOSmulti plug-in modules can be used in an ACOPOSmulti inverter or power supply module; the corresponding values can be found in the technical data of the respective ACOPOSmulti inverter or power supply module.

24.4 Indicators

The indicators (UP/DN LEDs) are located on the front of the ACOPOSmulti drive or power supply module where the plug-in module is installed.

The UP/DN LEDs are lit depending on the rotational direction and the speed of the connected encoder.¹⁾

UP LED ... indicates when the encoder position changes in the positive direction.

DN LED ... indicates when the encoder position changes in the negative direction.

24.5 Firmware

The firmware is part of the operating system for the ACOPOSmulti drive system. The firmware is updated by updating the ACOPOSmulti operating system.

1) The count direction of the encoder can be configured in Automation Studio. However, changing the count direction in Automation Studio does not change the actual count direction of the encoder and therefore does not affect the UP/DN LEDs!

25. Resolver plug-in module 8BAC0122.000-1

25.1 General description

The Resolver plug-in module 8BAC0122.000-1 can be used in an ACOPOSmulti slot. The module contains a resolver interface for evaluating BRX resolvers.

The plug-in module handles the output from resolvers which are built into B&R servo motors or used as an encoder for external axes. This resolver delivers the absolute position over one revolution. Normally, the movement path is longer than one revolution. In this case, a reference switch must be used and a homing procedure carried out.

The encoder input signals are monitored. In this way, broken connections, shorted lines and encoder supply failure (reference signal) can be recognized.

During start-up, the AC122 module is automatically identified by the ACOPOSmulti operating system. Making automatic adjustments to the motor (resolution parameter) and reading the motor parameters and limit values is not possible because the resolver does not have parameter memory like the EnDat encoder.

If the precision, resolution, bandwidth or ease of setting parameters is not sufficient with the resolver, the EnDat system should be used (see).

25.2 Order data


Model number	Short description	Figure
8BAC0122.000-1	ACOPOSmulti plug-in module, resolver interface 10 kHz	

Table 117: Order data - resolver plug-in module 8BAC0122

Technical data • Resolver plug-in module 8BAC0122.000-1

Optional accessories				
Model number	Amount	Short description	Comment	Page
8BCR0005.1111A-0	1	ACOPOSMulti resolver cable, length 5 m, 3 x 2 x 24 AWG (19 x 0.127), Resolver plug, 12-pin SpeedTec Socket, 9-pin servo connector DSUB plug, can be used in cable drag chains, UL/CSA certified	---	227
8BCR0007.1111A-0	1	ACOPOSMulti resolver cable, length 7 m, 3 x 2 x 24 AWG (19 x 0.127), Resolver plug, 12-pin SpeedTec Socket, 9-pin servo connector DSUB plug, can be used in cable drag chains, UL/CSA certified	---	227
8BCR0010.1111A-0	1	ACOPOSMulti resolver cable, length 10 m, 3 x 2 x 24 AWG (19 x 0.127), Resolver plug, 12-pin SpeedTec Socket, 9-pin servo connector DSUB plug, can be used in cable drag chains, UL/CSA certified	---	227
8BCR0015.1111A-0	1	ACOPOSMulti resolver cable, length 15 m, 3 x 2 x 24 AWG (19 x 0.127), Resolver plug, 12-pin SpeedTec Socket, 9-pin servo connector DSUB plug, can be used in cable drag chains, UL/CSA certified	---	227
8BCR0020.1111A-0	1	ACOPOSMulti resolver cable, length 20 m, 3 x 2 x 24 AWG (19 x 0.127), Resolver plug, 12-pin SpeedTec Socket, 9-pin servo connector DSUB plug, can be used in cable drag chains, UL/CSA certified	---	227
8BCR0025.1111A-0	1	ACOPOSMulti resolver cable, length 25 m, 3 x 2 x 24 AWG (19 x 0.127), Resolver plug, 12-pin SpeedTec Socket, 9-pin servo connector DSUB plug, can be used in cable drag chains, UL/CSA certified	---	227

Table 118: Optional accessory - resolver plug-in module 8BAC0122

25.3 Technical data

Product ID	8BAC0122.000-1
General information	
C-UL-US listed	Yes
Module type	ACOPOSmulti plug-in module
Slot ¹⁾	Slots 1 and 2
Max. power consumption	1 W
Encoder connection ²⁾	
Connection, module-side	9-pin DSUB socket
Indicators	UP/DN LEDs
Electrical isolation Encoder - ACOPOSmulti	No
Encoder monitoring	Yes
Max. encoder cable length	100 m
Encoder supply	
Signal transfer	Differential signals
Frequency	10 kHz
Output voltage	Typically 3 V _{eff}
Output current	Max. 50 mA _{eff}
Protective measures Overload protection Short circuit protection	Yes Yes
Analog inputs	
Signal transfer	Differential signals
Input voltage	Resolver ratio: 0.5 ±10%
Input impedance	10.4 kΩ - j 11.1 kΩ
Common mode voltage	max. ± 20 V
ADC resolution	14-bit
Position	
Resolution @ $\ddot{u} = 0.5$	Number of pole pairs * 22600
Bandwidth	In preparation
Accuracy	In preparation
Noise	In preparation
Operational conditions	
Ambient temperature during operation	... ³⁾
Relative humidity during operation	... ³⁾

Table 119: Technical data - resolver plug-in module 8BAC0122

Product ID	8BAC0122.000-1
Storage and transport conditions	
Storage temperature	-25 to +55°C
Relative humidity during storage	5 to 95%, non-condensing
Transport temperature	-25 to +70°C
Relative humidity during transport	Max. 95% at +40°C

Table 119: Technical data - resolver plug-in module 8BAC0122 (cont.)

- 1) The 8BAC0122.000-1 is an encoder module. Two encoder modules can also be connected. In this case, the encoder module in the first slot automatically serves as motor feedback for the first axis and the encoder module in the second slot serves as motor feedback for the second axis. The second slot can be used for other purposes when in single-axis operation.
- 2) The resolver must be wired using a cable with a single shield and twisted pair signal lines.
- 3) ACOPOSmulti plug-in modules can be used in an ACOPOSmulti inverter or power supply module; the corresponding values can be found in the technical data of the respective ACOPOSmulti inverter or power supply module.

25.4 Indicators

The indicators (UP/DN LEDs) are located on the front of the ACOPOSmulti drive or power supply module where the plug-in module is installed.

The UP/DN LEDs are lit depending on the rotational direction and the speed of the connected encoder. ¹⁾

UP LED ... indicates when the encoder position changes in the positive direction.

DN LED ... indicates when the encoder position changes in the negative direction.

25.5 Firmware

The firmware is part of the operating system for the ACOPOSmulti drive system. The firmware is updated by updating the ACOPOSmulti operating system.

¹⁾ The count direction of the encoder can be configured in Automation Studio. However, changing the count direction in Automation Studio does not change the actual count direction of the encoder and therefore does not affect the UP/DN LEDs!

26. Incremental/SSI encoder plug-in module 8BAC0123.000-1

26.1 General description

The Incremental/SSI encoder plug-in module 8BAC0123.000-1 can be used in an ACOPOSmulti slot. The module has an incremental/SSI encoder interface for encoders with a +5V or +24V encoder supply.

The plug-in module is suitable for

- Incremental encoder RS422 output signals
- SSI encoder (absolute encoder with synchronous serial interface)
- Tracer pins and similar face sensors with a digital output

The plug-in module mainly handles evaluation of encoders built into motors from other manufacturers as well the evaluation of encoders in external axes (encoders that evaluate any machine movement).

Information:

Only incremental encoders with square-wave signals with a 90° phase shift can be evaluated. Evaluation of incremental encoders with a sine/cosine output or pulse direction outputs is not possible!

B&R recommends using encoders with RS422 signals and a +5V encoder supply. They provide the highest level of immunity to interference with the lowest power consumption and are best suited for high counter frequencies.

When used for tracer pins, the module is only used as a fast trigger input. Unlike trigger inputs on the ACOPOSmulti inverter and power supply modules, sensors with an RS422 output can be connected here. The necessary auxiliary inputs for tracer pins with infrared transfer are also available.

The plug-in module provides connections for a motor temperature sensor (T+, T-) so that motors from other manufacturers can be connected without problems. ¹⁾

1) ACOPOSmulti plug-in module in SLOT1:

The temperature sensor connections (T+, T-) on the ACOPOSmulti plug-in module can be evaluated by all ACOPOSmulti power supply and inverter modules.

ACOPOSmulti plug-in module in SLOT2:

The temperature sensor connections (T+, T-) on the ACOPOSmulti plug-in module can only be evaluated by ACOPOSmulti two-axis inverter modules (8BV1xxxxHxD0.000-1).

During start-up, the plug-in module is automatically identified by the ACOPOSmulti drive system's operating system. Making automatic adjustments to the motor (resolution parameter) and reading the motor parameters and limit values is not possible because incremental and SSI encoders do not have parameter memory like the EnDat encoder.

All 4 edges are always evaluated during incremental encoder operation, therefore the counter frequency is 4x the input frequency.

The module is equipped with a configurable digital input filter. In this way, the filter effect and edge interval monitoring can be adjusted in 4 steps according to the maximum frequency required by the application. The lowest maximum frequency is set as default!

Monitoring functions

Incremental encoder operation

Errors that can be detected	Possible cause of the error	Remarks
Cable disturbance AB	<ul style="list-style-type: none"> Open connection on channel A and B Signal A, B not connected Short circuit between the wires, to ground or to the encoder supply Short circuit or open connection on the encoder supply Signal amplitude too low Common mode voltage to high 	Monitoring can be switched off via software (for encoders with too few steep edges).
Cable disturbance R	<ul style="list-style-type: none"> Open connection on channel R Signal R not connected Short circuit between the wires, to ground or to the encoder supply Short circuit or open connection on the encoder supply Signal amplitude too low Common mode voltage to high 	Monitoring can be switched off via software (for encoders with too few steep edges or for encoders without an R signal).
Signal disturbance	<ul style="list-style-type: none"> Edge interval A-B too small 	The permitted edge interval is determined automatically according to the specified max. input frequency.
Counter error (the interval from reference pulse to reference pulse is incorrect)	<ul style="list-style-type: none"> Shield, cabling or encoder defective The interval from reference pulse to reference pulse is configured incorrectly 	Monitoring of encoders with an R signal not possible
Encoder current requirements are not normal	<ul style="list-style-type: none"> Short circuit or open connection on the encoder cable or in the encoder Deterioration of the light source or dirt on the encoder disk 	The currently valid power consumption requirements can be read, and monitoring takes place in the application program. If the value goes below the minimum value, an error bit is also set. This monitoring can be switched off.

Table 120: Monitoring functions during incremental encoder operation

SSI encoder operation

Errors that can be detected	Possible cause of the error	Remarks
Cable disturbance D	<ul style="list-style-type: none"> • Open connection on channel D • Signal D not connected • Short circuit between D and DI, to ground or to the encoder supply • Short circuit or open connection on the encoder supply • Signal amplitude too low • Common mode voltage to high 	---
Parity error	<ul style="list-style-type: none"> • High level of disturbance • Parity monitoring configured incorrectly (Odd, Even, None) 	Monitoring only possible for encoders with a parity bit
Plausibility errors	<ul style="list-style-type: none"> • High level of disturbance • Position does not match the expected value 2x consecutively 	Monitoring can be switched off
Encoder current requirements are not normal	<ul style="list-style-type: none"> • Short circuit or open connection on the encoder cable or in the encoder • Deterioration of the light source or dirt on the encoder disk 	The currently valid power consumption requirements can be read, and monitoring takes place in the application program. If the value goes below the minimum value, an error bit is also set. This monitoring can be switched off.

Table 121: Monitoring functions during SSI encoder operation

Sensing device operation

Errors that can be detected	Possible cause of the error	Remarks
Cable disturbance AB	<ul style="list-style-type: none"> • Open connection on channel A and B • Signal AB not connected • Short circuit between the wires, to ground or to the encoder supply • Short circuit or open connection on the sensing device supply • Signal amplitude too low • Common mode voltage to high 	Monitoring can be switched off via software (for sensing devices with too few steep edges and sensing devices that do not require the A, B inputs)
Cable disturbance R	<ul style="list-style-type: none"> • Open connection on channel R • Signal R not connected • Short circuit between the wires, to ground or to the encoder supply • Short circuit or open connection on the sensing device supply • Signal amplitude too low • Common mode voltage to high 	Monitoring can be switched off via software (for sensing devices with too few steep edges).
Encoder current requirements are not normal	<ul style="list-style-type: none"> • Short circuit or open connection on the connection cable or in the sensing device 	The currently valid power consumption requirements can be read, and monitoring takes place in the application program. If the value goes below the minimum value, an error bit is also set. This monitoring can be switched off.

Table 122: Monitoring functions during sensing device operation

26.2 Order data

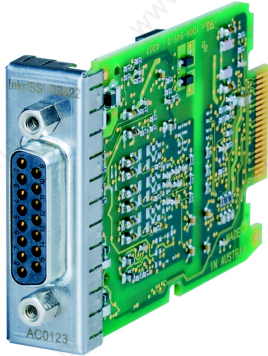
Model number	Short description	Figure
8BAC0123.000-1	ACOPOSMulti plug-in module, incremental encoder and SSI absolute encoder interface for RS422 signals	

Table 123: Order data - Incremental/SSI encoder plug-in module 8BAC0123.000-1

26.3 Technical data

Product ID	8BAC0123.000-1
General information	
C-UL-US listed	Yes
Module type	ACOPOSMulti plug-in module
Slot ¹⁾	Slots 1 and 2
Power consumption Encoder supply 5V Encoder supply 24V	$P_{\text{module}} [\text{mW}] = 25 \text{ V} \cdot ((I_{\text{encoder}} [\text{mA}] \cdot 0.42) + 0.45)^2$ $P_{\text{module}} [\text{mW}] = 25 \text{ V} \cdot (I_{\text{encoder}} [\text{mA}] + 0.45)^2$
Encoder connection	
Connection, module-side	15-pin DSUB socket
Indicators	UP/DN LEDs
Electrical isolation Encoder - ACOPOSMulti	Yes
Encoder monitoring	Yes
Max. encoder cable length	100 m ³⁾

Table 124: Technical data - Incremental/SSI encoder plug-in module 8BAC0123.000-1

Technical data • Incremental/SSI encoder plug-in module 8BAC0123.000-1

Product ID	8BAC0123.000-1
Encoder supply 5V	
Output voltage	5 V \pm 5%
Load capacity	350 mA ⁴⁾
Sense lines Amount Max. compensation	2 2 x 1.5 V
Protective measures Overload protection Short circuit protection	Yes Yes
Encoder supply 24V	
Output voltage	24 V \pm 10%
Load capacity	300 mA ⁵⁾
Sense lines	No
Protective measures Overload protection Short circuit protection	Yes Yes
Inputs A, B, R, D	
Signal transfer	RS422
Differential voltage	\pm 0.5 V to \pm 7 V ⁶⁾
Common-mode voltage relative to COM	-10 V to +13 V
Terminating resistor	120 Ω (difference)
Incremental encoder operation	
Signal form	Square wave pulse
Evaluation	4x
Input frequency ⁷⁾	Max. 50 / 100 / 200 / 400 kHz
Counter frequency	Max. 200 / 400 / 800 / 1600 kHz
Reference frequency	Max. 50 / 100 / 200 / 400 kHz
Distance between edges ⁸⁾	Min. 1.3 / 0.7 / 0.4 / 0.2 μ s
SSI absolute encoder operation	
Coding	Gray, binary
Baud rate	390 kBaud
Word size	Max. 31-bit
Differential voltage clock output to 120 Ω	Typ. 2.5 V
Operational conditions	
Ambient temperature during operation	... ⁹⁾
Relative humidity during operation	... ⁹⁾

Table 124: Technical data - Incremental/SSI encoder plug-in module 8BAC0123.000-1 (cont.)

Product ID	8BAC0123.000-1
Storage and transport conditions	
Storage temperature	-25 to +55°C
Relative humidity during storage	5 to 95%, non-condensing
Transport temperature	-25 to +70°C
Relative humidity during transport	Max. 95% at +40°C

Table 124: Technical data - Incremental/SSI encoder plug-in module 8BAC0123.000-1 (cont.)

- 1) The 8BAC0123.000-1 is an encoder module. Two encoder modules can also be connected. In this case, the encoder module in the first slot automatically serves as motor feedback for the first axis and the encoder module in the second slot serves as motor feedback for the second axis. The second slot can be used for other purposes when in single-axis operation.
- 2) I_{encoder} ... Current requirements for the incremental encoder. The current requirements for the terminating resistors is already included in the formula. A voltage drop on the encoder cable of max. $2 \times 1.5 \text{ V}$ is also included (only for 5V encoder supply).
- 3) The encoder must be wired using a cable with a single shield and twisted pair signal lines (e. g. $4 \times 2 \times 0.14 \text{ mm}^2 + 2 \times 0.5 \text{ mm}^2$).
- 4) An additional reserve of 60 mA is available for terminating resistors.
- 5) An additional reserve of 25 mA is available for terminating resistors.
- 6) With wire break monitoring deactivated, $\pm 0.2 \text{ V}$ is sufficient
- 7) Input filter can be configured using software.
- 8) Automatic adjustment to the selected input filter.
- 9) ACOPOSmulti plug-in modules can be used in an ACOPOSmulti inverter or power supply module; the corresponding values can be found in the technical data of the respective ACOPOSmulti inverter or power supply module.

26.4 Indicators

The indicators (UP/DN LEDs) are located on the front of the ACOPOSmulti drive or power supply module where the plug-in module is installed.

The UP/DN LEDs are lit depending on the rotational direction and the speed of the connected encoder. ¹⁾

UP LED ... indicates when the encoder position changes in the positive direction.

DN LED ... indicates when the encoder position changes in the negative direction.

26.5 Firmware

The firmware is part of the operating system for the ACOPOSmulti drive system. The firmware is updated by updating the ACOPOSmulti operating system.

1) The count direction of the encoder can be configured in Automation Studio. However, changing the count direction in Automation Studio does not change the actual count direction of the encoder and therefore does not affect the UP/DN LEDs!

27. Incremental encoder plug-in module 8BAC0123.001-1

27.1 General description

The incremental encoder plug-in module 8BAC0123.001-1 can be used in an ACOPOSmulti slot. The module has an incremental encoder interface for encoders with a +5V encoder supply.

The module is suitable for

- Incremental encoders with push, pull or push-pull outputs with no complementary signal
- Incremental encoders with symmetrical push-pull outputs that cannot handle such high loads

The plug-in module mainly handles evaluation of encoders built into motors from other manufacturers as well encoders in external axes (encoders that evaluate any machine movement).

Information:

Only incremental encoders with square-wave signals with a 90° phase shift can be evaluated. Evaluation of incremental encoders with a sine/cosine output or pulse direction outputs is not possible!

B&R recommends using encoders with RS422 signals and a 5V supply. They provide the highest level of immunity to interference with the lowest power consumption and are best suited for high counter frequencies. The plug-in module 8BAC0123.000-1 should be used to evaluate these encoders!

The plug-in module does not have line terminating resistors. Therefore encoders with low output current can be connected; however, the the module is only suitable for low counter frequencies or short encoder cables because of the possibility of line reflections.

The plug-in module provides connections for a motor temperature sensor (T+, T-) so that motors from other manufacturers can be connected without problems. ¹⁾

During start-up, the plug-in module is automatically identified by the ACOPOSmulti drive system's operating system. Making automatic adjustments to the motor (resolution parameter) and reading the motor parameters and limit values is not possible because incremental encoders do not have parameter memory like the EnDat encoder.

All 4 edges are always evaluated, therefore the counter frequency is 4x the input frequency.

1) ACOPOSmulti plug-in module in SLOT1:

The temperature sensor connections (T+, T-) on the ACOPOSmulti plug-in module can be evaluated by all ACOPOSmulti power supply and inverter modules.

ACOPOSmulti plug-in module in SLOT2:

The temperature sensor connections (T+, T-) on the ACOPOSmulti plug-in module can only be evaluated by ACOPOSmulti two-axis inverter modules (8BV0014HxD0.000-1, 8BV10028HxD0.000-1, 8BV10055HxD0.000-1).

The module is equipped with a configurable digital input filter. In this way, the filter effect and edge interval monitoring can be adjusted in 4 steps according to the maximum frequency required by the application. The lowest maximum frequency is set as default!

Monitoring functions

Incremental encoder operation

Errors that can be detected	Possible cause of the error	Remarks
Cable disturbance AB	<ul style="list-style-type: none"> • Open connection on channel A and B • Signals A, B not connected • Short circuit between the wires, to ground or to the encoder supply ¹⁾ • Short circuit or open connection on the encoder supply • Signal amplitude too low • Common mode voltage to high ¹⁾ 	Monitoring can be switched off via software (for encoders with too few steep edges).
Cable disturbance R	<ul style="list-style-type: none"> • Open connection on channel R • Signal R not connected • Short circuit between the wires, to ground or to the encoder supply ¹⁾ • Short circuit or open connection on the encoder supply • Signal amplitude too low • Common mode voltage to high ¹⁾ 	Monitoring can be switched off via software (for encoders with too few steep edges or for encoders without an R signal).
Signal disturbance	<ul style="list-style-type: none"> • Edge interval A-B too small 	The permitted edge interval is determined automatically according to the specified max. input frequency.
Counter error (the interval from reference pulse to reference pulse is incorrect)	<ul style="list-style-type: none"> • Shield, cabling or encoder defective • The interval from reference pulse to reference pulse is configured incorrectly 	Monitoring of encoders with an R signal not possible
Encoder current requirements are not normal	<ul style="list-style-type: none"> • Short circuit or open connection on the encoder cable or in the encoder • Deterioration of the light source or dirt on the encoder disk 	The currently valid power consumption requirements can be read, and monitoring takes place in the application program. If the value goes below the minimum value, an error bit is also set. This monitoring can be switched off.

Table 125: Monitoring functions during incremental encoder operation

1) Only relevant for encoders with differential signals.

27.2 Order data

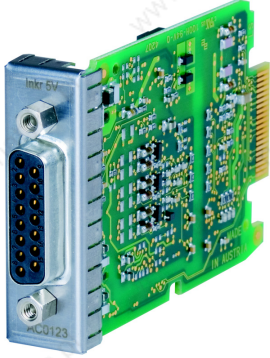
Model number	Short description	Figure
8BAC0123.001-1	ACOPOSMulti plug-in module, incremental encoder interface for 5V single-ended and 5V differential signals	

Table 126: Order data - Incremental encoder plug-in module 8BAC0123.001-1

27.3 Technical data

Product ID	8BAC0123.001-1
General information	
C-UL-US listed	Yes
Module type	ACOPOSMulti plug-in module
Slot ¹⁾	Slots 1 and 2
Power consumption	$P_{\text{module}} [\text{mW}] = 25 \text{ V} * (I_{\text{encoder}} [\text{mA}] * 0.42 + 48 \text{ mA})$ ²⁾
Encoder connection ³⁾	
Connection, module-side	15-pin DSUB socket
Indicators	UP/DN LEDs
Electrical isolation Encoder - ACOPOSMulti	Yes
Max. encoder cable length Incremental encoder SSI encoder	25 m ---

Table 127: Technical data - Incremental encoder plug-in module 8BAC0123.001-1

Technical data • Incremental encoder plug-in module 8BAC0123.001-1

Product ID	8BAC0123.001-1
Encoder supply 5V	
Output voltage	5 V ±5%
Load capacity	350 mA ⁴⁾
Sense lines Amount Max. compensation	2 2 x 1.5 V
Protective measures Overload protection Short circuit protection	Yes Yes
Inputs A, B, R	
Single-ended signals Input voltage for HIGH Input voltage for LOW Maximum input voltage	> 2.4 V (to COM) < 1.0 V (to COM) -10 V / +13V (to COM)
Differential signals Differential voltage Maximum input voltage	±0.8 V to ±23 V ⁵⁾ -10 V / +13 V (to COM)
Input resistance	See block diagram
Incremental encoder operation	
Signal form	Square wave pulse
Evaluation	4x
Input frequency ⁶⁾	Max. 25 / 50 / 100 / 200 kHz
Counter frequency	Max. 100 / 200 / 400 / 800 kHz
Reference frequency	Max. 25 / 50 / 100 / 200 kHz
Distance between edges ⁷⁾	Min. 2.6 / 1.3 / 0.7 / 0.4 µs
Operational conditions	
Ambient temperature during operation	... ⁸⁾
Relative humidity during operation	... ⁸⁾

Table 127: Technical data - Incremental encoder plug-in module 8BAC0123.001-1 (cont.)

Product ID	8BAC0123.001-1
Storage and transport conditions	
Storage temperature	-25 to +55°C
Relative humidity during storage	5 to 95%, non-condensing
Transport temperature	-25 to +70°C
Relative humidity during transport	Max. 95% at +40°C

Table 127: Technical data - Incremental encoder plug-in module 8BAC0123.001-1 (cont.)

- 1) The 8BAC0123.001-1 is an encoder module. Two encoder modules can also be connected. In this case, the encoder module in the first slot automatically serves as motor feedback for the first axis and the encoder module in the second slot serves as motor feedback for the second axis. The second slot can be used for other purposes when in single-axis operation.
- 2) I_{encoder} ... Current requirements for the incremental encoder. The current requirements for the terminating resistors is already included in the formula. A voltage drop on the encoder cable of max. $2 \times 1.5 \text{ V}$ is also included.
- 3) The encoder must be wired using a cable with a single shield and twisted pair signal lines (e. g. $4 \times 2 \times 0.14 \text{ mm}^2 + 2 \times 0.5 \text{ mm}^2$).
- 4) An additional reserve of 60 mA is available for terminating resistors.
- 5) With wire break monitoring deactivated, $\pm 0.5 \text{ V}$ is sufficient
- 6) Input filter can be configured using software.
- 7) Automatic adjustment to the selected input filter.
- 8) ACOPOSmulti plug-in modules can be used in an ACOPOSmulti inverter or power supply module; the corresponding values can be found in the technical data of the respective ACOPOSmulti inverter or power supply module.

27.4 Indicators

The indicators (UP/DN LEDs) are located on the front of the ACOPOSmulti drive or power supply module where the plug-in module is installed.

The UP/DN LEDs are lit depending on the rotational direction and the speed of the connected encoder. ¹⁾

UP LED ... indicates when the encoder position changes in the positive direction.

DN LED ... indicates when the encoder position changes in the negative direction.

27.5 Firmware

The firmware is part of the operating system for the ACOPOSmulti drive system. The firmware is updated by updating the ACOPOSmulti operating system.

1) The count direction of the encoder can be configured in Automation Studio. However, changing the count direction in Automation Studio does not change the actual count direction of the encoder and therefore does not affect the UP/DN LEDs!

28. Incremental encoder plug-in module 8BAC0123.002-1

28.1 General description

The incremental encoder plug-in module 8BAC0123.002-1 can be used in an ACOPOSmulti slot. The module has an incremental encoder interface for encoders with a +24V encoder supply.

The module is suitable for

- Incremental encoders with push, pull or push-pull outputs with no complementary signal
- Incremental encoders with symmetrical push-pull outputs
- Tracer pins and similar face sensors with a digital output

The plug-in module mainly handles evaluation of encoders built into motors from other manufacturers as well encoders in external axes (encoders that evaluate any machine movement).

Information:

Only incremental encoders with square-wave signals with a 90° phase shift can be evaluated. Evaluation of incremental encoders with a sine/cosine output or pulse direction outputs is not possible!

B&R recommends using encoders with RS422 signals and a 5V supply. They provide the highest level of immunity to interference with the lowest power consumption and are best suited for high counter frequencies. The plug-in module 8BAC0123.000-1 should be used to evaluate these encoders!

The plug-in module does not have line terminating resistors. Therefore encoders with low output current can be connected; however, the the module is only suitable for low counter frequencies or short encoder cables because of the possibility of line reflections.

When used for tracer pins, the module is only used as a fast trigger input. The necessary auxiliary inputs for tracer pins with infrared transfer are available.

The plug-in module provides connections for a motor temperature sensor (T+, T-) so that motors from other manufacturers can be connected without problems. ¹⁾

1) ACOPOSmulti plug-in module in SLOT1:

The temperature sensor connections (T+, T-) on the ACOPOSmulti plug-in module can be evaluated by all ACOPOSmulti power supply and inverter modules.

ACOPOSmulti plug-in module in SLOT2:

The temperature sensor connections (T+, T-) on the ACOPOSmulti plug-in module can only be evaluated by ACOPOSmulti two-axis inverter modules (8BV0014HxD0.000-1, 8BVI0028HxD0.000-1, 8BVI0055HxD0.000-1).

During start-up, the plug-in module is automatically identified by the ACOPOSmulti drive system's operating system. Making automatic adjustments to the motor (resolution parameter) and reading the motor parameters and limit values is not possible because incremental encoders do not have parameter memory like the EnDat encoder.

All 4 edges are always evaluated, therefore the counter frequency is 4x the input frequency.

The module is equipped with a configurable digital input filter. In this way, the filter effect and edge interval monitoring can be adjusted in 4 steps according to the maximum frequency required by the application. The lowest maximum frequency is set as default!

Monitoring functions

Incremental encoder operation

Errors that can be detected	Possible cause of the error	Remarks
Cable disturbance AB	<ul style="list-style-type: none"> Open connection on channel A and B Signals A, B not connected Short circuit between the wires, to ground or to the encoder supply ¹⁾ Short circuit or open connection on the encoder supply Signal amplitude too low Common mode voltage to high ¹⁾ 	Monitoring can be switched off via software (for encoders with too few steep edges).
Cable disturbance R	<ul style="list-style-type: none"> Open connection on channel R Signal R not connected Short circuit between the wires, to ground or to the encoder supply ¹⁾ Short circuit or open connection on the encoder supply Signal amplitude too low Common mode voltage to high ¹⁾ 	Monitoring can be switched off via software (for encoders with too few steep edges or for encoders without an R signal).
Signal disturbance	<ul style="list-style-type: none"> Edge interval A-B too small 	The permitted edge interval is determined automatically according to the specified max. input frequency.
Counter error (the interval from reference pulse to reference pulse is incorrect)	<ul style="list-style-type: none"> Shield, cabling or encoder defective The interval from reference pulse to reference pulse is configured incorrectly 	Monitoring of encoders with an R signal not possible
Encoder current requirements are not normal	<ul style="list-style-type: none"> Short circuit or open connection on the encoder cable or in the encoder Deterioration of the light source or dirt on the encoder disk 	The currently valid power consumption requirements can be read, and monitoring takes place in the application program. If the value goes below the minimum value, an error bit is also set. This monitoring can be switched off.

Table 128: Monitoring functions during incremental encoder operation

1) Only relevant for encoders with differential signals.

Sensing device operation

Errors that can be detected	Possible cause of the error	Remarks
Cable disturbance AB	<ul style="list-style-type: none"> • Open connection on channel A and B • Short circuit between the wires, to ground or to the encoder supply ¹⁾ • Short circuit or open connection on the sensing device supply • Signal amplitude too low • Common mode voltage to high ¹⁾ 	Monitoring can be switched off via software (for sensing devices with too few steep edges and sensing devices that do not require the A, B inputs)
Cable disturbance R	<ul style="list-style-type: none"> • Open connection on channel R • Short circuit between the wires, to ground or to the encoder supply ¹⁾ • Short circuit or open connection on the sensing device supply • Signal amplitude too low • Common mode voltage to high ¹⁾ • Signal R not connected 	Monitoring can be switched off via software (for sensing devices with too few steep edges).
Encoder current requirements are not normal	<ul style="list-style-type: none"> • Short circuit or open connection on the connection cable or in the sensing device 	The currently valid power consumption requirements can be read, and monitoring takes place in the application program. If the value goes below the minimum value, an error bit is also set. This monitoring can be switched off.

Table 129: Monitoring functions during sensing device operation

1) Only relevant for encoders with differential signals.

28.2 Order data

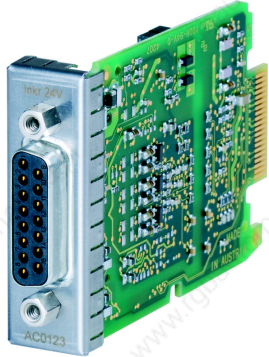
Model number	Short description	Figure
8BAC0123.002-1	ACOPOSmulti plug-in module, incremental encoder interface for 24 V single-ended and 24 V differential signals	 <p>The image shows a green printed circuit board (PCB) with a silver metal housing. On the left side, there is a multi-pin connector and two circular ports. The PCB is populated with various electronic components, including integrated circuits and resistors. The model number '8BAC0123' is printed on the bottom of the metal housing.</p>

Table 130: Order data - Incremental encoder plug-in module 8BAC0123.002-1

28.3 Technical data

Product ID	8BAC0123.002-1
General information	
C-UL-US listed	Yes
Module type	ACOPOSmulti plug-in module
Slot ¹⁾	Slots 1 and 2
Power consumption ²⁾	$P_{\text{module}} [\text{mW}] = 25 \text{ V} \cdot (I_{\text{encoder}} [\text{mA}] + 60 \text{ mA})$
Encoder connection ³⁾	
Connection, module-side	15-pin DSUB socket
Indicators	UP/DN LEDs
Electrical isolation Encoder - ACOPOSmulti	Yes
Max. encoder cable length	25 m
Encoder supply 24V	
Output voltage	24 V \pm 10%
Load capacity	300 mA ⁴⁾
Sense lines	---
Protective measures Overload protection Short circuit protection	Yes Yes
Inputs A, B, R	
Single-ended signals Input voltage for HIGH Input voltage for LOW Maximum input voltage	> 14 V (to COM) < 5.5 V (to COM) -15 V / +30 V (to COM)
Differential signals Differential voltage Maximum input voltage	$\pm 4 \text{ V to } \pm 30 \text{ V}^5)$ -15 V / +30 V (to COM)
Input resistance	See block diagram
Incremental encoder operation	
Signal form	Square wave pulse
Evaluation	4x
Input frequency ⁶⁾	Max. 25 / 50 / 100 / 200 kHz
Counter frequency	Max. 100 / 200 / 400 / 800 kHz
Reference frequency	Max. 25 / 50 / 100 / 200 kHz
Distance between edges ⁷⁾	Min. 2.6 / 1.3 / 0.7 / 0.4 μs
Operational conditions	
Ambient temperature during operation	... ⁸⁾
Relative humidity during operation	... ⁸⁾

Table 131: Technical data - Incremental encoder plug-in module 8BAC0123.002-1

Product ID	8BAC0123.002-1
Storage and transport conditions	
Storage temperature	-25 to +55°C
Relative humidity during storage	5 to 95%, non-condensing
Transport temperature	-25 to +70°C
Relative humidity during transport	Max. 95% at +40°C

Table 131: Technical data - Incremental encoder plug-in module 8BAC0123.002-1 (cont.)

- 1) The 8BAC0123.002-1 is an encoder module. Two encoder modules can also be connected. In this case, the encoder module in the first slot automatically serves as motor feedback for the first axis and the encoder module in the second slot serves as motor feedback for the second axis. The second slot can be used for other purposes when in single-axis operation.
- 2) I_{encoder} ... Current requirements for the incremental encoder. The current requirements for the terminating resistors is already included in the formula.
- 3) The encoder must be wired using a cable with a single shield and twisted pair signal lines (e. g. 4 x 2 x 0.14 mm² + 2 x 0.5 mm²).
- 4) An additional reserve of 25 mA is available for terminating resistors.
- 5) With wire break monitoring deactivated, +/- 2.5 V is sufficient
- 6) Input filter can be configured using software.
- 7) Automatic adjustment to the selected input filter.
- 8) ACOPOSmulti plug-in modules can be used in an ACOPOSmulti inverter or power supply module; the corresponding values can be found in the technical data of the respective ACOPOSmulti inverter or power supply module.

28.4 Indicators

The indicators (UP/DN LEDs) are located on the front of the ACOPOSmulti drive or power supply module where the plug-in module is installed.

The UP/DN LEDs are lit depending on the rotational direction and the speed of the connected encoder. ¹⁾

UP LED ... indicates when the encoder position changes in the positive direction.

DN LED ... indicates when the encoder position changes in the negative direction.

28.5 Firmware

The firmware is part of the operating system for the ACOPOSmulti drive system. The firmware is updated by updating the ACOPOSmulti operating system.

1) The count direction of the encoder can be configured in Automation Studio. However, changing the count direction in Automation Studio does not change the actual count direction of the encoder and therefore does not affect the UP/DN LEDs!

29. SinCos plug-in module 8BAC0124.000-1

29.1 General description

The SinCos plug-in module 8BAC0124.000-1 can be used in an ACOPOSmulti slot. The module contains one interface for evaluating incremental encoders with a sinusoidal output signal. Limit switches can be connected.

The input signals are monitored. In this way, broken connections, shorted lines and encoder supply failure can be recognized. The encoder power supply has overload and short-circuit protection.

29.2 Order data

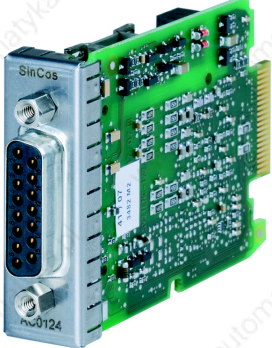
Model number	Short description	Figure
8BAC0124.000-1	ACOPOSmulti plug-in module, SinCos interface	

Table 132: Order data - SinCos plug-in module 8BAC0124

Technical data • SinCos plug-in module 8BAC0124.000-1

Optional accessories				
Model number	Amount	Short description	Comment	Page
8BCS0005.1111A-0	1	ACOPOSMulti SinCos cable, length 5 m, 10 x 0.14 mm ² + 2 x 0.5 mm ² , SinCos Plug, 12-pin SpeedTec socket, Servo plug, 15-pin DSUB plug, can be used in cable drag chains, UL/CSA Isited	---	229
8BCS0007.1111A-0	1	ACOPOSMulti SinCos cable, length 7 m, 10 x 0.14 mm ² + 2 x 0.5 mm ² , SinCos Plug, 12-pin SpeedTec socket, Servo plug, 15-pin DSUB plug, can be used in cable drag chains, UL/CSA Isited	---	229
8BCS0010.1111A-0	1	ACOPOSMulti SinCos cable, length 10 m, 10 x 0.14 mm ² + 2 x 0.5 mm ² , SinCos Plug, 12-pin SpeedTec socket, Servo plug, 15-pin DSUB plug, can be used in cable drag chains, UL/CSA Isited	---	229
8BCS0015.1111A-0	1	ACOPOSMulti SinCos cable, length 15 m, 10 x 0.14 mm ² + 2 x 0.5 mm ² , SinCos Plug, 12-pin SpeedTec socket, Servo plug, 15-pin DSUB plug, can be used in cable drag chains, UL/CSA Isited	---	229
8BCS0020.1111A-0	1	ACOPOSMulti SinCos cable, length 20 m, 10 x 0.14 mm ² + 2 x 0.5 mm ² , SinCos Plug, 12-pin SpeedTec socket, Servo plug, 15-pin DSUB plug, can be used in cable drag chains, UL/CSA Isited	---	229
8BCS0025.1111A-0	1	ACOPOSMulti SinCos cable, length 25 m, 10 x 0.14 mm ² + 2 x 0.5 mm ² , SinCos Plug, 12-pin SpeedTec socket, Servo plug, 15-pin DSUB plug, can be used in cable drag chains, UL/CSA Isited	---	229

Table 133: Optional accessory - SinCos plug-in module 8BAC0124

29.3 Technical data

Product ID	8BAC0124.000-1
General information	
C-UL-US listed	Yes
Module type	ACOPOSMulti plug-in module
Slot ¹⁾	Slots 1 and 2
Max. power consumption	$P_{\text{module}} [\text{mW}] = 25 \text{ V} \cdot I_{25\text{VDC}} [\text{mA}]$ $I_{25\text{VDC}} [\text{mA}] = I_{\text{encoder}} [\text{mA}] \cdot 0.37 + 32$
Encoder connection ²⁾	
Connection, module-side	15-pin DSUB socket
Indicators	UP/DN LEDs
Electrical isolation Encoder - ACOPOSMulti	No
Encoder monitoring	Yes
Max. encoder cable length	75 m

Table 134: Technical data - SinCos plug-in module 8BAC0124

Technical data • SinCos plug-in module 8BAC0124.000-1

Product ID	8BAC0124.000-1
Encoder supply	
Output voltage	5 V ± 5%
Load capacity	300 mA ³⁾
Sense lines	2, compensation of max. 2 x 0.7 V
Protective measures Overload protection Short circuit protection	Yes Yes
Sine-cosine inputs	
Signal transfer	Differential signals, symmetric
Differential voltage	0.5 to 1.25 V _{SS}
Common mode voltage	max. ± 7 V
Terminating resistor	120 Ω
Signal frequency (-5 dB)	DC up to 400 kHz
Signal frequency (-3 dB)	DC up to 300 kHz
ADC resolution	12-bit
Reference input	
Signal transfer	Differential signal, symmetric
Differential voltage for high	+0.2 V
Differential voltage for low	≤ -0.2 V
Common mode voltage	max. ± 7 V
Terminating resistor	120 Ω
Position	
Resolution @ 1 V _{SS} ⁴⁾	Number of encoder lines * 5700
Accuracy ⁵⁾	---
Noise ⁵⁾	---
Limit switch inputs ⁶⁾	
Number of inputs	2
Wiring	Source
Input resistance	1470 Ω
Electrical isolation Input - ACOPOSmulti Input - Input	No No
Input voltage minimum Rated Maximum	-12 V +5 V +20 V
Switching threshold LOW HIGH	< 0.8 V > 2 V
Switching delay	Max. 100µs
Operational conditions	
Ambient temperature during operation	... ⁷⁾
Relative humidity during operation	... ⁷⁾

Table 134: Technical data - SinCos plug-in module 8BAC0124 (cont.)

Product ID	8BAC0124.000-1
Storage and transport conditions	
Storage temperature	-25 to +55°C
Relative humidity during storage	5 to 95%, non-condensing
Transport temperature	-25 to +70°C
Relative humidity during transport	Max. 95% at +40°C

Table 134: Technical data - SinCos plug-in module 8BAC0124 (cont.)

- 1) The 8BAC0124.000-1 is an encoder module. Up to two encoder modules can be connected. In this case, the encoder module in the first slot automatically serves as motor feedback for the first axis and the encoder module in the second slot serves as motor feedback for the second axis. The second slot can be used for other purposes when in single-axis operation.
- 2) The encoder must be wired using a cable with a single shield and twisted pair signal lines.
- 3) An additional reserve of 12 mA is available for terminating resistors and limit switch inputs.
- 4) This value does not correspond to the encoder resolution that must be configured in Automation Studio (16384 * number of encoder lines).
- 5) In the field, this is limited by the encoder.
- 6) The measurement system offered by Heidenhain with limit switch outputs LIDA 47x, LIDA 48x and LIF4x1 was tested for compatibility. In the field, the cable length is limited by the encoder.
- 7) ACOPOSmulti plug-in modules can be used in an ACOPOSmulti inverter or power supply module; the corresponding values can be found in the technical data of the respective ACOPOSmulti inverter or power supply module.

29.4 Indicators

The indicators (UP/DN LEDs) are located on the front of the ACOPOSmulti drive or power supply module where the plug-in module is installed.

The UP/DN LEDs are lit depending on the rotational direction and the speed of the connected encoder. ¹⁾

UP LED ... indicates when the encoder position changes in the positive direction.

DN LED ... indicates when the encoder position changes in the negative direction.

29.5 Firmware

The firmware is part of the operating system for the ACOPOSmulti drive system. The firmware is updated by updating the ACOPOSmulti operating system.

1) The count direction of the encoder can be configured in Automation Studio. However, changing the count direction in Automation Studio does not change the actual count direction of the encoder and therefore does not affect the UP/DN LEDs!

30. Digital I/O plug-in module 8BAC0130.000-1

30.1 General description

The Digital I/O plug-in module 8BAC0130.000-1 can be used in SLOT2 of an ACOPOSmulti module.

The following +24 VDC inputs and output are available:

- Two digital inputs (sink)
- Two high-speed outputs with a maximum continuous current of 50mA. These are designed for a maximum switching frequency of 62.5 kHz (resistive load).
- Two readable standard outputs with a maximum continuous current of 500 mA. These are designed for a maximum switching frequency of 1.25 kHz (resistive load).

30.2 Order data

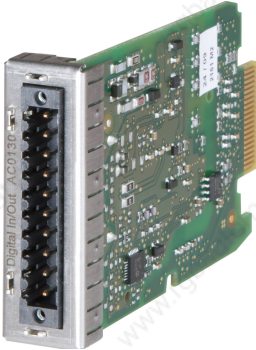
Model number	Short description	Figure
8BAC0130.000-1	ACOPOSmulti plug-in module, 2 digital outputs, 50 mA, max. 62.5 kHz, 2 digital outputs, 500 mA, max. 1.25 kHz, 2 digital inputs 24 VDC	

Table 135: Order data - Analog In plug-in module 8BAC0130.000-1

Required accessories				
Model number	Amount	Short description	Comment	Page
8TB1110.20D-00	1	Accessory terminal block (3.5), 10-pin screw clamp, 1.5 mm ² , protected against vibration by the screw flange, D coding: 1100110011	---	---
8TB1110.21D-00	1	Accessory terminal block (3.5), 10-pin cage clamp, 1.5 mm ² , protected against vibration by the screw flange, D coding: 1100110011	---	---

Table 136: Required accessories for Analog In plug-in module 8BAC0130.000-1

30.3 Technical data

Product ID	8BAC0130.000-1
General information	
C-UL-US listed	In preparation
Module type	ACOPOSmulti plug-in module
Slot	Slot 2
Max. power consumption	max. 800 mW
Connections	
Connection, module-side	10-pin connector
Indicators	UP-LED (module OK) and DN-LED (module NOT_OK)
Entrances	
Number of inputs	2
Wiring	Sink
Electrical isolation Input - ACOPOSmulti Input - Input	Yes No
Input voltage Rated Maximum	24 VDC 30 VDC
Input current at rated voltage	Approx. 11 mA
Switching delay	In preparation
Modulation compared to ground potential	Max. 30 V
High-speed outputs ¹⁾	
Number of outputs	2
Type	Push-pull
Electrical isolation Output - ACOPOSmulti Output - Output	Yes No
Switching voltage minimum Rated Maximum	18 VDC 24 VDC 30 VDC
Continuous current	Max. 50 mA
Switching delay 0 -> 1 and 1 -> 0	Max. 1 µs
Switching frequency (resistive load)	Max. 62.5 kHz
Protection Short circuit protection Overload protection	Yes Yes
Short circuit current at 24 V (until cut-off)	Approx. 0.2 A
Readable outputs	No

Table 137: Technical data - Analog In plug-in module 8BAC0130.000-1

Technical data • Digital I/O plug-in module 8BAC0130.000-1

Product ID	8BAC0130.000-1
Standard outputs	
Number of outputs	2
Type	High-side
Electrical isolation	
Output - ACOPOSmulti	Yes
Output - Output	No
Switching voltage	
minimum	18 VDC
Rated	24 VDC
Maximum	30 VDC
Continuous current	Max. 500 mA
Switching delay 0 -> 1 and 1 -> 0	Max. 50 µs
Switching frequency (resistive load)	Max. 1.25 kHz
Protection	
Short circuit protection	Yes
Overload protection	Yes
Short circuit current at 24 V (until cut-off)	Approx. 1.2 A
Readable outputs	Yes
Modulation compared to ground potential	Max. 30 V
Operational conditions	
Ambient temperature during operation	... 2)
Relative humidity during operation	... 2)
Storage and transport conditions	
Storage temperature	-25 to +55°C
Relative humidity during storage	5 to 95%, non-condensing
Transport temperature	-25 to +70°C
Relative humidity during transport	Max. 95% at +40°C

Table 137: Technical data - Analog In plug-in module 8BAC0130.000-1 (cont.)

- 1) Shielded cables must be used for high-speed inputs.
- 2) ACOPOSmulti plug-in modules can be used in an ACOPOSmulti inverter or power supply module; the corresponding values can be found in the technical data of the respective ACOPOSmulti inverter or power supply module.

30.4 Indicators

The indicators (UP/DN LEDs) are located on the front of the ACOPOSmulti drive or power supply module where the plug-in module is installed.

The UP/DN LEDs light up according to the module state.

UP-LED ... lit, if the module is functioning properly (green).

DN-LED ... lit, if the module is not (yet) functioning properly (red).

30.5 Firmware

The firmware is part of the operating system for the ACOPOSmulti drive system. The firmware is updated by updating the ACOPOSmulti operating system.

31. Digital Out plug-in module 8BAC0130.001-1

31.1 General description

The Digital Out plug-in module 8BAC0130.001-1 can be used in SLOT2 of an ACOPOSmulti module.

Six digital +24 VDC outputs are available:

- Two high-speed outputs with a maximum continuous current of 50 mA. These are designed for a maximum switching frequency of 62.5 kHz (resistive load).
- Four readable standard outputs with a maximum continuous current of 500 mA. These are designed for a maximum switching frequency of 1.25 kHz (resistive load).

31.2 Order data


Model number	Short description	Figure
8BAC0130.001-1	ACOPOSmulti plug-in module, 2 digital outputs, 50 mA, max. 62.5 kHz, 4 digital outputs, 500 mA, max. 1.25 kHz	

Table 138: Order data - Analog In plug-in module 8BAC0130.001-1

Required accessories				
Model number	Amount	Short description	Comment	Page
8TB1110.20C-00	1	Accessory terminal block (3.5), 10-pin screw clamp, 1.5 qmm, protected against vibration by the screw flange	---	---
8TB1110.21C-00	1	Accessory terminal block (3.5), 10-pin cage clamp, 1.5 qmm, protected against vibration by the screw flange	---	---

Table 139: Required accessories for Analog In plug-in module 8BAC0130.001-1

31.3 Technical data

Product ID	8BAC0130.001-1
General information	
C-UL-US listed	In preparation
Module type	ACOPOSmulti plug-in module
Slot	Slot 2
Max. power consumption	max. 800 mW
Connections	
Connection, module-side	10-pin connector
Indicators	UP-LED (module OK) and DN-LED (module NOT_OK)
High-speed outputs ¹⁾	
Number of outputs	2
Type	Push-pull
Electrical isolation	
Output - ACOPOSmulti	Yes
Output - Output	No
Switching voltage	
minimum	18 VDC
Rated	24 VDC
Maximum	30 VDC
Continuous current	Max. 50 mA
Switching delay 0 -> 1 and 1 -> 0	Max. 1 µs
Switching frequency (resistive load)	Max. 62.5 kHz
Protection	
Short circuit protection	Yes
Overload protection	Yes
Short circuit current at 24 V (until cut-off)	Approx. 0.2 A
Readable outputs	No
Standard outputs	
Number of outputs	4
Type	High-side
Electrical isolation	
Output - ACOPOSmulti	Yes
Output - Output	No
Switching voltage	
minimum	18 VDC
Rated	24 VDC
Maximum	30 VDC
Continuous current	Max. 500 mA
Switching delay 0 -> 1 and 1 -> 0	Max. 50 µs
Switching frequency (resistive load)	Max. 1.25 kHz
Protection	
Short circuit protection	Yes
Overload protection	Yes
Short circuit current at 24 V (until cut-off)	Approx. 1.2 A

Table 140: Technical data - Analog In plug-in module 8BAC0130.001-1

Technical data • Digital Out plug-in module 8BAC0130.001-1

Product ID	8BAC0130.001-1
Readable outputs	Yes
Modulation compared to ground potential	Max. 30 V
Operational conditions	
Ambient temperature during operation	... ²⁾
Relative humidity during operation	... ²⁾
Storage and transport conditions	
Storage temperature	-25 to +55°C
Relative humidity during storage	5 to 95%, non-condensing
Transport temperature	-25 to +70°C
Relative humidity during transport	Max. 95% at +40°C

Table 140: Technical data - Analog In plug-in module 8BAC0130.001-1 (cont.)

- 1) Shielded cables must be used for high-speed inputs.
- 2) ACOPOSmulti plug-in modules can be used in an ACOPOSmulti inverter or power supply module; the corresponding values can be found in the technical data of the respective ACOPOSmulti inverter or power supply module.

31.4 Indicators

The indicators (UP/DN LEDs) are located on the front of the ACOPOSmulti drive or power supply module where the plug-in module is installed.

The UP/DN LEDs light up according to the module state.

UP-LED ... lit, if the module is functioning properly (green).

DN-LED ... lit, if the module is not (yet) functioning properly (red).

31.5 Firmware

The firmware is part of the operating system for the ACOPOSmulti drive system. The firmware is updated by updating the ACOPOSmulti operating system.

32. Analog In plug-in module 8BAC0132.000-1

32.1 General description

The Analog In plug-in module 8BAC0132.000-1 can be used in an ACOPOSmulti slot. Four analog inputs are available (± 10 V differential inputs).

The analog inputs have a resolution of 14 bits and are scanned synchronously using the 50 μ s clock for the ACOPOSmulti inverter or power supply module. The analog inputs have a 30 kHz analog input filter (low pass 3rd order).

32.2 Order data


Model number	Short description	Figure
8BAC0132.000-1	ACOPOSmulti input module, 4 analog inputs ± 10 V	

Table 141: Order data - Analog In plug-in module 8BAC0132.000-1

Required accessories				
Model number	Amount	Short description	Comment	Page
8TB1110.20B-00	1	Screw clamp 10-pin, single-row, spacing: 3.5 mm, numbered serially, B coding: 0011111100	---	---
8TB1110.21B-00	1	Cage clamp 10-pin, single-row, spacing: 3.5 mm, B coding: 0011111100	---	---

Table 142: Required accessories for Analog In plug-in module 8BAC0132.000-1

32.3 Technical data

Product ID	8BAC0132.000-1
General information	
C-UL-US listed	Yes
Module type	ACOPOSmulti plug-in module
Slot	Slots 1 and 2
Max. power consumption	In preparation
Connections	
Connection, module-side	10-pin connector
Indicators	UP-LED (module OK) and DN-LED (module NOT_OK)
Analog inputs	
Number of inputs	4
Design	Differential input
Electrical isolation	
Input - ACOPOSmulti	Yes
Input - Input	No
Input signal	
Rated	-10 V to +10 V
Maximum	-15 V to +15 V
Operating mode	Cyclic measurement synchronous to 50 is
Digital converter resolution	14-bit
Non-linearity	±1 LSB
Conversion procedure	Successive approximation
Input conversion times	< 10 µs
Differential input impedance	> 10 MΩ
Input filter	Analog low pass 3rd order / cut-off frequency: 30 kHz
Common-mode rejection	
DC	In preparation
50 Hz	In preparation
Operational conditions	
Ambient temperature during operation	... 1)
Relative humidity during operation	... 1)
Storage and transport conditions	
Storage temperature	-25 to +55°C
Relative humidity during storage	5 to 95%, non-condensing
Transport temperature	-25 to +70°C
Relative humidity during transport	Max. 95% at +40°C

Table 143: Technical data - Analog In plug-in module 8BAC0132.000-1

1) ACOPOSmulti plug-in modules can be used in an ACOPOSmulti inverter or power supply module; the corresponding values can be found in the technical data of the respective ACOPOSmulti inverter or power supply module.

32.4 Indicators

The indicators (UP/DN LEDs) are located on the front of the ACOPOSmulti drive or power supply module where the plug-in module is installed.

The UP/DN LEDs light up according to the module state.

UP-LED ... lit, if the module is functioning properly (green).

DN-LED ... lit, if the module is not (yet) functioning properly (red).

32.5 Firmware

The firmware is part of the operating system for the ACOPOSmulti drive system. The firmware is updated by updating the ACOPOSmulti operating system.

33. 8B0W external braking resistors

8B0W external braking resistors are used to dissipate braking energy on 8B0P passive ACOPOSmulti power supply modules.

33.1 Order data


Model number	Short description	Figure
	IP65 protection	 <p>8B0W0079H000.001-1</p>
8B0W0045H000.001-1	ACOPOSmulti braking resistor, 450 W, 50 R, IP65, terminals	
8B0W0079H000.001-1	ACOPOSmulti braking resistor, 790 W, 33 R, IP65, terminals	

Table 144: Order data - 8B0W external braking resistors

33.2 Technical data

Product ID	8B0W0045H000.001-1	8B0W0079H000.001-1
General information		
C-UL-US listed	Yes	Yes
RoHS compliant	Yes	Yes
Cooling and mounting methods	Wall mounting	Wall mounting
Resistance		
Continuous power depending on the mounting orientation Horizontal Vertical	360 W 450 W	632 W 790 W
Reduction of continuous power according to ambient temperature above 40°C	7.5 W/K	13.2 W/K
Ohmic resistance	50 Ω ±10%	33 Ω ±10%
Max. operating voltage	850 VDC	850 VDC
Isolation voltage type test	4,000 VAC	4,000 VAC
Intrinsically Safe	Yes ¹⁾	Yes ¹⁾
Temperature model data ²⁾		
Maximum permissible over-temperature	680°C	670°C
Thermal resistance between braking resistor and the environment	1.517 K/W	0.852 K/W
Heat capacitance of the filament	16.3 J/K	22.6 J/K

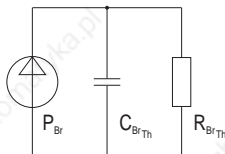
Table 145: Technical data - 8B0W external braking resistors

Technical data • 8B0W external braking resistors

Product ID	8B0W0045H000.001-1	8B0W0079H000.001-1
Resistor connection		
Design RB1, RB2 PE Shield connection	Terminals with tension spring technology M4 threaded bolt Yes, to the terminal box via high strength cable gland	
Terminal connection cross section Flexible and fine wire lines with wire tip sleeves UL/cULus CSA	1.5 - 10 mm ² 24-6 22-6	
Terminal cable outer-cross-section dimension of the connection cable	9 - 16.6 mm	
Operational conditions		
Permitted mounting orientations Standing horizontally Hanging vertically Connection box, bottom Connection box, top	Yes Yes No	
Ambient temperature during operation	-40°C to +90°C	
Relative humidity during operation	5 to 95%, non-condensing	
EN 60529 protection	IP65	
Mechanical characteristics		
Dimensions Width Height Depth	124 mm 121 mm 332 mm	124 mm 121 mm 532 mm
Weight	2.4 kg	3.9 kg

Table 145: Technical data - 8B0W external braking resistors (cont.)

- 1) 8B0W external braking resistors can be considered intrinsically safe if they are connected to a 8B0P passive power supply module operated with a mains supply voltage of 3 x 380 - 500 VAC. The maximum time until the 8B0W external braking resistors are damaged is approximately 5.5 min in this case; a maximum surface temperature of approximately 480°C is achieved when this happens. A lower mains supply voltage on the 8B0P passive power supply module allows a longer maximum time before the 8B0W external braking resistor is damaged, which also results in higher temperatures.
- 2) The parameters are based on the following thermal equivalent circuit for the external braking resistor:



34. Cables

34.1 General information

B&R offers the cables for the ACOPOSmulti drive system in up to six different lengths. All cables can be used for drag chain installations. ¹⁾

To prevent disturbances to encoder signals, the holding brake and temperature sensor wires are in the motor cable and not in the encoder cable.

34.1.1 Assembled cables

Using B&R cables guarantees that the EMC limits are not exceeded. The cables are prefabricated in the EU and are therefore subject to the strictest quality standards.

Information:

If cables from other manufacturers are used, make sure that they have the same wave parameters and the same design as the respective B&R cable. If deviations exist, additional measures are necessary to ensure that EMC directives are met.

¹⁾ Custom fabrication of motor cables is available on request. For custom fabrication of motor cables, the plug size must be matched to the motor used!

34.2 8BCM motor cables

34.2.1 Motor cables 1.5 mm²

Order data ¹⁾


Model number	Short description	Figure
8BCM0005.1111A-0	ACOPOSmulti motor cable, length 5 m, 4 x 1.5 mm ² + 2 x 2 x 0.75 mm ² , motor connector 8 pin SpeedTec socket, can be used in drag chains, UL/CSA listed	
8BCM0007.1111A-0	ACOPOSmulti motor cable, length 7 m, 4 x 1.5 mm ² + 2 x 2 x 0.75 mm ² , motor connector 8 pin SpeedTec socket, can be used in drag chains, UL/CSA listed	
8BCM0010.1111A-0	ACOPOSmulti motor cable, length 10 m, 4 x 1.5 mm ² + 2 x 2 x 0.75 mm ² , motor connector 8 pin SpeedTec socket, can be used in drag chains, UL/CSA listed	
8BCM0015.1111A-0	ACOPOSmulti motor cable, length 15 m, 4 x 1.5 mm ² + 2 x 2 x 0.75 mm ² , motor connector 8 pin SpeedTec socket, can be used in drag chains, UL/CSA listed	
8BCM0020.1111A-0	ACOPOSmulti motor cable, length 20 m, 4 x 1.5 mm ² + 2 x 2 x 0.75 mm ² , motor connector 8 pin SpeedTec socket, can be used in drag chains, UL/CSA listed	
8BCM0025.1111A-0	ACOPOSmulti motor cable, length 25 m, 4 x 1.5 mm ² + 2 x 2 x 0.75 mm ² , motor connector 8 pin SpeedTec socket, can be used in drag chains, UL/CSA listed	

Table 146: Order data - 8BCM motor cables, 1.5 mm²

Technical data

Product ID	8BCMxxxx.1111A-0
General information	
C-UL-US listed	Yes
Cable cross section	4 x 1.5 mm ² + 2 x 2 x 0.75 mm ²
Durability	Oil resistant according to VDE 0472 part 803, as well as standard hydraulic oil
Certification	UL AWM Style 20234, 80°C, 1000 V, E63216 and CSA AWM I/II A/B, 90°C, 1000 V, FT2 LL46064
Lines	
Power lines Wire insulation Wire colors	1.5 mm ² , tinned Cu wire Special thermoplastic material Black, brown, blue, yellow/green
Signal lines Wire insulation Wire colors	0.75 mm ² , tinned Cu wire Special thermoplastic material White, white/red, white/blue, white/green

Table 147: Technical data - 8BCM motor cables, 1.5 mm²

1) Other cable lengths and conduits are available from B&R upon request.

Technical data • Cables

Product ID	8BCMxxxx.1111A-0
Cable structure	
Power lines Stranding Shield	No No
Signal lines Stranding Shield	White with white/red and white/blue with white/green Separate shielding for pairs, tinned Cu mesh, Optical coverage > 85% and foil banding
Cable stranding	With filler elements and foil banding
Cable shield	Tinned Cu mesh, optical coverage > 85% and wrapped in isolating fabric
Outer sheathing Item Color Labeling	PUR Orange, similar to RAL 2003 flat BERNECKER + RAINER 4x1.5+2x2x0.75 FLEX AWM STYLE 20234 80°C 1000 V E63216 CSA AWM I/II A/B 90°C 1000 V FT2 LL46064
Electrical characteristics	
Conductor resistance Power lines Signal lines	≤ 14 Ω/km ≤ 29 Ω/km
Insulation resistance	> 200 MΩ per km
Test voltage Wire/wire Wire/shield	3 kV 3 kV
Max. current loading capacity according to IEC 60364-5-523 depending on the type of installation ¹⁾ Installed in conduit or cable duct Mounted on walls Installed in a cable tray	17.8 A 20 A 20.9 A
Mechanical characteristics	
Temperature range Moving Static	-10°C to +80°C -40°C to +90°C
Outer diameter	12.8 mm ± 0.4 mm
Flex radius Single bend Moving	40 mm 99 mm
Speed	≤ 4 m/s
Acceleration	< 60 m/s ²
Flex cycles ²⁾	3,000,000
Weight	0.26 kg/m

Table 147: Technical data - 8BCM motor cables, 1.5 mm² (cont.)

- 1) Valid in the following conditions: 40°C ambient temperature and 90°C maximal line temperature.

The maximum current load value in IEC60364-5-523 is for an ambient temperature of 30°C. The values are converted for use at 40°C ambient temperature using the factor $k_{Temp} = 0.91$ given in the standard.

The motor cable cross section is chosen for B&R motor cables so that the valid current load capacity for the selected cable cross section is greater than or equal to the thermal equivalent effective value of the motor current (I_q).

If information concerning load torque, inertia and friction are available, the thermal equivalent effective value of the motor current I_q for the motor being used is calculated as follows:

$$I_q [A] = \sqrt{\frac{1}{T_{Cycle} [s]} \cdot \sum_i I_i [A]^2 \cdot t_i [s]}$$

- 2) At an ambient temperature of 20°C and a flex radius of 125 mm.

34.2.2 Motor cables 4 mm²

Order data ¹⁾


Model number	Short description	Figure
8BCM0005.1312A-0	ACOPOSmulti motor cable, length 5 m, 4 x 4 mm ² + 2 x 2 x 1 mm ² , motor connector 8 pin SpeedTec socket, can be used in drag chains, UL/CSA listed	
8BCM0007.1312A-0	ACOPOSmulti motor cable, length 7 m, 4 x 4 mm ² + 2 x 2 x 1 mm ² , motor connector 8 pin SpeedTec socket, can be used in drag chains, UL/CSA listed	
8BCM0010.1312A-0	ACOPOSmulti motor cable, length 10 m, 4 x 4 mm ² + 2 x 2 x 1 mm ² , motor connector 8 pin SpeedTec socket, can be used in drag chains, UL/CSA listed	
8BCM0015.1312A-0	ACOPOSmulti motor cable, length 15 m, 4 x 4 mm ² + 2 x 2 x 1 mm ² , motor connector 8 pin SpeedTec socket, can be used in drag chains, UL/CSA listed	
8BCM0020.1312A-0	ACOPOSmulti motor cable, length 20 m, 4 x 4 mm ² + 2 x 2 x 1 mm ² , motor connector 8 pin SpeedTec socket, can be used in drag chains, UL/CSA listed	
8BCM0025.1312A-0	ACOPOSmulti motor cable, length 25 m, 4 x 4 mm ² + 2 x 2 x 1 mm ² , motor connector 8 pin SpeedTec socket, can be used in drag chains, UL/CSA listed	

Table 148: Order data - 8BCM motor cables, 4 mm²

Technical data

Product ID	8BCMxxxx.1312A-0
General information	
C-UL-US listed	Yes
Cable cross section	4 x 4 mm ² + 2 x 2 x 1 mm ²
Durability	Oil resistant according to VDE 0472 part 803, as well as standard hydraulic oil
Certification	UL AWM Style 20234, 80°C, 1000 V, E63216 and CSA AWM I/II A/B, 90°C, 1000 V, FT2 LL46064
Lines	
Power lines	4 mm ² , tinned Cu wire
Wire insulation	Special thermoplastic material
Wire colors	Black, brown, blue, yellow/green
Signal lines	1 mm ² , tinned Cu wire
Wire insulation	Special thermoplastic material
Wire colors	White, white/red, white/blue, white/green

Table 149: Technical data - 8BCM motor cables, 4 mm²

1) Other cable lengths and conduits are available from B&R upon request.

Technical data • Cables

Product ID	8BCMxxx.1312A-0
Cable structure	
Power lines Stranding Shield	No No
Signal lines Stranding Shield	White with white/red and white/blue with white/green Separate shielding for pairs, tinned Cu mesh, Optical coverage > 85% and foil banding
Cable stranding	With filler elements and foil banding
Cable shield	Tinned Cu mesh, optical coverage > 85% and wrapped in isolating fabric
Outer sheathing Item Color Labeling	PUR Orange, similar to RAL 2003 flat BERNECKER + RAINER 4x4.0+2x2x1.0 FLEX AWM STYLE 20234 80°C 1000 V E63216 CSA AWM I/II A/B 90°C 1000 V FT2 LL46064
Electrical characteristics	
Conductor resistance Power lines Signal lines	≤ 5.2 Ω/km ≤ 19 Ω/km
Insulation resistance	> 200 MΩ per km
Test voltage Wire/wire Wire/shield	3 kV 3 kV
Max. current loading capacity according to IEC 60364-5-523 depending on the type of installation ¹⁾ Installed in conduit or cable duct Mounted on walls Installed in a cable tray	31.9 A 36.4 A 38.2 A
Mechanical characteristics	
Temperature range Moving Static	-10°C to +80°C -40°C to +90°C
Outer diameter	15.8 mm ± 0.5 mm
Flex radius Single bend Moving	50 mm 122 mm
Speed	≤ 4 m/s
Acceleration	< 60 m/s ²
Flex cycles ²⁾	3,000,000
Weight	0.45 kg/m

Table 149: Technical data - 8BCM motor cables, 4 mm² (cont.)

1) Valid in the following conditions: 40°C ambient temperature and 90°C maximal line temperature.

The maximum current load value in IEC60364-5-523 is for an ambient temperature of 30°C. The values are converted for use at 40°C ambient temperature using the factor $k_{Temp} = 0.91$ given in the standard.

The motor cable cross section is chosen for B&R motor cables so that the valid current load capacity for the selected cable cross section is greater than or equal to the thermal equivalent effective value of the motor current (I_q).

If information concerning load torque, inertia and friction are available, the thermal equivalent effective value of the motor current I_q for the motor being used is calculated as follows:

$$I_q [A] = \sqrt{\frac{1}{T_{Cycle} [s]} \cdot \sum_i I_i [A]^2 \cdot t_i [s]}$$

2) At an ambient temperature of 20°C and a flex radius of 155 mm.

34.2.3 4 mm² motor cables with motor plug, size 1.5

Order data ¹⁾


Model number	Short description	Figure
8BCM0005.1322A-0	ACOPOSmulti motor cable, length 5 m, 4 x 4 mm ² + 2 x 2 x 1 mm ² , motor connector 8-pin SpeedTec socket, size 1.5, can be used in cable drag chains, UL/CSA listed	
8BCM0007.1322A-0	ACOPOSmulti motor cable, length 7 m, 4 x 4 mm ² + 2 x 2 x 1 mm ² , motor connector 8-pin SpeedTec socket, size 1.5, can be used in cable drag chains, UL/CSA listed	
8BCM0010.1322A-0	ACOPOSmulti motor cable, length 10 m, 4 x 4 mm ² + 2 x 2 x 1 mm ² , motor connector 8-pin SpeedTec socket, size 1.5, can be used in cable drag chains, UL/CSA listed	
8BCM0015.1322A-0	ACOPOSmulti motor cable, length 15 m, 4 x 4 mm ² + 2 x 2 x 1 mm ² , motor connector 8-pin SpeedTec socket, size 1.5, can be used in cable drag chains, UL/CSA listed	
8BCM0020.1322A-0	ACOPOSmulti motor cable, length 20 m, 4 x 4 mm ² + 2 x 2 x 1 mm ² , motor connector 8-pin SpeedTec socket, size 1.5, can be used in cable drag chains, UL/CSA listed	
8BCM0025.1322A-0	ACOPOSmulti motor cable, length 25 m, 4 x 4 mm ² + 2 x 2 x 1 mm ² , motor connector 8-pin SpeedTec socket, size 1.5, can be used in cable drag chains, UL/CSA listed	

Table 150: Order data - 8BCM 4 mm² motor cables with motor plug, size 1.5

Technical data

Product ID	8BCMxxxx.1322A-0
General information	
C-UL-US listed	Yes
Cable cross section	4 x 4 mm ² + 2 x 2 x 1 mm ²
Durability	Oil resistant according to VDE 0472 part 803, as well as standard hydraulic oil
Certification	UL AWM Style 20234, 80°C, 1000 V, E63216 and CSA AWM I/II A/B, 90°C, 1000 V, FT2 LL46064
Lines	
Power lines	4 mm ² , tinned Cu wire
Wire insulation	Special thermoplastic material
Wire colors	Black, brown, blue, yellow/green
Signal lines	1 mm ² , tinned Cu wire
Wire insulation	Special thermoplastic material
Wire colors	White, white/red, white/blue, white/green

Table 151: Technical data - 8BCM 4 mm² motor cables with motor plug, size 1.5

1) Other cable lengths and conduits are available from B&R upon request.

Technical data • Cables

Product ID	8BCMxxxx.1322A-0
Cable structure	
Power lines Stranding Shield	No No
Signal lines Stranding Shield	White with white/red and white/blue with white/green Separate shielding for pairs, tinned Cu mesh, Optical coverage > 85% and foil banding
Cable stranding	With filler elements and foil banding
Cable shield	Tinned Cu mesh, optical coverage > 85% and wrapped in isolating fabric
Outer sheathing Item Color Labeling	PUR Orange, similar to RAL 2003 flat BERNECKER + RAINER 4x4.0+2x2x1.0 FLEX AWM STYLE 20234 80°C 1000 V E63216 CSA AWM I/II A/B 90°C 1000 V FT2 LL46064
Electrical characteristics	
Conductor resistance Power lines Signal lines	≤ 5.2 Ω/km ≤ 19 Ω/km
Insulation resistance	> 200 MΩ per km
Test voltage Wire/wire Wire/shield	3 kV 3 kV
Max. current loading capacity according to IEC 60364-5-523 depending on the type of installation ¹⁾ Installed in conduit or cable duct Mounted on walls Installed in a cable tray	31.9 A 36.4 A 38.2 A
Mechanical characteristics	
Temperature range Moving Static	-10°C to +80°C -40°C to +90°C
Outer diameter	15.8 mm ± 0.5 mm
Flex radius Single bend Moving	50 mm 122 mm
Speed	≤ 4 m/s
Acceleration	< 60 m/s ²
Flex cycles ²⁾	3,000,000
Weight	0.45 kg/m

Table 151: Technical data - 8BCM 4 mm² motor cables with motor plug, size 1.5 (cont.)

- 1) Valid in the following conditions: 40°C ambient temperature and 90°C maximal line temperature.

The maximum current load value in IEC60364-5-523 is for an ambient temperature of 30°C. The values are converted for use at 40°C ambient temperature using the factor $k_{Temp} = 0.91$ given in the standard.

The motor cable cross section is chosen for B&R motor cables so that the valid current load capacity for the selected cable cross section is greater than or equal to the thermal equivalent effective value of the motor current (I_q).

If information concerning load torque, inertia and friction are available, the thermal equivalent effective value of the motor current I_q for the motor being used is calculated as follows:

$$I_q [A] = \sqrt{\frac{1}{T_{Cycle} [s]} \cdot \sum_i I_i [A]^2 \cdot t_i [s]}$$

- 2) At an ambient temperature of 20°C and a flex radius of 155 mm.

34.2.4 Motor cables 10 mm²

Order data ¹⁾


Model number	Short description	Figure
8BCM0005.1523A-0	ACOPOSmulti motor cable, length 5 m, 4 x 10 mm ² + 2 x 2 x 1.5 mm ² , motor connector 8-pin SpeedTec socket, size 1.5, can be used in cable drag chains, UL/CSA listed	
8BCM0007.1523A-0	ACOPOSmulti motor cable, length 7 m, 4 x 10 mm ² + 2 x 2 x 1.5 mm ² , motor connector 8-pin SpeedTec socket, size 1.5, can be used in cable drag chains, UL/CSA listed	
8BCM0010.1523A-0	ACOPOSmulti motor cable, length 10 m, 4 x 10 mm ² + 2 x 2 x 1.5 mm ² , motor connector 8-pin SpeedTec socket, size 1.5, can be used in cable drag chains, UL/CSA listed	
8BCM0015.1523A-0	ACOPOSmulti motor cable, length 15 m, 4 x 10 mm ² + 2 x 2 x 1.5 mm ² , motor connector 8-pin SpeedTec socket, size 1.5, can be used in cable drag chains, UL/CSA listed	
8BCM0020.1523A-0	ACOPOSmulti motor cable, length 20 m, 4 x 10 mm ² + 2 x 2 x 1.5 mm ² , motor connector 8-pin SpeedTec socket, size 1.5, can be used in cable drag chains, UL/CSA listed	
8BCM0025.1523A-0	ACOPOSmulti motor cable, length 25 m, 4 x 10 mm ² + 2 x 2 x 1.5 mm ² , motor connector 8-pin SpeedTec socket, size 1.5, can be used in cable drag chains, UL/CSA listed	

Table 152: Order data - 8BCM motor cables, 10 mm²

Technical data

Product ID	8BCMxxxx.1523A-0
General information	
C-UL-US listed	Yes
Cable cross section	4 x 10 mm ² + 2 x 2 x 1.5 mm ²
Durability	Oil resistant according to VDE 0472 part 803, as well as standard hydraulic oil
Certification	UL AWM Style 20234, 80°C, 1000 V, E63216 and CSA AWM I/II A/B, 90°C, 1000 V, FT2 LL46064
Lines	
Power lines	10 mm ² , tinned Cu wire
Wire insulation	Special thermoplastic material
Wire colors	Black, brown, blue, yellow/green
Signal lines	1.5 mm ² , tinned Cu wire
Wire insulation	Special thermoplastic material
Wire colors	White, white/red, white/blue, white/green

Table 153: Technical data - 8BCM motor cables, 10 mm²

1) Other cable lengths and conduits are available from B&R upon request.

Technical data • Cables

Product ID	8BCMxxxx.1523A-0
Cable structure	
Power lines Stranding Shield	No No
Signal lines Stranding Shield	White with white/red and white/blue with white/green Separate shielding for pairs, tinned Cu mesh, Optical coverage > 85% and foil banding
Cable stranding	With filler elements and foil banding
Cable shield	Tinned Cu mesh, optical coverage > 85% and wrapped in isolating fabric
Outer sheathing Item Color Labeling	PUR Orange, similar to RAL 2003 flat BERNECKER + RAINER 4x10.0+2x2x1.5 FLEX AWM STYLE 20234 80°C 1000 V E63216 CSA AWM I/II A/B 90°C 1000 V FT2 LL46064
Electrical characteristics	
Conductor resistance Power lines Signal lines	≤ 2.1 Ω/km ≤ 14 Ω/km
Insulation resistance	> 200 MΩ per km
Test voltage Wire/wire Wire/shield	3 kV 3 kV
Max. current loading capacity according to IEC 60364-5-523 depending on the type of installation ¹⁾ Installed in conduit or cable duct Mounted on walls Installed in a cable tray	54.6 A 64.6 A 68.3 A
Mechanical characteristics	
Temperature range Moving Static	-10°C to +80°C -40°C to +90°C
Outer diameter	20.1 mm ± 0.7 mm
Flex radius Single bend Moving	62 mm 156 mm
Speed	≤ 4 m/s
Acceleration	< 60 m/s ²
Flex cycles ²⁾	3,000,000
Weight	0.77 kg/m

Table 153: Technical data - 8BCM motor cables, 10 mm² (cont.)

1) Valid in the following conditions: 40°C ambient temperature and 90°C maximal line temperature.

The maximum current load value in IEC60364-5-523 is for an ambient temperature of 30°C. The values are converted for use at 40°C ambient temperature using the factor $k_{Temp} = 0.91$ given in the standard.

The motor cable cross section is chosen for B&R motor cables so that the valid current load capacity for the selected cable cross section is greater than or equal to the thermal equivalent effective value of the motor current (I_q).

If information concerning load torque, inertia and friction are available, the thermal equivalent effective value of the motor current I_q for the motor being used is calculated as follows:

$$I_q [A] = \sqrt{\frac{1}{T_{Cycle} [s]} \cdot \sum_i I_i [A]^2 \cdot t_i [s]}$$

2) At an ambient temperature of 20°C and a flex radius of 200 mm.

34.3 8BCE EnDat cables

34.3.1 Order data ¹⁾


Model number	Model number	Figure
8BCE0005.1111A-0	ACOPOSmulti EnDat cable, length 5 m, 10 x 0.14 mm ² + 2 x 0.5 mm ² , EnDat connector 17-pin SpeedTec socket, servo connector 15-pin DSUB plug, can be used in cable drag chains, UL/CSA listed	
8BCE0007.1111A-0	ACOPOSmulti EnDat cable, length 7 m, 10 x 0.14 mm ² + 2 x 0.5 mm ² , EnDat connector 17-pin SpeedTec socket, servo connector 15-pin DSUB plug, can be used in cable drag chains, UL/CSA listed	
8BCE0010.1111A-0	ACOPOSmulti EnDat cable, length 10 m, 10 x 0.14 mm ² + 2 x 0.5 mm ² , EnDat connector 17-pin SpeedTec socket, servo connector 15-pin DSUB plug, can be used in cable drag chains, UL/CSA listed	
8BCE0015.1111A-0	ACOPOSmulti EnDat cable, length 15 m, 10 x 0.14 mm ² + 2 x 0.5 mm ² , EnDat connector 17-pin SpeedTec socket, servo connector 15-pin DSUB plug, can be used in cable drag chains, UL/CSA listed	
8BCE0015.1111A-0	ACOPOSmulti EnDat cable, length 20 m, 10 x 0.14 mm ² + 2 x 0.5 mm ² , EnDat connector 17-pin SpeedTec socket, servo connector 15-pin DSUB plug, can be used in cable drag chains, UL/CSA listed	
8BCE0015.1111A-0	ACOPOSmulti EnDat cable, length 25 m, 10 x 0.14 mm ² + 2 x 0.5 mm ² , EnDat connector 17-pin SpeedTec socket, servo connector 15-pin DSUB plug, can be used in cable drag chains, UL/CSA listed	

Table 154: Order data - 8BCE EnDat cables

34.3.2 Technical data

Product ID	8BCExxxx.1111A-0
General information	
C-UL-US listed	Yes
Cable cross section	5 x 2 x 0.14 mm ² + 1 x 2 x 0.50 mm ²
Durability	Oil resistant according to VDE 0472 part 803, as well as standard hydraulic oil
Certification	UL AWM Style 20963, 80°C, 30 V, E63216 and CSA AWM III A/B, 90°C, 30 V, FT1 LL46064
Lines	
Signal lines Wire insulation Wire colors	0.14 mm ² , tinned Cu wire Special thermoplastic material Blue, brown, yellow, gray, green, pink, red, black, violet, white
Supply lines Wire insulation Wire colors	0.5 mm ² , tinned Cu wire Special thermoplastic material White/green, white/red

Table 155: Technical data - 8BCE EnDat cables

1) Other cable lengths and conduits are available from B&R upon request.

Technical data • Cables

Product ID	8BCExxxx.1111A-0
Cable structure	
Signal lines Stranding Shield	Green with brown, gray with yellow, white with violet, black with red, pink with blue No
Supply lines Stranding Shield	White/red with white/green and filler elements No
Cable stranding	With foil banding
Cable shield	Cu mesh, optical coverage > 85% and wrapped in isolating fabric
Outer sheathing Item Color Labeling	PUR RAL 6018 BERNECKER + RAINER 5x2x0.14+2x0.5 FLEX AWM STYLE 20963 80°C 30V E 63216 CSA AWM I/II A/B 90°C 30V FT1 LL 46064
Electrical characteristics	
Conductor resistance Signal lines Supply lines	≤ 140 Ω/km ≤ 40 Ω/km
Insulation resistance	> 200 MΩ per km
Test voltage Wire/wire Wire/shield	1 kV 0.8 kV
Mechanical characteristics	
Temperature range Moving Static	-10°C to +80°C -40°C to +90°C
Outer diameter	7.85 mm ± 0.2 mm
Flex radius Single bend Moving	24 mm 60 mm
Speed	≤ 4 m/s
Acceleration	< 60 m/s ²
Flex cycles ¹⁾	3,000,000
Weight	0.08 kg/m

Table 155: Technical data - 8BCE EnDat cables (cont.)

1) At an ambient temperature of 20°C and a flex radius of 65 mm.

34.4 8BCF EnDat 2.2 cables

34.4.1 Order data ¹⁾


Model number	Model number	Figure
8BCF0005.1221B-0	EnDat 2.2 cable, length 5 m, 1 x 4 x 0.14 mm ² + 4 x 0.34 mm ² , EnDat plug, 12-pin SpringTec socket, servo plug, 9-pin DSUB plug, can be used in cable drag chains, UL/CSA certified	
8BCF0007.1221B-0	EnDat 2.2 cable, length 7 m, 1 x 4 x 0.14 mm ² + 4 x 0.34 mm ² , EnDat plug, 12-pin SpringTec socket, servo plug, 9-pin DSUB plug, can be used in cable drag chains, UL/CSA certified	
8BCF0010.1221B-0	EnDat 2.2 cable, length 10 m, 1 x 4 x 0.14 mm ² + 4 x 0.34 mm ² , EnDat plug, 12-pin SpringTec socket, servo plug, 9-pin DSUB plug, can be used in cable drag chains, UL/CSA certified	
8BCF0015.1221B-0	EnDat 2.2 cable, length 15 m, 1 x 4 x 0.14 mm ² + 4 x 0.34 mm ² , EnDat plug, 12-pin SpringTec socket, servo plug, 9-pin DSUB plug, can be used in cable drag chains, UL/CSA certified	
8BCF0020.1221B-0	EnDat 2.2 cable, length 20 m, 1 x 4 x 0.14 mm ² + 4 x 0.34 mm ² , EnDat plug, 12-pin SpringTec socket, servo plug, 9-pin DSUB plug, can be used in cable drag chains, UL/CSA certified	
8BCF0025.1221B-0	EnDat 2.2 cable, length 25 m, 1 x 4 x 0.14 mm ² + 4 x 0.34 mm ² , EnDat plug, 12-pin SpringTec socket, servo plug, 9-pin DSUB plug, can be used in cable drag chains, UL/CSA certified	

Table 156: Order data - 8BCF EnDat cables

34.4.2 Technical data

Product ID	8BCFxxxx.1221B-0
General information	
C-UL-US listed	Yes
Cable cross section	1 x 4 x 0.14 mm ² + 4 x 0.34 mm ²
Durability	Oil resistant according to VDE 0472 part 803 test type B
Certification	UL AWM Style 20963, 80°C, 30 V, E63216
Lines	
Signal lines Wire insulation Wire colors	0.14 mm ² , tinned Cu wire Special thermoplastic material Blue, brown, yellow, gray, green, pink, red, black, violet, white
Supply lines Wire insulation Wire colors	0.34 mm ² , tinned Cu wire Special thermoplastic material White/green, white/red

Table 157: Technical data - 8BCF EnDat 2.2 cables

1) Other cable lengths and conduits are available from B&R upon request.

Technical data • Cables

Product ID	8BCFxxxx.1221B-0
Cable structure	
Signal lines Stranding Shield	Green with brown, gray with yellow, white with violet, black with red, pink with blue No
Supply lines Stranding Shield	White/red with white/green and filler elements No
Cable stranding	With foil banding
Cable shield	CuSn mesh
Outer sheathing Item Color Labeling	PUR Black Heidenhain UR AWM Style 20963 80°C 30V E63216
Electrical characteristics	
Conductor resistance Signal lines Supply lines	≤ 134 Ω/km ≤ 55 Ω/km
Insulation resistance	> 200 MΩ per km
Test voltage Wire/wire Wire/shield	0.5 kV 0.5 kV
Mechanical characteristics	
Temperature range Moving Static	-10°C to +80°C -40°C to +80°C
Outer diameter	6 mm ± 0.25 mm
Flex radius Single bend Moving	20 mm 75 mm
Speed	≤ 4 m/s
Acceleration	< 60 m/s ²
Flex cycles	3,000,000
Weight	0.08 kg/m

Table 157: Technical data - 8BCF EnDat 2.2 cables (cont.)

34.5 8BCR resolver cables

34.5.1 Order data ¹⁾


Model number	Short description	Figure
8BCR0005.1111A-0	ACOPOSmulti resolver cable, length 5 m, 3 x 2 x 24 AWG (19 x 0.127), resolver connector 12-pin SpeedTec socket, servo connector 9-pin DSUB plug, can be used in drag chains, UL/CSA listed	
8BCR0007.1111A-0	ACOPOSmulti resolver cable, length 7 m, 3 x 2 x 24 AWG (19 x 0.127), resolver connector 12-pin SpeedTec socket, servo connector 9-pin DSUB plug, can be used in drag chains, UL/CSA listed	
8BCR0010.1111A-0	ACOPOSmulti resolver cable, length 10 m, 3 x 2 x 24 AWG (19 x 0.127), resolver connector 12-pin SpeedTec socket, servo connector 9-pin DSUB plug, can be used in drag chains, UL/CSA listed	
8BCR0015.1111A-0	ACOPOSmulti resolver cable, length 15 m, 3 x 2 x 24 AWG (19 x 0.127), resolver connector 12-pin SpeedTec socket, servo connector 9-pin DSUB plug, can be used in drag chains, UL/CSA listed	
8BCR0020.1111A-0	ACOPOSmulti resolver cable, length 20 m, 3 x 2 x 24 AWG (19 x 0.127), resolver connector 12-pin SpeedTec socket, servo connector 9-pin DSUB plug, can be used in drag chains, UL/CSA listed	
8BCR0025.1111A-0	ACOPOSmulti resolver cable, length 25 m, 3 x 2 x 24 AWG (19 x 0.127), resolver connector 12-pin SpeedTec socket, servo connector 9-pin DSUB plug, can be used in drag chains, UL/CSA listed	

Table 158: Order data - 8BCR resolver cables

34.5.2 Technical data

Product ID	8BCRxxxx.1111A-0
General information	
C-UL-US listed	Yes
Cable cross section	3 x 2 x 24 AWG/19
Durability	Oil resistant according to VDE 0472 part 803, as well as standard hydraulic oil
Certification	UL AWM Style 20671, 90°C, 30 V, E63216 and CSA AWM, 90°C, 30 V, I/II A/B FT1 LL46064
Lines	
Signal lines	24 AWG/19, tinned Cu wire
Wire insulation	Special thermoplastic material
Wire colors	White, brown, green, yellow, gray, pink

Table 159: Technical data - 8BCR resolver cables

1) Other cable lengths and conduits are available from B&R upon request.

Technical data • Cables

Product ID	8BCRxxxx.1111A-0
Cable structure	
Signal lines Stranding Shield	White with brown, green with yellow, gray with pink No
Cable stranding	The 3 pairs together covered by foil banding
Cable shield	Cu mesh, optical coverage 90% and wrapped in isolating fabric
Outer sheathing Item Color Labeling	PUR RAL 6018 BERNECKER + RAINER 3x2x24 AWG FLEX AWM STYLE 20671 90°C 30V E 63216 CSA AWM 90°C 30V I/II A/B FT1 LL 46064
Electrical characteristics	
Conductor resistance	≤ 86 Ω/km
Insulation resistance	> 200 MΩ per km
Test voltage Wire/wire Wire/shield	1.5 kV 0.8 kV
Mechanical characteristics	
Temperature range Moving Static	-10°C to +80°C -40°C to +90°C
Outer diameter	6.5 mm ± 0.2 mm
Flex radius Single bend Moving	20 mm 50 mm
Speed	≤ 4 m/s
Acceleration	< 60 m/s ²
Flex cycles ¹⁾	3,000,000
Weight	0.07 kg/m

Table 159: Technical data - 8BCR resolver cables (cont.)

1) At an ambient temperature of 20°C and a flex radius of 65 mm.

34.6 8BCS SinCos cables

34.6.1 Order data ¹⁾


Model number	Model number	Figure
8BCS0005.1111A-0	ACOPOSmulti SinCos cable, length 5 m, 10 x 0.14 mm ² + 2 x 0.5 mm ² , SinCos connector 12-pin SpeedTec socket, servo connector 15-pin DSUB plug, can be used in drag chains, UL/CSA listed	
8BCS0007.1111A-0	ACOPOSmulti SinCos cable, length 7 m, 10 x 0.14 mm ² + 2 x 0.5 mm ² , SinCos connector 12-pin SpeedTec socket, servo connector 15-pin DSUB plug, can be used in drag chains, UL/CSA listed	
8BCS0010.1111A-0	ACOPOSmulti SinCos cable, length 10 m, 10 x 0.14 mm ² + 2 x 0.5 mm ² , SinCos connector 12-pin SpeedTec socket, servo connector 15-pin DSUB plug, can be used in drag chains, UL/CSA listed	
8BCS0015.1111A-0	ACOPOSmulti SinCos cable, length 15 m, 10 x 0.14 mm ² + 2 x 0.5 mm ² , SinCos connector 12-pin SpeedTec socket, servo connector 15-pin DSUB plug, can be used in drag chains, UL/CSA listed	
8BCS0020.1111A-0	ACOPOSmulti SinCos cable, length 20 m, 10 x 0.14 mm ² + 2 x 0.5 mm ² , SinCos connector 12-pin SpeedTec socket, servo connector 15-pin DSUB plug, can be used in drag chains, UL/CSA listed	
8BCS0025.1111A-0	ACOPOSmulti SinCos cable, length 25 m, 10 x 0.14 mm ² + 2 x 0.5 mm ² , SinCos connector 12-pin SpeedTec socket, servo connector 15-pin DSUB plug, can be used in drag chains, UL/CSA listed	

Table 160: Order data - 8BCS SinCos cables

34.6.2 Technical data

Product ID	8BCSxxxx.1111A-0
General information	
C-UL-US listed	Yes
Cable cross section	5 x 2 x 0.14 mm ² + 1 x 2 x 0.50 mm ²
Durability	Oil resistant according to VDE 0472 part 803, as well as standard hydraulic oil
Certification	UL AWM Style 20963, 80°C, 30 V, E63216 and CSA AWM III A/B, 90°C, 30 V, FT1 LL46064
Lines	
Signal lines Wire insulation Wire colors	0.14 mm ² , tinned Cu wire Special thermoplastic material Blue, brown, yellow, gray, green, pink, red, black, violet, white
Supply lines Wire insulation Wire colors	0.5 mm ² , tinned Cu wire Special thermoplastic material White/green, white/red

Table 161: Technical data - 8BCS SinCos cables

1) Other cable lengths and conduits are available from B&R upon request.

Technical data • Cables

Product ID	8BCSxxxx.1111A-0
Cable structure	
Signal lines Stranding Shield	Green with brown, gray with yellow, white with violet, black with red, pink with blue No
Supply lines Stranding Shield	White/red with white/green and filler elements No
Cable stranding	With foil banding
Cable shield	Cu mesh, optical coverage > 85% and wrapped in isolating fabric
Outer sheathing Item Color Labeling	PUR RAL 6018 BERNECKER + RAINER 5x2x0.14+2x0.5 FLEX AWM STYLE 20963 80°C 30V E 63216 CSA AWM I/II A/B 90°C 30V FT1 LL 46064
Electrical characteristics	
Conductor resistance Signal lines Supply lines	≤ 140 Ω/km ≤ 40 Ω/km
Insulation resistance	> 200 MΩ per km
Test voltage Wire/wire Wire/shield	1 kV 0.8 kV
Mechanical characteristics	
Temperature range Moving Static	-10°C to +80°C -40°C to +90°C
Outer diameter	7.85 mm ± 0.2 mm
Flex radius Single bend Moving	24 mm 60 mm
Speed	≤ 4 m/s
Acceleration	< 60 m/s ²
Flex cycles ¹⁾	3,000,000
Weight	0.08 kg/m

Table 161: Technical data - 8BCS SinCos cables (cont.)

1) At an ambient temperature of 20°C and a flex radius of 65 mm.

34.7 8BCA expansion cables

ACOPOSmulti 8BCA expansion cables are intended for connecting two ACOPOSmulti 8BVE expansion modules.

Information:

A shield plate is attached to each end of an ACOPOSmulti 8BCA expansion cable. No extra shielding is required if this shield plate is correctly installed on the ACOPOSmulti 8BVE expansion module.

34.7.1 Expansion cables, 1.5 mm²

Order data ¹⁾


Model number	Short description	Figure
8BCA01X5.1111A-0	ACOPOSmulti expansion cable, length 1.5 m, 3 x 1.5 mm ² , can be used in drag chains, UL/CSA listed	
8BCA0003.1111A-0	ACOPOSmulti expansion cable, length 3 m, 3 x 1.5 mm ² , can be used in drag chains, UL/CSA listed	
8BCA0005.1111A-0	ACOPOSmulti expansion cable, length 5 m, 3 x 1.5 mm ² , can be used in drag chains, UL/CSA listed	

Table 162: Order data - 8BCA expansion cables, 1.5 mm²

Technical data

Product ID	8BCAxxxx.1111A-0
General information	
C-UL-US listed	Yes
Cable cross section	4 x 1.5 mm ² + 2 x 2 x 0.75 mm ²
Durability	Oil resistant according to VDE 0472 part 803, as well as standard hydraulic oil
Certification	UL AWM Style 20234, 80°C, 1000 V, E63216 and CSA AWM I/II A/B, 90°C, 1000 V, FT2 LL46064
Lines	
Power lines Wire insulation Wire colors	1.5 mm ² , tinned Cu wire Special thermoplastic material Black, brown, blue, yellow/green
Signal lines Wire insulation Wire colors	0.75 mm ² , tinned Cu wire Special thermoplastic material White, white/red, white/blue, white/green

Table 163: Technical data - 8BCA expansion cables, 1.5 mm²

1) Other cable lengths and conduits are available from B&R upon request.

Technical data • Cables

Product ID	8BCAxxx.1111A-0
Cable structure	
Power lines Stranding Shield	No No
Signal lines Stranding Shield	White with white/red and white/blue with white/green Separate shielding for pairs, tinned Cu mesh, Optical coverage > 85% and foil banding
Cable stranding	With filler elements and foil banding
Cable shield	Tinned Cu mesh, optical coverage > 85% and wrapped in isolating fabric
Outer sheathing Item Color Labeling	PUR Orange, similar to RAL 2003 flat BERNECKER + RAINER 4x1.5+2x2x0.75 FLEX AWM STYLE 20234 80°C 1000 V E63216 CSA AWM I/II A/B 90°C 1000 V FT2 LL46064
Electrical characteristics	
Conductor resistance Power lines Signal lines	≤ 14 Ω/km ≤ 29 Ω/km
Insulation resistance	> 200 MΩ per km
Test voltage Wire/wire Wire/shield	3 kV 3 kV
Max. current loading capacity according to IEC 60364-5-523 depending on the type of installation ¹⁾ Installed in conduit or cable duct Mounted on walls Installed in a cable tray	17.8 A 20 A 20.9 A
Mechanical characteristics	
Temperature range Moving Static	-10°C to +80°C -40°C to +90°C
Outer diameter	12.8 mm ± 0.4 mm
Flex radius Single bend Moving	40 mm 99 mm
Speed	≤ 4 m/s
Acceleration	< 60 m/s ²
Flex cycles ²⁾	3,000,000
Weight	0.26 kg/m

Table 163: Technical data - 8BCA expansion cables, 1.5 mm² (cont.)

1) Valid in the following conditions: 40°C ambient temperature and 90°C maximal line temperature.

The maximum current load value in IEC60364-5-523 is for an ambient temperature of 30°C. The values are converted for use at 40°C ambient temperature using the factor $k_{Temp} = 0.91$ given in the standard.

2) At an ambient temperature of 20°C and a flex radius of 125 mm.

34.7.2 Expansion cables, 4 mm²

Order data ¹⁾

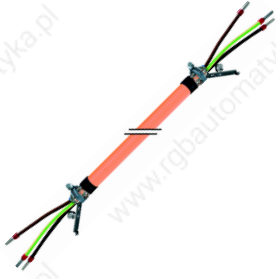
Model number	Short description	Figure
8BCA01X5.1312A-0	ACOPOSmulti expansion cable, length 1.5 m, 3 x 4 mm ² , can be used in drag chains, UL/CSA listed	
8BCA0003.1312A-0	ACOPOSmulti expansion cable, length 3 m, 3 x 4 mm ² , can be used in drag chains, UL/CSA listed	
8BCA0005.1312A-0	ACOPOSmulti expansion cable, length 5 m, 3 x 4 mm ² , can be used in drag chains, UL/CSA listed	

Table 164: Order data - 8BCA expansion cables, 4 mm²

Technical data

Product ID	8BCAxxxx.1312A-0
General information	
C-UL-US listed	Yes
Cable cross section	4 x 4 mm ² + 2 x 2 x 1 mm ²
Durability	Oil resistant according to VDE 0472 part 803, as well as standard hydraulic oil
Certification	UL AWM Style 20234, 80°C, 1000 V, E63216 and CSA AWM I/II A/B, 90°C, 1000 V, FT2 LL46064
Lines	
Power lines Wire insulation Wire colors	4 mm ² , tinned Cu wire Special thermoplastic material Black, brown, blue, yellow/green
Signal lines Wire insulation Wire colors	1 mm ² , tinned Cu wire Special thermoplastic material White, white/red, white/blue, white/green

Table 165: Technical data - 8BCA expansion cables, 4 mm²

1) Other cable lengths and conduits are available from B&R upon request.

Technical data • Cables

Product ID	8BCAxxxx.1312A-0
Cable structure	
Power lines Stranding Shield	No No
Signal lines Stranding Shield	White with white/red and white/blue with white/green Separate shielding for pairs, tinned Cu mesh, Optical coverage > 85% and foil banding
Cable stranding	With filler elements and foil banding
Cable shield	Tinned Cu mesh, optical coverage > 85% and wrapped in isolating fabric
Outer sheathing Item Color Labeling	PUR Orange, similar to RAL 2003 flat BERNECKER + RAINER 4x4.0+2x2x1.0 FLEX AWM STYLE 20234 80°C 1000 V E63216 CSA AWM I/II A/B 90°C 1000 V FT2 LL46064
Electrical characteristics	
Conductor resistance Power lines Signal lines	≤ 5.2 Ω/km ≤ 19 Ω/km
Insulation resistance	> 200 MΩ per km
Test voltage Wire/wire Wire/shield	3 kV 3 kV
Max. current loading capacity according to IEC 60364-5-523 depending on the type of installation ¹⁾ Installed in conduit or cable duct Mounted on walls Installed in a cable tray	31.9 A 36.4 A 38.2 A
Mechanical characteristics	
Temperature range Moving Static	-10°C to +80°C -40°C to +90°C
Outer diameter	15.8 mm ± 0.5 mm
Flex radius Single bend Moving	50 mm 122 mm
Speed	≤ 4 m/s
Acceleration	< 60 m/s ²
Flex cycles ²⁾	3,000,000
Weight	0.45 kg/m

Table 165: Technical data - 8BCA expansion cables, 4 mm² (cont.)

1) Valid in the following conditions: 40°C ambient temperature and 90°C maximal line temperature.

The maximum current load value in IEC60364-5-523 is for an ambient temperature of 30°C. The values are converted for use at 40°C ambient temperature using the factor $k_{Temp} = 0.91$ given in the standard.

2) At an ambient temperature of 20°C and a flex radius of 155 mm.

34.7.3 Expansion cables, 10 mm²

Order data ¹⁾

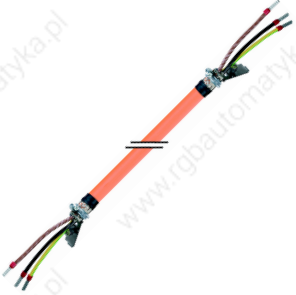
Model number	Short description	Figure
8BCA01X5.1513A-0	ACOPOSmulti expansion cable, length 1.5 m, 3 x 10 mm ² , can be used in drag chains, UL/CSA listed	
8BCA0003.1513A-0	ACOPOSmulti expansion cable, length 3 m, 3 x 10 mm ² , can be used in drag chains, UL/CSA listed	
8BCA0005.1513A-0	ACOPOSmulti expansion cable, length 5 m, 3 x 10 mm ² , can be used in drag chains, UL/CSA listed	

Table 166: Order data - 8BCA expansion cables, 10 mm²

Technical data

Product ID	8BCAxxxx.1513A-0
General information	
C-UL-US listed	Yes
Cable cross section	4 x 10 mm ² + 2 x 2 x 1.5 mm ²
Durability	Oil resistant according to VDE 0472 part 803, as well as standard hydraulic oil
Certification	UL AWM Style 20234, 80°C, 1000 V, E63216 and CSA AWM I/II A/B, 90°C, 1000 V, FT2 LL46064
Lines	
Power lines Wire insulation Wire colors	10 mm ² , tinned Cu wire Special thermoplastic material Black, brown, blue, yellow/green
Signal lines Wire insulation Wire colors	1.5 mm ² , tinned Cu wire Special thermoplastic material White, white/red, white/blue, white/green

Table 167: Technical data - 8BCA expansion cables, 10 mm²

1) Other cable lengths and conduits are available from B&R upon request.

Technical data • Cables

Product ID	8BCAxxx.1513A-0
Cable structure	
Power lines Stranding Shield	No No
Signal lines Stranding Shield	White with white/red and white/blue with white/green Separate shielding for pairs, tinned Cu mesh, Optical coverage > 85% and foil banding
Cable stranding	With filler elements and foil banding
Cable shield	Tinned Cu mesh, optical coverage > 85% and wrapped in isolating fabric
Outer sheathing Item Color Labeling	PUR Orange, similar to RAL 2003 flat BERNECKER + RAINER 4x10.0+2x2x1.5 FLEX AWM STYLE 20234 80°C 1000 V E63216 CSA AWM I/II A/B 90°C 1000 V FT2 LL46064
Electrical characteristics	
Conductor resistance Power lines Signal lines	≤ 2.1 Ω/km ≤ 14 Ω/km
Insulation resistance	> 200 MΩ per km
Test voltage Wire/wire Wire/shield	3 kV 3 kV
Max. current loading capacity according to IEC 60364-5-523 depending on the type of installation ¹⁾ Installed in conduit or cable duct Mounted on walls Installed in a cable tray	54.6 A 64.6 A 68.3 A
Mechanical characteristics	
Temperature range Moving Static	-10°C to +80°C -40°C to +90°C
Outer diameter	20.1 mm ± 0.7 mm
Flex radius Single bend Moving	62 mm 156 mm
Speed	≤ 4 m/s
Acceleration	< 60 m/s ²
Flex cycles ²⁾	3,000,000
Weight	0.77 kg/m

Table 167: Technical data - 8BCA expansion cables, 10 mm² (cont.)

1) Valid in the following conditions: 40°C ambient temperature and 90°C maximal line temperature.

The maximum current load value in IEC60364-5-523 is for an ambient temperature of 30°C. The values are converted for use at 40°C ambient temperature using the factor $k_{Temp} = 0.91$ given in the standard.

2) At an ambient temperature of 20°C and a flex radius of 200 mm.

35. Plugs

35.1 General information

B&R offers five different motor/encoder connectors for B&R motors. All connectors have IP67 protection. The metallic housing provides a protective ground connection on the housing according to VDE 0627. All plastic used in the connector is UL94/V0 listed. High quality, gold plated cage connector contacts guarantee a high level of contact security even when reinserted many times.

Information:

Using B&R connectors guarantees that the EMC limits for the connection are not exceeded. Make sure that connectors are put together correctly including a proper shield connection.

35.2 8BPM motor plugs

35.2.1 Order data

Model number	Short description	Figure
8BPM0001.0000-00	Motor plug 8-pin, SpeedTec, IP67, crimp contact included in the delivery: 4 x 0.35-2.5 mm ² + 4 x 0.14-1.0 mm ² , cable terminal size range: 9.5-14.5 mm, UL/CSA listed	
8BPM0002.0000-00	Motor plug 8-pin, SpeedTec, IP67, crimp contact included in the delivery: 4 x 2.5-4.0 mm ² + 4 x 0.14-1.0 mm ² , cable terminal size range: 14.0-17.0 mm, UL/CSA listed	
8BPM0003.0000-00	Motor plug 8-pin, SpeedTec, IP67, crimp contact included in the delivery: 4 x 1.5-10.0 mm ² + 4 x 0.35-2.5 mm ² , cable terminal size range: 16.5-25.0 mm, UL/CSA listed	

Table 168: Order data - 8BPM motor plugs

35.2.2 Technical data

Product ID	8BPM0001.0000-00	8BPM0002.0000-00	8BPM0003.0000-00
General information			
Connector size	Size 1		Size 1.5
Contacts	8 (4 power and 4 signal contacts)		
Degree of pollution	3		
Installation altitude	Up to 2,000 m		
Insulator	PA, UL94/V0 listed		
Contacts	Gold-plated brass		
Protective ground connection on housing	According to VDE 0627		
Protection according to DIN 40050	IP67 when connected		
Certifications	UL/CSA		
Electrical characteristics			
Overvoltage category	III		
Power contacts			
Rated current	30 A		75 A
Rated voltage	630 VAC / VDC		630 VAC / VDC
Test voltage (L-L)	6,000 V		6,000 V
Contact resistance	< 3 mΩ		< 1 mΩ
Signal contacts			
Rated current	7 A		30 A
Rated voltage	250 VAC / VDC		250 VAC / VDC
Test voltage (L-L)	2,500 V		4,000 V
Contact resistance	< 5 mΩ		< 3 mΩ
Mechanical characteristics			
Temperature range	-20°C to +130°C		
Housing material	Zinc casting, nickel plated		
Gaskets	FKM		
Connection cycles	> 50		
Crimp range	4 x 0.5 - 2.5 mm ² + 4 x 0.06 - 1 mm ²	4 x 2.5 - 4 mm ² + 4 x 0.06 - 1 mm ²	4 x 1.5 - 10 mm ² + 4 x 0.5 - 2.5 mm ²
Cable ø	9.5 - 14.5 mm	14 - 17 mm	16.5 - 25 mm
Manufacturer information			
Manufacturer Internet address	INTERCONTEC www.intercontec.biz		
Manufacturer's product ID	BSTA 078 FR 19 42 0100 126	BSTA 078 FR 01 59 0100 127	CSTA 264 FR 48 45 0020 058

Table 169: Technical data - 8BPM motor plugs

35.3 8BPE EnDat plugs

35.3.1 Order data


Model number	Short description	Figure
8BPE0001.0000-00	EnDat plug, 17-pin, SpeedTEC, IP67, crimp contacts included in the delivery: 17 x 0.14-1.0 mm ² , cable terminal size range: 6.0-10.0 mm, UL/CSA listed	

Table 170: Order data - 8BPE EnDat plugs

35.3.2 Technical data

Product ID	8BPE0001.0000-1
General information	
Connector size	Size 1
Contacts	17 signal contacts
Degree of pollution	3
Installation altitude	Up to 2,000 m
Insulator	PA, PBT, UL94/V0 listed
Contacts	Gold-plated brass
Protective ground connection on housing	According to VDE 0627
Protection according to DIN 40050	IP67 when connected
Certifications	UL/CSA
Electrical characteristics	
Overvoltage category	III
Signal contacts	
Rated current	9 A
Rated voltage	125 V
Test voltage (L - L)	2,500 V
Contact resistance	< 5 mΩ

Table 171: Technical data - EnDat plug 8BPE0001.0000-1

Technical data • Connectors

Product ID	8BPE0001.0000-1
Mechanical characteristics	
Temperature range	-20°C to +130°C
Housing material	Zinc die cast / brass, nickel-plated
Gaskets	FPM / HNBR
Connection cycles	> 50
Crimp range	17 x 0.14 - 1 mm ²
Cable ø	6 - 10 mm
Manufacturer information	
Manufacturer Internet address	INTERCONTEC www.intercontec.biz
Manufacturer's product ID	ASTA 035 FR 11 41 0100 156

Table 171: Technical data - EnDat plug 8BPE0001.0000-1 (cont.)

35.4 8BPR resolver plugs

35.4.1 Order data


Model number	Short description	Figure
8BPR0001.0000-00	Resolver plug 12-pin, SpeedTec, IP67, crimp contact included in the delivery: 12 x 0.14-1.0 mm ² , cable terminal size range: 6.0-10.0 mm, UL/CSA listed	

Table 172: Order data - 8BPR resolver plugs

35.4.2 Technical data - 8BPR0001.0000-00 resolver plug

Product ID	8BPR0001.0000-00
General information	
Connector size	Size 1
Contacts	12 signal contacts
Degree of pollution	3
Installation altitude	Up to 2,000 m
Insulator	PA, PBT, UL94/V0 listed
Contacts	Gold-plated brass
Protective ground connection on housing	According to VDE 0627
Protection according to DIN 40050	IP67 when connected
Certifications	UL/CSA
Electrical characteristics	
Overvoltage category	III
Signal contacts	
Rated current	9 A
Rated voltage	160 V
Test voltage (L - L)	2,500 V
Contact resistance	< 5 mΩ

Table 173: Technical data - 8BPR resolver plugs

Product ID	8BPR001.0000-00
Mechanical characteristics	
Temperature range	-20°C to +130°C
Housing material	Zinc casting, nickel plated
Gaskets	FPM / HNBR
Connection cycles	> 50
Crimp range	12 x 0.14 - 1 mm ²
Cable ø	6 - 10 mm
Manufacturer information	
Manufacturer Internet address	INTERCONTEC www.intercontec.biz
Manufacturer's product ID	ASTA 021 FR 11 41 0100 157

Table 173: Technical data - 8BPR resolver plugs (cont.)

Chapter 3 • Installation

1. General information

ACOPOSmulti modules must be installed in switching cabinets with at least IP54 protection.

Warning!

The notes regarding chapter 2 "Safety guidelines", section 2.6 "Handling and installation", on page 34 must be taken into consideration!

1.1 8B0M mounting plates

1.1.1 8B0MxxxxHW00.000-1 (wall mounting)

The mounting surface for the 8B0MxxxxHW00.000-1 mounting plate must provide sufficient stability for the mounting plate and also be non-flammable, level and free of contaminants.

Mounting holes (type and amount) are to be prepared according to section 4.5.1 "Mounting plate 8B0MnnnnHW00.000-1", on page 273.

The distances that must be used for mounting and ventilation of ACOPOSmulti modules can be found in the dimension diagrams for the individual modules.

1.1.2 8B0MxxxxHF00.000-1 (feed-through mounting)

The mounting surface for the 8B0MxxxxHF00.000-1 mounting plate must provide sufficient stability for the mounting plate and also be non-flammable, level and free of contaminants.

Caution!

It is especially important that the mounting surface is level because the entire surface of the 8B0MxxxxHF00.000-1 mounting plate comes into contact with it. The mounting surface must meet the criteria "Smoothness of 1 mm over the entire mounting surface".

Mounting on uneven surfaces can reduce heat dissipation from the ACOPOSmulti modules to the mounting plate!

Caution!

The area of the mounting surface where the seal for the 8B0MxxxxHF00.000-1 mounting plate sits must be free of scratches and residue because otherwise it cannot be guaranteed that protection guidelines according to EN 60529 are being met!

The cutout for the feed-through heat sink and the mounting holes (type and amount) are to be prepared according to section 4.7.1 "Mounting plate 8B0MnnnnHF00.000-1", on page 299.

The distances that must be used for mounting and ventilation of ACOPOSmulti modules can be found in the dimension diagrams for the individual modules.

1.1.3 8B0MxxxxHC00.000-1 (cold plate)

The mounting surface for the 8B0MxxxxHC00.000-1 mounting plate must provide sufficient stability for the mounting plate and also be non-flammable, level and free of contaminants.

Caution!

It is especially important that the mounting surface is level because the entire surface of the 8B0MxxxxHC00.000-1 cold plate mounting plate comes into contact with it. The mounting surface must meet the criteria "Smoothness of 1 mm over the entire mounting surface".

Mounting on uneven surfaces can reduce heat dissipation from the ACOPOSmulti modules to the mounting plate!

Mounting holes (type and amount) are to be prepared according to section 4.6.1 "Mounting plate 8B0MnnnnHC00.000-1", on page 285.

The distances that must be used for mounting and ventilation of ACOPOSmulti modules can be found in the dimension diagrams for the individual modules.

Connection of supply and return lines

The position of the connections for supply and return lines can be found in the mounting diagram (figure "Dimension diagram and installation dimensions - 8B0MnnnnHC00.000-1", on page 285, details Y and Z).

Caution!

The feed must be connected to the bottom connector of the mounting plate 8B0MxxxxHC00.000-1.

The return line must be connected to the top connector of the mounting plate 8B0MxxxxHC00.000-1.

1.2 Mounting ACOPOSmulti modules

Danger!

Before beginning work, remove the supply voltage and wait 5 minutes to ensure that the DC bus for the ACOPOSmulti drive system has discharged. See instructions!

- Attach the module to the mounting plate using the mounting clip(s) on the top of the ACOPOSmulti:



Figure 9: Attaching modules

- Clip the module into the backplane module(s). The module must be thoroughly attached, so that it rests straight in the backplane module(s) in order for the module contacts to function properly.
- Tighten all M6 mounting screws (2 screws per module width) on the module with a **torque between 4 and 5 Nm**: Tightening the bottom mounting screw creates a conductive contact between the module and the rail system of the supply voltage on the backplane module.



Figure 10: Tightening the fastening screws

1.3 8BVI inverter modules

1.3.1 Changing the backup battery

Battery-backed encoders can be connected to the EnDat 2.2 plug-in module 8BAC0120.001-x. The battery compartment for the required backup battery is located behind the black cover on the front of the ACOPOSmulti 8BVP power supply modules and ACOPOSmulti 8BVI inverter modules.

The backup battery is available as accessory set 8BXB000.0000-00 (includes the backup battery and a cap for the battery compartment).

Caution!

The following conditions must be met in order to maintain the encoder position when changing the backup battery:

- The 24V LED on the ACOPOSmulti module must be lit.
- An EnDat 2.2 plug-in module 8BAC0120.001-x is plugged into the ACOPOSmulti module.
- The battery backed encoder is connected to this EnDat 2.2 plug-in module 8BAC0120.001-x.

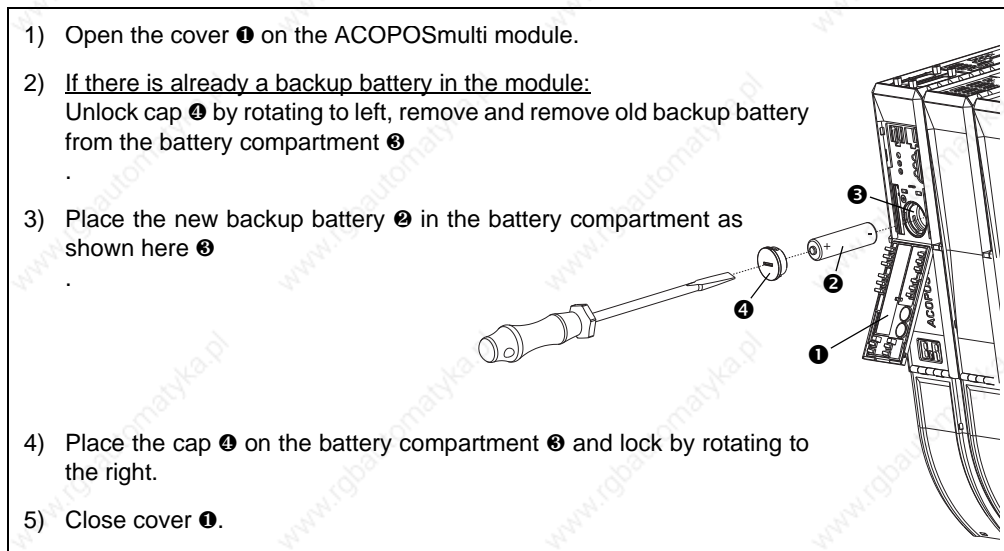


Figure 11: Changing/inserting the backup battery

Caution

The battery should be changed every 5 years. Change intervals are recommended by B&R and refer to average life span and operating conditions. It is not the maximum buffer duration.

Information:

Make sure to insert the battery with correct polarity!
Used batteries must be disposed of properly!

1.4 Expansion module - 8BVE0500Hx00.000-1

1.4.1 Installing the devices fuses

Before initial startup, the device fuses must be installed in the corresponding fuse holders. They are found on the broad left side as seen from the front of the module:

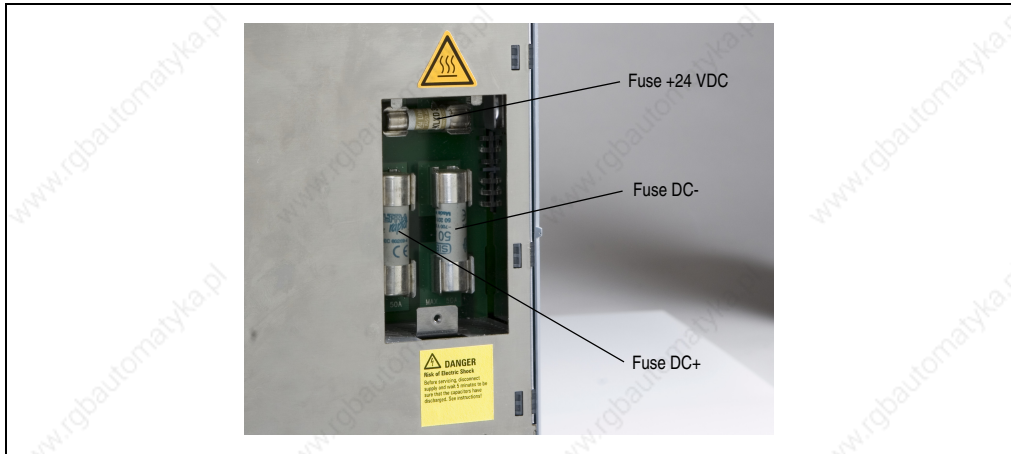


Figure 12: Expansion module, installing the device fuses

After installing the device fuses, the cover (included in the delivery) must be placed on the expansion module and tightened down with the fastening screws:

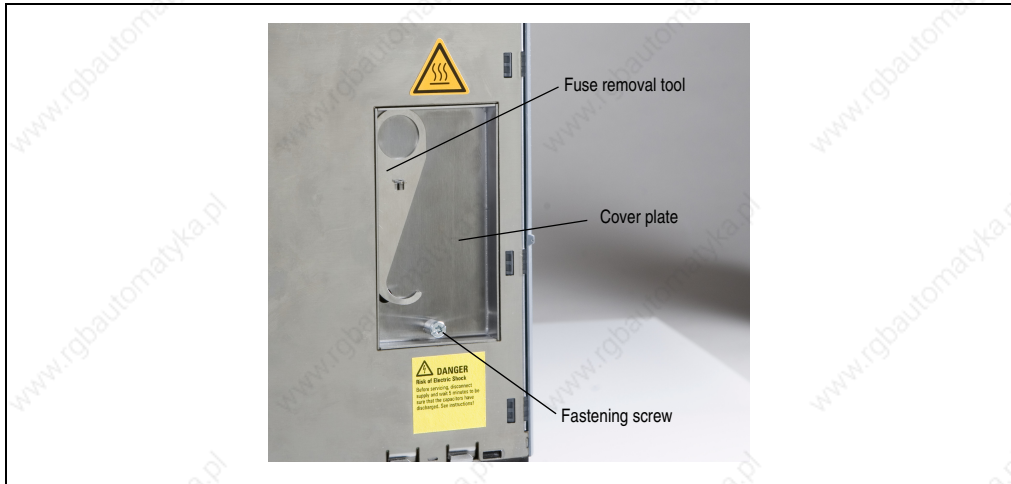


Figure 13: Expansion module - Cover plate closed

1.4.2 Exchanging device fuses

The device fuses in the expansion module are located on the left-hand side (as seen from the front) under a cover plate. In the cover plate is a tool for removing the device fuses.

Required tools: Screwdrivers

Danger!

Before beginning work, remove the supply voltage and wait 5 minutes to ensure that the DC bus for the ACOPOSmulti drive system has discharged. See instructions!

Danger!

The surfaces of ACOPOSmulti modules can be very hot!



Figure 14: Expansion module - Cover plate closed

Installation • General information

- 1) Remove fastening screw
- 2) Lift and remove cover from the module

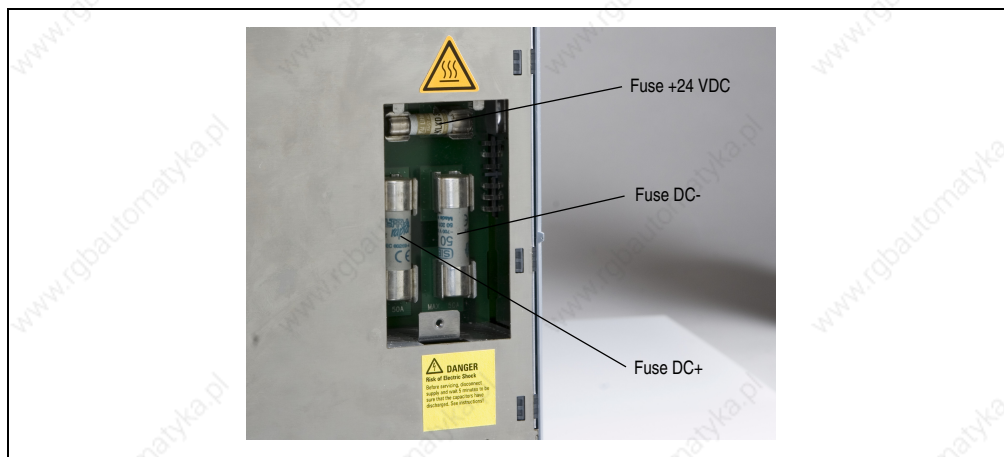


Figure 15: Expansion module - Cover plate removed

- 3) Remove fuse removal tool from cover plate:
Push the fuse removal tool out of the cover plate from behind using a screwdriver.

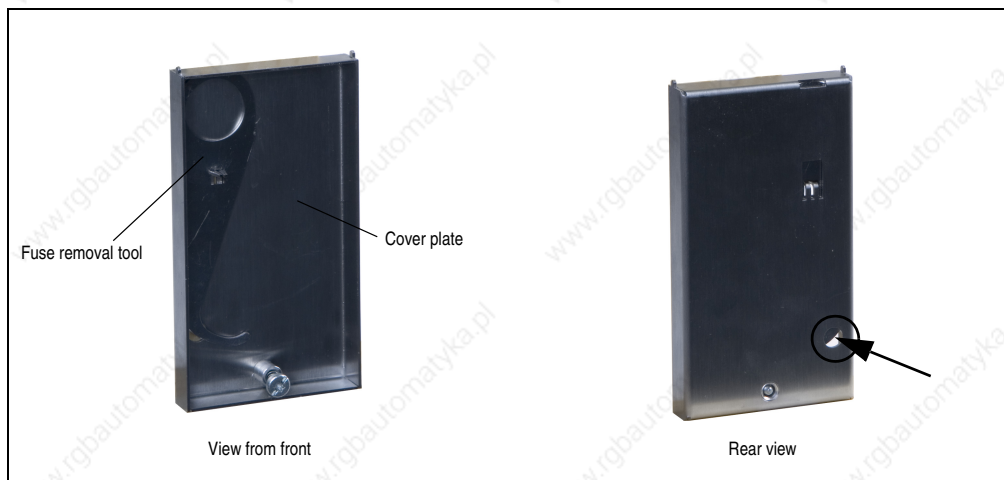


Figure 16: Removing the fuse removal tool

4) Insert the hooked end of the fuse removal tool under the fuse you would like to remove.

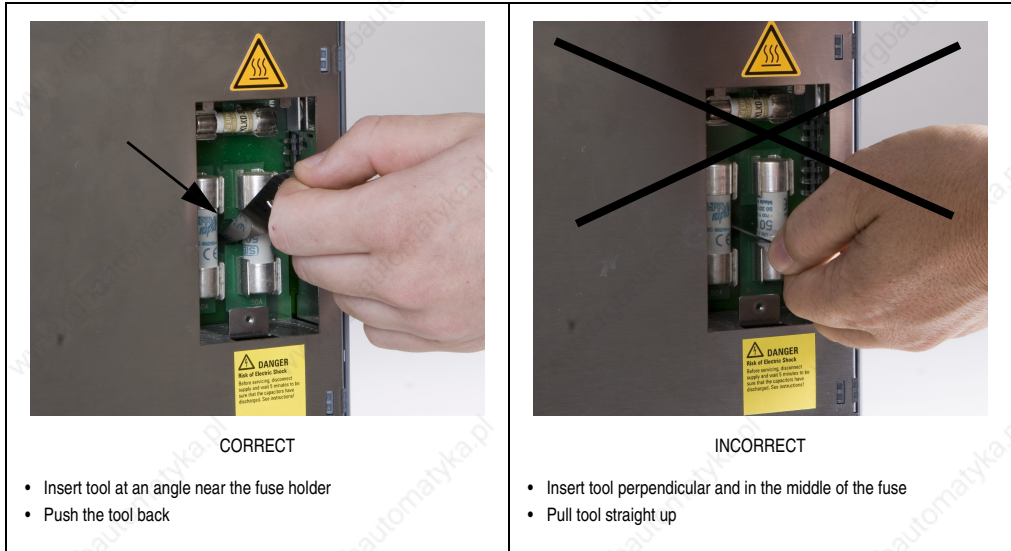


Figure 17: Using the fuse removal tool

5) Push the tool back to lever out the fuse.

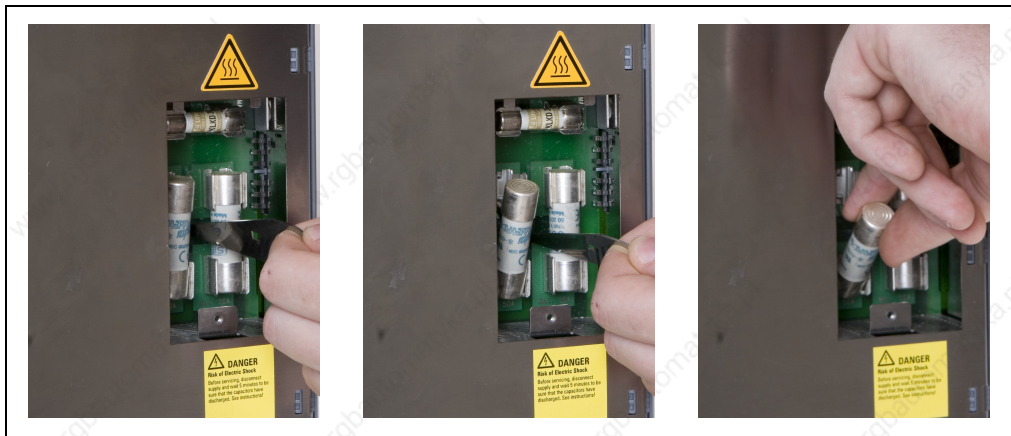


Figure 18: Lever out and remove the fuse

- 6) Pull fuse out of the fuse holder.
- 7) Place the new fuse in the fuse holder.
- 8) Put fuse removal tool back in the cover plate.
- 9) Put cover plate back on the module and tighten the fastening screw.

1.5 8BVR regeneration chokes

ACOPOSmulti 8BVR regeneration chokes must be installed in a closed electrical operating area (e.g. a switching cabinet).

Caution!

Certain installation positions can block the view of the warning sticker on the regeneration choke. Therefore, two additional warning stickers are included in the delivery for the user to place in a clearly visible location on the regeneration choke. These warning stickers are attached to the regeneration choke by a cable tie and must be removed before initial start-up because the backing film for the warning sticker is not sufficiently heat-resistant!

Warning!

When installing ACOPOSmulti regeneration chokes make sure that the windings and connection wires are strongly insulated from the neighboring electrically conductive components (e.g. switching cabinet wall).

If this reinforced insulation is implemented with an area of empty space, then a minimum distance of 8 mm (or 12.7 mm in accordance to cULus) to the neighboring conductive parts is necessary.

1.6 8B0W external braking resistors

Danger!

8B0W external braking resistors can reach extremely high surface temperatures during operation (depending on the type, up to a max. 355°C under nominal conditions).

It is therefore important to ensure that 8B0W external braking resistors are only installed on surfaces that are suited for these high temperatures!

Danger!

Direct contact between operating personnel and the hot surfaces of 8B0W external braking resistors must be prevented using suitable measures in order to avoid serious burns!

Danger!

8B0W external braking resistors can be considered intrinsically safe if they are connected to a 8B0P passive power supply module operated with a mains supply voltage of 3 x 380 - 500 VAC. The maximum time until the 8B0W external braking resistors are damaged is approximately 5.5 min in this case; a maximum surface temperature of approximately 479°C is achieved when this happens.

1.6.1 Mounting orientation

The following mounting orientations are permitted for 8B0W external braking resistors:

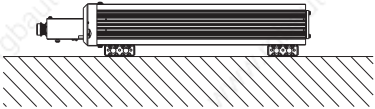
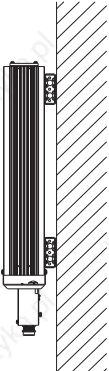
Standing horizontally	Hanging vertically, bottom of terminal box
	

Table 174: Permissible mounting orientations for 8B0W external braking resistors

The following mounting orientation is not permitted:

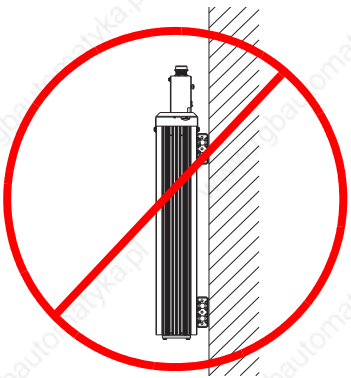
Hanging vertically, top of terminal box
<div style="display: flex; align-items: center;">  <div style="margin-left: 20px;"> <p>Danger!</p> <p>Vertical mounting on the top of the terminal box can cause the temperature in the terminal box to increase sharply due to the heat from the 8B0W external braking resistor. In extreme cases, this can damage the insulation on the connection cable and cause short-circuits in the connection terminal!</p> </div> </div>

Table 175: Impermissible mounting orientation for 8B0W external braking resistors

2. Motor cables

2.1 Assembly example (module-side) of a 1.5 mm² motor cable

- 1) Shorten motor cable to required length.
- 2) Strip motor cable on the module-end of cable (make sure not to damage the entire shield mesh)

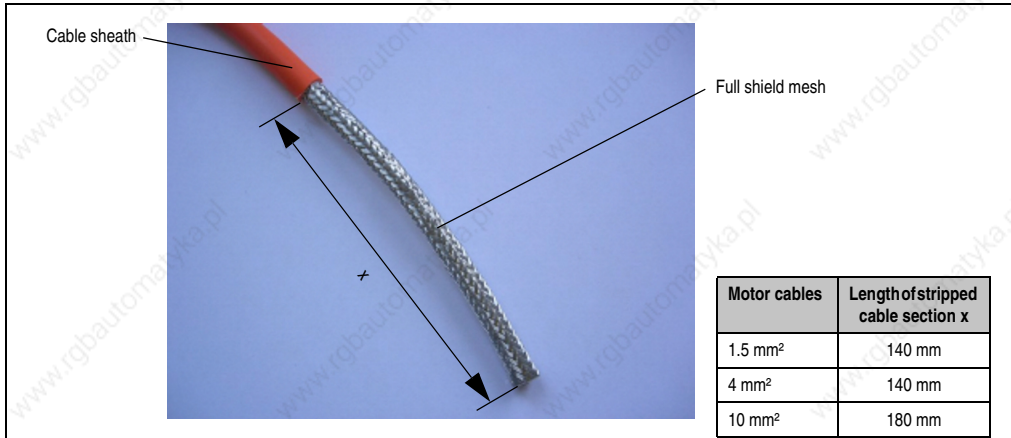


Figure 19: Stripped cable end

- 3) Pull the entire shield back over the cable sheath and cut off the stranding elements

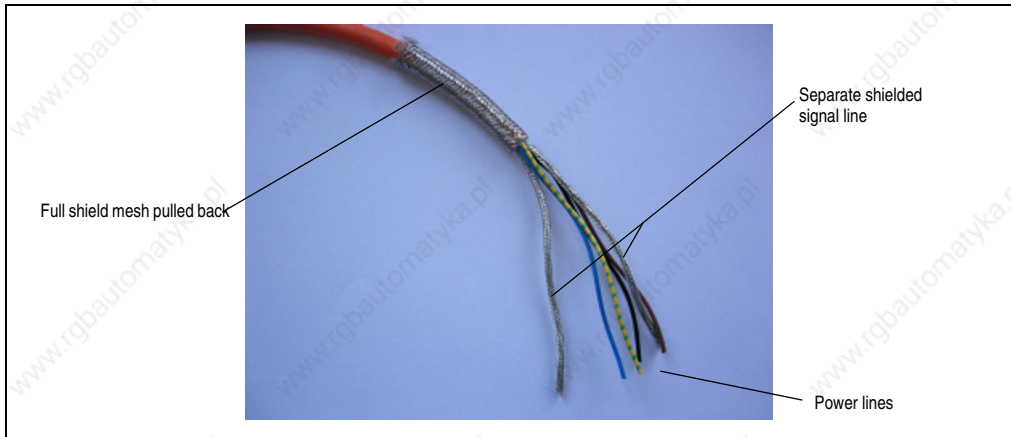


Figure 20: Cable ends with shielding mesh pulled back

4) Pull the separately shielded signal lines (2 x 2 lines) from the shielding mesh.

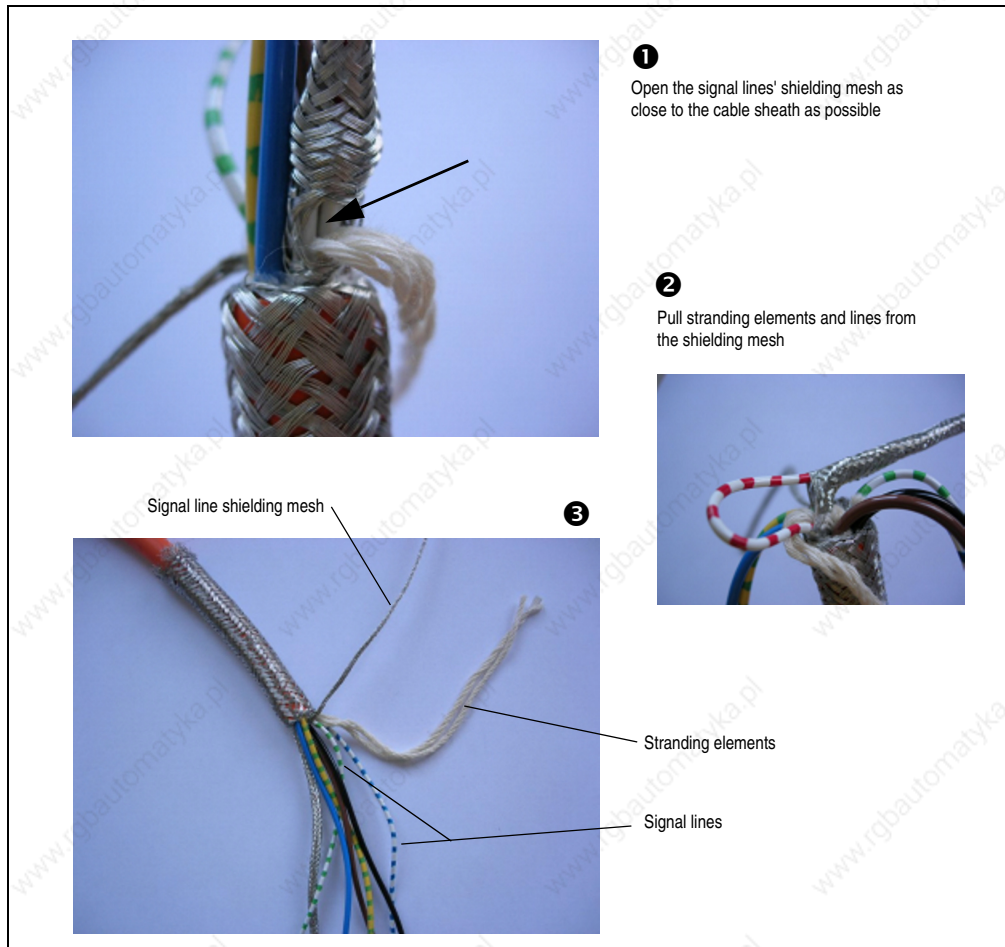


Figure 21: Pulling out the separately shielded signal lines

- 5) Cut the stranding elements of the separately shielded line.

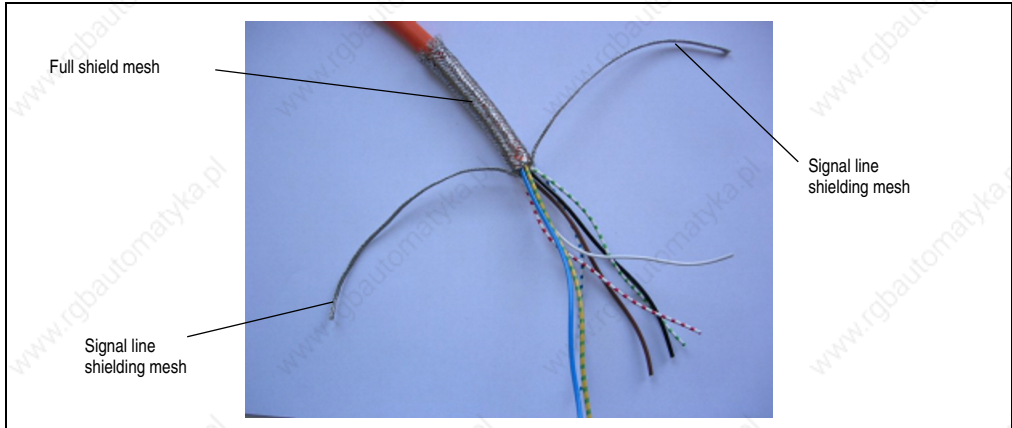


Figure 22: Cable end without stranding elements

- 6) Shorten the shielding mesh to a length of approximately 40 mm and pull the signal line's shielding mesh over the cable sheath.

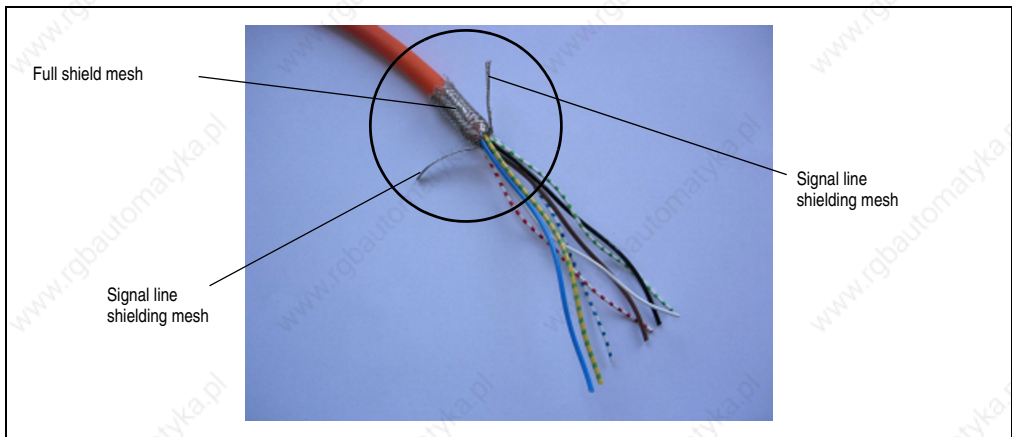


Figure 23: Cable ends with shortened shielding mesh

Installation • Motor cables

- 7) Attach all shielding mesh to the cable sheath using heat shrink tubing (approx. 20 mm long), and leaving approximately 30 mm of the shielding mesh free. ¹⁾

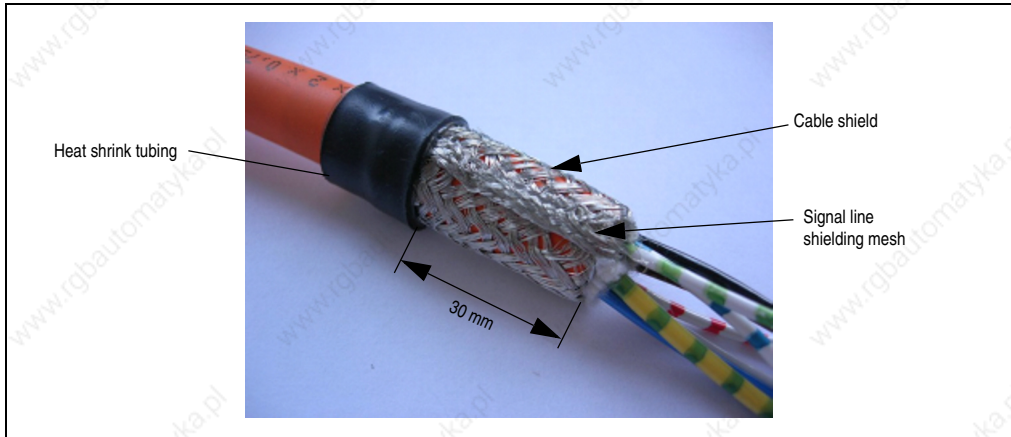


Figure 24: Attaching the shielding mesh

- 8) Strip wire ends and attach wire tip sleeves.

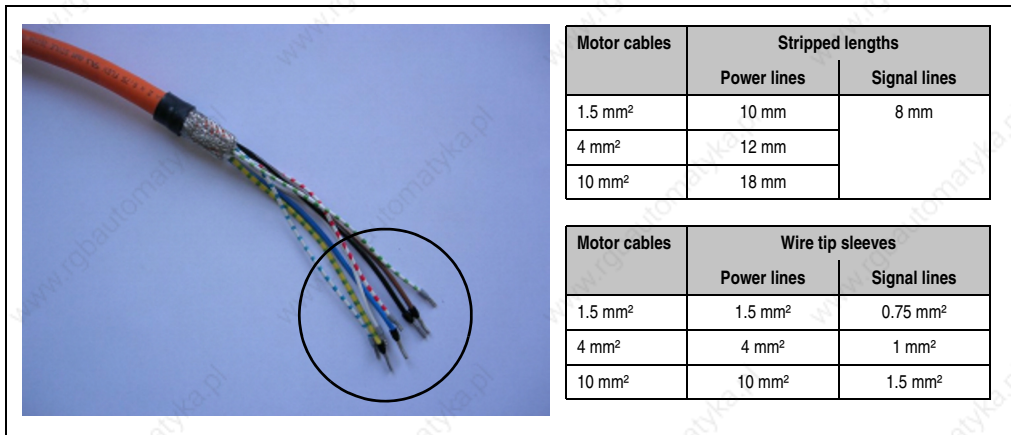


Figure 25: Wire ends with wire tip sleeves

¹⁾ We recommend using heat shrink tubing with adhesive filling.

9) Install shield components (shield component set 8SCS000.0000-00 as example).

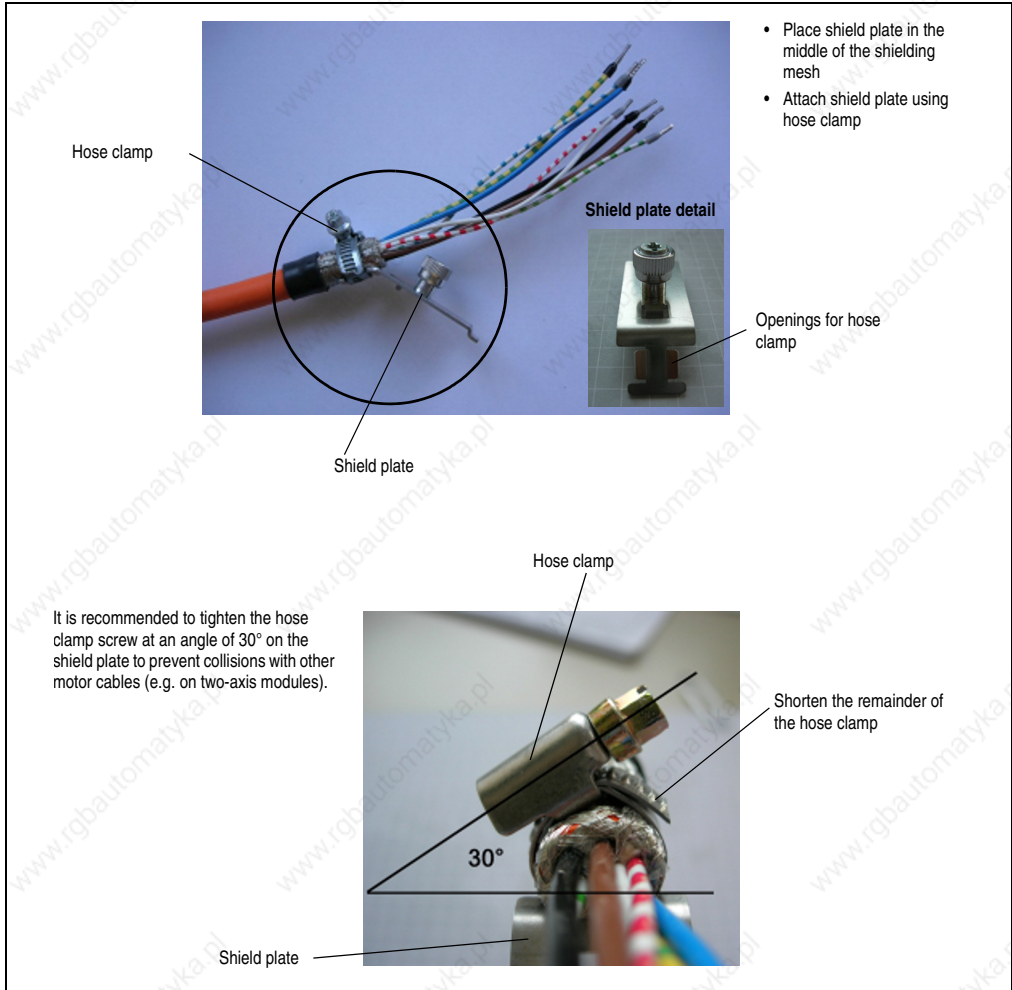


Figure 26: Installation of shield components

3. Shield component set 8SCS002.0000-00

The shield set 8SCS002.0000-00 can be used for shielding I/O cables for the connections on the top of ACOPOSmulti modules.

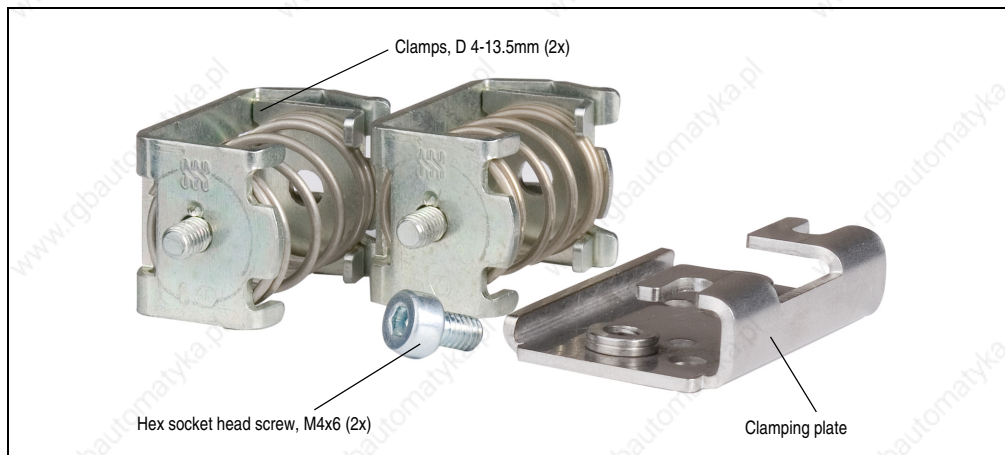


Figure 27: Shield set 8SCS002.0000-00

Required tools

- Flat-head screwdriver, size 2
- Hex key, size 3 mm

3.1 Preparation

Before installing the shield set 8SCS002.0000-00, a tab must first be removed from the top left plastic cover of the ACOPOSmulti module using a suitable tool (such as a flat-head screwdriver):

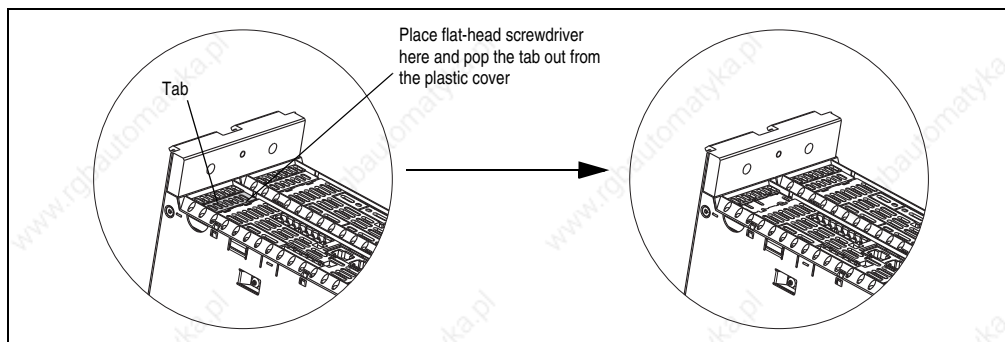


Figure 28: Popping out the tab

3.2 Installation

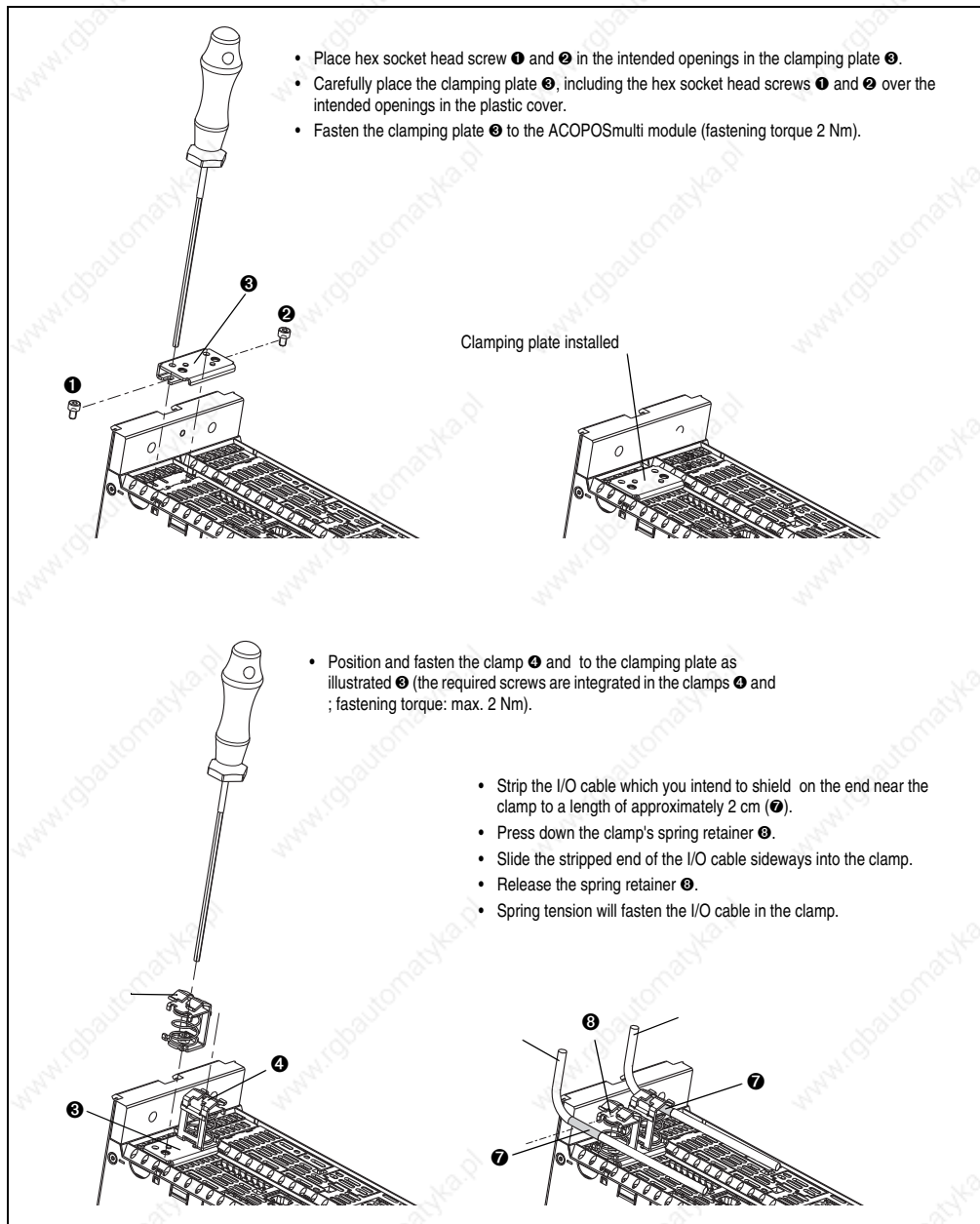


Figure 29: Installation of 8SCS002.0000-00

4. Dimension diagrams and installation dimensions

4.1 General information

4.1.1 Swivel range of the connector cover

Keep the swivel range of the connector cover(s) on the front side of the ACOPOSmulti modules free when installed to prevent cabling problems with ACOPOSmulti modules:

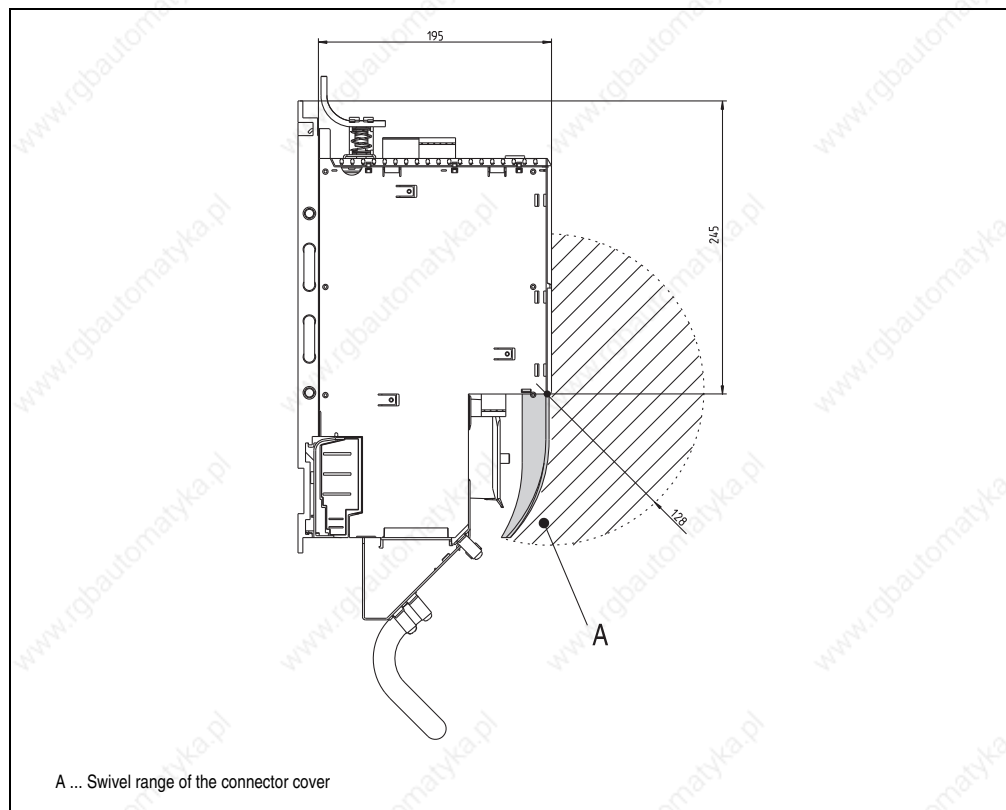


Figure 30: Swivel range of the connector cover

4.2 8B0F passive line filter

4.2.1 8B0F0300H000.000-1

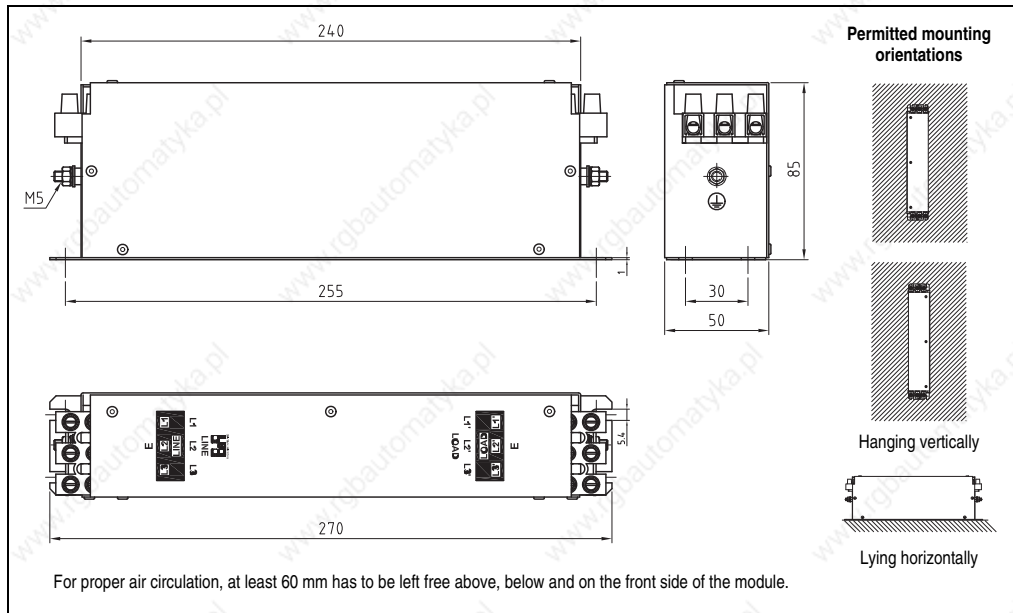


Figure 31: Dimension diagram and installation dimensions for 8B0F0300H000.000-1

4.2.2 8B0F0550H000.000-1

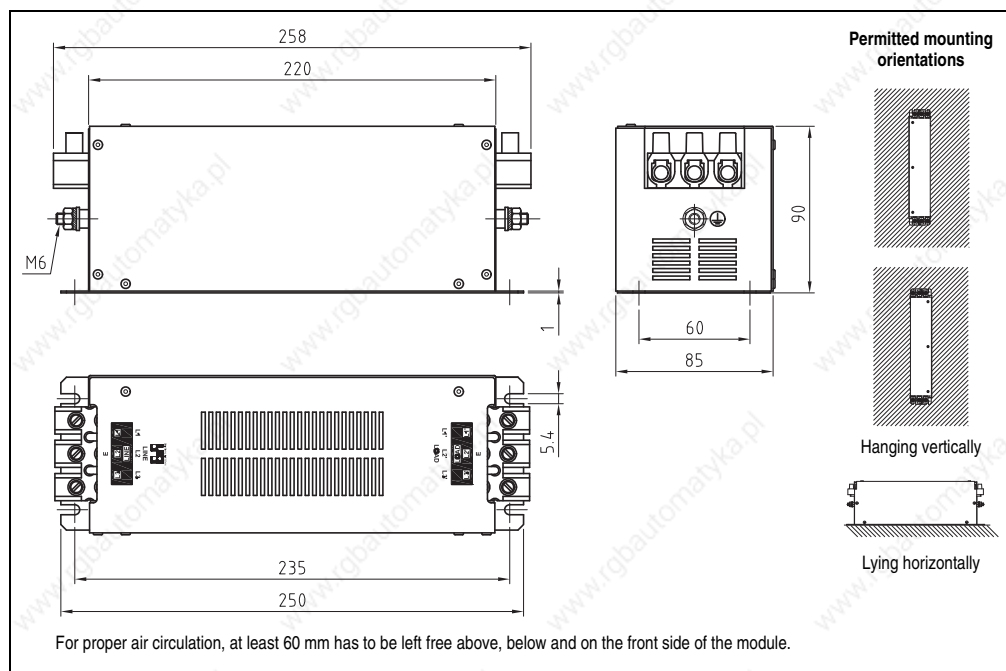


Figure 32: Dimension diagram and installation dimensions for 8B0F0550H000.000-1

4.3 8BVF line filter

4.3.1 8BVF0220H000.000-1, 8BVF0440H000.001-2

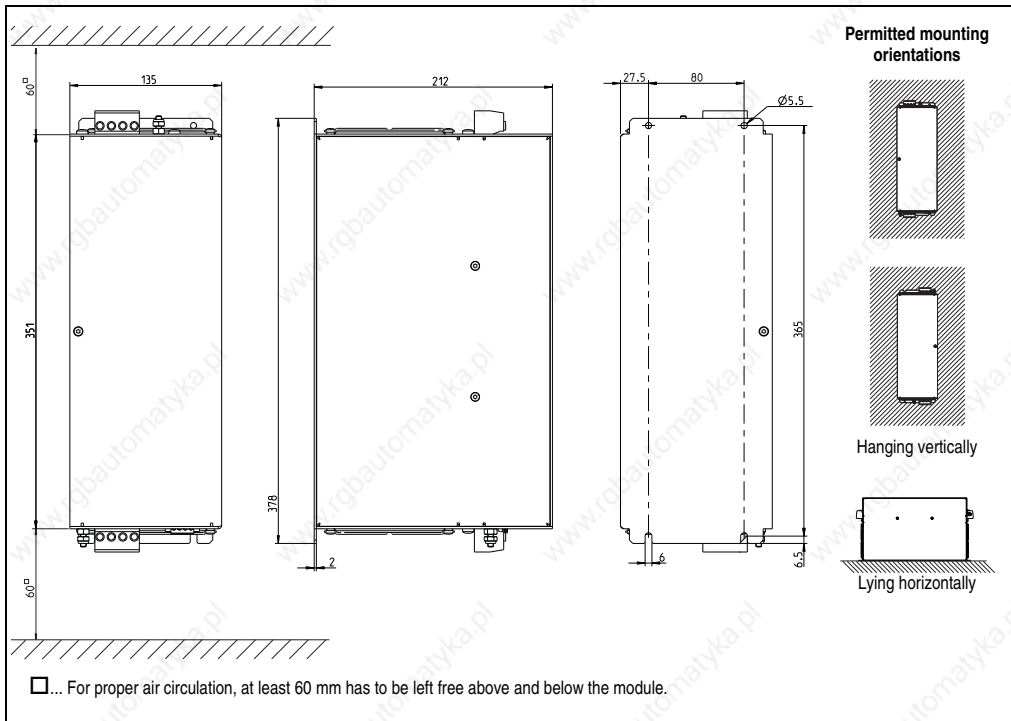


Figure 33: Dimensional diagram and installation dimensions for 8BVF0220H000.000-1, 8BVF0440H000.001-2

4.3.2 8BVF0880H000.000-1

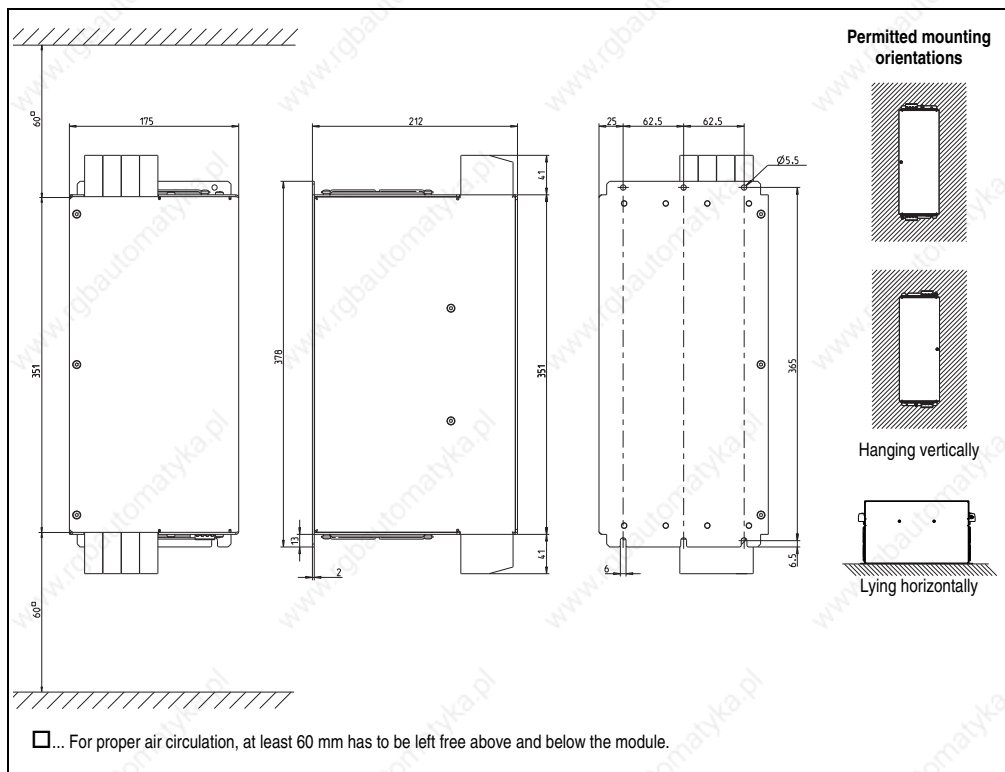


Figure 34: Dimensional diagram and installation dimensions for 8BVF8800H000.000-1

4.4 8BVR regeneration chokes

Caution!

Certain installation positions can block the view of the warning sticker on the regeneration choke. Therefore, two additional warning stickers are included in the delivery for the user to place in a clearly visible location on the regeneration choke. These warning stickers are attached to the regeneration choke by a cable tie and must be removed before initial start-up because the backing film for the warning sticker is not sufficiently heat-resistant!

4.4.1 8BVR0220H000.100-1

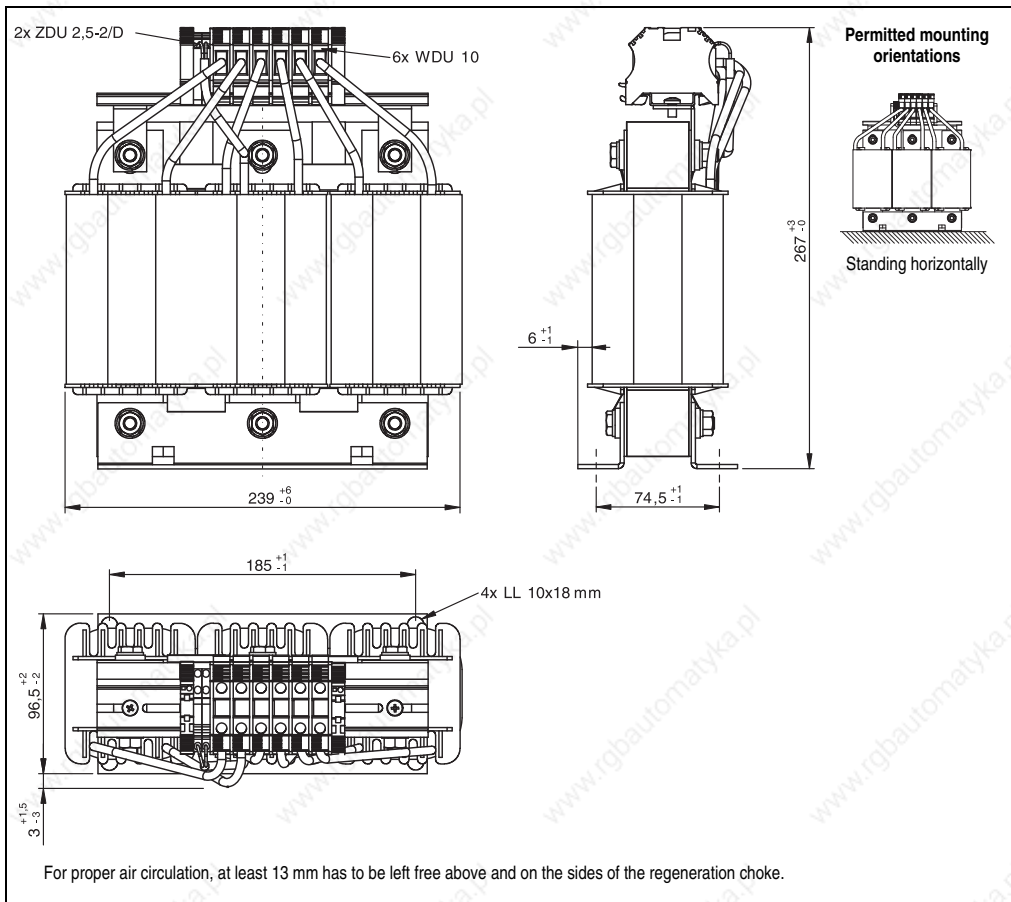


Figure 35: Dimensional diagram and installation dimensions for 8BVR0220H000.100-1

Warning!

When installing ACOPOSmulti regeneration chokes make sure that the windings and connection wires are strongly insulated from the neighboring electrically conductive components (e.g. switching cabinet wall).

If this reinforced insulation is implemented with an area of empty space, then a minimum distance of 8 mm (or 12.7 mm in accordance to cULus) to the neighboring conductive parts is necessary.

4.4.2 8BVR0440H000.100-1

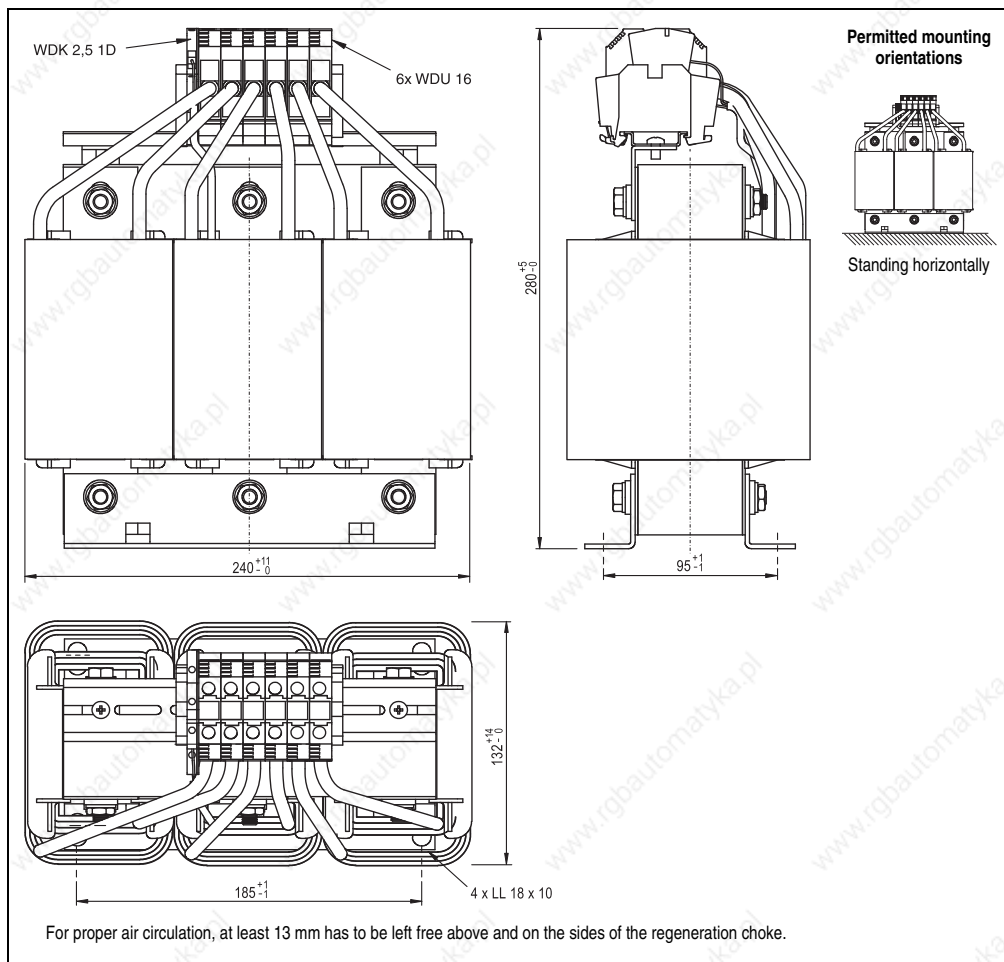


Figure 36: Dimension diagram and installation dimensions for 8BVR0440H000.100-1

Warning!

When installing ACOPOSmulti regeneration chokes make sure that the windings and connection wires are strongly insulated from the neighboring electrically conductive components (e.g. switching cabinet wall).

If this reinforced insulation is implemented with an area of empty space, then a minimum distance of 8 mm (or 12.7 mm in accordance to cULus) to the neighboring conductive parts is necessary.

4.4.3 8BVR0880H000.100-1

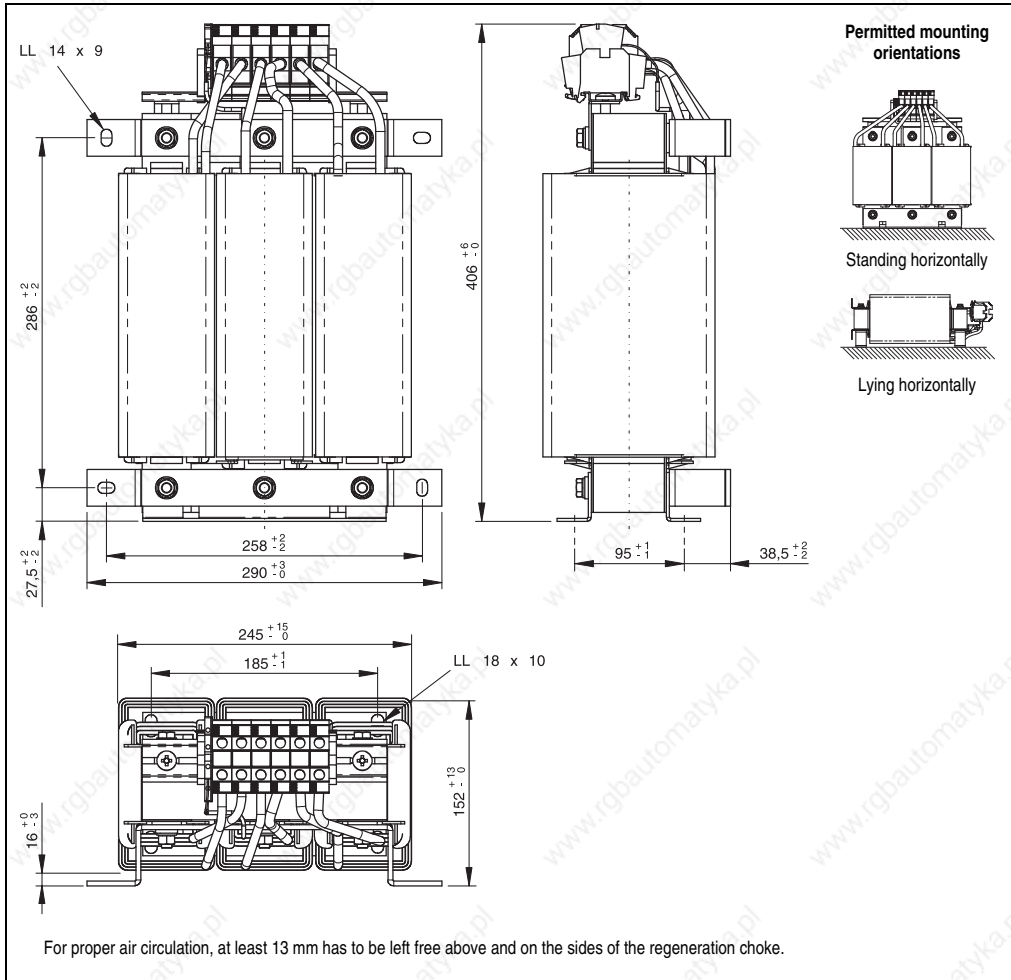


Figure 37: Dimension diagram and installation dimensions for 8BVR0880H000.100-1

Warning!

When installing ACOPOSmulti regeneration chokes make sure that the windings and connection wires are strongly insulated from the neighboring electrically conductive components (e.g. switching cabinet wall).

If this reinforced insulation is implemented with an area of empty space, then a minimum distance of 8 mm (or 12.7 mm in accordance to cULus) to the neighboring conductive parts is necessary.

4.5 Wall mounting

4.5.1 Mounting plate 8B0MnnnnHW00.000-1 ¹⁾

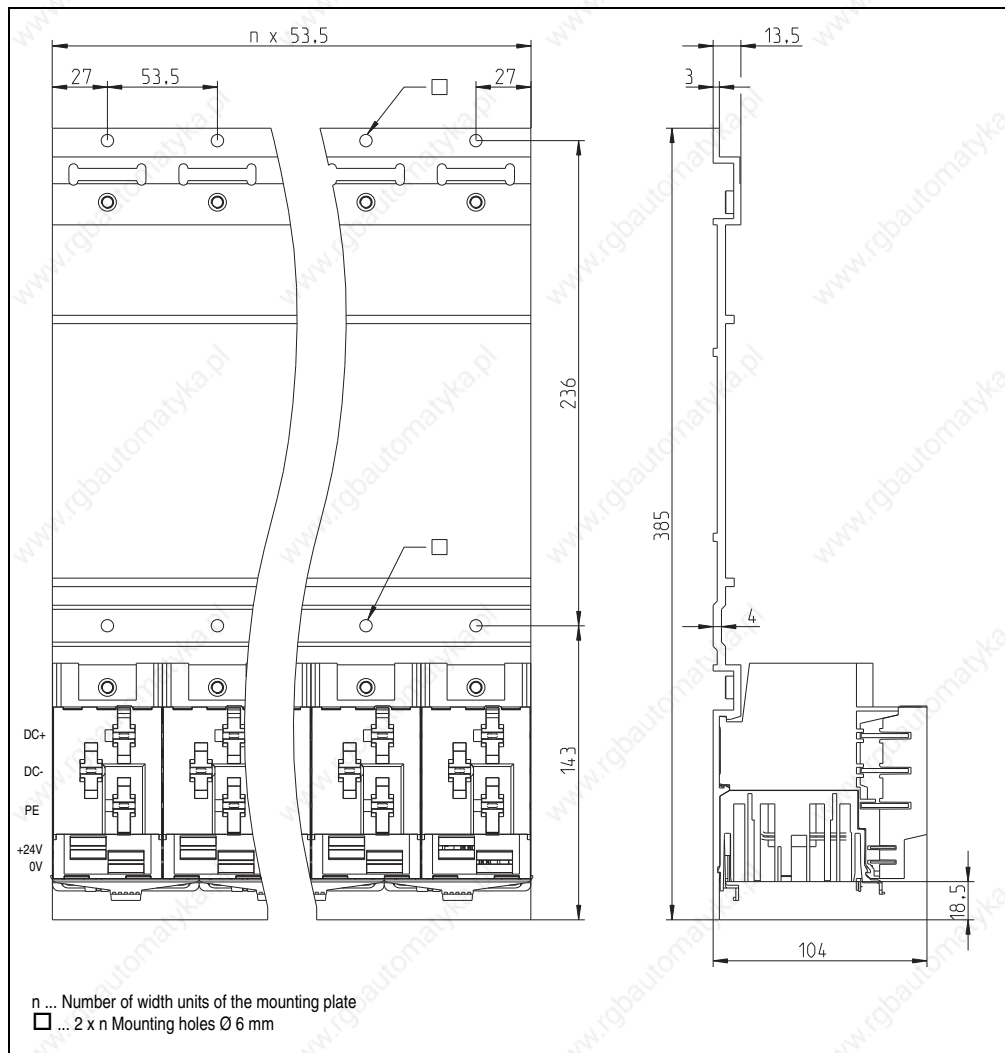


Figure 38: Dimension diagram and installation dimensions - 8B0MnnnnHW00.000-1

1) nnnn indicates the number of slots (0160 equals 16 slots).

4.5.2 Power supply modules 8BxP0220HW00.000-1, 8BxP0440HW00.000-1

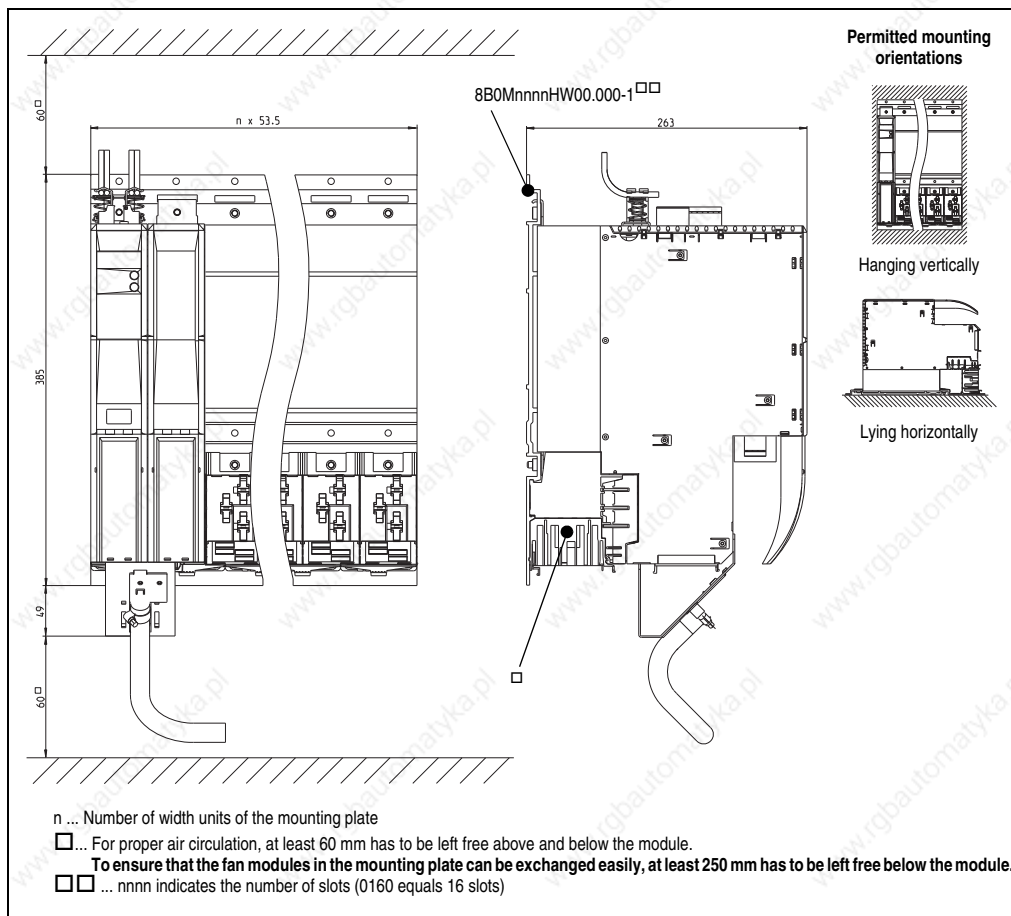


Figure 39: Dimension diagram and installation dimensions for 8BxP0220HW00.000-1, 8BxP0440HW00.000-1

4.5.3 Power supply module 8BVP0880HW00.000-1

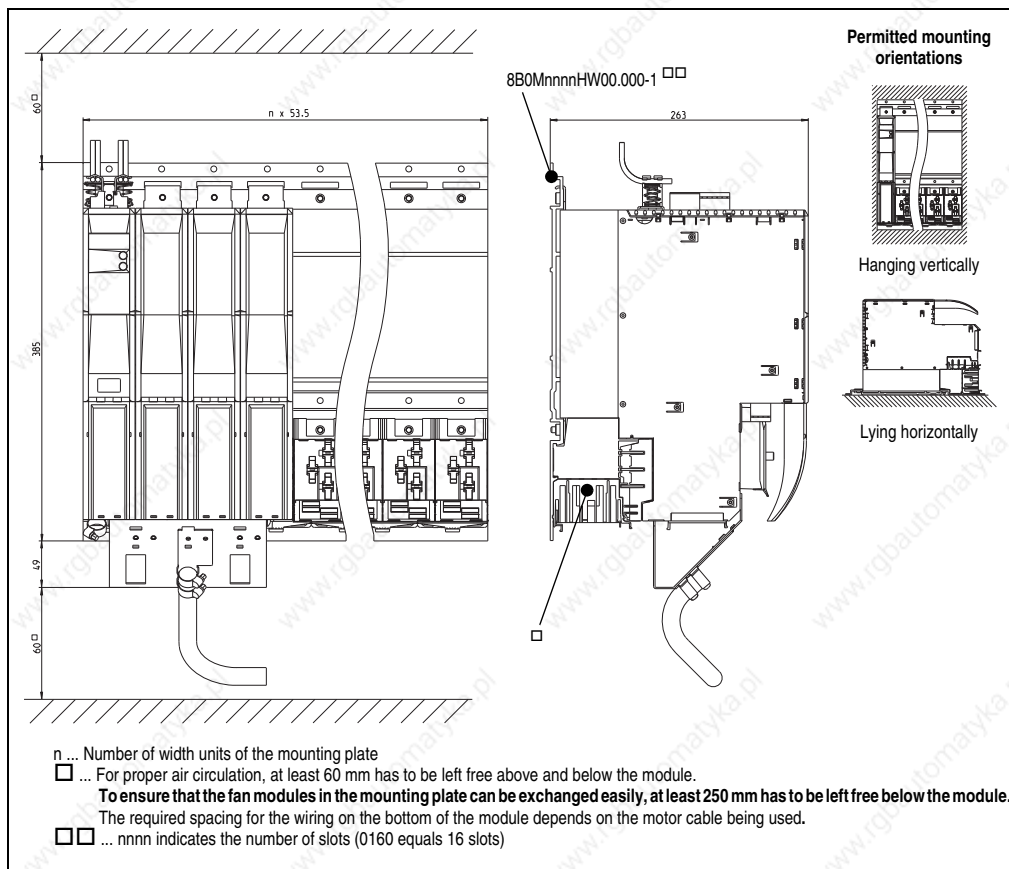


Figure 40: Dimensional diagram and installation dimensions for 8BVP0880HW00.000-1

4.5.4 Control supply units

8B0C0160HW00.000-1, 8B0C0320HW00.000-1

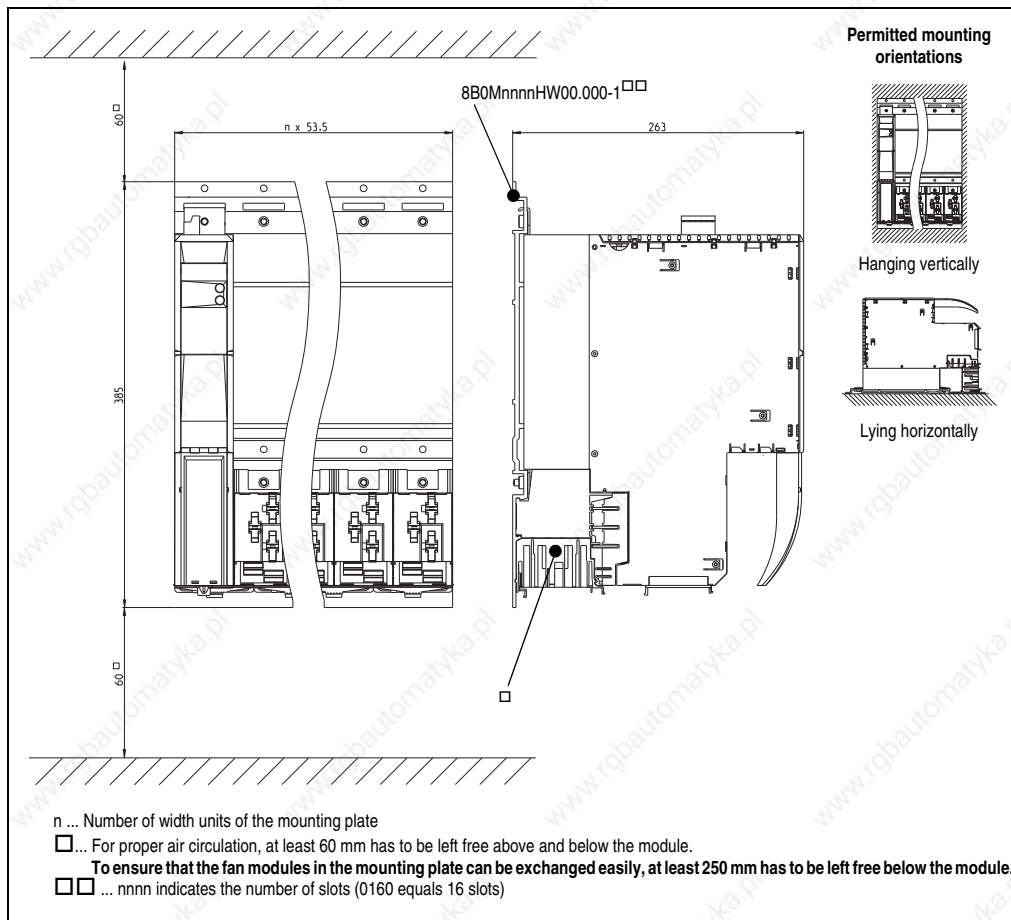


Figure 41: Dimension diagram and installation dimensions for 8B0C0160HW00.000-1, 8B0C0320HW00.000-1

8B0C0160HW00.001-1, 8B0C0320HW00.002-1, 8B0C0320HW00.00A-1

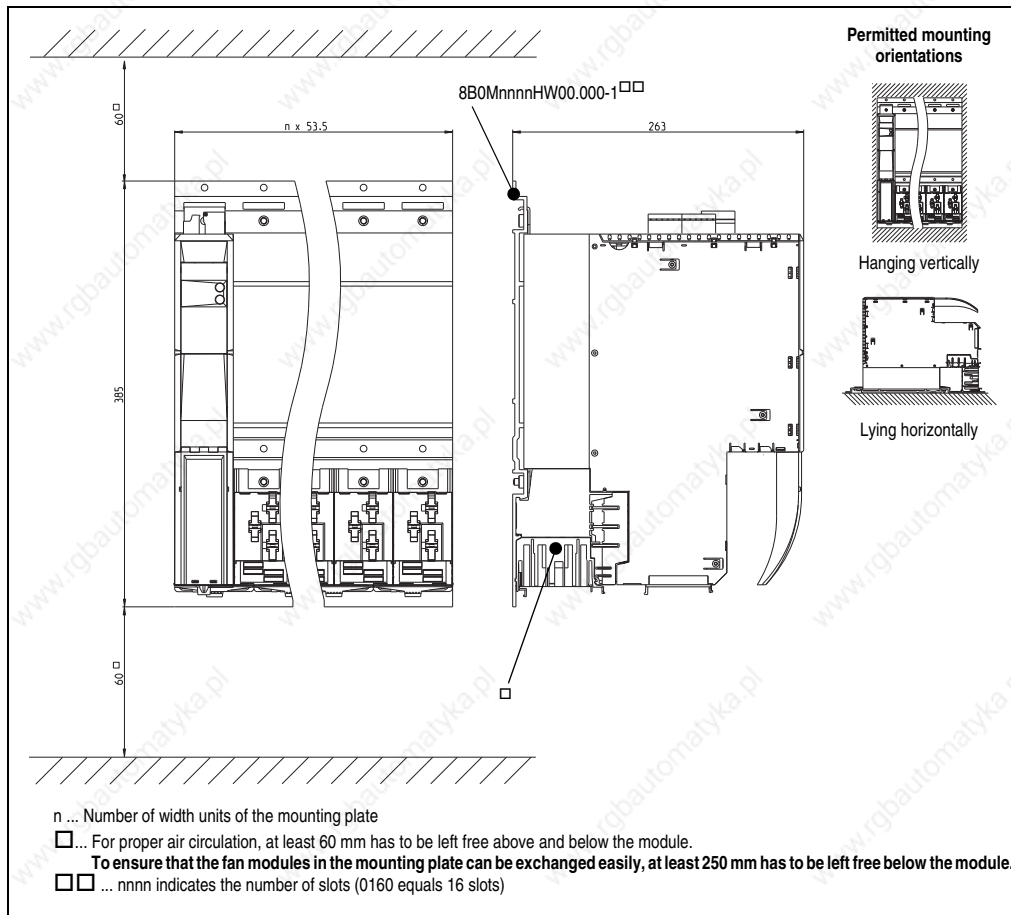


Figure 42: Dimension diagram and installation dimensions for 8B0C0160HW00.001-1, 8B0C0320HW00.002-1, 8B0C0320HW00.00A-1

4.5.5 Single-width inverter modules (single-axis modules)

8BVI0014HWSx.000-1, 8BVI0028HWSx.000-1, 8BVI0055HWSx.000-1, 8BVI0110HWSx.000-1

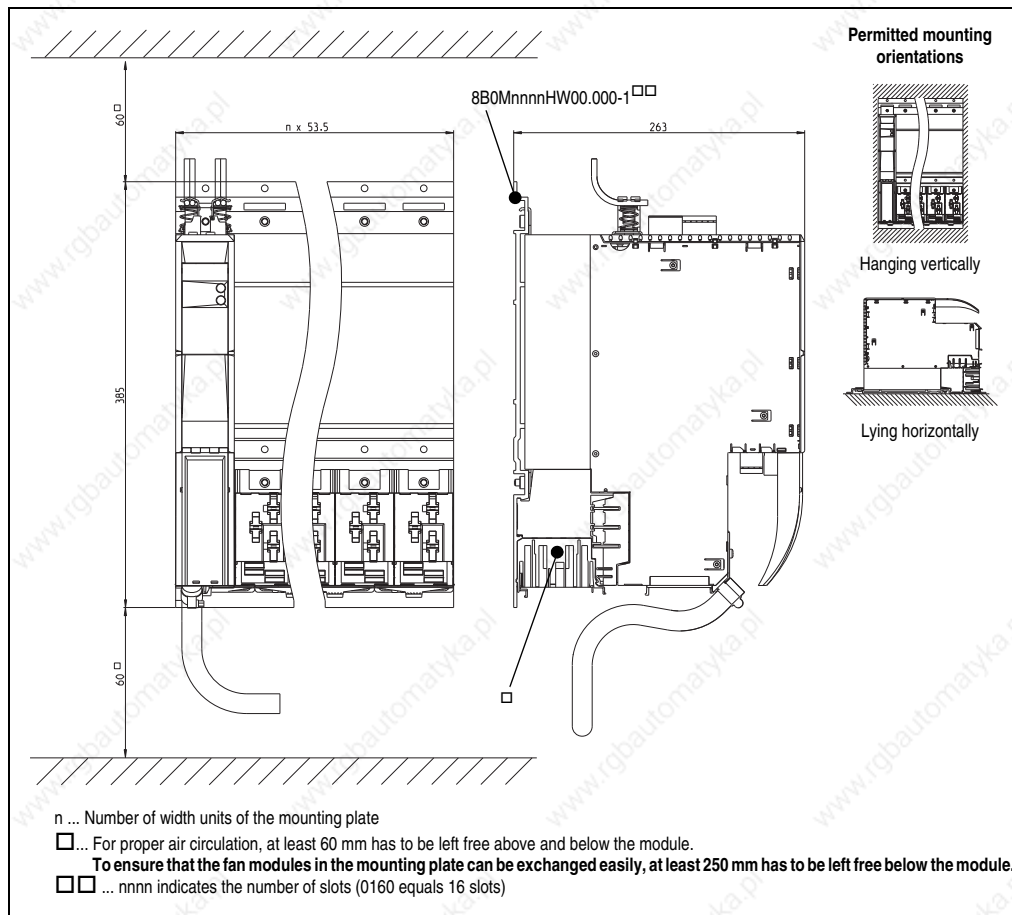


Figure 43: Dimension diagram and installation dimensions for 8BVI0014HWSx.000-1, 8BVI0028HWSx.000-1, 8BVI0055HWSx.000-1, 8BVI0110HWSx.000-1

4.5.6 Single-width inverter modules (two-axis modules)

8BVI0014HWDx.000-1, 8BVI0028HWDx.000-1, 8BVI0055HWDx.000-1

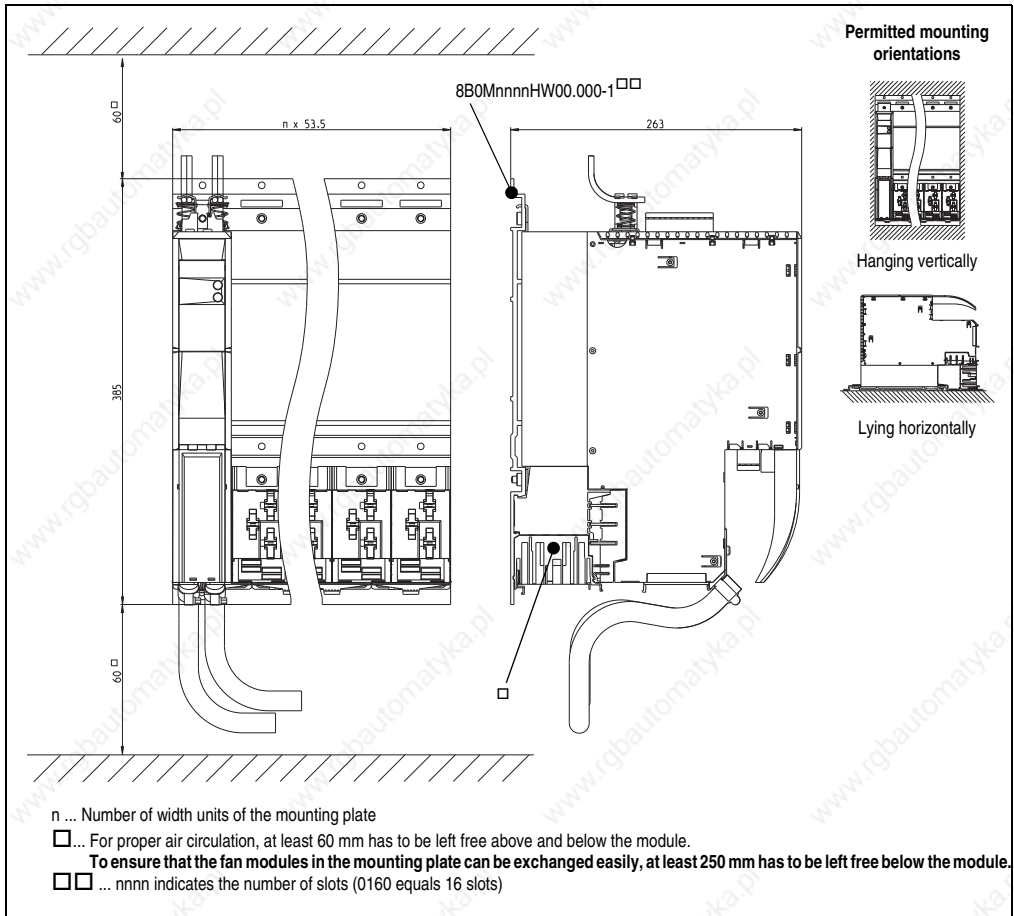


Figure 44: Dimension diagram and installation dimensions for 8BVI0014HWDx.000-1, 8BVI0028HWDx.000-1, 8BVI0055HWDx.000-1

4.5.7 Inverter modules 8BVI0220HWSx.000-1, 8BVI0440HWSx.000-1

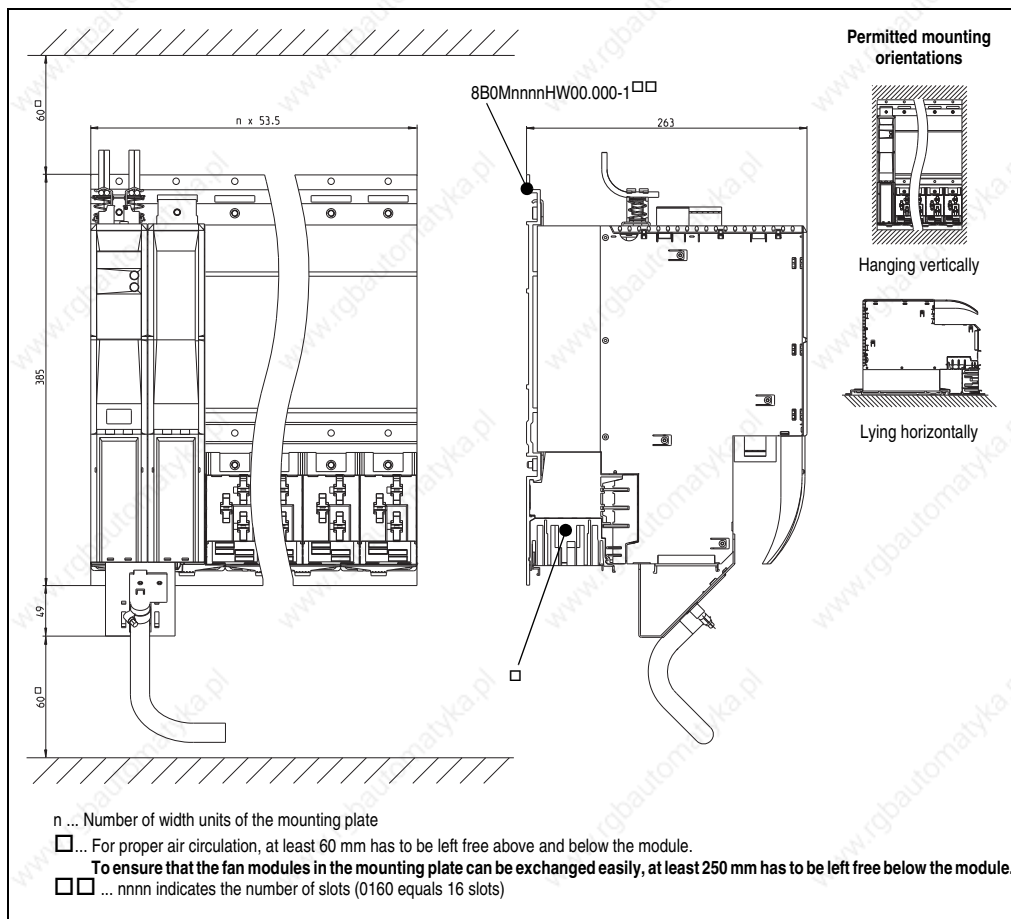


Figure 45: Dimension diagram and installation dimensions for 8BVI0220HWSx.000-1, 8BVI0440HWSx.000-1

4.5.8 Inverter modules 8BVI0110HWDx.000-1, 8BVI0220HWDx.000-1

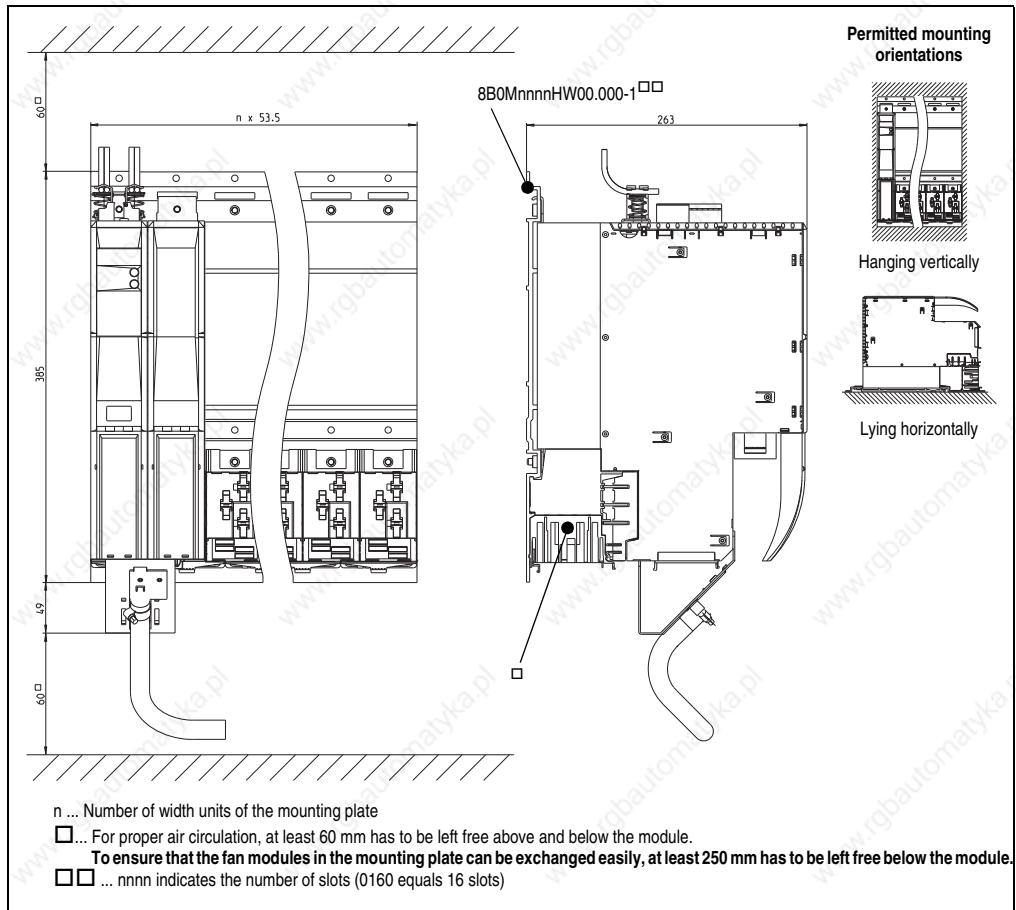


Figure 46: Dimension diagram and installation dimensions for 8BVI0220HWDx.000-1, 8BVI0220HWDx.000-1

4.5.9 Inverter module 8BV10880HWSx.000-1

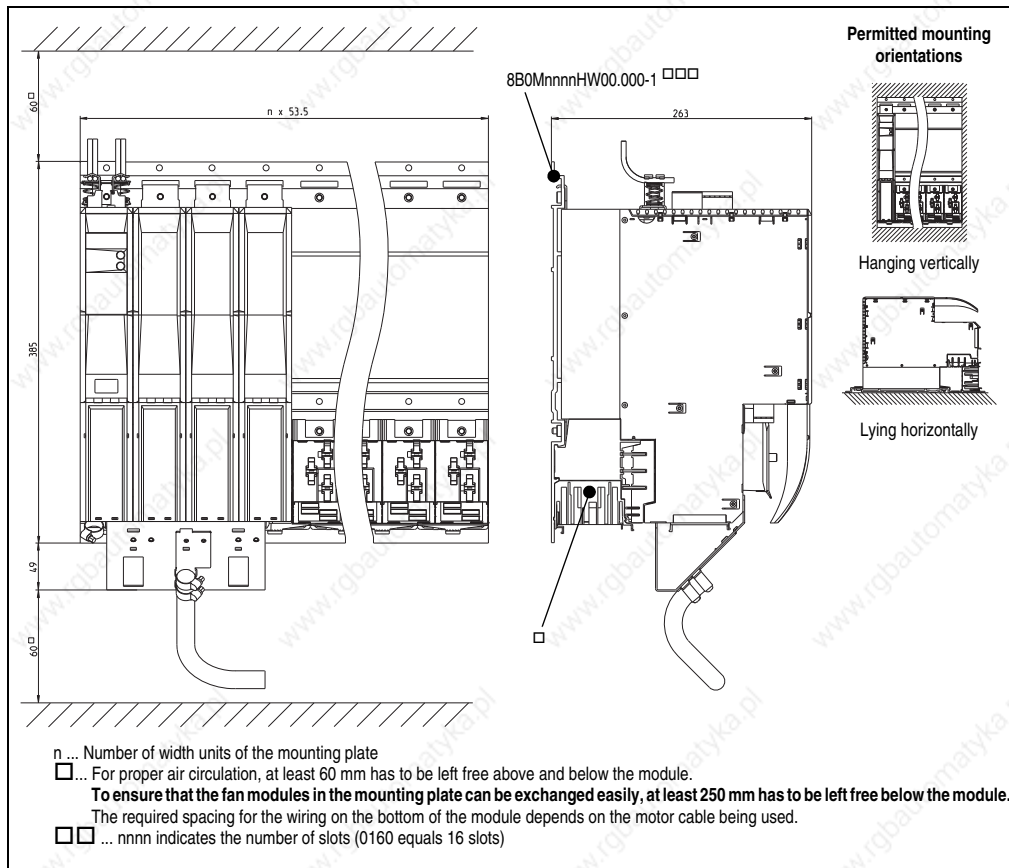


Figure 47: Dimension diagram installation dimensions for 8BV10880HWSx.000-1

4.5.10 Expansion module 8BVE0500HW00.000-1

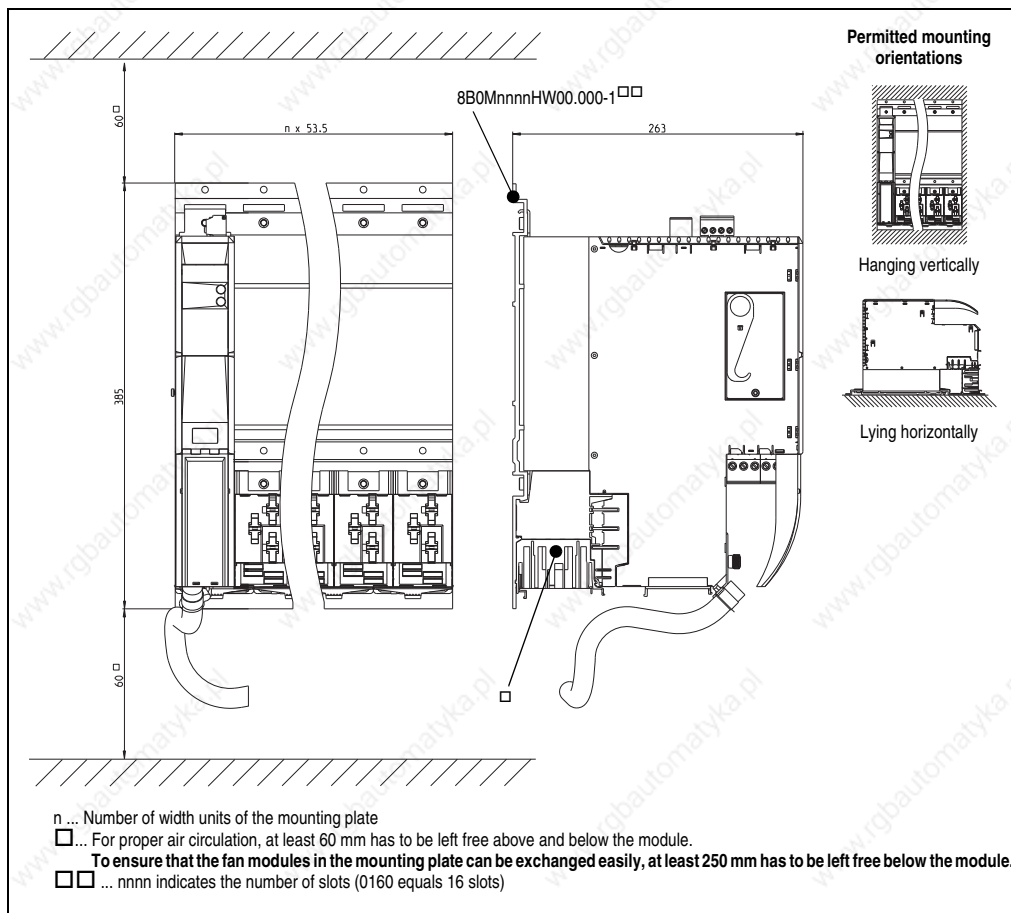


Figure 48: Dimension diagram and installation dimensions - 8BVE0500HW00.000-1

4.5.11 Capacitor module 8B0K1650HW00.000-1

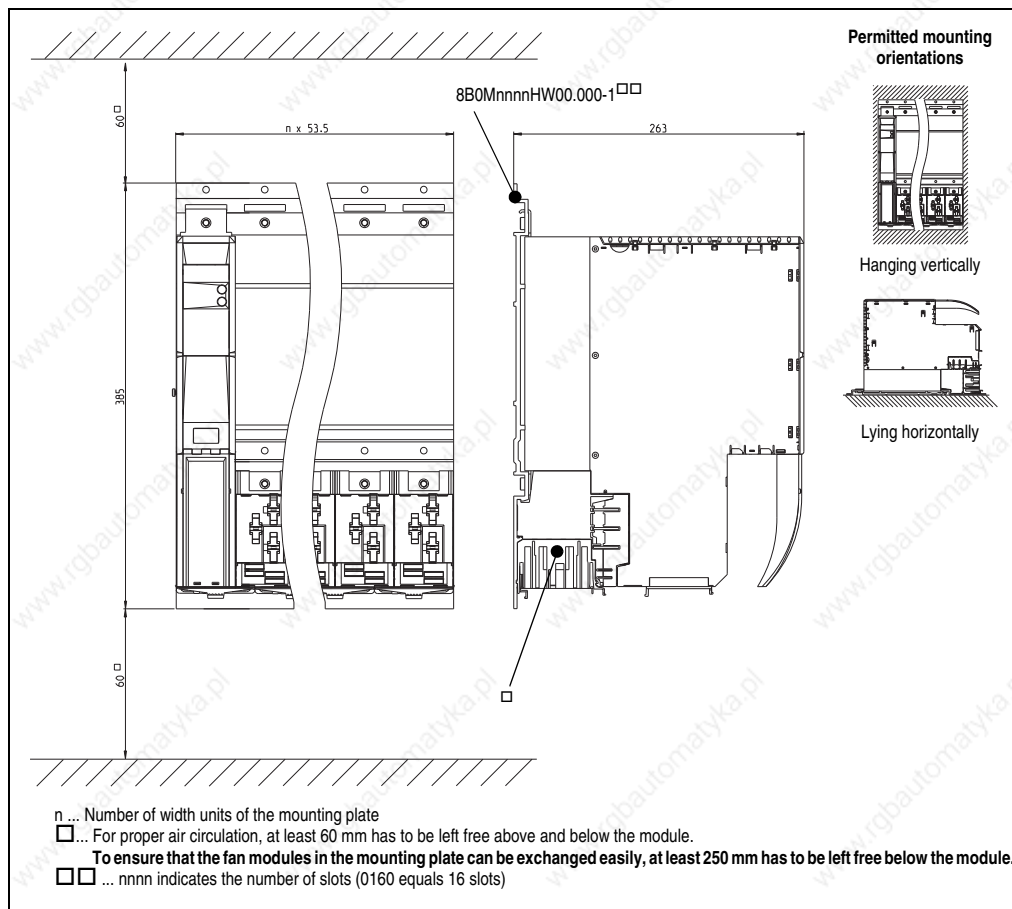


Figure 49: Dimension diagram and installation dimensions for 8B0K1650HW00.000-1

4.6 Cold-plate installation

4.6.1 Mounting plate 8B0MnnnnHC00.000-1 ¹⁾

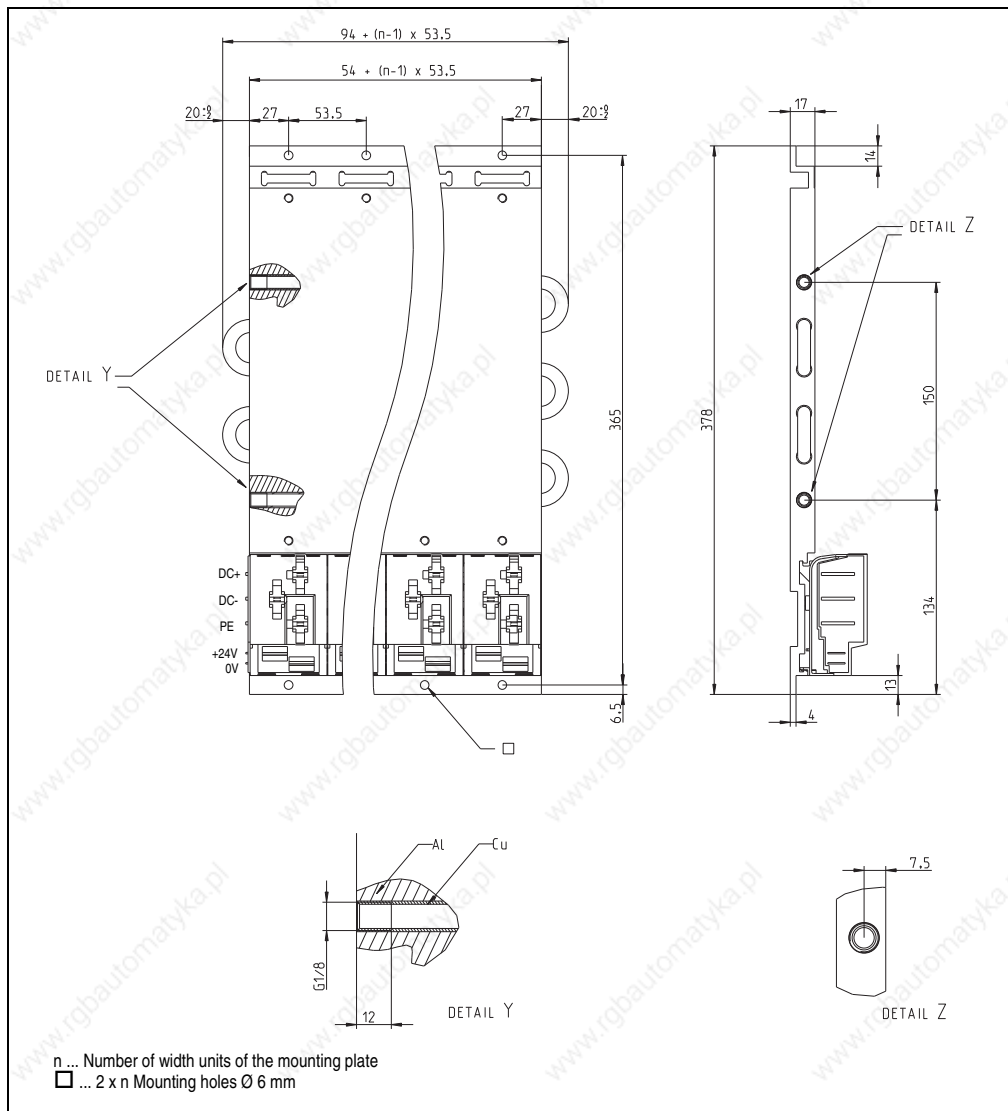


Figure 50: Dimension diagram and installation dimensions - 8B0MnnnnHC00.000-1

1) nnnn indicates the number of slots (0160 equals 16 slots).

4.6.2 Power supply module 8BxP0220HC00.000-1, 8BxP0440HC00.000-1

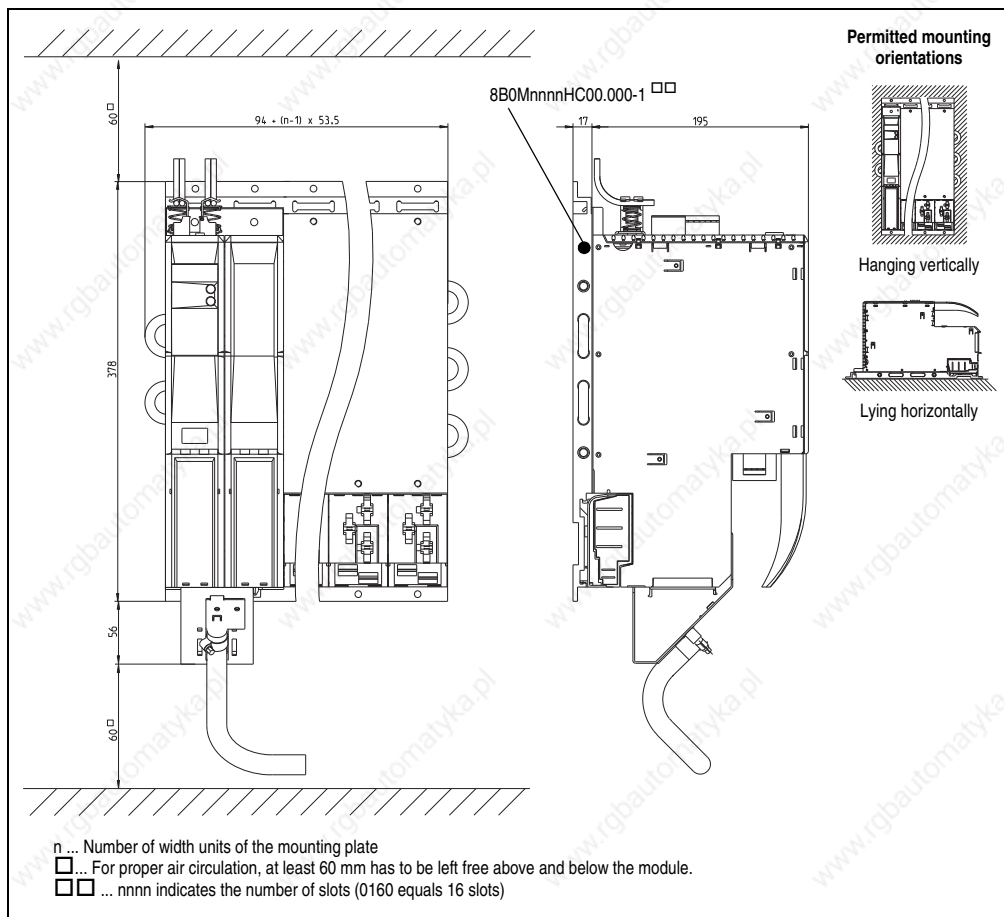


Figure 51: Dimension diagram and installation dimensions for 8BxP0220HC00.000-1, 8BxP0440HC00.000-1

Information:

When mounting ACOPOSmulti modules for cold-plate or feed-through mounting, be sure not to scratch the backplane. This can impair thermal dissipation to the mounting plate.

Do not set down ACOPOSmulti modules for cold-plate or feed-through mounting on their bottom side. Doing so could break the clips that hold the unit's fan. Broken clips make it more difficult to replace the fans later on.

4.6.3 Power supply module 8BVP0880HC00.000-1

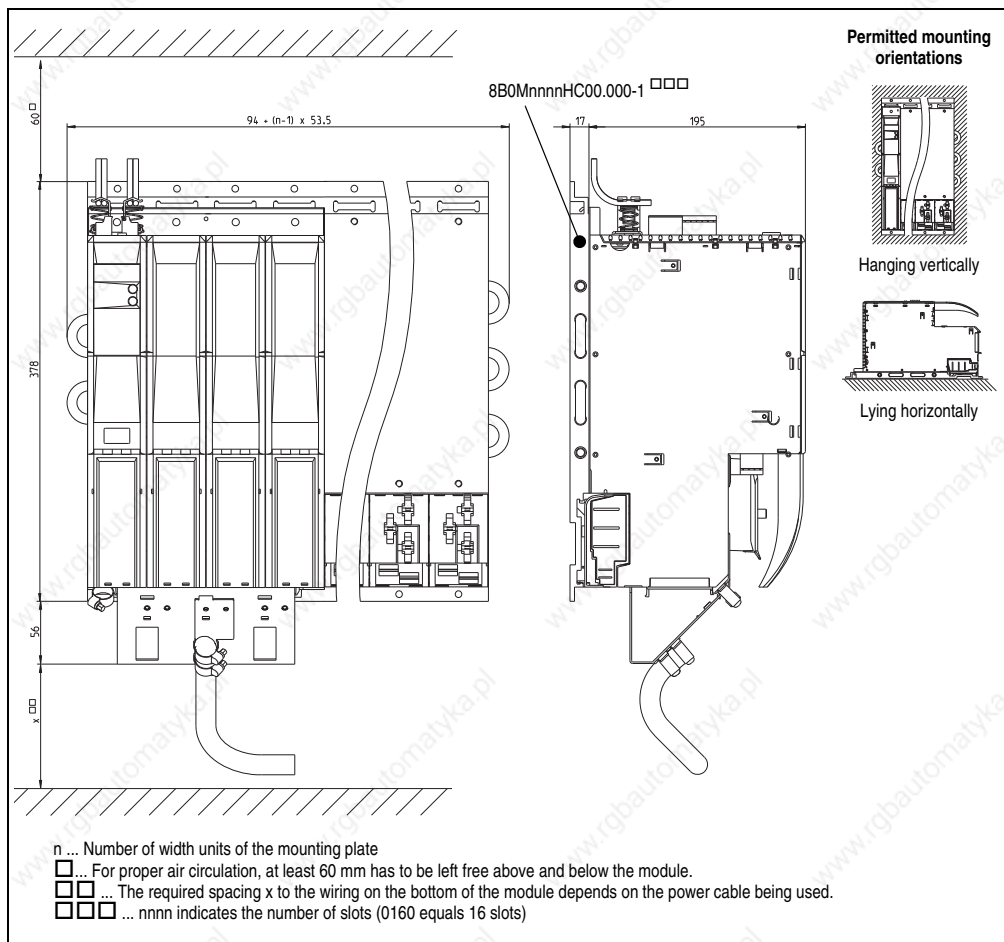


Figure 52: Dimension diagram and installation dimensions for 8BVP0880HC00.000-1

Information:

When mounting ACOPOSmulti modules for cold-plate or feed-through mounting, be sure not to scratch the backplane. This can impair thermal dissipation to the mounting plate.

Do not set down ACOPOSmulti modules for cold-plate or feed-through mounting on their bottom side. Doing so could break the clips that hold the unit's fan. Broken clips make it more difficult to replace the fans later on.

4.6.4 Power supply module 8BVP1650HC00.000-1

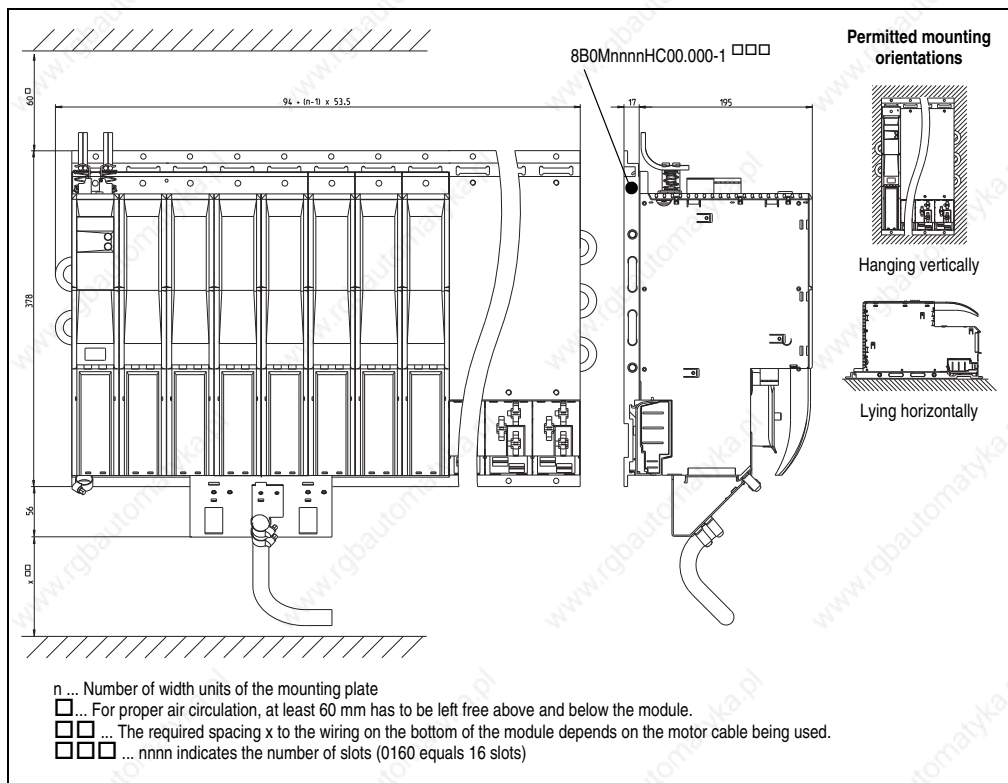


Figure 53: Dimension diagram and installation dimensions for 8BVP1650HC00.000-1

Information:

When mounting ACOPOSmulti modules for cold-plate or feed-through mounting, be sure not to scratch the backplane. This can impair thermal dissipation to the mounting plate.

Do not set down ACOPOSmulti modules for cold-plate or feed-through mounting on their bottom side. Doing so could break the clips that hold the unit's fan. Broken clips make it more difficult to replace the fans later on.

4.6.5 Control supply units

8B0C0160HC00.000-1, 8B0C0320HC00.000-1

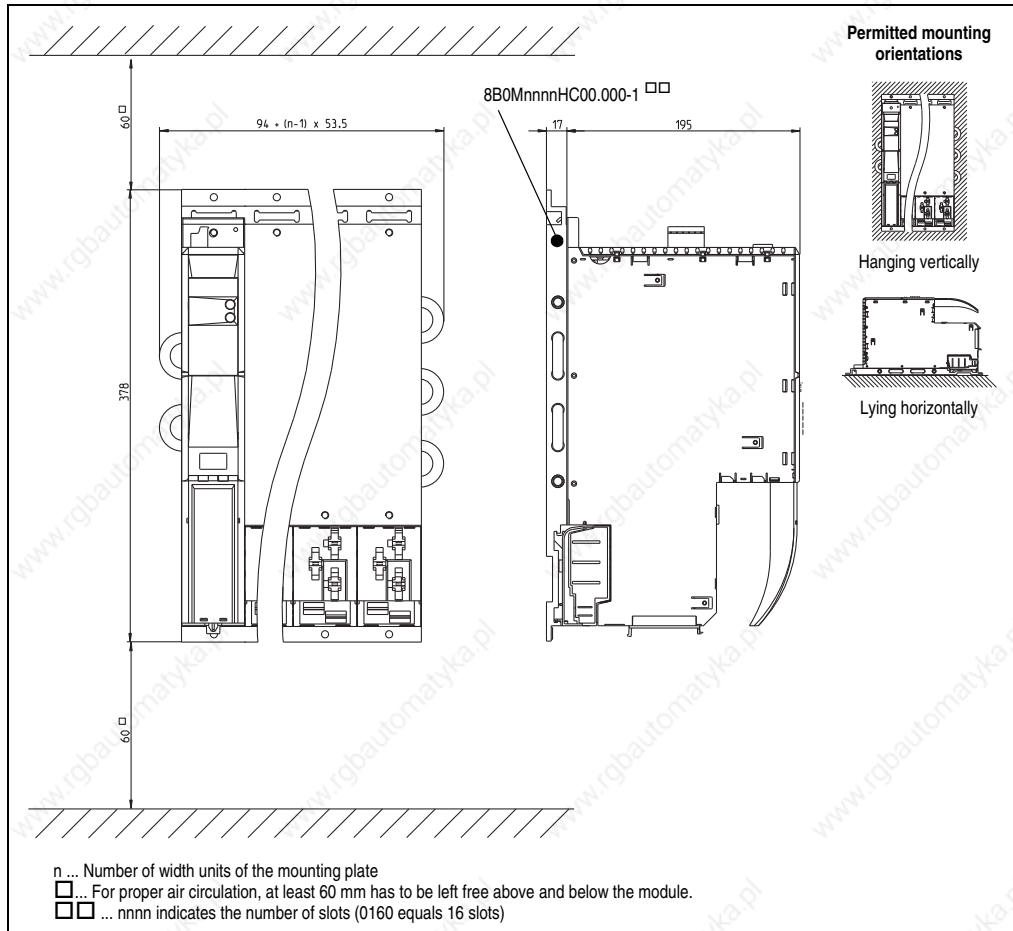


Figure 54: Dimensional diagram and installation dimensions for 8B0C0160HC00.000-1, 8B0C0320HC00.000-1

Information:

When mounting ACOPOSmulti modules for cold-plate or feed-through mounting, be sure not to scratch the backplane. This can impair thermal dissipation to the mounting plate.

Do not set down ACOPOSmulti modules for cold-plate or feed-through mounting on their bottom side. Doing so could break the clips that hold the unit's fan. Broken clips make it more difficult to replace the fans later on.

8B0C0160HC00.001-1, 8B0C0320HC00.002-1, 8B0C0320HC00.00A-1

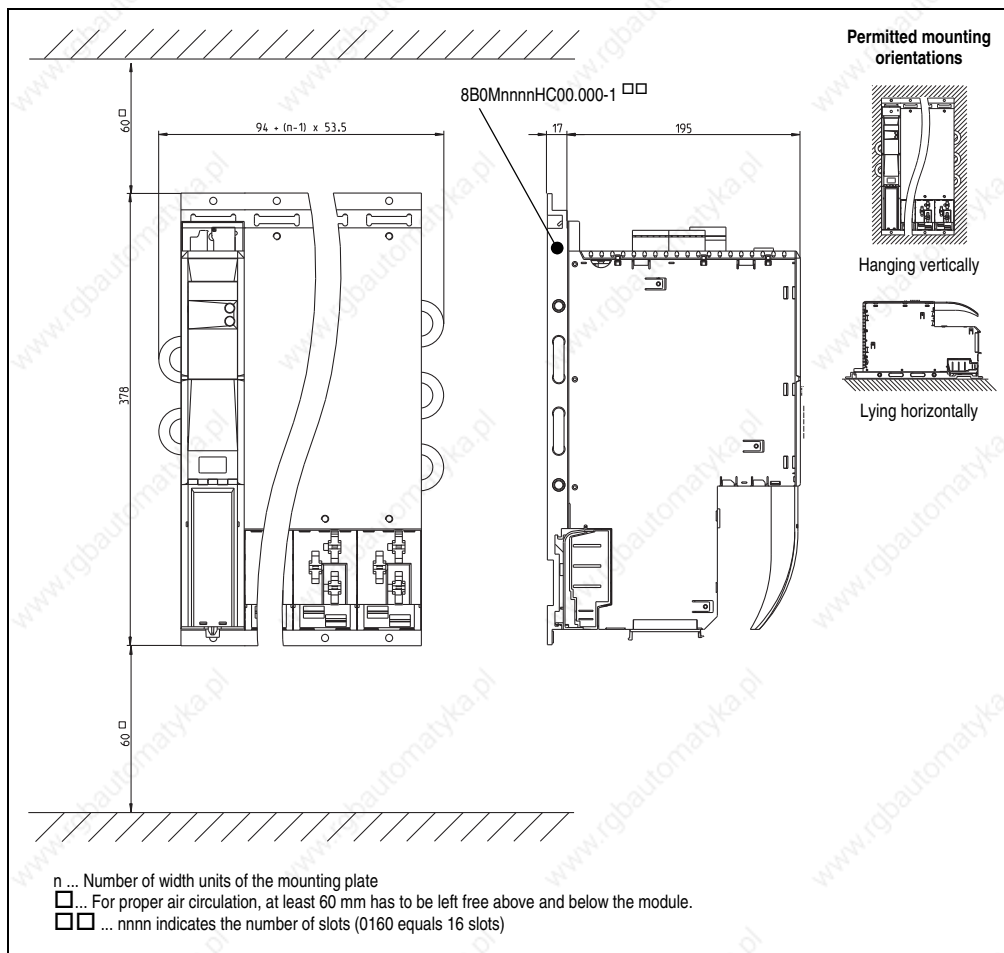


Figure 55: Dimension diagram and installation dimensions for 8B0C0160HC00.001-1, 8B0C0320HC00.002-1, 8B0C0320HC00.00A-1

Information:

When mounting ACOPOSmulti modules for cold-plate or feed-through mounting, be sure not to scratch the backplane. This can impair thermal dissipation to the mounting plate.

Do not set down ACOPOSmulti modules for cold-plate or feed-through mounting on their bottom side. Doing so could break the clips that hold the unit's fan. Broken clips make it more difficult to replace the fans later on.

4.6.6 Single-width inverter modules (single-axis modules)

8BVI0014HCSx.000-1, 8BVI0028HCSx.000-1, 8BVI0055HCSx.000-1, 8BVI0110HCSx.000-1

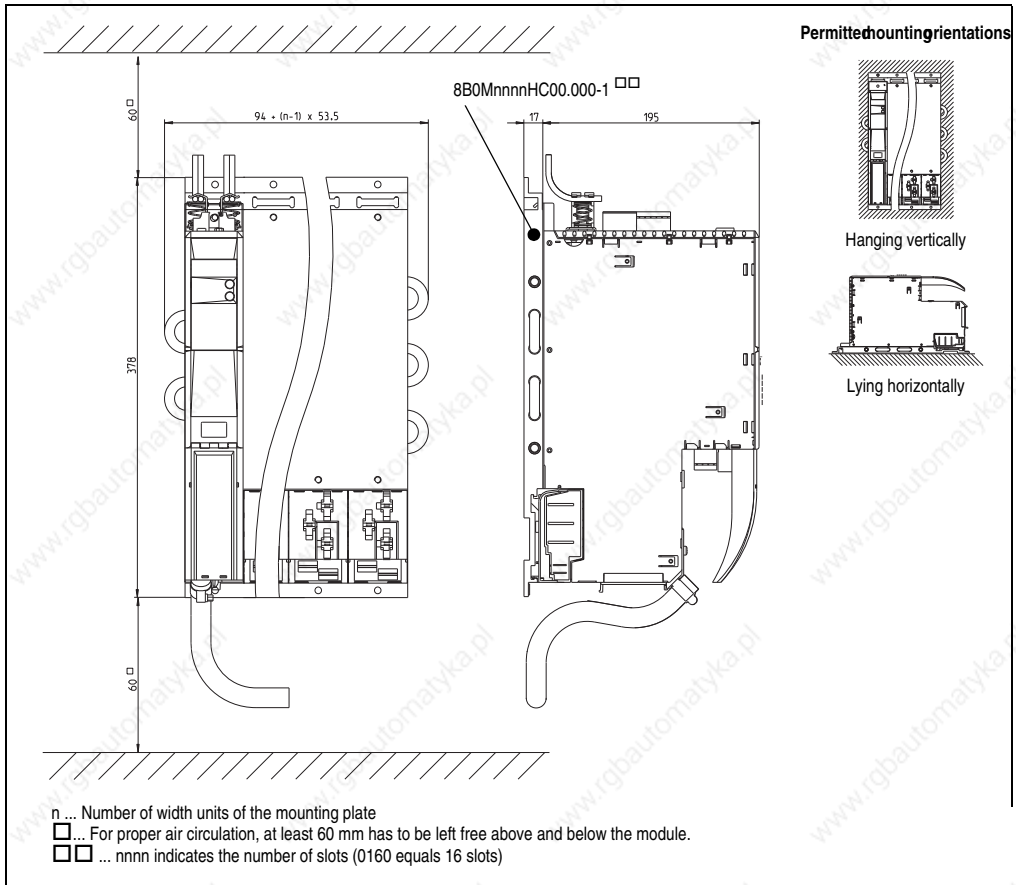


Figure 56: Dimension diagram and installation dimensions for 8BVI0014HCSx.000-1, 8BVI0028HCSx.000-1, 8BVI0055HCSx.000-1, 8BVI0110HCSx.000-1

Information:

When mounting ACOPOSmulti modules for cold-plate or feed-through mounting, be sure not to scratch the backplane. This can impair thermal dissipation to the mounting plate.

Do not set down ACOPOSmulti modules for cold-plate or feed-through mounting on their bottom side. Doing so could break the clips that hold the unit's fan. Broken clips make it more difficult to replace the fans later on.

4.6.7 Single-width inverter modules (two-axis modules)

8BVI0014HCDx.000-1, 8BVI0028HCDx.000-1, 8BVI0055HCDx.000-1

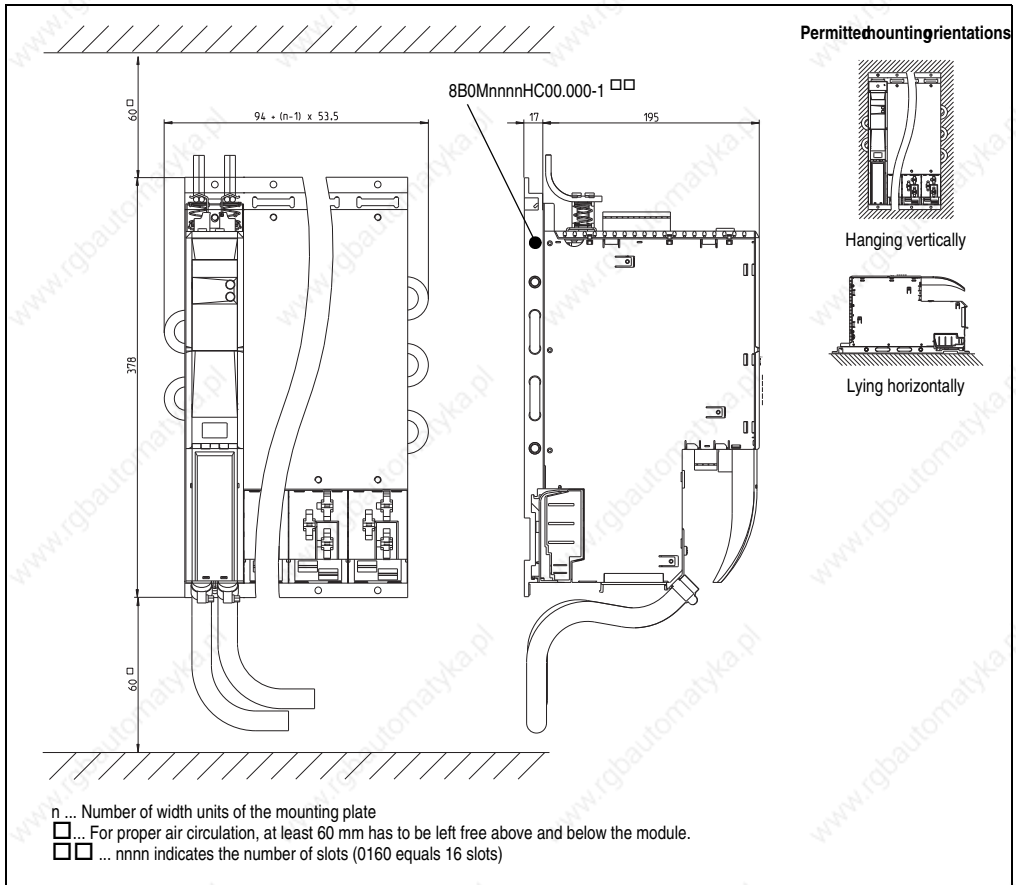


Figure 57: Dimension diagram and installation dimensions for 8BVI0014HCDx.000-1, 8BVI0028HCDx.000-1, 8BVI0055HCDx.000-1

Information:

When mounting ACOPOSmulti modules for cold-plate or feed-through mounting, be sure not to scratch the backplane. This can impair thermal dissipation to the mounting plate.

Do not set down ACOPOSmulti modules for cold-plate or feed-through mounting on their bottom side. Doing so could break the clips that hold the unit's fan. Broken clips make it more difficult to replace the fans later on.

4.6.8 Inverter modules 8BVI0220HCSx.000-1, 8BVI0440HCSx.000-1

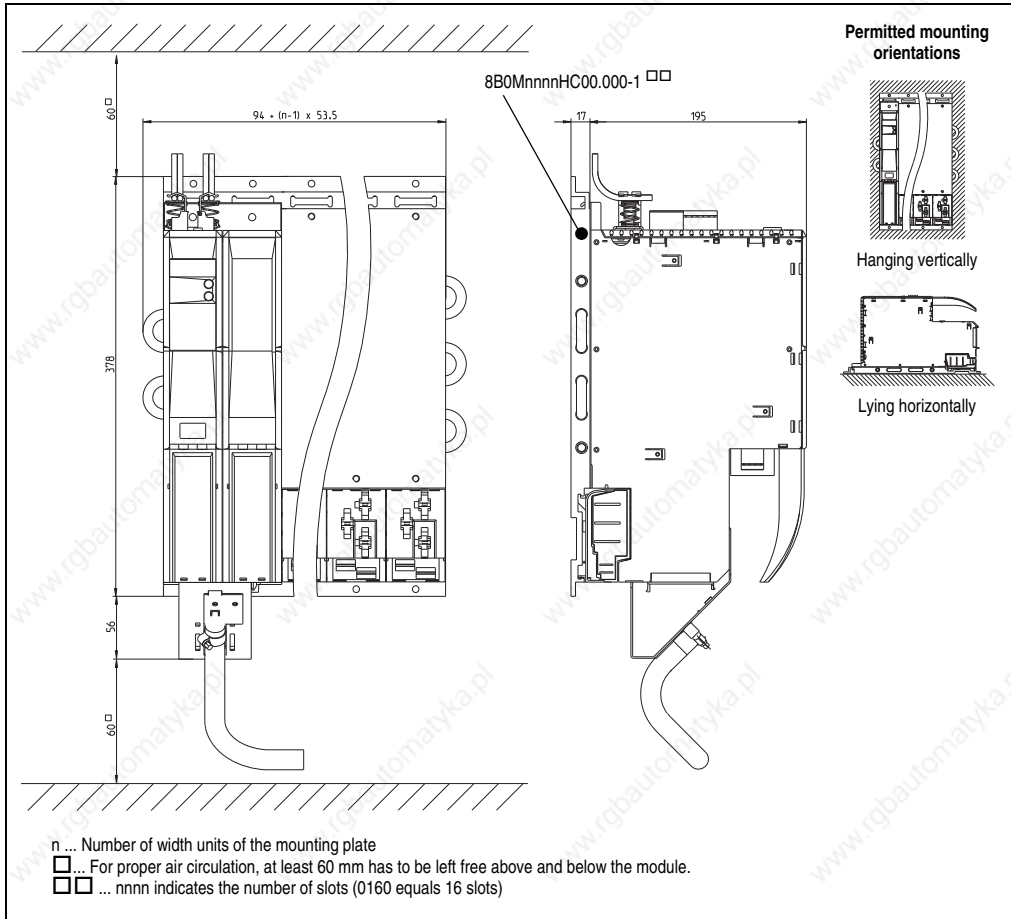


Figure 58: Dimension diagram and installation dimensions for 8BVI0220HCSx.000-1, 8BVI0440HCSx.000-1

Information:

When mounting ACOPOSmulti modules for cold-plate or feed-through mounting, be sure not to scratch the backplane. This can impair thermal dissipation to the mounting plate.

Do not set down ACOPOSmulti modules for cold-plate or feed-through mounting on their bottom side. Doing so could break the clips that hold the unit's fan. Broken clips make it more difficult to replace the fans later on.

4.6.9 Inverter modules 8BVI0110HCDx.000-1, 8BVI0220HCDx.000-1

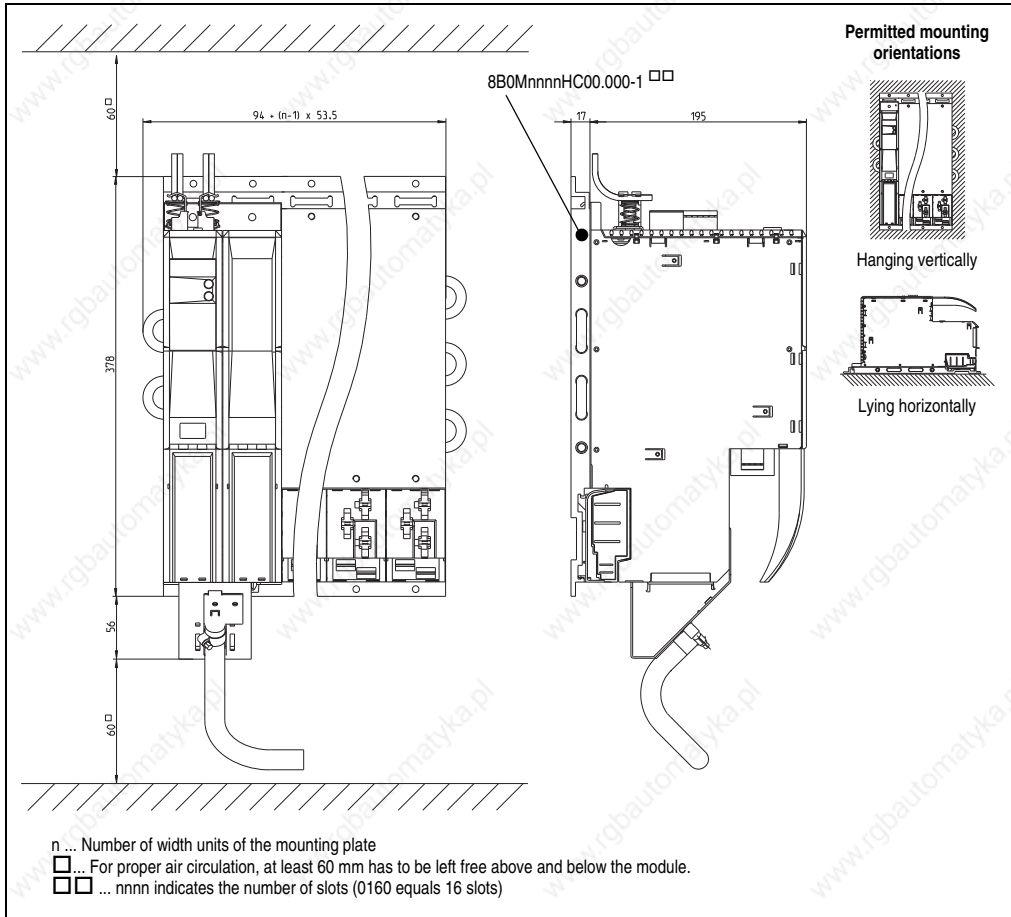


Figure 59: Dimension diagram and installation dimensions for 8BVI0110HCDx.000-1, 8BVI0220HCDx.000-1

Information:

When mounting ACOPOSmulti modules for cold-plate or feed-through mounting, be sure not to scratch the backplane. This can impair thermal dissipation to the mounting plate.

Do not set down ACOPOSmulti modules for cold-plate or feed-through mounting on their bottom side. Doing so could break the clips that hold the unit's fan. Broken clips make it more difficult to replace the fans later on.

4.6.10 Inverter module 8BVI0880HCSx.000-1

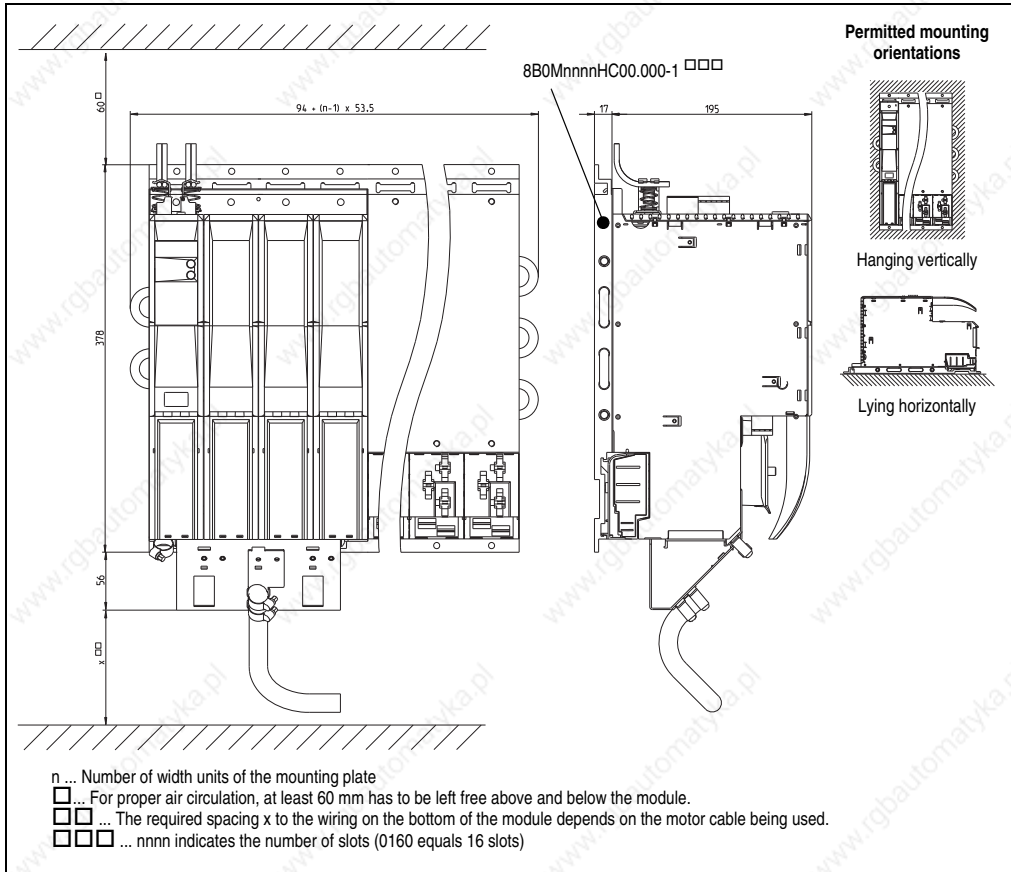


Figure 60: Dimension diagram and installation dimensions for 8BVI0880HCSx.000-1

Information:

When mounting ACOPOSmulti modules for cold-plate or feed-through mounting, be sure not to scratch the backplane. This can impair thermal dissipation to the mounting plate.

Do not set down ACOPOSmulti modules for cold-plate or feed-through mounting on their bottom side. Doing so could break the clips that hold the unit's fan. Broken clips make it more difficult to replace the fans later on.

4.6.11 Inverter module 8BVI1650HCS0.000-1

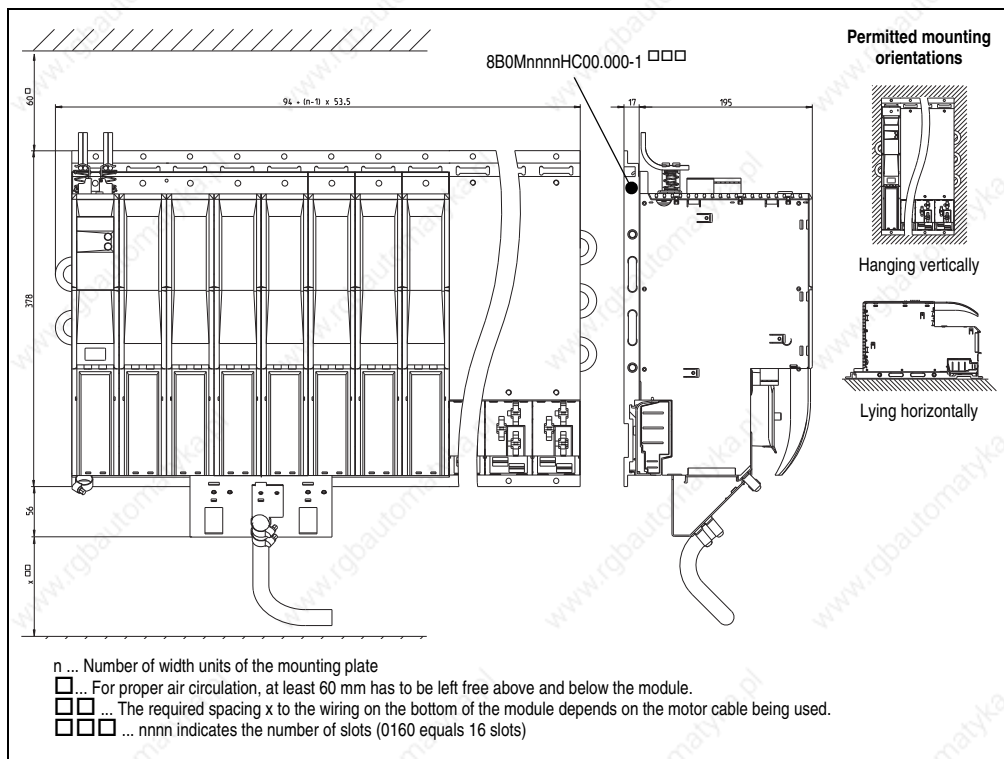


Figure 61: Dimension diagram and installation dimensions for 8BVI1650HCS0.000-1

Information:

When mounting ACOPOSmulti modules for cold-plate or feed-through mounting, be sure not to scratch the backplane. This can impair thermal dissipation to the mounting plate.

Do not set down ACOPOSmulti modules for cold-plate or feed-through mounting on their bottom side. Doing so could break the clips that hold the unit's fan. Broken clips make it more difficult to replace the fans later on.

4.6.12 Expansion module 8BVE0500HC00.000-1

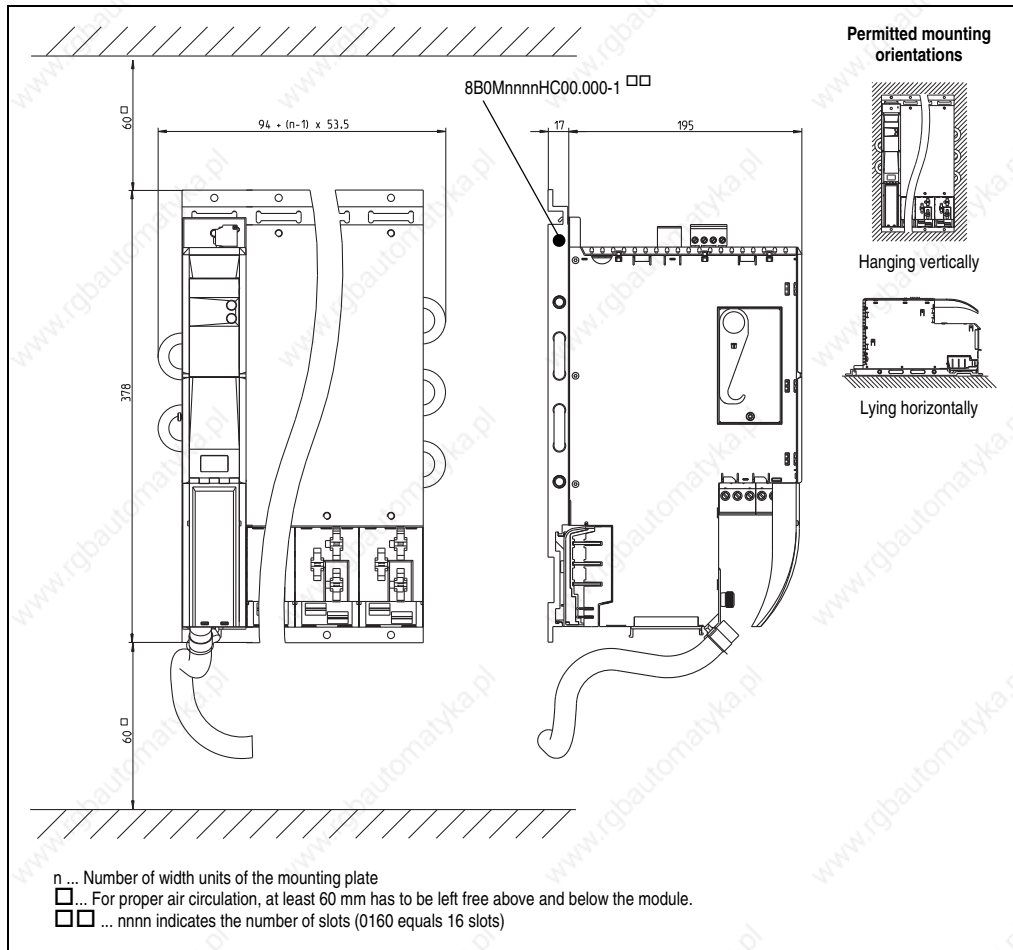


Figure 62: Dimension diagram and installation dimensions for 8BVE0500HC00.000-1

Information:

When mounting ACOPOSmulti modules for cold-plate or feed-through mounting, be sure not to scratch the backplane. This can impair thermal dissipation to the mounting plate.

Do not set down ACOPOSmulti modules for cold-plate or feed-through mounting on their bottom side. Doing so could break the clips that hold the unit's fan. Broken clips make it more difficult to replace the fans later on.

4.6.13 Capacitor module 8B0K1650HC00.000-1

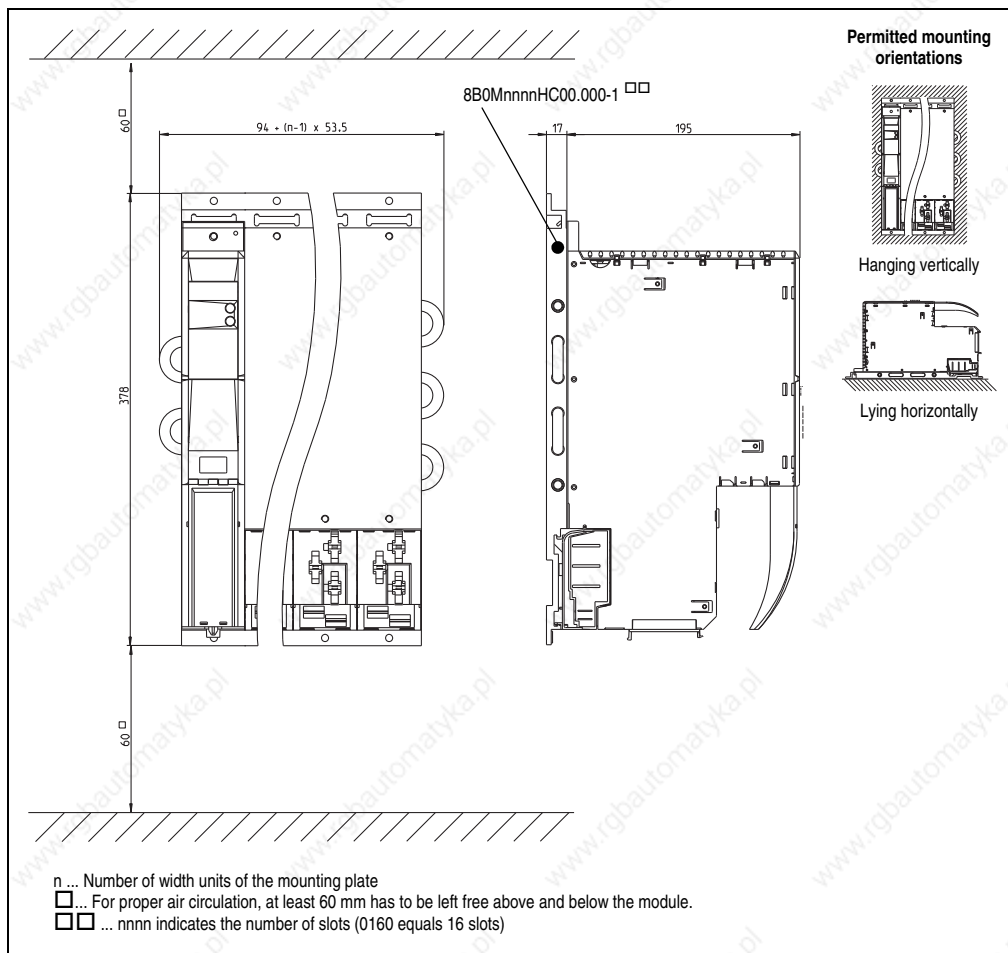


Figure 63: Dimension diagram and installation dimensions for 8B0K1650HC00.000-1

Information:

When mounting ACOPOSmulti modules for cold-plate or feed-through mounting, be sure not to scratch the backplane. This can impair thermal dissipation to the mounting plate.

Do not set down ACOPOSmulti modules for cold-plate or feed-through mounting on their bottom side. Doing so could break the clips that hold the unit's fan. Broken clips make it more difficult to replace the fans later on.

4.7 Feed-through mounting

4.7.1 Mounting plate 8B0MnnnnHF00.000-1¹⁾

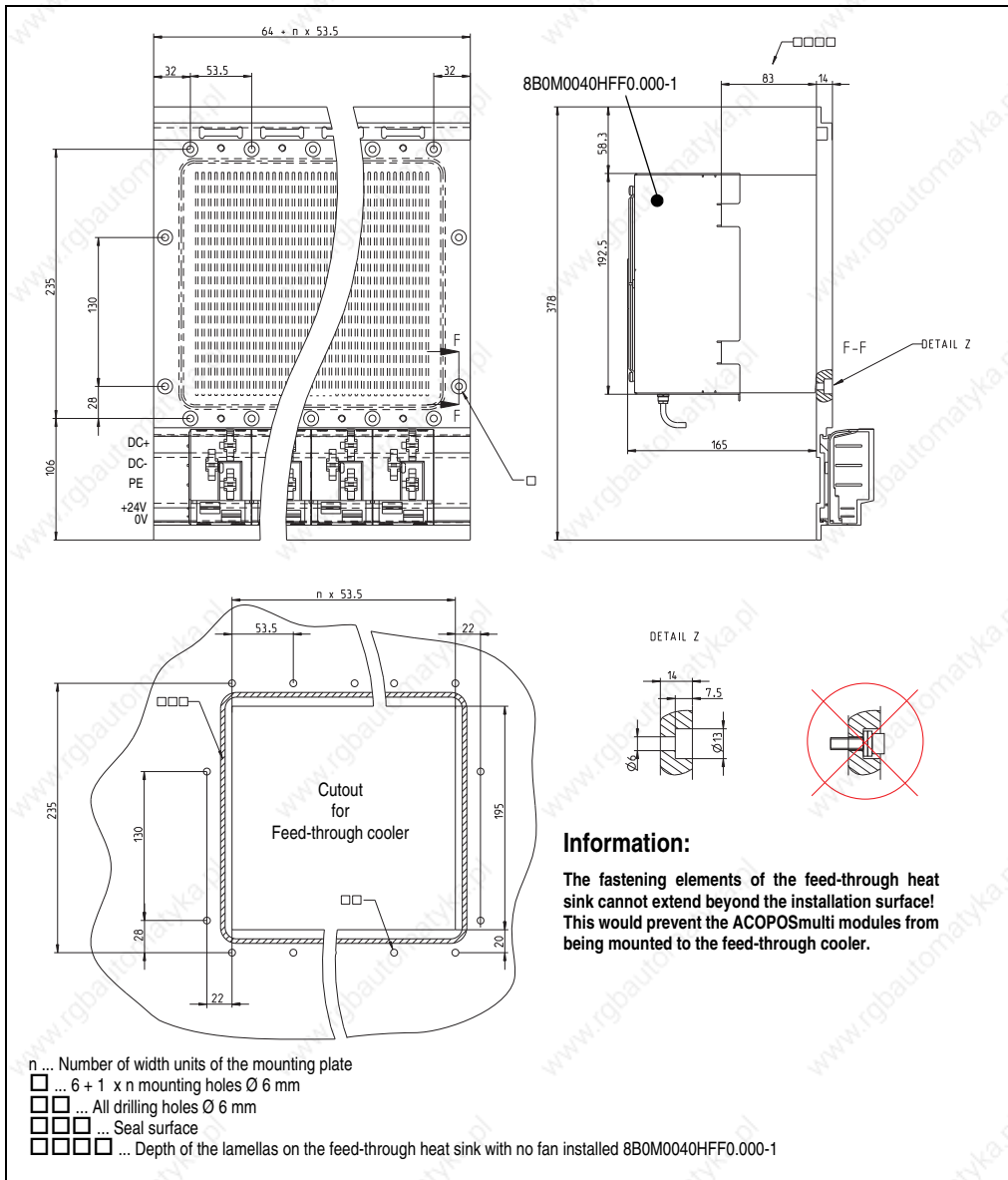


Figure 64: Dimension diagram and installation dimensions for 8B0MnnnnHF00.000-1

1) nnnn indicates the number of slots (0160 equals 16 slots).

4.7.2 Power supply module 8BxP0220HC00.000-1, 8BxP0440HC00.000-1

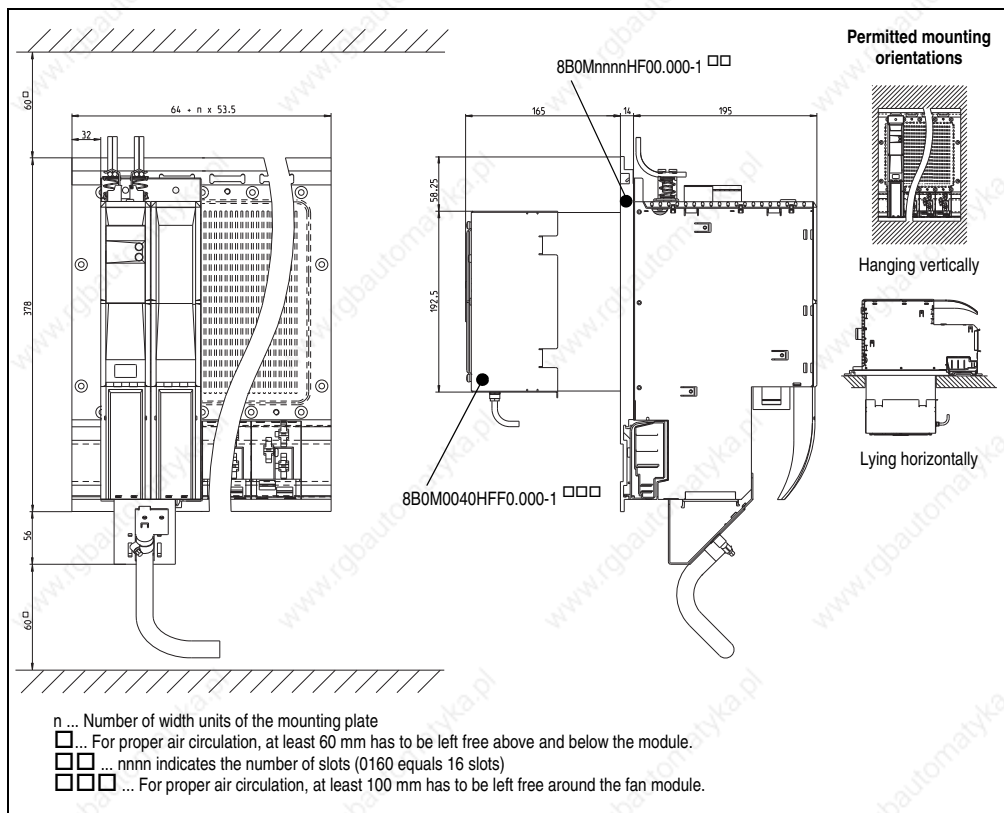


Figure 65: Dimension diagram and installation dimensions for 8BxP0220HC00.000-1, 8BxP0440HC00.000-1

Information:

When mounting ACOPOSmulti modules for cold-plate or feed-through mounting, be sure not to scratch the backplane. This can impair thermal dissipation to the mounting plate.

Do not set down ACOPOSmulti modules for cold-plate or feed-through mounting on their bottom side. Doing so could break the clips that hold the unit's fan. Broken clips make it more difficult to replace the fans later on.

4.7.3 Power supply module 8BVP0880HC00.000-1

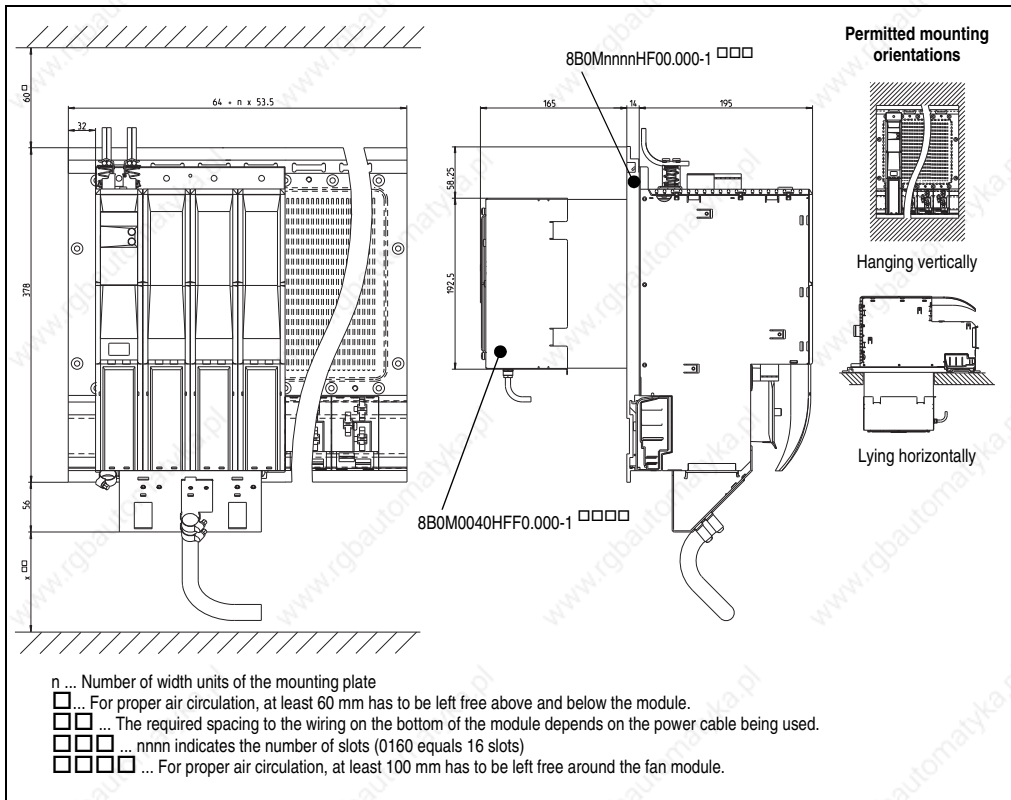


Figure 66: Dimension diagram and installation dimensions for 8BVP0880HC00.000-1

Information:

When mounting ACOPOSmulti modules for cold-plate or feed-through mounting, be sure not to scratch the backplane. This can impair thermal dissipation to the mounting plate.

Do not set down ACOPOSmulti modules for cold-plate or feed-through mounting on their bottom side. Doing so could break the clips that hold the unit's fan. Broken clips make it more difficult to replace the fans later on.

4.7.4 Power supply module 8BVP1650HC00.000-1

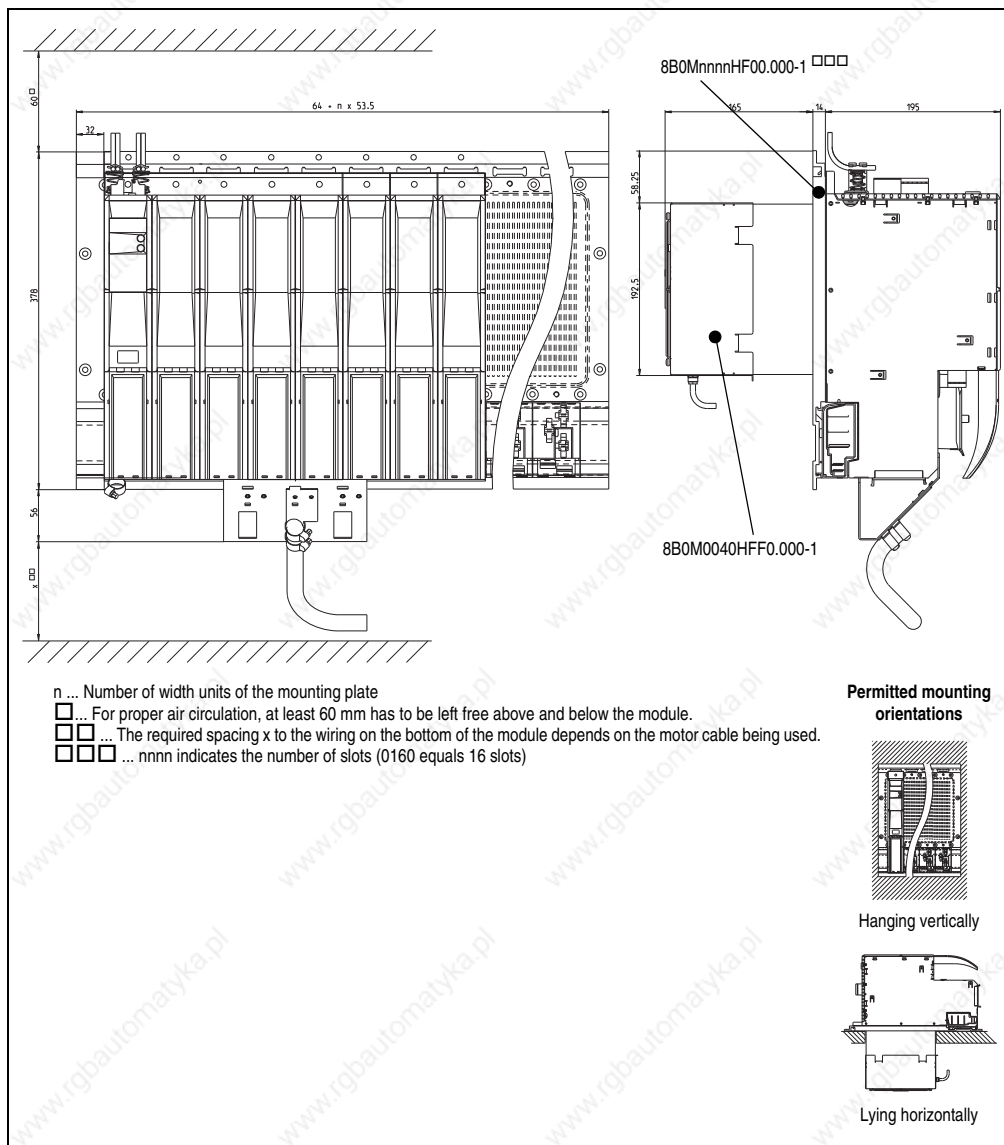


Figure 67: Dimension diagram and installation dimensions for 8BVP1650HC00.000-1

Information:

When mounting ACOPOSmulti modules for cold-plate or feed-through mounting, be sure not to scratch the backplane. This can impair thermal dissipation to the mounting plate.

Do not set down ACOPOSmulti modules for cold-plate or feed-through mounting on their bottom side. Doing so could break the clips that hold the unit's fan. Broken clips make it more difficult to replace the fans later on.

4.7.5 Control supply units

8B0C0160HC00.000-1, 8B0C0320HC00.000-1

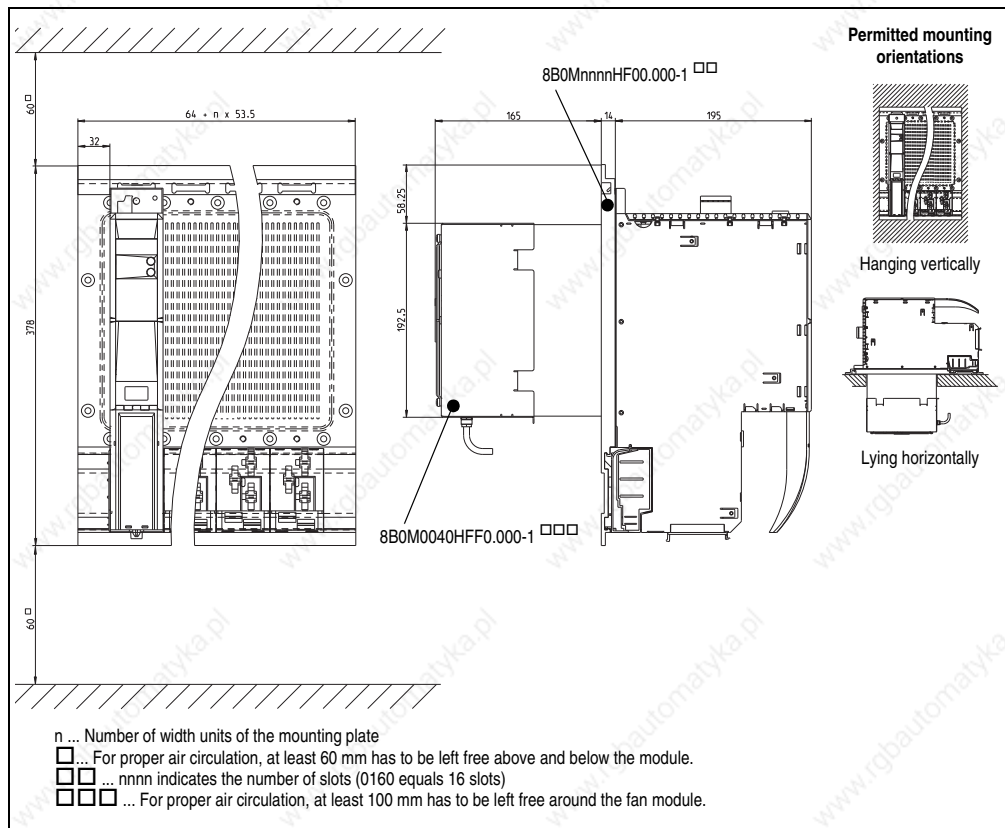


Figure 68: Dimensional diagram and installation dimensions for 8B0C0160HC00.000-1, 8B0C0320HC00.000-1

Information:

When mounting ACOPOSmulti modules for cold-plate or feed-through mounting, be sure not to scratch the backplane. This can impair thermal dissipation to the mounting plate.

Do not set down ACOPOSmulti modules for cold-plate or feed-through mounting on their bottom side. Doing so could break the clips that hold the unit's fan. Broken clips make it more difficult to replace the fans later on.

8B0C0160HC00.001-1, 8B0C0320HC00.002-1, 8B0C0320HC00.00A-1

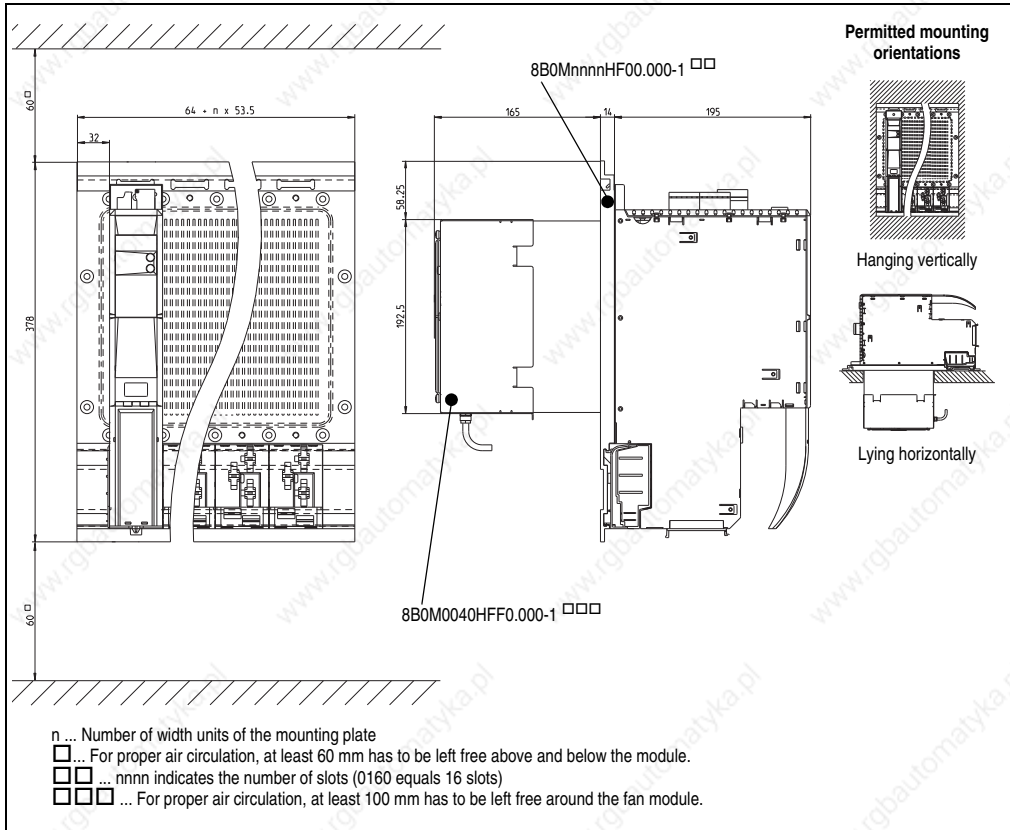


Figure 69: Dimension diagram and installation dimensions for 8B0C0160HC00.001-1, 8B0C0320HC00.002-1, 8B0C0320HC00.00A-1

Information:

When mounting ACOPOSmulti modules for cold-plate or feed-through mounting, be sure not to scratch the backplane. This can impair thermal dissipation to the mounting plate.

Do not set down ACOPOSmulti modules for cold-plate or feed-through mounting on their bottom side. Doing so could break the clips that hold the unit's fan. Broken clips make it more difficult to replace the fans later on.

4.7.6 Single-width inverter modules (single-axis modules)

8BVI0014HCSx.000-1, 8BVI0028HCSx.000-1, 8BVI0055HCSx.000-1, 8BVI0110HCSx.000-1

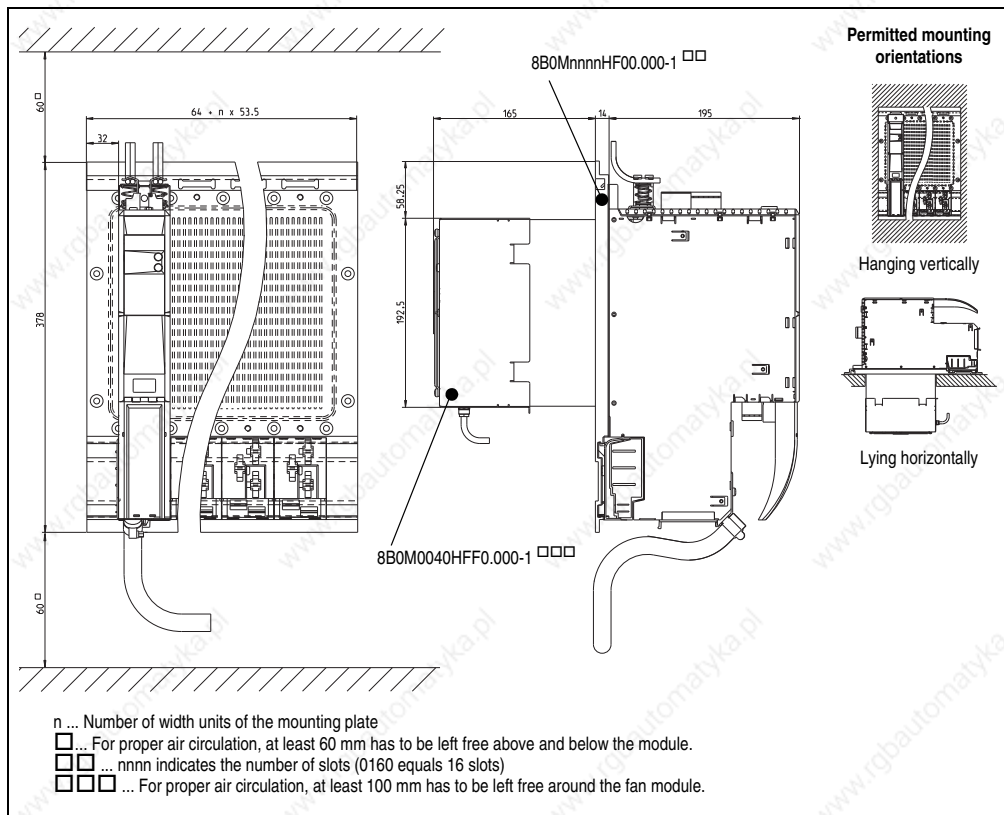


Figure 70: Dimension diagram and installation dimensions for 8BVI0014HCSx.000-1, 8BVI0028HCSx.000-1, 8BVI0055HCSx.000-1, 8BVI0110HCSx.000-1

Information:

When mounting ACOPOSmulti modules for cold-plate or feed-through mounting, be sure not to scratch the backplane. This can impair thermal dissipation to the mounting plate.

Do not set down ACOPOSmulti modules for cold-plate or feed-through mounting on their bottom side. Doing so could break the clips that hold the unit's fan. Broken clips make it more difficult to replace the fans later on.

4.7.7 Single-width inverter modules (two-axis modules)

8BVI0014HCDx.000-1, 8BVI0028HCDx.000-1, 8BVI0055HCDx.000-1

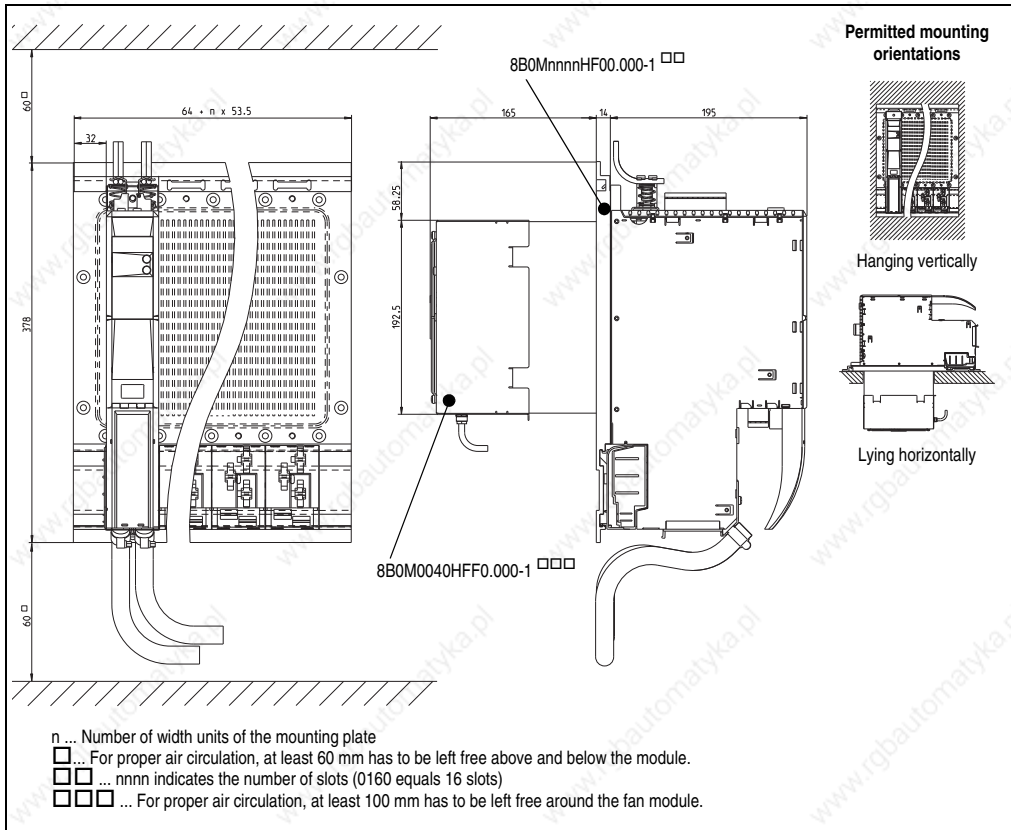


Figure 71: Dimension diagram and installation dimensions for 8BVI0014HCDx.000-1, 8BVI0028HCDx.000-1, 8BVI0055HCDx.000-1

Information:

When mounting ACOPOSmulti modules for cold-plate or feed-through mounting, be sure not to scratch the backplane. This can impair thermal dissipation to the mounting plate.

Do not set down ACOPOSmulti modules for cold-plate or feed-through mounting on their bottom side. Doing so could break the clips that hold the unit's fan. Broken clips make it more difficult to replace the fans later on.

4.7.8 Inverter modules 8BVI0220HCSx.000-1, 8BVI0440HCSx.000-1

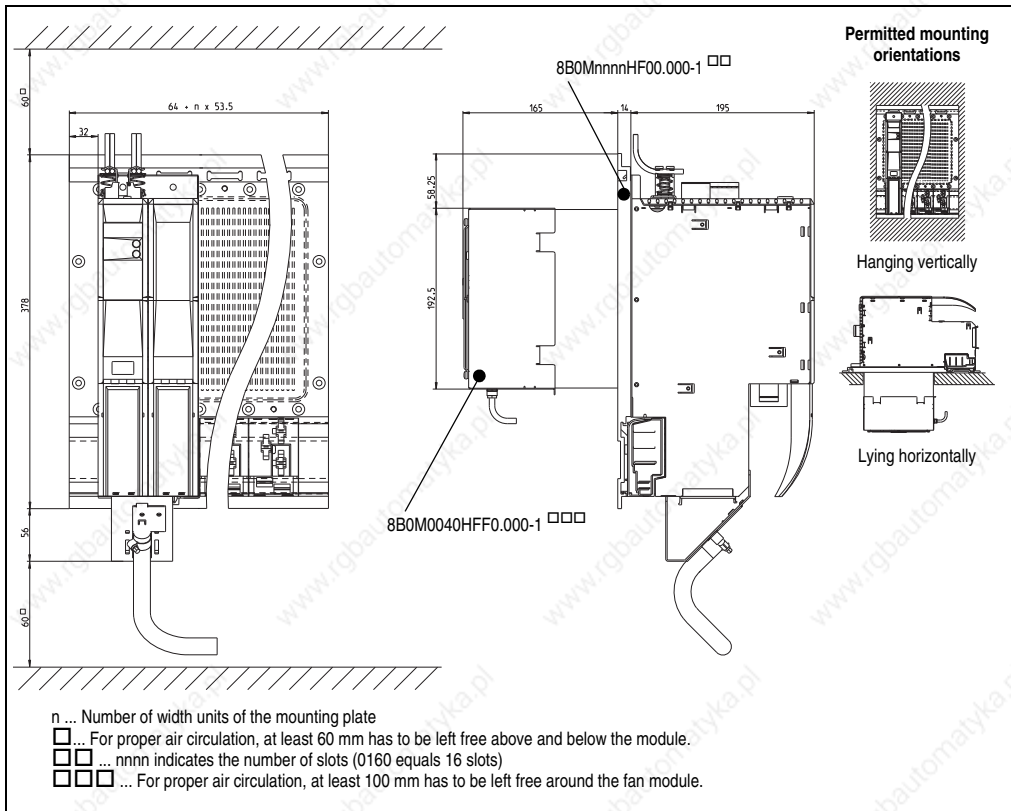


Figure 72: Dimension diagram and installation dimensions for 8BVI0220HCSx.000-1, 8BVI0440HCSx.000-1

Information:

When mounting ACOPOSmulti modules for cold-plate or feed-through mounting, be sure not to scratch the backplane. This can impair thermal dissipation to the mounting plate.

Do not set down ACOPOSmulti modules for cold-plate or feed-through mounting on their bottom side. Doing so could break the clips that hold the unit's fan. Broken clips make it more difficult to replace the fans later on.

4.7.9 Inverter modules 8BVI0110HCDx.000-1, 8BVI0220HCDx.000-1

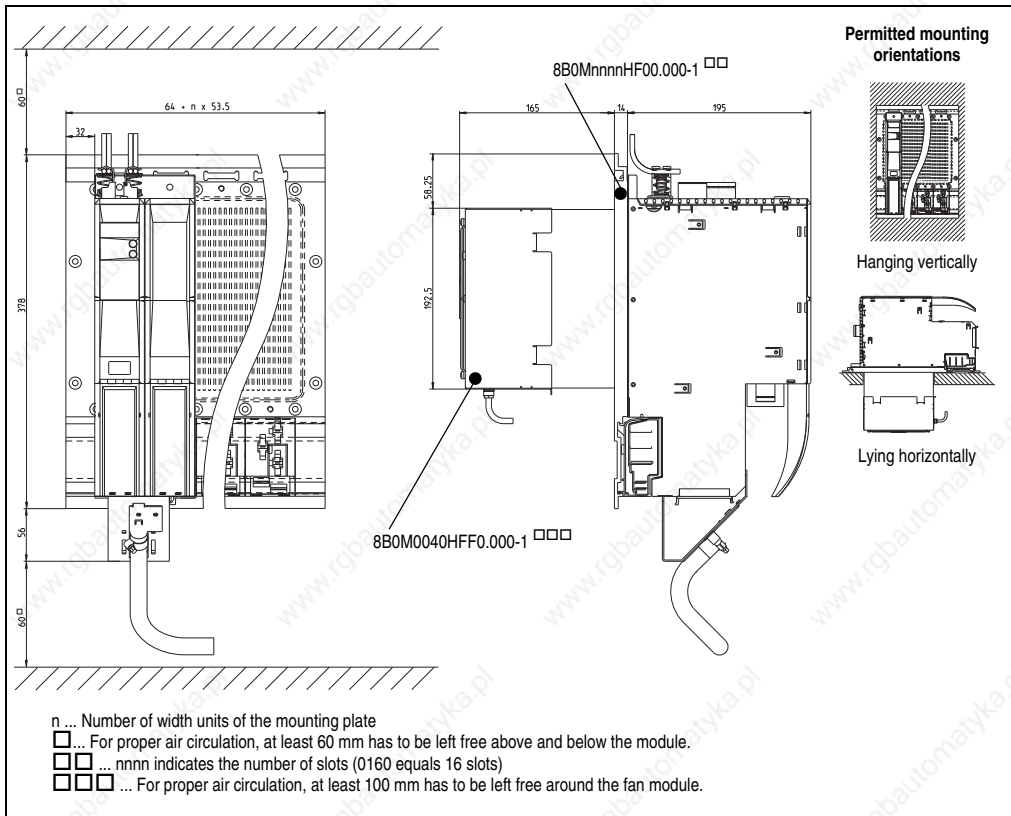


Figure 73: Dimension diagram and installation dimensions for 8BVI0110HCDx.000-1, 8BVI0220HCDx.000-1

Information:

When mounting ACOPOSmulti modules for cold-plate or feed-through mounting, be sure not to scratch the backplane. This can impair thermal dissipation to the mounting plate.

Do not set down ACOPOSmulti modules for cold-plate or feed-through mounting on their bottom side. Doing so could break the clips that hold the unit's fan. Broken clips make it more difficult to replace the fans later on.

4.7.10 Inverter module 8BVI0880HCSx.000-1

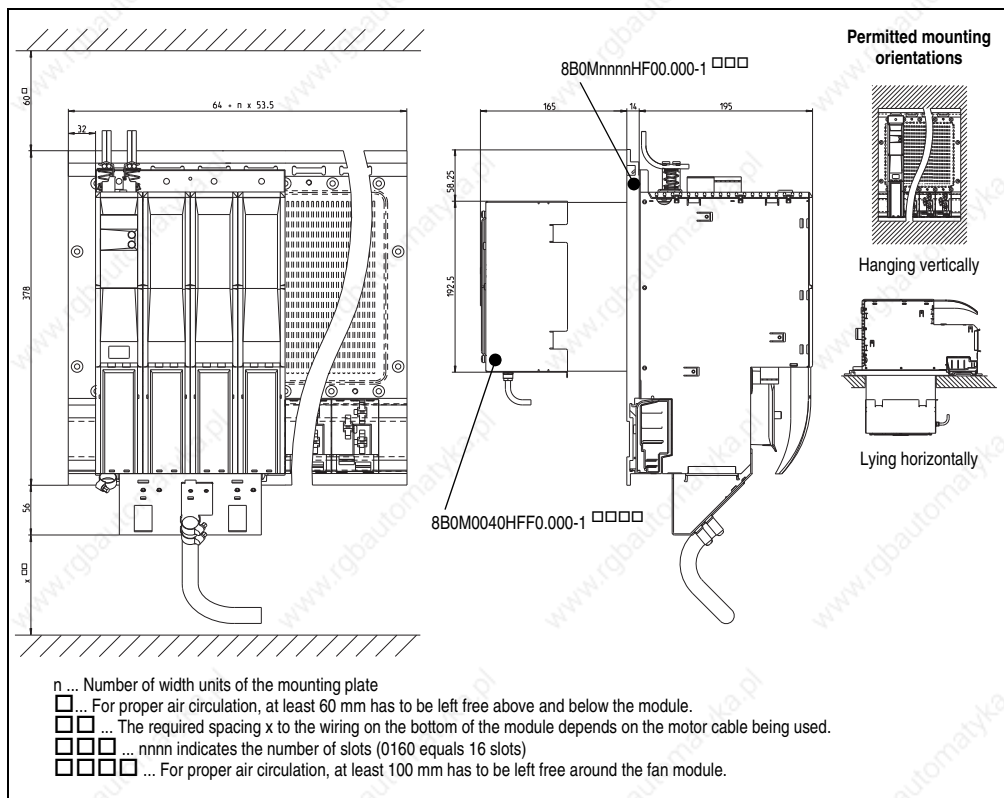


Figure 74: Dimension diagram and installation dimensions for 8BVI0880HCSx.000-1

Information:

When mounting ACOPOSmulti modules for cold-plate or feed-through mounting, be sure not to scratch the backplane. This can impair thermal dissipation to the mounting plate.

Do not set down ACOPOSmulti modules for cold-plate or feed-through mounting on their bottom side. Doing so could break the clips that hold the unit's fan. Broken clips make it more difficult to replace the fans later on.

4.7.11 Inverter module 8BVI1650HCS0.000-1

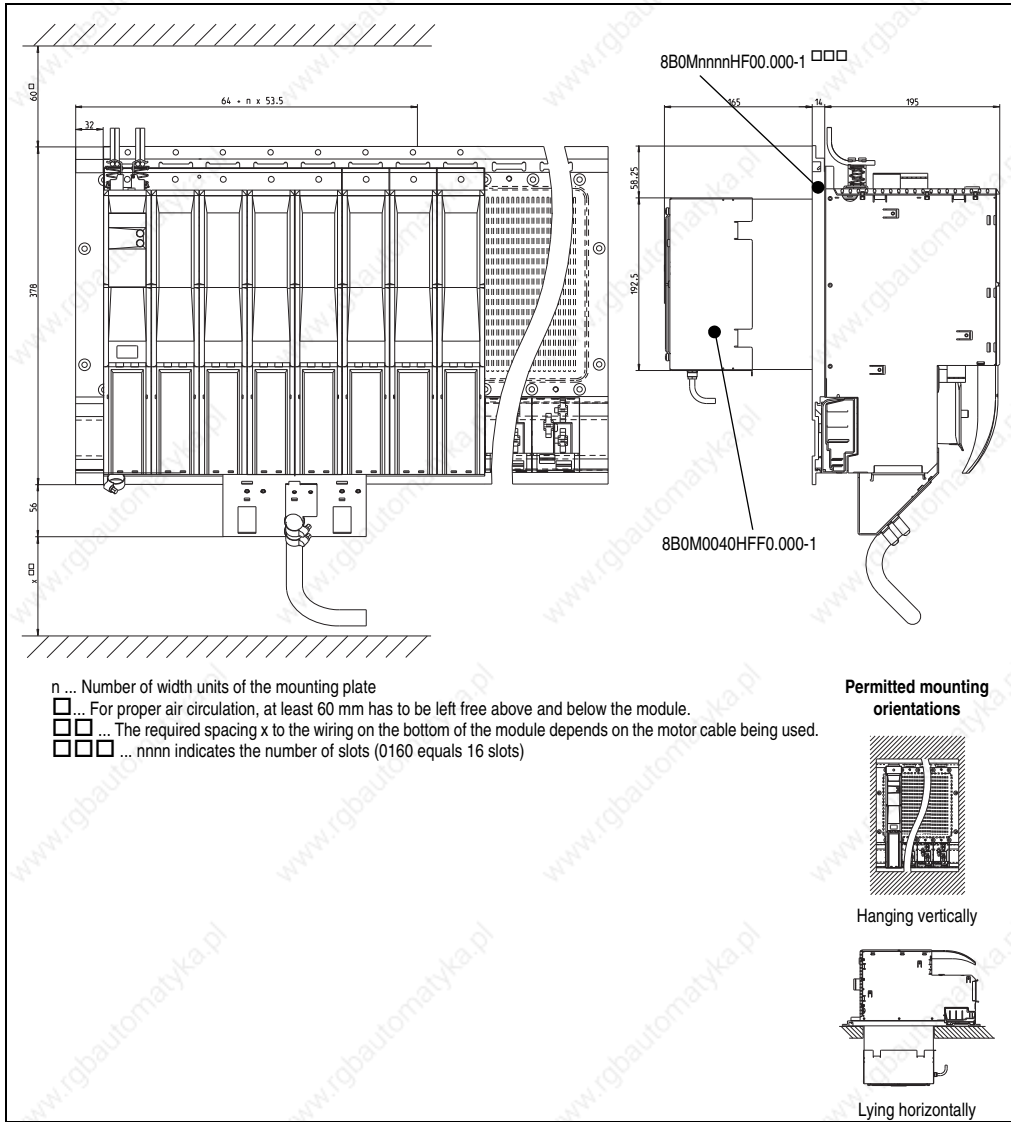


Figure 75: Dimension diagram and installation dimensions for 8BVI1650HCS0.000-1

Information:

When mounting ACOPOSmulti modules for cold-plate or feed-through mounting, be sure not to scratch the backplane. This can impair thermal dissipation to the mounting plate.

Do not set down ACOPOSmulti modules for cold-plate or feed-through mounting on their bottom side. Doing so could break the clips that hold the unit's fan. Broken clips make it more difficult to replace the fans later on.

4.7.12 Expansion module 8BVE0500HC00.000-1

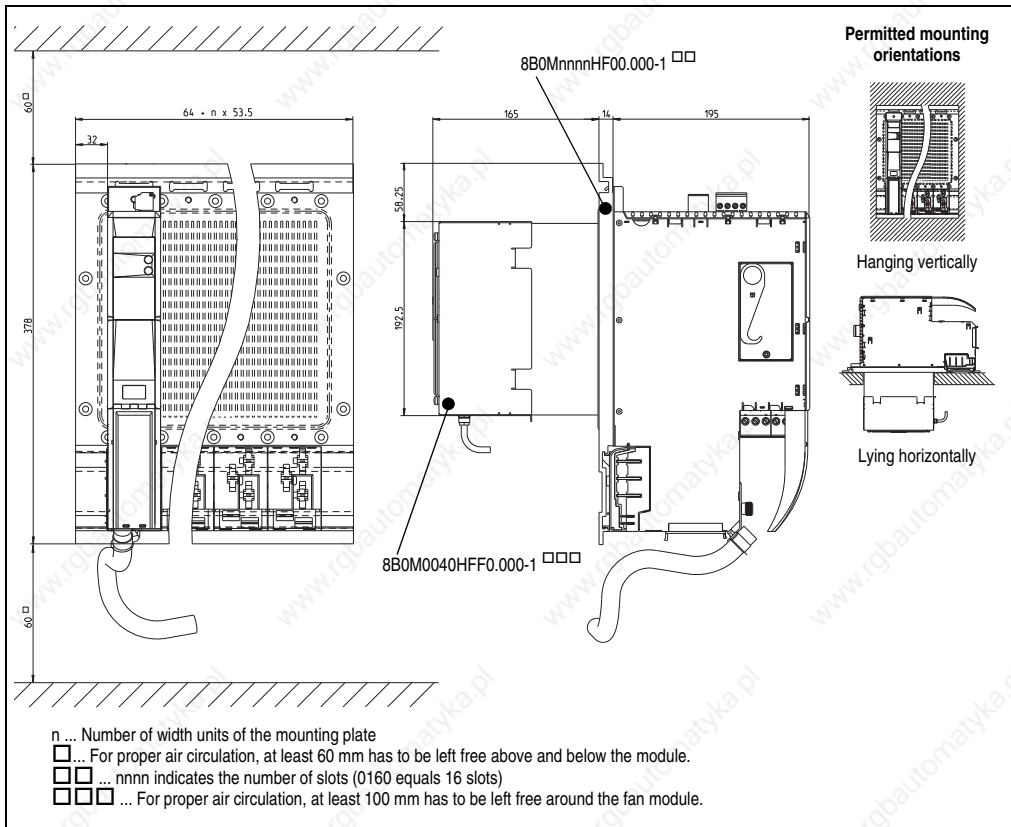


Figure 76: Dimension diagram and installation dimensions for 8BVE0500HC00.000-1

Information:

When mounting ACOPOSmulti modules for cold-plate or feed-through mounting, be sure not to scratch the backplane. This can impair thermal dissipation to the mounting plate.

Do not set down ACOPOSmulti modules for cold-plate or feed-through mounting on their bottom side. Doing so could break the clips that hold the unit's fan. Broken clips make it more difficult to replace the fans later on.

4.7.13 Capacitor module 8B0K1650HC00.000-1

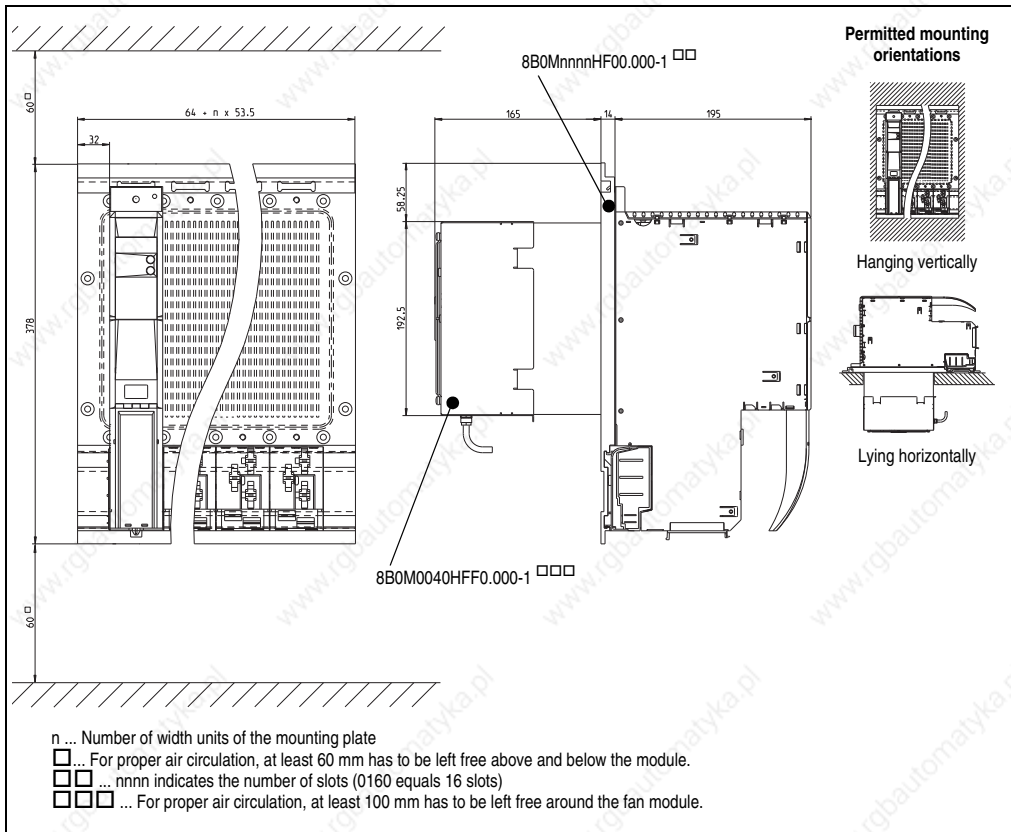


Figure 77: Dimension diagram and installation dimensions for 8B0K1650HC00.000-1

Information:

When mounting ACOPOSmulti modules for cold-plate or feed-through mounting, be sure not to scratch the backplane. This can impair thermal dissipation to the mounting plate.

Do not set down ACOPOSmulti modules for cold-plate or feed-through mounting on their bottom side. Doing so could break the clips that hold the unit's fan. Broken clips make it more difficult to replace the fans later on.

4.8 External braking resistors

4.8.1 8B0W0045H000.001-1, 8B0W0079H000.001-1

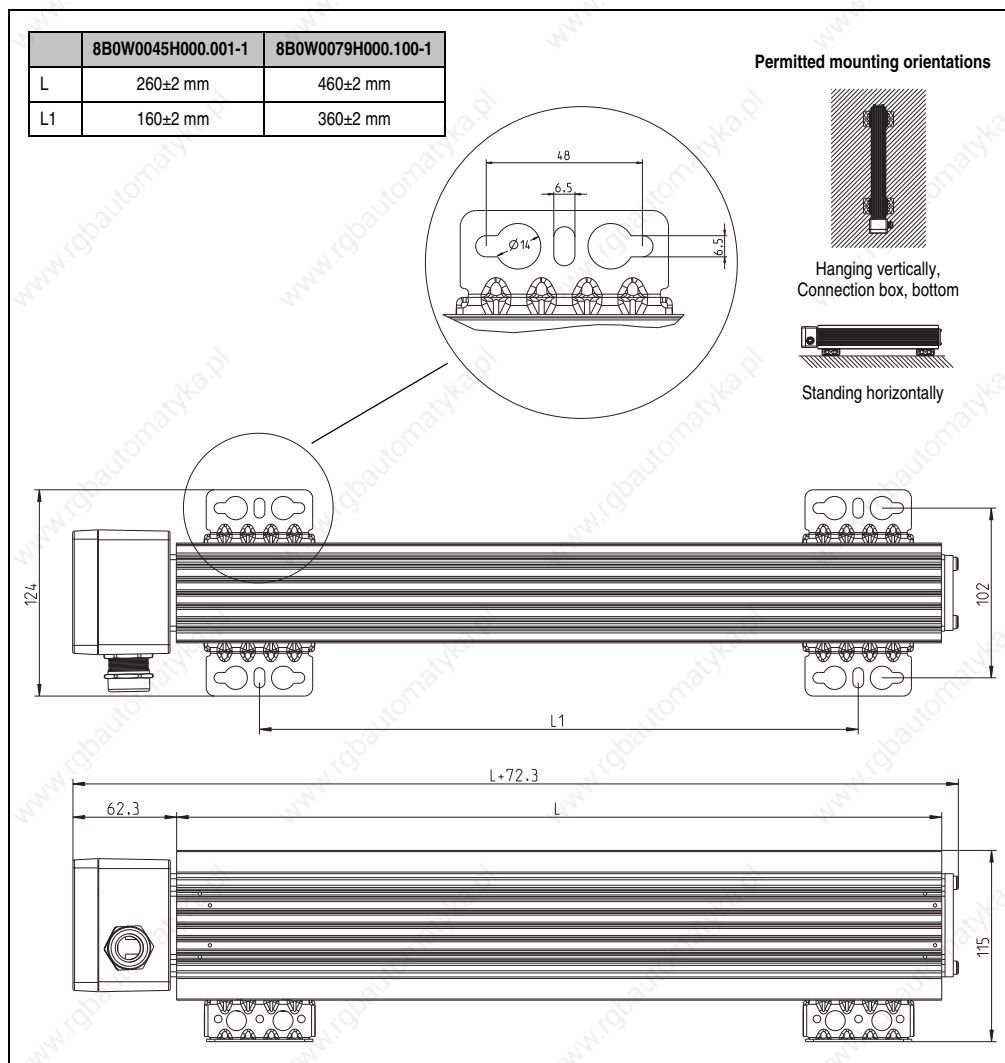


Figure 78: Dimension diagram for 8B0W0045H000.001-1, 8B0W0079H000.001-1

Warning!

8B0W external braking resistors can reach extremely high surface temperatures during operation and after shutting off!

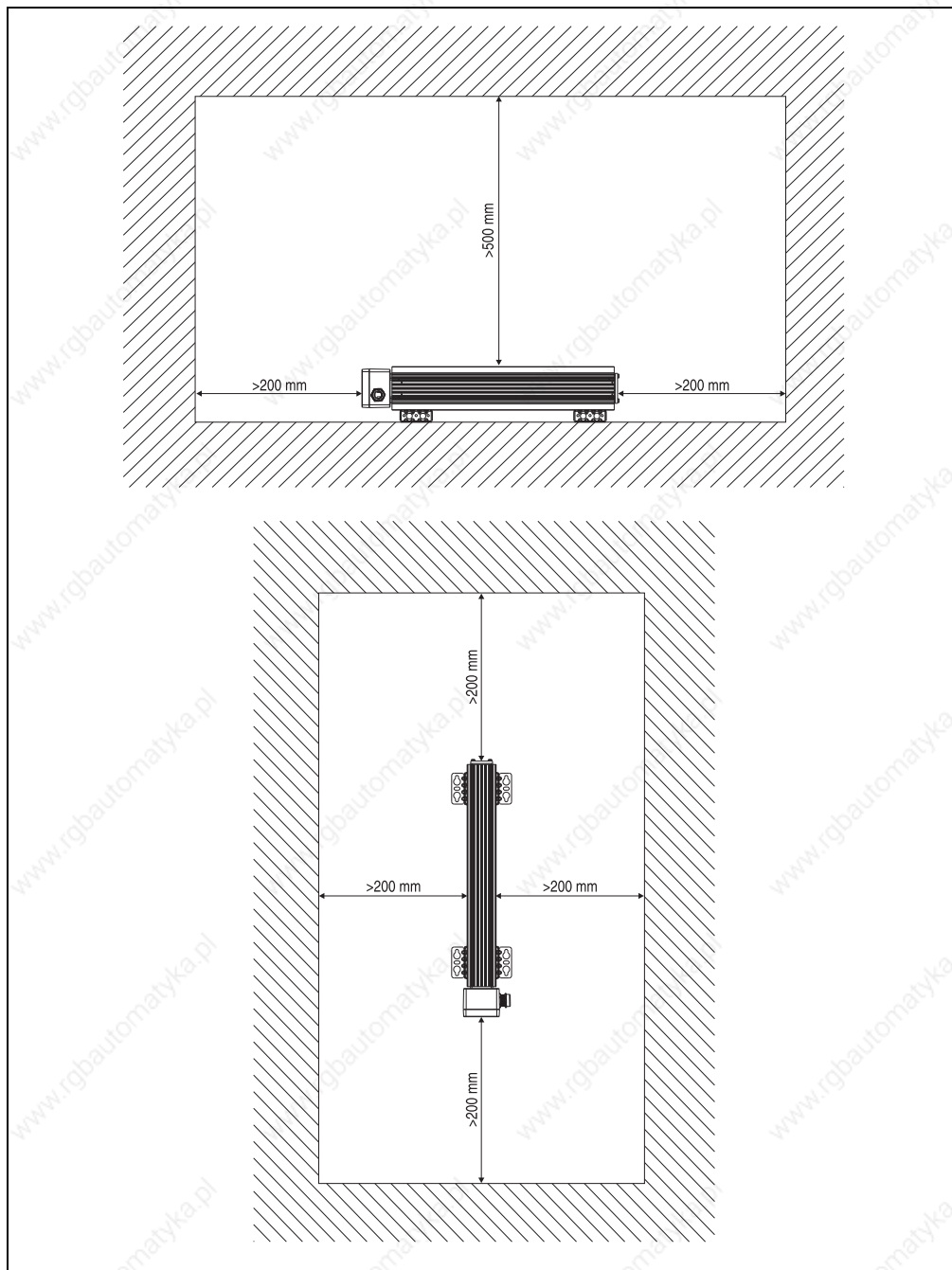


Figure 79: Installation dimensions - 8B0W external braking resistors

4.9 Fan module 8B0M0040HFF0.000-1

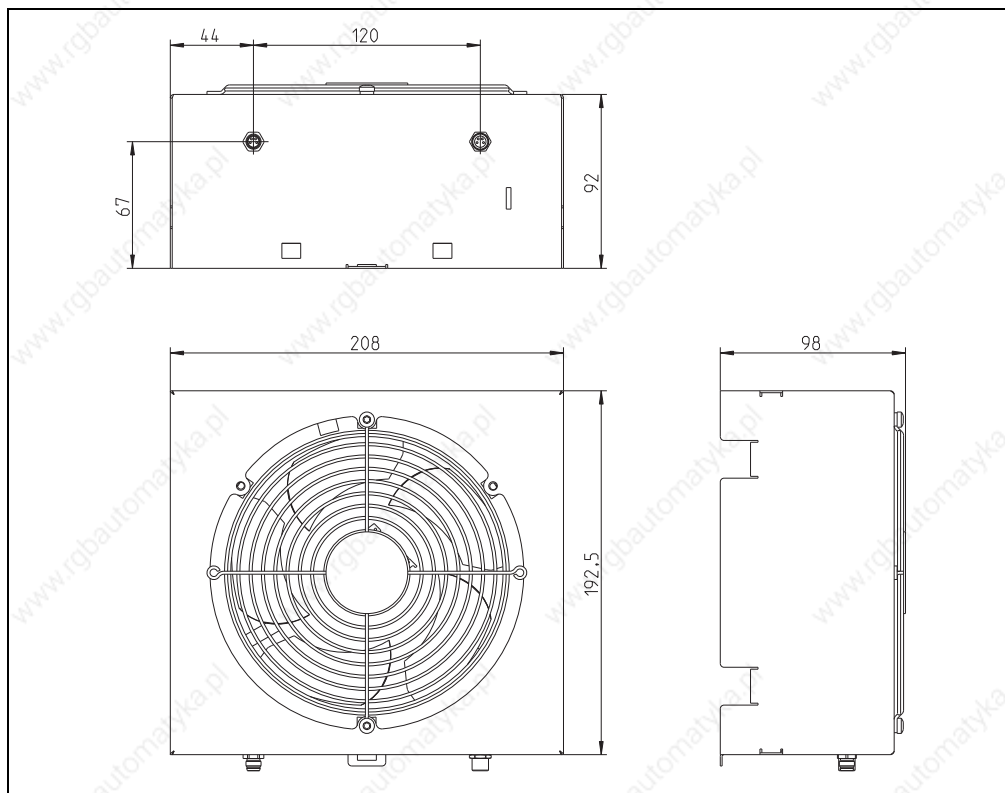


Figure 80: Dimension diagram and installation dimensions for 8B0M0040HFF0.000-1

5. Using cooling systems in switching cabinets

Cooling systems are sometimes required for maintaining the permissible ambient temperature levels of ACOPOSmulti drives systems in switching cabinets.

For details about dimensioning cooling systems, see the section "Dimensioning cooling systems for cooling switching cabinets", on page 364.

5.1 Natural convection

Warning!

Make sure that only well-sealed switching cabinets are used because otherwise contaminated ambient air could permeate the switching cabinet.

5.2 Using filter fans

The filter fans and outlet filters should be arranged on the switching cabinet in such a way that the air is taken in from below and exits above.

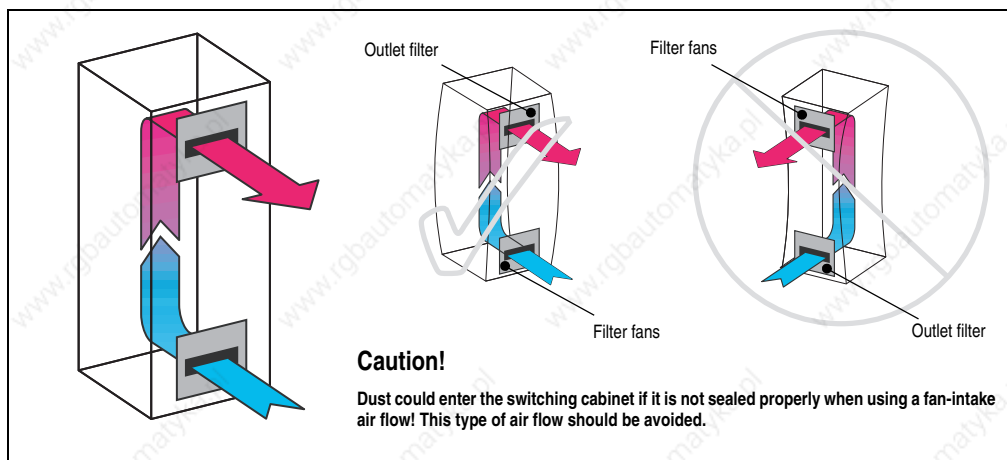


Figure 81: Function diagram of filter fans

Warning!

Make sure that only well-sealed switching cabinets are used because otherwise contaminated ambient air could permeate the switching cabinet.

5.3 Using air/air heat exchangers

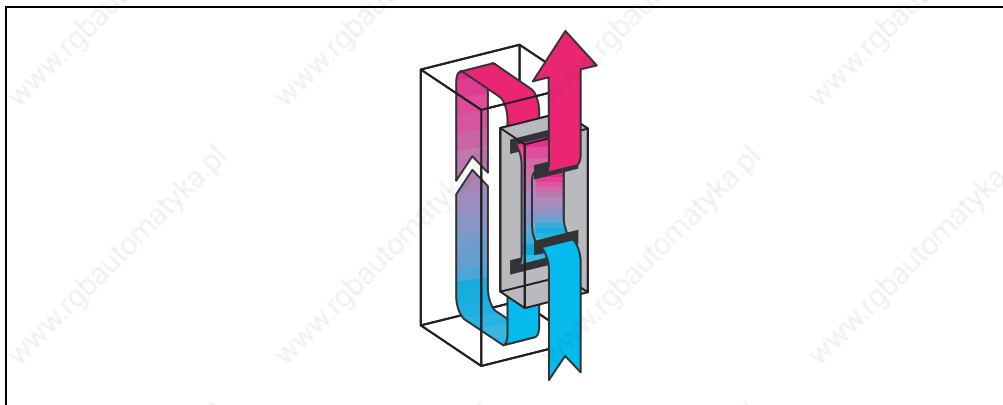


Figure 82: Function diagram of air/air heat exchangers

Caution!

An even circulation of air must be ensured in the switching cabinet. Air intake openings and outlets for the inner circulation of the air/air heat exchanger must not be covered because this would prevent sufficient air circulation in the switching cabinet.

It is recommended to allow for sufficient space (> 200 mm) in front of the air intakes and outlets.

Caution!

If any modules or electronic components are used in the switching cabinet which use their own fans, make sure that the direction of air flow does not go against the cooling system's flow of cool air. An air bypass could occur which would prevent sufficient cooling in the switching cabinet.

Warning!

Make sure that only well-sealed switching cabinets are used because otherwise contaminated ambient air could permeate the switching cabinet.

Mounting air/air heat exchangers behind mounting plates should generally be avoided. However if this is necessary, then corresponding air shields must be used. Air intake openings and outlets must also be added to the mounting plate.

5.4 Using air/water heat exchangers

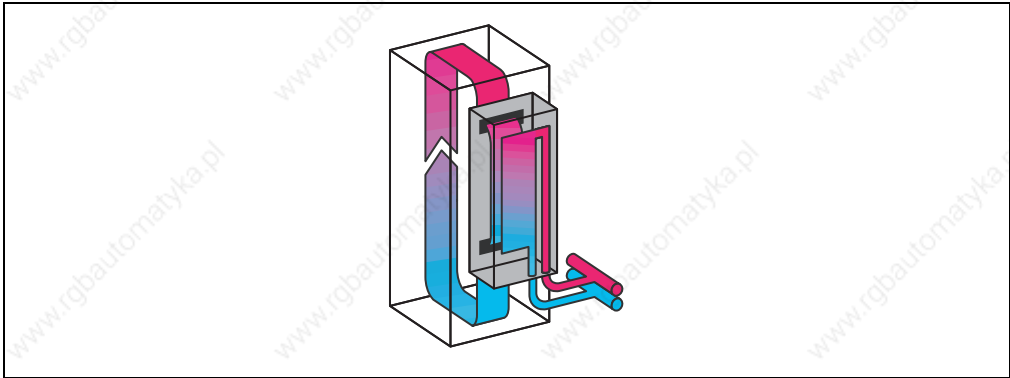


Figure 83: Function diagram of air/water heat exchangers

Caution!

An even circulation of air must be ensured in the switching cabinet. Air intake openings and outlets for the inner circulation of the air/water heat exchanger must not be covered because this would prevent sufficient air circulation in the switching cabinet.

It is recommended to allow for sufficient space (> 200 mm) in front of the air intakes and outlets.

Caution!

If any modules or electronic components are used in the switching cabinet which use their own fans, make sure that the direction of air flow does not go against the cooling system's flow of cool air. An air bypass could occur which would prevent sufficient cooling in the switching cabinet.

Warning!

Make sure that only well-sealed switching cabinets are used because otherwise contaminated ambient air could permeate the switching cabinet.

Mounting air/water heat exchangers behind mounting plates should generally be avoided. However if this is necessary, then corresponding air shields must be used. Air intake openings and outlets must also be added to the mounting plate.

5.5 Using cooling aggregates

5.5.1 General information

Caution!

Incorrect installation of cooling aggregates may cause condensation which can damage the ACOPOSmulti drives systems installed there!

Condensation can enter the ACOPOSmulti drive systems with the cooled air flow!

Warning!

Make sure that only well-sealed switching cabinets are used because otherwise ambient air could penetrate and cause condensation.

During operation with the switching cabinet doors open (e.g. service), the ACOPOSmulti drive systems are not allowed to be cooler than the air in the switching cabinet at any time after the doors are closed.

To keep the temperature of the ACOPOSmulti drive systems and the switching cabinet at the same level, the cooling aggregate must remain in operation even when the system is switched off.

Cooling aggregates must be installed in a way that prevents condensation from dripping into the ACOPOSmulti drive systems. This should be considered when selecting the switching cabinet (special construction for use of cooling aggregates on top of the switching cabinet).

Also make sure that condensed water which forms in the cooling aggregate fan when it is switched off cannot sprinkle into the ACOPOSmulti drive systems.

Make sure the temperature setting of the cooling aggregates is correct! Only set the switching cabinet's internal temperature as low as is necessary.

Be sure to follow the installation guidelines for the cooling aggregate provided in the operating manual!

5.5.2 Placing a cooling aggregate on top of the switching cabinet

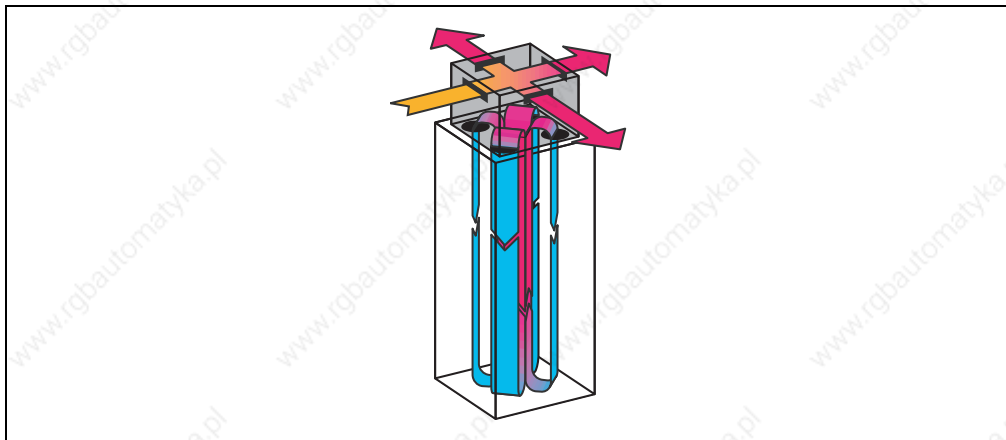


Figure 84: Placing a cooling aggregate on top of the switching cabinet

Caution!

Targeted air flow must be ensured when arranging cooling aggregates on the top of the switching cabinet! The flow of cool air must be directed through air channel systems at the lowest possible point in the switching cabinet (see image above).

Caution!

Make sure that the flow of cool air in the cooling system is not directed against the air flow from the fans in the ACOPOSmulti drive system. This could cause an air bypass, which would prevent sufficient cooling in the ACOPOSmulti drive system.

Condensation must be directed off the cooling aggregate according to manufacturer specifications so that it does not end up in the ACOPOSmulti drive system.

5.5.3 Placing a cooling aggregate on the front of the switching cabinet

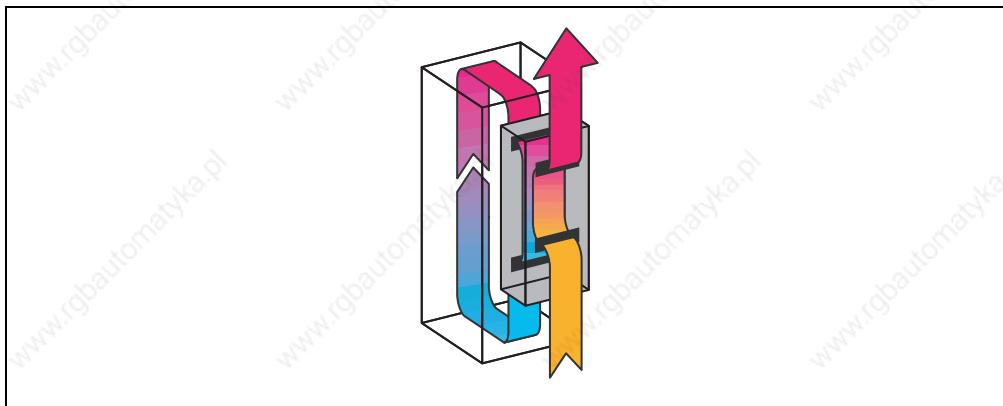


Figure 85: Placing a cooling aggregate on the front of the switching cabinet

Caution!

The flow of cool air from the cooling aggregate must be directed through air channel systems at the lowest possible point in the switching cabinet (see image above).

Caution!

Make sure that the flow of cool air in the cooling system is not directed against the air flow from the fans in the ACOPOSmulti drive system. This could cause an air bypass, which would prevent sufficient cooling in the ACOPOSmulti drive system.

Condensation must be directed off the cooling aggregate according to manufacturer specifications so that it does not end up in the ACOPOSmulti drive system.

Chapter 4 • Dimensioning

1. Power mains connection

1.1 General information

1.1.1 System configuration

The power mains connection for the ACOPOSmulti drive system is made using terminals X1 / L1, L2, L3 and PE on the ACOPOSmulti line filter. The ACOPOSmulti drive system can be directly connected to TT and TN systems (these are three-phase systems with grounded neutral).

When using ungrounded IT mains (three-phase systems without grounded neutral or with an impedance grounded neutral) or TN-S mains with grounded phase conductor and protective ground conductor, isolation transformers must be used. The secondary neutral must be grounded and connected to the ACOPOSmulti drive system protective ground conductor. This makes it possible to prevent over-voltages between external conductors and the housing for the ACOPOSmulti modules. Three-phase isolation transformers with the corresponding input and output voltages and a vector group with secondary neutral can be used (e.g. 3 x 400 V / 3 x 400 V, Dyn5).

In the USA, TT and TN systems are among the most common mains systems and are referred to as "Delta / Wye with grounded Wye neutral". TT systems are also known as "systems with ungrounded secondary" and TN-S mains with grounded phase conductor as "Delta / Delta with grounded leg".

Danger!

ACOPOSmulti drive systems are only permitted to be operated directly on grounded, three-phase industrial mains (TT, TN-S, TN-C-S). When using the ACOPOSmulti drive system in living areas, shops and small businesses, additional filtering measures must be implemented by the user.

Danger!

ACOPOSmulti drive systems are not permitted to be operated directly on IT and TN-S mains with a grounded phase conductor and protective ground conductor!

Warning!

ACOPOSmulti drive systems are suitable for power mains which can provide a maximum short circuit current (SCCR) of 10000 A_{eff} at a maximum of 528 V_{eff}.

Warning!

The network's short-circuit capacity S_k must be 10 times greater than the continuous power of the selected power supply unit.

1.1.2 Supply Voltage Range

The permissible supply voltage range for ACOPOSmulti drive systems is 3 x 220 VAC to 480 VAC $\pm 10\%$.

Respective intermediate transformers must be used for other supply voltages. With grounded power mains, autotransformers can also be used to adjust the voltage. Neutral does not have to be connected for this type of transformer.

Warning!

The apparent power from the transformer (intermediate transformer, autotransformer) must be at least 25% of the continuous power from the ACOPOSmulti power supply module being used. Otherwise, parasitic leakage inductances can cause excessive heating of the transformer. In extreme cases, this can cause critical damage to the transformer!

1.1.3 Protective ground connection (PE)

The following information concerning the protective ground connection corresponds to IEC 61800-5-1, Item 4.2.5.4 "Connection elements for the protective ground conductor" and must be followed.

A protective ground conductor must be connected to the line filter and also the ACOPOSmulti power supply module.

Wire cross section

The wire cross section for the protective ground conductor is oriented to the external conductors and must be selected according to the following table:

Wire cross section for external line A [mm ²]	Minimum wire cross section for protective ground connection A _{PE} [mm ²] ¹⁾
A ≤ 16	A
16 < A ≤ 35	16
35 < A	A / 2

Table 176: Selection of the protective ground conductor cross section

1) Any protective ground conductor that is not part of a cable must have a minimum wire cross section of 4 mm².

Increased Discharge Current

Danger!

ACOPOSmulti drive systems are devices with increased discharge current (larger than 3.5 mA AC or 10 mA DC).

A permanent (immobile) protective ground connection must be provided for ACOPOSmulti line filter / power supply units. The following conditions must be met, depending on the ACOPOSmulti module being used:

Dimensioning • Power mains connection

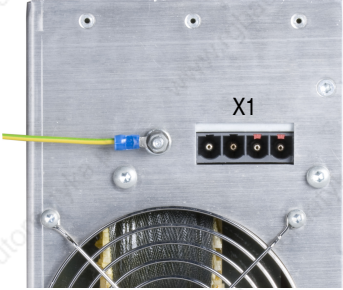
ACOPOSmulti module	Condition	Figure
8BVF0220H000.000-1 8BVF0440H000.001-2	In addition to the connection of the first protective ground conductor on terminal X1 / PE, a second protective ground conductor with the same cross section must be connected on the designated connector (M5 threaded bolt).	 <p>View from below</p>
8BVF0880H000.000-1	The cross section of the protective ground conductor connected to terminal X1 / PE must be at least 10 mm ² Cu.	---

Table 177: Protective ground conditions for ACOPOSmulti line filter 8BVF

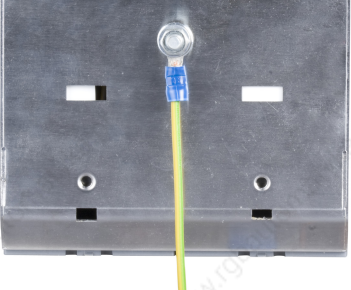
ACOPOSmulti module	Condition	Figure
8BxP0220Hx00.000-1 8BxP0440Hx00.000-1	In addition to the connection of the first protective ground conductor on terminal X5 / PE, a second protective ground conductor with the same cross section must be connected on the designated connector (M5 threaded bolt).	 <p>View from below</p>
8BVP0880Hx00.000-1	The cross section of the protective ground conductor connected to terminal X5 / PE must be at least 10 mm ² Cu.	---

Table 178: Protective ground conditions for ACOPOSmulti power supply module 8BxP

1.2 Dimensioning

In general, dimensioning the power mains, the over-current protection and (if necessary) the line contactors depend on the structure of the power mains connection.

1.2.1 Design of the ACOPOSmulti power mains connections

The structure of a power mains connection with circuit breaker can be seen in the following diagram:

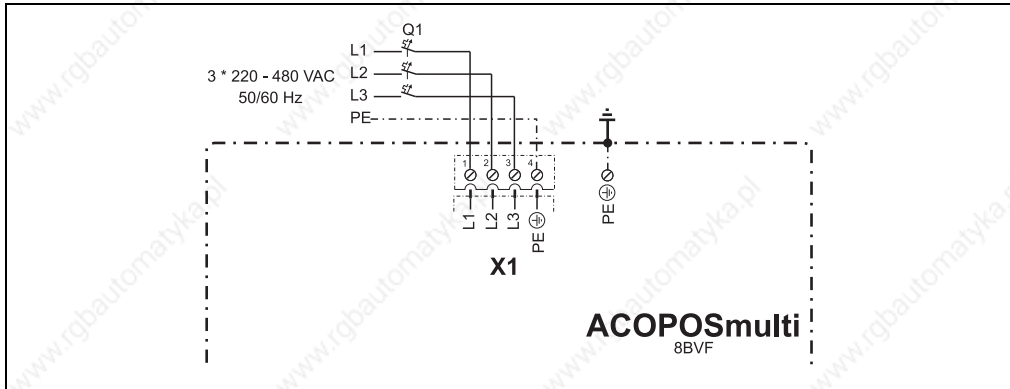


Figure 86: Circuit diagram for ACOPOSmulti line filter, power mains connection

Dimensioning the Power Mains and Over-current Protection

Information:

When choosing a suitable fuse, the user must also account for properties such as aging effects, temperature derating, overcurrent capacity and the definition of the rated current, which can vary by manufacturer and type. Furthermore, the fuse that is selected must also be able to handle application-specific aspects (e.g. overcurrents that occur in acceleration cycles).

The cross section of the power mains and the rated current for over-current protection should be determined based on the average current load to be expected.

The average current load to be expected can be calculated as follows:

$$I_{\text{Mains}}[\text{A}] = \frac{P[\text{VA}]}{\sqrt{3} \cdot U_{\text{Mains}}[\text{V}]}$$

Dimensioning • Power mains connection

The cross section of the power mains and the rated current of the over-current protection used are chosen according to table 179 "Maximum current load vfor PVC insulated three-phase cables or individual wires", on page 330 so that the maximum current load for the cable cross section selected is greater than or equal to the calculated current load.

$$I_Z \geq I_{\text{Mains}}$$

The rated current of the over-current protection must be less than or equal to the maximum current load for the cable cross section selected (see table 179 "Maximum current load vfor PVC insulated three-phase cables or individual wires", on page 330).

$$I_B \leq I_Z$$

The following table shows the maximum current load of PVC insulated three-phase cables (or three current-carrying wires) according to IEC 60204-1 at 40 °C ambient temperature ¹⁾ and 70 °C maximum conductor temperature (maximum current load for installation type F and cross sections greater than 35 mm², IEC 60364-5-523 is used for installation types B1 and B2).

Line cross section [mm ²]	Maximum current load for the cable cross section I_Z / rated current for the over-current protection I_R [A] depending on the type of installation				
	Three individual wires in conduit or cable duct	Three-phase cable in conduit or cable duct	Three-phase cable on walls	Three-phase cable in a cable tray	Three individual wires in a cable tray
	B1	B2	C	E	F
1.5	13.5 / 13	12.2 / 10	15.2 / 13	16.1 / 16	---
2.5	18.3 / 16	16.5 / 16	21 / 20	22 / 20	---
4	25 / 25	23 / 20	28 / 25	30 / 25	---
6	32 / 32	29 / 25	36 / 32	37 / 32	---
10	44 / 32	40 / 32	50 / 50	52 / 50	---
16	60 / 50	53 / 50	66 / 63	70 / 63	---
25	77 / 63	67 / 63	84 / 80	88 / 80	96 / 80
35	97 / 80	83 / 80	104 / 100	114 / 100	119 / 100
50	117 / 100	103 / 100	123 / 100	123 / 100	145 / 125
70	149 / 125	130 / 125	155 / 125	155 / 125	188 / 160
95	180 / 160	156 / 125	192 / 160	192 / 160	230 / 200

Table 179: Maximum current load vfor PVC insulated three-phase cables or individual wires

When determining the cross section for the power mains, make sure that the cross section selected is within the range that can be used with power mains terminal X1 on the ACOPOSmulti line filter (see section 1.3 "Overview of clampable diameter ranges", on page 392).

- 1) The maximum current load value in IEC 60204-1 is for an ambient temperature of 40 °C. This reference temperature is 30 °C in IEC 60364-5-523. The values in table 179 "Maximum current load vfor PVC insulated three-phase cables or individual wires", on page 330 from IEC 60364-5-523 are also converted for use at 40°C with the factor $k_{\text{temp}} = 0.87$ specified in the standard. With the specified maximum current load, a reduction factor for groups of cables and individual wires is not taken into consideration. If necessary, they must be taken from the corresponding standards and included in the calculation.

Over-current protection in the form of a circuit breaker or a fuse is required. Circuit breakers (time lag) with type C tripping characteristics (according to IEC 60898) or fuses (time lag) with type gG tripping characteristics (according to IEC 60269-1) are to be used. ¹⁾

North America:

Class J fuses according to UL Standard 248-8 can be used (for example fuses of type AJTxx from Ferraz Shawmut (www.ferrazshawmut.com) or type LPJ-xxSP from Bussmann (www.bussmann.com), where xx is the rated current for the respective fuse).

The fuse must have the following tripping characteristics:

Minimum tripping time [s]	Rated current for the fuse at an average expected current load of			
	12 ... 35 A	50 ... 80 A	100 ... 125 A	160 A
0.2	Approx. $5.1 \cdot I_{\text{mains}}$	Approx. $4.5 \cdot I_{\text{mains}}$	Approx. $3.6 \cdot I_{\text{mains}}$	Approx. $4.0 \cdot I_{\text{mains}}$
4	Approx. $3.7 \cdot I_{\text{mains}}$	Approx. $3.3 \cdot I_{\text{mains}}$	Approx. $2.8 \cdot I_{\text{mains}}$	Approx. $3.2 \cdot I_{\text{mains}}$
10	Approx. $2.9 \cdot I_{\text{mains}}$	Approx. $2.5 \cdot I_{\text{mains}}$	Approx. $2.0 \cdot I_{\text{mains}}$	Approx. $2.3 \cdot I_{\text{mains}}$
240	Approx. $1.7 \cdot I_{\text{mains}}$	Approx. $1.7 \cdot I_{\text{mains}}$	Approx. $1.6 \cdot I_{\text{mains}}$	Approx. $1.8 \cdot I_{\text{mains}}$

Table 180: Tripping characteristics of the fuse for the power mains connection

Dimensioning the Line Contactor

The rated current of the line contactor is oriented to the over-current protection for the power mains connection. The line contactor is set up so that nominal operating current specified by the manufacturer of the line contactor for category AC-1 according to EN 60947-4-1 is approximately 1 times the rated current of the over-current protection.

1) Circuit breakers are available on the market with rated currents from 6 A to 63 A. Outside of this range, fuses must be used.

1.3 Fault current protection

Fault current protection (RCD - residual current-operated protective device) can be used with ACOPOSmulti drive systems. However the following points must be noted:

ACOPOSmulti drive systems have a power rectifier. If a short-circuit to the frame occurs, a flat DC fault current can be created which prevents an AC current or pulse current sensitive RCD (type A or AC) from being activated, therefore canceling the protective function for all connected devices.

Danger!

If used for protection during direct or indirect contact of the fault current protection (RCD), only a Type B RCD (AC-DC sensitive, according to IEC 60755) can be used for the ACOPOSmulti drive system power mains connection. Otherwise additional protective measures must be used, such as neutralization or isolation from the power mains using an isolation transformer.

1.3.1 Rated fault current

On ACOPOSmulti drive systems, fault current protection with a rated fault current of 300 mA can be used. However, errors can occur:

- When connecting ACOPOSmulti drive systems to the power mains, contact chatter causes single or two-phase operation. This results in short-term increases to discharge currents via the bypass capacitors in the line filter and in the power supply and inverter modules.
- Because of high frequency discharge currents occurring during operation via the bypass capacitors in the power supply and inverter modules.
- Because of high frequency discharge currents occurring during operation via long motor cables.

1.3.2 Estimating possible ACOPOSmulti drive system configurations

Estimating ACOPOSmulti drive system configurations that can be used with certain fault current protection is somewhat imprecise for two reasons:

- 1) The rated fault currents listed by the manufacturer are maximum currents which will definitely trip the fault current protection device. Normally, the fault current protection device is tripped at approximately 60% of the rated fault current.
- 2) Contact chatter when connecting the ACOPOSmulti drive system to the power mains depends on the switching device used.

To reduce problems with tripping currents, B&R carried out tests with several fault current protection device types available on the market. To reduce problems with contact chatter, B&R recommends connecting the ACOPOSmulti drive system to the power mains with a line contactor. This normally results in sufficiently short contact chatter times.

Dimensioning • Power mains connection

To determine if an ACOPOSmulti drive system can be operated with a certain fault current protection device, the sums of all discharge capacitances C_D in the drive system must be determined:

$$C_D[\mu\text{F}] = C_{D_{\text{LineFilter}}}[\mu\text{F}] + C_{D_{\text{PowerSupplyModule}}}[\mu\text{F}] + \sum C_{D_{\text{InverterModule}}}[\mu\text{F}]$$

The discharge capacitances for the individual modules in the respective ACOPOSmulti drive system can be found in the following table:

Module	Discharge capacitance C_D
ACOPOSmulti line filter	
8BVF0220H000.000-1	14.1 μF
8BVF0440H000.001-2	14.1 μF
8BVF0880H000.000-1	14.1 μF
ACOPOSmulti power supply modules	
8B0P0220Hx00.000-1	0.9 μF
8B0P0440Hx00.000-1	0.9 μF
8BVP0220Hx00.000-1	0.9 μF
8BVP0440Hx00.000-1	0.9 μF
8BVP0880Hx00.000-1	0.9 μF
8BVP1650Hx00.000-1	1.8 μF
ACOPOSmulti inverter modules	
8BVI0014HxS0.000-1	0.14 μF
8BVI0028HxS0.000-1	0.14 μF
8BVI0055HxS0.000-1	0.14 μF
8BVI0110HxS0.000-1	0.14 μF
8BVI0014HxD0.000-1	0.2 μF
8BVI0028HxD0.000-1	0.2 μF
8BVI0055HxD0.000-1	0.2 μF
8BVI0110HxD0.000-1	0.44 μF
8BVI0220HxS0.000-1	0.22 μF
8BVI0220HxD0.000-1	0.44 μF
8BVI0330HxS0.000-1	0.22 μF
8BVI0440HxS0.000-1	0.22 μF
8BVI0880HxS0.000-1	0.45 μF
8BVI1650HxS0.000-1	0.9 μF

Table 181: Discharge capacitances C_D of ACOPOSmulti modules

1.3.3 Manufacturers of fault current protection devices that can be used

Manufacturer	Type	Comment	Rated current [mA]
Doepke (www.doebke.de)	DFS 4B SK 63-4/0.3	AC-DC sensitive	300
	DFS 4B SKS 63-4/0.3	AC-DC sensitive selective (delayed)	
	DFS 4B SK 63-4/0.5	AC-DC sensitive	500
	DFS 4B SKS 63-4/0.5	AC-DC sensitive selective (delayed)	
ABB (www.abb.com)	F204 B-63/0.3	AC-DC sensitive	300
	F204 BS-63/0.3	AC-DC sensitive selective (delayed)	

Table 182: Manufacturers of fault current protection devices that can be used

These fault current protection devices can be used up to a total discharge capacitance C_D of approx. 20 μF for the ACOPOSmulti drive system.

1.3.4 Examples

Example 1

A check must be carried out to determine if the following ACOPOSmulti drive system can be operated with the fault current protection device ABB F204B-63/0.3:

ACOPOSmulti drive system consisting of		Discharge capacitance C_D	
Amount	Module name	per Module	Total
1	8BVF0440H000.001-2	14.1 μF	14.1 μF
1	8BVR0440H000.001-2	---	---
1	8BVP0440HC00.000-1	0.9 μF	0.9 μF
1	8BVI0440HCS0.000-1	0.22 μF	0.22 μF
5	8BVI0028HCD0.000-1	0.14 μF	0.7 μF
Total discharge capacitance C_D			15.92 μF

Table 183: Checking if fault current protection devices can be used, Example 1

The total discharge capacitance C_D for this ACOPOSmulti drive system is lower than 20 μF . This ACOPOSmulti drive system can therefore be operated with the fault current protection device ABB F204B-63/0.3.

Example 2

It's necessary to check if the following ACOPOSmulti drive system can be operated with the Doepke DFS 4B SK 63-4/0.5 fault current protection device:

ACOPOSmulti drive system consisting of		Discharge capacitance C_D	
Amount	Module name	per Module	Total
1	8BVF0880H000.000-1	14.1 μF	14.1 μF
1	8BVR0880H000.000-1	---	---
1	8BVP0880HC00.000-1	0.9 μF	0.9 μF
1	8BVI0880HCS0.000-1	0.45 μF	0.45 μF
1	8BVI0440HCS0.000-1	0.22 μF	0.22 μF
2	8BVI0110HCS0.000-1	0.14 μF	0.28 μF
3	8BVI0055HCD0.000-1	0.14 μF	0.42 μF
Total discharge capacitance C_D			16.37 μF

Table 184: Checking if fault current protection devices can be used, Example 2

The total discharge capacitance C_D for this ACOPOSmulti drive system is lower than 20 μF . This ACOPOSmulti drive system can therefore be operated with the Doepke DFS 4B SK 63-4/0.5 fault current protection device.

2. Motor connector

On B&R motors, the power connections, the connections for the holding brake and the connections for the motor temperature sensor are all made using the same motor plug.

The motor connection is made on the ACOPOSmulti drive system using the ACOPOSmulti inverter unit. The motor connection must be shielded correctly (see section 1.1.3 "Overview", on page 375).

The structure of the motor connection can be seen in the following diagram:

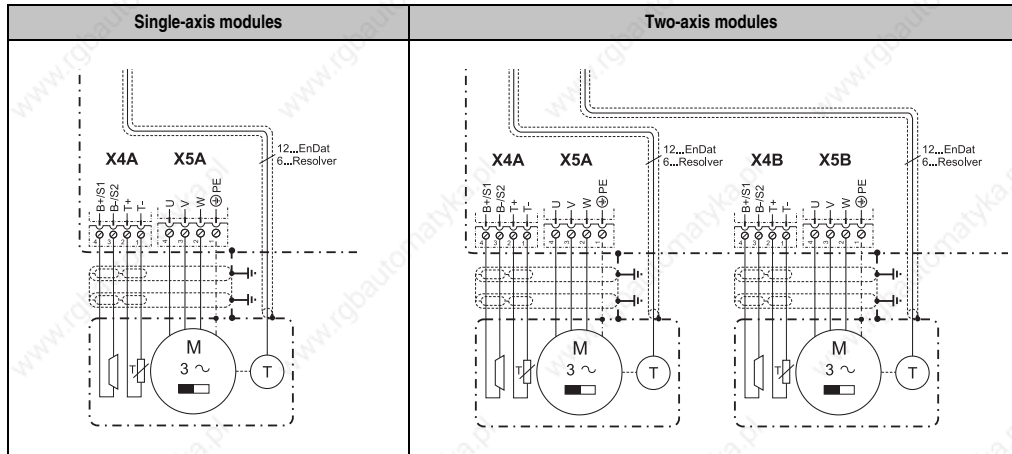


Figure 87: Circuit diagram for ACOPOSmulti inverter modules, motor connection

The cross section of the motor cable must be dimensioned for the thermal equivalent effective value of the motor current. ¹⁾

The cross section of the motor cable is chosen for B&R motor cables according to the following table so that the maximum current load for the cable cross section selected is greater than or equal to the thermal equivalent effective value of the motor current:

$$I_z \geq I_q$$

1) If information concerning load torque, inertia and friction are available, the thermal equivalent effective value for the motor current of the motor used is calculated as follows:

$$I_q[\text{A}] = \sqrt{\frac{1}{T_{\text{Cycle}}[\text{s}]} \cdot \sum_i I_i[\text{A}]^2 \cdot t_i[\text{s}]}$$

The following table shows the maximum current load for special insulated three-phase cables according to IEC 60364-5-523 at 40 °C ambient temperature ¹⁾ and 90 °C maximum cable temperature.

Line cross section [mm ²]	Maximum current load on the line I _Z [A] depending on type of installation		
	Three-phase cable in conduit or cable duct	Three-phase cable on walls	Three-phase cable in a cable tray
	B2	C	E
1.5	17.8	20	20.9
4	31.9 ¹⁾	36.4 ¹⁾	38.2 ¹⁾
10	54.6	64.6	68.3
35	116.5	133.8	143.8

Table 185: Maximum current load for special insulated three-phase cables

1) The plug pins on the assembled B&R motor cable 8BCMxxxx.1312A-0 can only handle a max. load of 30 A.

When determining the cross section for the motor cable, make sure that the cross section selected is within the range that can be used with motor connection terminal X5 (see section 1.3 "Overview of clampable diameter ranges", on page 392).

1) The maximum current load value in IEC 60364-5-523 is for an ambient temperature of 30 °C. The values in table 185 "Maximum current load for special insulated three-phase cables", on page 337 are converted for use at 40°C ambient temperature using the factor $k_{Temp} = 0.91$ given in the standard.

With the specified maximum current load, a reduction factor for groups of cables and individual wires is not taken into consideration. If necessary, they must be taken from the corresponding standards and included in the calculation.

3. Braking resistor

3.1 General information

When braking servo motors, power is returned to the drive system. This causes the capacitors in the DC bus to be charged to higher voltages. Starting with a DC bus voltage of approx. 800 V, the passive 8B0P power supply module links an external braking resistor to the DC bus using the brake chopper and converts the braking energy to heat.

3.2 External braking resistor connection

An external braking resistor is connected using terminals X5B / RB+, RB- and PE. The structure of the external braking resistor connection can be seen in the following diagram:

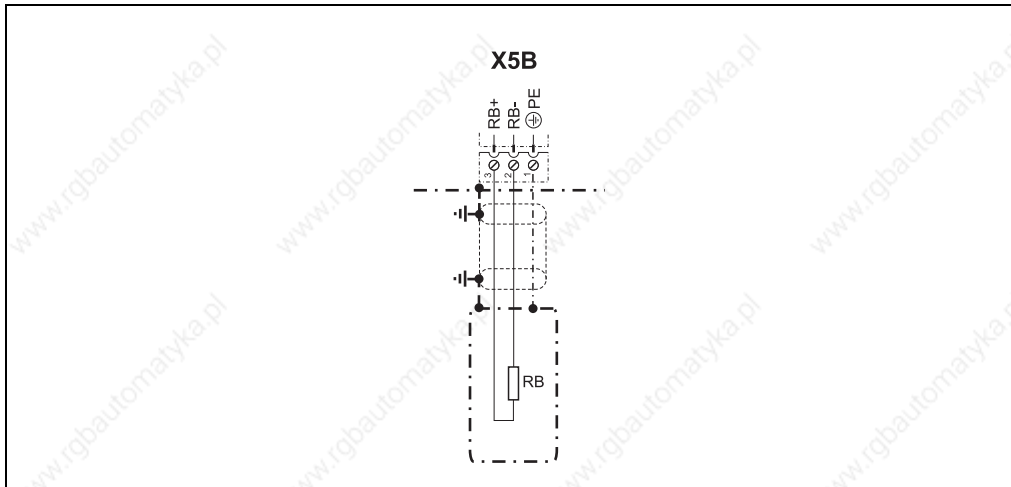


Figure 88: Circuit diagram 8B0P0xx0Hx00.00x-1, connection X5B (external braking resistor)

When determining the diameter ¹⁾ for wiring the external braking resistor, make sure that the selected diameter is within the range that can be used with braking resistor connection terminal X5B (see Chapter 1.3 "Overview of clampable diameter ranges", section 1.3.3 "8B0P power supply modules", on page 393).

- 1) The cross section of the braking resistor cable must be dimensioned for the thermal equivalent effective value of the respective brake current. If information concerning the flow of the brake current is available, calculate the thermal equivalent effective value of the brake current using

$$I_q[\text{A}] = \sqrt{\frac{1}{T_{\text{Cycle}}[\text{s}]} \cdot \sum_i I_i[\text{A}]^2 \cdot t_i[\text{s}]}$$

The cross section of the braking resistor connection should then be selected as described in table 179 "Maximum current load vfor PVC insulated three-phase cables or individual wires", on page 330, so that the maximum current load of the cable cross section is greater than or equal to the thermal equivalent effective value of the brake current ($I_2 \geq I_q$).

3.2.1 Fuse protection

To protect the external braking resistor connection, a fuse is built into the bottom of passive 8BOP power supply modules. ¹⁾

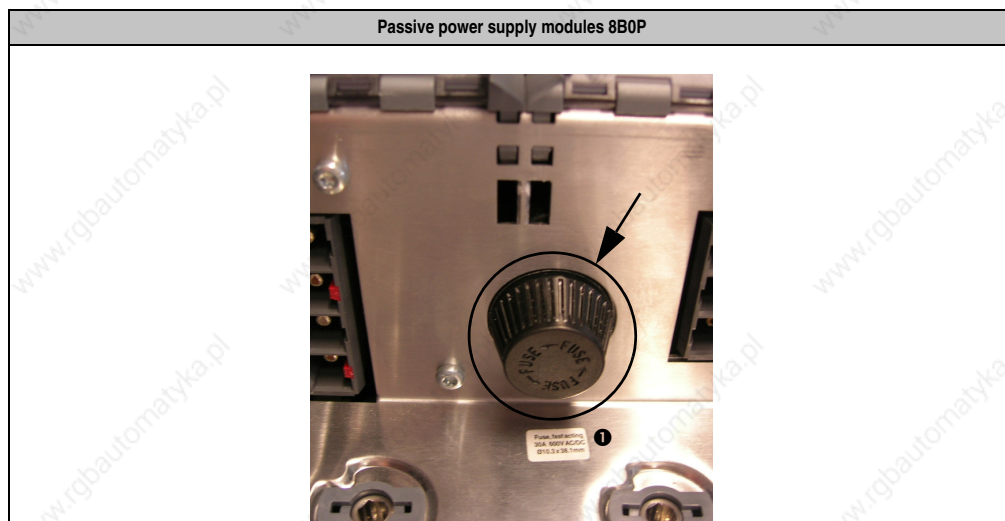


Table 186: The location where the fuse for the external braking resistor connection is installed

The relevant data for the fuses that are to be used can be found on the sticker (❶) close to the fuse holder.

1) The fuses used must be fast-acting fuses $\varnothing 10 \times 38$ mm for 600 VAC/VDC.

For example, type KLKD0xx (xx is the rated current of the fuse in amperes e. g. KLKD030) from Littelfuse (www.littelfuse.com) can be used.

3.3 Sizing the braking resistor

3.3.1 Calculation basics

An external braking resistor can be dimensioned based on the sum of the movement and load profiles of all axes that are connected via the DC bus to the passive 8B0P power supply module which the external braking resistor should be connected to:

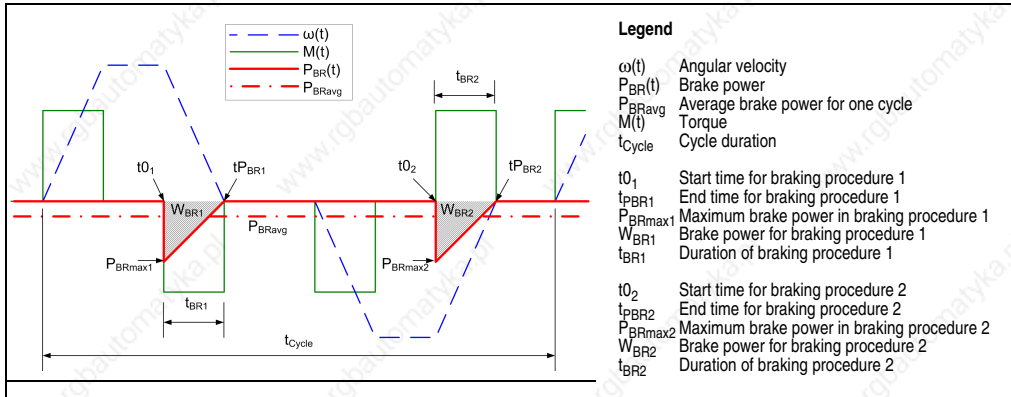


Figure 89: Adding the movement and load profile for a sample application

Power calculation

$$P(t) = M(t) \cdot \omega(t)$$

All $P(t) < 0$ will be labeled as brake power ratings $P_{BR}(t)$.

Braking energy per braking procedure (responsible for heating up the braking resistor during a braking procedure)

$$W_{BR_i} = \int_{t_{0_i}}^{t_{PBR_i}} P_{BR_i}(t) dt \quad P_{BR_i} < 0$$

Braking energy for one cycle (responsible for average heating of the braking resistor)

$$W_{BRtotal} = \sum_{i=1}^N W_{BR_i}$$

Maximum brake power within one cycle (determinant variable for selecting the braking resistor value)

$$P_{BRmaxAPPL} = \text{Max}(P_{BRmax_i})$$

Average brake power for one cycle (determinant variable for the required continuous power of the braking resistor)

$$P_{BRavgAPPL} = \frac{W_{BRtotal}}{t_{Cycle}}$$

Total braking time within one cycle (determinant variable for determining the duty cycle ratio)

$$t = \sum_0^{t_{Cycle}} t_{BRi}$$

Determining the braking resistor data

The following parameters must be determined for the external braking resistor according to the application:

- Resistor value (R_{BR})
- Maximum power (P_{BRmax})
- Rated continuous power (P_{BRN})

Further parameters for external braking resistors can be taken from the manufacturer's data sheet:

- Thermal capacity (C_{th})
- Thermal resistance (R_{th})
- Maximum temperature of the braking resistor (T_{BRmax}) or absorbed heat up to T_{BRmax} (Q_{BRmax})

Data for B&R 8B0W braking resistors

Model number	Mounting orientation	R_{BR} [Ω]	T_{BRmax} [$^{\circ}C$] ¹⁾	R_{th} [K/W]	C_{th} [J/K]	Q_{BRmax} [J] ^{1) 2)}	P_{BRN} [W] ^{1) 2)}
8B0W0045H000.00x-1	Vertical	50	682	1.517	16.3	10465	450
	Horizontal	50	682	1.897	16.3	10465	360
8B0W0079H000.00x-1	Vertical	33	673	0.852	22.6	14306	790
	Horizontal	33	673	1.065	22.6	14306	632

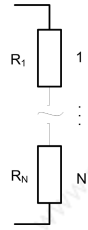
Table 187: Overview of 8B0W braking resistor data

1) T_{BRmax} can be reduced by application-related limitations (contact protection, warming of neighboring components, maximum warming of the switching cabinet, installation position, etc.). In this case, the values for Q_{BRmax} and P_{BRN} will also change; these must be recalculated for the maximum value of T_{BRmax} permitted in the application!

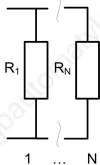
2) Values for $T_{amb} = 40^{\circ}C$.

Series and parallel connection of braking resistors

Parameter	Serial connection	Parallel operation
Resistance value	$R_{ges} = \sum_{i=1}^N R_i$	$\frac{1}{R_{ges}} = \sum_{i=1}^N \frac{1}{R_i}$
Thermal resistance	$\frac{1}{R_{thtotal}} = \sum_{i=1}^N \frac{1}{R_{thi}}$	$\frac{1}{R_{thtotal}} = \sum_{i=1}^N \frac{1}{R_{thi}}$
Thermal capacity	$C_{th} = \sum_{i=1}^N C_{thi}$	$C_{th} = \sum_{i=1}^N C_{thi}$
Max. permissible temperature	$T_{max} = T_{max}$	$T_{max} = T_{max}$
Absorbed heat up to T_{max}	$Q_{maxtotal} = \sum_{i=1}^N Q_{maxi}$	$Q_{maxtotal} = \sum_{i=1}^N Q_{maxi}$



Serial connection diagram showing resistors R₁ through R_N connected in series.



Parallel connection diagram showing resistors R₁ through R_N connected in parallel.

Table 188: Series and parallel connection of braking resistors

Maximum heat that can be absorbed by the braking resistor:

$$Q_{BRmax} = (T_{BRmax} - T_{amb}) \cdot c_{th}$$

Maximum temperature in continuous operation:

$$\Delta T_{Dauer} = P_{avg} \cdot R_{th}$$

Average over-temperature in continuous operation:

$$\Delta T_{BR} = \frac{W_{BRtotal}}{C_{th}}$$

Thermal time constant of the braking resistor:

$$\tau = R_{th} \cdot c_{th}$$

3.3.2 Example

Scenario

An axis has the following movement and load profile:

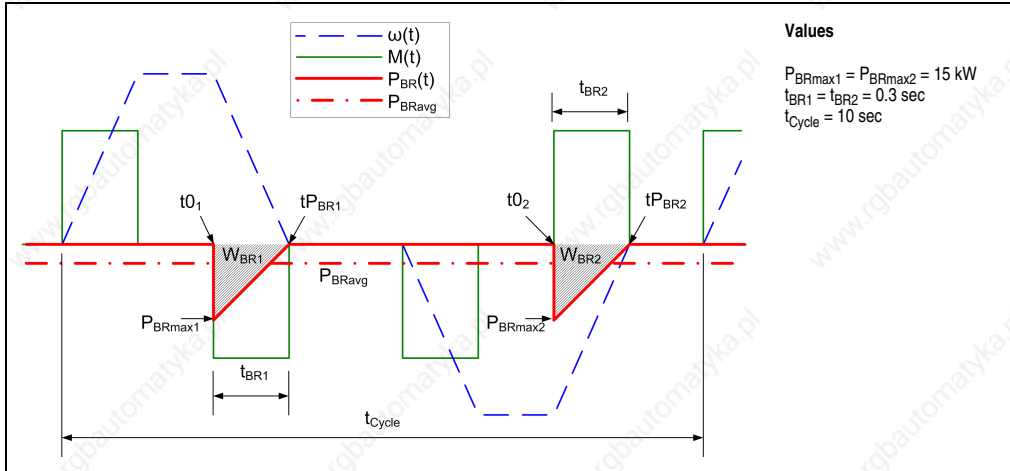


Figure 90: Example: Add movement and load profile

- The ambient temperature is 40°C.
- There are no application-related limitations for the maximum surface temperature of the braking resistor.

Calculation

Step 1) Determine maximum brake power within one cycle

$$P_{BRmaxAPPL} = P_{BRmax1} = P_{BRmax2} = 50kW$$

Step 2) Determine average brake power for one cycle

$$W_{BRtotal} = \frac{P_{BRmax1} \cdot t_{BR1}}{2} + \frac{P_{BRmax2} \cdot t_{BR2}}{2} = \frac{50kW \cdot 0,3s}{2} + \frac{50kW \cdot 0,3s}{2} = 15kJ$$

$$P_{BRavgAPPL} = \frac{W_{BRtotal}}{t_{Cycle}} = \frac{15kJ}{10s} = 1,5kW$$

Step 3) Determine the right ACOPOSMulti 8B0P power supply module

The following criteria must be met:

$$P_{maxServo} \geq P_{BRmaxAPPL} \Rightarrow P_{maxServo} \geq 50kW$$

$$I_{BRServo} \geq \frac{\sqrt{P_{BRavgAPPL} \cdot P_{BRmaxAPPL}}}{U_{DC}} \Rightarrow I_{BRServo} \geq \frac{\sqrt{1500W \cdot 50000W}}{750V} \Rightarrow I_{BRServo} \geq 11,54A$$

The ACOPOSMulti power supply module 8B0P0440Hx00.000-1 meets these criteria (see table 48 "Technical data - 8B0P power supply modules", on page 72):

- $P_{maxServo} = 65kW \geq 50kW$
- $I_{BRServo} = 22A \geq 11,54A$

Can the selected ACOPOSmulti 8B0P power supply module conduct the peak power for the required braking duration for each individual braking procedure within the cycle?

This can be checked using the following diagrams:

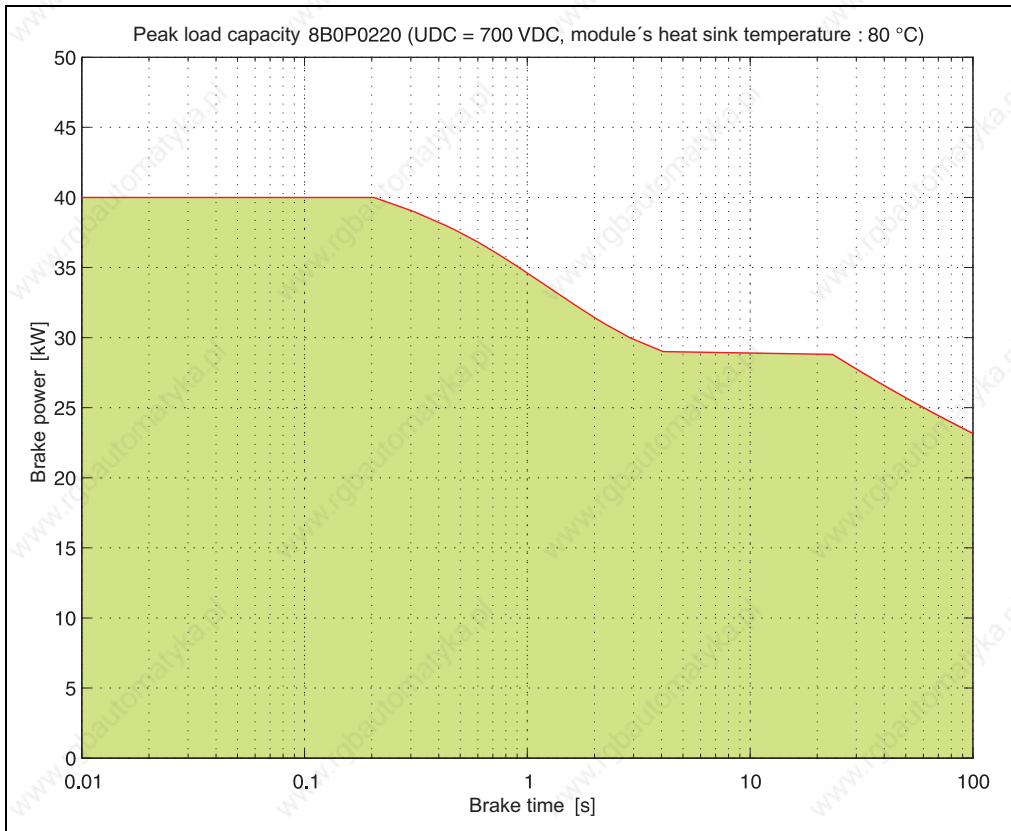


Figure 91: Peak load capacity 8B0P0220Hx00.00x-1

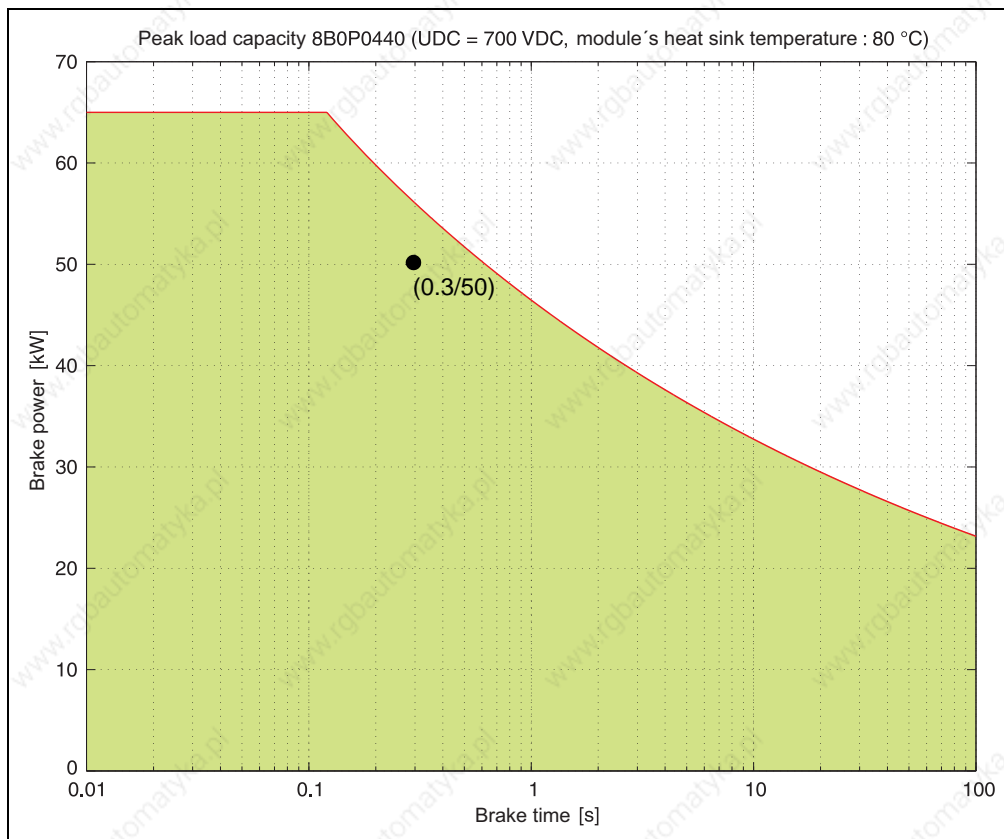


Figure 92: Peak load capacity 8B0P0440Hx00.00x-1

The individual braking procedures within one cycle are entered in the diagram as points with the coordinates (t_{BR}/P_{BRmax}) and must all be within the permissible range (marked green). If this is not the case, then a different ACOPOSmulti 8B0P power supply module must be selected!

Figure 92 "Peak load capacity 8B0P0440Hx00.00x-1" contains the individual braking procedures from the sample application ($t_{BR} = 0.3$ sec, $P_{BRmax} = 50$ kW). These are within the permissible range, which indicates that the selected ACOPOSmulti 8B0P power supply module is suitable for the peak power of each individual braking procedure in the application.

Step 4) Determine value of the required external braking resistor

Maximum permissible braking resistor for the application:

$$R_{BRmaxAPPL} = \frac{U_{DCmax}^2}{P_{BRmaxAPPL}} = \frac{750V^2}{50000W} = 11,25\Omega$$

The value of the external braking resistor must meet the following criteria:

- $R_{BR} \geq R_{minServo} \Rightarrow R_{BR} \geq 7,5\Omega$
- $R_{BR} \geq \frac{P_{BRavgAPPL}}{I_{BRServo}^2} \Rightarrow R_{BR} \geq \frac{1500W}{22A^2} \Rightarrow R_{BR} \geq 3,1\Omega$
- $R_{BR} \leq R_{BRmaxAPPL} \Rightarrow R_{BR} \leq 11,25\Omega$

Therefore, a braking resistor or a combination of braking resistors must be selected with a resistance value between 7.5 Ω and 11.25 Ω .

Step 4) Select external braking resistor**Caution!**

If a resistance less than the minimum resistance is used, the brake chopper built into the device could be destroyed!

Danger!

During braking, voltages up to 900 VDC can occur on the external braking resistor. The external braking resistor must be able to handle these voltages.

Information:

We recommend choosing braking resistor value so that its resistance value R_{BR} is as close as possible to the maximum value permissible for the application R_{BRmax} , in order to keep the current low through the fuse on the ACOPOSmulti 8B0P power supply module's braking resistor connection.

This can require a parallel or series connection of individual braking resistors.

Three braking resistors 8B0W0079H000.001-1 ($R_{BR} = 33 \Omega$) will be connected in parallel to maintain a resistance value that is right for the application (for technical data, see table "Overview of 8B0W braking resistor data", on page 341):

- Resistance value: $\frac{1}{R_{BR}} = \sum_{i=1}^N \frac{1}{R_{BR_i}} \Rightarrow R_{BR} = 11\Omega \leq 11, 25\Omega$
- Thermal capacity: $c_{th} = \sum_{i=1}^N c_{th_i} \Rightarrow c_{th} = 77, 8 \frac{J}{K}$

The continuous power P_{BRN} and the thermal resistance R_{th} of the selected combination of braking resistors depends on the installation position:

- Horizontal installation:

$$\frac{1}{R_{th}} = \sum_{i=1}^N \frac{1}{R_{th_i}} \Rightarrow R_{th} = 0, 355\Omega \quad P_{BRN} = \sum_{i=1}^N P_{BRN} \Rightarrow P_{BRN} = 1896W$$

- Vertical installation:

$$\frac{1}{R_{th}} = \sum_{i=1}^N \frac{1}{R_{th_i}} \Rightarrow R_{th} = 0, 284\Omega \quad P_{BRN} = \sum_{i=1}^N P_{BRN} \Rightarrow P_{BRN} = 2370W$$

Information:

The rated continuous power P_{BRN} of a braking resistor depends on the ambient temperature and the braking resistor's maximum permissible temperature.

The braking resistor's rated power will be decreased if, for application reasons, the ambient temperature is increased and/or the braking resistor's maximum permissible temperature is limited (contact protection, warming of neighboring components, maximum warming of the switching cabinet, installation position, etc.)!

Is the rated continuous power P_{BRN} of the selected braking resistor combination sufficient for the application's average brake power $P_{BRavgAPPL}$?

The following condition must be met:

$$P_{BRN} \geq P_{BRavgAPPL}$$

This condition must be checked for all permissible installation positions:

- Horizontal installation:
 $P_{BRN} \geq P_{BRavgAPPL} \Rightarrow 1896W > 1500W \rightarrow$ Rated continuous power P_{BRN} is sufficient
- Vertical installation:
 $P_{BRN} \geq P_{BRavgAPPL} \Rightarrow 2370W > 1500W \rightarrow$ Rated continuous power P_{BRN} is sufficient

Can the selected braking resistor conduct the incidental braking energy without exceeding the maximum braking resistor temperature for the application?

The following condition must be met for this to happen: $P_{BRN} \geq \frac{W_{Br_i}}{t_i} \cdot k$

The peak load factor k for any braking resistor can be visually determined using the following diagram:

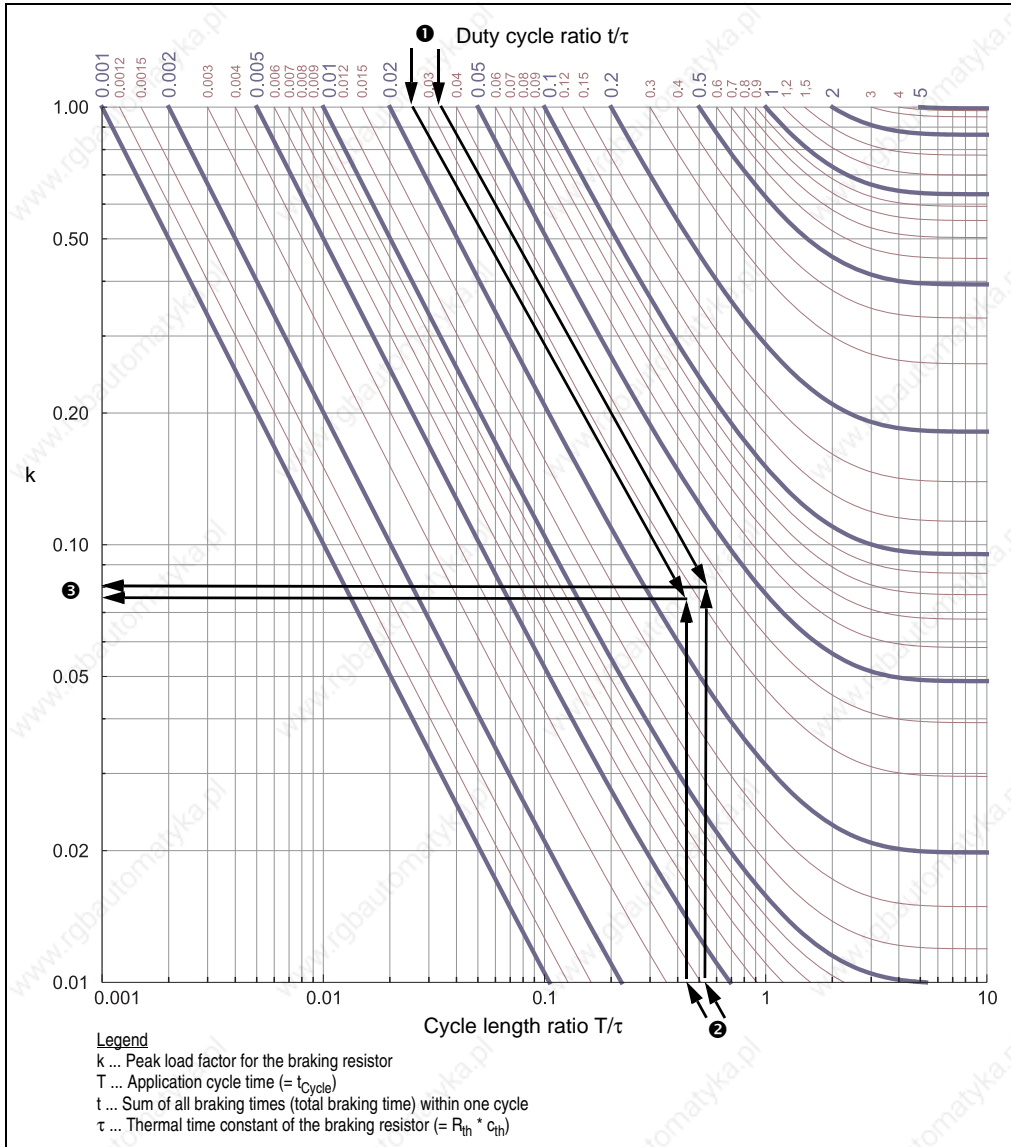


Figure 93: Determining the peak load factor k

Dimensioning • Braking resistor

❶ Calculation of the duty cycle ratio

- Horizontal installation: $\frac{t}{\tau} = \frac{t_{BR1} + t_{BR2}}{R_{th} \cdot c_{th}} = \frac{0,3 + 0,3}{0,355 \cdot 67,8} = 0,025$
- Vertical installation: $\frac{t}{\tau} = \frac{t_{BR1} + t_{BR2}}{R_{th} \cdot c_{th}} = \frac{0,3 + 0,3}{0,284 \cdot 67,8} = 0,031$

❷ Calculation of the cycle length ratio

- Horizontal installation: $\frac{T}{\tau} = \frac{t_{Cycle}}{R_{th} \cdot c_{th}} = \frac{10}{0,355 \cdot 67,8} = 0,415$
- Vertical installation: $\frac{T}{\tau} = \frac{t_{Cycle}}{R_{th} \cdot c_{th}} = \frac{10}{0,284 \cdot 67,8} = 0,519$

❸ Reading the peak load factor k based on the values from ❶ and ❷ in figure 93 "Determining the peak load factor k"

- Horizontal installation: $k = 0.075$
- Vertical installation: $k = 0.08$

This condition must be checked for all permissible installation positions:

- Horizontal installation:

$$P_{BRN} \geq \frac{W_{BRi}}{t_i} \cdot k \Rightarrow 1896W \geq \frac{7500J}{0,3s} \cdot 0,075 \Rightarrow 1896W \geq 1875W$$

--> The rated power P_{BRN} of the braking resistor is barely sufficient for the application - no reserves! Therefore, horizontal installation is not recommended!

- Vertical installation:

$$P_{BRN} \geq \frac{W_{BRi}}{t_i} \cdot k \Rightarrow 2370W \geq \frac{7500J}{0,3s} \cdot 0,08 \Rightarrow 2370W \geq 2000W$$

--> The rated power P_{BRN} of the braking resistor is sufficient for the application

Result

Three B&R braking resistors 8B0W0079H000.001-1 connected in parallel and installed vertically on an ACOPOSmulti 8B0P0440Hx00.00x-1 power supply module meet the requirements of the application.

3.4 Setting brake resistor parameters

When using external braking resistors, the following parameters must be set on the drive system using B&R Automation Studio:

ParID	Name	Formula symbols	Units
10	Ohmic resistance	R_{BR}	[Ω]
11	Maximum over-temperature on the external braking resistor	T_{BRmax}	[$^{\circ}C$]
12	Thermal resistance between braking resistor and the environment ¹⁾	R_{th}	[$^{\circ}C/W$]
13	Heat capacitance of the filament ²⁾	C_{th}	[$Ws/^{\circ}C$]
398	Setting for an internal / external braking resistor 0 ... internal (default) 1 ... external Information: Switching is only possible during the ACOPOSmulti drive system initialization phase.	---	---

Table 189: ParIDs for setting external braking resistor parameters

- 1) Total thermal resistance $R_{thtotal}$ for series or parallel connection of several (n_{Br}) of the same braking resistors:

$$R_{thtotal} = \frac{R_{th}}{n_{Br}}$$

- 2) Total heat capacitance of the filament $C_{thtotal}$ for series or parallel connection of several (n_{Br}) of the same braking resistors:

$$C_{thtotal} = C_{th} \cdot n_{Br}$$

The parameters can normally be found on the data sheet from the respective manufacturer. ¹⁾

The parameters are based on the following thermal equivalent circuit for the external braking resistor:

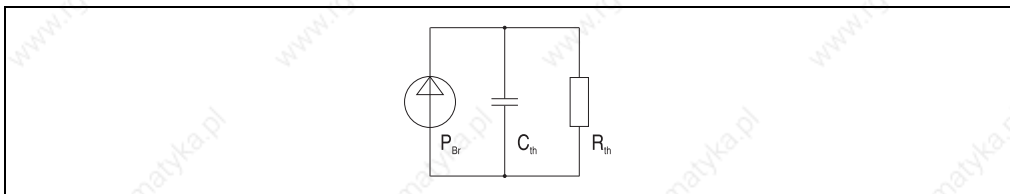


Figure 94: Thermal equivalent circuit for the external braking resistor

If a value for the maximum over-temperature T_{BRmax} of the external braking resistor is not given, it can be determined using the following formula:

$$T_{BRmax} = P_{BRN} \cdot R_{th}$$

- 1) An example of reliable braking resistors are Σ SIGMA type braking resistors (www.danothem.com).

4. Cooling water circuit

4.1 Cooling system

In principle, both atmospherically open as well as closed cooling systems can be used.

Caution!

Direct contact of the cooling medium with ambient air should generally be avoided because evaporation can enrich the substance of content in the cooling medium, which in turn negatively affects the cooling capacity.

Caution!

Be sure to consult the technical data for the ACOPOSmulti mounting plate 8B0MnnnnHC00.000-1 when dimensioning the cooling system (see the section "Operating conditions" in table 44 "Technical data - 8B0M mounting plates", on page 68).

4.1.1 Piping

Rust-resistant steel pipes are recommended for use in the cooling system (V2A or V4A).

4.1.2 Gaskets

Gaskets that are free of chloride, graphite and soot and that are made of Viton[®] or EPDM are recommended.

Information:

Check the cooling system for leaks after installation is complete and before initial startup of the drive system!

4.1.3 Schematic diagram of the cooling water circuit

Direct connection to an existing cooling circulation system

If the system already contains a cooling water circuit whose cooling medium does not meet the requirements as specified in section 4.2.2 "Hydrologic data", on page 360, it can be directly connected with the cooling water circuit of the ACOPOSmulti mounting plate 8B0MnnnnHC00.000-1.

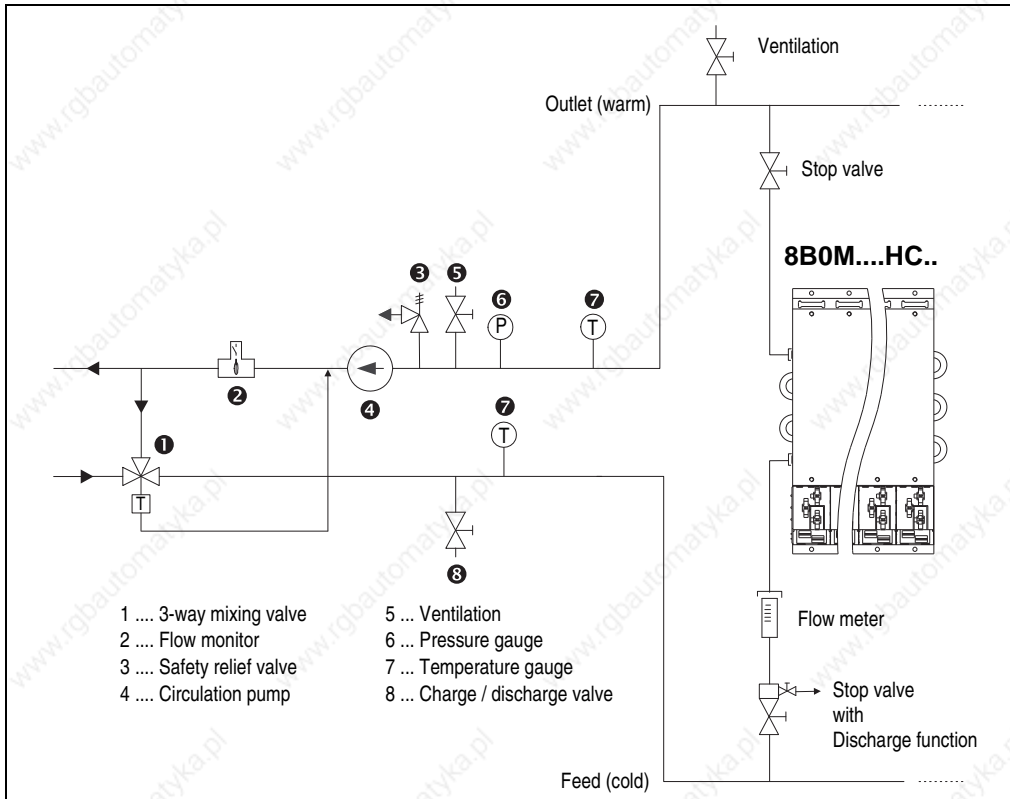


Figure 95: Schematic diagram of the cooling circuit (direct connection)

Information:

This schematic diagram represents a maximum version. Depending on local conditions and on the design of the existing cooling circulation system, some of the displayed components can be left out in certain circumstances.

Dimensioning • Cooling water circuit

Using stop valves in the feed and outlet to connect the ACOPOSmulti mounting plate 8B0MnnnnHC00.000-1 makes it possible to replace the mounting plate without completely emptying the cooling system.

Connecting the feed and outlet to the ACOPOSmulti mounting plate 8B0MnnnnHC00.000-1:
See Figure 50 "Dimension diagram and installation dimensions - 8B0MnnnnHC00.000-1", on page 285, Details Y and Z.

Caution!

The feed (cold) must be connected to the bottom connector of the ACOPOSmulti mounting plate 8B0MnnnnHC00.000-1.

The drain (warm) must be connected to the top connector of the ACOPOSmulti mounting plate 8B0MnnnnHC00.000-1.

Warning!

Parts of the cooling circuit can reach very high temperatures. Improper handling of the cooling circuit carries the risk of burns!

Therefore, the ACOPOSmulti mounting plate 8B0MnnnnHC00.000-1 can only be replaced after the cooling water circuit has cooled off! Protective equipment should be used if necessary (protective gloves, etc.).

Water-water heat exchanger

If the system already contains a cooling water circuit whose cooling medium does not meet the requirements as specified in section 4.2.2 "Hydrologic data", on page 360, it can be connected with the cooling water circuit of the ACOPOSmulti mounting plate 8B0MnnnnHC00.000-1 via a water-water heat exchanger.

Information:

Please refer to the user documentation of the water-water heat exchanger!

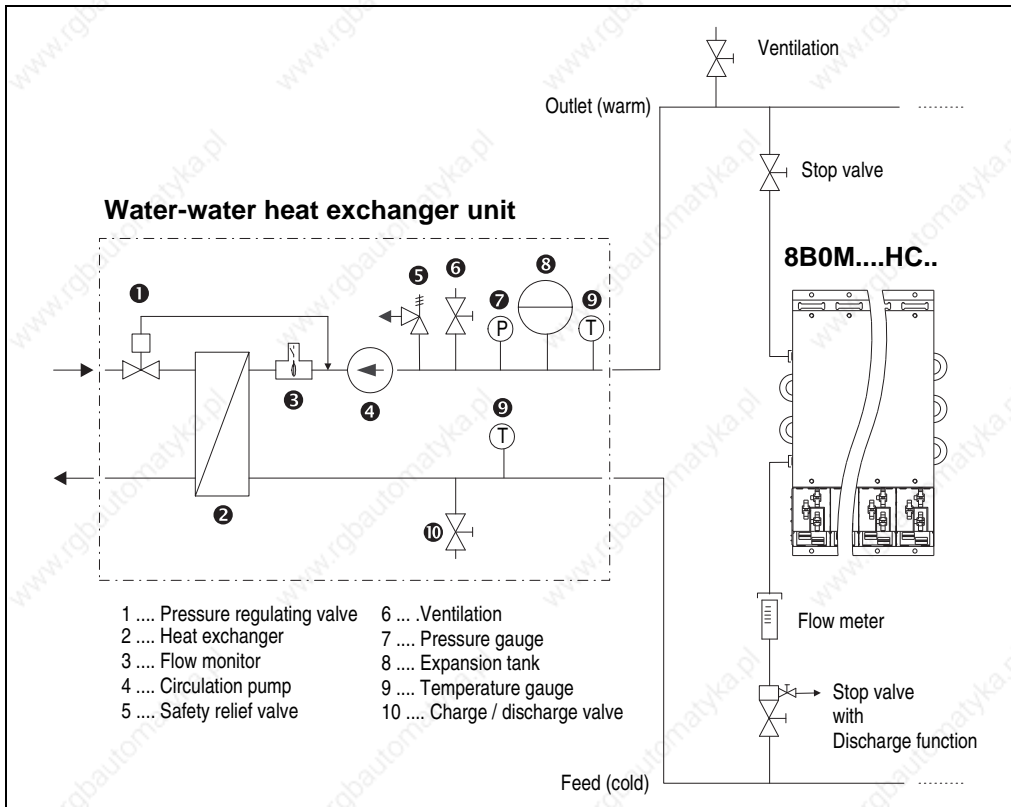


Figure 96: Schematic diagram of the cooling circuit (water-water heat exchanger)

Using stop valves in the feed and outlet to connect the ACOPOSmulti mounting plate 8B0MnnnnHC00.000-1 makes it possible to replace the mounting plate without completely emptying the cooling system.

Dimensioning • Cooling water circuit

Connecting the feed and outlet to the ACOPOSmulti mounting plate 8B0MnnnnHC00.000-1:

See Figure 50 "Dimension diagram and installation dimensions - 8B0MnnnnHC00.000-1", on page 285, Details Y and Z.

Caution!

The feed (cold) must be connected to the bottom connector of the ACOPOSmulti mounting plate 8B0MnnnnHC00.000-1.

The drain (warm) must be connected to the top connector of the ACOPOSmulti mounting plate 8B0MnnnnHC00.000-1.

Connecting the water-water heat exchanger:

Please refer to the user documentation provided by manufacturer.

Warning!

Parts of the cooling circuit can reach very high temperatures. Improper handling of the cooling circuit carries the risk of burns!

Therefore, the ACOPOSmulti mounting plate 8B0MnnnnHC00.000-1 can only be replaced after the cooling water circuit has cooled off! Protective equipment should be used if necessary (protective gloves, etc.).

Information:

Continuous monitoring of the circulation pump is recommended to ensure proper cooling function.

Air-water heat exchanger

If the system does not contain a cooling water circuit, then the ACOPOSmulti mounting plate's cooling medium can be cooled via an air-water-heat exchanger.

Information:

Please refer to the 8B0MnnnnHC00.000-1 ACOPOSmulti mounting plate's technical data and the user documentation of the air-water-heat exchanger!

The air-water heat exchanger unit must be dimensioned in such a way so that the incidental heat can be safely dissipated, even under unfavorable boundary conditions.

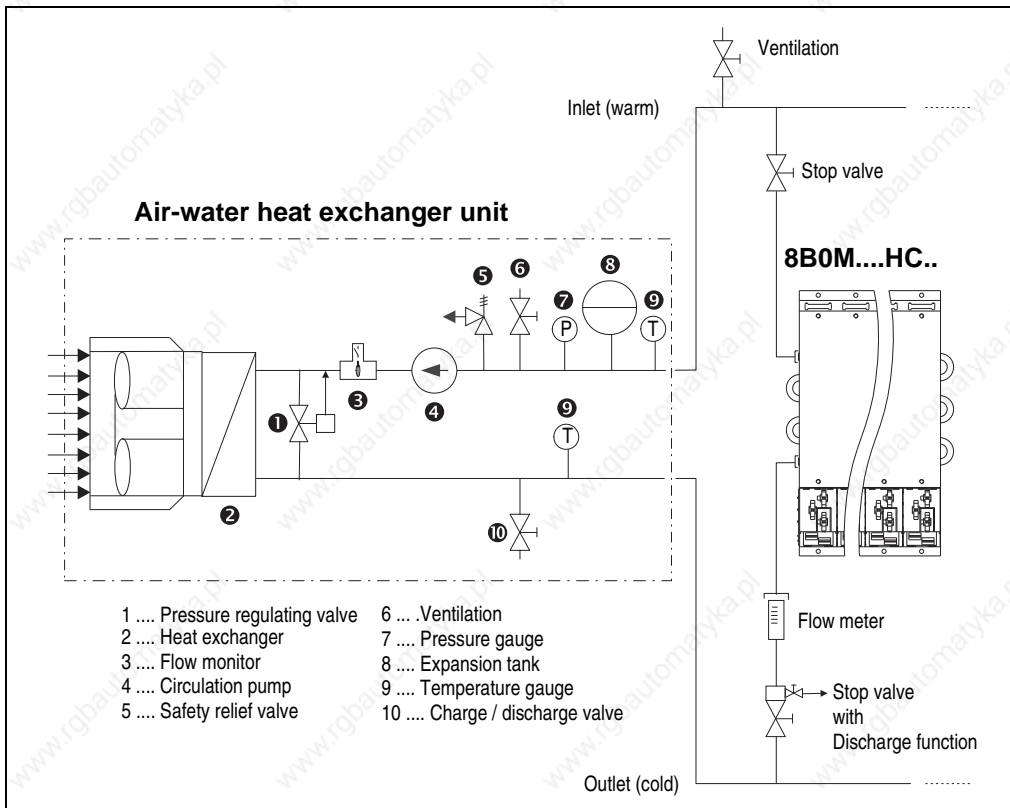


Figure 97: Schematic diagram of the cooling circuit (water-water heat exchanger)

Using stop valves in the feed and outlet to connect the ACOPOSmulti mounting plate 8B0MnnnnHC00.000-1 makes it possible to replace the mounting plate without completely emptying the cooling system.

Connecting the feed and outlet to the ACOPOSmulti mounting plate 8B0MnnnnHC00.000-1:

See Figure 50 "Dimension diagram and installation dimensions - 8B0MnnnnHC00.000-1", on page 285, Details Y and Z.

Caution!

The feed (cold) must be connected to the bottom connector of the ACOPOSmulti mounting plate 8B0MnnnnHC00.000-1.

The drain (warm) must be connected to the top connector of the ACOPOSmulti mounting plate 8B0MnnnnHC00.000-1.

Connecting the air-water heat exchanger:

Please refer to the user documentation provided by manufacturer.

Warning!

Parts of the cooling circuit can reach very high temperatures. Improper handling of the cooling circuit carries the risk of burns!

Therefore, the ACOPOSmulti mounting plate 8B0MnnnnHC00.000-1 can only be replaced after the cooling water circuit has cooled off! Protective equipment should be used if necessary (protective gloves, etc.).

Information:

Continuous monitoring of the circulation pump is recommended to ensure proper cooling function.

4.2 Cooling medium

The cooling medium must be clean, chemically neutral and free of particulate matter.

The following can be used as cooling medium:

- Tap water (an admixture of demineralized water is possible for adhering to the hydrologic data - see the section 4.2.2 "Hydrologic data", on page 360).
- A mix of tap water and max. 20 - 30% antifreeze agent (the antifreeze agent Antifrogen N from Clariant (www.clariant.com) is recommended).
This ensures antifreeze protection down to approximately -10°C.

Warning!

**Antifreeze agents are hazardous to your health!
Seek immediate medical attention if swallowed.**

Information:

Certain cooling agents cannot be mixed together.

If some of the cooling medium must be refilled or replaced, then the same cooling medium must be used that is already being used in the cooling system!

Caution!

A mixture of water and antifreeze agent with Antifrogen N can only be refilled/replaced in the specified mixing ratio. A concentration of Antifrogen N in the cooling medium that is too strong will eventually begin to corrode pump seals, thereby negatively affecting the cooling system seal!

4.2.1 Preparation and maintenance

Different demands are placed on the purity of the cooling medium depending on the application. If the cooling medium does not have a sufficient level of purity, then various methods can be used to remove impurities:

Type of impurity	Method of removal
Mechanical impurity	Filtering the cooling medium with various types of filters
Hardness degree of cooling medium is too high	Softening via ion exchange
Minor mechanical impurity and a low percentage of hardness ions	Offsetting the cooling medium with stabilizers and dispersing agents
Minor chemical impurities	Offsetting the cooling medium with passivators/inhibitors
Minor biological impurities (algae, bacteria, etc.)	Offsetting the cooling medium with biocides

Table 190: Overview of methods for removing impurities in the cooling medium

4.2.2 Hydrologic data

Information:

The VEB cooling water guidelines (VGB-R 455 P) must be followed in order to avoid problems in the cooling water circuit.

The amount of solutes in the cooling medium increases during heat exchange due to evaporation of the cooling medium. This also increases the conductivity, which causes the cooling medium to become more corrosive. This effect can be reduced by refilling an according amount of fresh cooling medium; It is also recommended to remove some of the enriched cooling medium when doing this.

The cooling medium should exhibit only minor hardness, to prevent deposits from building up in the cooling system. On the other hand, water that is too soft negatively affects the materials in the cooling system.

Information:

The quality of the cooling medium must be checked periodically to prevent impairment of the cooling capacity and/or damage to the cooling circuit!

The cooling medium properties should not deviate from the following hydrologic data:

Hydrologic data	CuAl
pH value	7 to 8.5
Carbon hardness	3 to 8 °dH
Free carbonic acids	8 to 15 mg/l
Sulfides	---
Oxygen	<10 mg/l
Chloride ions	<50 mg/l
Sulfate ions	<250 mg/l
Nitrates and nitrites	<10 mg/l
CSB	<7 mg/l
Ammonia	<5 mg/l
Iron	<0.2 mg/l
Manganese	<0.2 mg/l
Conductivity	<2200 µS/cm
Evaporation residue	<500 mg/l
Potassium permanganate consumption	<25 mg/l
Particulate matter	<3 mg/l

Table 191: Hydrologic data

4.2.3 Corrosion protection

Metallic objects (e.g. screws, etc.) in the cooling circuit must be made of one material that features a minimal voltage difference to the mounting plate material because otherwise contact corrosion and/or pitting corrosion can occur (also see table 192 "Electrochemical series, standard potential against hydrogen").

Item	Refined ion	Standard potential	Item	Refined ion	Standard potential
Lithium	Li+	-3.04 V	Cobalt	Co ²⁺	-0.28 V
Potassium	K+	-2.39 V	Nickel	Ni ²⁺	-0.25 V
Calcium	Ca ²⁺	-2.87 V	Tin	Sn ²⁺	-0.14 V
Sodium	Na+	-2.71 V	Lead	Pb ³⁺	-0.13 V
Magnesium	Mg ²⁺	-2.38 V	Iron	FE ³⁺	-0.037 V
Titanium	Ti ²⁺	-1.75 V	Hydrogen	2H+	0.00 V
Aluminum	Al ³⁺	-1.67 V	Copper	Cu ²⁺	0.34 V
Manganese	Mn ²⁺	-1.05 V	Carbon	C ²⁺	0.74 V
Zinc	Zn ²⁺	-0.76 V	Silver	Ag+	0.80 V
Chrome	Cr ³⁺	-0.71 V	Platinum	Pt ²⁺	1.20 V
Iron	Fe ²⁺	-0.44 V	Gold	Au ³⁺	1.42 V
Cadmium	Cd ²⁺	-0.40 V	Gold	Au+	1.69 V

Table 192: Electrochemical series, standard potential against hydrogen

Information:

B&R recommends the use of brass or plastic screws. Other materials must be checked by the user according to application. B&R is not liable for any damages caused by corrosion resulting from improperly used materials.

Warning!

Corrosion can cause damages in the coolant circuit, which can result in failure of the entire cooling system!

The cooling medium that is used must exhibit suitable properties to avoid corrosion (also see the section 4.2.2 "Hydrologic data", on page 360).

Information:

If the antifreeze agent Antifrogen N is used in the recommended concentration (20 - 30 %), then the assumption can be made that the corrosion protection is sufficient.

4.2.4 Biocide additive

Information:

If the antifreeze agent Antifrogen N is used in the recommended concentration (20 - 30 %), then the assumption can be made that the level of biocide effectiveness is sufficient.

4.2.5 Condensation

Condensation can occur if the input temperature of the cooling medium in the mounting plate is below the ambient temperature. The occurrence of condensation depends on the dew point of the air around the mounting point.

The dew point temperature depends on humidity and installation altitude and can be determined using the following diagram:

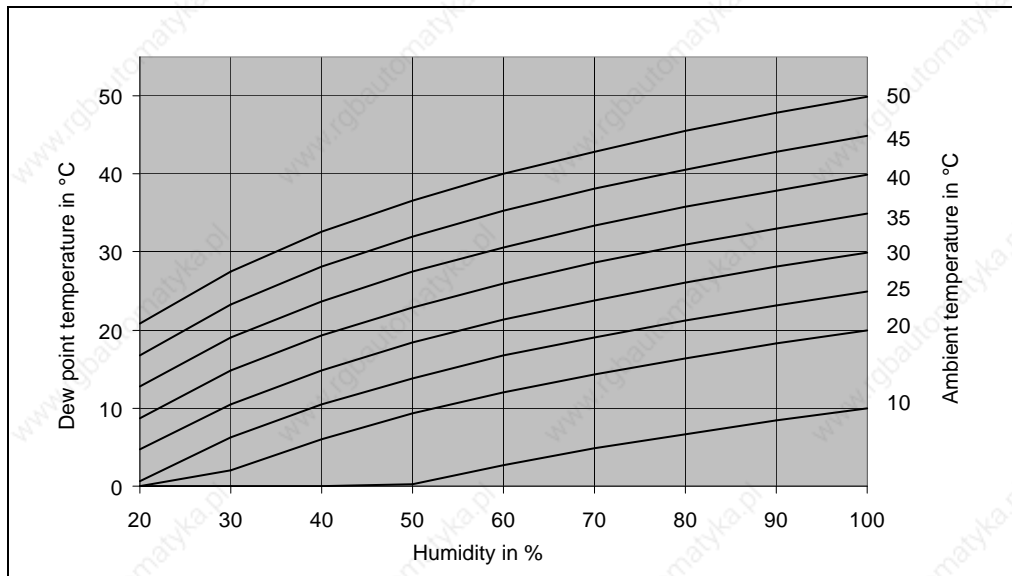


Figure 98: Dew point temperature characteristic (installation altitude: 0 ... 500 m)

The diagram illustrates characteristic curves for the dew point temperature at different ambient temperatures. A reading can now be made of the corresponding value for the dew point temperature according to the ambient temperature.

Example

According to the diagram, the dew point temperature at an ambient temperature of 40°C and a relative humidity of 60 % is approximately 31°C.

Therefore, the input temperature of the cooling medium in the mounting plate must be higher than 31°C to safely eliminate condensation.

Information:

Condensation does not occur in environments with common air temperatures and air pressures when the input temperature of the cooling medium is > 35 ... 40°C.

Potential measures for preventing condensation

- Include a temperature-controlled valve device in the cooling circuit
- The temperature of the cooling medium is adjusted according to the ambient temperature (coolant temperature regulation; preferred at high room temperatures and high relative humidity)
- Dehumidify the ambient air:
Condensation of air moisture on an air-water heat exchanger that is operated with the cold cooling medium.
- Use of switching cabinet heaters

5. Dimensioning cooling systems for cooling switching cabinets

5.1 General dimensioning criteria

- What are the environmental conditions where the switching cabinet will be located (ambient temperature T_A , humidity, installation altitude above sea level)?
- How is the air circulation (intake and outlet) where the switching cabinet will be located? Particularly small spaces can become significantly warmer due to the heat dissipation from a cooling device.
- Is the ambient air clean or contaminated with dust, oil, etc?
- Which type of switching cabinet installation is intended according to DIN 57660 part 500?
- Is the switching cabinet open (allowing air flow) or closed (no air flow)? Switching cabinets that are closed (no air flow) can only dissipate power loss via the switching cabinet walls.
- What kind of material are the switching cabinet walls made of (specification of the heat transfer coefficient k)?
- What is the switching cabinet's minimum required level of protection according to EN 60529?
- How high is the specified internal temperature T_{Iset} of the switching cabinet? This value must be lower than the lowest permissible ambient temperature of all components used in the switching cabinet.
- Is a coolant circulation available where the switching cabinet is located?
- Is the maximum ambient temperature T_{Amax} lower than the desired internal temperature T_{Iset} of the switching cabinet?

5.1.1 Basic selection of the cooling system

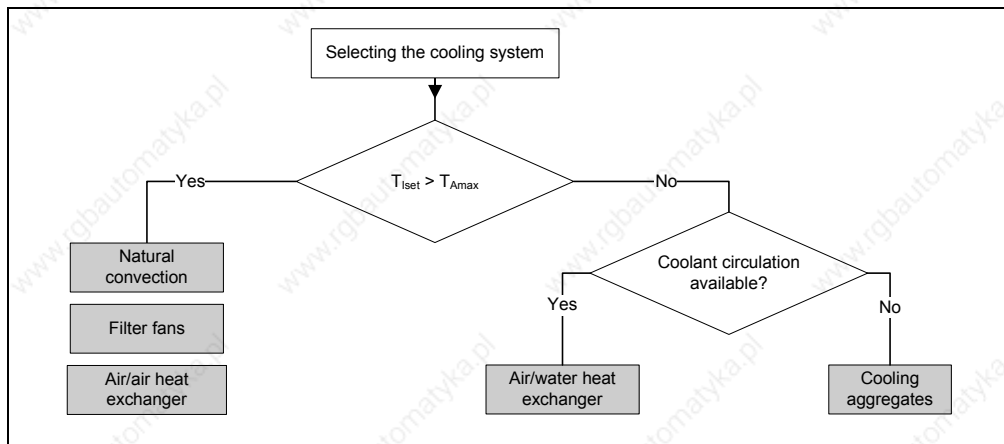


Figure 99: Basic selection of the cooling system

5.2 Natural convection

The power loss is emitted outwards via the switching cabinet walls.

Information:

The ambient temperature T_A must be considerably lower than the internal temperature T_I of the switching cabinet.

The heat capacity emitted from the switching cabinet to the environment depends decisively on the location where the switching cabinet is installed: A housing located in an open space can emit more heat to its environment than a housing that is mounted to a wall or built into a recess.

The calculation of the effective switching cabinet surface A depending on the type of switching cabinet installation is determined in DIN VDE 57 660 part 500 or IEC 890 (and VDE 0660 part 890):

Mounting arrangement according to IEC 890	Formula for calculating A [m ²] ¹⁾
Detached single cabinet, free-standing on all sides	$A = 1.8 \times H \times (B + T) + 1.4 \times B \times T$
Single cabinet, against a wall	$A = 1.4 \times W \times (H + D) + 1.8 \times D \times H$
First or last cabinet, detached on three sides	$A = 1.4 \times D \times (H + W) + 1.8 \times W \times H$
First or last cabinet, against a wall	$A = 1.4 \times H \times (B + T) + 1.4 \times B \times T$
Middle cabinet, detached on two sides	$A = 1.8 \times B \times H + 1.4 \times B \times T + T \times H$
Middle cabinet, against a wall	$A = 1.4 \times W \times (H + D) + D \times H$
Middle cabinet, against a wall, with covered roof	$A = 1.4 \times B \times H + 0.7 \times B \times T + T \times H$

Table 193: Calculation of the effective switching cabinet surface A (DIN VDE 57 660 part 500 or IEC 890)

1) B ... Switching cabinet width [m]; H ... Switching cabinet height [m]; D ... Switching cabinet depth [m].

5.2.1 Dimensioning

- 1) Determining the power loss Q_V of all devices in the switching cabinet
- 2) Calculating the effective switching cabinet surface A
- 3) Calculating the switching cabinet's maximum internal temperature $T_{I\max}$: ¹⁾

$$T_{I\max} = \frac{Q_V}{k \cdot A} + T_A$$

The switching cabinet's maximum internal temperature $T_{I\max}$ must be lower than the maximum ambient temperature of the components used inside the switching cabinet.

1) k ... Heat transfer coefficient [W/m²K]; for steel panel: $k = 5.5$

If the power loss Q_V in the switching cabinet is unknown, the actual power loss can be calculated by measuring T_A and T_I :

$$Q_V = A \cdot k \cdot (T_{I\max} - T_A)$$

5.2.2 Example ¹⁾

An ACOPOSmulti drive system is built into the following modules:

- 1x 8BVF0880H000.000-1
- 1x 8BVR0880H000.100-1
- 1x 8BVP0880HW00.000-1
- 1x 8B0C0320HW00.002-1
- 3x 8BVI0220HWS0.000-1

The ACOPOSmulti drive system is run at a switching frequency of 10 kHz.
The power loss for all other active devices in the switching cabinet is 500 W.

The steel switching cabinet is 2 m wide, 2 m high, 1 m deep and is free-standing on all sides.
The internal temperature of the switching cabinet should not exceed 40 °C. The ambient temperature is 30 °C.

Now determine whether the power loss occurring in the switching cabinet can be dissipated by its own natural convection.

Determining the power loss of all devices in the switching cabinet

Components in the switching cabinet	Amount	Power loss per component [W] ¹⁾	Total power loss [W]
8BVF0880H000.000-1	1	470	470
8BVR0880H000.100-1	1	470	470
8BVP0880HW00.000-1	1	1943	1943
8B0C0320HW00.002-1	1	80	80
8BVI0220HWS0.000-1	3	929	2787
All other active devices	---	500	500
Sum:			6250

Table 194: Determining the power loss in the switching cabinet

1) The power loss values can be found or calculated using the Chapter 2 "Technical data". Maximum values are used in this case (continuous power and continuous current).

Calculating the effective switching cabinet surface

$$A = 1.8 \times H \times (B + T) + 1.4 \times B \times T = 1.8 \times 2 \times (2+1) + 1.4 \times 2 \times 1 = 13.6 \text{ m}^2$$

Calculating the switching cabinet's internal temperature T_I

$$T_I = \frac{Q_v}{k \cdot A} + T_A = \frac{6250}{5,5 \cdot 13,6} + 30 = 114^\circ\text{C}$$

The switching cabinet's calculated internal temperature considerably exceeds the desired internal temperature of 40 °C. Therefore, the power loss occurring inside the switching cabinet cannot be dissipated by its own natural convection. Another method must be used for cooling the switching cabinet.

1) Only valid for wall-mounted ACOPOSmulti drive systems.

5.3 Filter fans

Filter fans are also a simple type of switching cabinet cooling. The power loss is dissipated by adding the circulation of ambient air and simultaneously allowing the heated air inside the switching cabinet to flow out.

Information:

The ambient temperature T_A must be lower than the internal temperature T_I of the switching cabinet in order to use filter fans.

5.3.1 Dimensioning

- 1) Determining the power loss Q_v of all devices in the switching cabinet
- 2) Determining the switching cabinet's maximum internal temperature $T_{I_{max}}$ at nominal load or from the maximum ambient temperature of the components being used
- 3) Specification of the switching cabinet's ambient temperature T_A
- 4) Specification of the switching cabinet's installation altitude h above sea level.
Depending on the switching cabinet's installation altitude, a compensation factor f might be required, which can be found in the following table:

Installation altitude h [m]	Compensation factor f [m ³ K/Wh]
$0 \leq h \leq 100$	3.1
$100 < h \leq 250$	3.2
$250 < h \leq 500$	3.3
$500 < h \leq 750$	3.4
$750 < h \leq 1000$	3.5

Table 195: Compensation factor f depending on the switching cabinet's installation altitude

- 5) Calculation of the air flow volume V :

$$V[\text{m}^3/\text{h}] = f \cdot \frac{Q_v}{T_{I_{max}} - T_A}$$

The correct filter fan can now be selected based on the calculated air flow volume V .

Information:

The required protection level of the switching cabinet according to EN 60529 must also be taken into consideration when selecting a filter fan.

5.3.2 Example ¹⁾

An ACOPOSmulti drive system is built into the following modules:

- 1x 8BVF0880H000.000-1
- 1x 8BVR0880H000.100-1
- 1x 8BVP0880HW00.000-1
- 1x 8B0C0320HW00.002-1
- 3x 8BVI0220HWS0.000-1

The ACOPOSmulti drive system is run at a switching frequency of 10 kHz.
The power loss for all other active devices in the switching cabinet is 500 W.

The steel switching cabinet is 2 m wide, 2 m high, 1 m deep and is free-standing on all sides. The internal temperature of the switching cabinet should not exceed 40 °C. The ambient temperature is 30 °C. The switching cabinet should be installed at 800 m above sea level.

The right filter fan must be selected for this switching cabinet.

Determining the power loss of all devices in the switching cabinet

Components in the switching cabinet	Amount	Power loss per component [W] ¹⁾	Total power loss [W]
8BVF0880H000.000-1	1	470	470
8BVR0880H000.100-1	1	470	470
8BVP0880HW00.000-1	1	1943	1943
8B0C0320HW00.002-1	1	80	80
8BVI0220HWS0.000-1	3	929	2787
All other active devices	---	500	500
Sum:			6250

Table 196: Determining the power loss in the switching cabinet

1) The power loss values can be found or calculated using the Chapter 2 "Technical data". Maximum values are used in this case (continuous power and continuous current).

Calculation of the air flow volume V

The compensation factor f can be taken from table 195 "Compensation factor f depending on the switching cabinet's installation altitude", on page 367 and is equal to 3.5 m³K/Wh.

This results in an air flow volume of

$$V = f \cdot \frac{Q_v}{T_{\text{Imax}} - T_A} = 3,5 \cdot \frac{6250}{40 - 30} = 2188 \text{ m}^3/\text{h}$$

The correct filter fan can now be selected based on the determined air flow volume.

1) Only valid for wall-mounted ACOPOSmulti drive systems.

5.4 Air/air heat exchanger

Air/air heat exchangers dissipate the power loss from the switching cabinet using two hermetically isolated air currents in the opposing current principle. This prevents dust, oil and other (aggressive) materials in the ambient air from permeating the switching cabinet.

Information:

The ambient temperature T_A must be lower than the internal temperature T_I of the switching cabinet in order to use air/air heat exchangers.

5.4.1 Dimensioning

- 1) Determining the power loss Q_v of all devices in the switching cabinet
- 2) Determining the switching cabinet's maximum internal temperature $T_{I_{max}}$ at nominal load or from the maximum ambient temperature of the components being used
- 3) Specification of the switching cabinet's ambient temperature T_A
- 4) Calculating the effective switching cabinet surface A
- 5) Calculating the specific heat capacity q_W : ¹⁾

$$q_W \left[\frac{W}{K} \right] = \frac{Q_v - (A \cdot (T_{I_{max}} - T_A) \cdot k)}{T_{I_{max}} - T_A}$$

The right air/air heat exchanger can be selected based on the specific heat capacity q_W .

Information:

The required protection level of the switching cabinet according to EN 60529 must also be taken into consideration when selecting an air/air heat exchanger.

1) k ... Heat transfer coefficient [W/m²K]; for steel panel: k = 5.5

5.4.2 Example ¹⁾

An ACOPOSmulti drive system is built into the following modules:

- 1x 8BVF0880H000.000-1
- 1x 8BVR0880H000.100-1
- 1x 8BVP0880HW00.000-1
- 1x 8B0C0320HW00.002-1
- 3x 8BVI0220HWS0.000-1

The ACOPOSmulti drive system is run at a switching frequency of 10 kHz.
The power loss for all other active devices in the switching cabinet is 500 W.

The steel switching cabinet is 2 m wide, 2 m high, 1 m deep and is free-standing on all sides.
The internal temperature of the switching cabinet should not exceed 40 °C. The ambient temperature is 30 °C.

The right air/air heat exchanger must be selected for this switching cabinet.

Determining the power loss of all devices in the switching cabinet

Components in the switching cabinet	Amount	Power loss per component [W] ¹⁾	Total power loss [W]
8BVF0880H000.000-1	1	470	470
8BVR0880H000.100-1	1	470	470
8BVP0880HW00.000-1	1	1943	1943
8B0C0320HW00.002-1	1	80	80
8BVI0220HWS0.000-1	3	929	2787
All other active devices	---	500	500
Sum:			6250

Table 197: Determining the power loss in the switching cabinet

1) The power loss values can be found or calculated using the Chapter 2 "Technical data". Maximum values are used in this case (continuous power and continuous current).

Calculating the effective switching cabinet surface

$$A = 1.8 \times H \times (B + T) + 1.4 \times B \times T = 1.8 \times 2 \times (2 + 1) + 1.4 \times 2 \times 1 = 13.6 \text{ m}^2$$

Calculating the specific heat capacity

The heat transfer coefficient k for steel panels is 5.5 W/m²K.

This results in a specific heat capacity q_W of

$$q_W = \frac{Q_v - (A \cdot (T_{\text{Imax}} - T_A) \cdot k)}{T_{\text{Imax}} - T_A} = \frac{6250 - (13,6 \cdot (40 - 30) \cdot 5,5)}{40 - 30} = 550,2 \frac{\text{W}}{\text{K}}$$

The right air/air heat exchanger can be selected based on the determined specific heat capacity q_W.

1) Only valid for wall-mounted ACOPOSmulti drive systems.

5.5 Air/water heat exchanger, cooling aggregates

Air/water heat exchangers and cooling aggregates dissipate the power loss via a cooling circulation system. This prevents dust, oil and other (aggressive) materials in the ambient air from permeating the switching cabinet.

5.5.1 Dimensioning

- 1) Determining the power loss Q_V of all devices in the switching cabinet
- 2) Determining the switching cabinet's maximum internal temperature $T_{I_{max}}$ at nominal load or from the maximum ambient temperature of the components being used
- 3) Specification of the switching cabinet's ambient temperature T_A
- 4) Calculating the effective switching cabinet surface A
- 5) Calculation of the required cooling capacity Q_E : ¹⁾

$$Q_E[W] = Q_V - (A \cdot (T_{I_{max}} - T_A) \cdot k)$$

The right air/water heat exchanger or cooling aggregate can now be selected based on the required cooling capacity Q_E .

Information:

The required protection level of the switching cabinet according to EN 60529 must also be taken into consideration when selecting an air/water heat exchanger or cooling aggregate.

1) k ... Heat transfer coefficient [W/m²K]; for steel panel: k = 5.5

5.5.2 Example ¹⁾

An ACOPOSmulti drive system is built into the following modules:

- 1x 8BVF0880H000.000-1
- 1x 8BVR0880H000.100-1
- 1x 8BVP0880HW00.000-1
- 1x 8B0C0320HW00.002-1
- 3x 8BVI0220HWS0.000-1

The ACOPOSmulti drive system is run at a switching frequency of 10 kHz.
The power loss for all other active devices in the switching cabinet is 500 W.

The steel switching cabinet is 2 m wide, 2 m high, 1 m deep and is free-standing on all sides.
The internal temperature of the switching cabinet should not exceed 40 °C. The ambient temperature is 30 °C.

The right air/water heat exchanger or cooling aggregate must be selected for this switching cabinet.

Determining the power loss in the switching cabinet

Components in the switching cabinet	Amount	Power loss per component [W] ¹⁾	Total power loss [W]
8BVF0880H000.000-1	1	470	470
8BVR0880H000.100-1	1	470	470
8BVP0880HW00.000-1	1	1943	1943
8B0C0320HW00.002-1	1	80	80
8BVI0220HWS0.000-1	3	929	2787
All other active devices	---	500	500
Sum:			6250

Table 198: Determining the power loss in the switching cabinet

1) The power loss values can be found or calculated using the Chapter 2 "Technical data". Maximum values are used in this case (continuous power and continuous current).

Calculating the effective switching cabinet surface

$$A = 1.8 \times H \times (B + T) + 1.4 \times B \times T = 1.8 \times 2 \times (2 + 1) + 1.4 \times 2 \times 1 = 13.6 \text{ m}^2$$

Calculation of the required cooling capacity

The heat transfer coefficient k for steel panels is 5.5 W/m²K.

This results in a required cooling capacity Q_E of

$$Q_E = Q_v - (A \cdot (T_{I_{max}} - T_A) \cdot k) = 6250 - (13,6 \cdot (40 - 30) \cdot 5,5) = 5502 \text{ W}$$

The right air/water heat exchanger or cooling aggregate can now be selected based on the determined required cooling capacity Q_E.

1) Only valid for wall-mounted ACOPOSmulti drive systems.

Chapter 5 • Wiring

1. General information

1.1 Electromagnetic compatibility of the installation

1.1.1 General information

If the directives for electromagnetic compatibility of the installation are followed, the ACOPOSmulti drive system meets the EMC directive 2004/108/EG and low-voltage directives 2006/95/CE. It meets the requirements for harmonized EMC product standard IEC 61800-3:2004 for industry (second environment).

Additional EMC measures must be implemented by the manufacturer of machines or systems if the product standards for the machine has lower limits or if the machine should conform to generic standard IEC 61000-6-4. Proof of conformity to the necessary limits must be provided according to the documentation for use of the EMC directives from the manufacturer or distributor of the machine or system.

Additional EMC measures are needed when operating ACOPOSmulti drive systems in a living area or when connecting ACOPOSmulti drive systems to a low voltage system which supplies buildings in living areas without an intermediate transformer (first environment).

1.1.2 Installation notes

- 1) The switching cabinet or the system must be constructed appropriately.
- 2) To prevent the effects of disturbances, the following lines must be properly shielded:
 - motor lines
 - encoder cables
 - control lines
 - data cables
- 3) Inductive switching elements such as contactors or relays are to be equipped with corresponding suppressor elements such as varistors, RC elements or damping diodes.
- 4) All electrical connections are to be kept as short as possible.
- 5) Cable shields are to be attached to the designated shield terminals and the plug housing.
- 6) Shielded cables with copper mesh or tinned copper mesh are to be used. Twisting or extending the protective mesh using single conductors is not allowed.
- 7) Unused cable conductors are to be grounded on both sides if possible.

1.1.3 Overview

Passive power supply

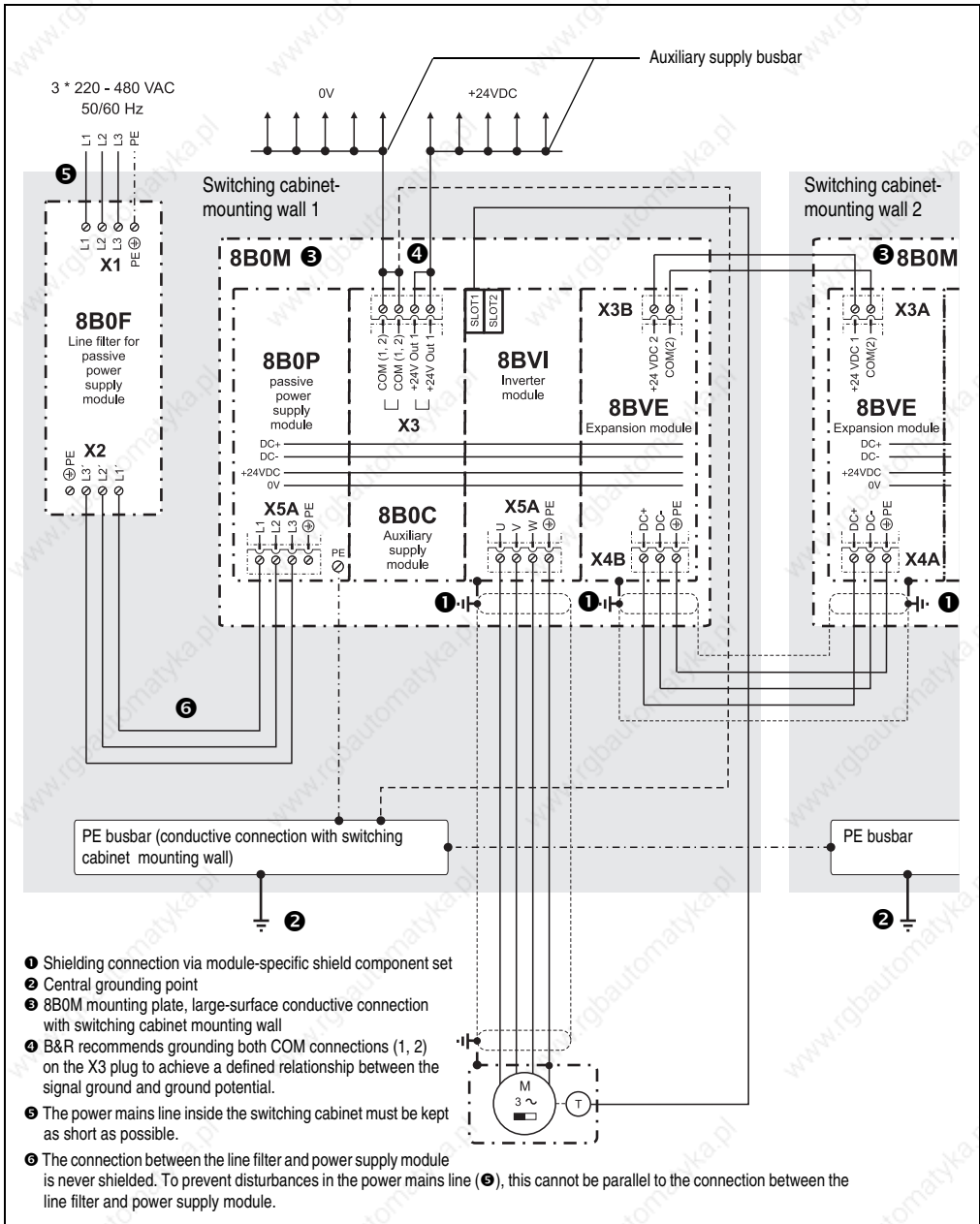


Figure 100: Overview of ground/shield for ACOPOSmulti drive system (passive power supply)

Active power supply

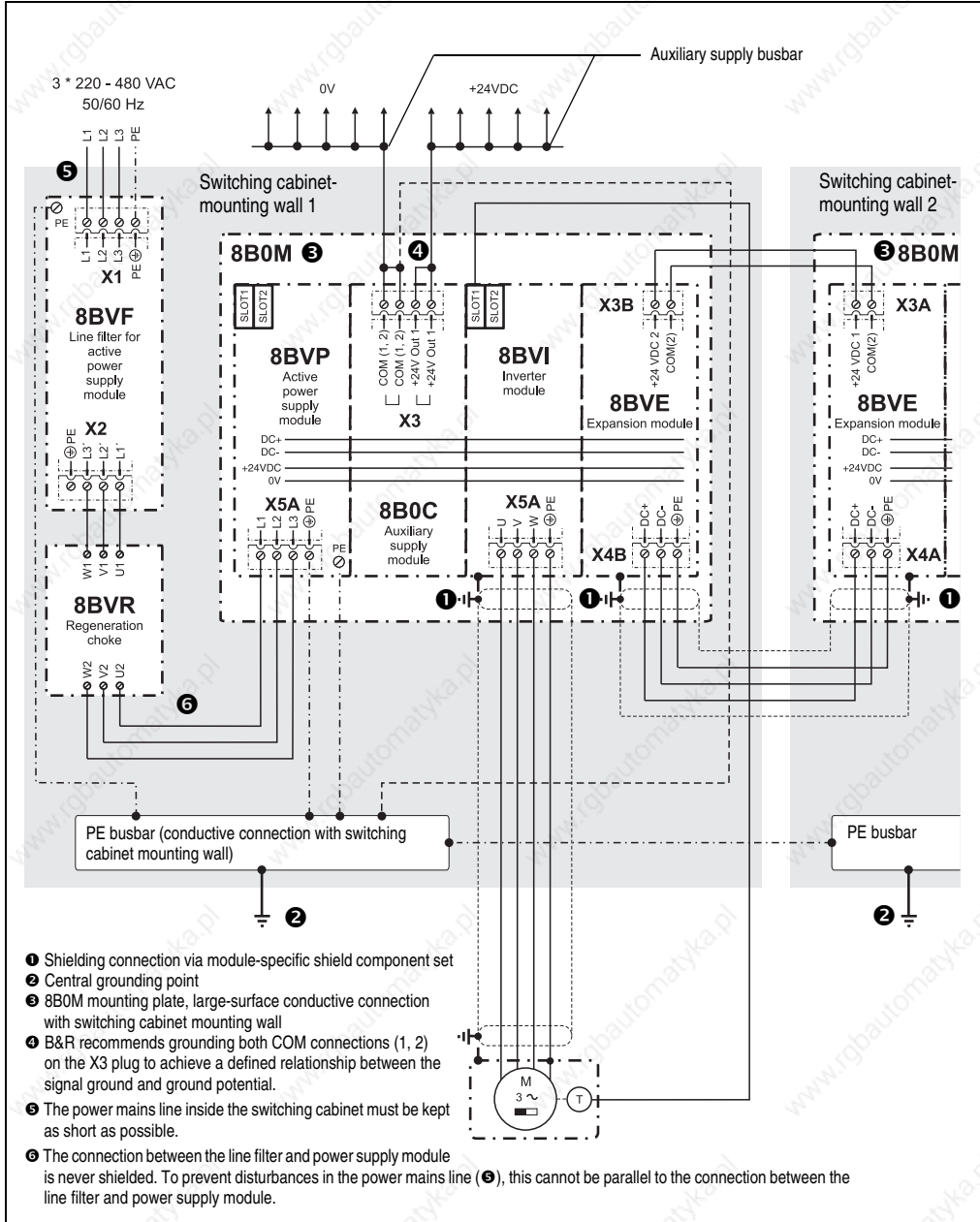


Figure 101: Overview of ground/shield for ACOPOSmulti drive system (active power supply)

1.1.4 Connection diagrams for ground and shield connections

The ground connections and shield connections for ACOPOSmulti drive system have to be made as illustrated in the following diagrams.

8B0F line filters

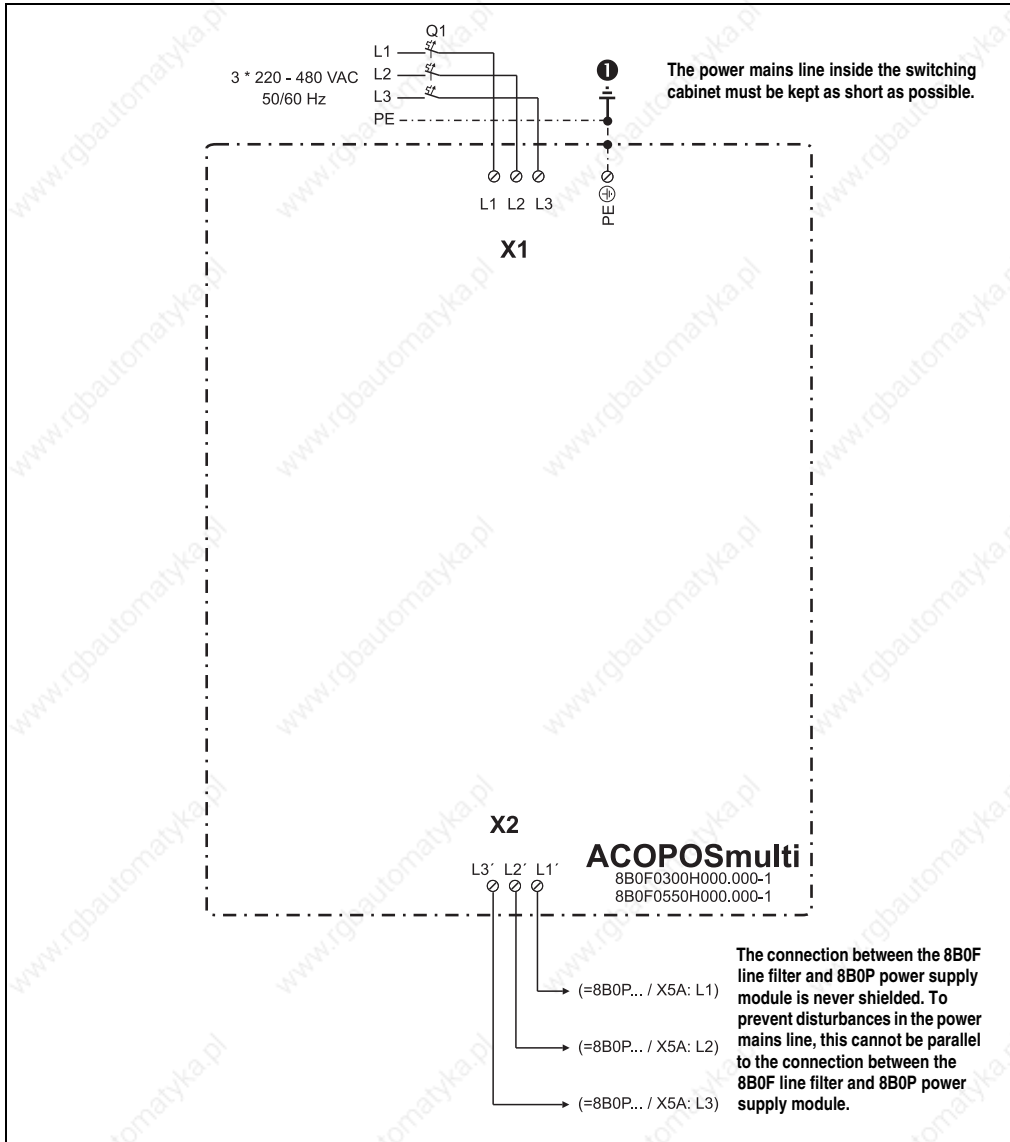


Figure 102: Ground connections and shield connections for 8B0F line filter

8B0P power supply modules

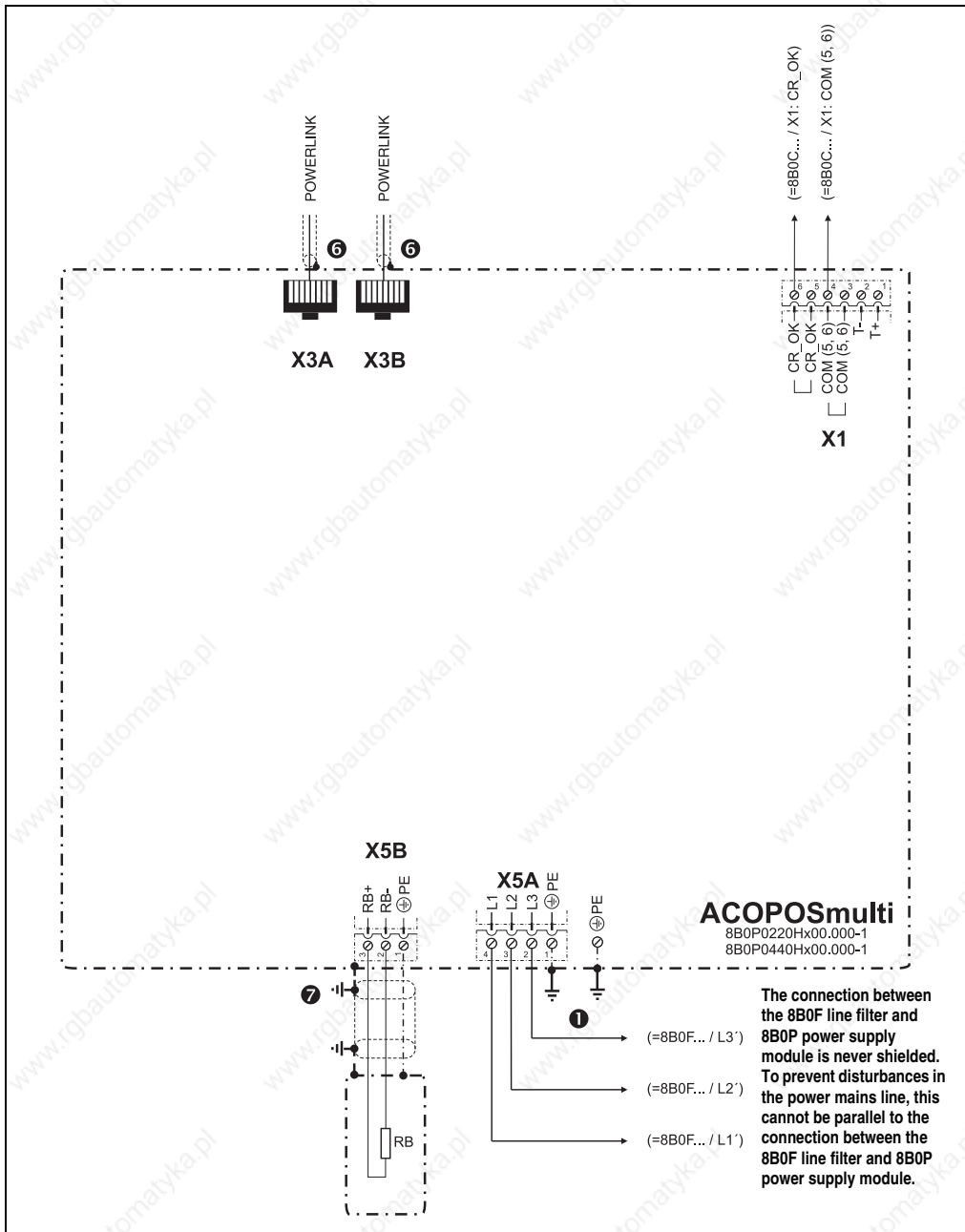


Figure 103: Ground connections and shield connections for 8B0P power supply units

8BVF line filter

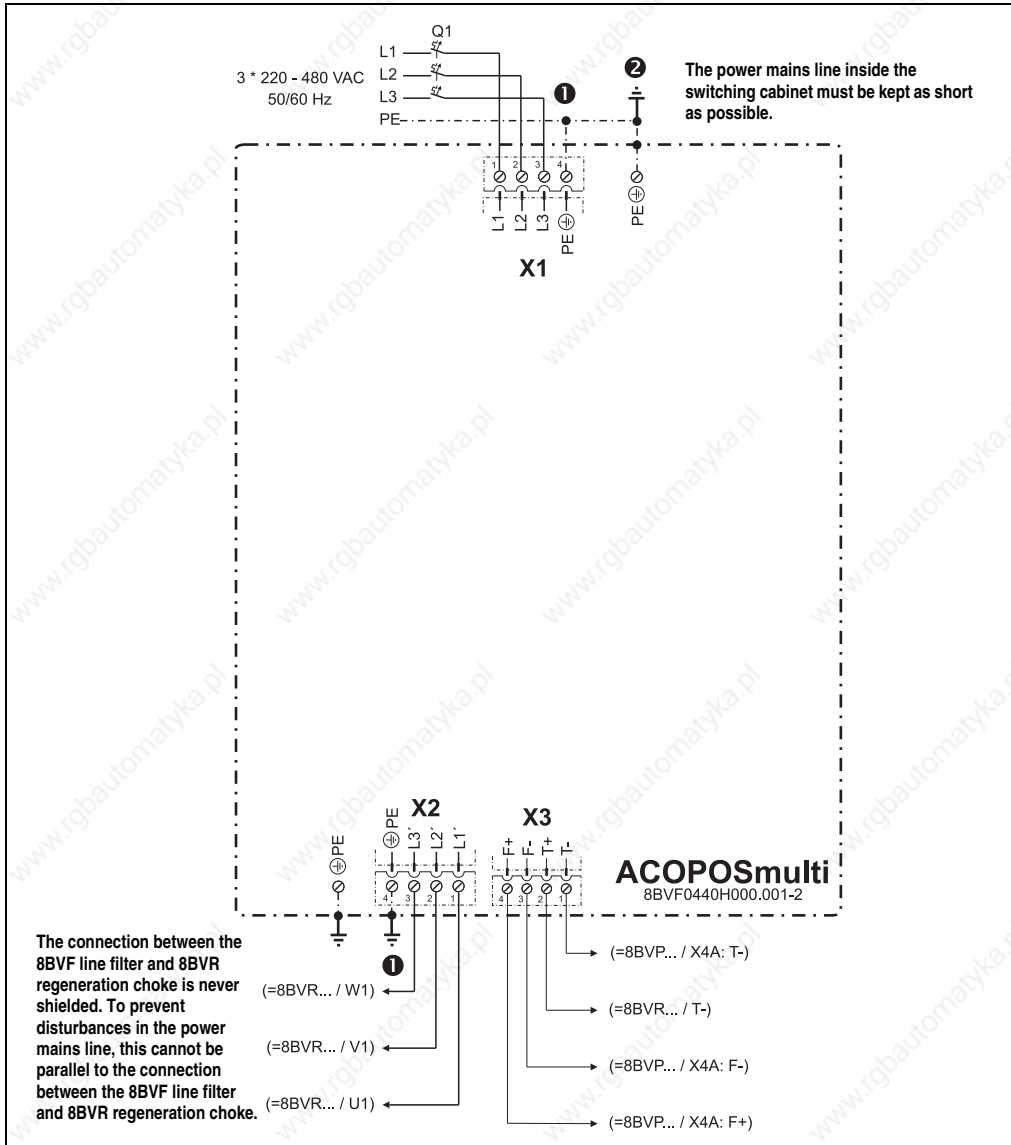


Figure 104: Ground connections and shield connections for 8BVF line filter

8BVP power supply units

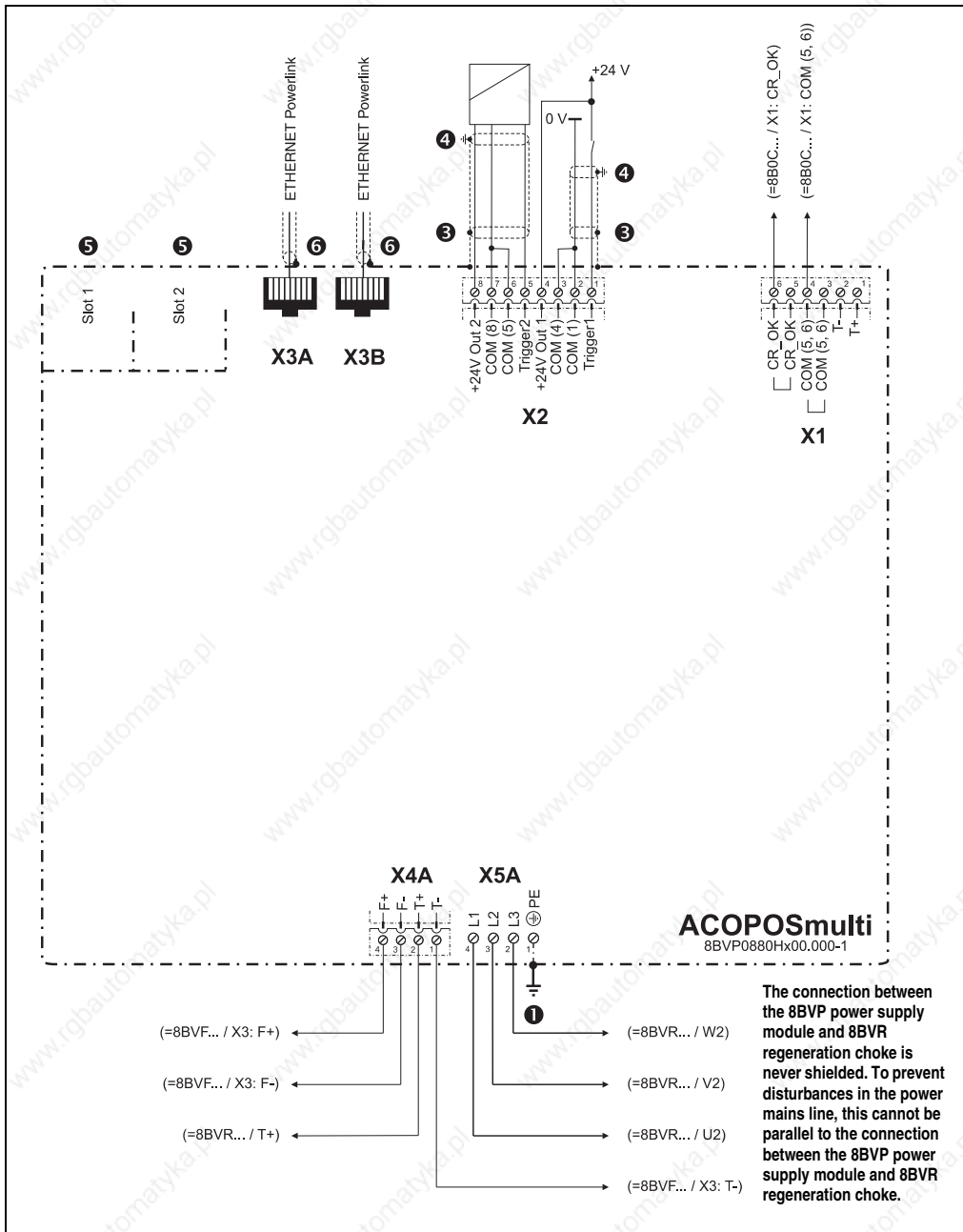


Figure 105: Ground connections and shield connections for 8BVP power supply units

8BVR regeneration chokes

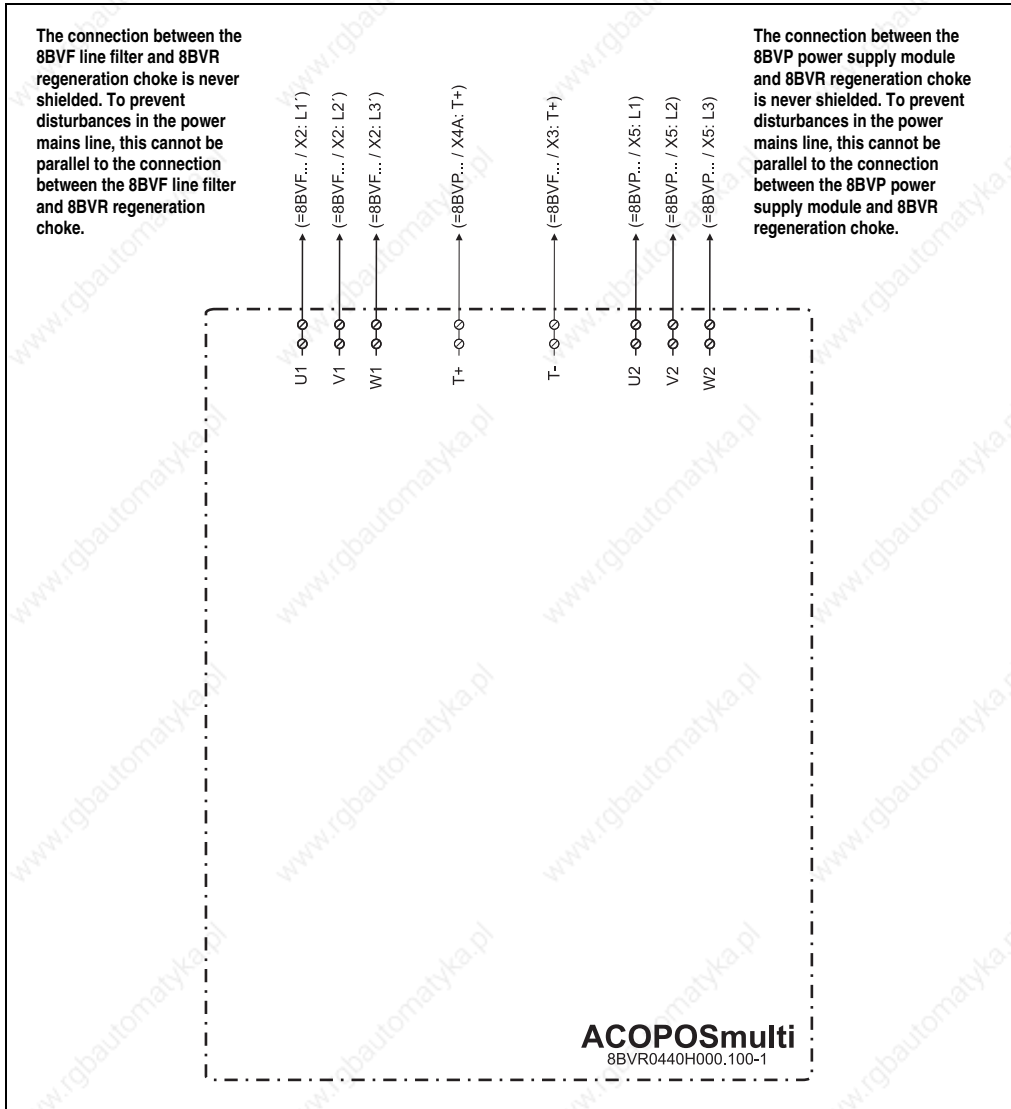


Figure 106: Ground connections and shield connections for 8BVR regeneration chokes

8B0C auxiliary supply modules

- B&R recommends grounding both COM connections (1, 2) on the X3 plug to achieve a defined relationship between the signal ground and ground potential. Alternatively, the COM (2) connection can also be grounded on the X2 plug.

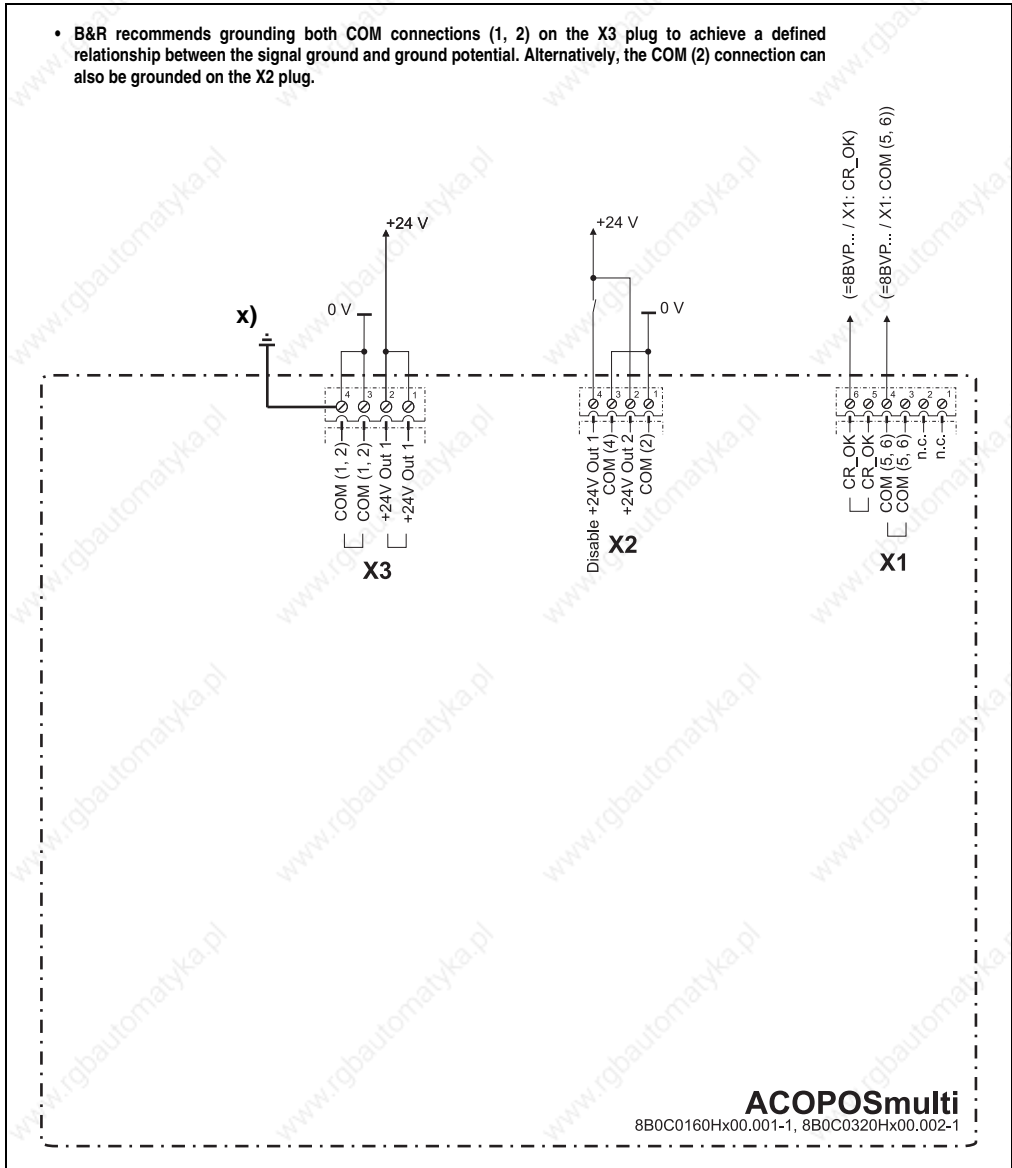


Figure 107: Ground connections and shield connections for 8B0C auxiliary supply modules

8BVI inverter modules

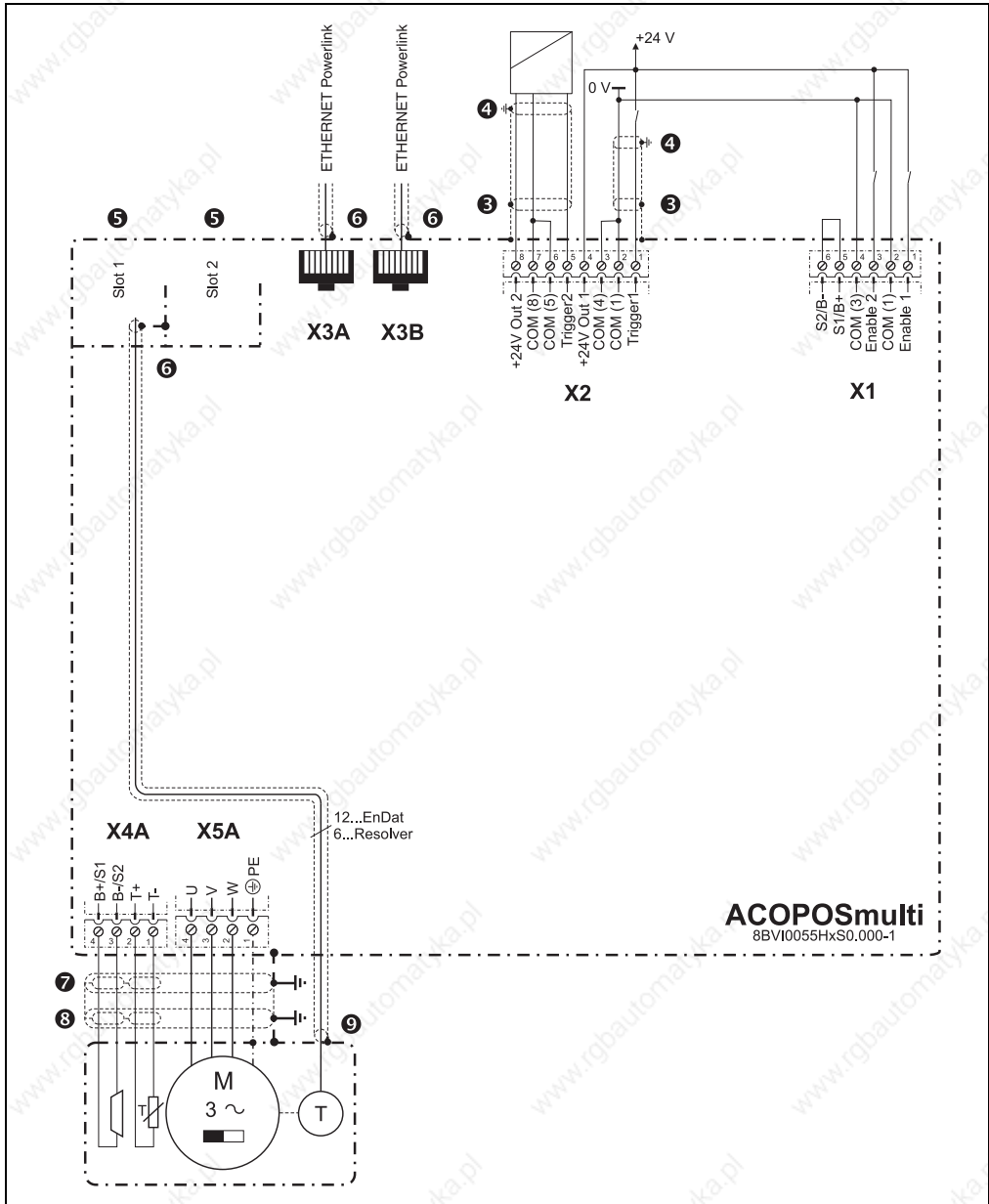


Figure 108: Ground connections and shield connections for 8BVI inverter modules

8BVE expansion modules

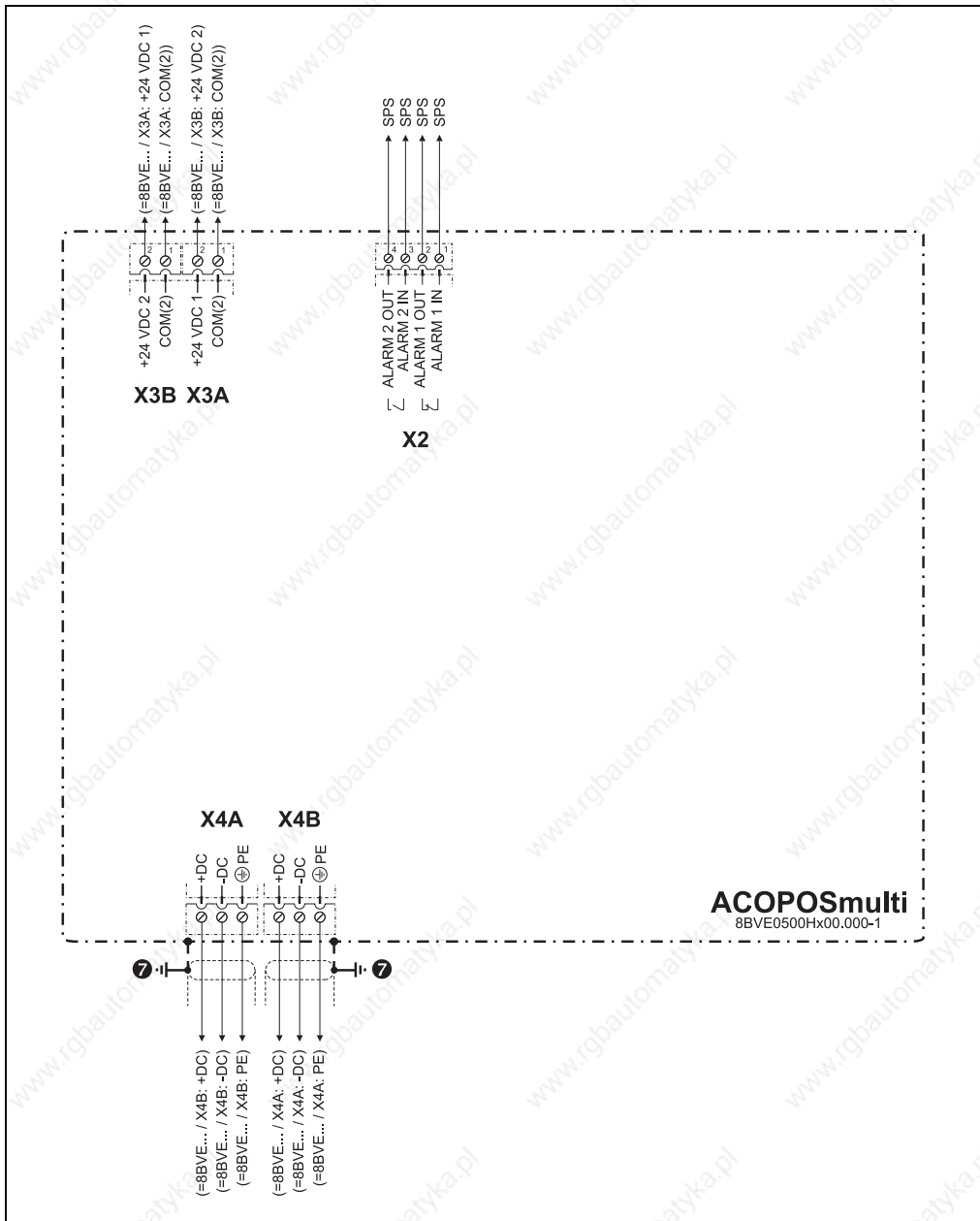


Figure 109: Ground connections and shield connections for 8BVE expansion modules

- ❶ The protective ground connection (PE) is internally connected to the respective module housing.
- ❷ The second protective ground conductor connection is required because of the increased discharge current ($> 3.5 \text{ mA}$) on the following ACOPOSmulti modules. The same cross section as the protective ground conductor for the power mains must be used:
Line filter: 8BVF0220H000.000-1; 8BVF0440H000.000-1
Power supply modules: 8BVP0220Hx00.000-1; 8BVP0440Hx00.000-1
- ❸ Both trigger inputs are only filtered internally with approx. $50 \mu\text{s}$. Make sure the cable shield is grounded properly. The optional shield set 8SCS002.0000-00 can be used with this.
- ❹ The cable shield must be attached to the shield connector.
- ❺ All mounting brackets on ACOPOSmulti plug-in modules automatically come in contact with the housing when inserted in the module slot.
 Open module slots on ACOPOSmulti modules can be closed with the optional shield set 8SCS005.0000-00 available from B&R:

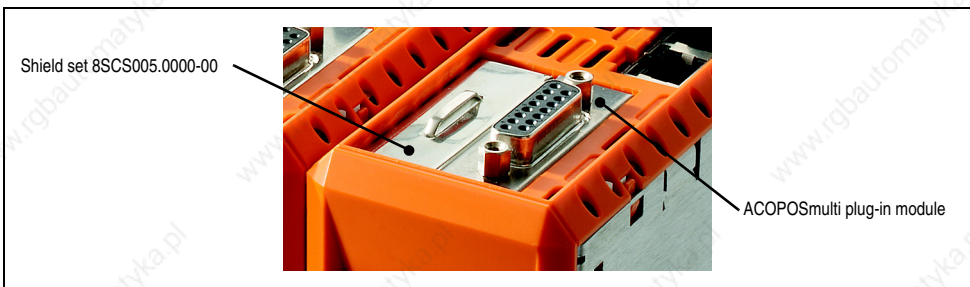


Figure 110: Use of the shield set 8SCS005.0000-00

- ❻ Cable connection via DSUB plug:
 The cable shield must be sufficiently connected using the designated clamp in the metallic or metal-plated DSUB plug housing. The DSUB plug fastening screws must be tightened.

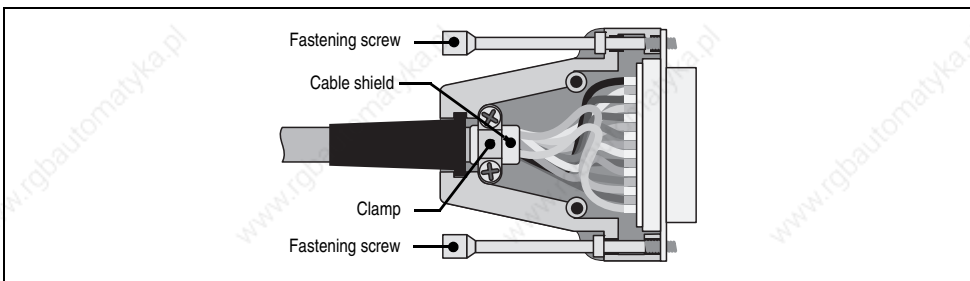


Figure 111: Cable shielding in DSUB housing

Cable connection via terminals:

Wiring • General information

The cable shield must be connected to the ACOPOSmulti module housing using the optional shield set 8SCS002.0000-00.

Cable connection via RJ45 plug:

Grounding the cable shield as well provides an improvement in EMC properties. Both sides should be properly grounded near the connector. The optional shield set 8SCS002.0000-00, available from B&R, can be used on the ACOPOSmulti module.

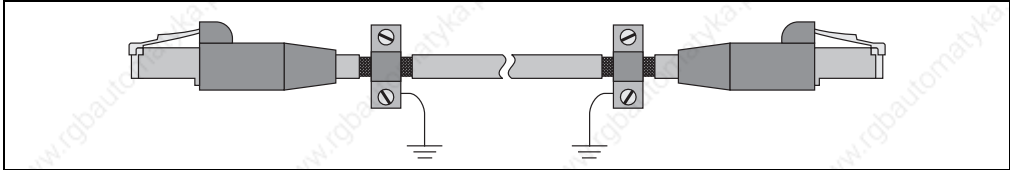


Figure 112: Grounding the POWERLINK cable shielding

Information:

When cabling POWERLINK networks with B&R POWERLINK cables, **no additional grounding of the cable shield is required to ensure resistance to disturbances in accordance with EN 61800-3!**

- 7 The cable shield can be connected with the ACOPOSmulti module housing using the optional shield sets available from B&R.
- 8 On the motor side, the cable shield for the motor line is connected to the motor housing using the motor plug and connected to ground via the machine.
- 9 On the motor side, the encoder cable shield must be connected to the motor housing using the encoder plug and connected to ground via the machine.

For external encoders, the cable shield of the encoder cable must be connected (on the encoder side) with the machine and therefore with ground using the encoder plug.

1.2 Isolation and high-voltage test

1.2.1 Insulation resistance according to EN 60204

According to EN 60204, the insulation resistance of electrical equipment is measured with 500 V DC voltage between the main circuit conductors and the protective ground conductor system and is not permitted to be below a value of 1 M Ω . Testing individual sections of the system is permitted.

Power mains connection (mains side) for ACOPOSmulti line filters (X1)

The insulation resistance test can be carried out on the ACOPOSmulti line filter power mains connection (X1) as described above; however, values > 1 M Ω are not expected because of the overvoltage protection connection of the power mains. The 50 k Ω minimum value required by the EN 60204 section 18.3 standard is exceeded.

Power mains connection (load side) for ACOPOSmulti line filters (X2)

The insulation resistance test can be carried out on the ACOPOSmulti line filter power mains connection (X2) as described above; however, values > 1 M Ω are not expected because of the overvoltage protection connection of the power mains. The 50 k Ω minimum value required by the EN 60204 section 18.3 standard is exceeded.

Connections U1 / V1 / W1 of ACOPOSmulti regeneration chokes

The insulation resistance test can be carried out on the ACOPOSmulti regeneration choke U1 / V1 / W1 connections as described above. However, values > 1 M Ω should not be expected. The 50 k Ω minimum value required by the EN 60204 section 18.3 standard is exceeded.

Connections U2 / V2 / W2 of ACOPOSmulti regeneration chokes

The insulation resistance test can be carried out on the ACOPOSmulti regeneration choke U2 / V2 / W2 connections as described above. However, values > 1 M Ω should not be expected. The 50 k Ω minimum value required by the EN 60204 section 18.3 standard is exceeded.

Power mains connection of ACOPOSmulti power supply modules (X5A)

The insulation resistance test can be carried out on the power mains connection (X5A) of ACOPOSmulti power supply modules as described above; however, values > 1 M Ω are not expected because of the overvoltage protection connection of the power mains. The 50 k Ω minimum value required by the EN 60204 section 18.3 standard is exceeded.

Motor connection of ACOPOSmulti inverter modules (X5A / X5B)

Warning!

An insulation test is not permitted to be carried out on the motor connection (X5A / X5B) of ACOPOSmulti inverter modules because that would destroy the ACOPOSmulti inverter modules!

The motor cable must be removed from the motor connection (X5A / X5B) of the ACOPOSmulti inverter module before the insulation resistance is measured!

B&R motors and B&R motor cables

In principle, an insulation resistance measurement can be carried out on B&R motor cables and B&R motors. However, the insulation resistance can be lower than 1 M Ω depending on the motor that is connected. The 50 k Ω minimum value required by the EN 60204 section 18.3 standard is exceeded.

Warning!

An insulation test is not permitted to be carried out on the motor connection (X5A / X5B) of ACOPOSmulti inverter modules because that would destroy the ACOPOSmulti inverter modules!

The motor cable must be removed from the motor connection (X5A / X5B) of the ACOPOSmulti inverter module before the insulation resistance is measured!

1.2.2 High voltage test

According to EN 60204, the electrical equipment must be able to withstand a test voltage connected between the conductors of all circuits and the protective ground conductor system for at least 1 s (exception: all circuits with a voltage < PELV voltage). The test voltage must be twice the rated voltage for the equipment, and at least 1000 VAC (50 / 60 Hz). Components that cannot handle this test voltage must be disconnected before carrying out the high voltage test.

Power mains connection (mains side) for ACOPOSmulti line filters (X1)

Warning!

A high voltage test is not permitted to be carried out on the power mains connection (X1) of ACOPOSmulti line filters because that would destroy the ACOPOSmulti line filter!

Power mains connection (load side) for ACOPOSmulti line filters (X2)

Warning!

A high voltage test is not permitted to be carried out on the power mains connection (X2) of ACOPOSmulti line filters because that would destroy the ACOPOSmulti line filter!

Connections U1 / V1 / W1 of ACOPOSmulti regeneration chokes

The high voltage test can be carried out on the ACOPOSmulti regeneration choke U1 / V1 / W1 connections as described above.

Warning!

Before performing the high voltage test on the U1 / V1 / W1 connections of the ACOPOSmulti regeneration choke, the cable between the X2 connection of the ACOPOSmulti line filter and the U1 / V1 / W1 connections of the ACOPOSmulti regeneration choke must be removed from the X2 connection of the ACOPOSmulti line filter. Otherwise the ACOPOSmulti line filter will be severely damaged!

Connections U2 / V2 / W2 of ACOPOSmulti regeneration chokes

The high voltage test can be carried out on the ACOPOSmulti regeneration choke U2 / V2 / W2 connections as described above.

Warning!

Before performing the high voltage test on the U2 / V2 / W2 connections of the ACOPOSmulti regeneration choke, the cable between the X5A connection of the ACOPOSmulti power supply module and the U2 / V2 / W2 connections of the ACOPOSmulti regeneration choke must be removed from the X5A connection of the ACOPOSmulti power supply module. Otherwise the ACOPOSmulti power supply module will be severely damaged!

Power mains connection of ACOPOSmulti power supply modules (X5A)

Warning!

A high voltage test cannot be carried out on the power mains connection (X5A) of the ACOPOSmulti power supply modules because sparks can occur that are caused by the internal wiring.

Motor connection of ACOPOSmulti inverter modules (X5A / X5B)

Warning!

A high voltage test is not permitted to be carried out on the motor connection (X5A / X5B) of ACOPOSmulti inverter modules because that would destroy the ACOPOSmulti inverter modules!

B&R motors and B&R motor cables

In principle, a high voltage test can be carried out on B&R motor cables and B&R motors. Depending on the size of the motor and length of the motor cable, increased measurement currents can occur because of capacitive coupling.

Warning!

A high voltage test is not permitted to be carried out on the motor connection (X5A / X5B) of ACOPOSmulti inverter modules because that would destroy the ACOPOSmulti inverter modules!

The motor cable must be removed from the motor connection (X5A / X5B) of the ACOPOSmulti inverter module before the high voltage measurement is made!

1.2.3 Typical procedure

Isolation test

- 1) Remove the motor cable from the X5A / X5B connection of the ACOPOSmulti inverter module.
- 2) Perform the insulation test on the X1 power mains connection (mains side) of the ACOPOSmulti line filter.
- 3) Perform the insulation test on the B&R motor.

High voltage test

- 1) Remove the connection cable between the X2 connection of the ACOPOSmulti line filter and the U1 / V1 / W1 connections of the ACOPOSmulti regeneration choke on the X2 connection of the ACOPOSmulti line filter.
- 2) Remove the connection cable between the X5A connection of the ACOPOSmulti power supply module and the U2 / V2 / W2 connections of the ACOPOSmulti regeneration choke on the X5A connection of the ACOPOSmulti power supply module.
- 3) Perform the high voltage test on the U1 / V1 / W1 connections of the ACOPOSmulti regeneration choke.
- 4) Remove the motor cable from the X5A / X5B connection of the ACOPOSmulti inverter module.
- 5) Perform the high voltage test on the B&R motor.

1.3 Overview of clampable diameter ranges

1.3.1 8BVF line filter

Connection	Wire types Approbation data	8BVF0220, 8BVF0440		8BVF0880	
		[mm ²]	[AWG]	[mm ²]	[AWG]
X1	Solid core / multiple conductor lines	0.75 - 16	20 - 6	16 - 50	6 - 0
	Flexible and fine wire lines without Wire Tip Sleeves with Wire Tip Sleeves	0.75 - 16 0.5 - 16	20 - 6 18 - 6	16 - 50 10 - 50	6 - 0 8 - 0
	Approbation data UL/C-UL-US CSA	--- ---	20 - 6 ---	--- ---	6 - 1/0 ---
Holding Torque for the Terminal Screws [Nm]		1.7 to 1.8		Min. 6	
X2	Solid core / multiple conductor lines	0.75 - 16	20 - 6	16 - 50	6 - 0
	Flexible and fine wire lines without Wire Tip Sleeves with Wire Tip Sleeves	0.75 - 16 0.5 - 16	20 - 6 18 - 6	16 - 50 10 - 50	6 - 0 8 - 0
	Approbation data UL/C-UL-US CSA	--- ---	20 - 6 ---	--- ---	6 - 1/0 ---
Holding Torque for the Terminal Screws [Nm]		1.7 to 1.8		Min. 6	
X3	Solid core / multiple conductor lines	0.2 - 2.5	24 - 12	0.2 - 2.5	24 - 12
	Flexible and fine wire lines without Wire Tip Sleeves with Wire Tip Sleeves	0.2 - 2.5 0.25 - 2.5	24 - 12 24 - 12	0.2 - 2.5 0.25 - 2.5	24 - 12 24 - 12
	Approbation data UL/C-UL-US CSA	--- ---	30 - 12 28 - 12	--- ---	30 - 12 28 - 12
Holding Torque for the Terminal Screws [Nm]		0.5 to 0.6		0.5 to 0.6	

Table 199: Terminal cross sections of the 8BVF line filter

1.3.2 8BVR regeneration chokes

Connection	Wire types Approbation data	8BVR0220H000.100-1, 8BVR0440H000.100-1		8BVR0880H000.100-1	
		[mm ²]	[AWG]	[mm ²]	[AWG]
U1, V1, W1 U2, V2, W2	Solid core / multiple conductor lines	1.5 - 25	14 - 2	2.5 - 50	12 - 1/0
	Flexible and fine wire lines without Wire Tip Sleeves with Wire Tip Sleeves	1.5 - 25 1.5 - 16	14 - 2 14 - 4	2.5 - 35 2.5 - 35	12 - 1 12 - 1
	Approbation data UL/C-UL-US CSA	--- ---	18 - 4 14 - 6	--- ---	12 - 1 12 - 2
Holding Torque for the Terminal Screws [Nm]		2 to 4		4 to 5	
T+, T-	Solid core / multiple conductor lines	0.5 - 4	18 - 10	0.5 - 4	18 - 10
	Flexible and fine wire lines without Wire Tip Sleeves with Wire Tip Sleeves	0.5 - 4 0.5 - 2.5	18 - 10 18 - 12	0.5 - 4 0.5 - 2.5	18 - 10 18 - 12
	Approbation data UL/C-UL-US CSA	--- ---	30 - 12 26 - 12	--- ---	30 - 12 26 - 12
Holding torque for the terminal screws [Nm]		0.4 to 0.6		0.4 to 0.6	

Table 200: Terminal cross sections of the 8BVR regeneration chokes

1.3.3 8B0P power supply modules

Connection	Wire types Approbation data	8BVP0220, 8BVP0440	
		[mm ²]	[AWG]
X1	Solid core / multiple conductor lines	0.2 - 2.5	24 - 12
	Flexible and fine wire lines without Wire Tip Sleeves with Wire Tip Sleeves	0.2 - 2.5	24 - 12
		0.25 - 2.5	24 - 12
	Approbation data UL/C-UL-US CSA	---	30 - 12
---		22 - 12	
Holding torque for the terminal screws [Nm]		0.5 to 0.6	
X5A	Solid core / multiple conductor lines	0.75 - 16	20 - 6
	Flexible and fine wire lines without Wire Tip Sleeves with Wire Tip Sleeves	0.75 - 16	20 - 6
		0.5 - 16	18 - 6
	Approbation data UL/C-UL-US CSA	---	20 - 6
---		---	
Holding torque for the terminal screws [Nm]		1.7 to 1.8	
X5B	Solid core / multiple conductor lines	0.5 - 10	20 - 7
	Flexible and fine wire lines without Wire Tip Sleeves with Wire Tip Sleeves	0.5 - 6	20 - 9
		0.5 - 6	20 - 9
	Approbation data UL/C-UL-US CSA	---	20 - 8
---		20 - 8	
Holding torque for the terminal screws [Nm]		1.2 to 1.5	

Table 201: Clampable diameter ranges of 8B0P power supply modules

1.3.4 8BVP power supply units

Connection	Wire types Approbation data	8BVP0220, 8BVP0440		8BVP0880, 8BVP1650	
		[mm ²]	[AWG]	[mm ²]	[AWG]
X1	Solid core / multiple conductor lines	0.2 - 2.5	24 - 12	0.2 - 2.5	24 - 12
	Flexible and fine wire lines without Wire Tip Sleeves	0.2 - 2.5	24 - 12	0.2 - 2.5	24 - 12
	with Wire Tip Sleeves	0.25 - 2.5	24 - 12	0.25 - 2.5	24 - 12
Approbation data UL/C-UL-US		---	30 - 12	---	30 - 12
CSA		---	22 - 12	---	22 - 12
Holding torque for the terminal screws [Nm]		0.5 to 0.6		0.5 to 0.6	
X2	Solid core / multiple conductor lines	0.2 - 2.5	24 - 12	0.2 - 2.5	24 - 12
	Flexible and fine wire lines without Wire Tip Sleeves	0.2 - 2.5	24 - 12	0.2 - 2.5	24 - 12
	with Wire Tip Sleeves	0.25 - 2.5	24 - 12	0.25 - 2.5	24 - 12
Approbation data UL/C-UL-US		---	30 - 12	---	30 - 12
CSA		---	22 - 12	---	22 - 12
Holding torque for the terminal screws [Nm]		0.5 to 0.6		0.5 to 0.6	
X4A	Solid core / multiple conductor lines	0.2 - 2.5	24 - 12	0.2 - 2.5	24 - 12
	Flexible and fine wire lines without Wire Tip Sleeves	0.2 - 2.5	24 - 12	0.2 - 2.5	24 - 12
	with Wire Tip Sleeves	0.25 - 2.5	24 - 12	0.25 - 2.5	24 - 12
Approbation data UL/C-UL-US		---	30 - 12	---	30 - 12
CSA		---	28 - 12	---	28 - 12
Holding torque for the terminal screws [Nm]		0.5 to 0.6		0.5 to 0.6	
X5A	Solid core / multiple conductor lines	0.75 - 16	20 - 6	6 - 50	10 - 0
	Flexible and fine wire lines without Wire Tip Sleeves	0.75 - 16	20 - 6	6 - 50	10 - 0
	with Wire Tip Sleeves	0.5 - 16	18 - 6	6 - 50	10 - 0
Approbation data UL/C-UL-US		---	20 - 6	---	---
CSA		---	---	---	---
Holding torque for the terminal screws [Nm]		1.7 to 1.8		--- 1)	

Table 202: Terminal cross sections of the 8BVP power supply units

1) The connection is made with cable lugs using an M8 threaded bolt.

1.3.5 8B0C auxiliary supply modules

Connection	Wire types Approbation data	8B0C0160 8B0C0320	
		[mm ²]	[AWG]
X1	Solid core / multiple conductor lines	0.2 - 2.5	24 - 12
	Flexible and fine wire lines without Wire Tip Sleeves	0.2 - 2.5	24 - 12
	with Wire Tip Sleeves	0.25 - 2.5	24 - 12
	Approbation data UL/C-UL-US	---	30 - 12
	CSA	---	22 - 12
Holding torque for the terminal screws [Nm]		0.5 to 0.6	
X2 ¹⁾	Solid core / multiple conductor lines	0.2 - 2.5	24 - 12
	Flexible and fine wire lines without Wire Tip Sleeves	0.2 - 2.5	24 - 12
	with Wire Tip Sleeves	0.25 - 2.5	24 - 12
	Approbation data UL/C-UL-US	---	30 - 12
	CSA	---	22 - 12
Holding torque for the terminal screws [Nm]		0.5 to 0.6	
X3 ¹⁾	Solid core / multiple conductor lines	0.2 - 6	24 - 10
	Flexible and fine wire lines without Wire Tip Sleeves	0.25 - 6	24 - 10
	with Wire Tip Sleeves	0.25 - 4	24 - 11
	Approbation data UL/C-UL-US	---	24 - 10
	CSA	---	---
Holding torque for the terminal screws [Nm]		0.7 to 0.8	

Table 203: Terminal cross sections of the 8B0C auxiliary supply modules

1) Only for 8B0C0160Hx00.001-1, 8B0C0160HC00.A01-1 and 8B0C0320Hx00.002-1.

Wiring • Overview of clampable diameter ranges

1.3.6 8BVI inverter modules

Connection	Wire types Approbation data	8BVI0014 8BVI0028 8BVI0055 8BVI0110 8BVI0220HxD		8BVI0220HxS		8BVI0440		8BVI0880 8BVI1650	
		[mm²]	[AWG]	[mm²]	[AWG]	[mm²]	[AWG]	[mm²]	[AWG]
X1	Solid core / multiple conductor lines	0.2 - 2.5	24 - 12	0.2 - 2.5	24 - 12	0.2 - 2.5	24 - 12	0.2 - 2.5	24 - 12
	Flexible and fine wire lines without Wire Tip Sleeves with Wire Tip Sleeves	0.2 - 2.5 0.25 - 2.5	24 - 12 24 - 12	0.2 - 2.5 0.25 - 2.5	24 - 12 24 - 12	0.2 - 2.5 0.25 - 2.5	24 - 12 24 - 12	0.2 - 2.5 0.25 - 2.5	24 - 12 24 - 12
	Approbation data UL/C-UL-US CSA	---	30 - 12 22 - 12	---	30 - 12 22 - 12	---	30 - 12 22 - 12	---	30 - 12 22 - 12
Holding torque for the terminal screws [Nm]		0.5 to 0.6		0.5 to 0.6		0.5 to 0.6		0.5 to 0.6	
X2	Solid core / multiple conductor lines	0.2 - 2.5	24 - 12	0.2 - 2.5	24 - 12	0.2 - 2.5	24 - 12	0.2 - 2.5	24 - 12
	Flexible and fine wire lines without Wire Tip Sleeves with Wire Tip Sleeves	0.2 - 2.5 0.25 - 2.5	24 - 12 24 - 12	0.2 - 2.5 0.25 - 2.5	24 - 12 24 - 12	0.2 - 2.5 0.25 - 2.5	24 - 12 24 - 12	0.2 - 2.5 0.25 - 2.5	24 - 12 24 - 12
	Approbation data UL/C-UL-US CSA	---	30 - 12 22 - 12	---	30 - 12 22 - 12	---	30 - 12 22 - 12	---	30 - 12 22 - 12
Holding torque for the terminal screws [Nm]		0.5 to 0.6		0.5 to 0.6		0.5 to 0.6		0.5 to 0.6	
X4A, X4B	Solid core / multiple conductor lines	0.2 - 2.5	24 - 12	0.2 - 2.5	24 - 12	0.2 - 2.5	24 - 12	0.2 - 2.5	24 - 12
	Flexible and fine wire lines without Wire Tip Sleeves with Wire Tip Sleeves	0.2 - 2.5 0.25 - 2.5	24 - 12 24 - 12	0.2 - 2.5 0.25 - 2.5	24 - 12 24 - 12	0.2 - 2.5 0.25 - 2.5	24 - 12 24 - 12	0.2 - 2.5 0.25 - 2.5	24 - 12 24 - 12
	Approbation data UL/C-UL-US CSA	---	30 - 12 28 - 12	---	30 - 12 28 - 12	---	30 - 12 28 - 12	---	30 - 12 28 - 12
Holding torque for the terminal screws [Nm]		0.5 to 0.6		0.5 to 0.6		0.5 to 0.6		0.5 to 0.6	
X5A, X5B	Solid core / multiple conductor lines	0.2 - 10	24 - 8	0.5 - 10	20 - 7	0.75 - 16	20 - 6	6 - 50	10 - 0
	Flexible and fine wire lines without Wire Tip Sleeves with Wire Tip Sleeves	0.2 - 6 0.2 - 6	24 - 10 24 - 10	0.5 - 6 0.5 - 6	20 - 9 20 - 9	0.75 - 16 0.5 - 16	20 - 6 18 - 6	6 - 50 6 - 50	10 - 0 10 - 0
	Approbation data UL/C-UL-US CSA	---	24 - 10 ---	---	20 - 8 20 - 8	---	20 - 6 ---	---	---
Holding torque for the terminal screws [Nm]		0.5 to 0.6		1.2 to 1.5		1.7 to 1.8		... ¹⁾	

Table 204: Terminal cross sections of the 8BVI inverter modules

1) The connection is made with cable lugs using an M8 threaded bolt.

1.3.7 8BVE expansion modules

Connection	Wire types Approbation data	8BVE0500	
		[mm ²]	[AWG]
X2	Solid core / multiple conductor lines	0.2 - 2.5	24 - 12
	Flexible and fine wire lines without Wire Tip Sleeves with Wire Tip Sleeves	0.2 - 2.5	24 - 12
		0.25 - 2.5	24 - 12
Approbation data UL/C-UL-US CSA		---	30 - 12 22 - 12
Holding torque for the terminal screws [Nm]		0.5 to 0.6	
X3A, X3B	Solid core / multiple conductor lines	0.2 - 6	24 - 10
	Flexible and fine wire lines without Wire Tip Sleeves with Wire Tip Sleeves	0.25 - 6	24 - 10
		0.25 - 4	24 - 11
Approbation data UL/C-UL-US CSA		---	24 - 10 ---
Holding torque for the terminal screws [Nm]		0.7 to 0.8	
X4A, X4B	Solid core / multiple conductor lines	0.75 - 16	20 - 6
	Flexible and fine wire lines without Wire Tip Sleeves with Wire Tip Sleeves	0.75 - 16	20 - 6
		0.5 - 16	18 - 6
Approbation data UL/C-UL-US CSA		---	20 - 6 ---
Holding torque for the terminal screws [Nm]		1.7 to 1.8	

Table 205: Terminal cross sections of the 8BVE expansion modules

2. 8B0F line filters

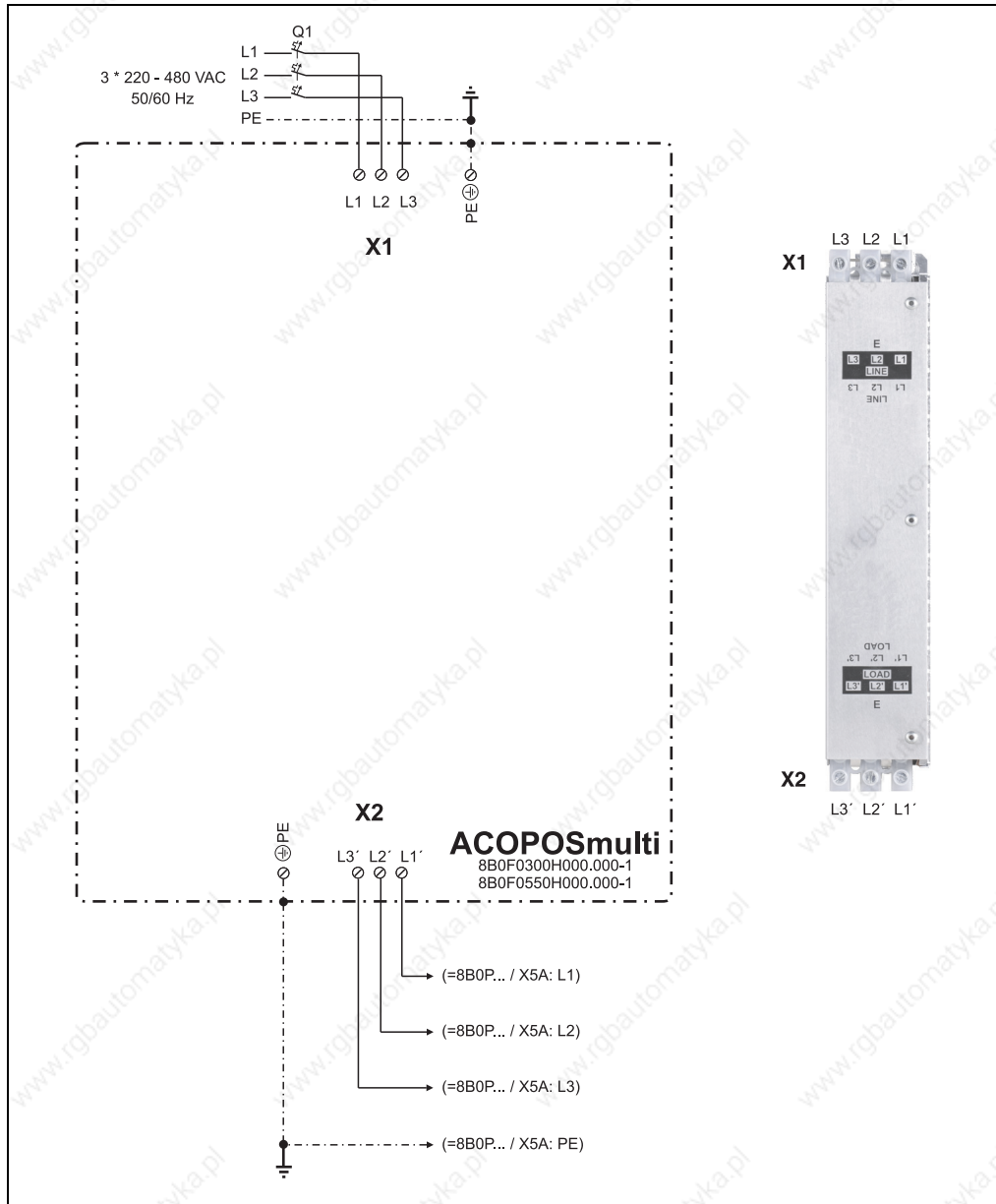


Figure 113: Overview of pin assignments - 8B0F0330H000.000-1, 8B0F0550H000.000-1

2.1 Pin assignments - X1

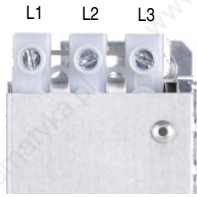
X1	Name	Function
	L1	Power mains connection L1 (mains side)
	L2	Power mains connection L2 (mains side)
	L3	Power mains connection L3 (mains side)
Terminal connection cross section	8B0F0300H000.000-1	8B0F0550H000.000-1
Flexible and fine wire lines with wire tip sleeves UL/cULus CSA	Max. 10 mm ² 8 8	Max. 16 mm ² 4 4
Fastening torque of the terminal screws	1.9 to 2.2 Nm	

Table 206: Pin assignments - X1 plug 8B0F0300H000.000-1, 8B0F0550H000.000-1

2.2 Pin assignments - X2

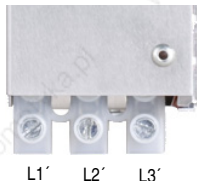
X2	Name	Function
	L1'	Power mains connection L1 (load side)
	L2'	Power mains connection L2 (load side)
	L3'	Power mains connection L3 (load side)
Terminal connection cross section	8B0F0300H000.000-1	8B0F0550H000.000-1
Flexible and fine wire lines with wire tip sleeves UL/cULus CSA	Max. 10 mm ² 8 8	Max. 16 mm ² 4 4
Fastening torque of the terminal screws	1.9 to 2.2 Nm	

Table 207: Pin assignments - X2 plug 8B0F0300H000.000-1, 8B0F0550H000.000-1

2.3 Protective ground connection (PE) (mains and load side)

The protective ground conductor is connected to the threaded bolt provided using a cable lug.

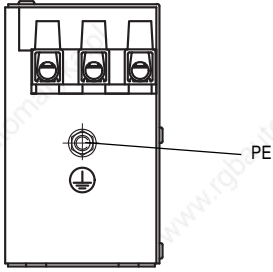
Figure	Pin	Name	Function					
	---	PE	Protective ground conductor					
	<table border="1"> <thead> <tr> <th>Terminal cross sections</th> <th>[mm²]</th> <th>AWG</th> </tr> </thead> <tbody> <tr> <td>Cable lug for threaded bolt</td> <td>0.25 - 16</td> <td>23 - 5</td> </tr> </tbody> </table>			Terminal cross sections	[mm ²]	AWG	Cable lug for threaded bolt	0.25 - 16
Terminal cross sections	[mm ²]	AWG						
Cable lug for threaded bolt	0.25 - 16	23 - 5						

Table 208: Protective ground connection (PE) 8B0F0300H000.000-1, 8B0F0550H000.000-1

Danger!

Before turning on the supply voltage, make sure that the line filter housing is properly connected to ground (PE rail). The ground connection must be made, even when testing the line filter or when operating it for a short time!

2.4 Input/output circuit diagram

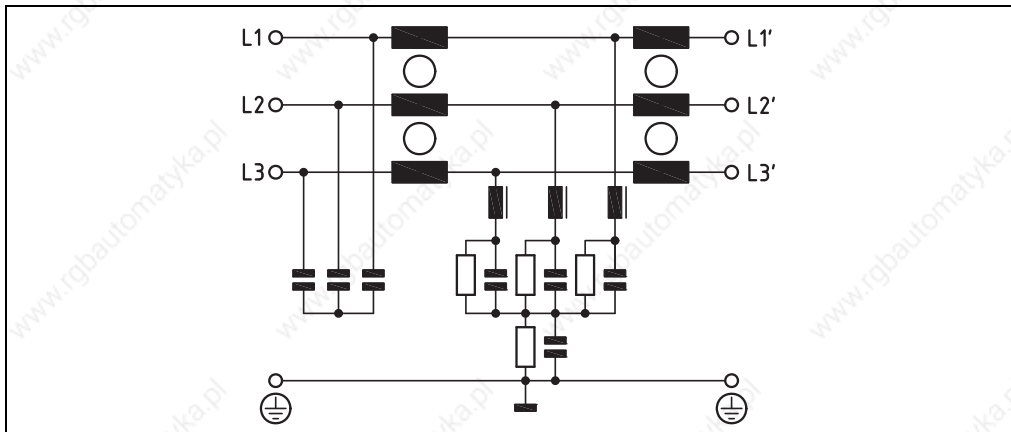


Figure 114: Input/output circuit diagram - 8B0F0300H000.000-1, 8B0F0550H000.000-1

3. 8BVF line filter

3.1 8BVF0220H000.000-1, 8BVF0440H000.001-2

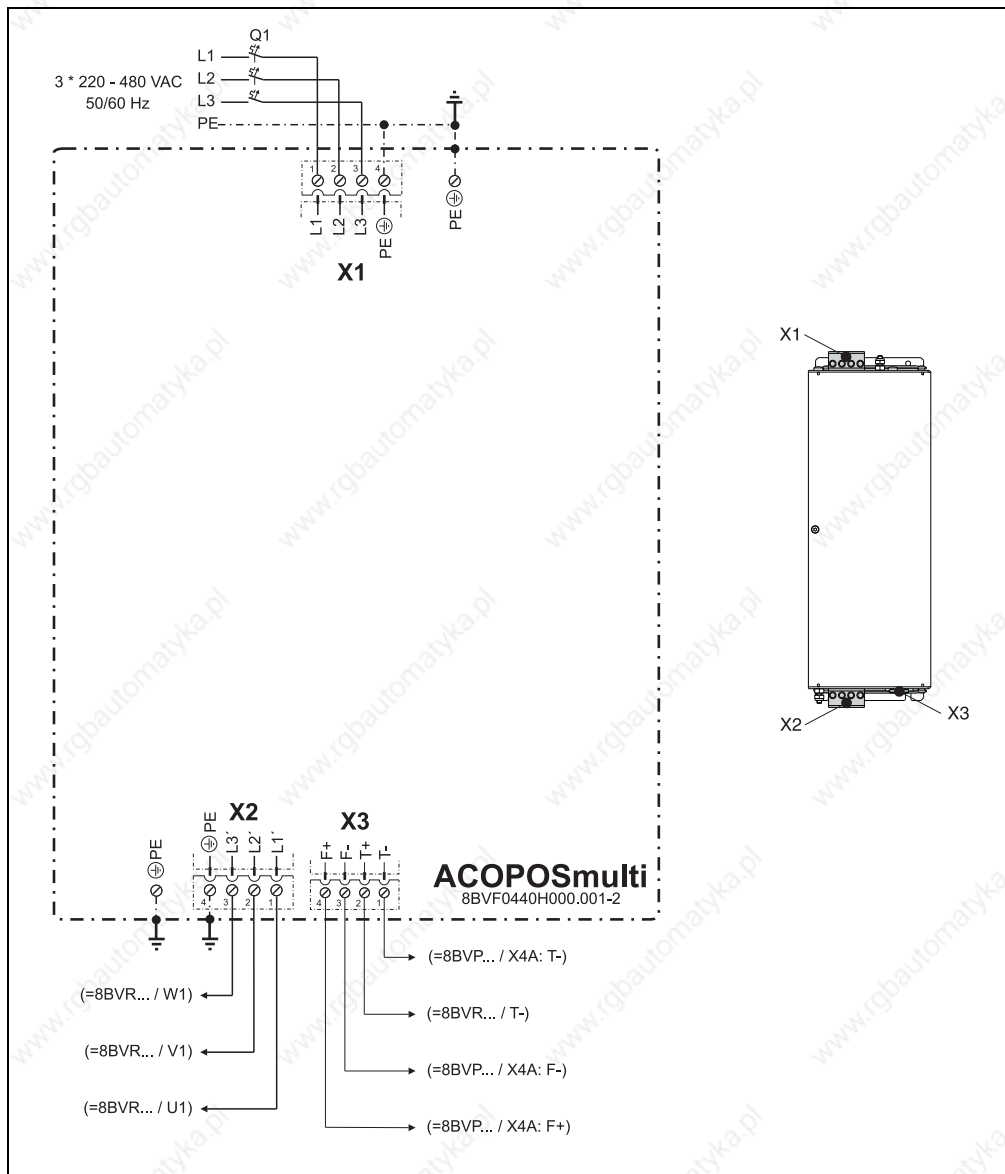


Figure 115: Overview of pin assignments - 8BVF0220H000.000-1, 8BVF0440H000.001-2

3.1.1 Pin assignments - X1 plug

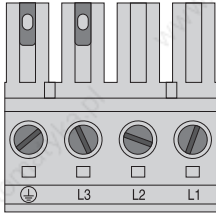
X1	Name	Function
	L1	Power mains connection L1 (mains side)
	L2	Power mains connection L2 (mains side)
	L3	Power mains connection L3 (mains side)
	PE	Protective ground conductor

Table 209: Pin assignments - X1 plug 8BVF0220H000.000-1, 8BVF0440H000.001-2

3.1.2 Pin assignments - X2 plug

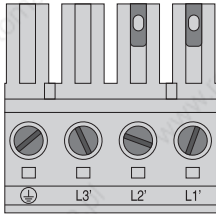
X2	Name	Function
	L1'	Power mains connection L1 (load side)
	L2'	Power mains connection L2 (load side)
	L3'	Power mains connection L3 (load side)
	PE	Protective ground conductor

Table 210: Pin assignments - X2 plug 8BVF0220H000.000-1, 8BVF0440H000.001-2

Warning!

The position of the protective ground connection (PE) on plugs X1 and X2 is different than the position of the protective ground connection on plug X5A for inverter modules 8BVI0220 / 8BVI0440 and power supply modules 8BVP0220 / 8BVP0440!

3.1.3 Pin assignments - X3 plug

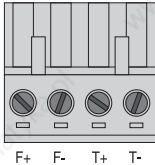
X3	Name	Function
	T-	Load: Temperature sensor -
	T+	Load: Temperature sensor +
	F-	Load: Fans -
	F+	Load: Fans +

Table 211: Pin assignments - X3 plug 8BVF0220H000.000-1, 8BVF0440H000.001-2

3.1.4 Additional protective ground connection (PE) (mains and load side)

The protective ground conductor is connected to the M5 (mains and load side) threaded bolt provided using a cable lug. For information concerning dimensioning see section 1.1.3 "Protective ground connection (PE)", on page 327.

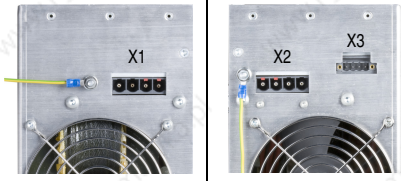
Figure	Pin	Name	Function
 <p>View from above (mains side) View from below (load side)</p>	---	PE	Protective ground conductor
Terminal cross sections		[mm ²]	AWG
Cable lug for M5 threaded bolt		0.25 - 16	23 - 5

Table 212: Additional protective ground connection (PE) 8BVF0220H000.000-1, 8BVF0440H000.001-2

Danger!

Before turning on the supply voltage, make sure that the line filter housing is properly connected to ground (PE rail). The ground connection must be made, even when testing the line filter or when operating it for a short time!

3.1.5 Input/output circuit diagram

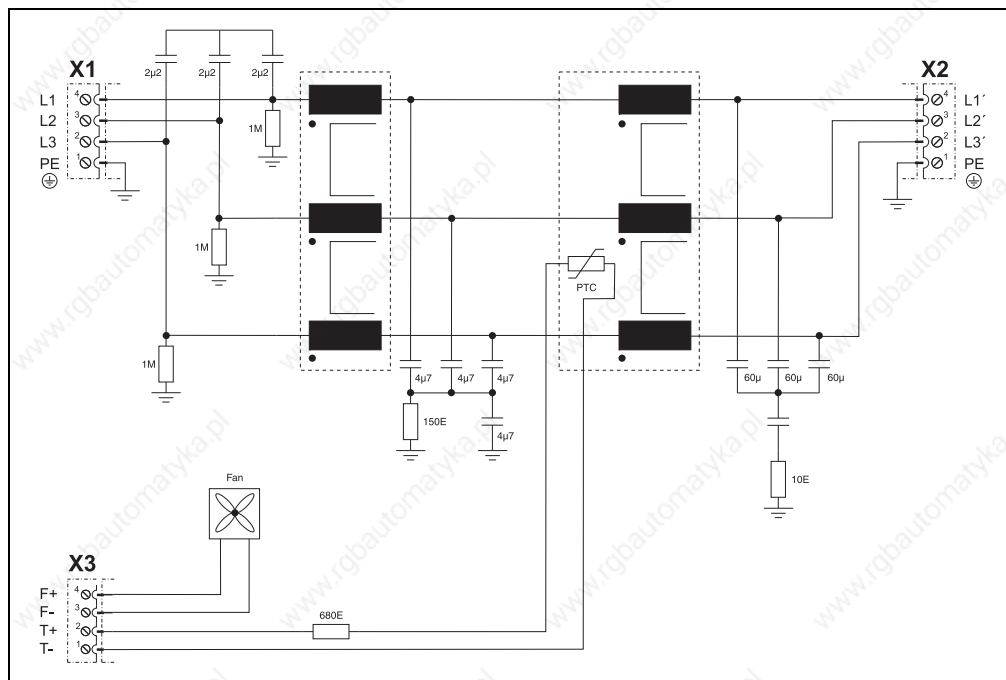


Figure 116: Input/output circuit diagram - 8BVF0220H000.000-1, 8BVF0440H000.001-2

3.2 8BVF0880H000.000-1

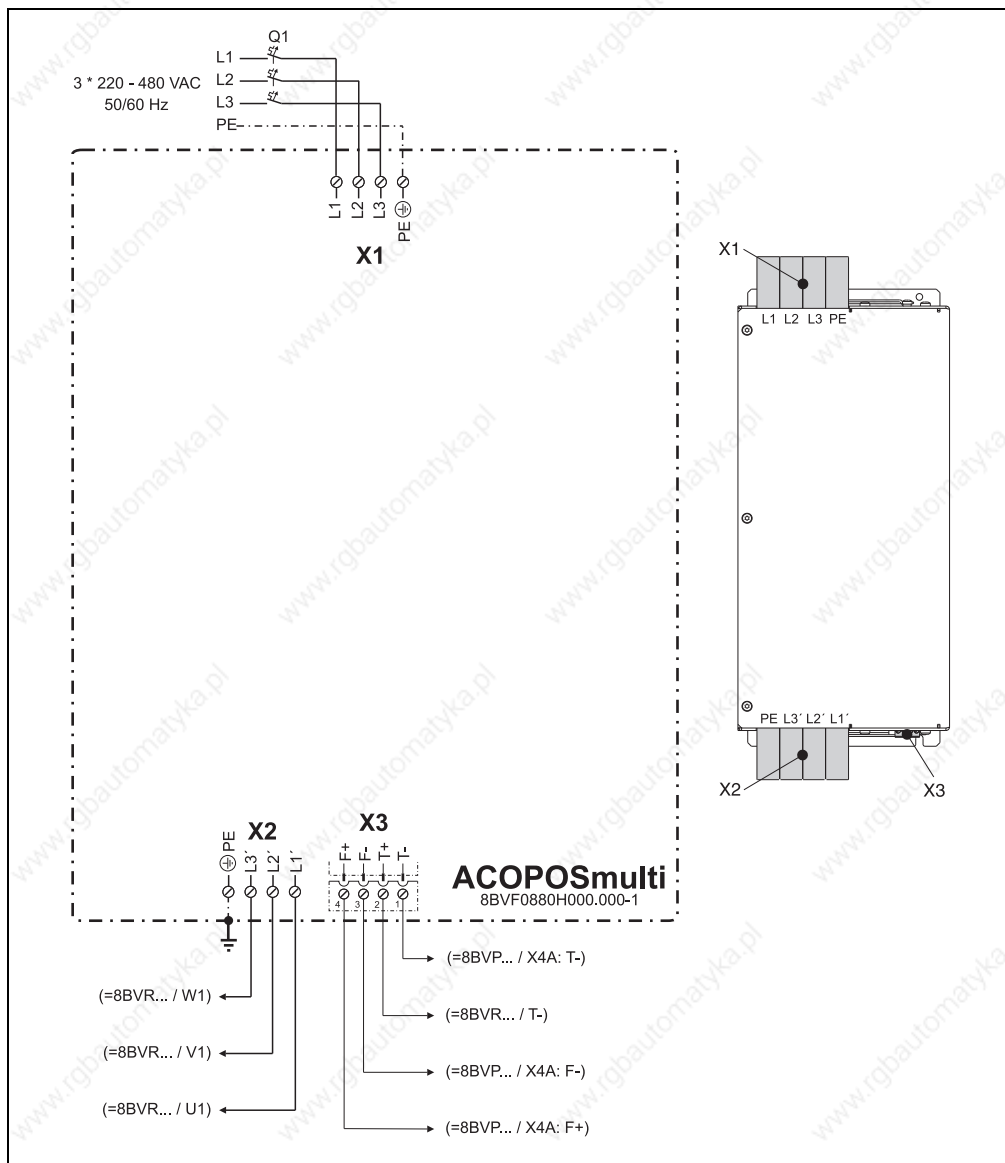


Figure 117: Overview of pin assignments - 8BVF0880H000.000-1

3.2.1 Pin assignments - X1

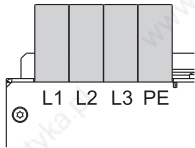
X1	Name	Function
	L1	Power mains connection L1 (mains side)
	L2	Power mains connection L2 (mains side)
	L3	Power mains connection L3 (mains side)
	PE	Protective ground conductor

Table 213: Pin assignments - X1 8BVF0880H000.000-1

3.2.2 Pin assignments - X2

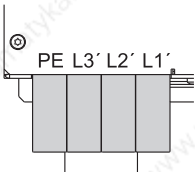
X2	Name	Function
	L1'	Power mains connection L1 (load side)
	L2'	Power mains connection L2 (load side)
	L3'	Power mains connection L3 (load side)
	PE	Protective ground conductor

Table 214: Pin assignments - X2 8BVF0880H000.000-1

3.2.3 Pin assignments - X3 plug

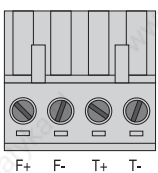
X3	Name	Function
	T-	Load: Temperature sensor -
	T+	Load: Temperature sensor +
	F-	Load: Fans -
	F+	Load: Fans +

Table 215: Pin assignments - X3 plug 8BVF0880H000.000-1

Danger!

Before turning on the supply voltage, make sure that the line filter housing is properly connected to ground (PE rail). The ground connection must be made, even when testing the line filter or when operating it for a short time!

3.2.4 Input/output circuit diagram

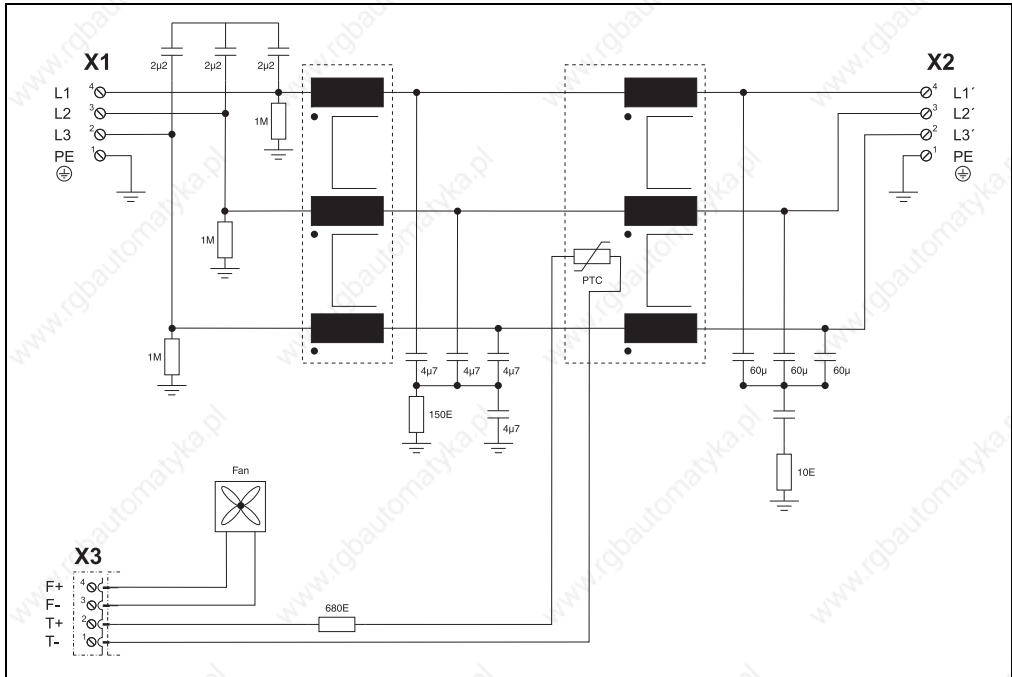


Figure 118: Input/output circuit diagram - 8BVF0880H000.000-1

4. 8BVR regeneration chokes

4.1 8BVR0220H000.100-1

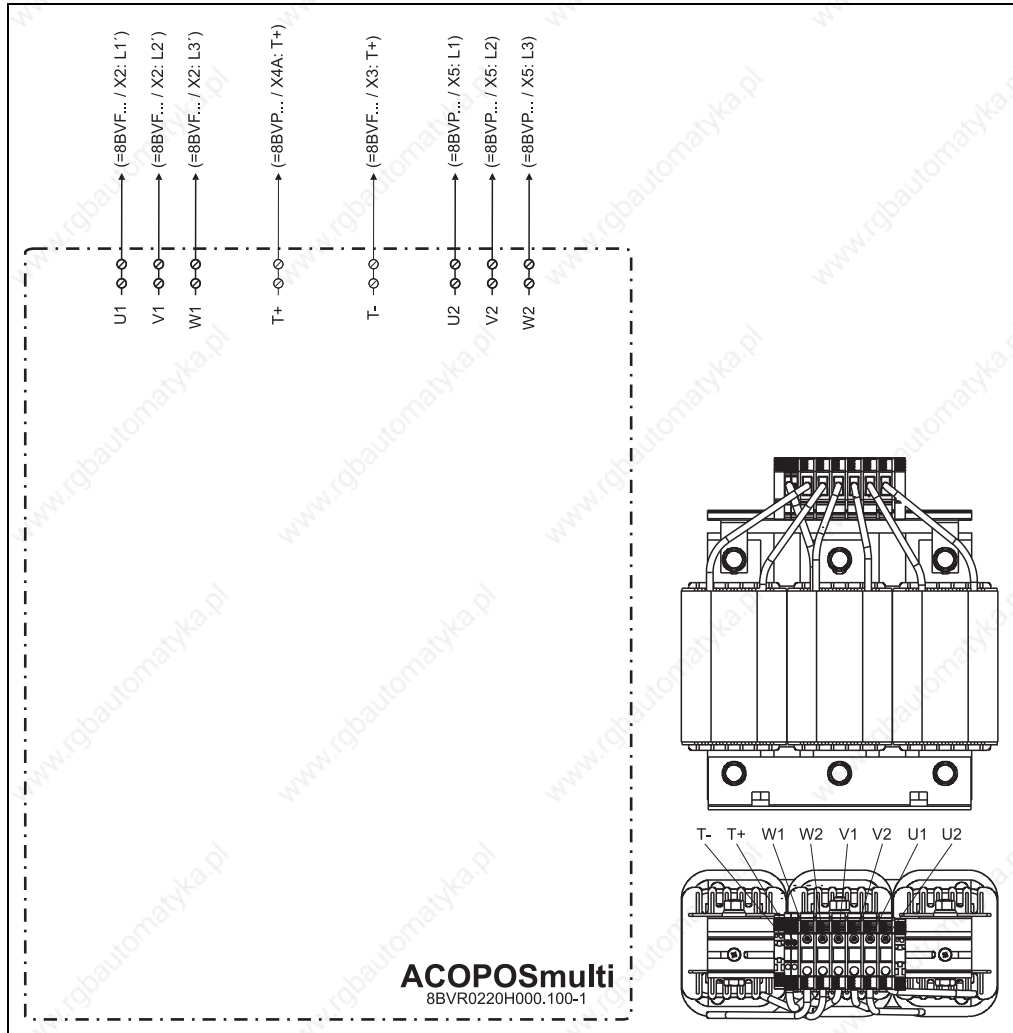


Figure 119: Overview of pin assignments - 8BVR0220H000.100-1

4.1.1 Input/output circuit diagram

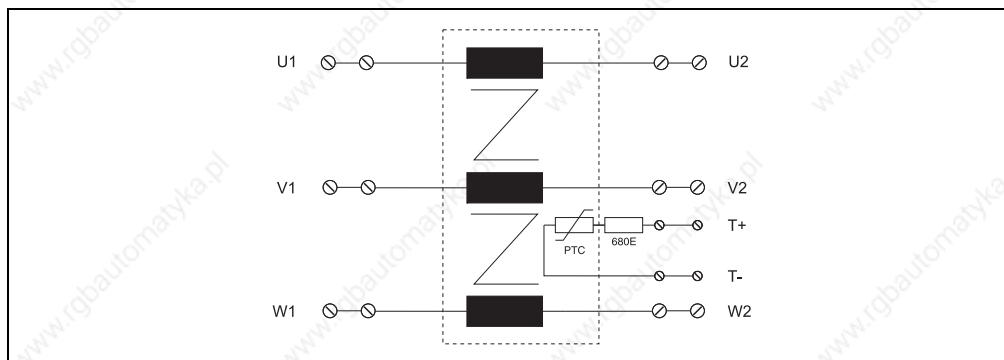


Figure 120: Input/output circuit diagram - 8BVR0220H000.100-1

Information:

ACOPOSmulti 8BVR regeneration chokes do not contain a protective ground connection because all exposed electrically conductive parts are isolated from the active parts using reinforced insulation.

Warning!

When installing ACOPOSmulti regeneration chokes make sure that the windings and connection wires are strongly insulated from the neighboring electrically conductive components (e.g. switching cabinet wall).

If this reinforced insulation is implemented with an area of empty space, then a minimum distance of 8 mm (or 12.7 mm in accordance to cULus) to the neighboring conductive parts is necessary.

Caution!

Certain installation positions can block the view of the warning sticker on the regeneration choke. Therefore, two additional warning stickers are included in the delivery for the user to place in a clearly visible location on the regeneration choke. These warning stickers are attached to the regeneration choke by a cable tie and must be removed before initial start-up because the backing film for the warning sticker is not sufficiently heat-resistant!

4.2 8BVR0440H000.100-1

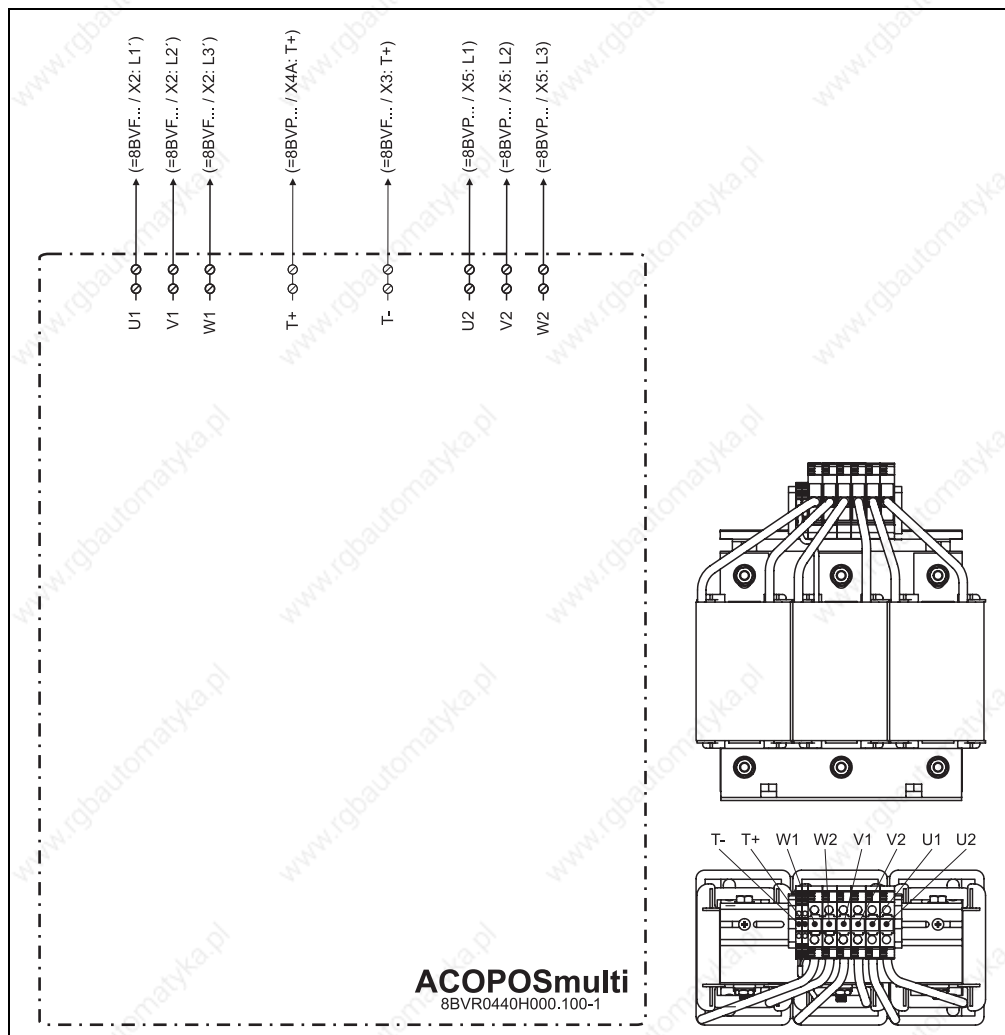


Figure 121: Overview of pin assignments - 8BVR0440H000.100-1

4.2.1 Input/output circuit diagram

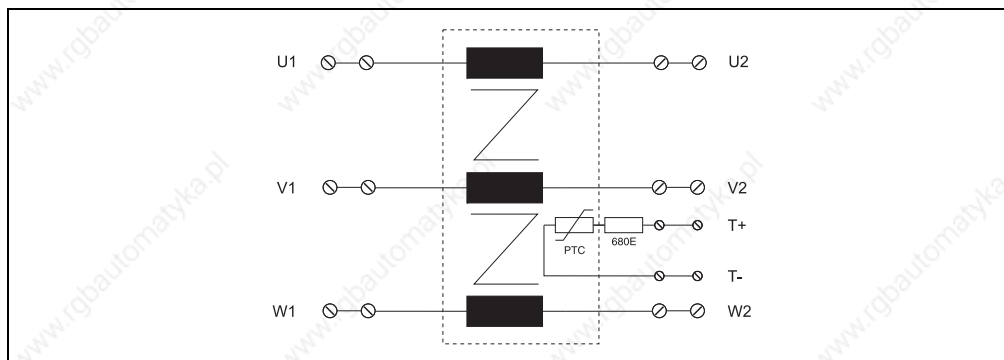


Figure 122: Input/output circuit diagram - 8BVR0440H000.100-1

Information:

ACOPOSmulti 8BVR regeneration chokes do not contain a protective ground connection because all exposed electrically conductive parts are isolated from the active parts using reinforced insulation.

Warning!

When installing ACOPOSmulti regeneration chokes make sure that the windings and connection wires are strongly insulated from the neighboring electrically conductive components (e.g. switching cabinet wall).

If this reinforced insulation is implemented with an area of empty space, then a minimum distance of 8 mm (or 12.7 mm in accordance to cULus) to the neighboring conductive parts is necessary.

Caution!

Certain installation positions can block the view of the warning sticker on the regeneration choke. Therefore, two additional warning stickers are included in the delivery for the user to place in a clearly visible location on the regeneration choke. These warning stickers are attached to the regeneration choke by a cable tie and must be removed before initial start-up because the backing film for the warning sticker is not sufficiently heat-resistant!

4.3 8BVR0880H000.100-1

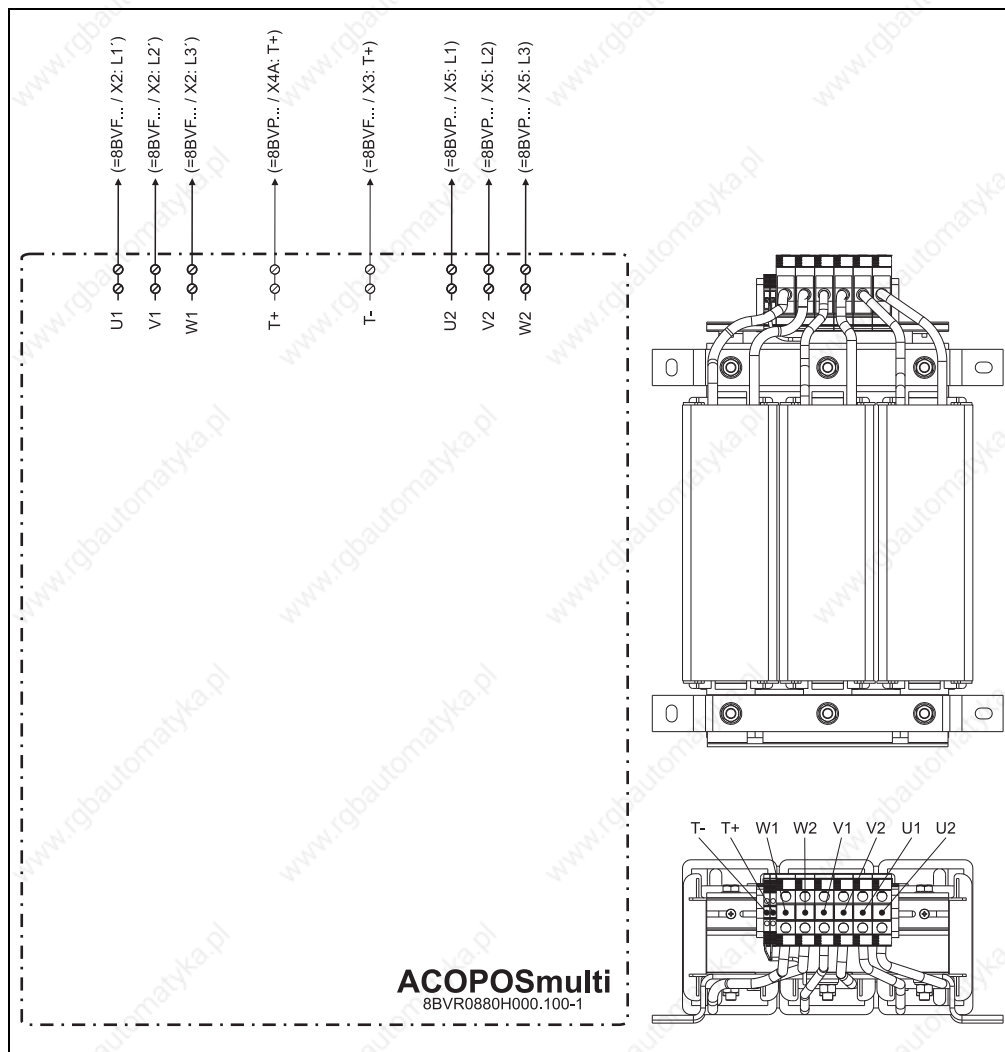


Figure 123: Overview of pin assignments - 8BVR0880H000.100-1

4.3.1 Input/output circuit diagram

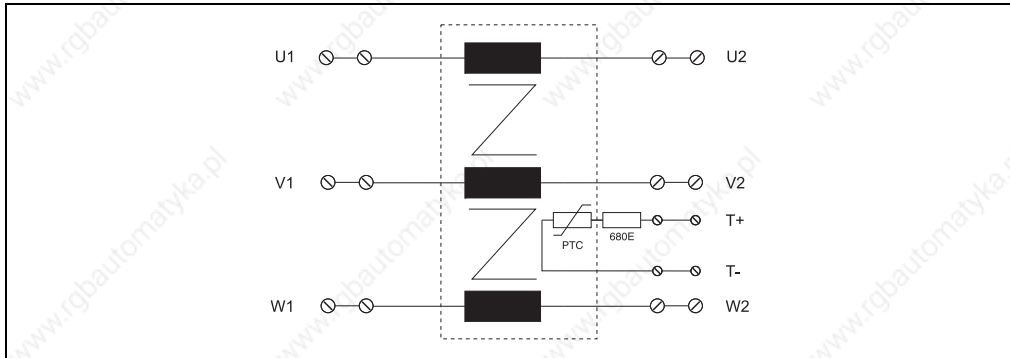


Figure 124: Input/output circuit diagram - 8BVR0880H000.100-1

Information:

ACOPOSmulti 8BVR regeneration chokes do not contain a protective ground connection because all exposed electrically conductive parts are isolated from the active parts using reinforced insulation.

Warning!

When installing ACOPOSmulti regeneration chokes make sure that the windings and connection wires are strongly insulated from the neighboring electrically conductive components (e.g. switching cabinet wall).

If this reinforced insulation is implemented with an area of empty space, then a minimum distance of 8 mm (or 12.7 mm in accordance to cULus) to the neighboring conductive parts is necessary.

Caution!

Certain installation positions can block the view of the warning sticker on the regeneration choke. Therefore, two additional warning stickers are included in the delivery for the user to place in a clearly visible location on the regeneration choke. These warning stickers are attached to the regeneration choke by a cable tie and must be removed before initial start-up because the backing film for the warning sticker is not sufficiently heat-resistant!

5. 8B0P power supply modules

5.1 8B0P0220Hx00.000-1, 8B0P0440Hx00.000-1

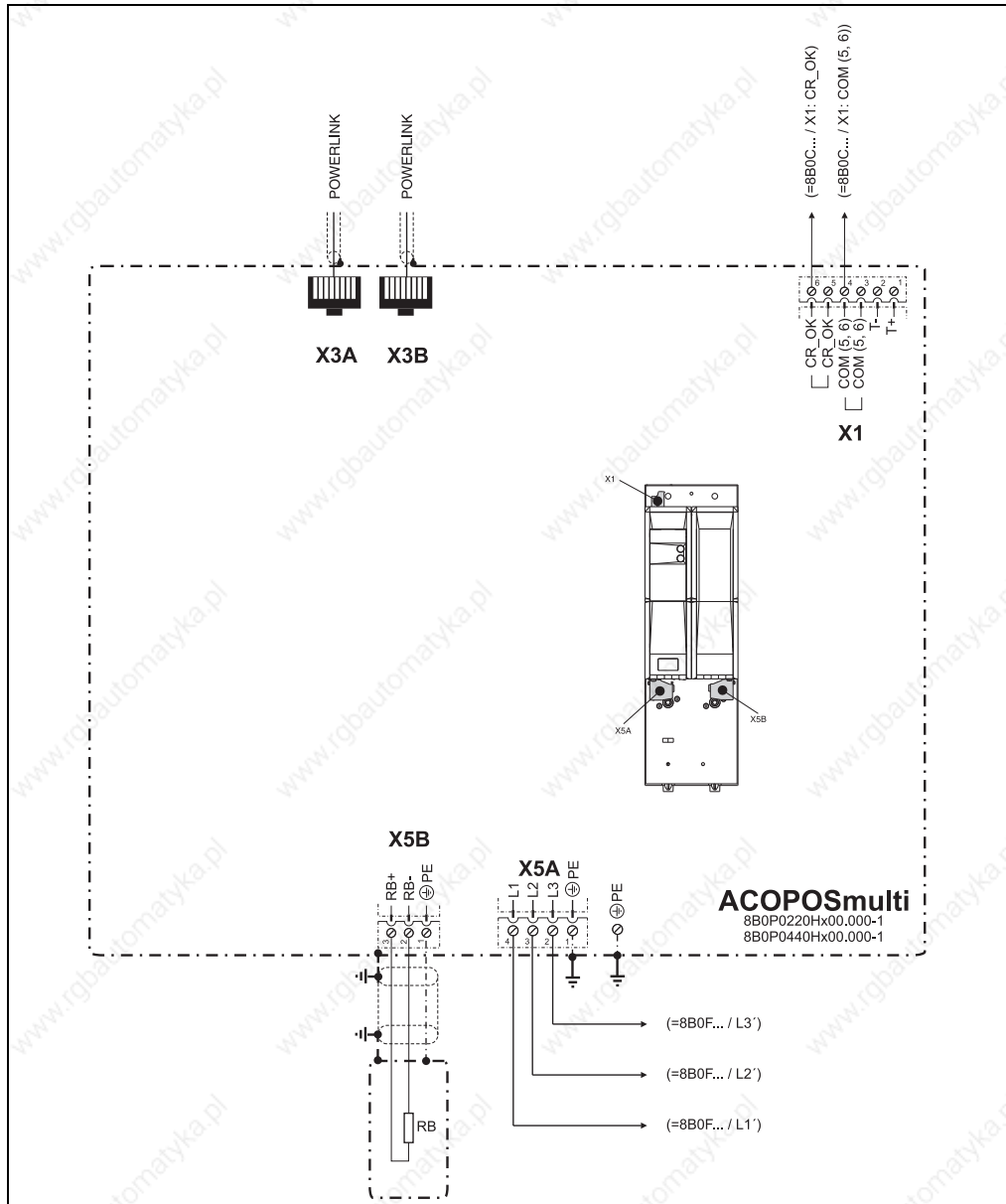


Figure 125: Overview of pin assignments - 8B0P0220Hx00.000-1, 8B0P0440Hx00.000-1

5.1.1 Pin assignments - X1 plug

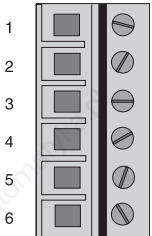
X1	Pin	Name	Function
	1	T+	Temperature sensor +
	2	T-	Temperature sensor -
	3	COM (5, 6)	DC bus ready 0 V
	4	COM (5, 6)	DC bus ready 0 V
	5	CR_OK	DC bus ready ¹⁾
	6	CR_OK	DC bus ready ¹⁾

Table 216: Pin assignments - X1 plug 8B0P0220Hx00.000-1, 8B0P0440Hx00.000-1

- 1) The CR_OK output is only set if the following condition is met:
The charging relay is closed and the DC bus voltage $U_{DC} > 270$ VDC.

Danger!

The connections for the temperature sensors are isolated circuits. Therefore, these connections are only allowed to be connected to devices or components with at least safe isolation according to IEC 60364-4-41 or EN 61800-5-1.

5.1.2 Pin assignments - X3A, X3B plugs


X3A, X3B	Pin	Name	Function
	1	RXD	Receive signal
	2	RXD\	Receive signal inverted
	3	TXD	Transmit signal
	4	Shield	Shield
	5	Shield	Shield
	6	TXD\	Transmit signal inverted
	7	Shield	Shield
	8	Shield	Shield

Table 217: Pin assignments - X3A, X3B plugs 8B0P0220Hx00.000-1, 8B0P0440Hx00.000-1

5.1.3 Pin assignments - X5A plug

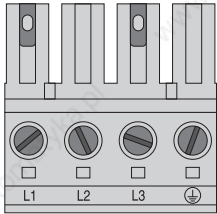
X5A	Name	Function
	PE	Network: Protective ground conductor
	L3	Network: Power mains connection L3
	L2	Network: Power mains connection L2
	L1	Network: Power mains connection L1

Table 218: Pin assignments - X5A plug 8B0P0220Hx00.000-1, 8B0P0440Hx00.000-1

5.1.4 Pin assignments - X5B plug

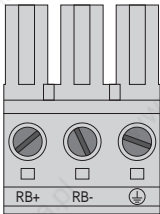
X6	Name	Function
	PE	Protective ground conductor
	RB-	Brake Resistance -
	RB+	Brake Resistance +

Table 219: Pin assignments - X5B plug 8B0P0220Hx00.000-1, 8B0P0440Hx00.000-1

Danger!

Before turning on the module, make sure that the housing is properly connected to ground (PE rail). The ground connection must be made, even when testing the module or when operating it for a short time!

5.1.5 Additional protective ground connection (PE)

The protective ground conductor is connected to the M5 threaded bolt provided using a cable lug. For information concerning dimensioning see section 1.1.3 "Protective ground connection (PE)", on page 327.

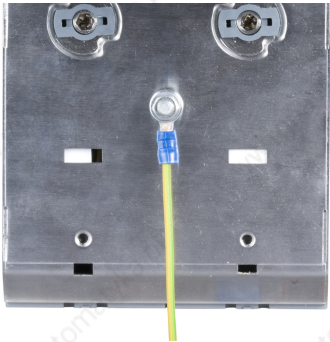
Figure	Pin	Name	Function					
 <p>View from below</p>	---	PE	Protective ground conductor					
	<table border="1"> <thead> <tr> <th>Terminal cross sections</th> <th>[mm²]</th> <th>AWG</th> </tr> </thead> <tbody> <tr> <td>Cable lug for M5 threaded bolt</td> <td>0.25 - 16</td> <td>23 - 5</td> </tr> </tbody> </table>			Terminal cross sections	[mm ²]	AWG	Cable lug for M5 threaded bolt	0.25 - 16
Terminal cross sections	[mm ²]	AWG						
Cable lug for M5 threaded bolt	0.25 - 16	23 - 5						

Table 220: Additional protective ground connection (PE) 8B0P0220H000.000-1, 8B0P0440H000.000-1

5.1.6 Input/output circuit diagram

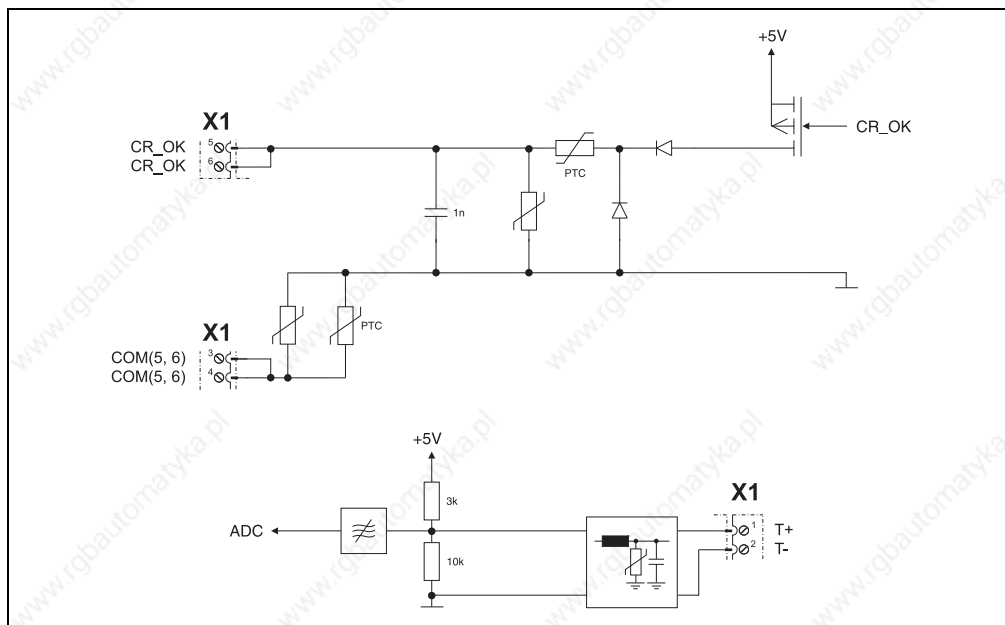


Figure 126: Input/output circuit diagram - 8B0P0220Hx00.000-1, 8B0P0440Hx00.000-1

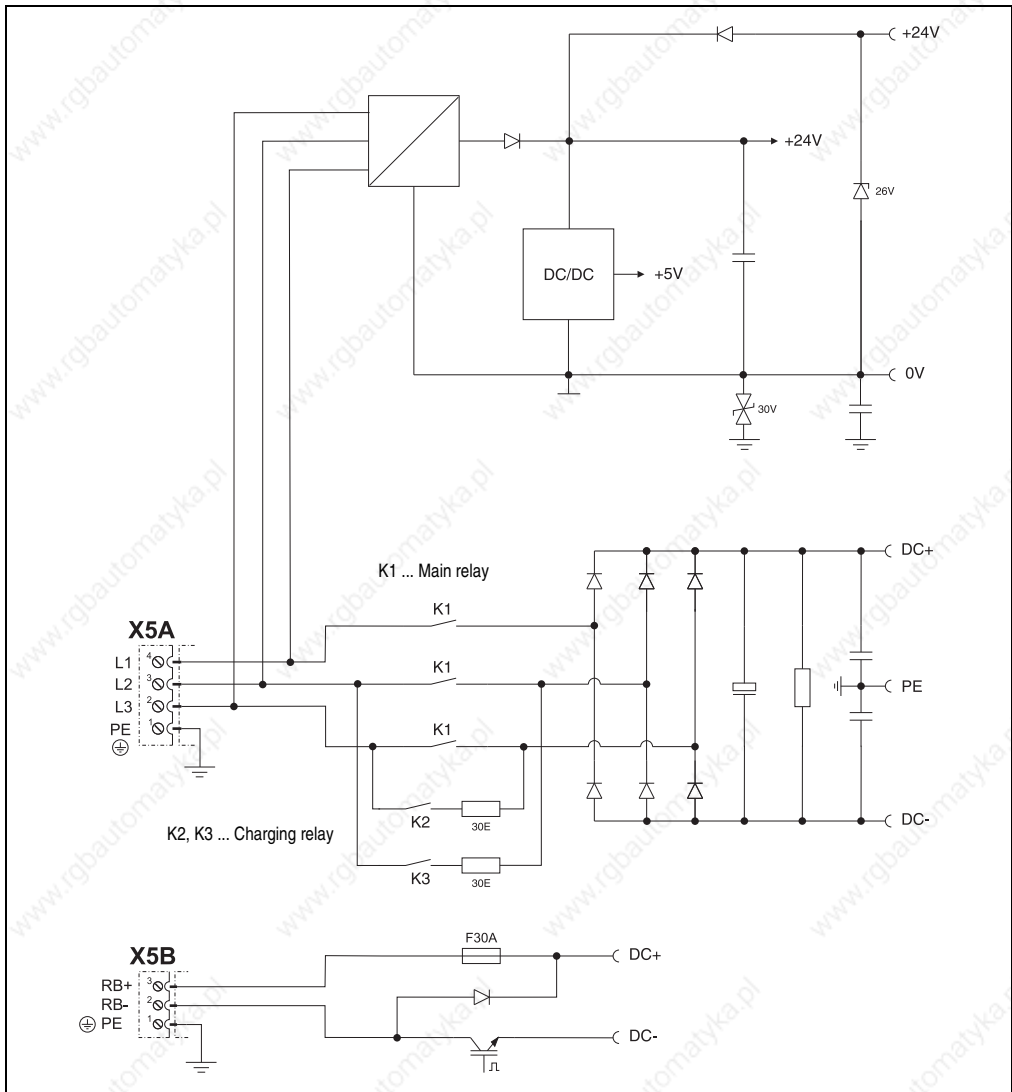


Figure 126: Input/output circuit diagram - 8B0P0220Hx00.000-1, 8B0P0440Hx00.000-1 (cont.)

6. 8BVP power supply units

6.1 8BVP0220Hx00.000-1, 8BVP0440Hx00.000-1

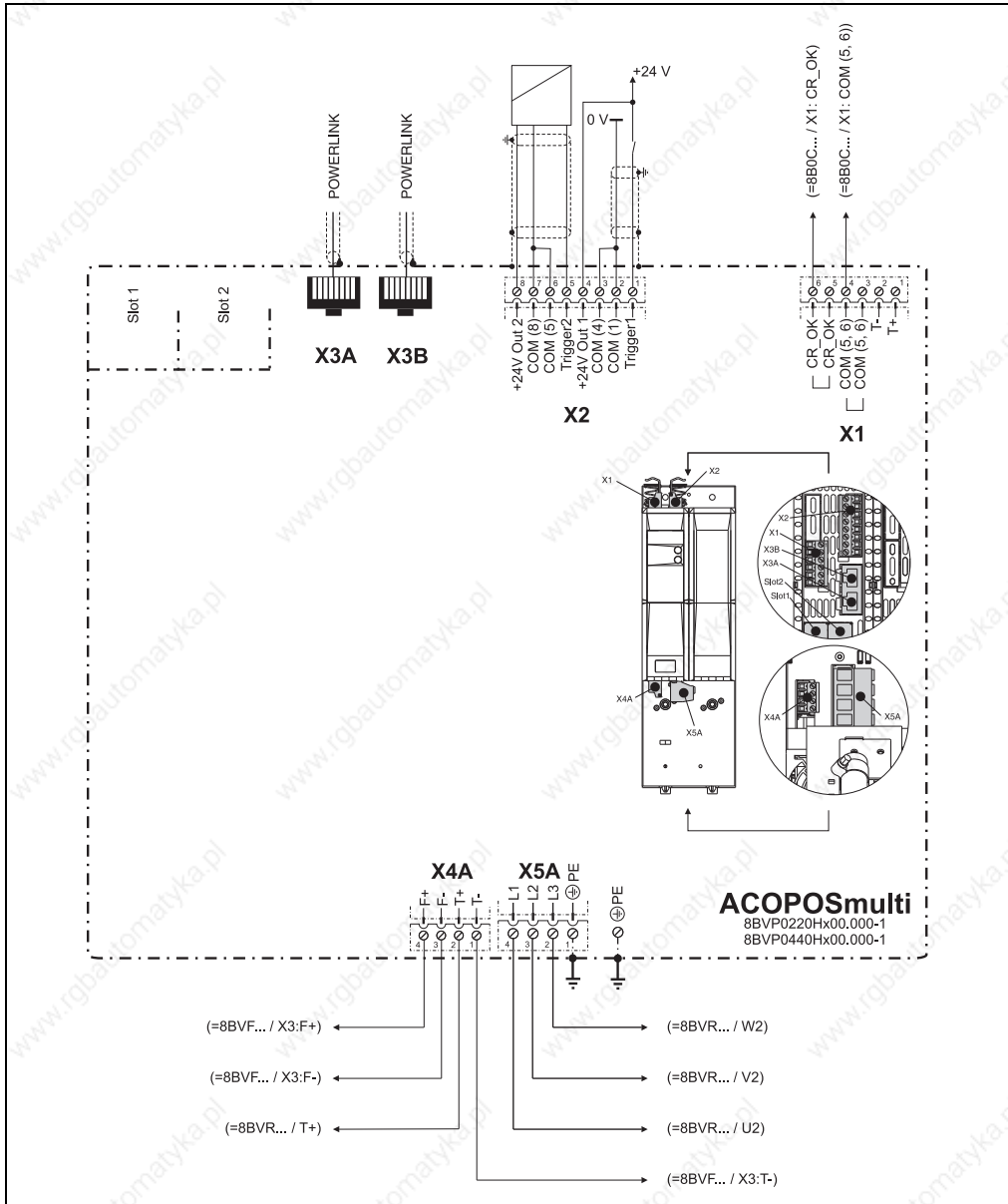


Figure 127: Overview of pin assignments - 8BVP0220Hx00.000-1, 8BVP0440Hx00.000-1

6.1.1 Pin assignments - X1 plug

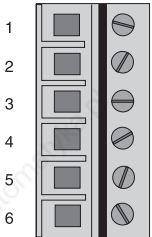
X1		Pin	Name	Function
	1	T+	Temperature sensor +	
	2	T-	Temperature sensor -	
	3	COM (5, 6)	DC bus ready 0 V	
	4	COM (5, 6)	DC bus ready 0 V	
	5	CR_OK	DC bus ready ¹⁾	
	6	CR_OK	DC bus ready ¹⁾	

Table 221: Pin assignments - X1 plug 8BVP0220Hx00.000-1, 8BVP0440Hx00.000-1

- 1) The CR_OK output is only set if the following condition is met:
The charging relay is closed and the DC bus voltage $U_{DC} > 270$ VDC.

Danger!

The connections for the temperature sensors are isolated circuits. Therefore, these connections are only allowed to be connected to devices or components with at least safe isolation according to IEC 60364-4-41 or EN 61800-5-1.

6.1.2 Pin assignments - X2 plug

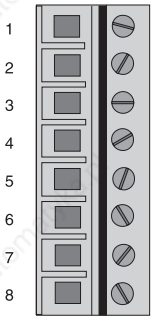
X2		Pin	Name	Function
	1	Trigger1	Trigger 1	
	2	COM (1)	Trigger 1 0 V	
	3	COM (4)	+24 V output 1 0 V	
	4	+24V Out 1	+24 V output 1	
	5	Trigger2	Trigger 2	
	6	COM (5)	Trigger 2 0 V	
	7	COM (8)	+24 V output 2 0 V	
	8	+24V Out 2	+24 V output 2	

Table 222: Pin assignments - X2 plug 8BVP0220Hx00.000-1, 8BVP0440Hx00.000-1

6.1.3 Pin assignments - X3A, X3B plugs


X3A, X3B	Pin	Name	Function
	1	RXD	Receive signal
	2	RXD\	Receive signal inverted
	3	TXD	Transmit signal
	4	Shield	Shield
	5	Shield	Shield
	6	TXD\	Transmit signal inverted
	7	Shield	Shield
	8	Shield	Shield

Table 223: Pin assignments - X3A, X3B plugs 8BVP0220Hx00.000-1, 8BVP0440Hx00.000-1

6.1.4 Pin assignments - X4A plug

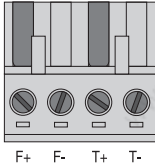
X4A	Name	Function
	T-	Network: Temperature sensor -
	T+	Network: Temperature sensor +
	F-	Network: Fans -
	F+	Network: Fans +

Table 224: Pin assignments - X4A plug 8BVP0220Hx00.000-1, 8BVP0440Hx00.000-1

Danger!

The connections for the temperature sensors and the fans are isolated circuits. Therefore, these connections are only allowed to be connected to devices or components with at least safe isolation according to IEC 60364-4-41 or EN 61800-5-1.

6.1.5 Pin assignments - X5A plug

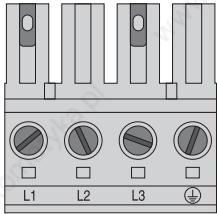
X5A	Name	Function
	PE	Network: Protective ground conductor
	L3	Network: Power mains connection L3
	L2	Network: Power mains connection L2
	L1	Network: Power mains connection L1

Table 225: Pin assignments - X5A plug 8BVP0220Hx00.000-1, 8BVP0440Hx00.000-1

Danger!

Before turning on the module, make sure that the housing is properly connected to ground (PE rail). The ground connection must be made, even when testing the module or when operating it for a short time!

6.1.6 Additional protective ground connection (PE)

The protective ground conductor is connected to the M5 threaded bolt provided using a cable lug. For information concerning dimensioning see section 1.1.3 "Protective ground connection (PE)", on page 327.

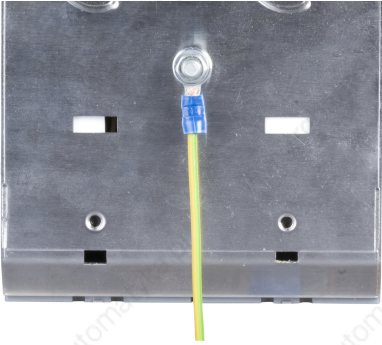
Figure	Pin	Name	Function					
 <p>View from below</p>	---	PE	Protective ground conductor					
	<table border="1"> <thead> <tr> <th>Terminal cross sections</th> <th>[mm²]</th> <th>AWG</th> </tr> </thead> <tbody> <tr> <td>Cable lug for M5 threaded bolt</td> <td>0.25 - 16</td> <td>23 - 5</td> </tr> </tbody> </table>			Terminal cross sections	[mm ²]	AWG	Cable lug for M5 threaded bolt	0.25 - 16
Terminal cross sections	[mm ²]	AWG						
Cable lug for M5 threaded bolt	0.25 - 16	23 - 5						

Table 226: Additional protective ground connection (PE) 8BVP0220H000.000-1, 8BVP0440H000.000-1

Danger!

Before turning on the supply voltage, make sure that the 8BVP power supply module housing is properly connected to ground (PE rail). The ground connection must be made, even when testing the 8BVP power supply module or when operating it for a short time!

6.1.7 Input/output circuit diagram

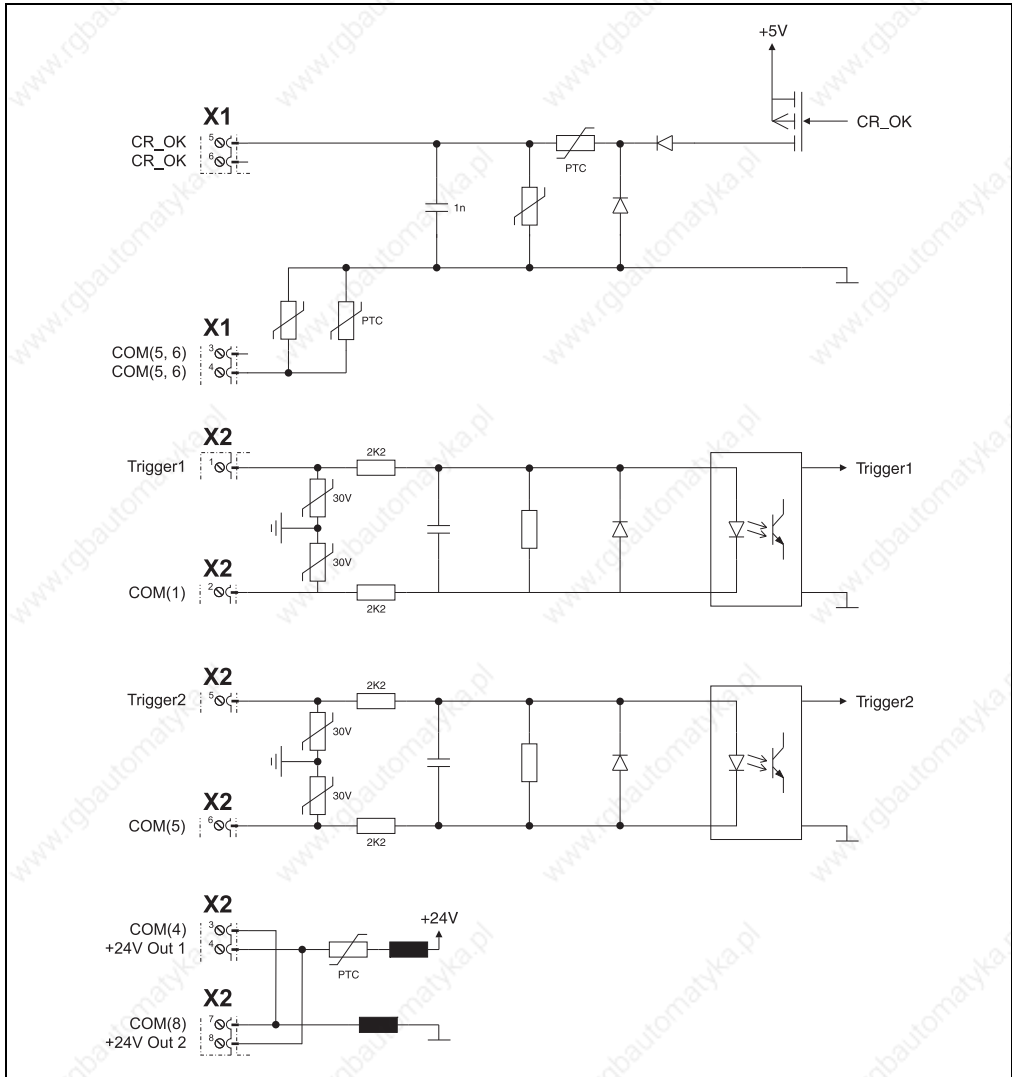


Figure 128: Input/output diagram - 8BVP0220Hx00.000-1, 8BVP0440Hx00.000-1

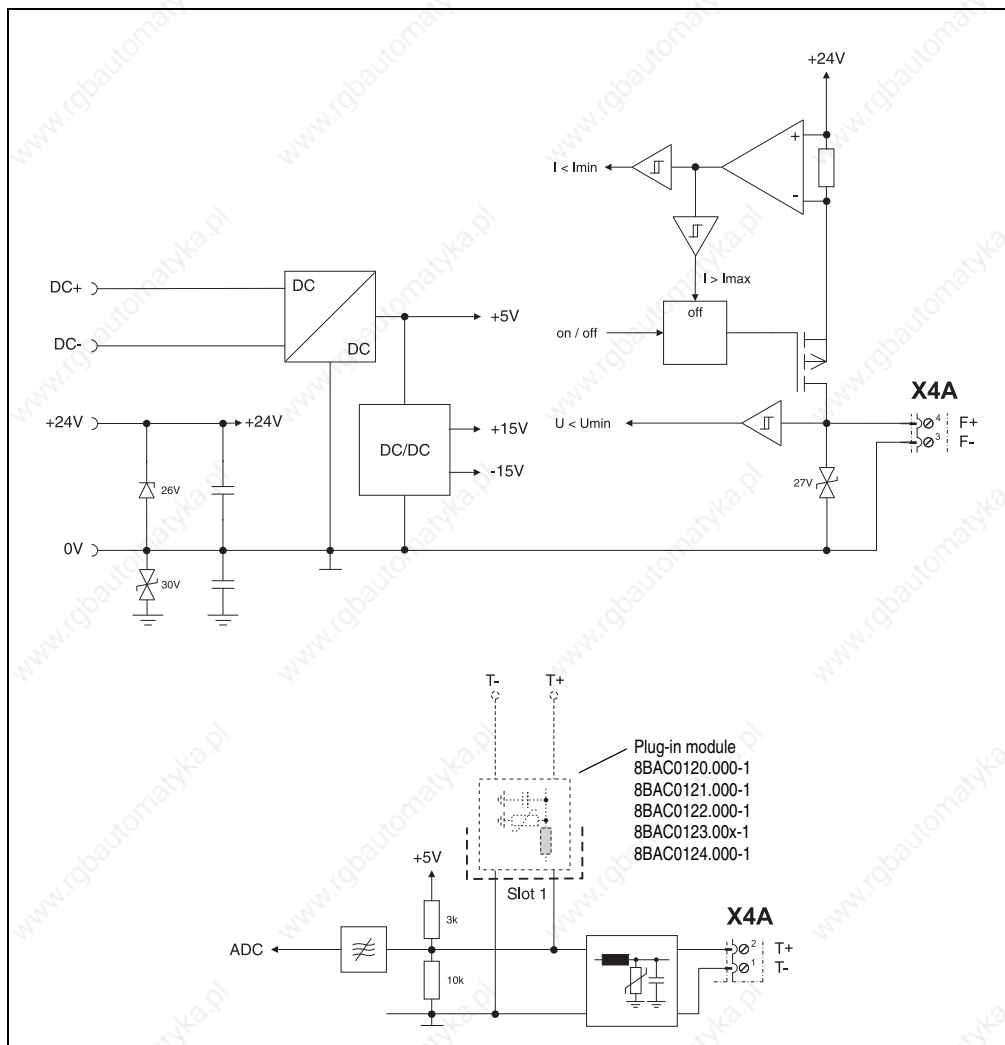


Figure 128: Input/output diagram - 8BVP0220Hx00.000-1, 8BVP0440Hx00.000-1 (cont.)

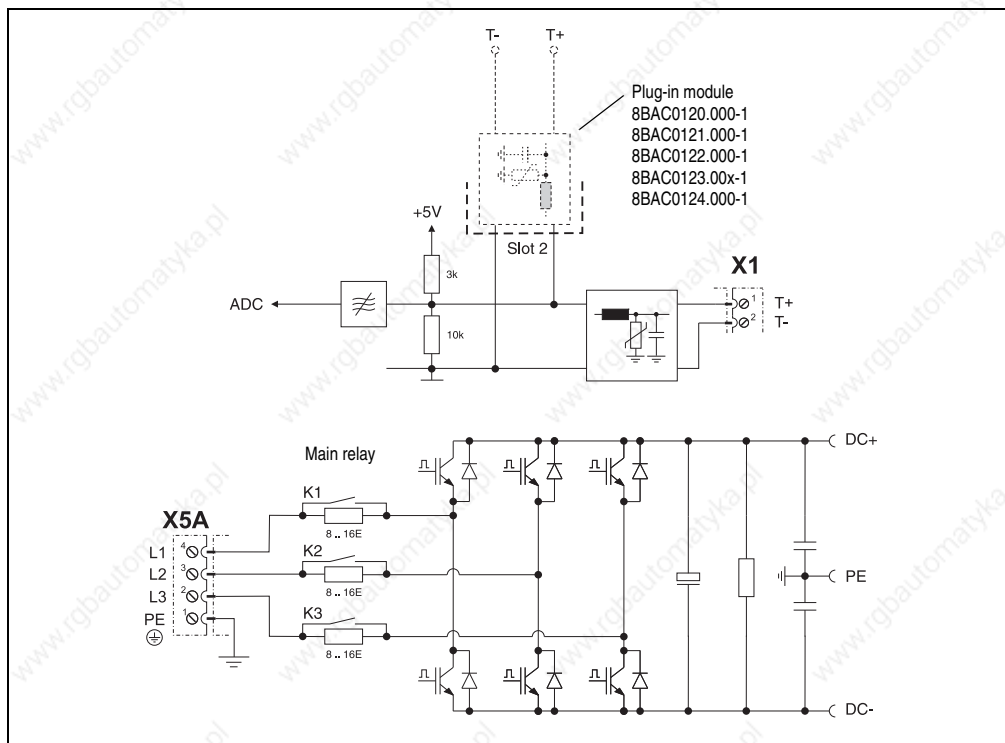


Figure 128: Input/output diagram - 8BVP0220Hx00.000-1, 8BVP0440Hx00.000-1 (cont.)

6.2 8BVP0880Hx00.000-1

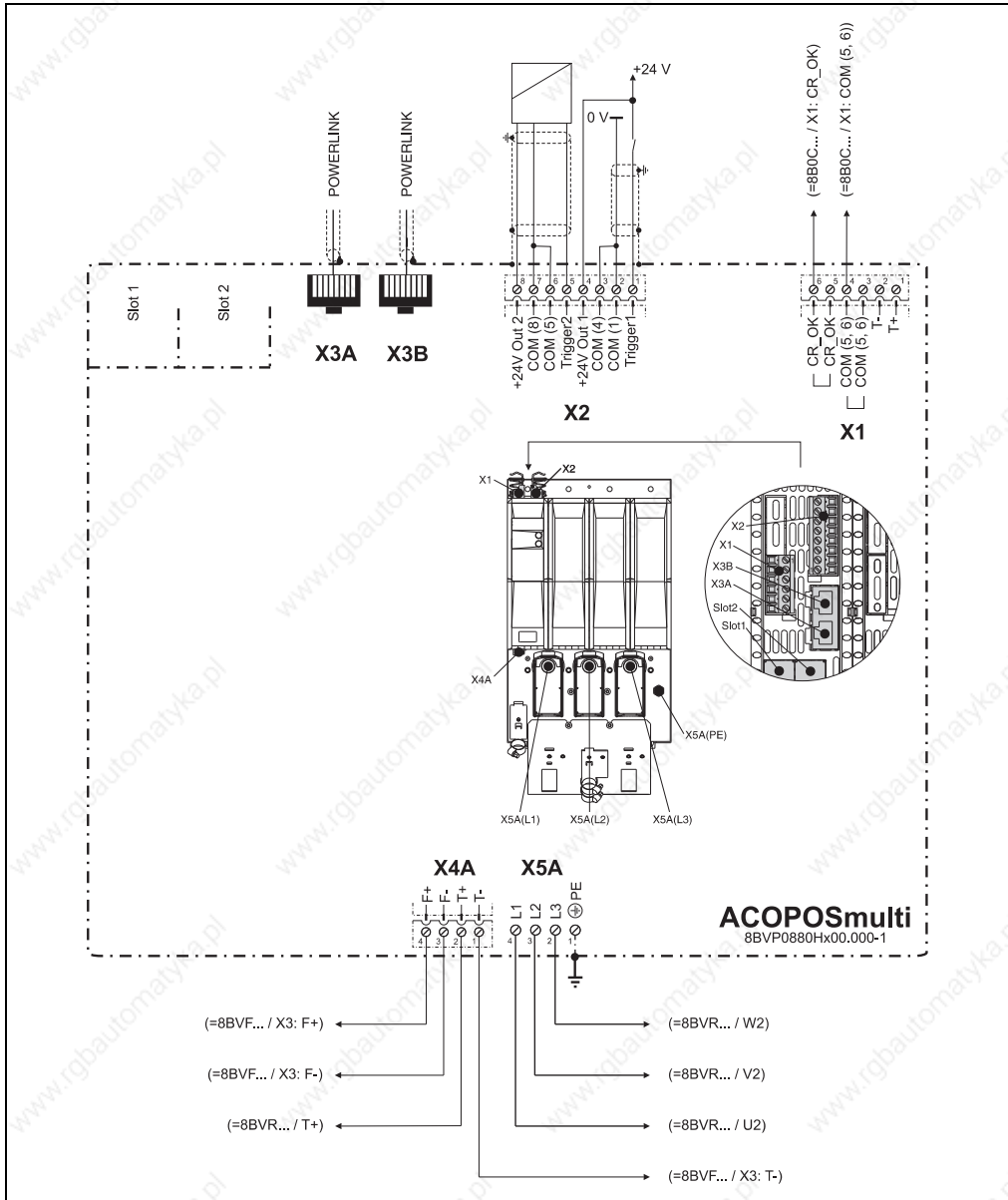


Figure 129: Overview of pin assignments - 8BVP0880Hx00.000-1

6.2.1 Pin assignments - X1 plug

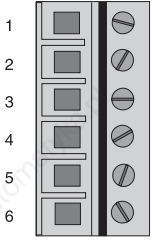
X1		Pin	Name	Function
	1	T+	Temperature sensor +	
	2	T-	Temperature sensor -	
	3	COM (5, 6)	DC bus ready 0 V	
	4	COM (5, 6)	DC bus ready 0 V	
	5	CR_OK	DC bus ready ¹⁾	
	6	CR_OK	DC bus ready ¹⁾	

Table 227: Pin assignments - X1 plug 8BVP0880Hx00.000-1

- 1) The CR_OK output is only set if the following condition is met:
The charging relay is closed and the DC bus voltage $U_{DC} > 270$ VDC.

Danger!

The connections for the temperature sensors are isolated circuits. Therefore, these connections are only allowed to be connected to devices or components with at least safe isolation according to IEC 60364-4-41 or EN 61800-5-1.

6.2.2 Pin assignments - X2 plug

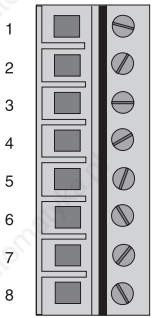
X2		Pin	Name	Function
	1	Trigger1	Trigger 1	
	2	COM (1)	Trigger 1 0 V	
	3	COM (4)	+24 V output 1 0 V	
	4	+24V Out 1	+24 V output 1	
	5	Trigger2	Trigger 2	
	6	COM (5)	Trigger 2 0 V	
	7	COM (8)	+24 V output 2 0 V	
	8	+24V Out 2	+24 V output 2	

Table 228: Pin assignments - X2 plug 8BVP0880Hx00.000-1

6.2.3 Pin assignments - X3A, X3B plugs


X3A, X3B	Pin	Name	Function
	1	RXD	Receive signal
	2	RXD\	Receive signal inverted
	3	TXD	Transmit signal
	4	Shield	Shield
	5	Shield	Shield
	6	TXD\	Transmit signal inverted
	7	Shield	Shield
	8	Shield	Shield

Table 229: Pin assignments - X3A, X3B plugs 8BVP0880Hx00.000-1

6.2.4 Pin assignments - X4A plug

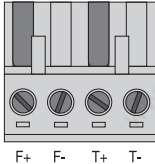
X4A	Name	Function
	T-	Network: Temperature sensor -
	T+	Network: Temperature sensor +
	F-	Network: Fans -
	F+	Network: Fans +

Table 230: Pin assignments - X4A plug 8BVP0880Hx00.000-1

Danger!

The connections for the temperature sensors and the fans are isolated circuits. Therefore, these connections are only allowed to be connected to devices or components with at least safe isolation according to IEC 60364-4-41 or EN 61800-5-1.

6.2.5 Pin assignments - X5A plug

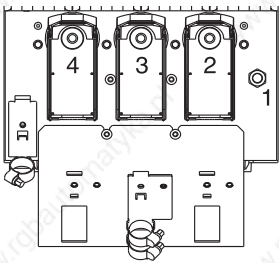
X5A	Pin	Name	Function
	1	PE	Network: Protective ground conductor
	2	L3	Network: Power mains connection L3
	3	L2	Network: Power mains connection L2
	4	L1	Network: Power mains connection L1
Holding torque for the M8 nuts: 7.5 Nm			

Table 231: Pin assignments - X5A plug 8BVP0880Hx00.000-1

Danger!

Before turning on the module, make sure that the housing is properly connected to ground (PE rail). The ground connection must be made, even when testing the module or when operating it for a short time!

Cable installation for power mains connection L1, L2, L3

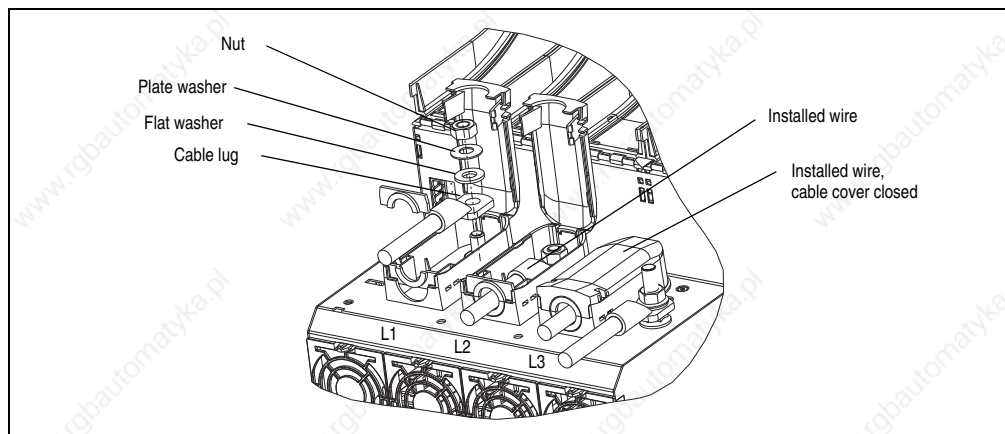


Figure 130: Cable installation for power mains connection L1, L2, L3

Cable installation connection PE (1 wire)

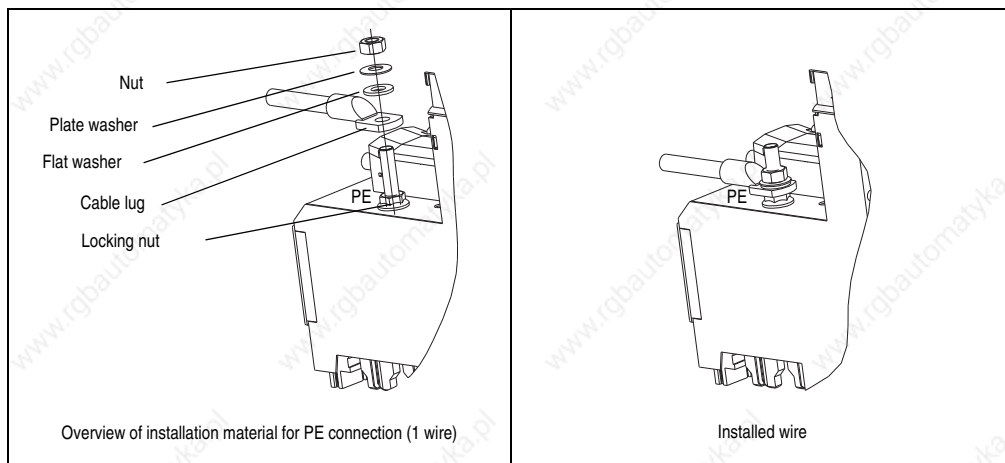


Figure 131: Cable installation connection PE (1 wire)

Cable installation connection PE (3 wire)

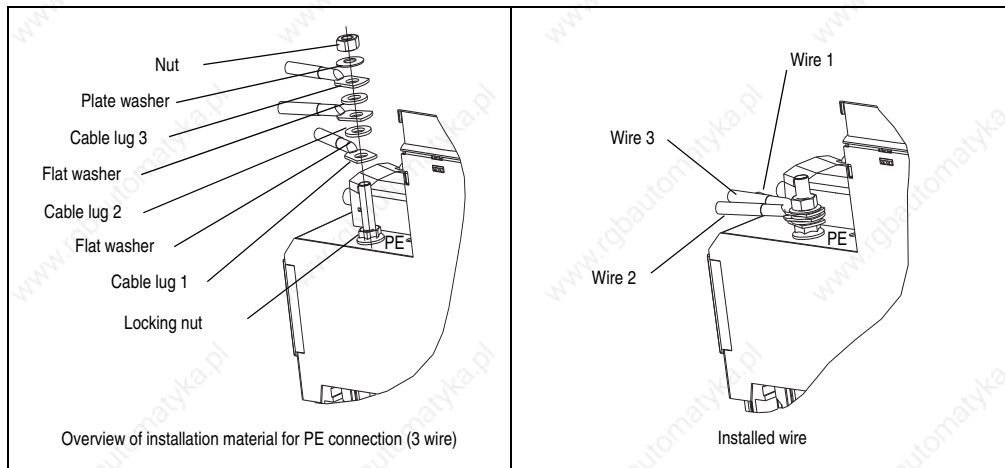


Figure 132: Cable installation connection PE (3 wire)

6.2.6 Input/output circuit diagram

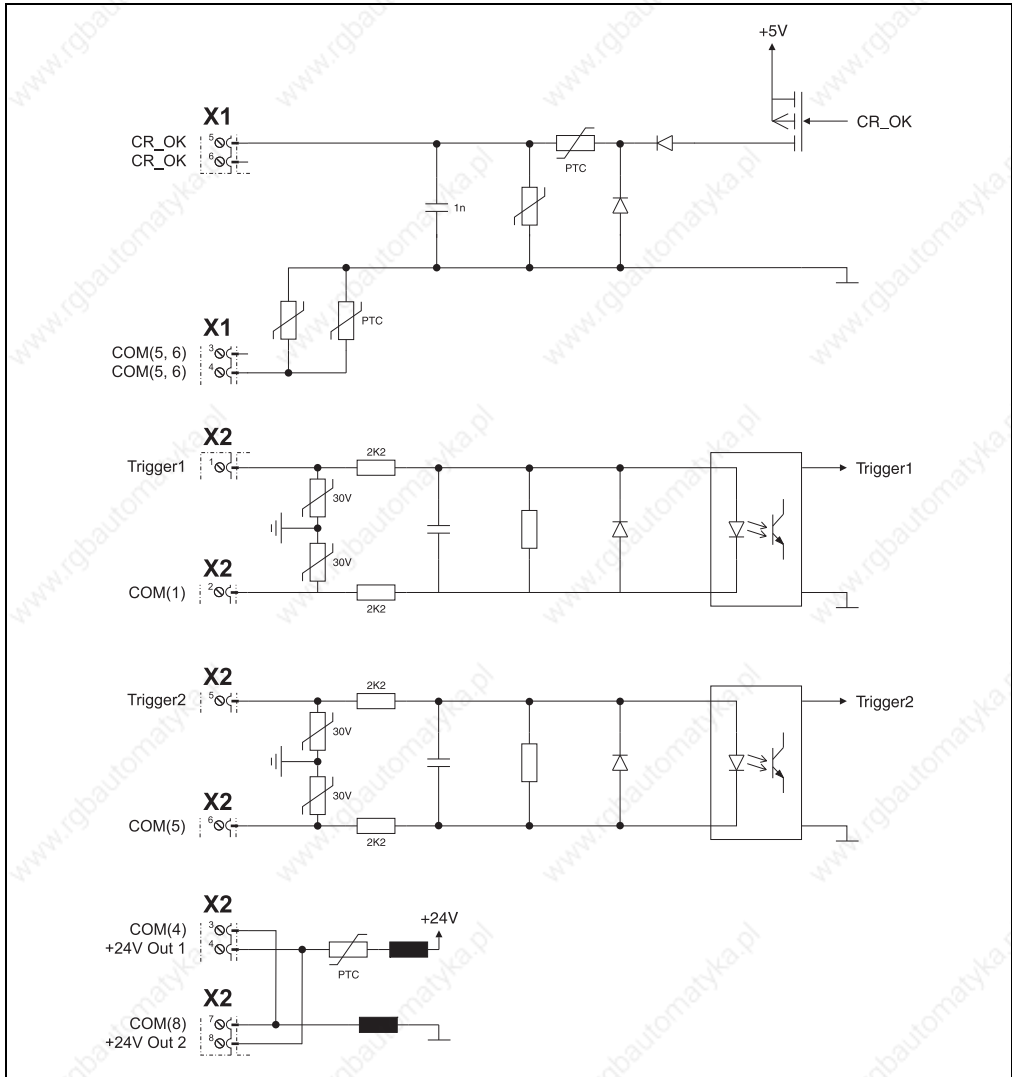


Figure 133: Input/output circuit diagram - 8BVP0880Hx00.000-1

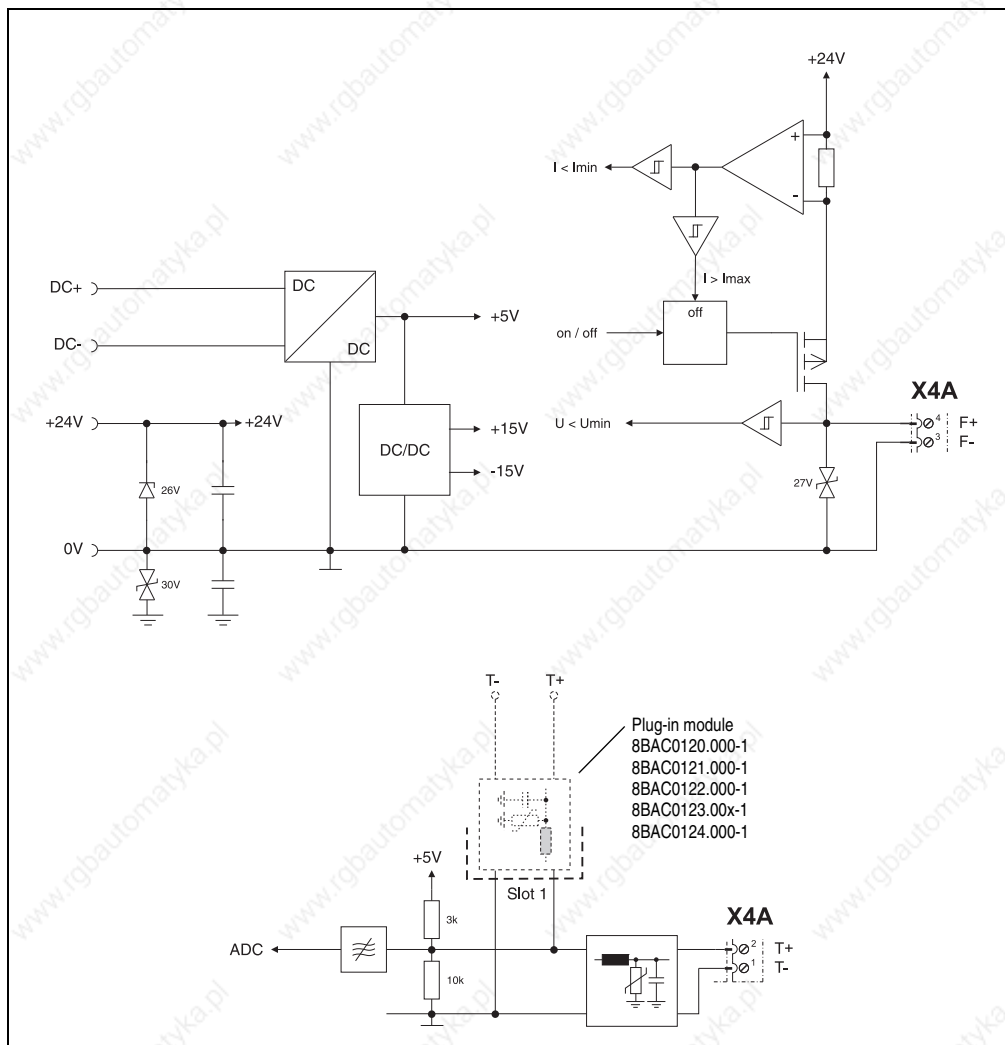


Figure 133: Input/output circuit diagram - 8BVP0880Hx00.000-1 (cont.)

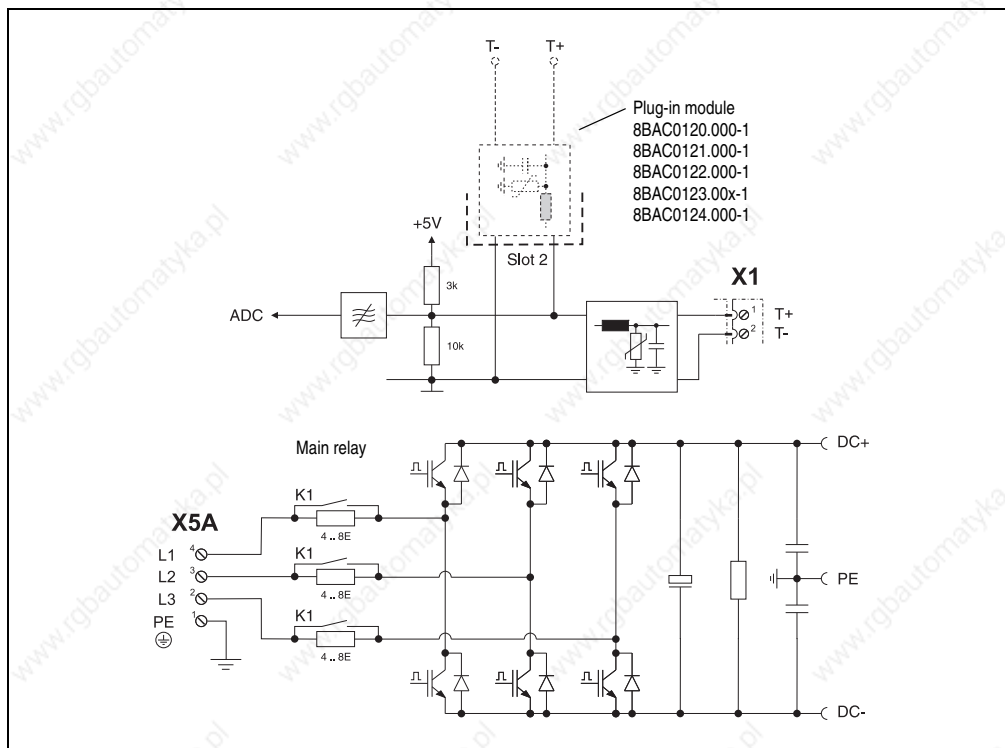


Figure 133: Input/output circuit diagram - 8BVP0880Hx00.000-1 (cont.)

6.3 8BVP1650HC00.000-1

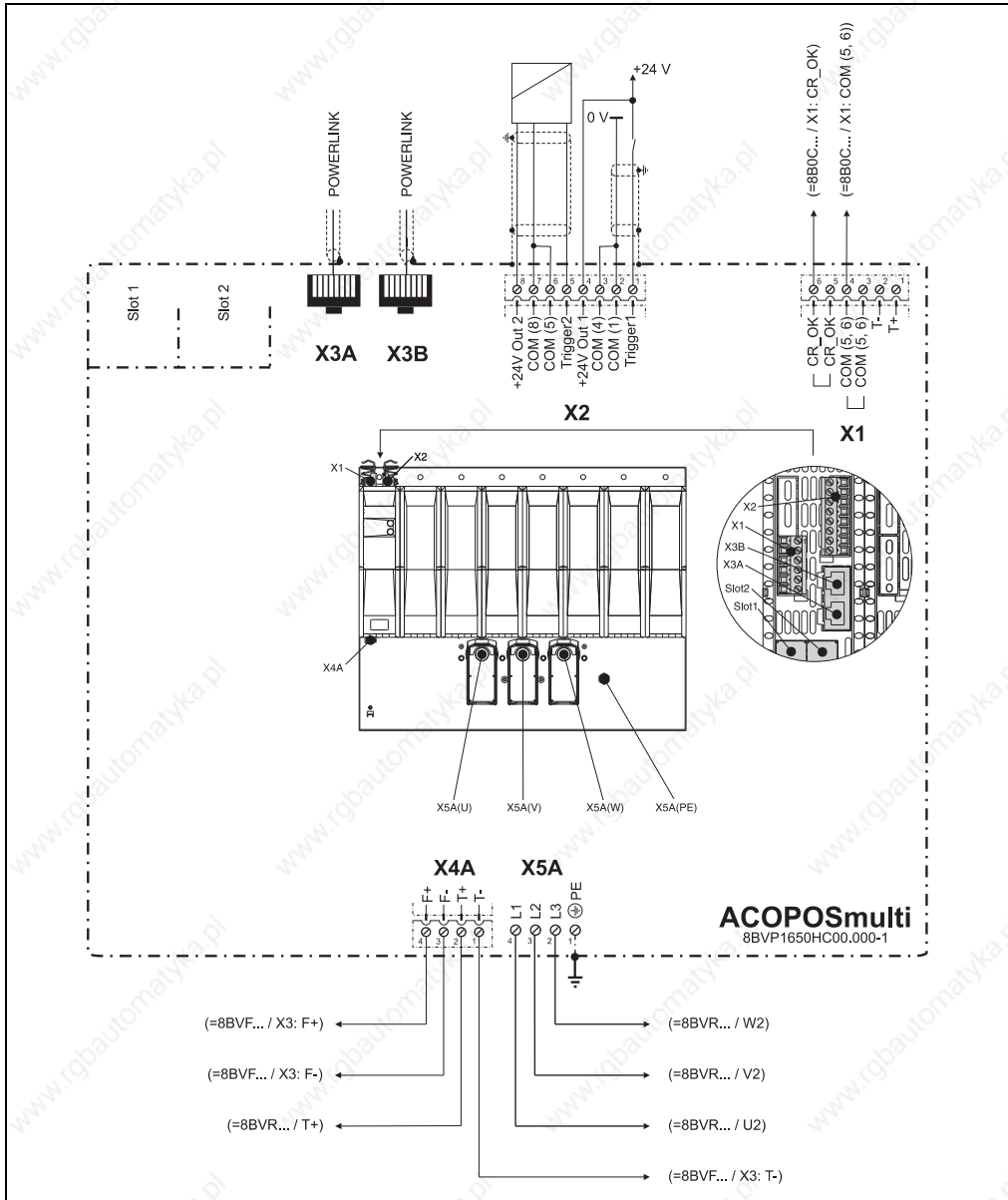


Figure 134: Overview of pin assignments - 8BVP1650HC00.000-1

6.3.1 Pin assignments - X1 plug

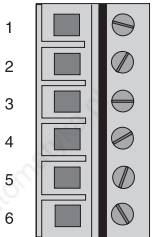
X1		Pin	Name	Function
	1	T+	Temperature sensor +	
	2	T-	Temperature sensor -	
	3	COM (5, 6)	DC bus ready 0 V	
	4	COM (5, 6)	DC bus ready 0 V	
	5	CR_OK	DC bus ready ¹⁾	
	6	CR_OK	DC bus ready ¹⁾	

Table 232: Pin assignments - X1 plug 8BVP1650HC00.000-1

- 1) The CR_OK output is only set if the following condition is met:
The charging relay is closed and the DC bus voltage $U_{DC} > 270$ VDC.

Danger!

The connections for the temperature sensors are isolated circuits. Therefore, these connections are only allowed to be connected to devices or components with at least safe isolation according to IEC 60364-4-41 or EN 61800-5-1.

6.3.2 Pin assignments - X2 plug

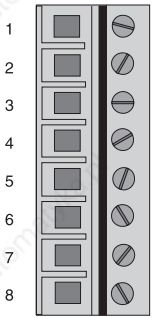
X2		Pin	Name	Function
	1	Trigger1	Trigger 1	
	2	COM (1)	Trigger 1 0 V	
	3	COM (4)	+24 V output 1 0 V	
	4	+24V Out 1	+24 V output 1	
	5	Trigger2	Trigger 2	
	6	COM (5)	Trigger 2 0 V	
	7	COM (8)	+24 V output 2 0 V	
	8	+24V Out 2	+24 V output 2	

Table 233: Pin assignments - X2 plug 8BVP1650HC00.000-1

6.3.3 Pin assignments - X3A, X3B plugs


X3A, X3B	Pin	Name	Function
	1	RXD	Receive signal
	2	RXD\	Receive signal inverted
	3	TXD	Transmit signal
	4	Shield	Shield
	5	Shield	Shield
	6	TXD\	Transmit signal inverted
	7	Shield	Shield
	8	Shield	Shield

Table 234: Pin assignments - X3A, X3B plugs 8BVP1650HC00.000-1

6.3.4 Pin assignments - X4A plug

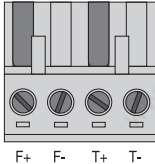
X4A	Name	Function
	T-	Network: Temperature sensor -
	T+	Network: Temperature sensor +
	F-	Network: Fans -
	F+	Network: Fans +

Table 235: Pin assignments - X4A plug 8BVP1650HC00.000-1

Danger!

The connections for the temperature sensors and the fans are isolated circuits. Therefore, these connections are only allowed to be connected to devices or components with at least safe isolation according to IEC 60364-4-41 or EN 61800-5-1.

6.3.5 Pin assignments - X5A plug

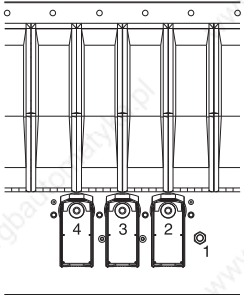
X5A	Pin	Name	Function
	1	PE	Network: Protective ground conductor
	2	L3	Network: Power mains connection L3
	3	L2	Network: Power mains connection L2
	4	L1	Network: Power mains connection L1
Holding torque for the M8 nuts: 7.5 Nm			

Table 236: Pin assignments - Plug 8BVP1650HC00.000-1

Danger!

Before turning on the module, make sure that the housing is properly connected to ground (PE rail). The ground connection must be made, even when testing the module or when operating it for a short time!

Cable installation for power mains connection L1, L2, L3

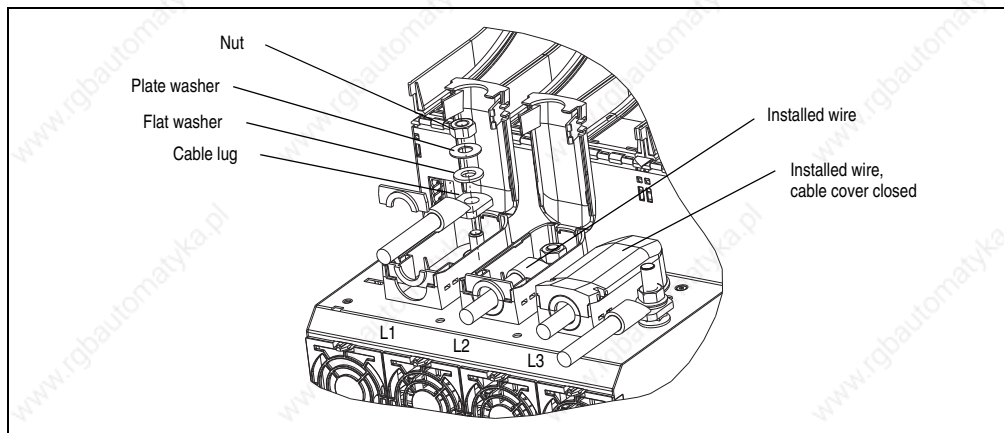


Figure 135: Cable installation for power mains connection L1, L2, L3

Cable installation connection PE (1 wire)

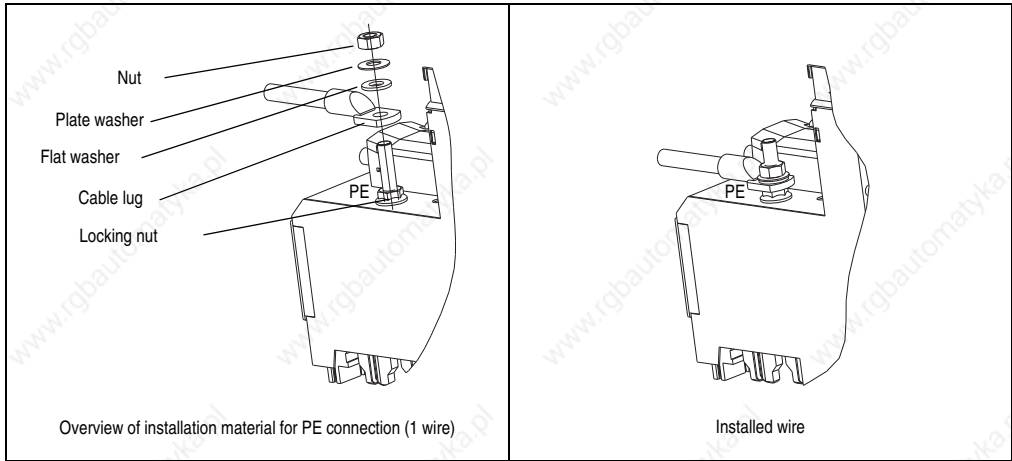


Figure 136: Cable installation connection PE (1 wire)

Cable installation connection PE (3 wire)

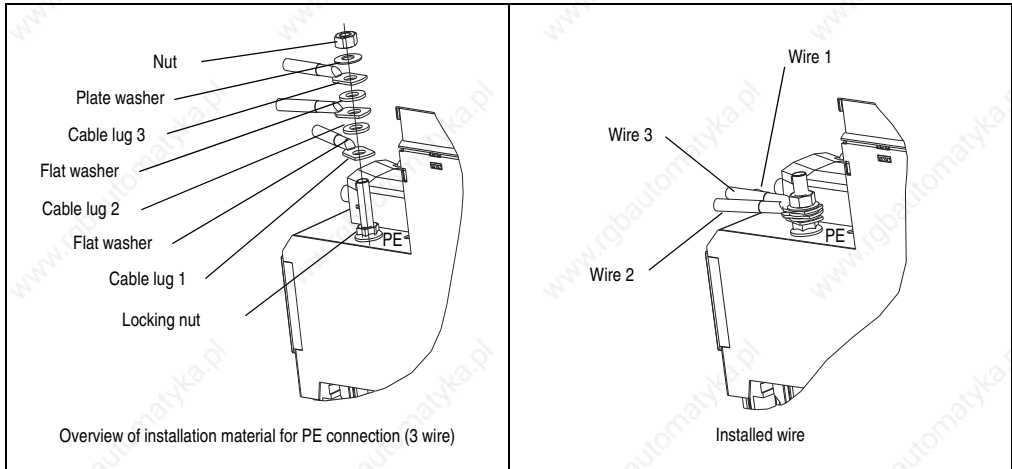


Figure 137: Cable installation connection PE (3 wire)

6.3.6 Input/output circuit diagram

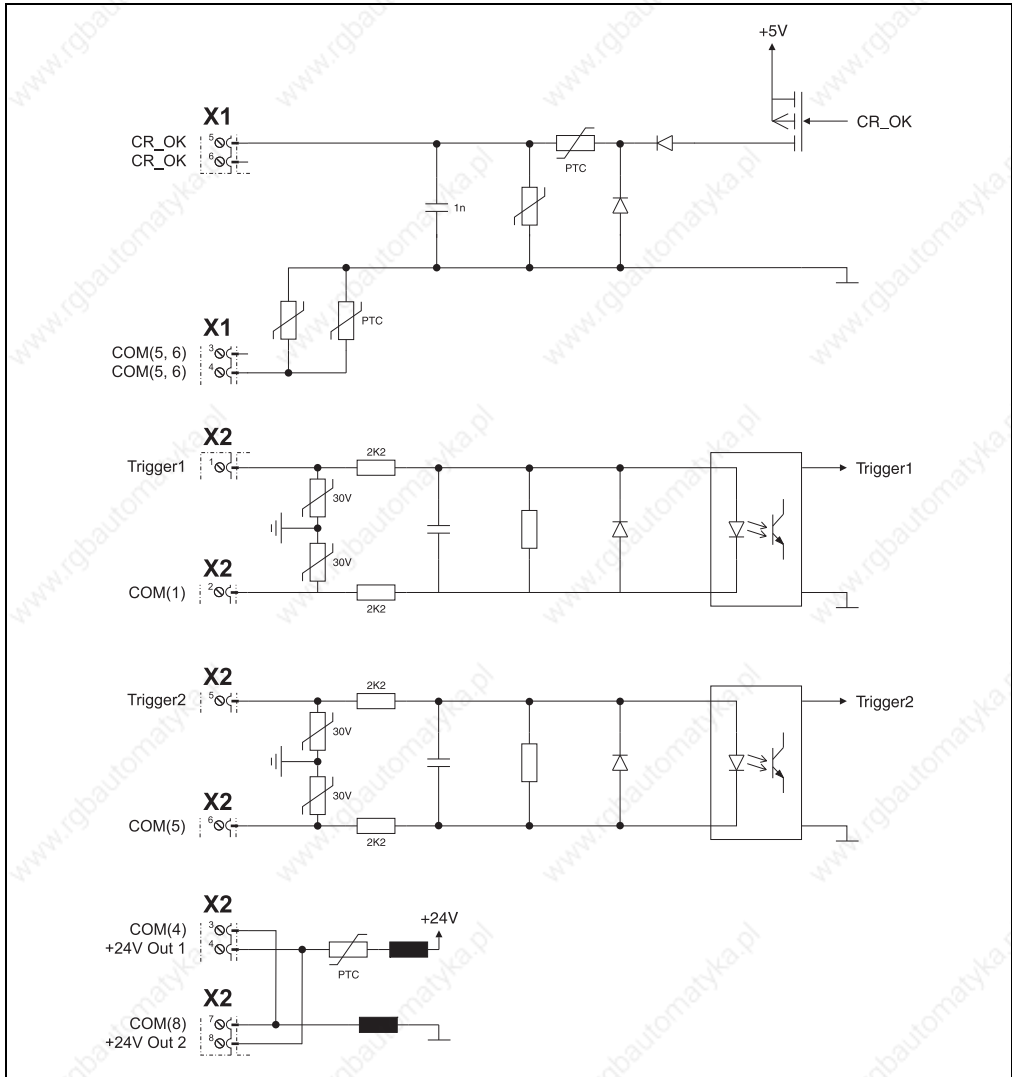


Figure 138: Input/output circuit diagram - 8BVP1650HC00.000-1

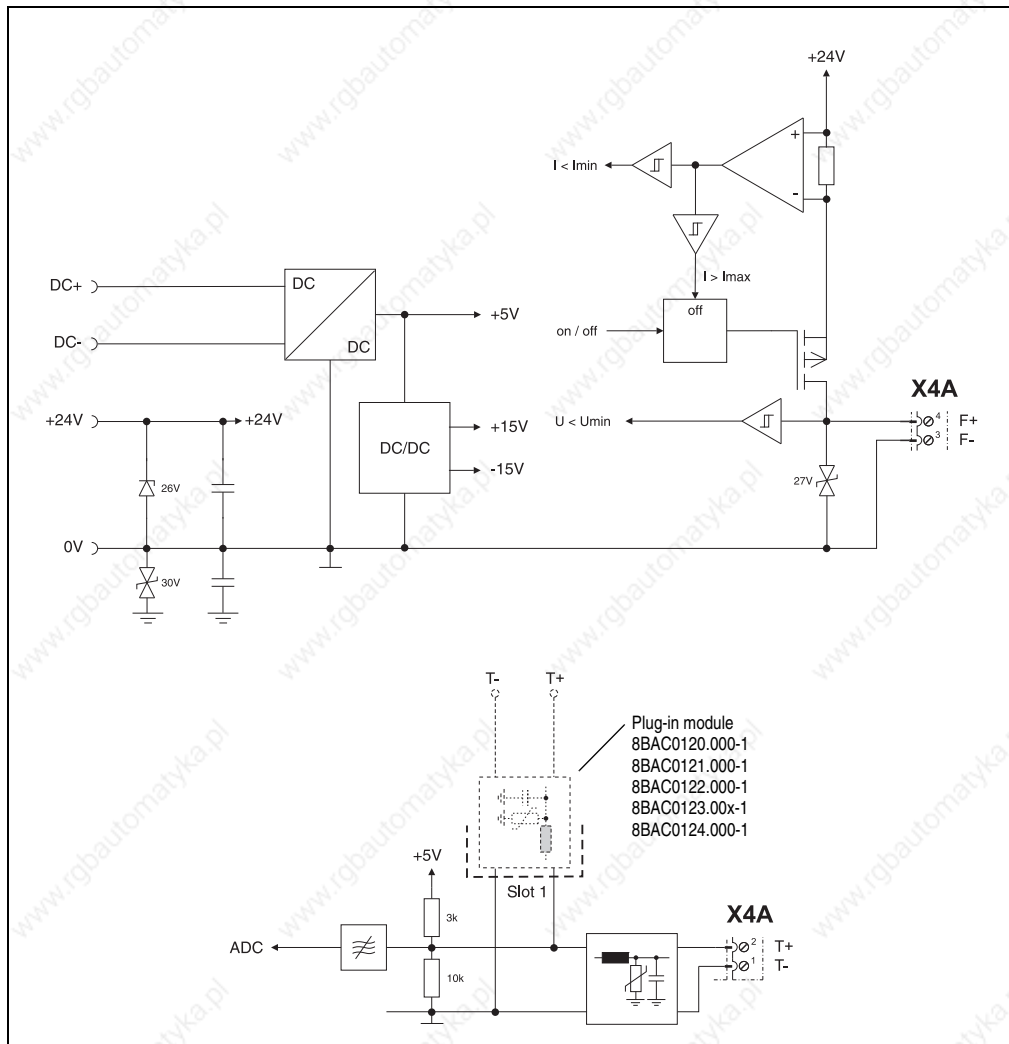


Figure 138: Input/output circuit diagram - 8BVP1650HC00.000-1 (cont.)

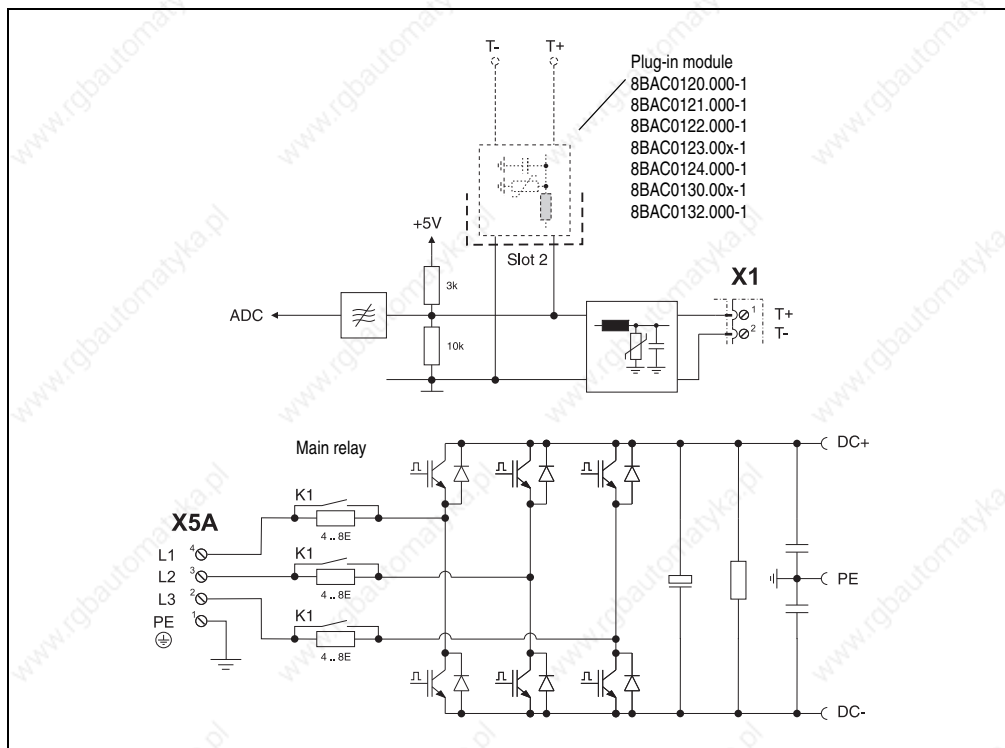


Figure 138: Input/output circuit diagram - 8BVP1650HC00.000-1 (cont.)

7. 8B0C auxiliary supply modules

7.1 8B0C0160Hx00.000-1, 8B0C0320Hx00.000-1

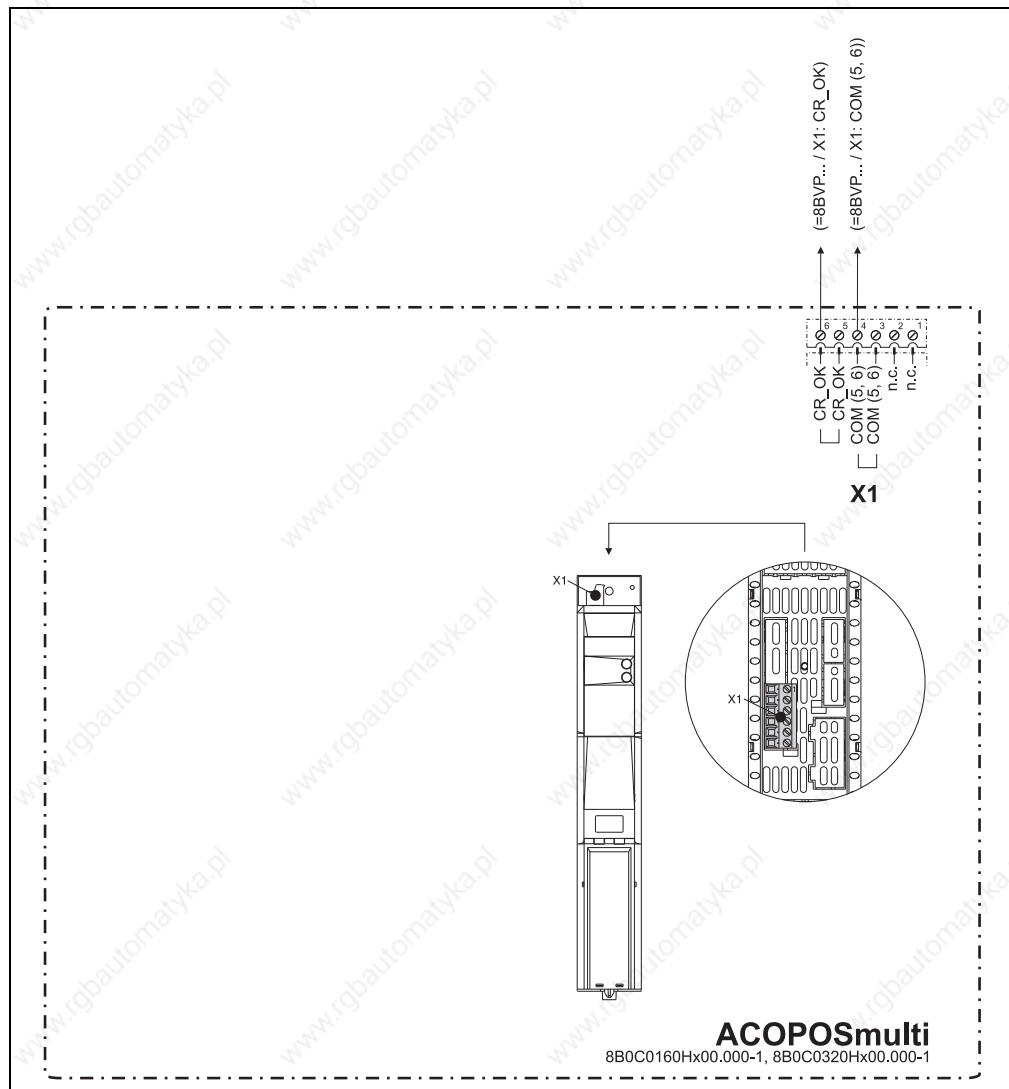


Figure 139: Overview of pin assignments - 8B0C0160Hx00.000-1, 8B0C0320Hx00.000-1

7.1.1 Pin assignments - X1 plug

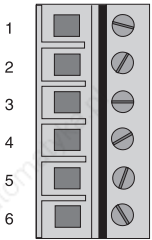
X1		Pin	Name	Function
	1	---	---	---
	2	---	---	---
	3	COM (5, 6)	DC bus ready 0 V	
	4	COM (5, 6)	DC bus ready 0 V	
	5	CR_OK	DC bus ready	
	6	CR_OK	DC bus ready	

Table 237: Pin assignments - X1 plug 8B0C0160Hx00.000-1, 8B0C0320Hx00.000-1

7.1.2 Input/output circuit diagram

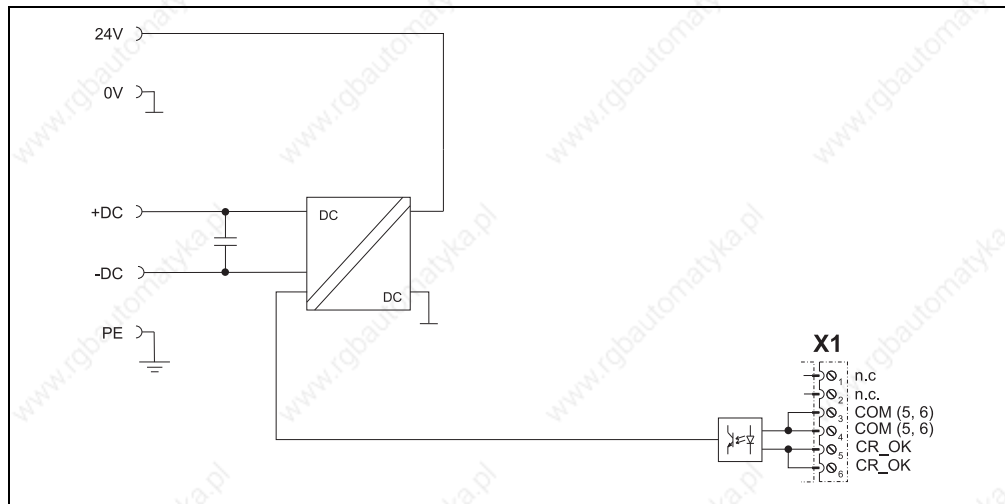


Figure 140: Input/output circuit diagram - 8B0C0160Hx00.000-1, 8B0C0320Hx00.000-1

7.2 8B0C0160Hx00.001-1, 8B0C0320Hx00.002-1

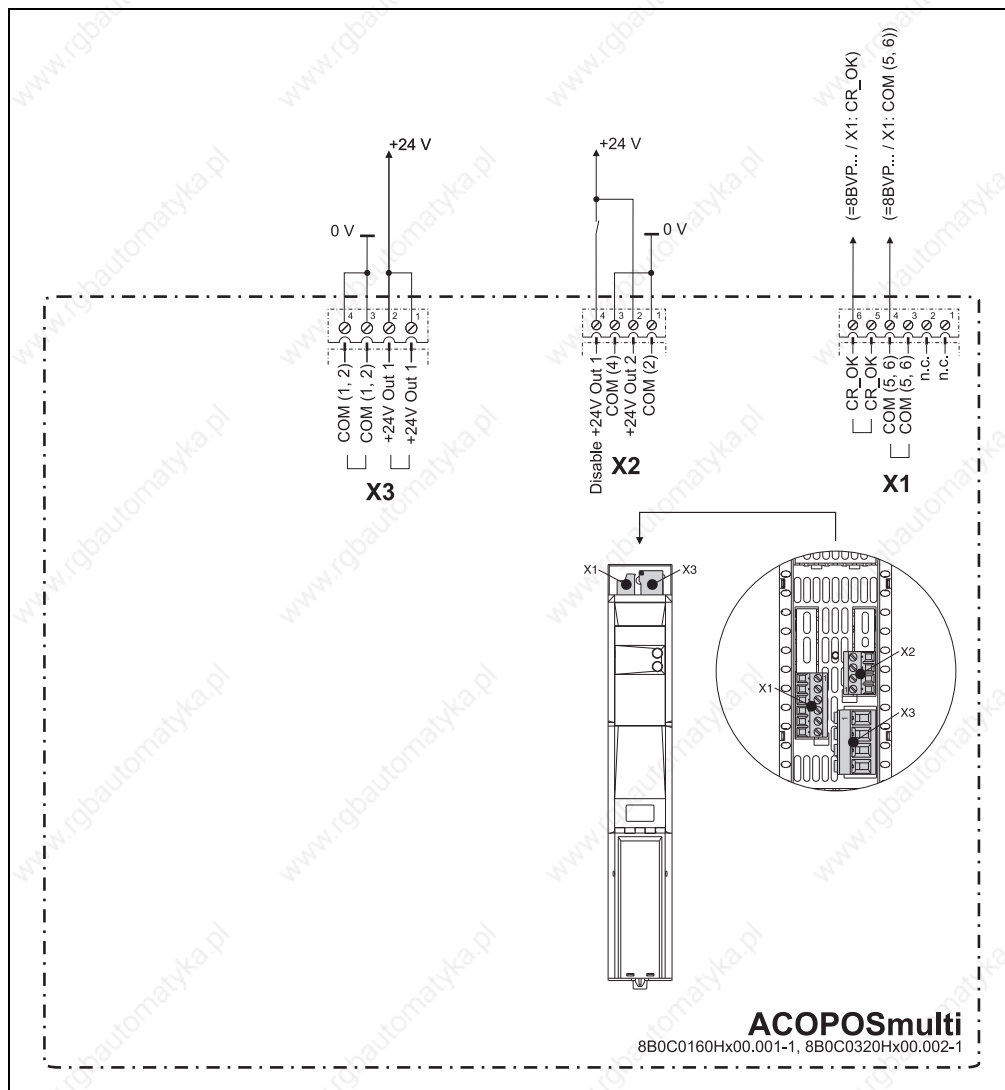


Figure 141: Overview of pin assignments - 8B0C0160Hx00.001-1, 8B0C0320Hx00.002-1

7.2.1 Pin assignments - X1 plug

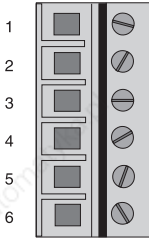
X1		Pin	Name	Function
	1	---	---	---
	2	---	---	---
	3	COM (5, 6)	DC bus ready 0 V	
	4	COM (5, 6)	DC bus ready 0 V	
	5	CR_OK	DC bus ready	
	6	CR_OK	DC bus ready	

Table 238: Pin assignments - X1 plug 8B0C0160Hx00.001-1, 8B0C0320Hx00.002-1

7.2.2 Pin assignments - X2 plug

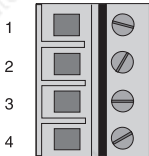
X2		Pin	Name	Function
	1	COM (2)	+24 V output 2 0 V	
	2	+24V Out 2	+24 V output 2	
	3	COM (4)	Disable +24 V output 1 0 V	
	4	Disable +24V Out 1	Disable +24 V output 1	

Table 239: Pin assignments - X2 plug 8B0C0160Hx00.001-1, 8B0C0320Hx00.002-1

7.2.3 Pin assignments - X3 plug

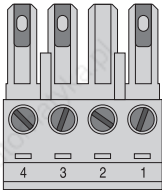
X3		Pin	Name	Function
	1	+24V Out 1	+24 V output 1	
	2	+24V Out 1	+24 V output 1	
	3	COM (1, 2)	+24 V output 1 0 V	
	4	COM (1, 2)	+24 V output 1 0 V	

Table 240: Pin assignments - X3 plug 8B0C0160Hx00.001-1, 8B0C0320Hx00.002-1

Information:

B&R recommends grounding both COM connections (1, 2) on the X3 plug to achieve a defined relationship between the signal ground and ground potential. Alternatively, the COM (2) connection can also be grounded on the X2 plug.

7.2.4 Input/output circuit diagram

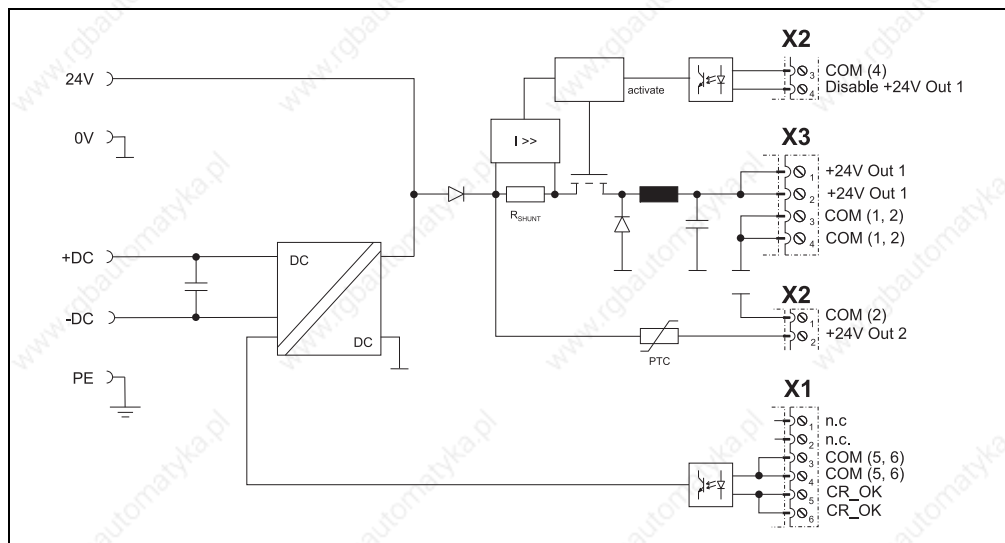


Figure 142: Input/output circuit diagram - 8B0C0160Hx00.001-1, 8B0C0320Hx00.002-1

7.2.5 Parallel connection of multiple 8B0C auxiliary supply modules

Warning!

When the external 24V outputs (24V Out 1, 24 V Out 2) are connected in parallel, the corresponding COM connections must also be connected in parallel!

7.3 8B0C0160HC00.A01-1

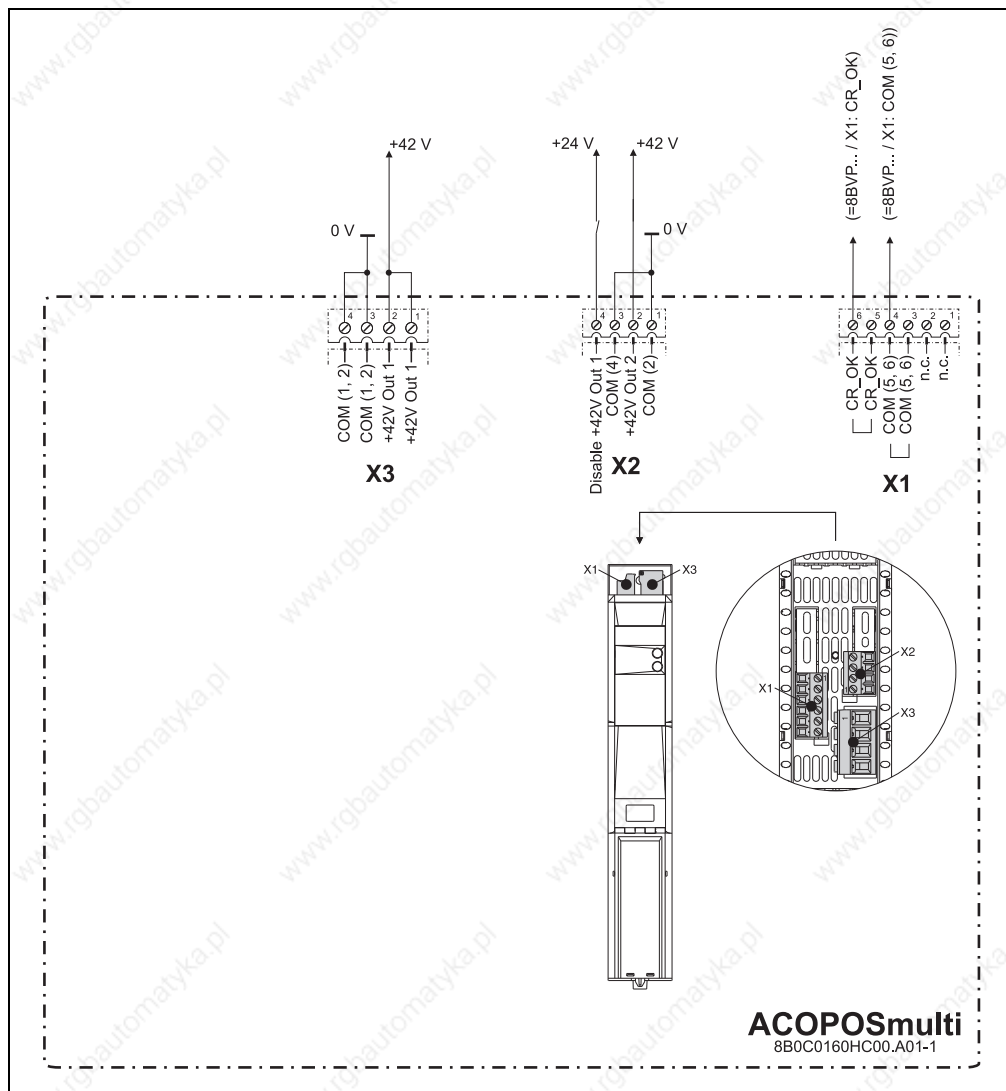


Figure 143: Overview of pin assignments - 8B0C0160HC00.A01-1

7.3.1 Pin assignments - X1 plug

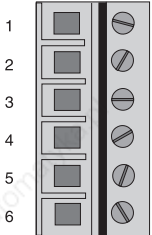
X1		Pin	Name	Function
	1	---	---	---
	2	---	---	---
	3	COM (5, 6)	DC bus ready 0 V	
	4	COM (5, 6)	DC bus ready 0 V	
	5	CR_OK	DC bus ready	
	6	CR_OK	DC bus ready	

Table 241: Pin assignments - X1 plug 8B0C0160HC00.A01-1

7.3.2 Pin assignments - X2 plug

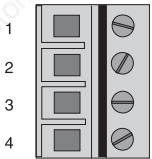
X2		Pin	Name	Function
	1	COM (2)	+42 V output 2 0 V	
	2	+42V Out 2	+42 V output 2	
	3	COM (4)	Disable +42 V output 1 0 V	
	4	Disable +42V Out 1	Disable +42 V output 1	

Table 242: Pin assignments - X2 plug 8B0C0160HC00.A01-1

7.3.3 Pin assignments - X3 plug

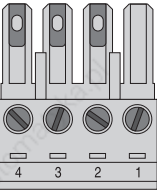
X3		Pin	Name	Function
	1	+42V Out 1	+42 V output 1	
	2	+42V Out 1	+42 V output 1	
	3	COM (1, 2)	+42 V output 1 0 V	
	4	COM (1, 2)	+42 V output 1 0 V	

Table 243: Pin assignments - X3 plug 8B0C0160HC00.A01-1

Information:

B&R recommends grounding both COM connections (1, 2) on the X3 plug to achieve a defined relationship between the signal ground and ground potential. Alternatively, the COM (2) connection can also be grounded on the X2 plug.

7.3.4 Input/output circuit diagram

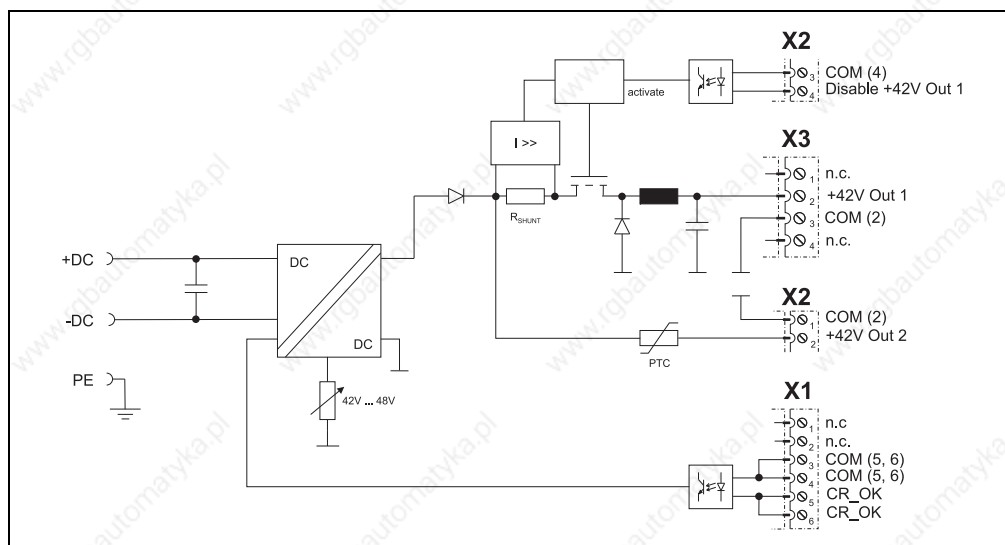


Figure 144: Input/output circuit diagram - 8B0C0160HC00.A01-1

7.3.5 Parallel connection of multiple 8B0C auxiliary supply modules

Warning!

When the external 42V outputs (42V Out 1, 24 V Out 2) are connected in parallel, the corresponding COM connections must also be connected in parallel!

7.4 8B0C0320Hx00.00A-1

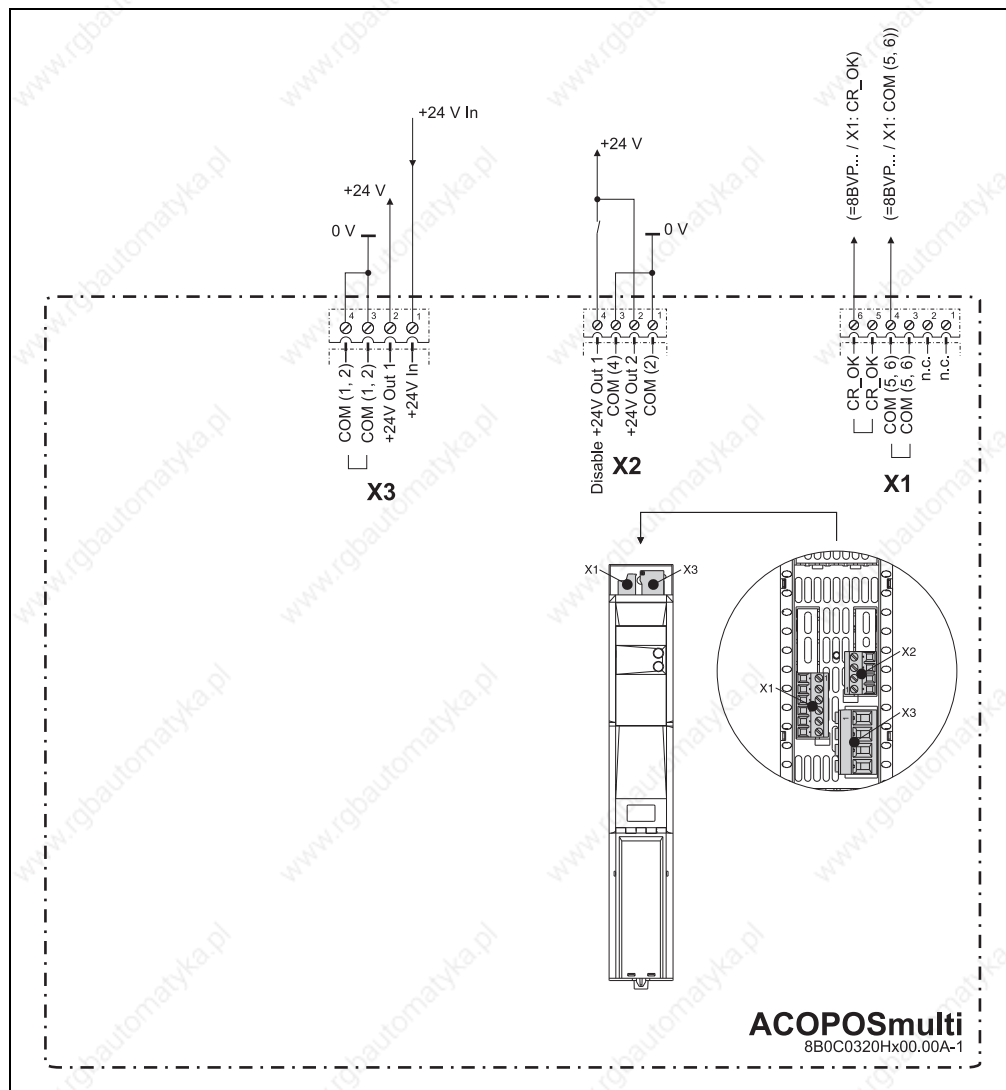


Figure 145: Overview of pin assignments - 8B0C0320Hx00.00A-1

7.4.1 Pin assignments - X1 plug

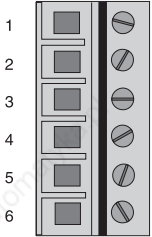
X1	Pin	Name	Function
	1	---	---
	2	---	---
	3	COM (5, 6)	DC bus ready 0 V
	4	COM (5, 6)	DC bus ready 0 V
	5	CR_OK	DC bus ready
	6	CR_OK	DC bus ready

Table 244: Pin assignments - X1 plug 8B0C0320Hx00.00A-1

7.4.2 Pin assignments - X2 plug

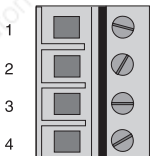
X2	Pin	Name	Function
	1	COM (2)	+24 V output 2 0 V
	2	+24V Out 2	+24 V output 2
	3	COM (4)	Disable +24 V output 1 0 V
	4	Disable +24V Out 1	Disable +24 V output 1

Table 245: Pin assignments - X2 plug 8B0C0320Hx00.00A-1

7.4.3 Pin assignments - X3 plug

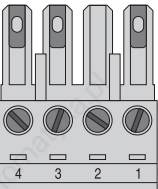
X3	Pin	Name	Function
	1	+24V In	+24 V feed
	2	+24V Out 1	+24 V output 1
	3	COM (1, 2) ¹⁾	+24 V output 1 0 V
	4	COM (1, 2) ¹⁾	+24 V supply, 0 V

Table 246: Pin assignments - X3 plug 8B0C0320Hx00.00A-1

1) The connections X3/3 and X3/4 are connected with each other inside the device.

Information:

B&R recommends grounding both COM connections (1, 2) on the X3 plug to achieve a defined relationship between the signal ground and ground potential. Alternatively, the COM (2) connection can also be grounded on the X2 plug.

7.4.4 Input/output circuit diagram

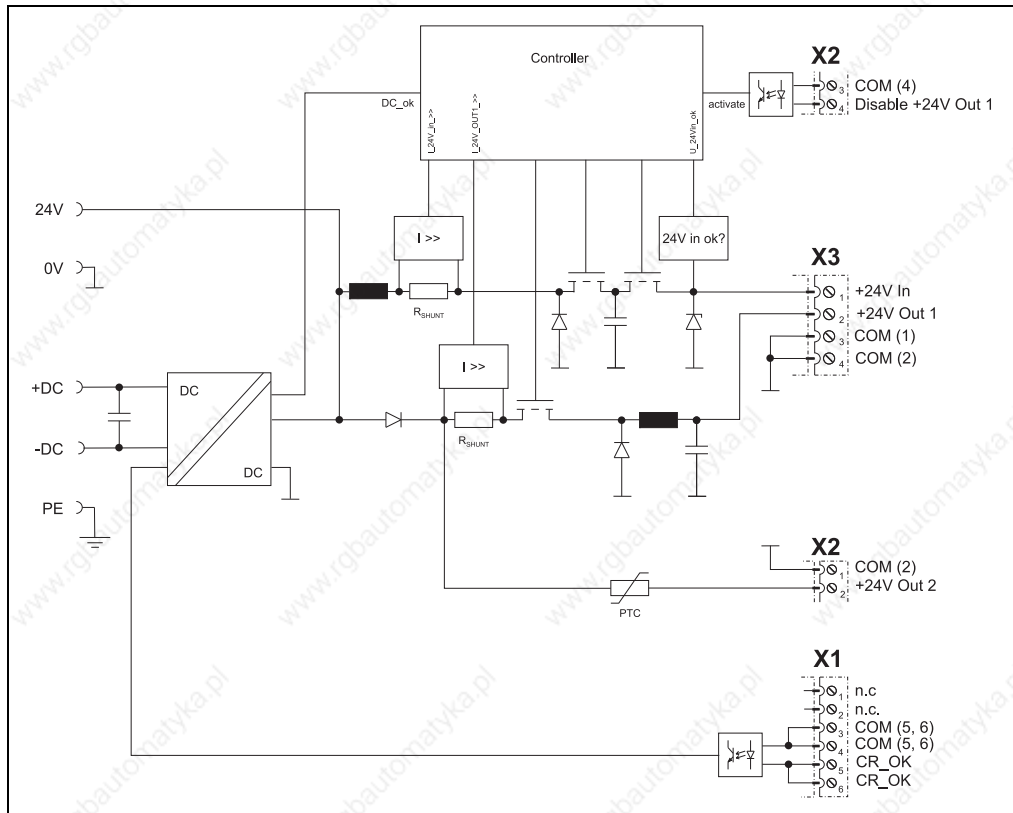


Figure 146: Input/output circuit diagram - 8B0C0320Hx00.00A-1

7.4.5 Parallel connection of multiple 8B0C auxiliary supply modules

Warning!

When the external 24V outputs (24V Out 1, 24 V Out 2) are connected in parallel, the corresponding COM connections must also be connected in parallel!

8. 8BVI inverter modules

8.1 8BVI0014HxS0.000-1, 8BVI0028HxS0.000-1, 8BVI0055HxS0.000-1, 8BVI0110HxS0.000-1

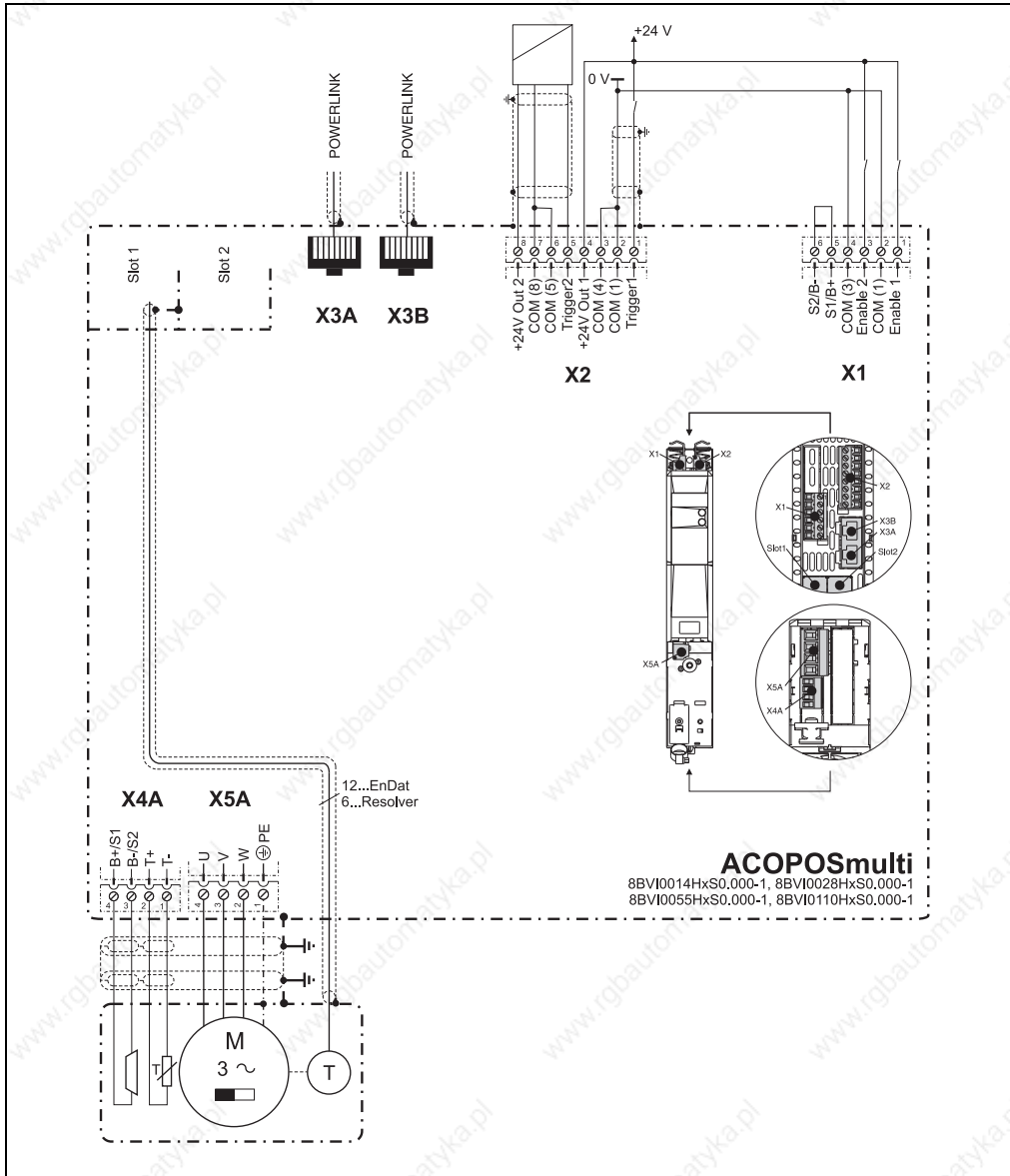


Figure 147: Overview of pin assignments

8BVI0014HxS0.000-1, 8BVI0028HxS0.000-1, 8BVI0055HxS0.000-1, 8BVI0110HxS0.000-1

8.1.1 Pin assignments - X1 plug

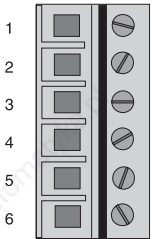
X1		Pin	Name	Function
	1	1	Enable 1 ¹⁾	Axis 1: Enable 1
	2	2	COM (1)	Axis 1: Enable 1 0 V
	3	3	Enable 2 ¹⁾	Axis 1: Enable 2
	4	4	COM (3)	Axis 1: Enable 2 0 V
	5	5	S1/B+ ^{1) 2)}	Axis 1: Brake + / Activation for the external holding brake
	6	6	S2/B- ^{1) 2)}	Axis 1: Brake - / Activation for the external holding brake

Table 247: Pin assignments - X1 plug

8BVI0014HxS0.000-1, 8BVI0028HxS0.000-1, 8BVI0055HxS0.000-1, 8BVI0110HxS0.000-1

1) The wiring is not permitted to exceed a total length of 3 m.

2) If the holding brake is connected via an additional external relay contact (ground-in e.g. via the connections S1/S2) instead of via the internal transistor, then the internal quenching circuit has no effect! In this case, the customer must make sure that neither the relay contact nor the braking coil are damaged when switching off the brake. This can be done by interconnecting the coil or - better still - interconnecting the contact with a quenching circuit.

Danger!

The connections for the motor holding brake are isolated circuits. Therefore, these connections are only allowed to be connected to devices or components with at least safe isolation according to IEC 60364-4-41 or EN 61800-5-1.

Caution!

If B+ and B are swapped when connecting the permanent magnet holding brakes, then the brakes cannot be opened! ACOPOSmulti inverter modules cannot determine if a holding brake is connected with reverse polarity!

8.1.2 Pin assignments - X2 plug

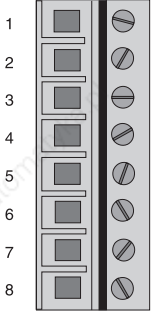
X2	Pin	Name	Function
	1	Trigger1	Trigger 1
	2	COM (1)	Trigger 1 0 V
	3	COM (4)	+24 V output 1 0 V
	4	+24 V Out 1	+24 V output 1
	5	Trigger2	Trigger 2
	6	COM (5)	Trigger 2 0 V
	7	COM (8)	+24 V output 2 0 V
	8	+24 V Out 2	+24 V output 2

Table 248: Pin assignments - X2 plug

8BVI0014HxS0.000-1, 8BVI0028HxS0.000-1, 8BVI0055HxS0.000-1, 8BVI0110HxS0.000-1

8.1.3 Pin assignments - X3A, X3B plugs


X3A, X3B	Pin	Name	Function
	1	RXD	Receive signal
	2	RXD\	Receive signal inverted
	3	TXD	Transmit signal
	4	Shield	Shield
	5	Shield	Shield
	6	TXD\	Transmit signal inverted
	7	Shield	Shield
	8	Shield	Shield

Table 249: Pin assignments - X3A, X3B plugs

8BVI0014HxS0.000-1, 8BVI0028HxS0.000-1, 8BVI0055HxS0.000-1, 8BVI0110HxS0.000-1

8.1.4 Pin assignments - X4A plug

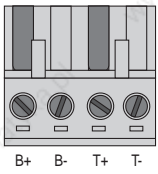
X4A	Name	Function
	T-	Axis 1: Temperature sensor -
	T+	Axis 1: Temperature sensor +
	B-/S2 ^{1) 2)}	Axis 1: Brake - / Activation for the external holding brake
	B+/S1 ^{1) 2)}	Axis 1: Brake + / Activation for the external holding brake

Table 250: Pin assignments - X4A plug

8BVI0014HxS0.000-1, 8BVI0028HxS0.000-1, 8BVI0055HxS0.000-1, 8BVI0110HxS0.000-1

1) The wiring is not permitted to exceed a total length of 3 m.

2) If the holding brake is connected via an additional external relay contact (ground-in e.g. via the connections S1/S2) instead of via the internal transistor, then the internal quenching circuit has no effect! In this case, the customer must make sure that neither the relay contact nor the braking coil are damaged when switching off the brake. This can be done by interconnecting the coil or - better still - interconnecting the contact with a quenching circuit.

Danger!

The connections for the motor temperature sensors and the motor holding brake are isolated circuits. Therefore, these connections are only allowed to be connected to devices or components with at least safe isolation according to IEC 60364-4-41 or EN 61800-5-1.

Caution!

If B+ and B are swapped when connecting the permanent magnet holding brakes, then the brakes cannot be opened! ACOPOSmulti inverter modules cannot determine if a holding brake is connected with reverse polarity!

8.1.5 Pin assignments - X5A plug

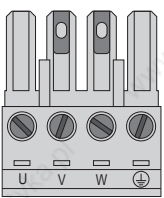
X5A	Name	Function
	PE	Axis 1: Protective ground conductor
	W	Axis 1: Motor connection W
	V	Axis 1: Motor connection V
	U	Axis 1: Motor connection U

Table 251: Pin assignments - X5A plug

8BVI0014HxS0.000-1, 8BVI0028HxS0.000-1, 8BVI0055HxS0.000-1, 8BVI0110HxS0.000-1

8.1.6 Input/output circuit diagram

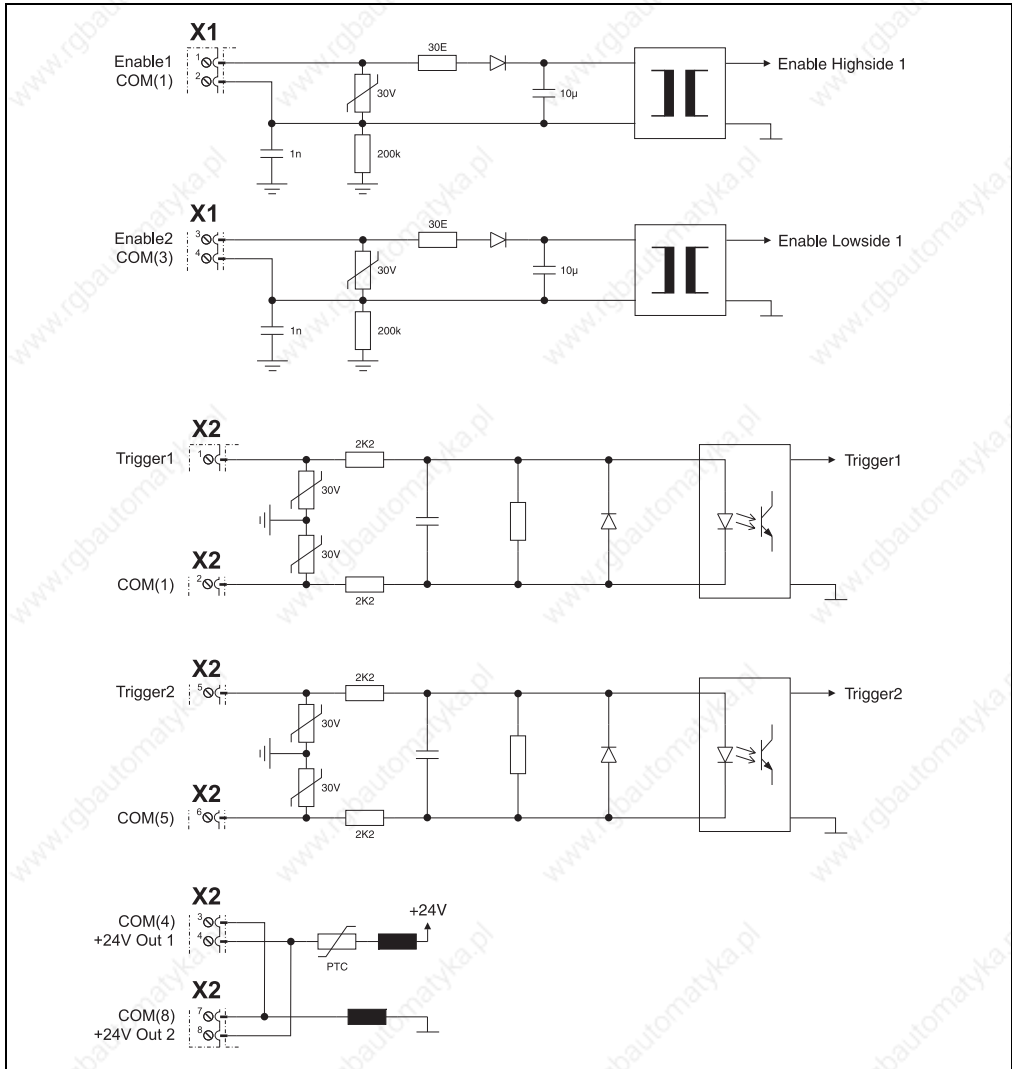


Figure 148: Input/output circuit diagram

8BVI0014HxS0.000-1, 8BVI0028HxS0.000-1, 8BVI0055HxS0.000-1, 8BVI0110HxS0.000-1

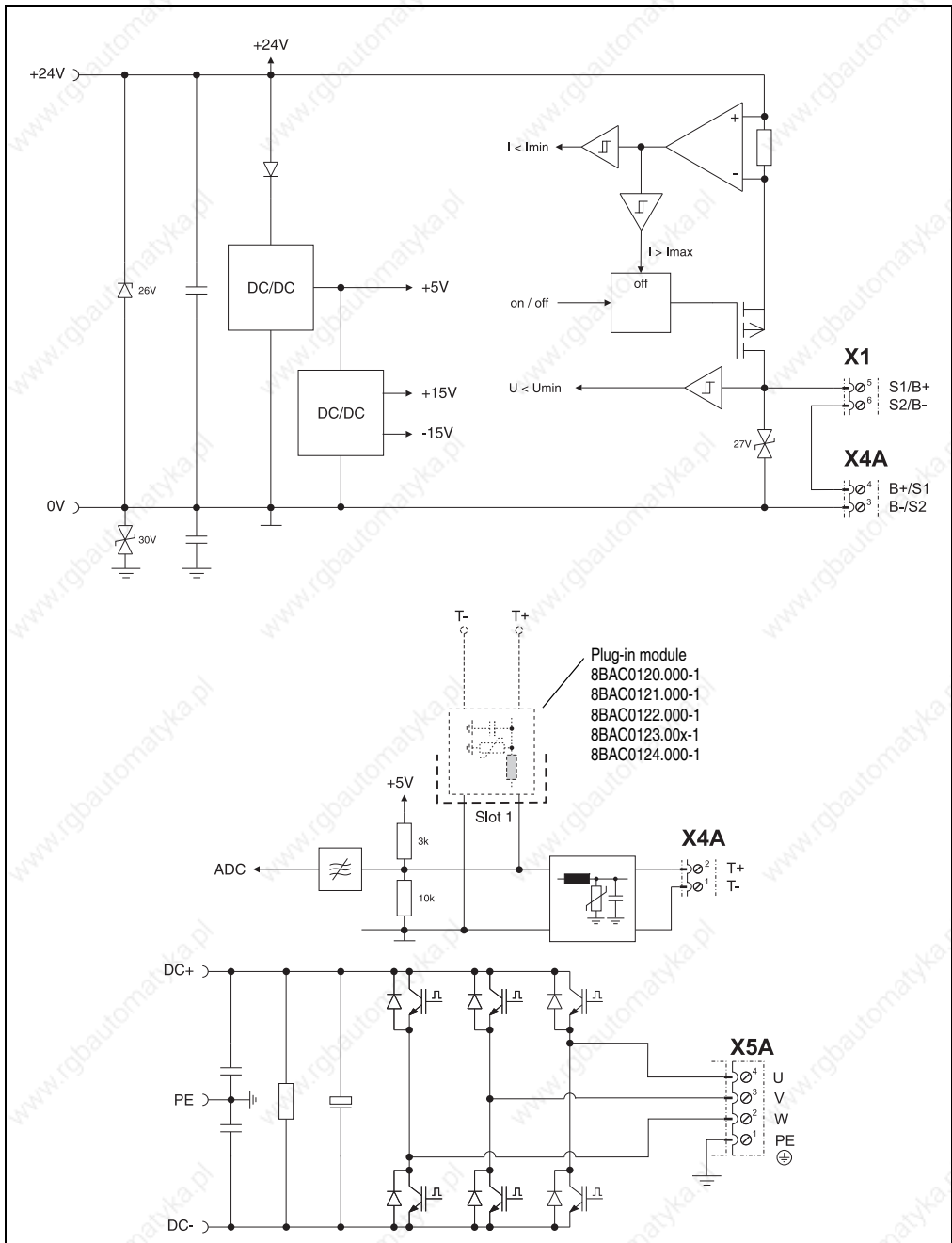


Figure 148: Input/output circuit diagram

8BVI0014HxS0.000-1, 8BVI0028HxS0.000-1, 8BVI0055HxS0.000-1, 8BVI0110HxS0.000-1 (cont.)

8.2 8BVI0014HxD0.000-1, 8BVI0028HxD0.000-1, 8BVI0055HxD0.000-1

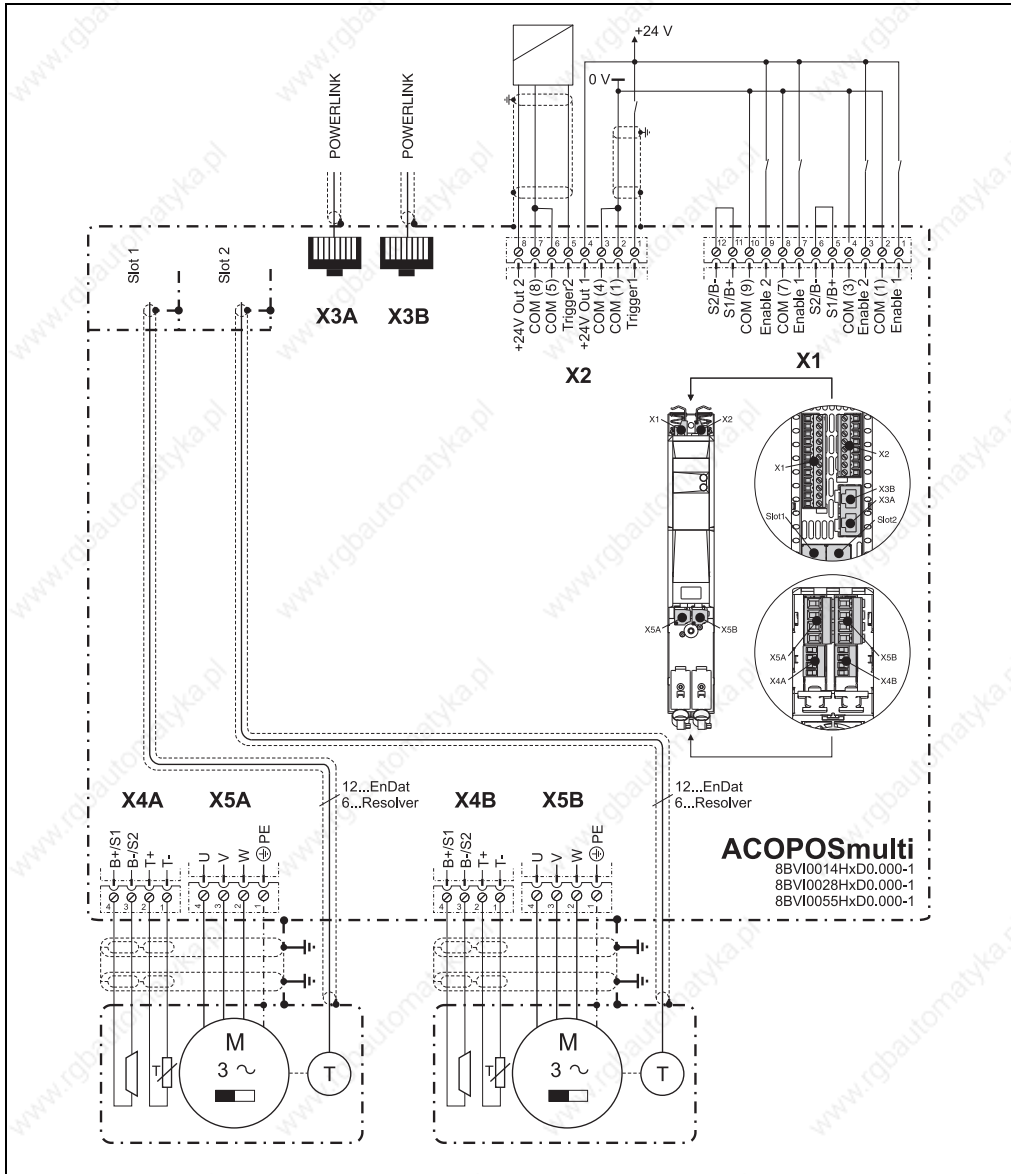


Figure 149: Overview of pin assignments
 8BVI0014HxD0.000-1, 8BVI0028HxD0.000-1, 8BVI0055HxD0.000-1

8.2.1 Pin assignments - X1 plug

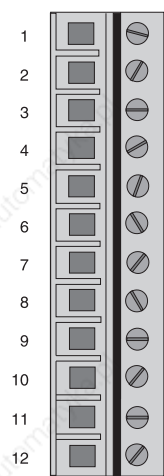
X1		Pin	Name	Function
	1	1	Enable 1 ¹⁾	Axis 2: Enable 1
	2	2	COM (1)	Axis 2: Enable 1 0 V
	3	3	Enable 2 ¹⁾	Axis 2: Enable 2
	4	4	COM (3)	Axis 2: Enable 2 0 V
	5	5	S1/B+ ^{1) 2)}	Axis 2: Brake + / Activation for the external holding brake
	6	6	S2/B- ^{1) 2)}	Axis 2: Brake - / Activation for the external holding brake
	7	7	Enable 1 ¹⁾	Axis 1: Enable 1
	8	8	COM (7)	Axis 1: Enable 1 0 V
	9	9	Enable 2 ¹⁾	Axis 1: Enable 2
	10	10	COM (9)	Axis 1: Enable 2 0 V
	11	11	S1/B+ ^{1) 2)}	Axis 1: Brake + / Activation for the external holding brake
	12	12	S2/B- ^{1) 2)}	Axis 1: Brake - / Activation for the external holding brake

Table 252: Pin assignments - X1 plug

8BVI0014HxD0.000-1, 8BVI0028HxD0.000-1, 8BVI0055HxD0.000-1

1) The wiring is not permitted to exceed a total length of 3 m.

2) If the holding brake is connected via an additional external relay contact (ground-in e.g. via the connections S1/S2) instead of via the internal transistor, then the internal quenching circuit has no effect! In this case, the customer must make sure that neither the relay contact nor the braking coil are damaged when switching off the brake. This can be done by interconnecting the coil or - better still - interconnecting the contact with a quenching circuit.

Danger!

The connections for the motor holding brakes are isolated circuits. Therefore, these connections are only allowed to be connected to devices or components with at least safe isolation according to IEC 60364-4-41 or EN 61800-5-1.

Caution!

If B+ and B are swapped when connecting the permanent magnet holding brakes, then the brakes cannot be opened! ACOPOSmulti inverter modules cannot determine if a holding brake is connected with reverse polarity!

8.2.2 Pin assignments - X2 plug

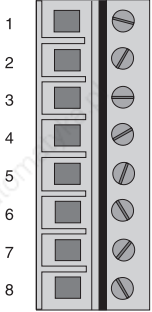
X2	Pin	Name	Function
	1	Trigger1	Trigger 1
	2	COM (1)	Trigger 1 0 V
	3	COM (4)	+24 V output 1 0 V
	4	+24 V Out 1	+24 V output 1
	5	Trigger2	Trigger 2
	6	COM (5)	Trigger 2 0 V
	7	COM (8)	+24 V output 2 0 V
	8	+24 V Out 2	+24 V output 2

Table 253: Pin assignments - X2 plug
8BVI0014HxD0.000-1, 8BVI0028HxD0.000-1, 8BVI0055HxD0.000-1

8.2.3 Pin assignments - X3A, X3B plugs


X3A, X3B	Pin	Name	Function
	1	RXD	Receive signal
	2	RXD\	Receive signal inverted
	3	TXD	Transmit signal
	4	Shield	Shield
	5	Shield	Shield
	6	TXD\	Transmit signal inverted
	7	Shield	Shield
	8	Shield	Shield

Table 254: Pin assignments - X3A, X3B plugs
8BVI0014HxD0.000-1, 8BVI0028HxD0.000-1, 8BVI0055HxD0.000-1

8.2.4 Pin assignments - X4A plug

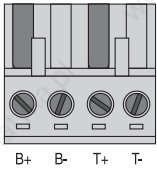
X4A	Name	Function
 <p>B+ B- T+ T-</p>	T-	Axis 1: Temperature sensor -
	T+	Axis 1: Temperature sensor +
	B-/S2 ^{1) 2)}	Axis 1: Brake - / Activation for the external holding brake
	B+/S1 ^{1) 2)}	Axis 1: Brake + / Activation for the external holding brake

Table 255: Pin assignments - X4A plug

8BVI0014HxD0.000-1, 8BVI0028HxD0.000-1, 8BVI0055HxD0.000-1

- 1) The wiring is not permitted to exceed a total length of 3 m.
- 2) If the holding brake is connected via an additional external relay contact (ground-in e.g. via the connections S1/S2) instead of via the internal transistor, then the internal quenching circuit has no effect! In this case, the customer must make sure that neither the relay contact nor the braking coil are damaged when switching off the brake. This can be done by interconnecting the coil or - better still - interconnecting the contact with a quenching circuit.

Danger!

The connections for the motor temperature sensors and the motor holding brake are isolated circuits. Therefore, these connections are only allowed to be connected to devices or components with at least safe isolation according to IEC 60364-4-41 or EN 61800-5-1.

Caution!

If B+ and B- are swapped when connecting the permanent magnet holding brakes, then the brakes cannot be opened! ACOPOSmulti inverter modules cannot determine if a holding brake is connected with reverse polarity!

8.2.5 Pin assignments - X4B plug

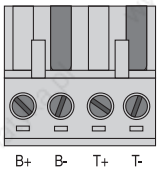
X4b	Name	Function
	T-	Axis 2: Temperature sensor -
	T+	Axis 2: Temperature sensor +
	B-/S2 ^{1) 2)}	Axis 2: Brake - / Activation for the external holding brake
	B+/S1 ^{1) 2)}	Axis 2: Brake + / Activation for the external holding brake

Table 256: Pin assignments - X4B plug

8BVI0014HxD0.000-1, 8BVI0028HxD0.000-1, 8BVI0055HxD0.000-1

- 1) The wiring is not permitted to exceed a total length of 3 m.
- 2) If the holding brake is connected via an additional external relay contact (ground-in e.g. via the connections S1/S2) instead of via the internal transistor, then the internal quenching circuit has no effect! In this case, the customer must make sure that neither the relay contact nor the braking coil are damaged when switching off the brake. This can be done by interconnecting the coil or - better still - interconnecting the contact with a quenching circuit.

Danger!

The connections for the motor temperature sensors and the motor holding brake are isolated circuits. Therefore, these connections are only allowed to be connected to devices or components with at least safe isolation according to IEC 60364-4-41 or EN 61800-5-1.

Caution!

If B+ and B- are swapped when connecting the permanent magnet holding brakes, then the brakes cannot be opened! ACOPOSmulti inverter modules cannot determine if a holding brake is connected with reverse polarity!

8.2.6 Pin assignments - X5A plug

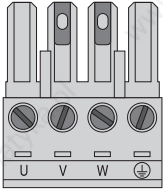
X5A	Name	Function
	PE	Axis 1: Protective ground conductor
	W	Axis 1: Motor connection W
	V	Axis 1: Motor connection V
	U	Axis 1: Motor connection U

Table 257: Pin assignments - X5A plug

8BVI0014HxD0.000-1, 8BVI0028HxD0.000-1, 8BVI0055HxD0.000-1

8.2.7 Pin assignments - X5B plug

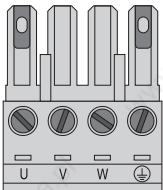
X5B	Name	Function
	PE	Axis 2: Protective ground conductor
	W	Axis 2: Motor connection W
	V	Axis 2: Motor connection V
	U	Axis 2: Motor connection U

Table 258: Pin assignments - X5B plug

8BVI0014HxD0.000-1, 8BVI0028HxD0.000-1, 8BVI0055HxD0.000-1

8.2.8 Input/output circuit diagram

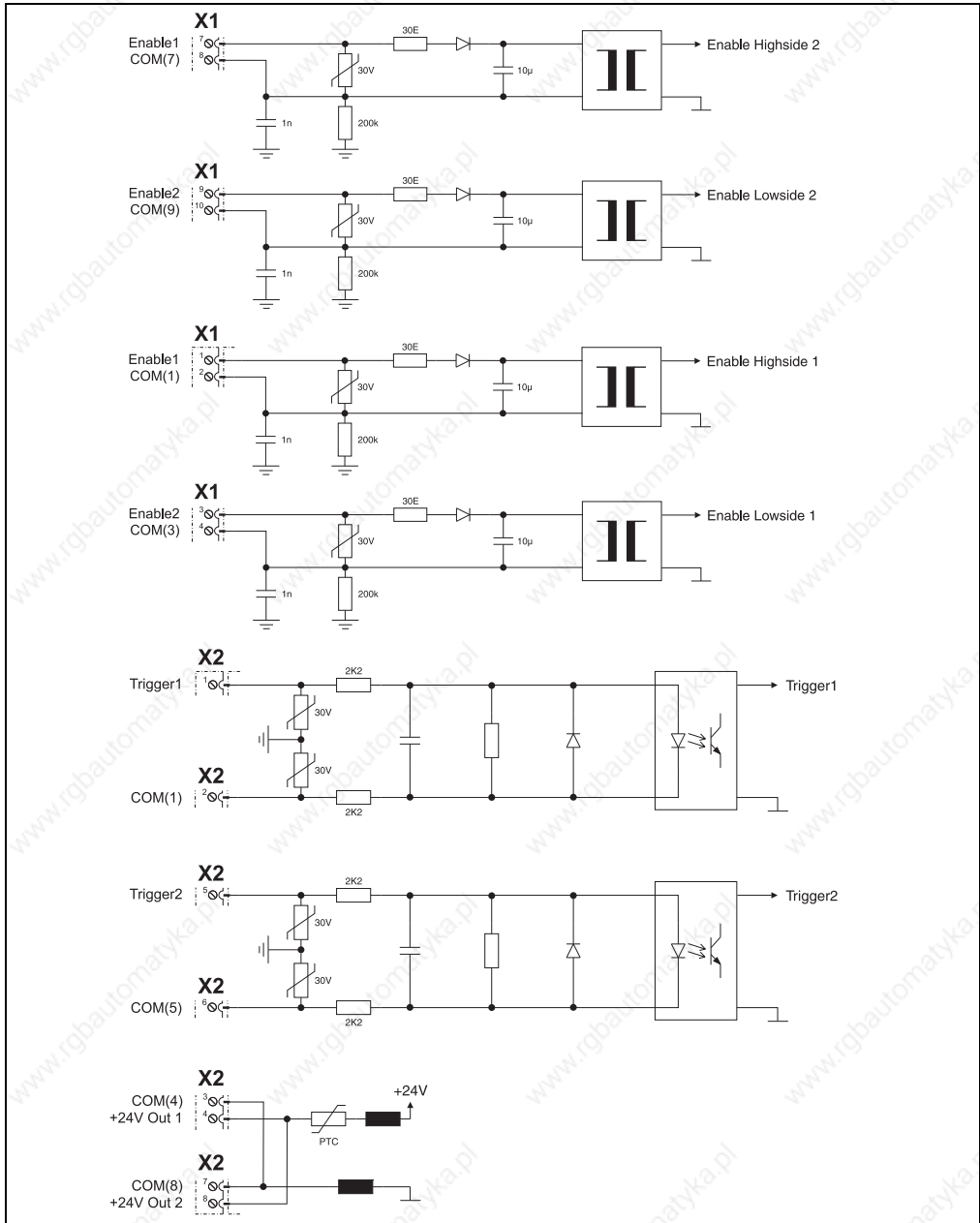


Figure 150: Input/output circuit diagram - 8BVI0014HxD0.000-1, 8BVI0028HxD0.000-1, 8BVI0055HxD0.000-

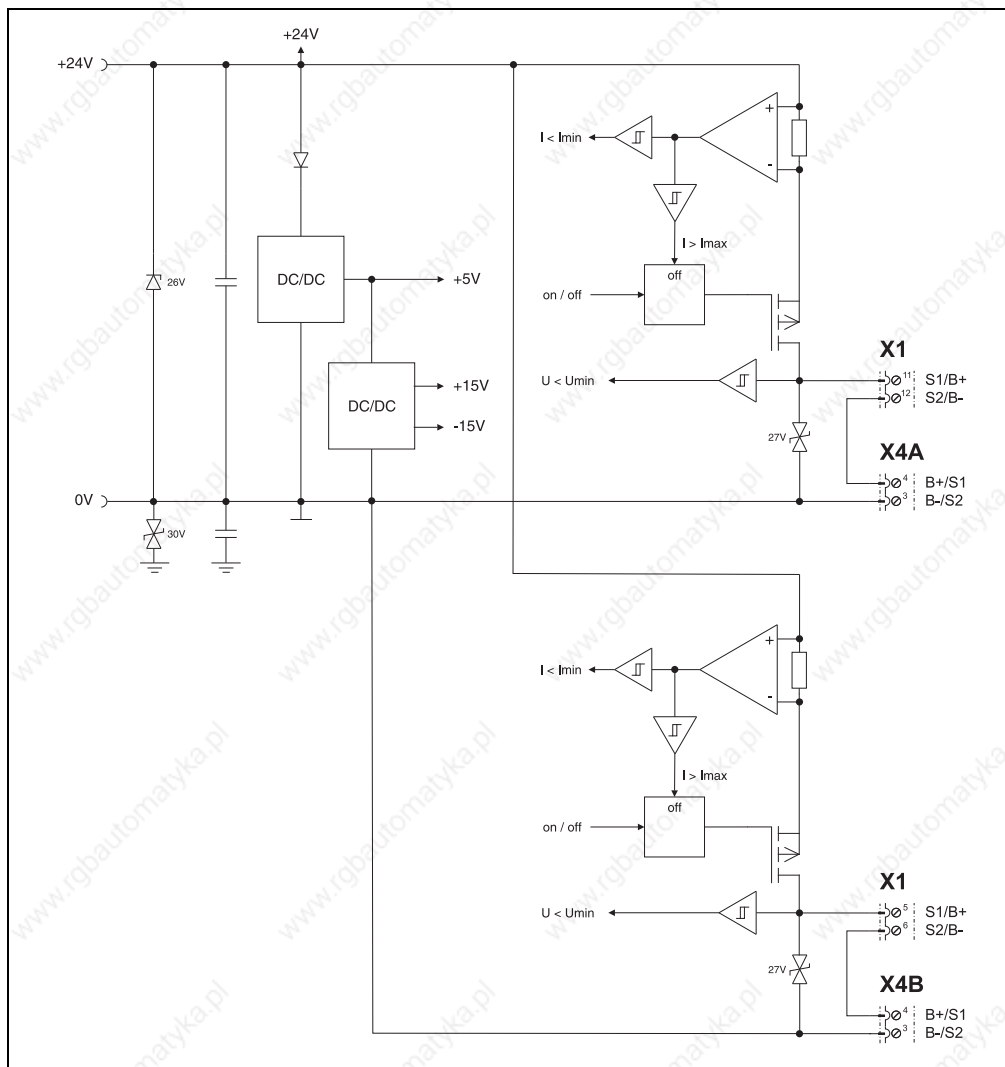


Figure 150: Input/output circuit diagram - 8BVI0014HxD0.000-1, 8BVI0028HxD0.000-1, 8BVI0055HxD0.000-1 (cont.)

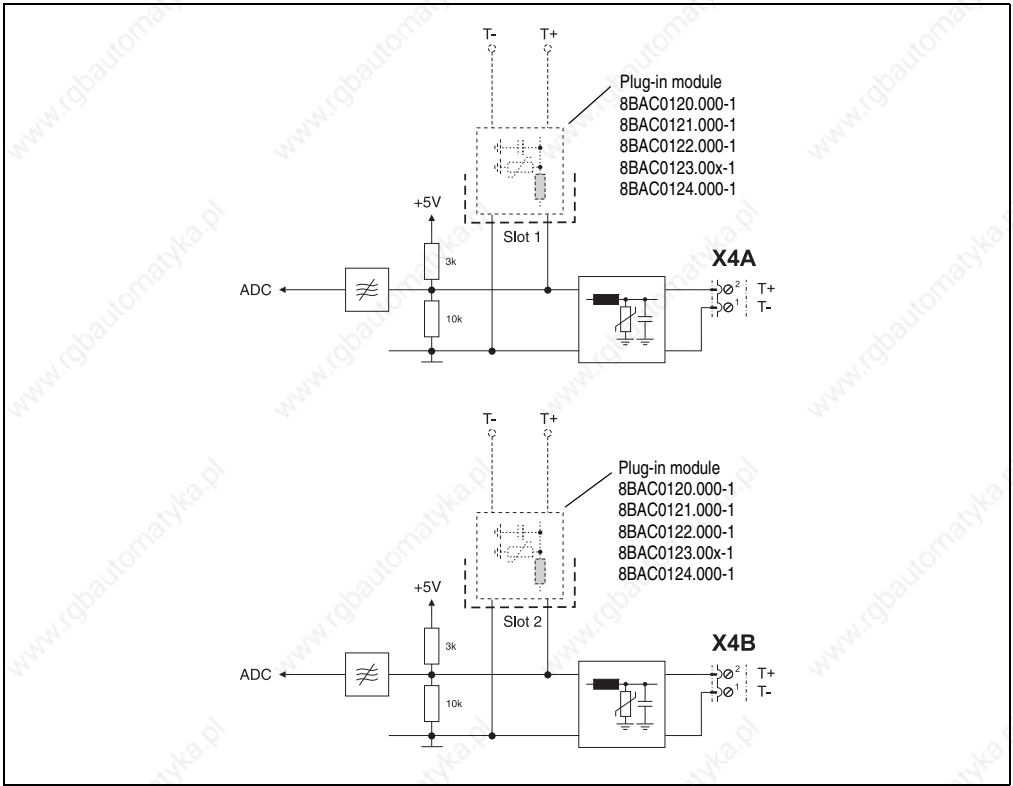


Figure 150: Input/output circuit diagram - 8BVI0014HxD0.000-1, 8BVI0028HxD0.000-1, 8BVI0055HxD0.000-1 (cont.)

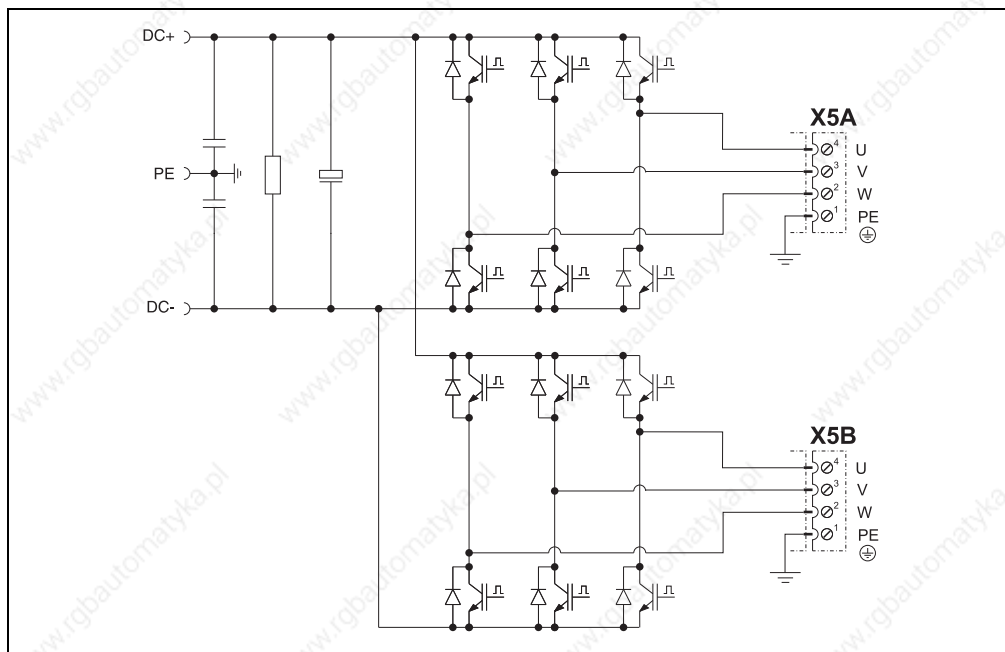


Figure 150: Input/output circuit diagram - 8BV10014HxD0.000-1, 8BV10028HxD0.000-1, 8BV10055HxD0.000-1 (cont.)

8.3 8BVI0220HxS0.000-1, 8BVI0440HxS0.000-1

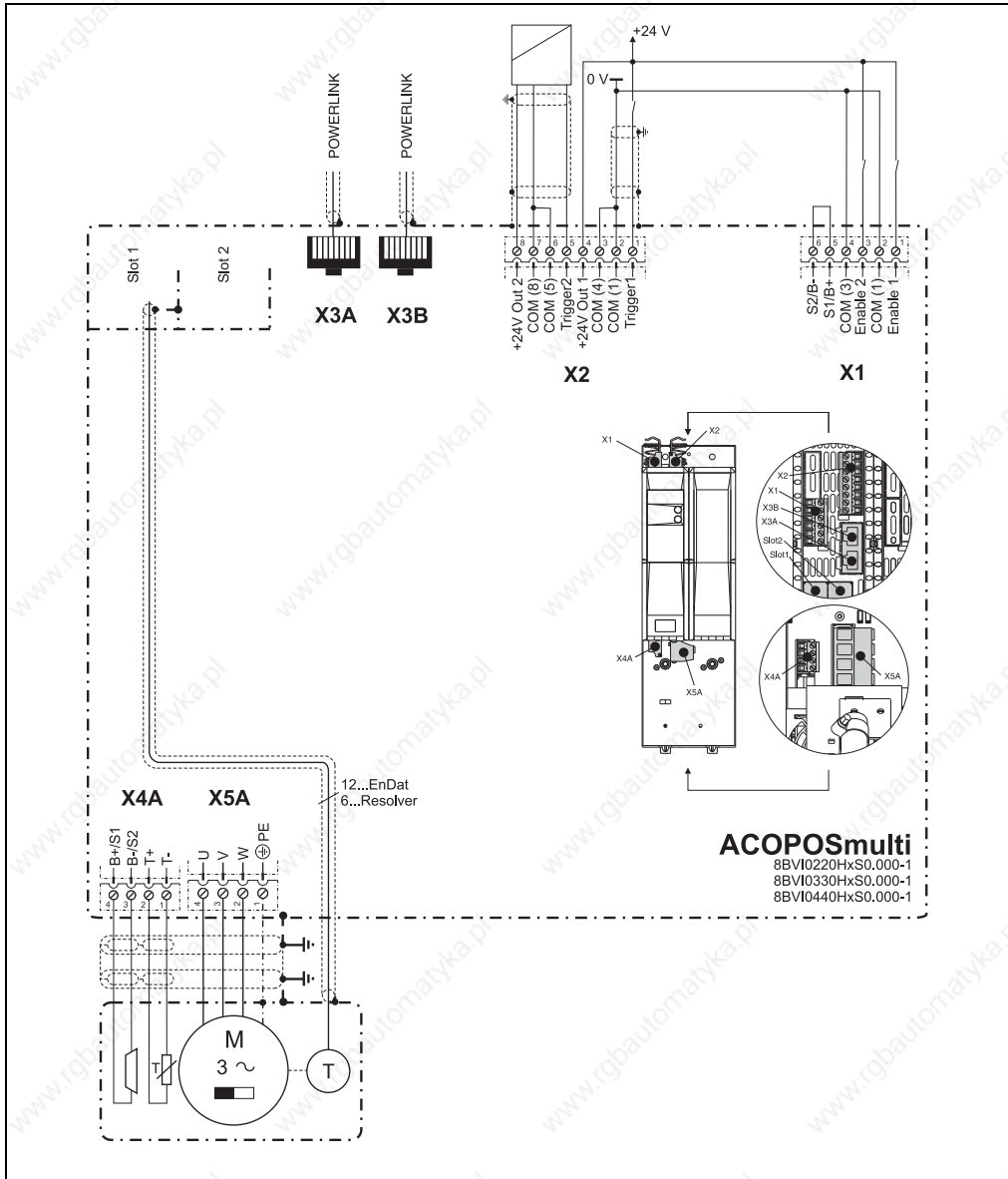


Figure 151: Overview of pin assignments - 8BVI0220HxS0.000-1, 8BVI0440HxS0.000-1

8.3.1 Pin assignments - X1 plug

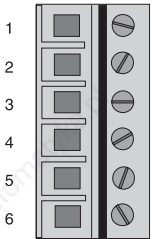
X1	Pin	Name	Function
	1	Enable 1 ¹⁾	Axis 1: Enable 1
	2	COM (1)	Axis 1: Enable 1 0 V
	3	Enable 2 ¹⁾	Axis 1: Enable 2
	4	COM (3)	Axis 1: Enable 2 0 V
	5	S1/B+ ^{1) 2)}	Axis 1: Brake + / Activation for the external holding brake
	6	S2/B- ^{1) 2)}	Axis 1: Brake - / Activation for the external holding brake

Table 259: Pin assignments - X1 plug 8BVI0220HxS0.000-1, 8BVI0440HxS0.000-1

- 1) The wiring is not permitted to exceed a total length of 3 m.
- 2) If the holding brake is connected via an additional external relay contact (ground-in e.g. via the connections S1/S2) instead of via the internal transistor, then the internal quenching circuit has no effect! In this case, the customer must make sure that neither the relay contact nor the braking coil are damaged when switching off the brake. This can be done by interconnecting the coil or - better still - interconnecting the contact with a quenching circuit.

Danger!

The connections for the motor holding brake are isolated circuits. Therefore, these connections are only allowed to be connected to devices or components with at least safe isolation according to IEC 60364-4-41 or EN 61800-5-1.

Caution!

If B+ and B are swapped when connecting the permanent magnet holding brakes, then the brakes cannot be opened! ACOPOSmulti inverter modules cannot determine if a holding brake is connected with reverse polarity!

8.3.2 Pin assignments - X2 plug

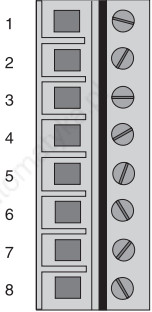
X2		Pin	Name	Function
	1	1	Trigger1	Trigger 1
	2	2	COM (1)	Trigger 1 0 V
	3	3	COM (4)	+24 V output 1 0 V
	4	4	+24 V Out 1	+24 V output 1
	5	5	Trigger2	Trigger 2
	6	6	COM (5)	Trigger 2 0 V
	7	7	COM (8)	+24 V output 2 0 V
	8	8	+24 V Out 2	+24 V output 2

Table 260: Pin assignments - X2 plug 8BVI0220HxS0.000-1, 8BVI0440HxS0.000-1

8.3.3 Pin assignments - X3A, X3B plugs


X3A, X3B		Pin	Name	Function
	1	1	RXD	Receive signal
	2	2	RXD\	Receive signal inverted
	3	3	TXD	Transmit signal
	4	4	Shield	Shield
	5	5	Shield	Shield
	6	6	TXD\	Transmit signal inverted
	7	7	Shield	Shield
	8	8	Shield	Shield

Table 261: Pin assignments - X3A, X3B plugs 8BVI0220HxS0.000-1, 8BVI0440HxS0.000-1

8.3.4 Pin assignments - X4A plug

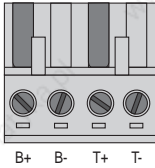
X4A	Name	Function
	T-	Axis 1: Temperature sensor -
	T+	Axis 1: Temperature sensor +
	B-/S2 ^{1) 2)}	Axis 1: Brake - / Activation for the external holding brake
	B+/S1 ^{1) 2)}	Axis 1: Brake + / Activation for the external holding brake

Table 262: Pin assignments - X4A plug 8BVI0220HxS0.000-1, 8BVI0440HxS0.000-1

- 1) The wiring is not permitted to exceed a total length of 3 m.
- 2) If the holding brake is connected via an additional external relay contact (ground-in e.g. via the connections S1/S2) instead of via the internal transistor, then the internal quenching circuit has no effect! In this case, the customer must make sure that neither the relay contact nor the braking coil are damaged when switching off the brake. This can be done by interconnecting the coil or - better still - interconnecting the contact with a quenching circuit.

Danger!

The connections for the motor temperature sensors and the motor holding brake are isolated circuits. Therefore, these connections are only allowed to be connected to devices or components with at least safe isolation according to IEC 60364-4-41 or EN 61800-5-1.

Caution!

If B+ and B are swapped when connecting the permanent magnet holding brakes, then the brakes cannot be opened! ACOPOSmulti inverter modules cannot determine if a holding brake is connected with reverse polarity!

8.3.5 Pin assignments - X5A plug

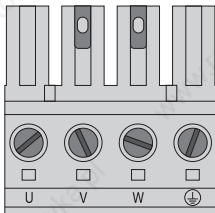
X5A	Name	Function
	PE	Axis 1: Protective ground conductor
	W	Axis 1: Motor connection W
	V	Axis 1: Motor connection V
	U	Axis 1: Motor connection U

Table 263: Pin assignments - X5A plug 8BVI0220HxS0.000-1, 8BVI0440HxS0.000-1

Information:

An additional PE conductor does not have to be connected to the threaded bolts located beside the X5A plug. The PE connection on the X5A plug is required and sufficient.

8.3.6 Input/output circuit diagram

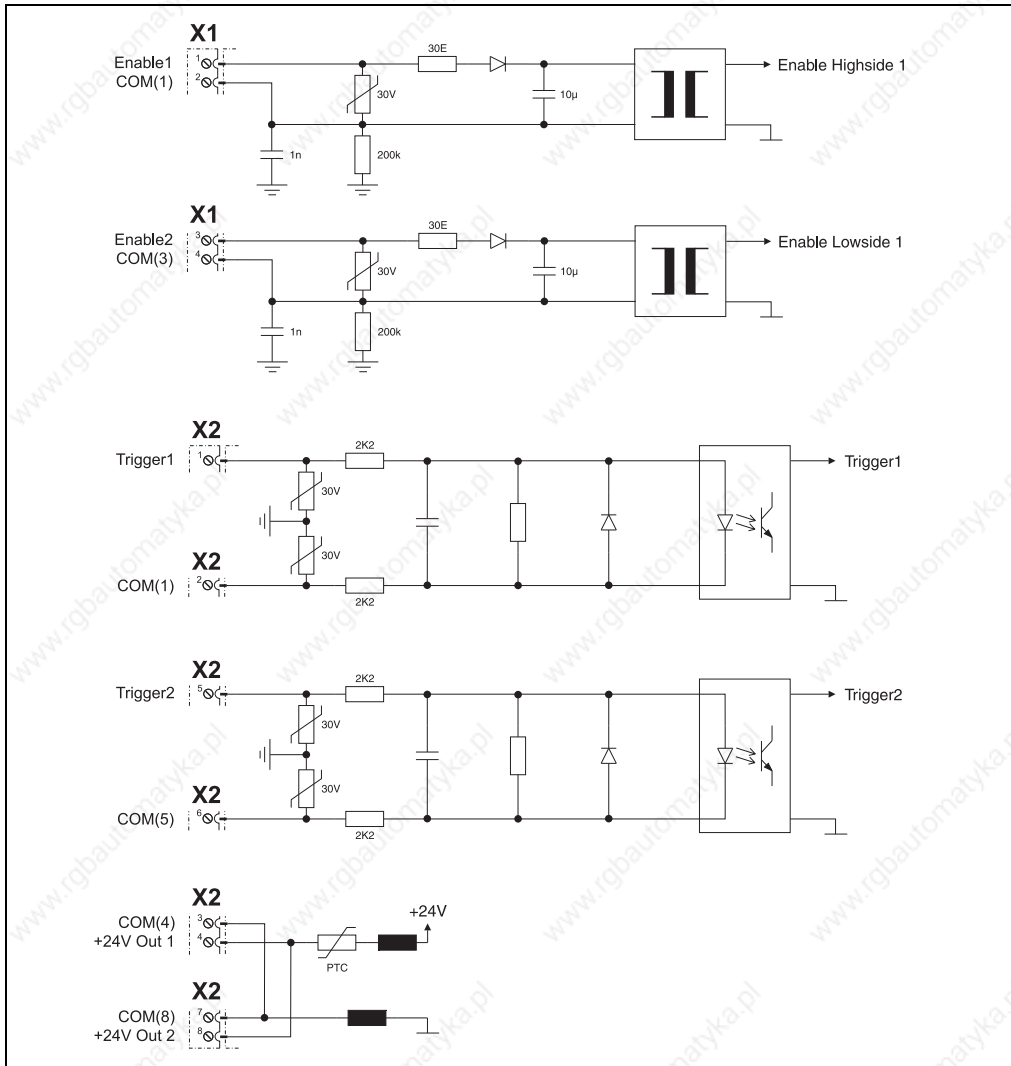


Figure 152: Input/output circuit diagram - 8BVI0220HxS0.000-1, 8BVI0440HxS0.000-1

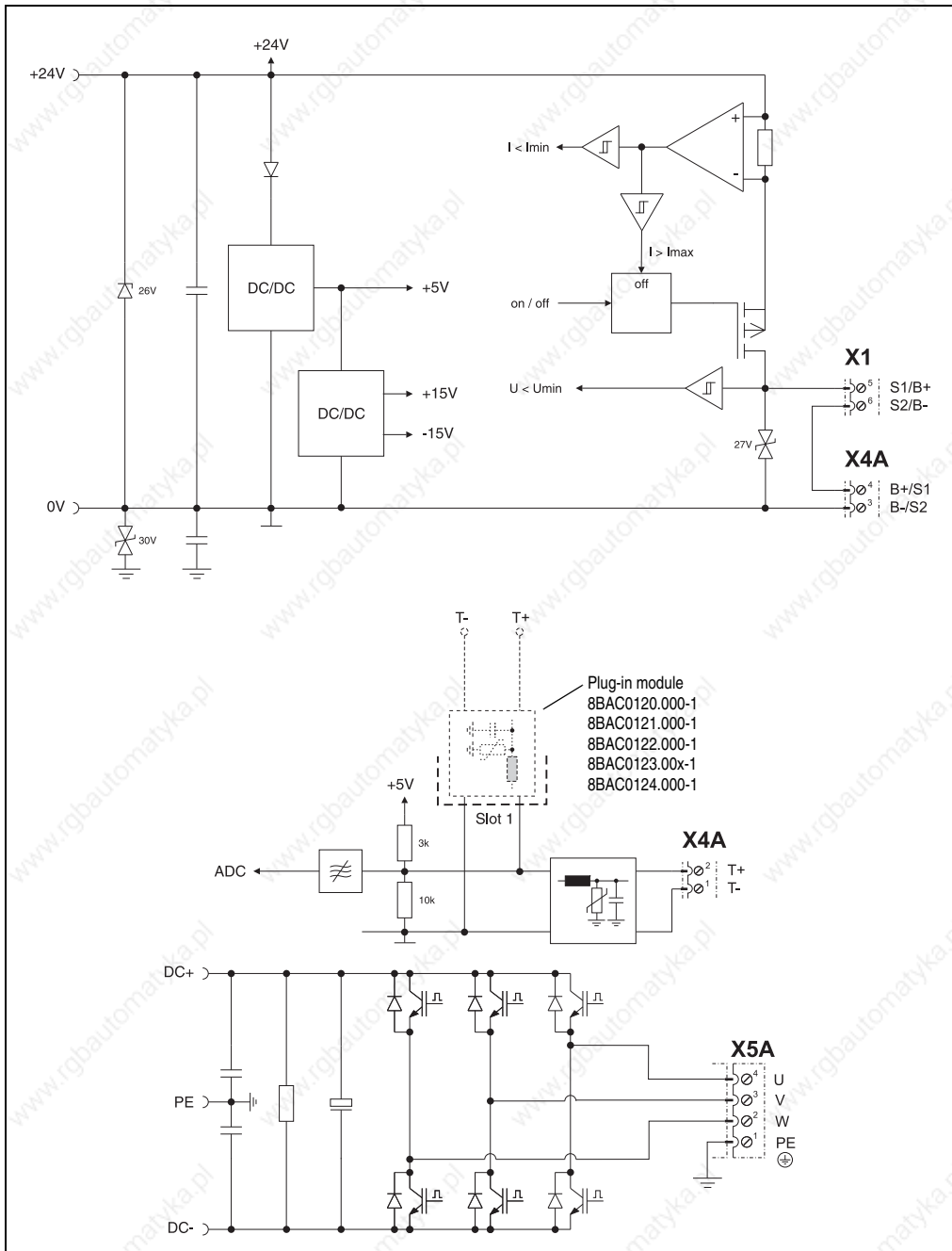


Figure 152: Input/output circuit diagram - 8BVI0220HxS0.000-1, 8BVI0440HxS0.000-1 (cont.)

8.4 8BVI0110HxD0.000-1, 8BVI0220HxD0.000-1

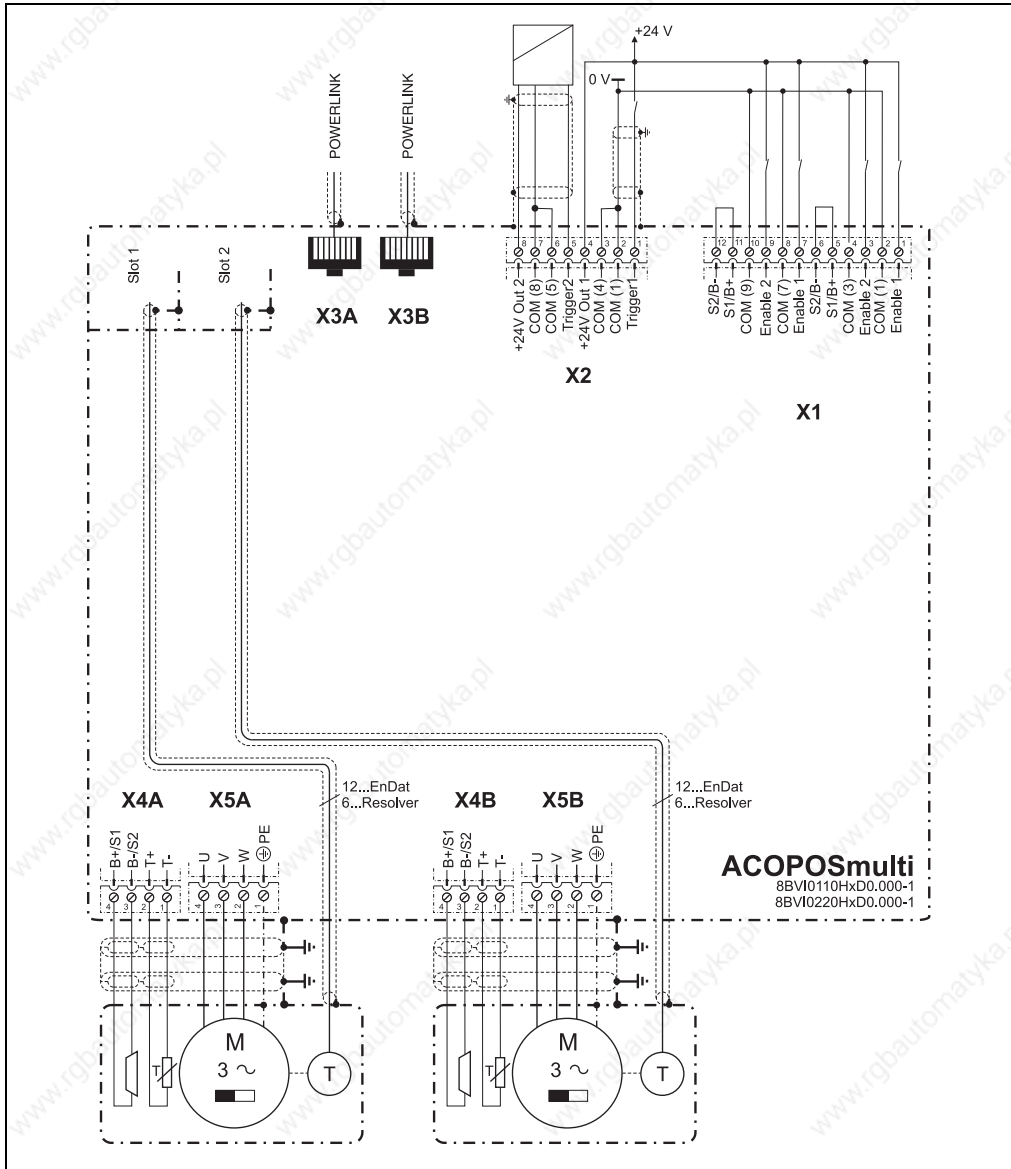


Figure 153: Overview of pin assignments - 8BVI0110HxD0.000-1, 8BVI0220HxD0.000-1

8.4.1 Pin assignments - X1 plug

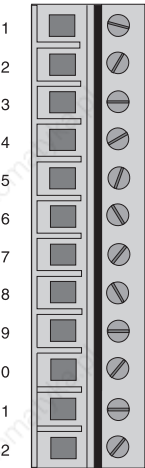
X1	Pin	Name	Function
	1	Enable 1	Axis 2: Enable 1
	2	COM (1)	Axis 2: Enable 1 0 V
	3	Enable 2	Axis 2: Enable 2
	4	COM (3)	Axis 2: Enable 2 0 V
	5	S1/B+ ^{1) 2)}	Axis 2: Brake + / Activation for the external holding brake
	6	S2/B- ^{1) 2)}	Axis 2: Brake - / Activation for the external holding brake
	7	Enable 1	Axis 1: Enable 1
	8	COM (7)	Axis 1: Enable 1 0 V
	9	Enable 2	Axis 1: Enable 2
	10	COM (9)	Axis 1: Enable 2 0 V
	11	S1/B+ ^{1) 2)}	Axis 1: Brake + / Activation for the external holding brake
	12	S2/B- ^{1) 2)}	Axis 1: Brake - / Activation for the external holding brake

Table 264: Pin assignments - X1 plug 8BVI0110HxD0.000-1, 8BVI0220HxD0.000-1

- 1) If the holding brake is connected via an additional external relay contact (ground-in e.g. via the connections S1/S2) instead of via the internal transistor, then the internal quenching circuit has no effect! In this case, the customer must make sure that neither the relay contact nor the braking coil are damaged when switching off the brake. This can be done by interconnecting the coil or - better still - interconnecting the contact with a quenching circuit.
- 2) Due to EMC reasons, wiring of the S1 and S2 connectors (activation of the external holding brake) is not permitted to exceed a total length of x m.

Danger!

The connections for the motor holding brakes are isolated circuits. Therefore, these connections are only allowed to be connected to devices or components with at least safe isolation according to IEC 60364-4-41 or EN 61800-5-1.

Caution!

If B+ and B are swapped when connecting the permanent magnet holding brakes, then the brakes cannot be opened! ACOPOSmulti inverter modules cannot determine if a holding brake is connected with reverse polarity!

8.4.2 Pin assignments - X2 plug

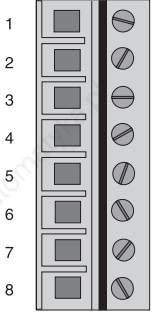
X2	Pin	Name	Function
	1	Trigger1	Trigger 1
	2	COM (1)	Trigger 1 0 V
	3	COM (4)	+24 V output 1 0 V
	4	+24 V Out 1	+24 V output 1
	5	Trigger2	Trigger 2
	6	COM (5)	Trigger 2 0 V
	7	COM (8)	+24 V output 2 0 V
	8	+24 V Out 2	+24 V output 2

Table 265: Pin assignments - X2 plug 8BVI0110HxD0.000-1, 8BVI0220HxD0.000-1

8.4.3 Pin assignments - X3A, X3B plugs


X3A, X3B	Pin	Name	Function
	1	RXD	Receive signal
	2	RXD\	Receive signal inverted
	3	TXD	Transmit signal
	4	Shield	Shield
	5	Shield	Shield
	6	TXD\	Transmit signal inverted
	7	Shield	Shield
	8	Shield	Shield

Table 266: Pin assignments - X3A, X3B plugs 8BVI0110HxD0.000-1, 8BVI0220HxD0.000-1

8.4.4 Pin assignments - X4A plug

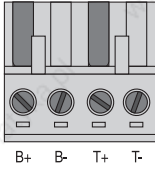
X4A	Name	Function
 <p>B+ B- T+ T-</p>	T-	Axis 1: Temperature sensor -
	T+	Axis 1: Temperature sensor +
	B-/S2 ^{1) 2)}	Axis 1: Brake - / Activation for the external holding brake
	B+/S1 ^{1) 2)}	Axis 1: Brake + / Activation for the external holding brake

Table 267: Pin assignments - X4A plug 8BVI0110HxD0.000-1, 8BVI0220HxD0.000-1

- 1) If the holding brake is connected via an additional external relay contact (ground-in e.g. via the connections S1/S2) instead of via the internal transistor, then the internal quenching circuit has no effect! In this case, the customer must make sure that neither the relay contact nor the braking coil are damaged when switching off the brake. This can be done by interconnecting the coil or - better still - interconnecting the contact with a quenching circuit.
- 2) Wiring of the S1 and S2 connectors (activation of the external holding brake) is not permitted to exceed a total length of x m.

Danger!

The connections for the motor temperature sensors and the motor holding brake are isolated circuits. Therefore, these connections are only allowed to be connected to devices or components with at least safe isolation according to IEC 60364-4-41 or EN 61800-5-1.

Caution!

If B+ and B- are swapped when connecting the permanent magnet holding brakes, then the brakes cannot be opened! ACOPOSmulti inverter modules cannot determine if a holding brake is connected with reverse polarity!

8.4.5 Pin assignments - X4B plug

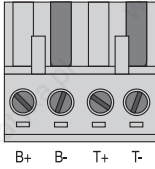
X4b	Name	Function
 <p>B+ B- T+ T-</p>	T-	Axis 2: Temperature sensor -
	T+	Axis 2: Temperature sensor +
	B-/S2 ^{1) 2)}	Axis 2: Brake - / Activation for the external holding brake
	B+/S1 ^{1) 2)}	Axis 2: Brake + / Activation for the external holding brake

Table 268: Pin assignments - X4B plug 8BVI0110HxD0.000-1, 8BVI0220HxD0.000-1

- 1) If the holding brake is connected via an additional external relay contact (ground-in e.g. via the connections S1/S2) instead of via the internal transistor, then the internal quenching circuit has no effect! In this case, the customer must make sure that neither the relay contact nor the braking coil are damaged when switching off the brake. This can be done by interconnecting the coil or - better still - interconnecting the contact with a quenching circuit.
- 2) Due to EMC reasons, wiring of the S1 and S2 connectors (activation of the external holding brake) is not permitted to exceed a total length of x m.

Danger!

The connections for the motor temperature sensors and the motor holding brake are isolated circuits. Therefore, these connections are only allowed to be connected to devices or components with at least safe isolation according to IEC 60364-4-41 or EN 61800-5-1.

Caution!

If B+ and B- are swapped when connecting the permanent magnet holding brakes, then the brakes cannot be opened! ACOPOSmulti inverter modules cannot determine if a holding brake is connected with reverse polarity!

8.4.6 Pin assignments - X5A plug

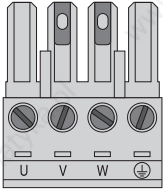
X5A	Name	Function
	PE	Axis 1: Protective ground conductor
	W	Axis 1: Motor connection W
	V	Axis 1: Motor connection V
	U	Axis 1: Motor connection U

Table 269: Pin assignments - X5A plug 8BVI0110HxD0.000-1, 8BVI0220HxD0.000-1

8.4.7 Pin assignments - X5B plug

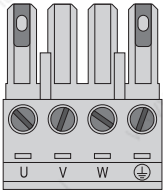
X5B	Name	Function
	PE	Axis 2: Protective ground conductor
	W	Axis 2: Motor connection W
	V	Axis 2: Motor connection V
	U	Axis 2: Motor connection U

Table 270: Pin assignments - X5B plug 8BVI0110HxD0.000-1, 8BVI0220HxD0.000-1

8.4.8 Input/output circuit diagram

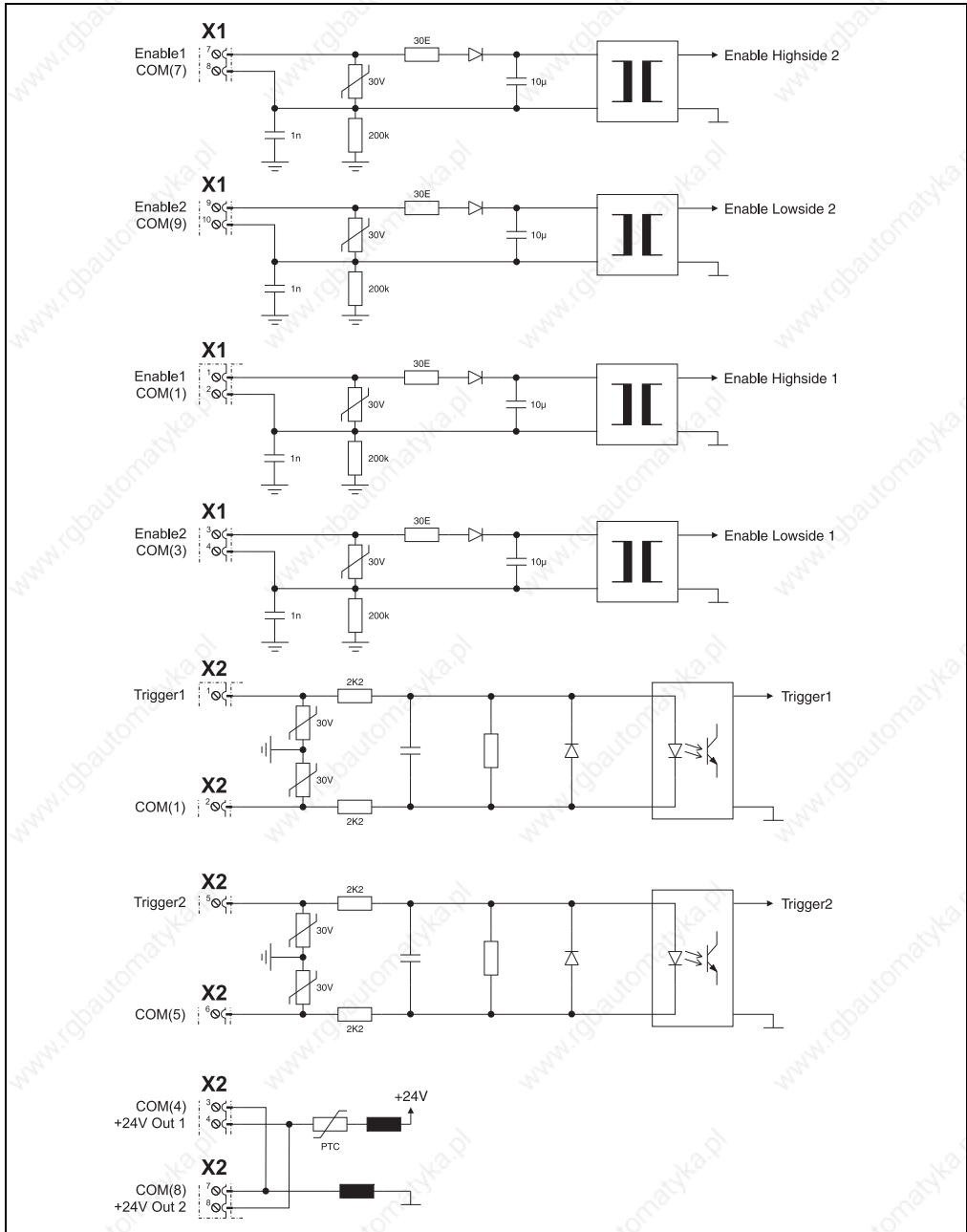


Figure 154: Input/output circuit diagram - 8BVI0110HxD0.000-1, 8BVI0220HxD0.000-1

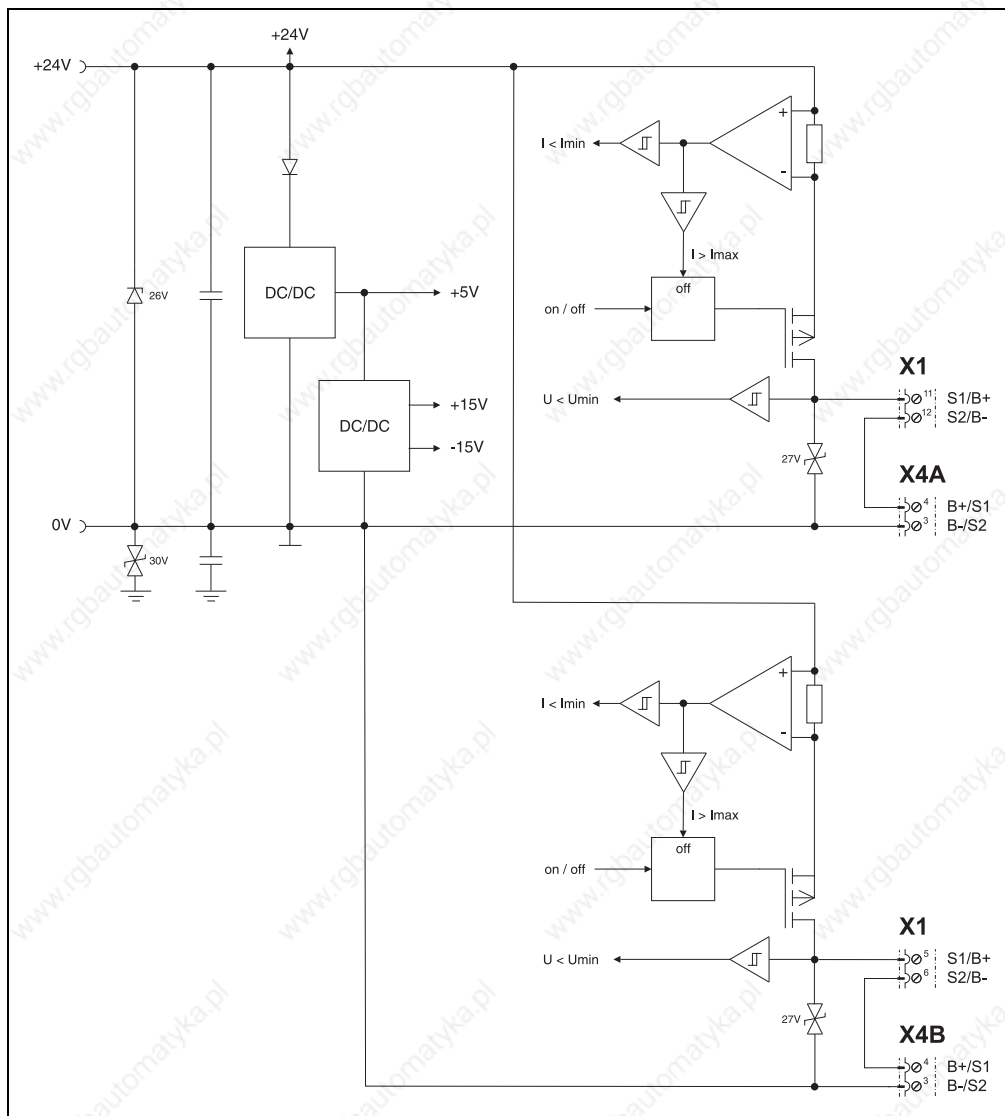


Figure 154: Input/output circuit diagram - 8BVI0110HxD0.000-1, 8BVI0220HxD0.000-1 (cont.)

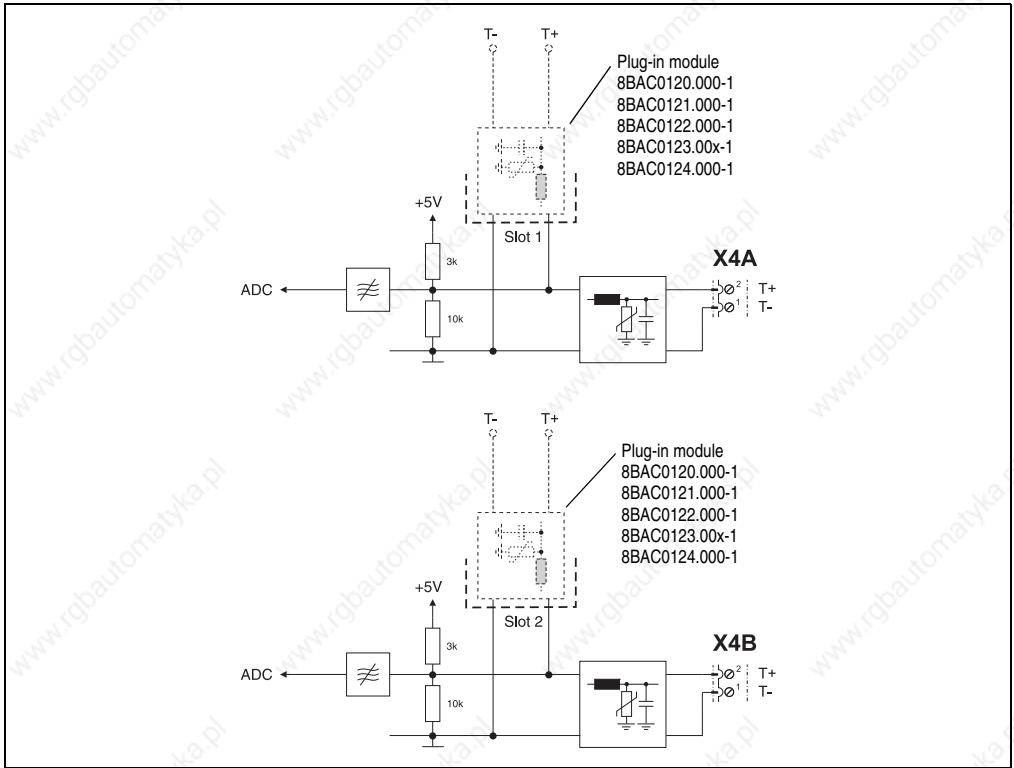


Figure 154: Input/output circuit diagram - 8BVI0110HxD0.000-1, 8BVI0220HxD0.000-1 (cont.)

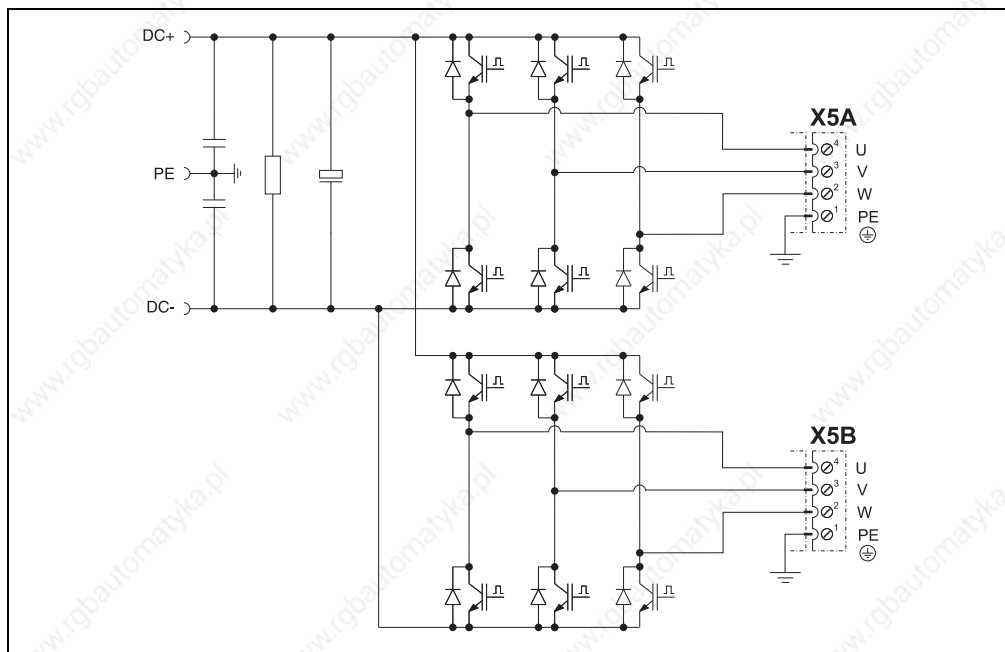


Figure 154: Input/output circuit diagram - 8BVI0110HxD0.000-1, 8BVI0220HxD0.000-1 (cont.)

8.5 8BVI0880HxS0.000-1

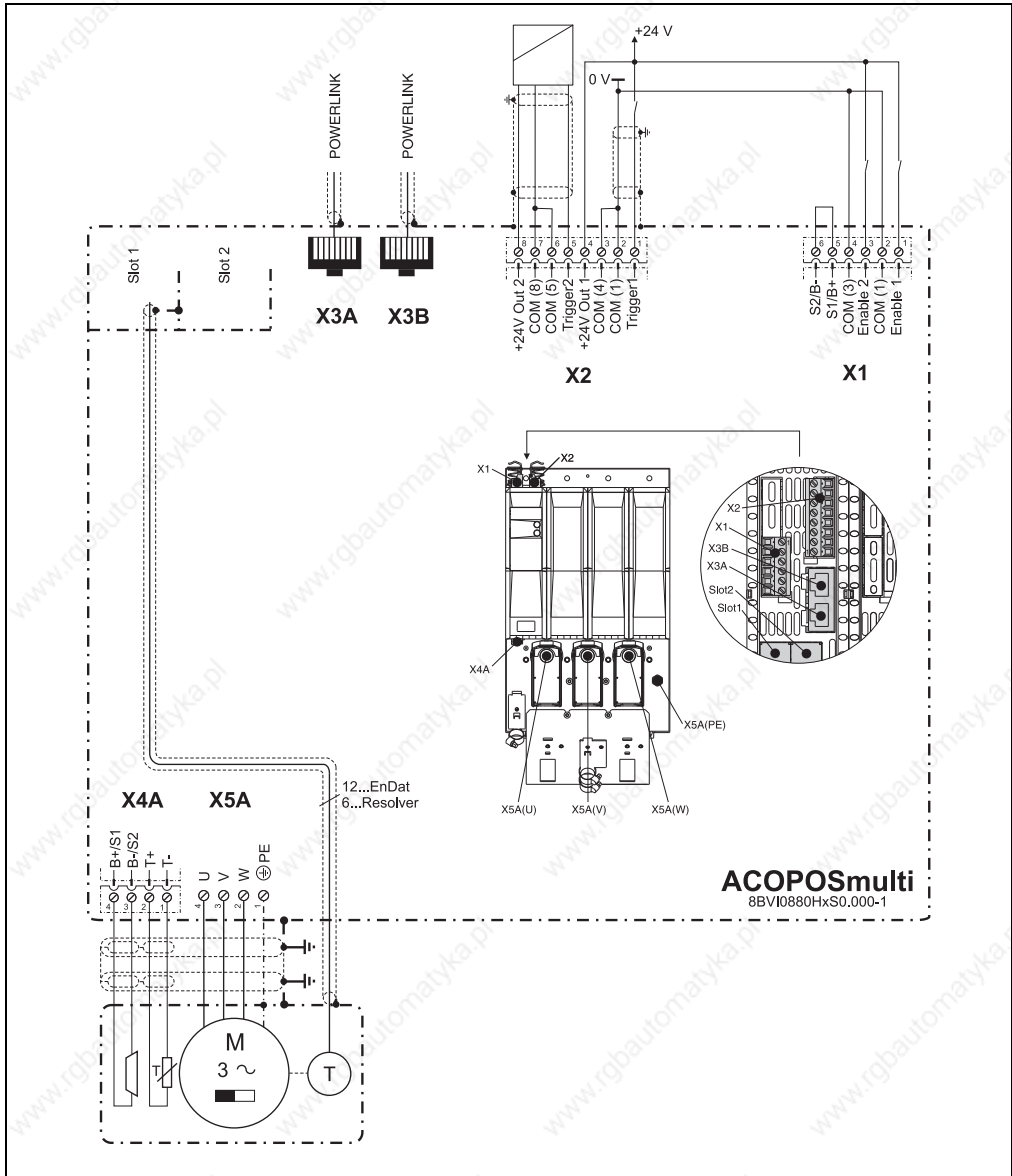


Figure 155: Overview of pin assignments - 8BVI0880HxS0.000-1

8.5.1 Pin assignments - X1 plug

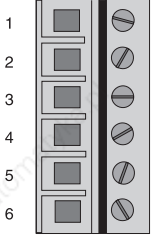
X1	Pin	Name	Function
	1	Enable 1 ¹⁾	Axis 1: Enable 1
	2	COM (1)	Axis 1: Enable 1 0 V
	3	Enable 2 ¹⁾	Axis 1: Enable 2
	4	COM (3)	Axis 1: Enable 2 0 V
	5	S1/B+ ^{1) 2)}	Axis 1: Brake + / Activation for the external holding brake
	6	S2/B- ^{1) 2)}	Axis 1: Brake - / Activation for the external holding brake

Table 271: Pin assignments - X1 plug 8BVI0880HxS0.000-1

- 1) The wiring is not permitted to exceed a total length of 3 m.
- 2) If the holding brake is connected via an additional external relay contact (ground-in e.g. via the connections S1/S2) instead of via the internal transistor, then the internal quenching circuit has no effect! In this case, the customer must make sure that neither the relay contact nor the braking coil are damaged when switching off the brake. This can be done by interconnecting the coil or - better still - interconnecting the contact with a quenching circuit.

Danger!

The connections for the motor holding brake are isolated circuits. Therefore, these connections are only allowed to be connected to devices or components with at least safe isolation according to IEC 60364-4-41 or EN 61800-5-1.

Caution!

If B+ and B are swapped when connecting the permanent magnet holding brakes, then the brakes cannot be opened! ACOPOSmulti inverter modules cannot determine if a holding brake is connected with reverse polarity!

8.5.2 Pin assignments - X2 plug

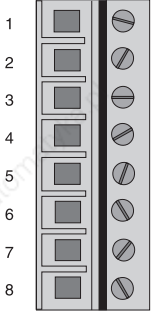
X2		Pin	Name	Function
	1	1	Trigger1	Trigger 1
	2	2	COM (1)	Trigger 1 0 V
	3	3	COM (4)	+24 V output 1 0 V
	4	4	+24 V Out 1	+24 V output 1
	5	5	Trigger2	Trigger 2
	6	6	COM (5)	Trigger 2 0 V
	7	7	COM (8)	+24 V output 2 0 V
	8	8	+24 V Out 2	+24 V output 2

Table 272: Pin assignments - X2 plug 8BVI0880HxS0.000-1

8.5.3 Pin assignments - X3A, X3B plugs


X3A, X3B		Pin	Name	Function
	1	1	RXD	Receive signal
	2	2	RXD\	Receive signal inverted
	3	3	TXD	Transmit signal
	4	4	Shield	Shield
	5	5	Shield	Shield
	6	6	TXD\	Transmit signal inverted
	7	7	Shield	Shield
	8	8	Shield	Shield

Table 273: Pin assignments - X3A, X3B plugs 8BVI0880HxS0.000-1

8.5.4 Pin assignments - X4A plug

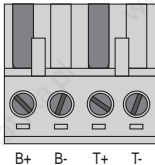
X4A	Name	Function
 <p>B+ B- T+ T-</p>	T-	Axis 1: Temperature sensor -
	T+	Axis 1: Temperature sensor +
	B-/S2 ^{1) 2)}	Axis 1: Brake - / Activation for the external holding brake
	B+/S1 ^{1) 2)}	Axis 1: Brake + / Activation for the external holding brake

Table 274: Pin assignments - X4A plug 8BVI0880HxS0.000-1

- 1) The wiring is not permitted to exceed a total length of 3 m.
- 2) If the holding brake is connected via an additional external relay contact (ground-in e.g. via the connections S1/S2) instead of via the internal transistor, then the internal quenching circuit has no effect! In this case, the customer must make sure that neither the relay contact nor the braking coil are damaged when switching off the brake. This can be done by interconnecting the coil or - better still - interconnecting the contact with a quenching circuit.

Danger!

The connections for the motor temperature sensors and the motor holding brake are isolated circuits. Therefore, these connections are only allowed to be connected to devices or components with at least safe isolation according to IEC 60364-4-41 or EN 61800-5-1.

Caution!

If B+ and B are swapped when connecting the permanent magnet holding brakes, then the brakes cannot be opened! ACOPOSmulti inverter modules cannot determine if a holding brake is connected with reverse polarity!

8.5.5 Pin assignments - X5A plug

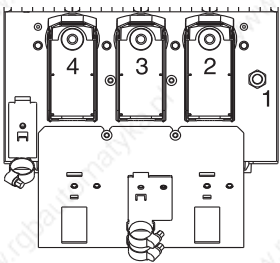
X5A	Pin	Name	Function
	1	PE	Axis 1: Protective ground conductor
	2	W	Axis 1: Motor connection W
	3	V	Axis 1: Motor connection V
	4	U	Axis 1: Motor connection U
Holding torque for the M8 nuts: 7.5 Nm			

Table 275 : Pin assignments - X5A plug 8BVI0880HxS0.000-1

Cable installation for motor connections U, V, W

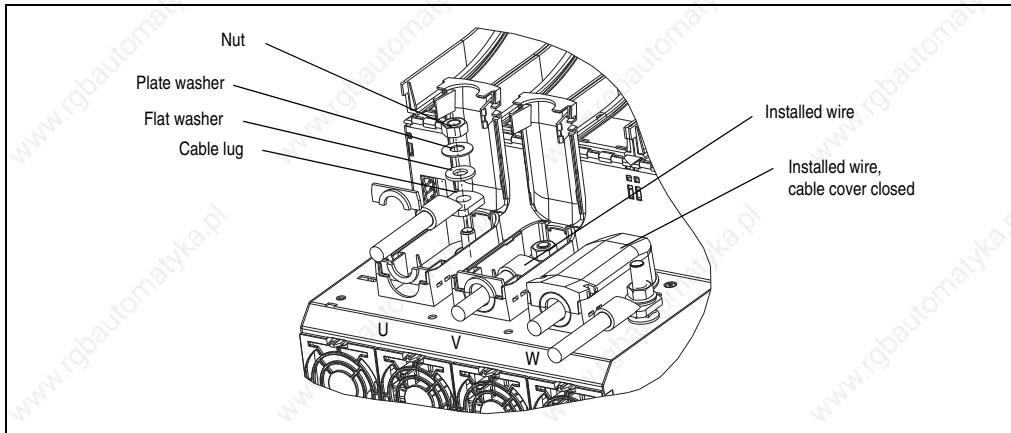


Figure 156: Cable installation for motor connections U, V, W

Cable installation connection PE (1 wire)

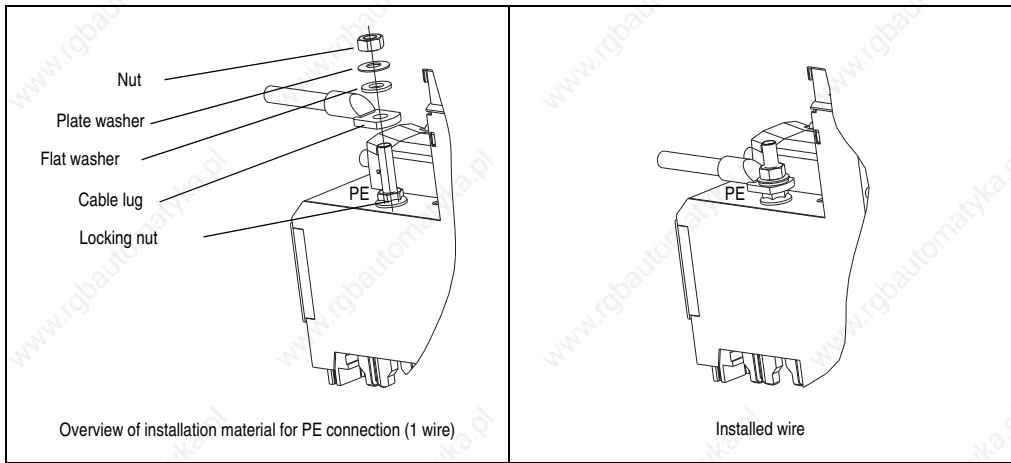


Figure 157: Cable installation connection PE (1 wire)

Cable installation connection PE (3 wire)

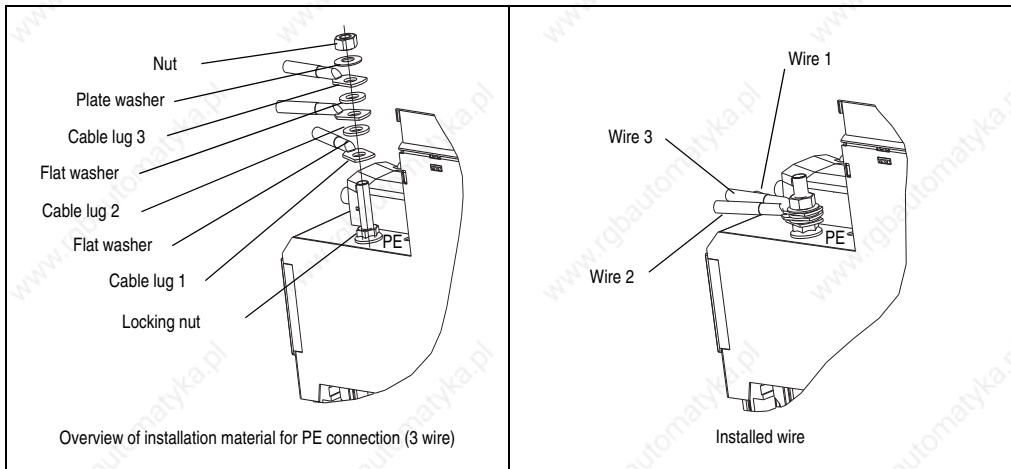


Figure 158: Cable installation connection PE (3 wire)

8.5.6 Input/output circuit diagram

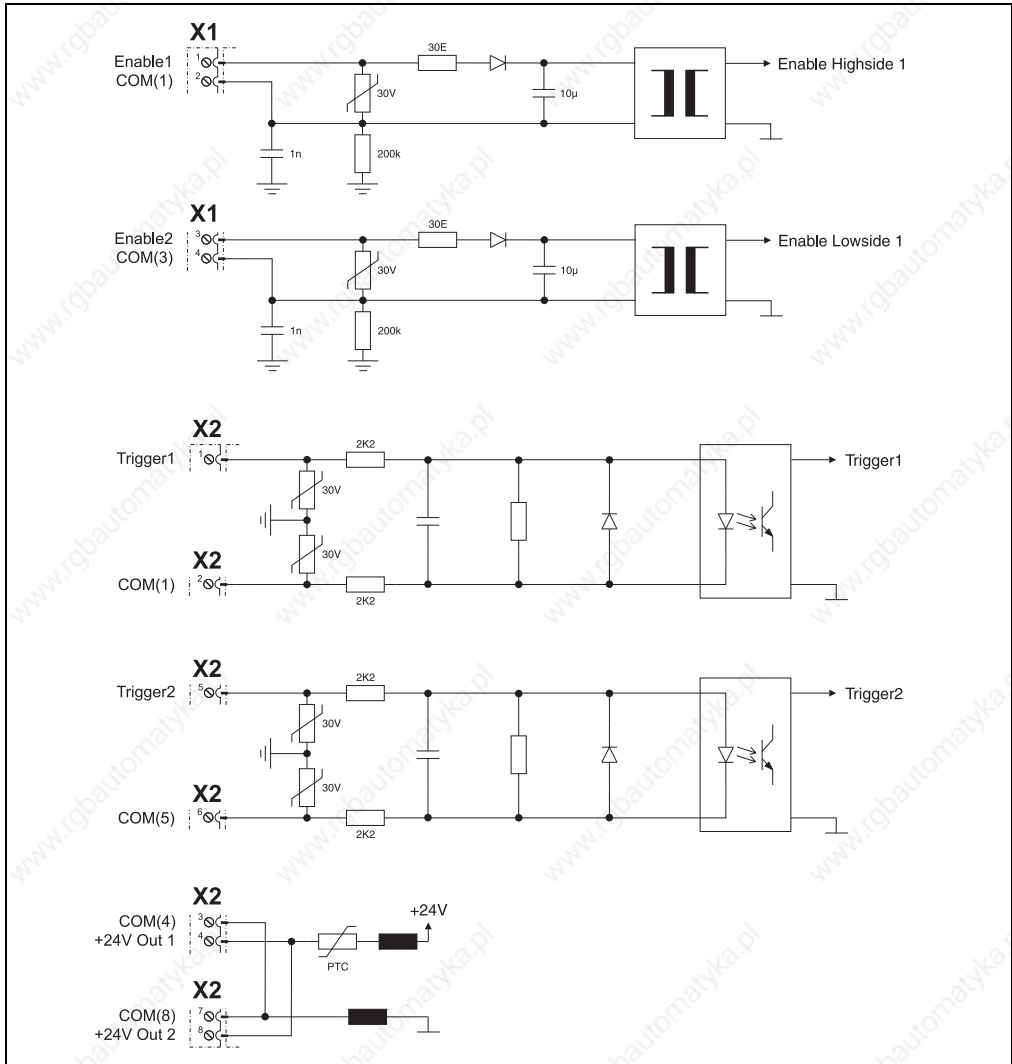


Figure 159: Input/output circuit diagram - 8BVI00880HxS0.000-1

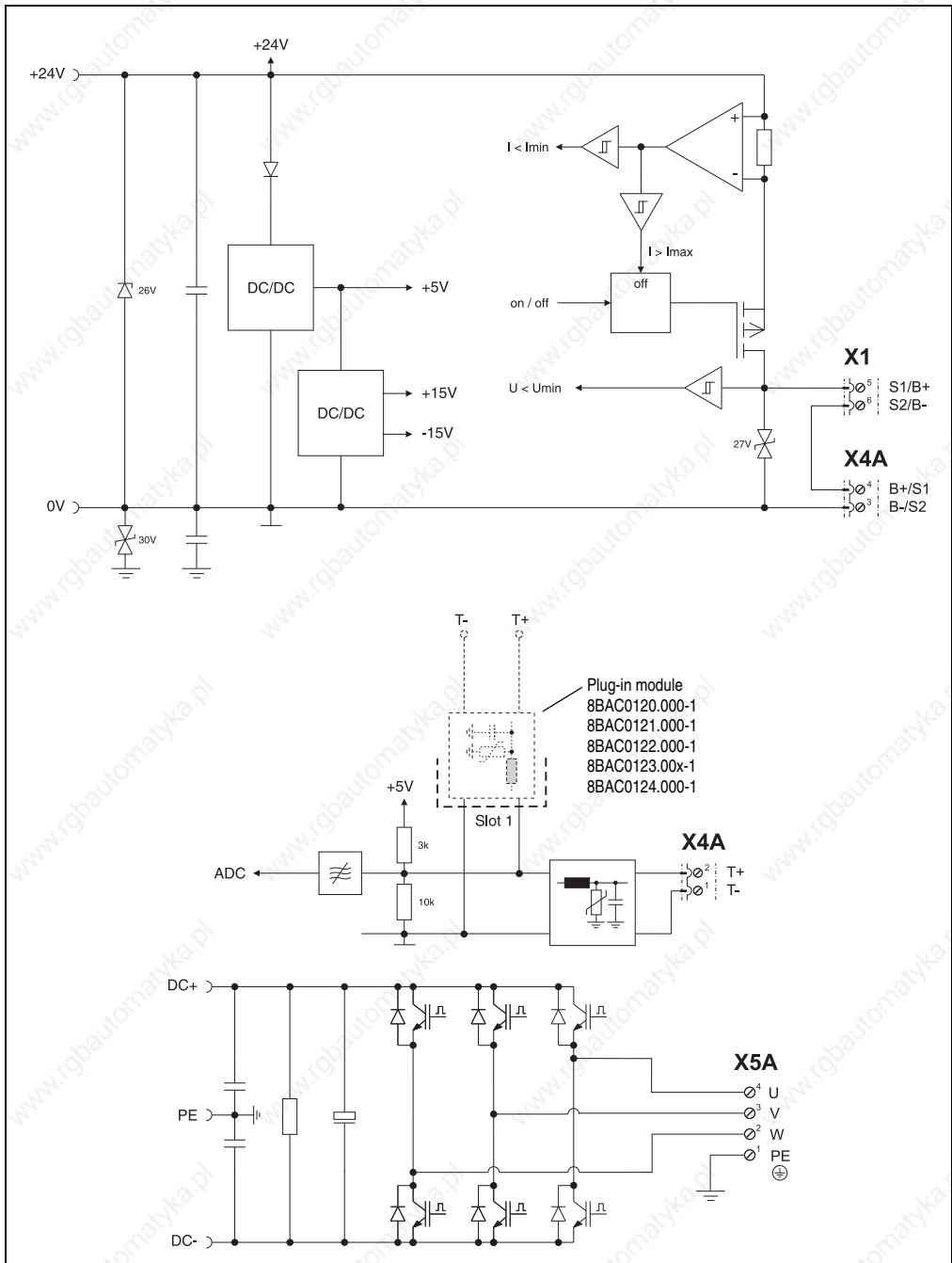


Figure 159: Input/output circuit diagram - 8BVI00880HxS0.000-1 (cont.)

8.6 8BVI1650HxS0.000-1

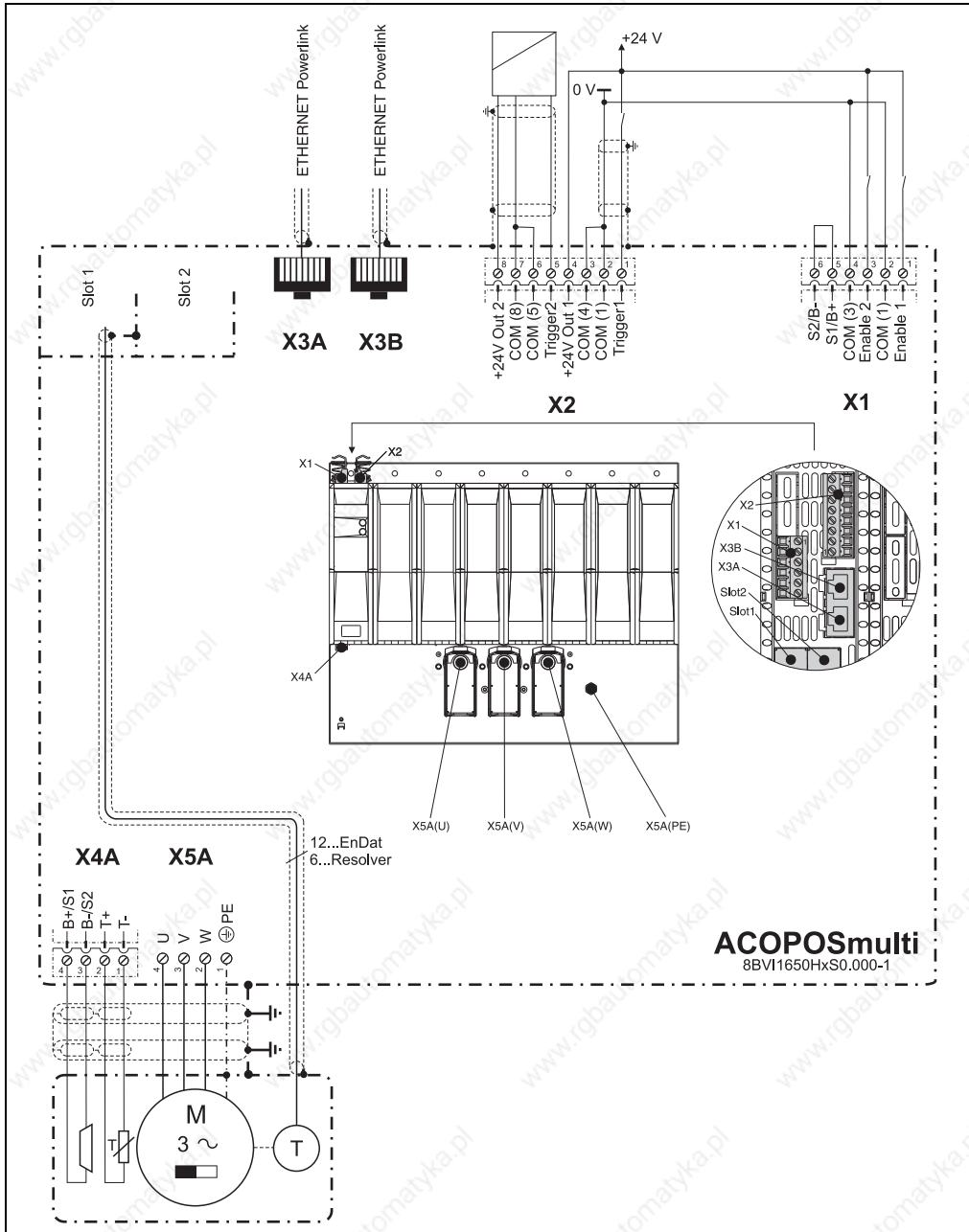


Figure 160: Overview of pin assignments - 8BVI1650HxS0.000-1

8.6.1 Pin assignments - X1 plug

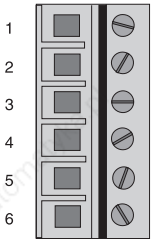
X1		Pin	Name	Function
	1	1	Enable 1 ¹⁾	Axis 1: Enable 1
	2	2	COM (1)	Axis 1: Enable 1 0 V
	3	3	Enable 2 ¹⁾	Axis 1: Enable 2
	4	4	COM (3)	Axis 1: Enable 2 0 V
	5	5	S1/B+ ^{1) 2)}	Axis 1: Brake + / Activation for the external holding brake
	6	6	S2/B- ^{1) 2)}	Axis 1: Brake - / Activation for the external holding brake

Table 276: Pin assignments - X1 plug 8BVI1650HxS0.000-1

- 1) The wiring is not permitted to exceed a total length of 3 m.
- 2) If the holding brake is connected via an additional external relay contact (ground-in e.g. via the connections S1/S2) instead of via the internal transistor, then the internal quenching circuit has no effect! In this case, the customer must make sure that neither the relay contact nor the braking coil are damaged when switching off the brake. This can be done by interconnecting the coil or - better still - interconnecting the contact with a quenching circuit.

Danger!

The connections for the motor holding brake are isolated circuits. Therefore, these connections are only allowed to be connected to devices or components with at least safe isolation according to IEC 60364-4-41 or EN 61800-5-1.

Caution!

If B+ and B are swapped when connecting the permanent magnet holding brakes, then the brakes cannot be opened! ACOPOSmulti inverter modules cannot determine if a holding brake is connected with reverse polarity!

8.6.2 Pin assignments - X2 plug

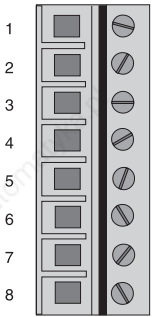
X2	Pin	Name	Function
	1	Trigger1	Trigger 1
	2	COM (1)	Trigger 1 0 V
	3	COM (4)	+24 V output 1 0 V
	4	+24 V Out 1	+24 V output 1
	5	Trigger2	Trigger 2
	6	COM (5)	Trigger 2 0 V
	7	COM (8)	+24 V output 2 0 V
	8	+24 V Out 2	+24 V output 2

Table 277: Pin assignments - X2 plug 8BVI1650HxS0.000-1

8.6.3 Pin assignments - X3A, X3B plugs


X3A, X3B	Pin	Name	Function
	1	RXD	Receive signal
	2	RXD\	Receive signal inverted
	3	TXD	Transmit signal
	4	Shield	Shield
	5	Shield	Shield
	6	TXD\	Transmit signal inverted
	7	Shield	Shield
	8	Shield	Shield

Table 278: Pin assignments - X3A, X3B plugs 8BVI1650HxS0.000-1

8.6.4 Pin assignments - X4A plug

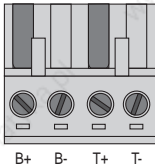
X4A	Name	Function
	T-	Axis 1: Temperature sensor -
	T+	Axis 1: Temperature sensor +
	B-/S2 ^{1) 2)}	Axis 1: Brake - / Activation for the external holding brake
	B+/S1 ^{1) 2)}	Axis 1: Brake + / Activation for the external holding brake

Table 279: Pin assignments - X4A plug 8BVI1650HxS0.000-1

- 1) The wiring is not permitted to exceed a total length of 3 m.
- 2) If the holding brake is connected via an additional external relay contact (ground-in e.g. via the connections S1/S2) instead of via the internal transistor, then the internal quenching circuit has no effect! In this case, the customer must make sure that neither the relay contact nor the braking coil are damaged when switching off the brake. This can be done by interconnecting the coil or - better still - interconnecting the contact with a quenching circuit.

Danger!

The connections for the motor temperature sensors and the motor holding brake are isolated circuits. Therefore, these connections are only allowed to be connected to devices or components with at least safe isolation according to IEC 60364-4-41 or EN 61800-5-1.

Caution!

If B+ and B are swapped when connecting the permanent magnet holding brakes, then the brakes cannot be opened! ACOPOSmulti inverter modules cannot determine if a holding brake is connected with reverse polarity!

8.6.5 Pin assignments - X5A plug

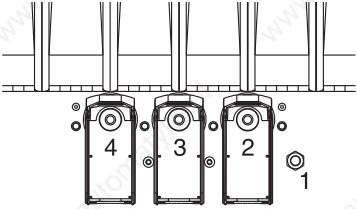
X5A	Pin	Name	Function
	1	PE	Axis 1: Protective ground conductor
	2	W	Axis 1: Motor connection W
	3	V	Axis 1: Motor connection V
	4	U	Axis 1: Motor connection U
Holding torque for the M8 nuts: 7.5 Nm			

Table 280 : Pin assignments - X5A plug 8BVI1650HxS0.000-1

Cable installation for motor connections U, V, W

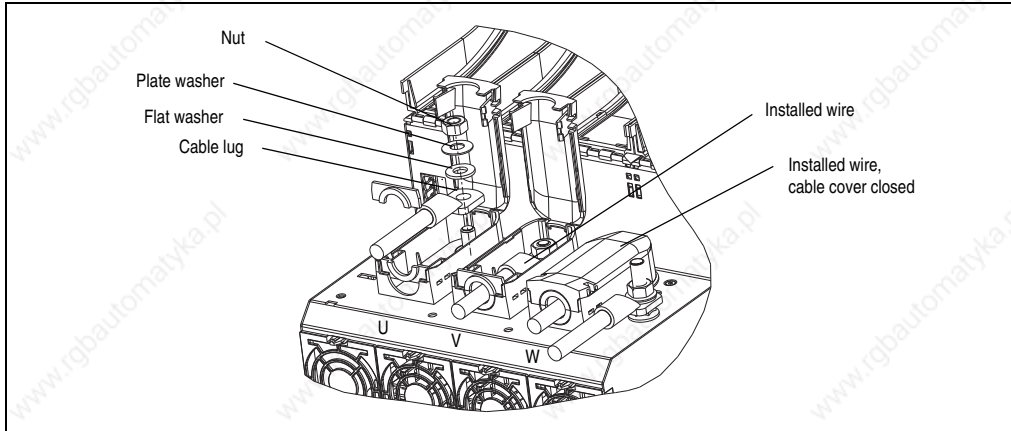


Figure 161: Cable installation for motor connections U, V, W

Cable installation connection PE (1 wire)

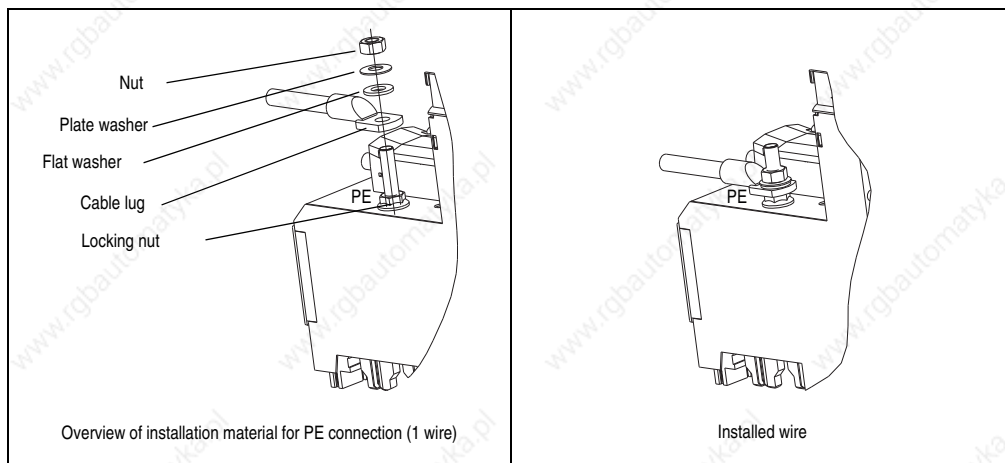


Figure 162: Cable installation connection PE (1 wire)

Cable installation connection PE (3 wire)

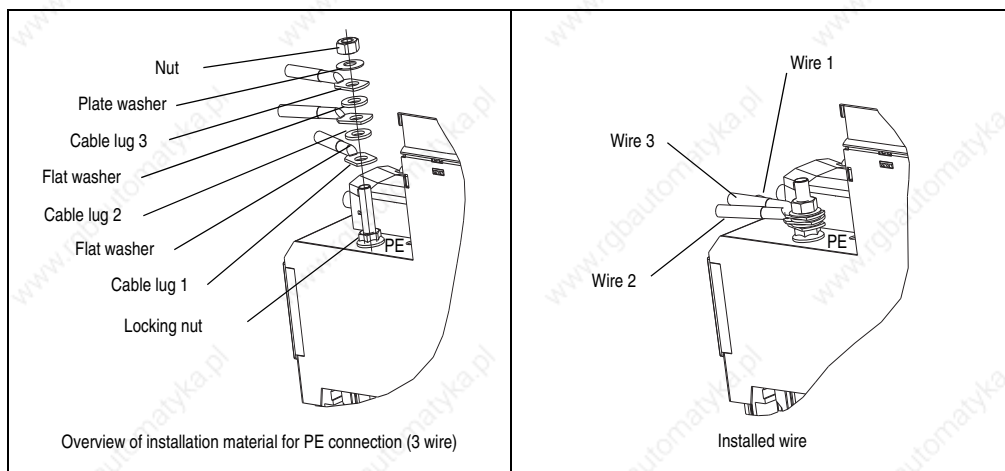


Figure 163: Cable installation connection PE (3 wire)

8.6.6 Input/output circuit diagram

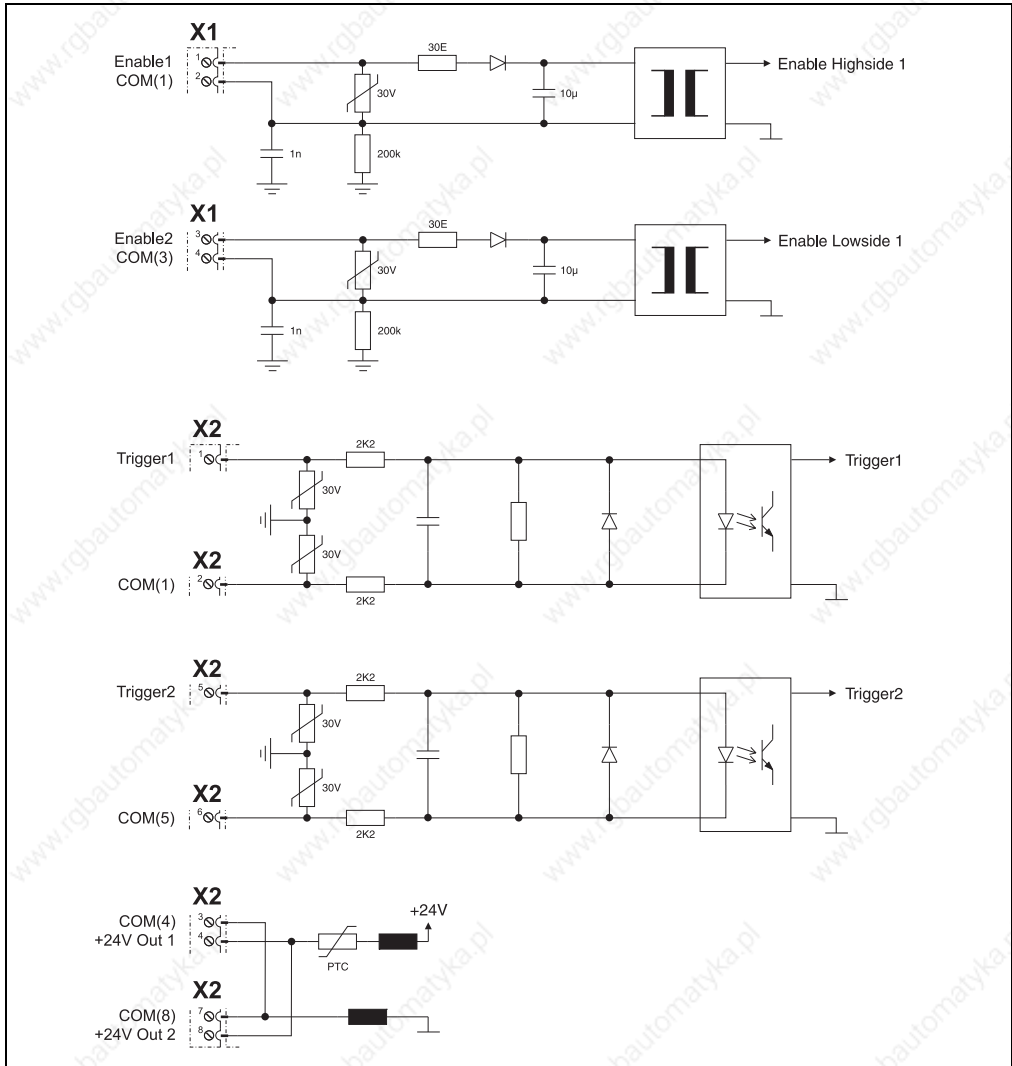


Figure 164: Input/output circuit diagram - 8BVI1650HxS0.000-1

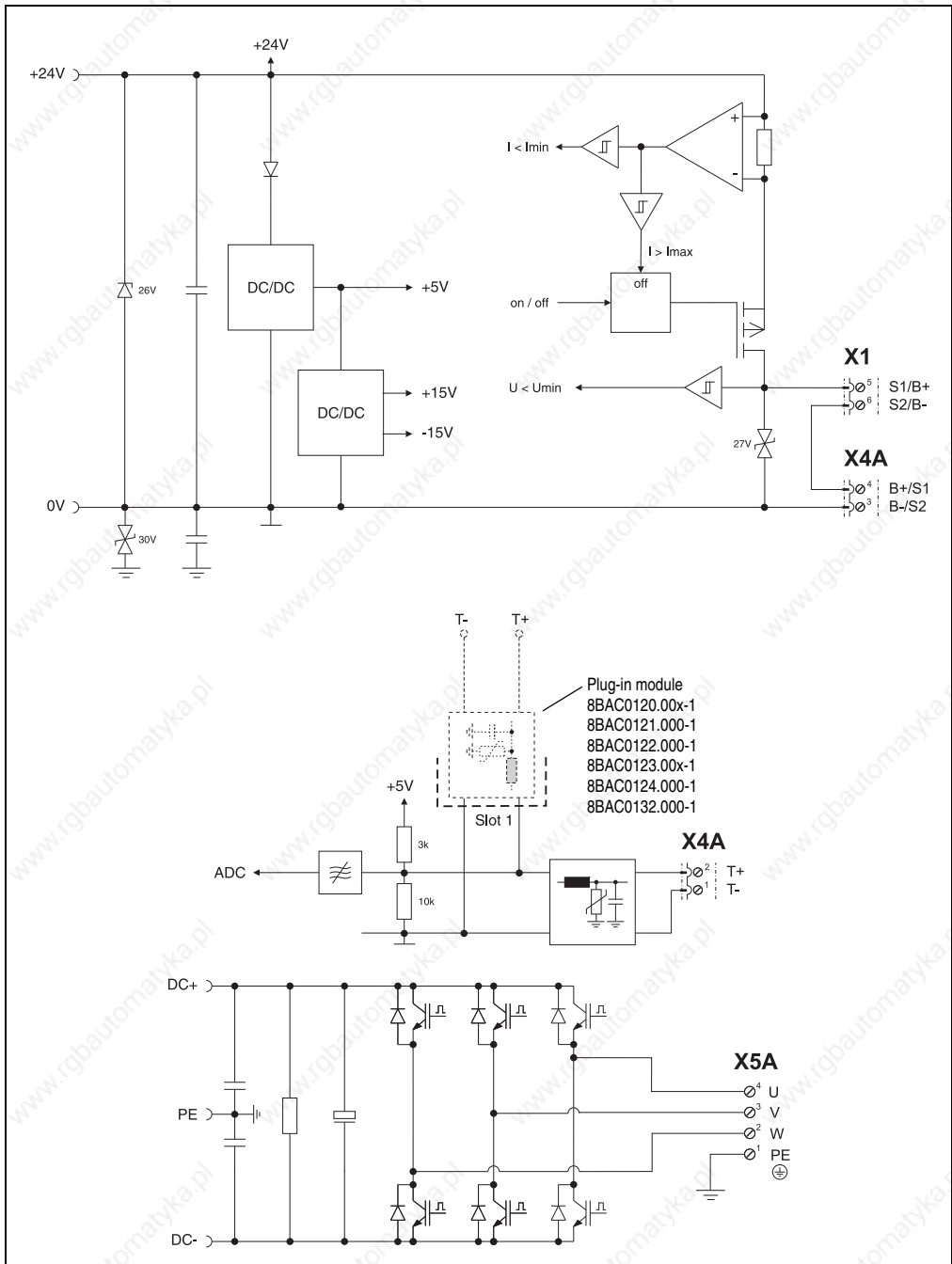


Figure 164: Input/output circuit diagram - 8BVI1650HxS0.000-1 (cont.)

9. 8BVE expansion modules

9.1 8BVE0500Hx00.000-1

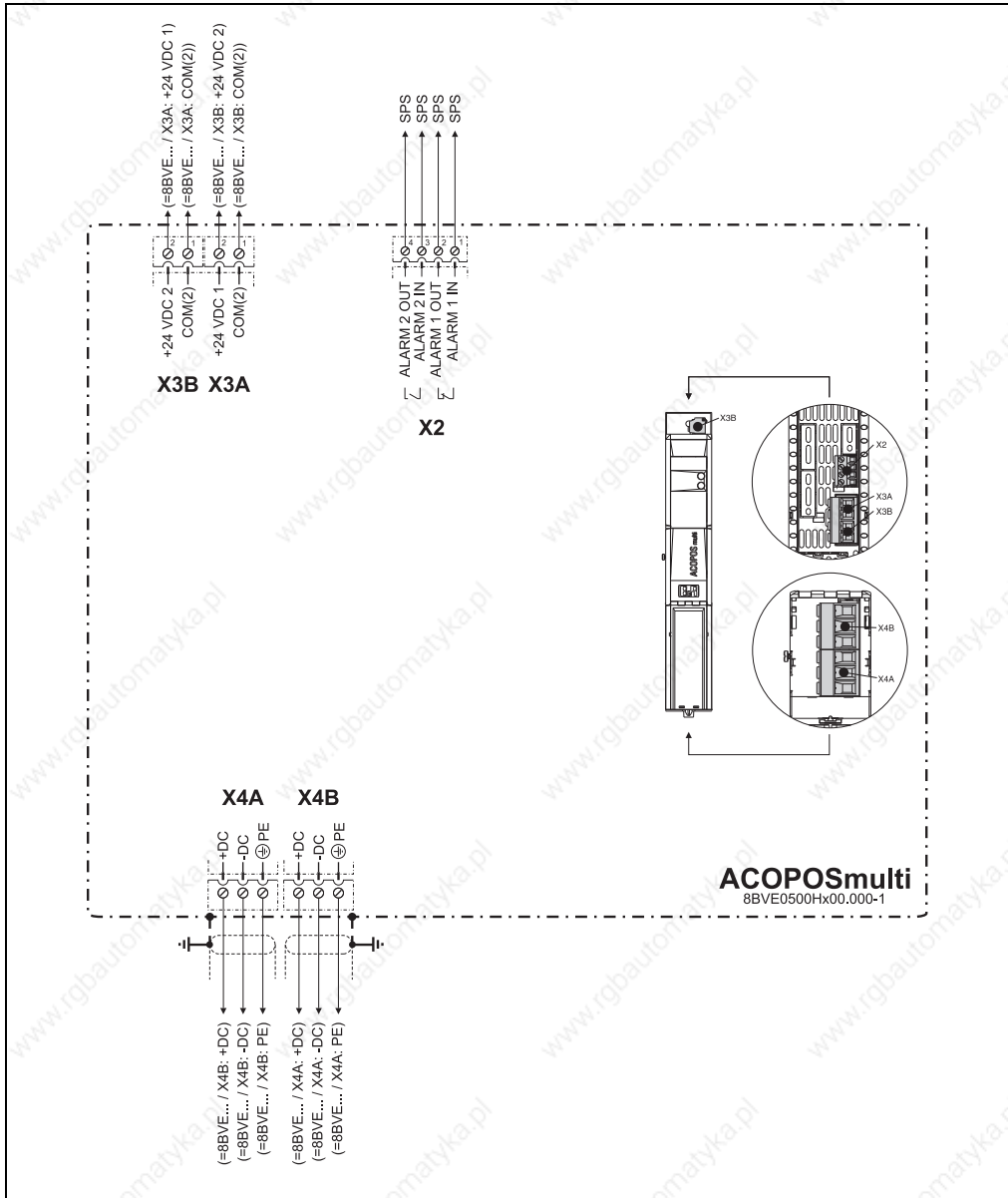


Figure 165: Overview of pin assignments - 8BVE0500Hx00.000-1

9.1.1 Pin assignments - X2 plug

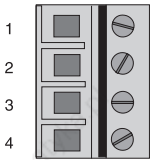
X2	Pin	Name	Function
	1	ALARM 1 IN	Alarm contact 1 IN (NC)
	2	ALARM 1 OUT	Alarm contact 1 OUT (NC)
	3	ALARM 2 IN	Alarm contact 2 IN (NO)
	4	ALARM 2 OUT	Alarm contact 2 OUT (NO)

Table 281: Pin assignments - X2 plug 8BVE0500Hx00.000-1

9.1.2 Pin assignments - X3A plug

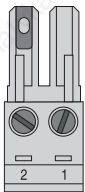
X3A	Pin	Name	Function
	1	COM(2)	+24 V output 1 0 V
	2	+24V VDC 1	+24 V output 1

Table 282: Pin assignments - X3A plug 8BVE0500Hx00.000-1

9.1.3 Pin assignments - X3B plug

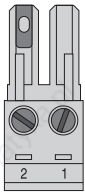
X3B	Pin	Name	Function
	1	COM(2)	+24 V output 2 0 V
	2	+24V VDC 2	+24 V output 2

Table 283: Pin assignments - X3B plug 8BVE0500Hx00.000-1

9.1.4 Pin assignments - X4A plug ¹⁾

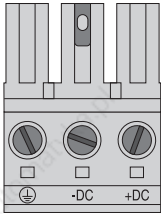
X4A	Name	Function
	+DC	U DC bus 1 +
	-DC	U DC bus 1 -
	PE	Protective ground conductor

Table 284: Pin assignments - X4A plug 8BVE0500Hx00.000-1

9.1.5 Pin assignments - X4B plug ¹⁾

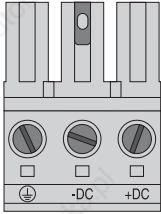
X4B	Name	Function
	+DC	U DC bus 2 +
	-DC	U DC bus 2 -
	PE	Protective ground conductor

Table 285: Pin assignments - X4B plug 8BVE0500Hx00.000-1

1) Shielded cables must be used. B&R recommends the ACOPOSmulti 8BCA expansion cables.

10. 8B0W external braking resistors

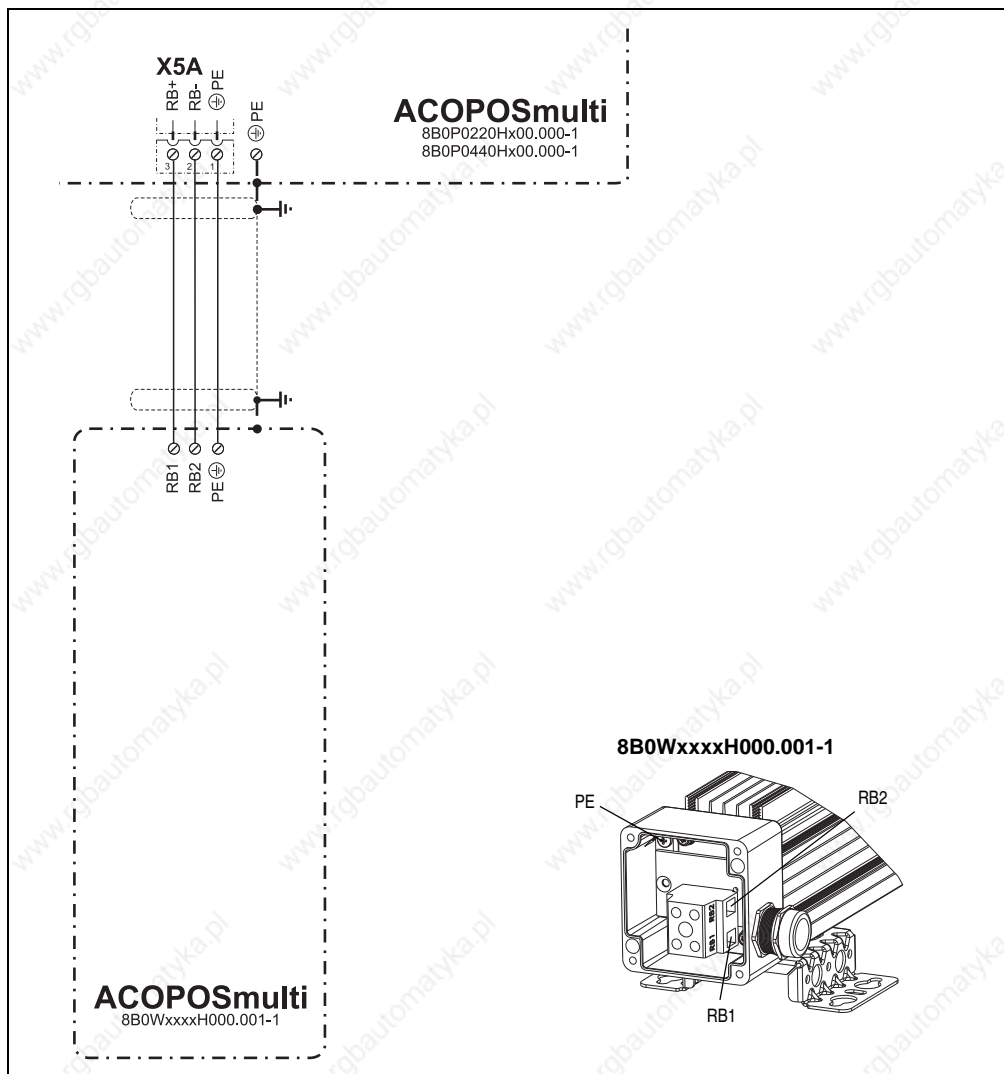


Figure 166: Overview of pin assignments - 8B0W

Information:

8B0W external braking resistors must be wired using connection cables that are suited for maximum line temperatures > 90°C.

Shielded cables must be used for wiring!

11. Plug-in modules

11.1 EnDat 2.1 interface 8BAC0120.000-1

11.1.1 Pin assignments

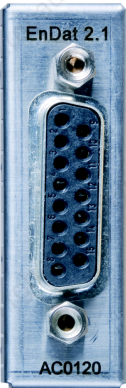
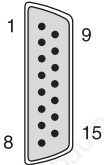
Figure	X11	Pin	Name	Function
		1	A	Channel A
		2	COM	Encoder supply 0 V
		3	B	Channel B
		4	+5V	Encoder supply +5 V
		5	D	Data input
		6	---	---
		7	T+	Temperature sensor +
		8	T	Clock output
		9	A\	Channel A inverted
		10	Sense COM	Sense input 0 V
		11	B\	Channel B inverted
		12	Sense +5V	Sense input +5 V
		13	D\	Data input inverted
		14	T-	Temperature sensor -
		15	T\	Clock output inverted

Table 286: Pin assignments - EnDat 2.1 interface 8BAC0120.000-1

Danger!

The connections for the motor temperature sensors and the encoders are isolated circuits. Therefore, these connections are only allowed to be connected to devices or components with at least safe isolation according to IEC 60364-4-41 or EN 61800-5-1.

11.1.2 Input/output circuit diagram

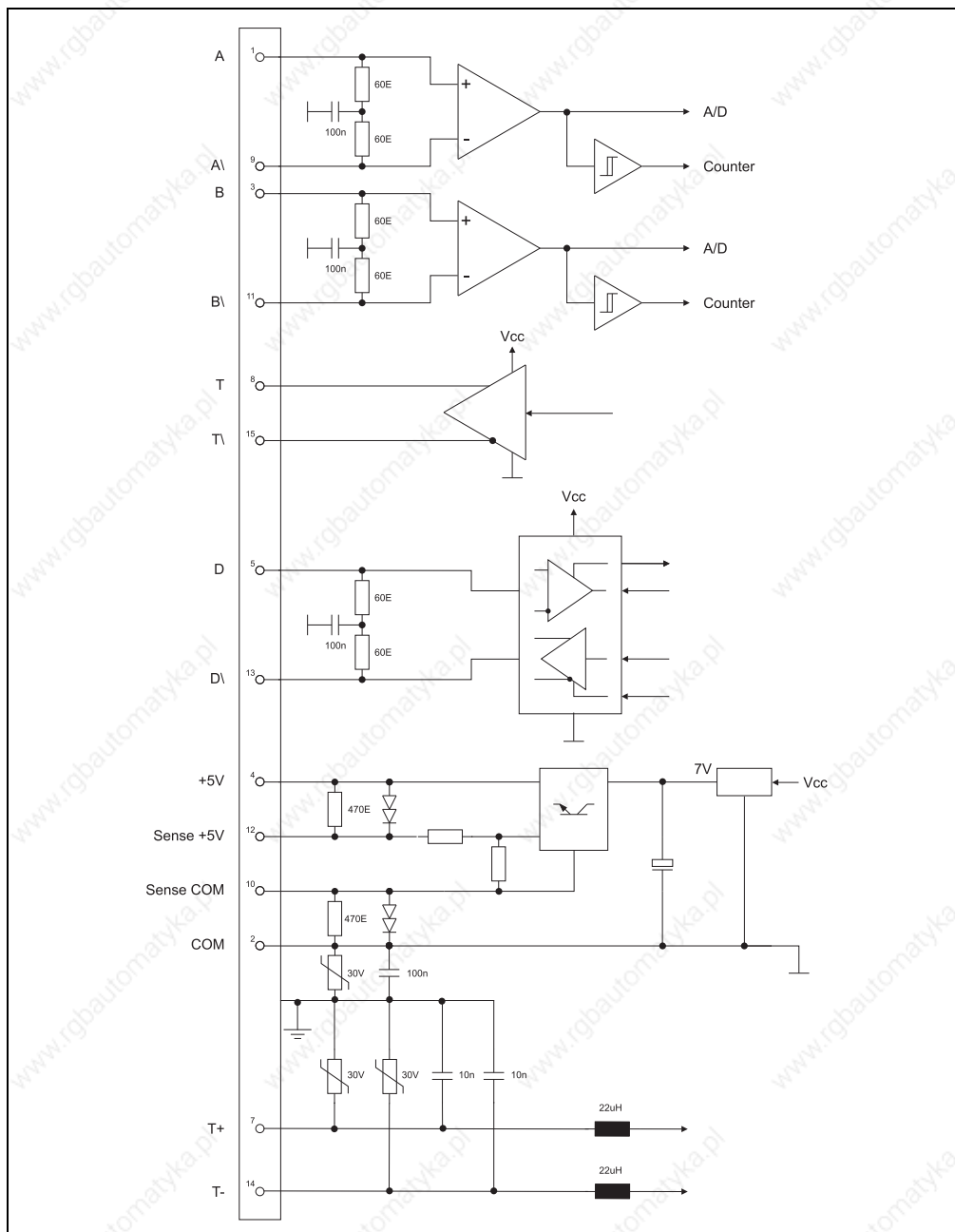


Figure 167: Input/output circuit diagram - EnDat 2.1 interface 8BAC0120.000-1

11.2 EnDat 2.2 interface 8BAC0120.001-2

11.2.1 Pin assignments


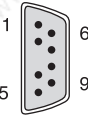
Figure	X11	Pin	Name	Function
 <p>Symbol photo</p>		1	U+	Encoder supply +12.5 V
		2	VBATT	Battery supply
		3	---	Coding
		4	D	Data input
		5	T	Clock output
		6	COM (1)	Encoder supply 0 V
		7	COM (2)	Battery supply 0 V
		8	D\	Data input inverted
		9	T\	Clock output inverted

Table 287: Pin assignments - EnDat 2.2 interface 8BAC0120.001-2

Danger!

The connections for the encoders are isolated circuits. Therefore, these connections are only allowed to be connected to devices or components with at least safe isolation according to IEC 60364-4-41 or EN 61800-5-1.

11.2.2 Input/output circuit diagram

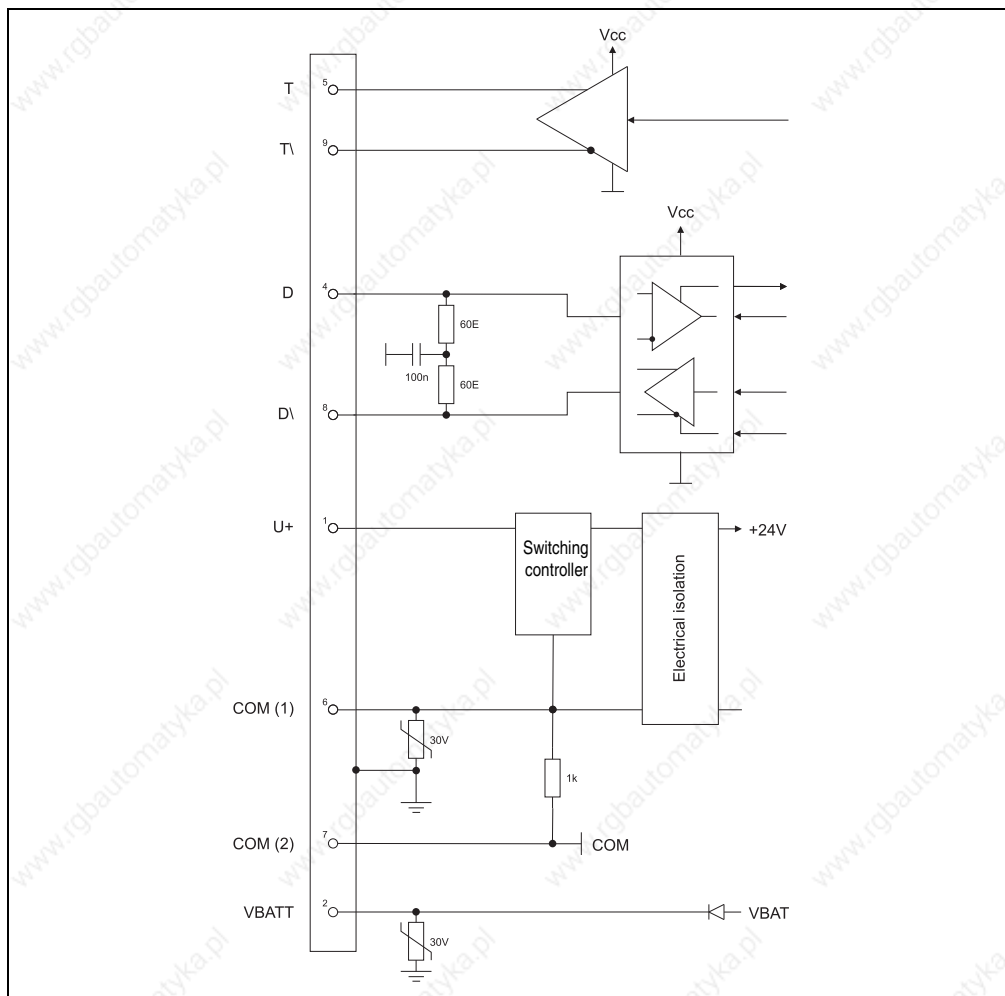


Figure 168: Input/output circuit diagram - EnDat 2.2 interface 8BAC0120.001-2

11.3 HIPERFACE interface 8BAC0121.000-1

11.3.1 Pin assignments

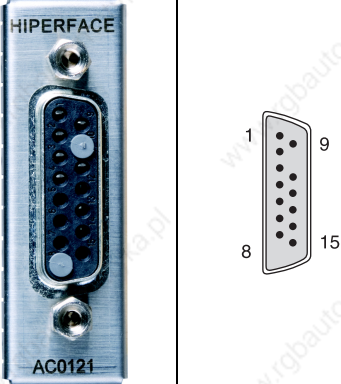
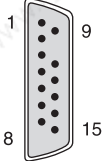
Figure	X11	Pin	Name	Function
		1	SIN	Channel SIN
		2	COM	Encoder supply 0 V
		3	COS	Channel COS
		4	+10V	Encoder supply +10 V
		5	D	Data input
		6	---	---
		7	T+	Temperature sensor +
		8	---	Coding
		9	REF SIN	REF SIN channel
		10	---	Coding
		11	REF COS	REF COS channel
		12	---	---
		13	D\	Data input inverted
		14	T-	Temperature sensor -
		15	---	---

Table 288: Pin assignments - HIPERFACE interface 8BAC0121.000-1

Danger!

The connections for the motor temperature sensors and the encoders are isolated circuits. Therefore, these connections are only allowed to be connected to devices or components with at least safe isolation according to IEC 60364-4-41 or EN 61800-5-1.

11.3.2 Input/output circuit diagram

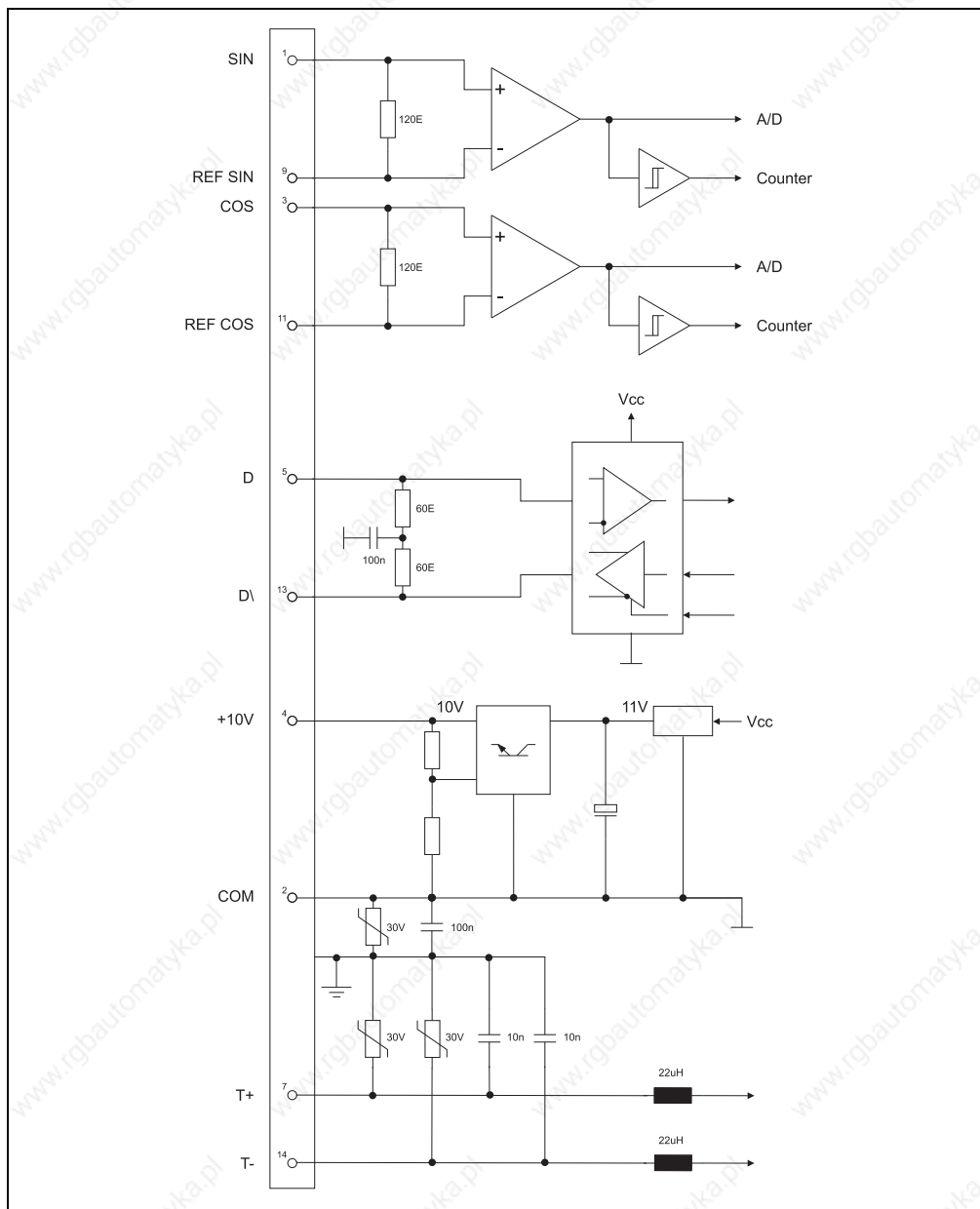


Figure 169: Input/output circuit diagram - HIPERFACE interface 8BAC0121.000-1

11.4 Resolver interface 8BAC0122.000-1

11.4.1 Pin assignments

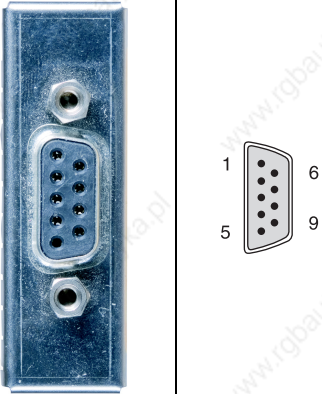
Figure	X11	Pin	Name ¹⁾	Function	Typical wire colors for the resolver ²⁾
		1	T+	Temperature sensor +	---
		2	T-	Temperature sensor -	---
		3	S4	Sine input +	Blue
		4	S1	Cosine input -	Red
		5	R2	Reference output +	black/white (or yellow/white)
		6	---	---	---
		7	S2	Sine input -	Yellow
		8	S3	Cosine input +	Black
		9	R1	Reference output -	red/white

Table 289: Pin assignments - Resolver interface 8BAC0122.000-1

1) The names are the same as those used by leading manufacturers (Tanagawa, Tyco, LTN).

2) This refers to the wire colors of the line connected directly to the resolver and used universally by leading manufacturers (Tanagawa, Tyco, LTN). **This does not refer to the wire colors of the B&R resolver cable!**

Danger!

The connections for the motor temperature sensors and the encoders are isolated circuits. Therefore, these connections are only allowed to be connected to devices or components with at least safe isolation according to IEC 60364-4-41 or EN 61800-5-1.

11.4.2 Input/output circuit diagram

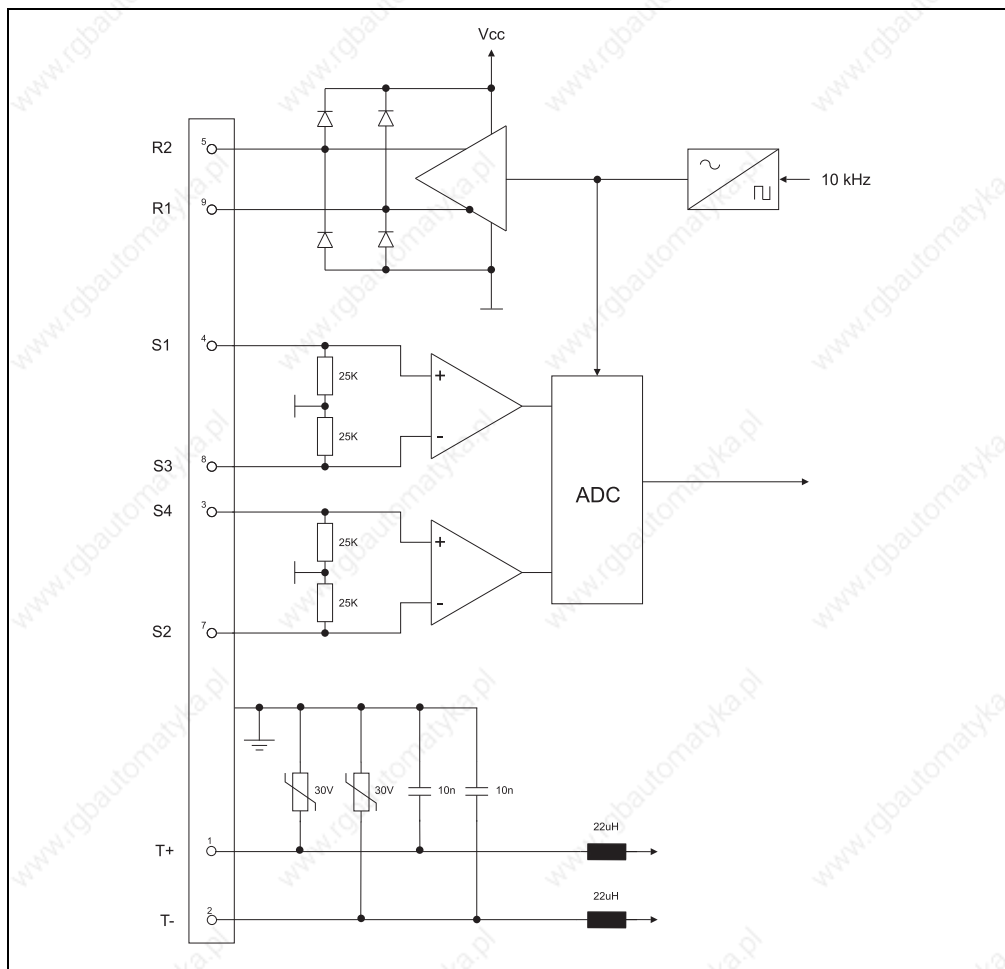


Figure 170: Input/output circuit diagram - Resolver interface 8BAC0122.000-1

11.5 Incremental/SSI encoder interface 8BAC0123.000-1

11.5.1 Pin assignments

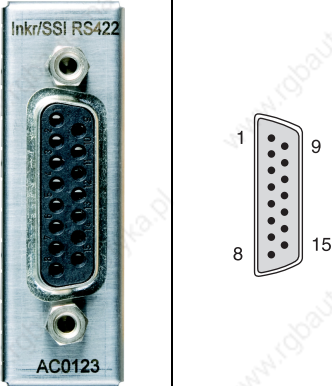
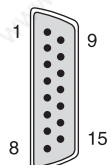
Figure	X11	Pin	Name	Function in Incremental mode	Function in SSI mode	
		1	A	Channel A	---	
		2	A\	Channel A inverted	---	
		3	B	Channel B	---	
		4	B\	Channel B inverted	---	
		5	RD	Reference pulse	Data input	
		6	RD\	Reference pulse inverted	Data input inverted	
		7	T	---	Clock output	
		8	T\	---	Clock output inverted	
		9	+5V out	Encoder supply +5 V		
		10	Sense +5V	Sense input +5 V		
		11	Sense COM	Sense input 0 V		
		12	COM (1 - 9, 13)	Encoder supply 0 V		
		13	+24V out	Encoder supply +24 V		
		14	T+	Temperature sensor +		
		15	T-	Temperature sensor -		

Table 290: Pin assignments - Incremental/SSI encoder interface 8BAC0123.000-1

Danger!

The connections for the motor temperature sensors and the encoders are isolated circuits. Therefore, these connections are only allowed to be connected to devices or components with at least safe isolation according to IEC 60364-4-41 or EN 61800-5-1.

Caution!

This plug-in module uses the same type of connection as the EnDat plug-in module 8BAC0120.000-1 (15-pin DSUB socket).

Warning (danger of confusion)! EnDat encoders will be damaged if connected to this plug-in module!

11.5.2 Input/output circuit diagram

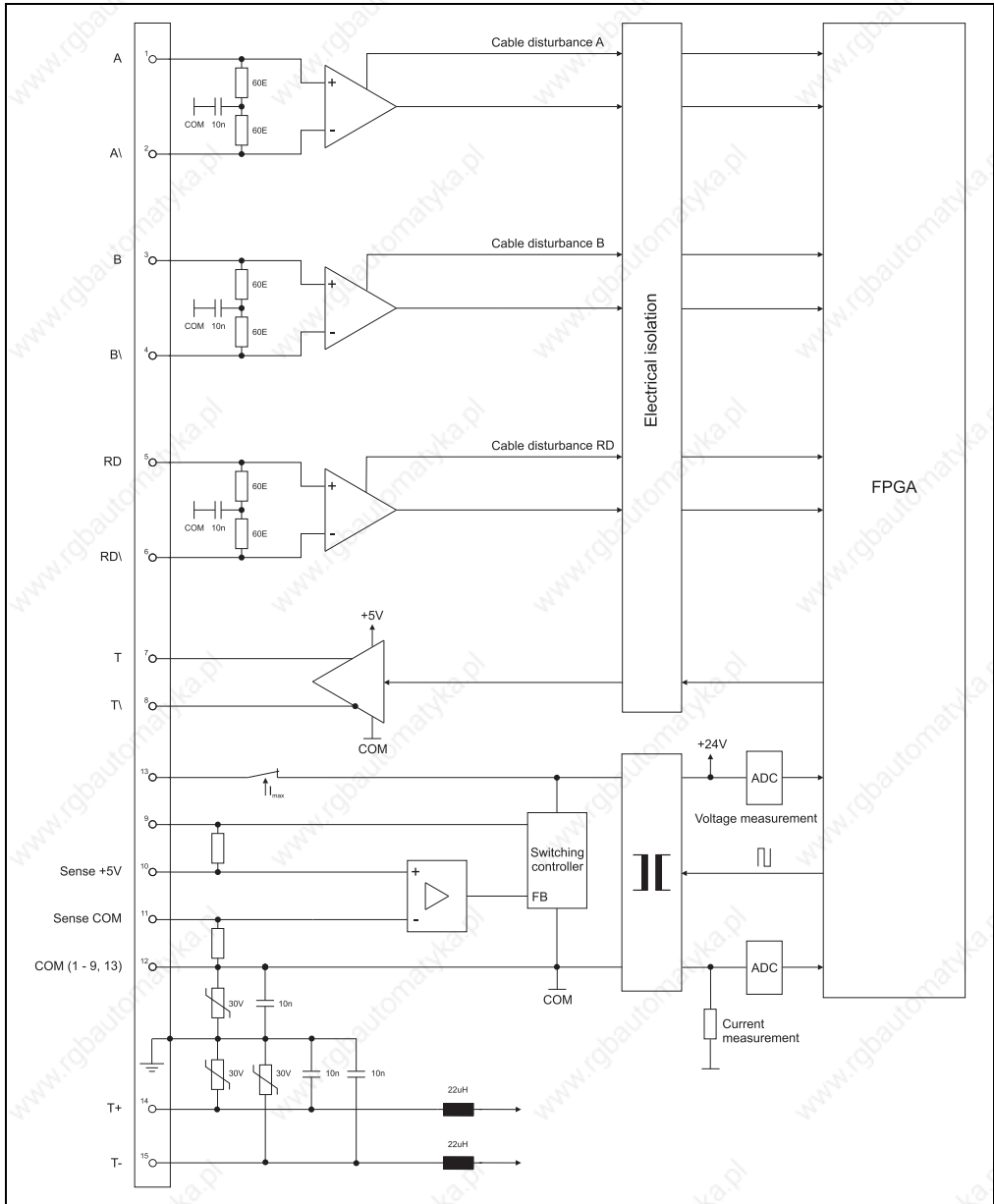


Figure 171: Input/output circuit diagram - Incremental/SSI encoder interface 8BAC0123.000-1

11.5.3 Tracer pin connection (in preparation)

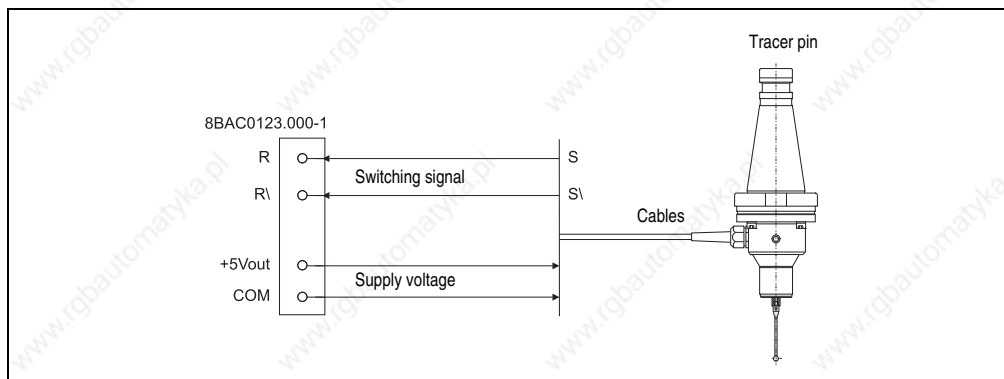


Figure 172: Connection example for cabled tracer pins with 5V supply and TTL output signals

The reference pulse input is used as an input for the switching signal for the tracer pins. Wire break monitoring for channels A and B must be deactivated.

11.6 Incremental encoder interface 8BAC0123.001-1

11.6.1 Pin assignments

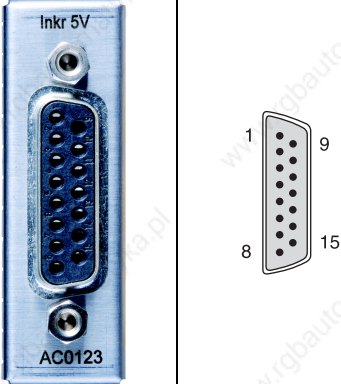
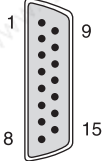
Figure	X11	Pin	Name	Function
		1	A	Channel A
		2	A\	Channel A inverted
		3	B	Channel B
		4	B\	Channel B inverted
		5	RD	Reference pulse
		6	RD\	Reference pulse inverted
		7	n.c.	---
		8	n.c.	---
		9	+5V out	Encoder supply +5 V
		10	Sense +5V	Sense input +5 V
		11	Sense COM	Sense input 0 V
		12	COM (1 - 6, 9)	Encoder supply 0 V
		13	n.c.	---
		14	T+	Temperature sensor +
		15	T-	Temperature sensor -

Table 291: Pin assignments - Incremental encoder interface 8BAC0123.001-1

Danger!

The connections for the motor temperature sensors and the encoders are isolated circuits. Therefore, these connections are only allowed to be connected to devices or components with at least safe isolation according to IEC 60364-4-41 or EN 61800-5-1.

11.6.2 Input/output circuit diagram

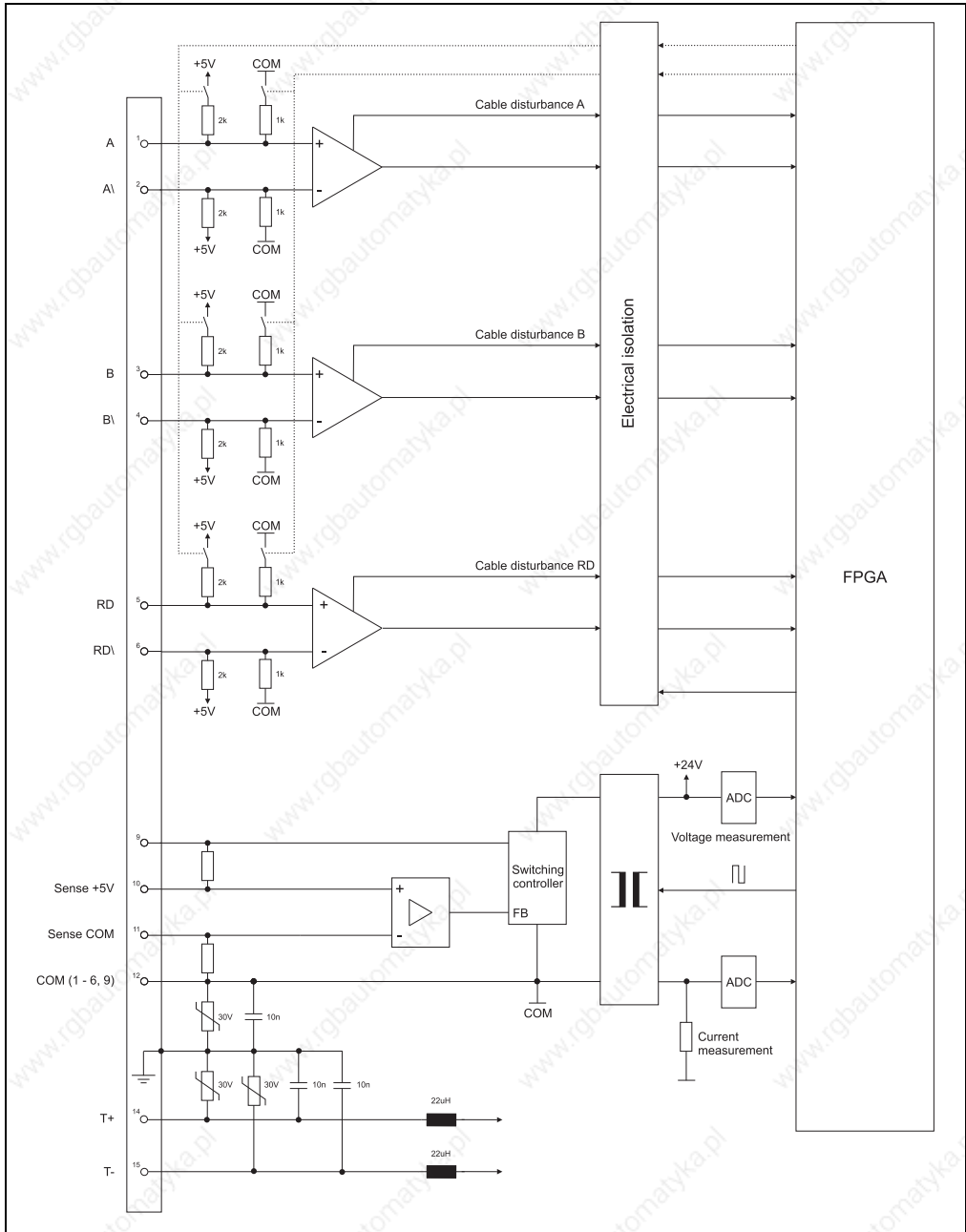


Figure 173: Input/output circuit diagram - Incremental encoder interface 8BAC0123.001-1

11.6.3 Configuration of the pull-up and pull-down resistances in the module

The pull-up and pull-down resistances in the module can be switched using software so that encoders with different output designs can be connected. As default, the module is configured for encoders with push-pull outputs.

Encoders with push-pull outputs (default)	Encoders with push outputs	Encoders with pull outputs
<p>The pull-up and pull-down resistances in the module are activated at the same time:</p>	<p>Only the pull-down resistance in the module is activated:</p>	<p>Only the pull-up resistance in the module is activated:</p>

Table 292: Possible configurations of the pull-up and pull-down resistances in the module

11.6.4 Configuration of wire break monitoring

Encoders with push-pull outputs

Wire break monitoring is possible as default.

Encoders with push or pull outputs

Wire break monitoring is only possible if the encoder itself is equipped with pull-up or pull-down resistances (pull-up: max. 2 k Ω , pull-down: max. 560 Ω) and the module is configured for encoders with push-pull outputs.

Wire break monitoring for encoders with push outputs	Wire break monitoring for encoders with pull outputs

Table 293: Configuration of wire break monitoring for encoders with push or pull outputs

11.7 Incremental encoder interface 8BAC0123.002-1

11.7.1 Pin assignments

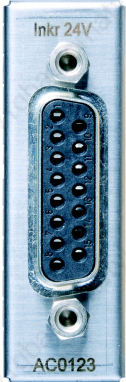
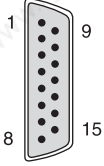
Figure	X11	Pin	Name	Function
		1	A	Channel A
		2	A\	Channel A inverted
		3	B	Channel B
		4	B\	Channel B inverted
		5	RD	Reference pulse
		6	RD\	Reference pulse inverted
		7	n.c.	---
		8	n.c.	---
		9	n.c.	---
		10	n.c.	---
		11	n.c.	---
		12	COM (1 - 6, 13)	Encoder supply 0 V
		13	+24V out	Encoder supply +24 V
		14	T+	Temperature sensor +
		15	T-	Temperature sensor -

Table 294: Pin assignments - Incremental encoder interface 8BAC0123.002-1

Danger!

The connections for the motor temperature sensors and the encoders are isolated circuits. Therefore, these connections are only allowed to be connected to devices or components with at least safe isolation according to IEC 60364-4-41 or EN 61800-5-1.

Caution!

This plug-in module uses the same type of connection as the EnDat plug-in module 8BAC0120.000-1 (15-pin DSUB socket).

Warning (danger of confusion)! EnDat encoders will be damaged if connected to this plug-in module!

11.7.2 Input/output circuit diagram

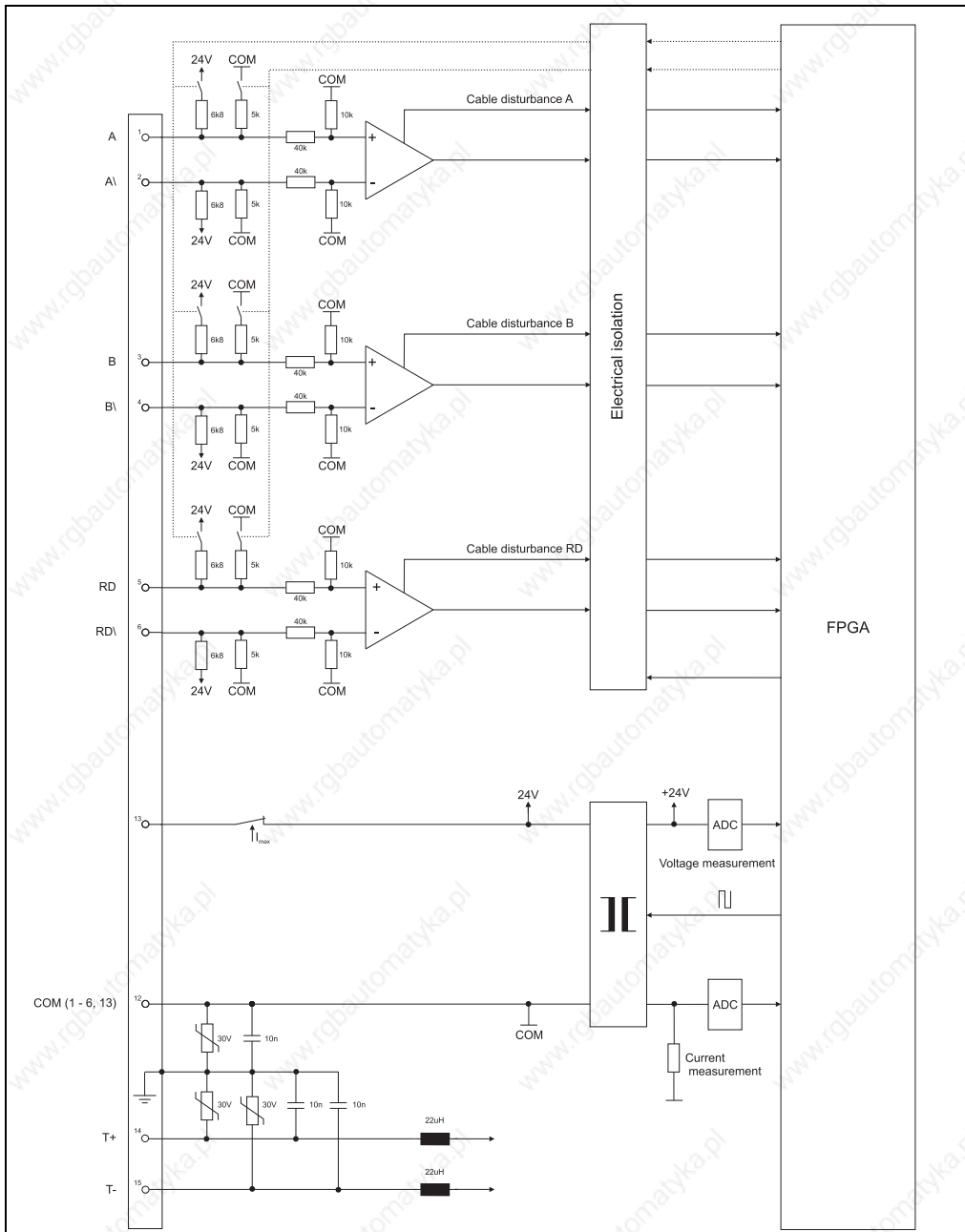


Figure 174: Input/output circuit diagram - Incremental encoder interface 8BAC0123.002-1

11.7.3 Tracer pin connection (in preparation)

Cabled tracer pins

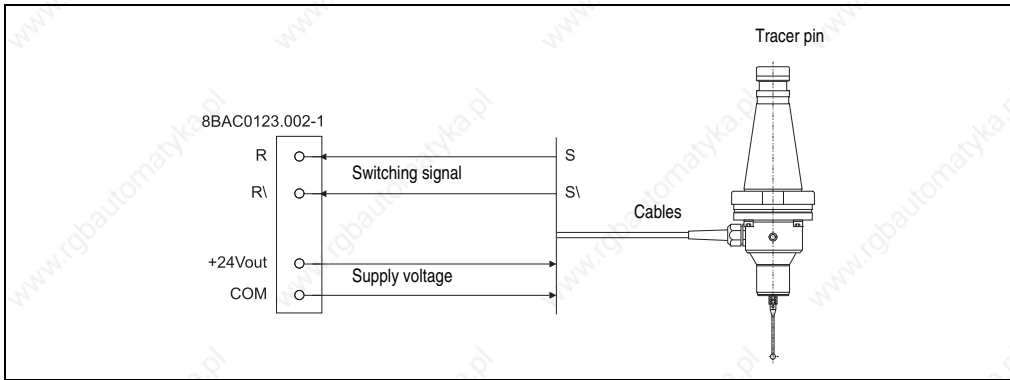


Figure 175: Connection example for cabled tracer pins with 24V supply and HTL output signals

The reference pulse input is used as an input for the switching signal for the tracer pins. Wire break monitoring for channels A and B must be deactivated.

Cable-free (IR) tracer pins

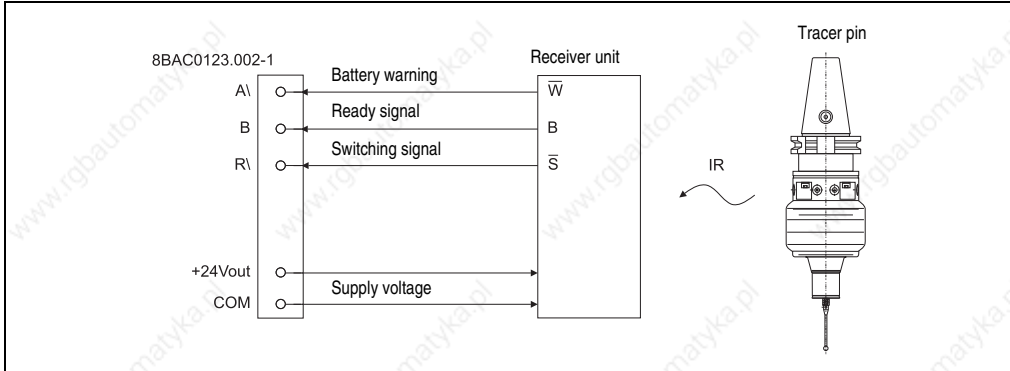


Figure 176: Connection example for cable-free (IR) tracer pins with 24V supply and HTL output signals

The reference pulse input is used as an input for the switching signal for the tracer pins. Additionally, channels A and B are used for the battery warning and the ready signal.

11.7.4 Configuration of the pull-up and pull-down resistances in the module

The pull-up and pull-down resistances in the module can be switched using software so that encoders with different output designs can be connected. As default, the module is configured for encoders with push-pull outputs.

Encoders with push-pull outputs (default)	Encoders with push outputs	Encoders with pull outputs
<p>The pull-up and pull-down resistances in the module are activated at the same time:</p>	<p>Only the pull-down resistance in the module is activated:</p>	<p>Only the pull-up resistance in the module is activated:</p>

Table 295: Possible configurations of the pull-up and pull-down resistances in the module

11.7.5 Configuration of wire break monitoring

Encoders with push-pull outputs

Wire break monitoring is possible as default.

Encoders with push or pull outputs

Wire break monitoring is only possible if the encoder itself is equipped with pull-up or pull-down resistances (pull-up: max. 5.6 kΩ, pull-down: max. 3.9 kΩ) and the module is configured for encoders with push-pull outputs.

Wire break monitoring for encoders with push outputs	Wire break monitoring for encoders with pull outputs

Table 296: Configuration of wire break monitoring for encoders with push or pull outputs

11.8 SinCos interface 8BAC0124.000-1

11.8.1 Pin assignments

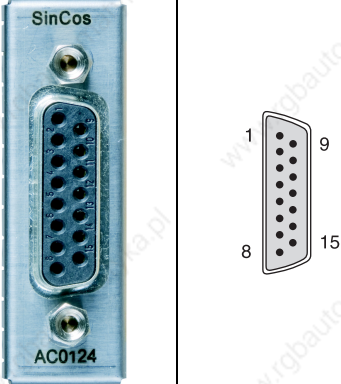
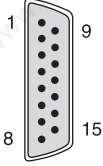
Figure	X11	Pin	Name	Function
		1	A	Channel A
		2	COM	Encoder supply 0 V
		3	B	Channel B
		4	+5V	Encoder supply +5 V
		5	T+	Temperature sensor +
		6	Limit -	Negative limit (L2)
		7	R\	Reference pulse inverted
		8	Limit+	Positive limit (L1)
		9	A\	Channel A inverted
		10	Sense COM	Sense input 0 V
		11	B\	Channel B inverted
		12	Sense +5V	Sense input +5 V
		13	T-	Temperature sensor -
		14	R	Reference pulse
		15	---	---

Table 297: Pin assignments - SinCos interface 8BAC0124.000-1

Danger!

The connections for the motor temperature sensors and the encoders are isolated circuits. Therefore, these connections are only allowed to be connected to devices or components with at least safe isolation according to IEC 60364-4-41 or EN 61800-5-1.

11.8.2 Input/output circuit diagram

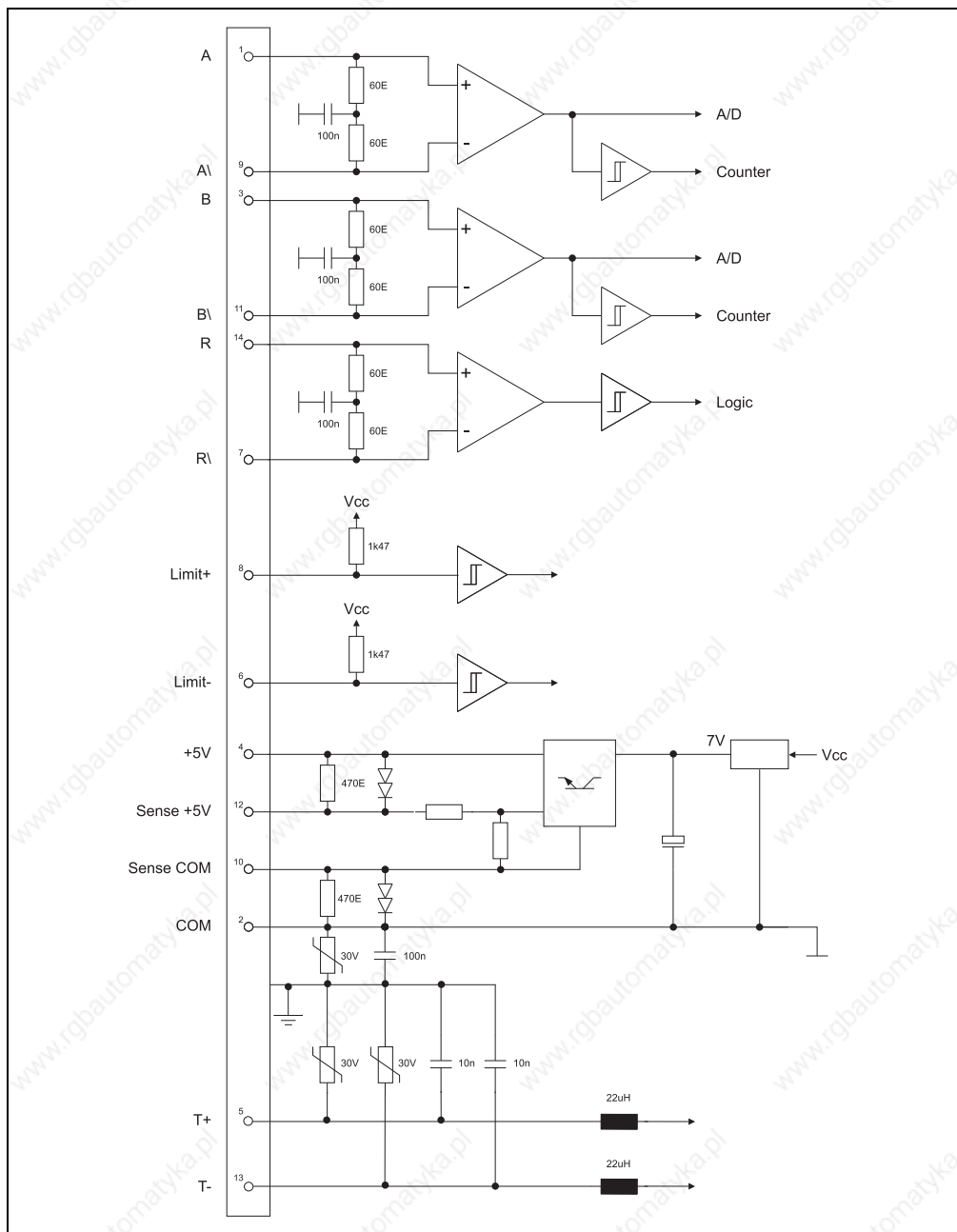


Figure 177: Input/output circuit diagram - SinCos interface 8BAC0124.000-1

11.9 Digital I/O Interface 8BAC0130.000-1

11.9.1 Pin assignments



Figure	X11	Pin	Name	Function
		1	Digital O 1	Digital output 1
		2	n.c.	---
		3	Digital O 2	Digital output 2
		4	n.c.	---
		5	Digital O 3	Digital output 3
		6	Digital O 4	Digital output 4
		7	Digital I 1	Digital input 1
		8	Digital I 2	Digital input 2
		9	+24V In	+24 V supply
		10	COM (1,3,5 - 9)	0 V supply
Terminal cross sections			[mm²]	[AWG]
Solid core / multiple conductor lines			0.2 - 1.5	28 - 14
Flexible, multiple wire line without Wire Tip Sleeves			0.2 - 1.5	28 - 14
with Wire Tip Sleeves			0.2 - 1.5	28 - 14
Approval data				
UL/C-UL-US			---	28 - 14
CSA			---	28 - 14
Holding torque for the terminal screws [Nm]			0.2 to 0.25	

Table 298: Pin assignments - Digital I/O Interface 8BAC0130.000-1

Caution!

The two high-speed digital outputs (X11/1 and X11/3) must be wired using shielded lines.

The shield set 8SCS002.0000-00 must be used on ACOPOSmulti power supply modules and inverter modules! The shield must be attached as close to the terminal as possible.

11.9.2 Input/output circuit diagram

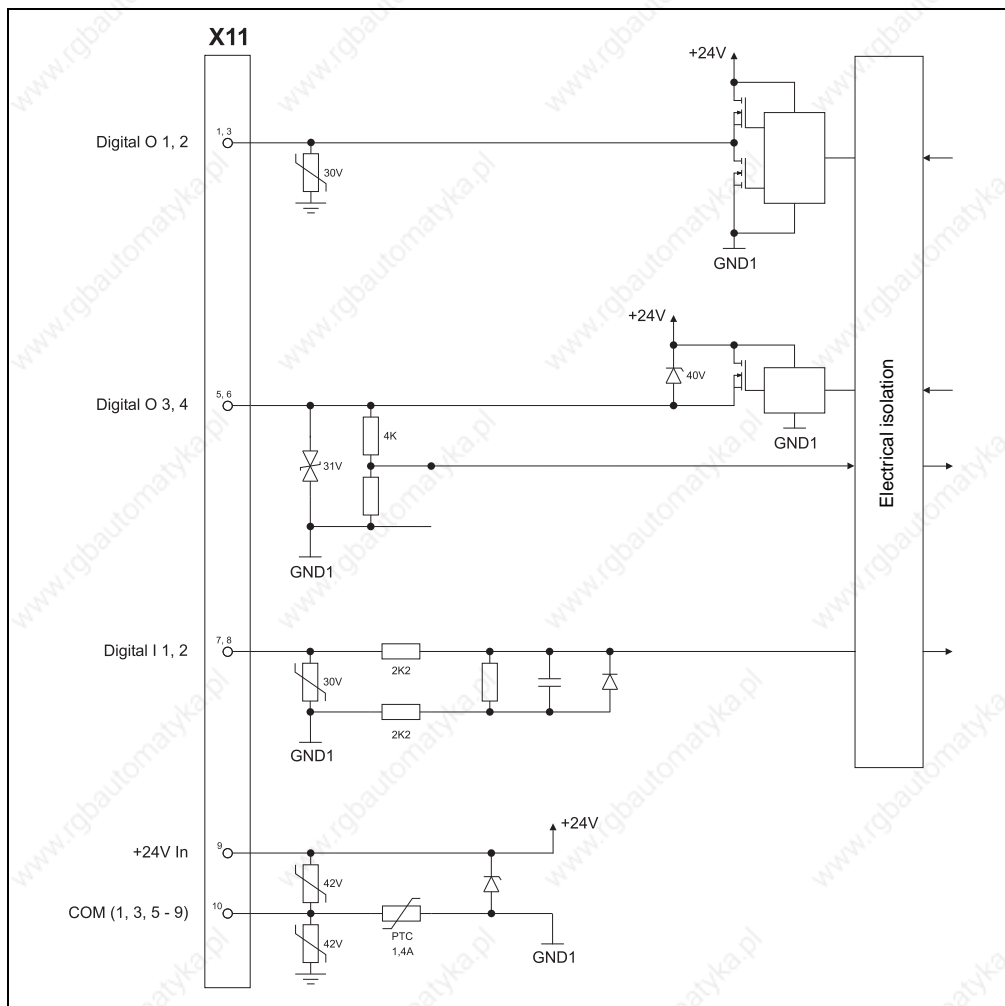


Figure 178: Input/output circuit diagram - Digital I/O Interface 8BAC0130.000-1

11.10 Digital Out Interface 8BAC0130.001-1

11.10.1 Pin assignments



Figure	X11	Pin	Name	Function
		1	Digital O 1	Digital output 1
		2	n.c.	---
		3	Digital O 2	Digital output 2
		4	n.c.	---
		5	Digital O 3	Digital output 3
		6	Digital O 4	Digital output 4
		7	Digital O 5	Digital output 5
		8	Digital O 6	Digital output 6
		9	+24V In	+24 V supply
		10	COM (1,3,5 - 9)	0 V supply
Terminal cross sections		[mm²]	[AWG]	
Solid core / multiple conductor lines		0.2 - 1.5	28 - 14	
Flexible, multiple wire line without Wire Tip Sleeves		0.2 - 1.5	28 - 14	
with Wire Tip Sleeves		0.2 - 1.5	28 - 14	
Approval data				
UL/C-UL-US		---	28 - 14	
CSA		---	28 - 14	
Holding torque for the terminal screws [Nm]		0.2 to 0.25		

Table 299: Pin assignments - Digital Out Interface 8BAC0130.001-1

Caution!

The two high-speed digital outputs (X11/1 and X11/3) must be wired using shielded lines.

The shield set 8SCS002.0000-00 must be used on ACOPOSmulti power supply modules and inverter modules! The shield must be attached as close to the terminal as possible.

11.10.2 Input/output circuit diagram

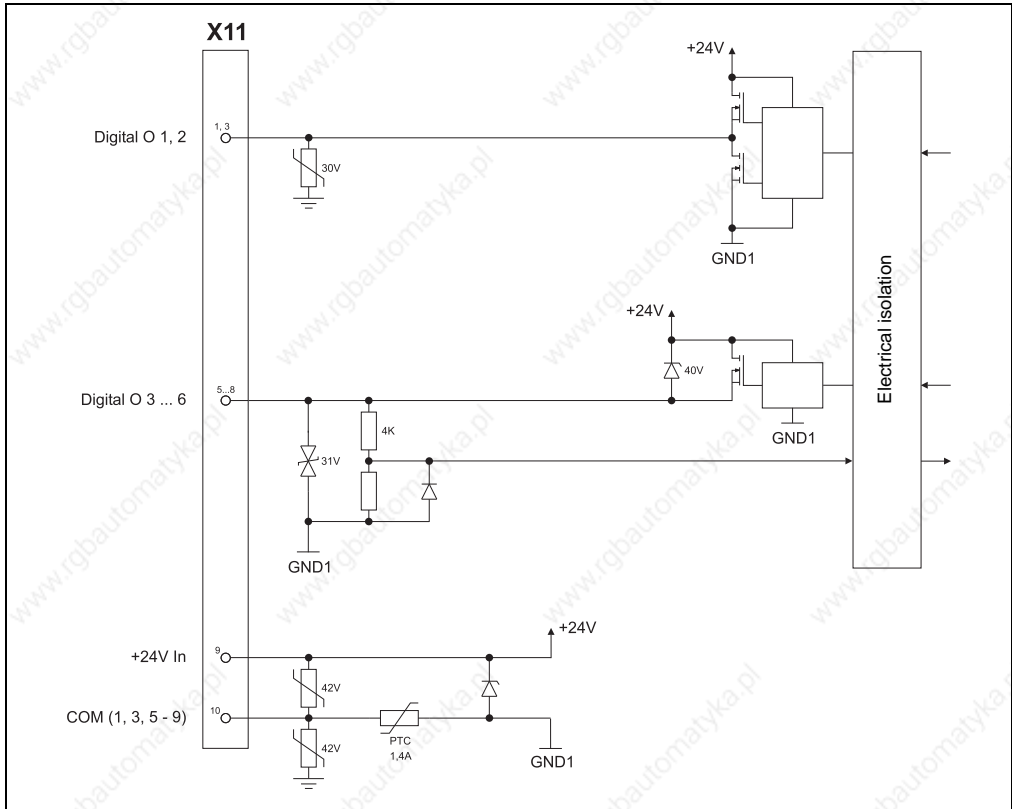


Figure 179: Input/output circuit diagram - Digital Out interface 8BAC0130.001-1

11.11 Analog interface 8BAC0132.000-1

11.11.1 Pin assignments

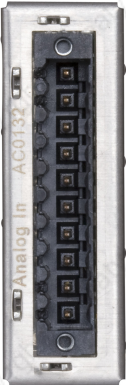

Figure	X11	Pin	Name	Function
		1	Analog I 1 +	Analog input 1 plus
		2	Analog I 1 -	Analog input 1 minus
		3	Shield (1,2,4,5)	Shield connection
		4	Analog I 2 +	Analog input 2 plus
		5	Analog I 2 -	Analog input 2 minus
		6	Analog I 3 +	Analog input 3 plus
		7	Analog I 3 -	Analog input 3 minus
		8	Shield (6,7,9,10)	Shield connection
		9	Analog I 4 +	Analog input 4 plus
		10	Analog I 4 -	Analog input 4 minus
Terminal cross sections		[mm²]	[AWG]	
Solid core / multiple conductor lines		0.2 - 1.5	28 - 14	
Flexible, multiple wire line without Wire Tip Sleeves		0.2 - 1.5	28 - 14	
with Wire Tip Sleeves		0.2 - 1.5	28 - 14	
Approval data				
UL/C-UL-US		---	28 - 14	
CSA		---	28 - 14	
Holding torque for the terminal screws [Nm]		0.2 to 0.25		

Table 300: Pin assignments - Analog interface 8BAC0132.000-1

11.11.2 Input/output circuit diagram

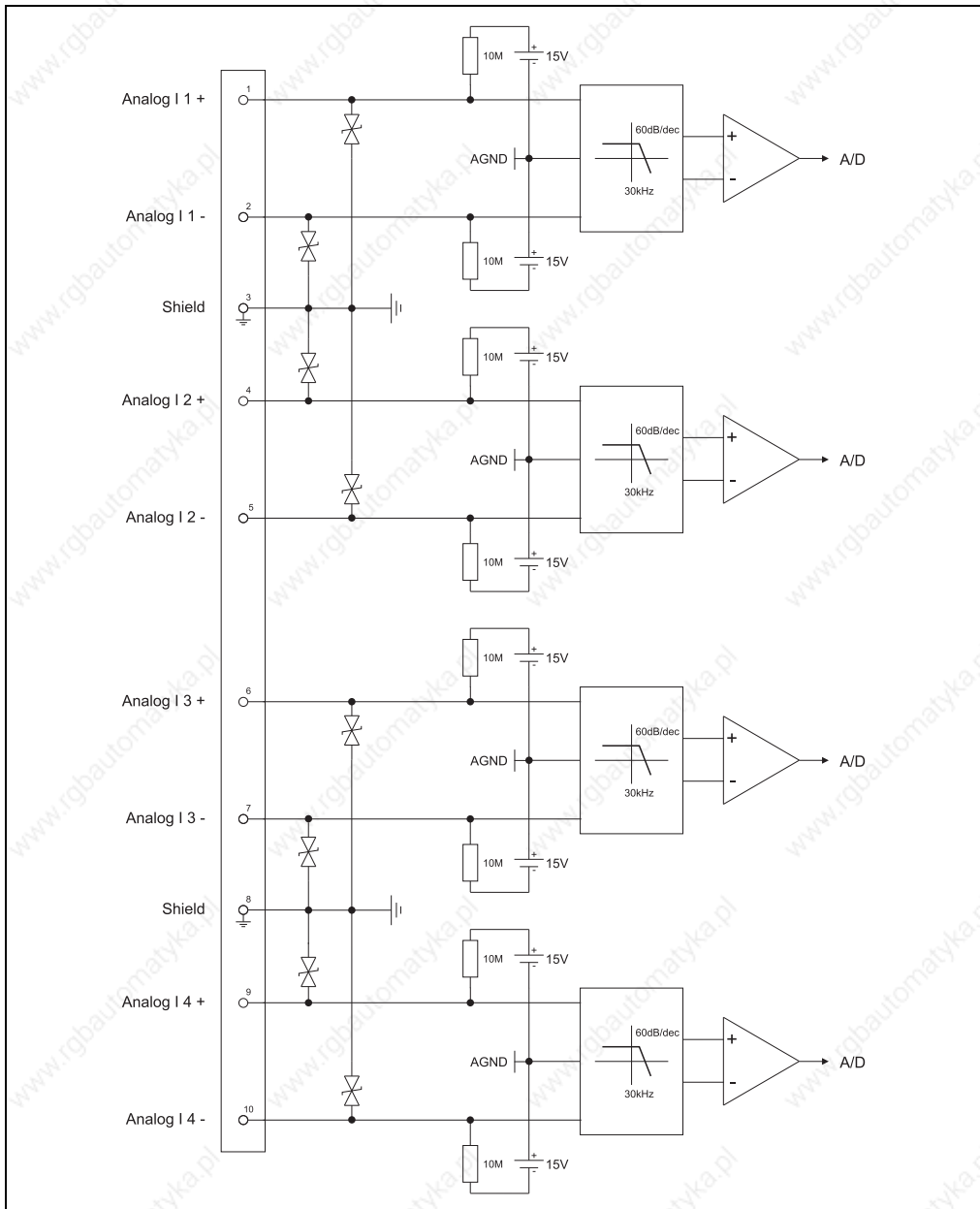


Figure 180: Input/output circuit diagram - Analog interface 8BAC0132.000-1

12. Cables

12.1 8BCM motor cable

12.1.1 8BCMxxxx.1111A-0, 8BCMxxxx.1312A-0

Construction

Pos.	pieces	Name	Note
1	1	Motor lines	4 x 1.5 mm ² + 2 x 2 x 0.75 mm ² (for 8BCMxxxx.1111A-0) 4 x 4 mm ² + 2 x 2 x 1 mm ² (for 8BCMxxxx.1312A-0)
2	1	Circular plug, 8-pin socket	BSTA 078 NN00 42 0100 000 (for 8BCMxxxx.1111A-0) BSTA 078 NN00 59 0100 000 (for 8BCMxxxx.1312A-0)
3	1	Heat shrink tubing	
4	8	Wire tip sleeve	
5	1	Cable clamps	
6	1	Shield plate	

Table 301: Construction - Motor cable 8BCMxxxx.1111A-0, 8BCMxxxx.1312A-0

Pin assignments

Circular plug	Pin	Name	Function
	1	U	Motor connection U
	4	V	Motor connection V
	3	W	Motor connection W
	2	PE	Protective ground conductor
	A	T+	Temperature +
	B	T-	Temperature -
	C	B+	Brake +
	D	B-	Brake -

Table 302: Pin assignments - Motor cable 8BCMxxxx.1111A-0, 8BCMxxxx.1312A-0

Cable schematic

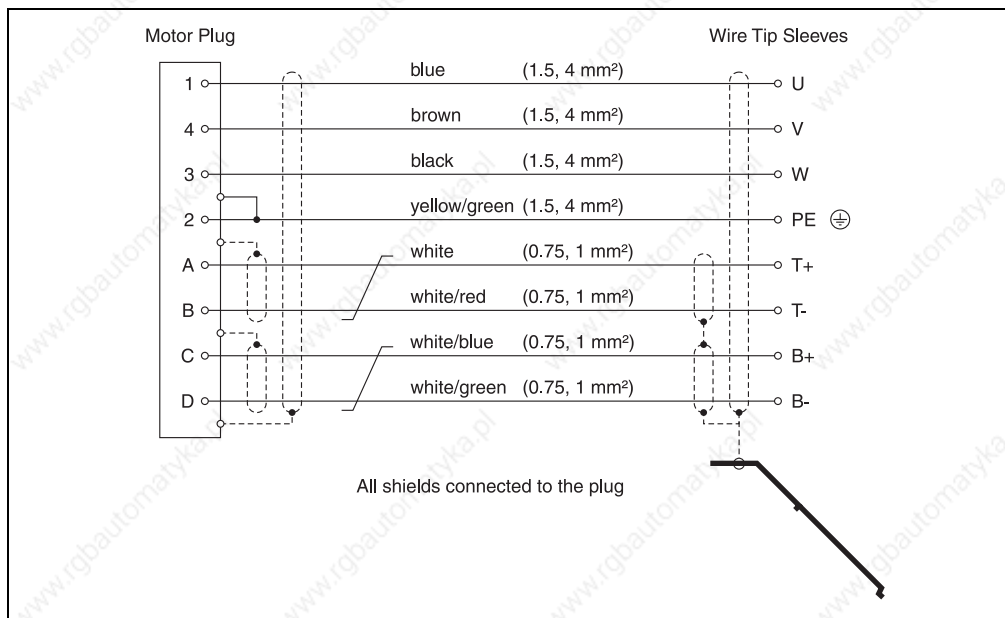
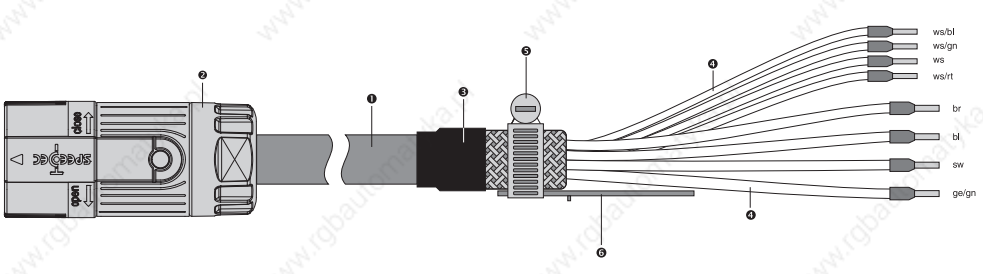


Figure 181: Cable schematic - Motor cable 8BCMxxxx.1111A-0, 8BCMxxxx.1312A-0

12.1.2 8BCMxxxx.1523A-0

Construction



Pos.	pieces	Name	Note
1	1	Motor lines	4 x 10 mm ² + 2 x 2 x 1.5 mm ²
2	1	Circular plug, 8-pin socket	CSTA 264 NN00 44 0020 000
3	1	Heat shrink tubing	
4	8	Wire tip sleeve	
5	1	Cable clamps	
6	1	Shield plate	

Table 303: Construction - Motor cable 8BCMxxxx.1523A-0

Pin assignments

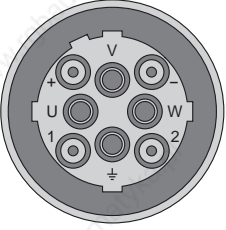
Circular plug	Pin	Name	Function
	U	U	Motor connection U
	V	V	Motor connection V
	W	W	Motor connection W
	⊥	PE	Protective ground conductor
	1	T+	Temperature +
	2	T-	Temperature -
	+	B+	Brake +
	-	B-	Brake -

Table 304: Pin assignments - Motor cable 8BCMxxxx.1523A-0

Cable schematic

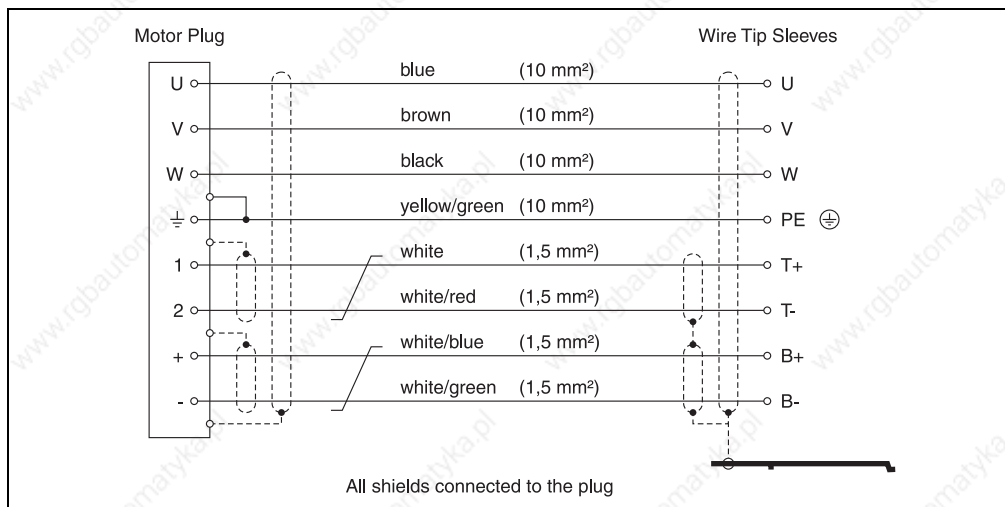
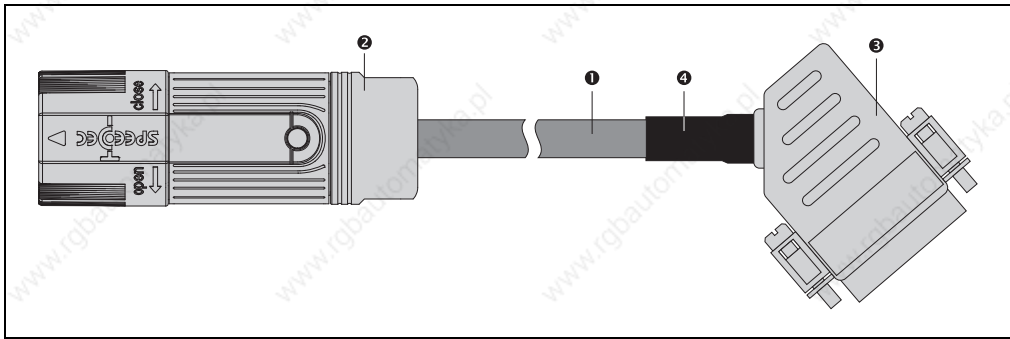


Figure 182: Cable schematic - Motor cable 8BCMxxxx.1523A-0

12.2 8BCE EnDat cable

12.2.1 Construction



Pos.	pieces	Name	Note
1	1	Encoder cable	10 x 0.14 mm ² + 2 x 0.50 mm ²
2	1	Circular plug, 17-pin socket	ASTA 035 NN00 41 0100 000
3	1	DSUB housing 45°, metal plated, 15-pin plug	
4	1	Heat shrink tubing	

Table 305: Construction - 8BCE EnDat cable

12.2.2 Pin assignments

Circular plug	Pin	Name	Function	Pin	DSUB plug
	15	A	Channel A	1	
	10	COM (1, 3 - 9, 11, 13 - 15)	Encoder supply 0 V	2	
	12	B	Channel B	3	
	7	+5V out / 0.25A	Encoder supply +5 V	4	
	14	D	Data input	5	
	8	T	Clock output	8	
	16	A\	Channel A inverted	9	
	4	Sense COM	Sense input 0 V	10	
	13	B\	Channel B inverted	11	
	1	Sense +5V	Sense input +5 V	12	
	17	D\	Data inverted	13	
	9	T\	Clock output inverted	15	

Table 306: Pin assignments - 8BCE EnDat cable

12.2.3 Cable schematic

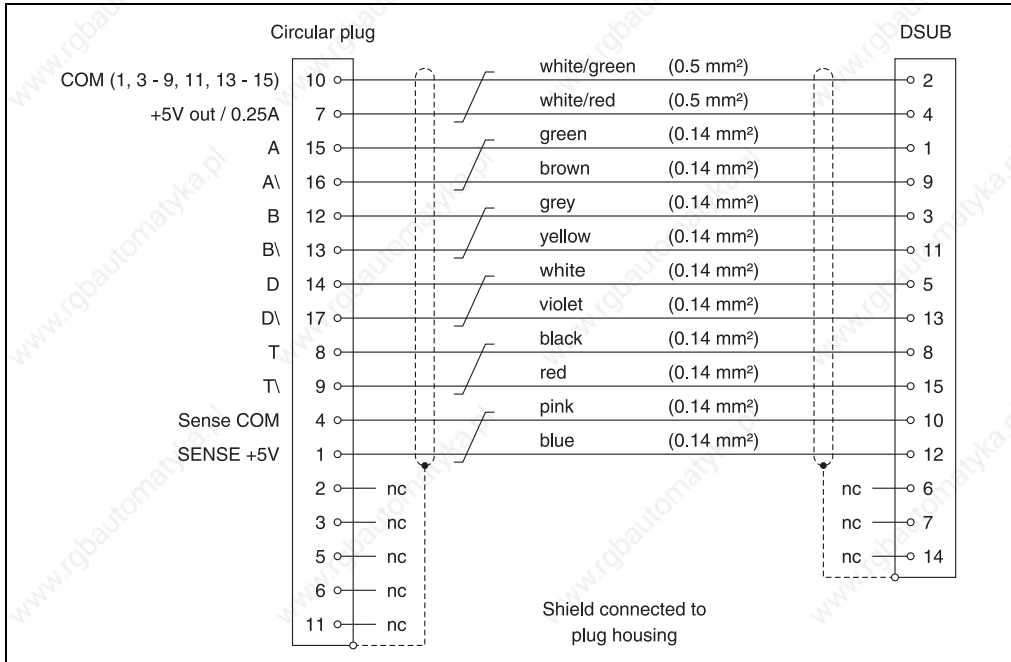
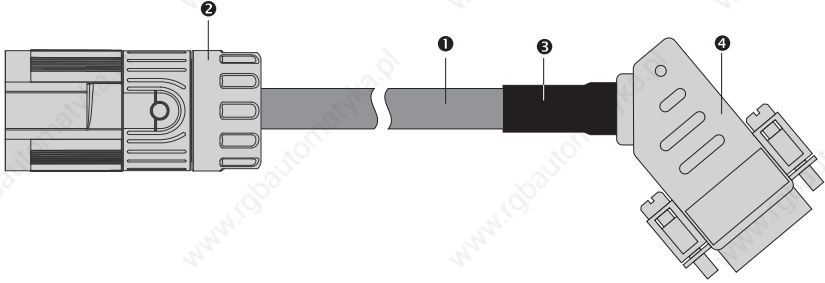


Figure 183: Cable schematic - 8BCE EnDat cable

12.3 8BCF EnDat 2.2 cable

12.3.1 Construction



Pos.	pieces	Name	Note
1	1	Encoder cable	1 x 4 x 0.14 mm ² + 2 x 0.34 mm ²
2	1	Circular plug, 12-pin socket	ESTB 002 NN00 10 0001 000
3	1	DSUB housing 45°, metal plated, 9-pin plug	
4	1	Heat shrink tubing	

Table 307: Construction - 8BCF EnDat 2.2 cable

12.3.2 Pin assignments

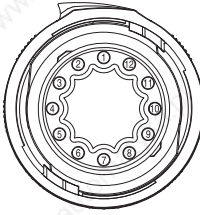
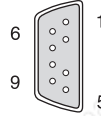
Circular plug	Pin	Name	Function	Pin	DSUB plug
	1	U+	Encoder supply +12.5 V	1	
	2	D	Data input	4	
	3	D\	Data input inverted	8	
	4	T	Clock output	5	
	5	T\	Clock output inverted	9	
	6	COM (2)	Battery supply 0 V	7	
	7	COM (1)	Encoder supply 0 V	6	
	8	---			
	9	---			
	10	---			
	11	---			
	12	VBATT	Battery supply	2	

Table 308: Pin assignments - 8BCF EnDat 2.2 cable

12.3.3 Cable schematic

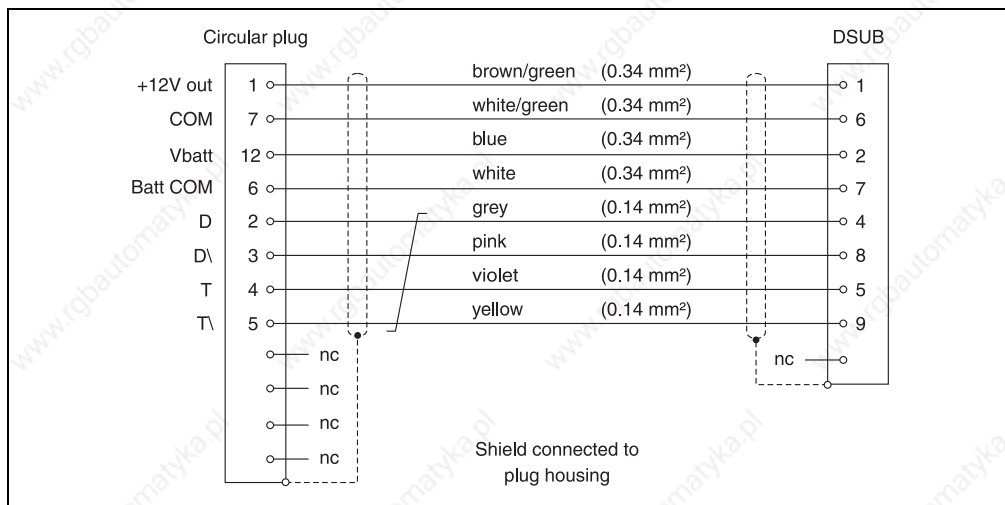
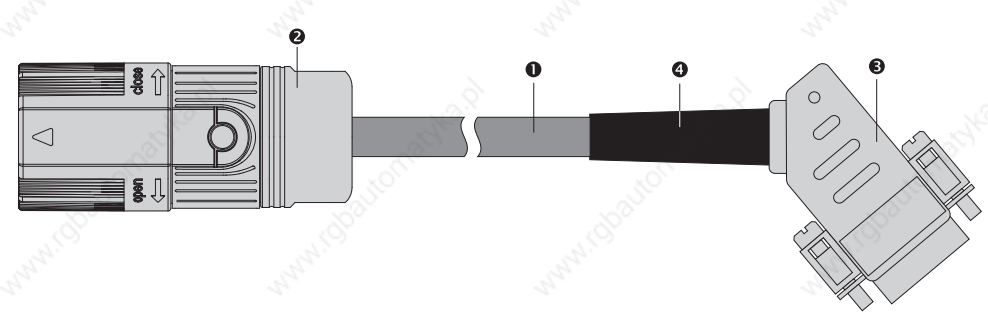


Figure 184: Cable schematic - 8BCF EnDat 2.2 cable

12.4 8BCR resolver cables

12.4.1 Construction



Pos.	pieces	Name	Note
1	1	Encoder cable	3 x 2 x 24 AWG/19
2	1	Circular plug, 12-pin socket	ASTA 021 FR 11 10 0035 000
3	1	DSUB housing 45°, metal plated, 9-pin plug	
4	1	Heat shrink tubing	

Table 309: Construction - 8BCR resolver cables

12.4.2 Pin assignments

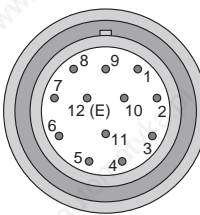
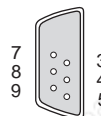
Circular plug	Pin	Name	Function	Pin	DSUB plug
	1	---			
	2	---			
	3	S4	Sine input +	3	
	4	S1	Cosine input -	4	
	5	R2	Reference output +	5	
	6	---			
	7	S2	Sine input -	7	
	8	S3	Cosine input +	8	
	9	R1	Reference output -	9	
	10	---			
	11	---			
	12	---			

Table 310: Pin assignments - 8BCR resolver cables

12.4.3 Cable schematic

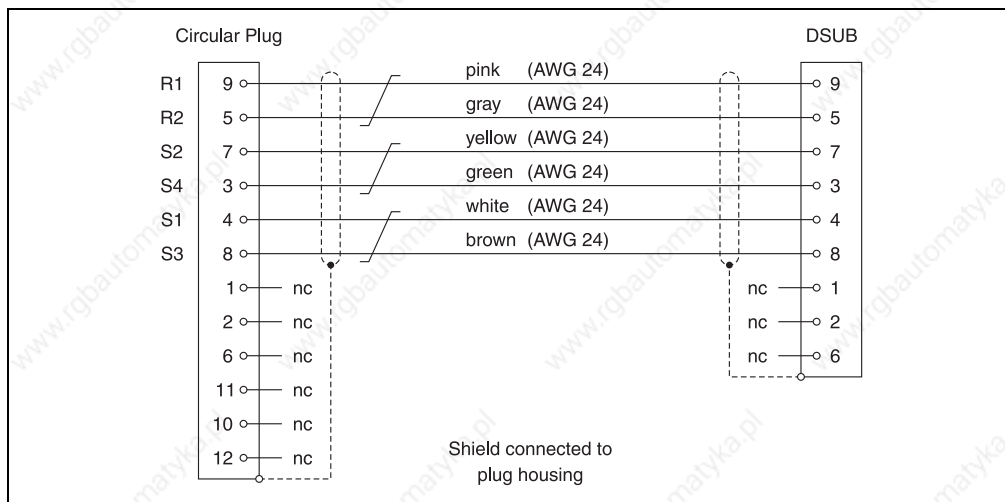
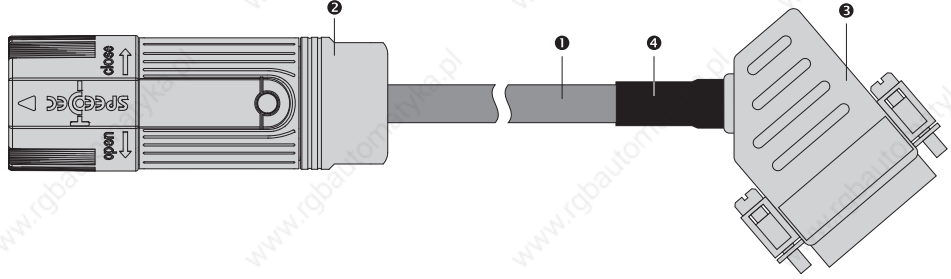


Figure 185: Cable schematic - 8BCR resolver cables

12.5 8BCS SinCos cables

12.5.1 Construction



Pos.	pieces	Name	Note
1	1	Encoder cable	10 x 0.14 mm ² + 2 x 0.50 mm ²
2	1	Circular plug, 12-pin socket	ASTA 021 NN00 41 0100 000
3	1	DSUB housing 45°, metal plated, 15-pin plug	
4	1	Heat shrink tubing	

Table 311: Construction - 8BCS SinCos cable

12.5.2 Pin assignments

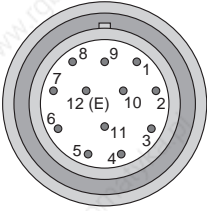
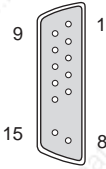
Circular plug	Pin	Name	Function	Pin	DSUB plug
	5	A	Channel A	1	
	10	COM	Encoder supply 0 V	2	
	8	B	Channel B	3	
	12	+5V out / 0.3A	Encoder supply +5 V	4	
	4	R\	Reference pulse inverted	7	
	6	A\	Channel A inverted	9	
	11	Sense COM	Sense input 0 V	10	
	1	B\	Channel B inverted	11	
	2	Sense +5V	Sense input +5 V	12	
	3	R	Reference pulse	14	

Table 312: Pin assignments - 8BCS SinCos cable

12.5.3 Cable schematic

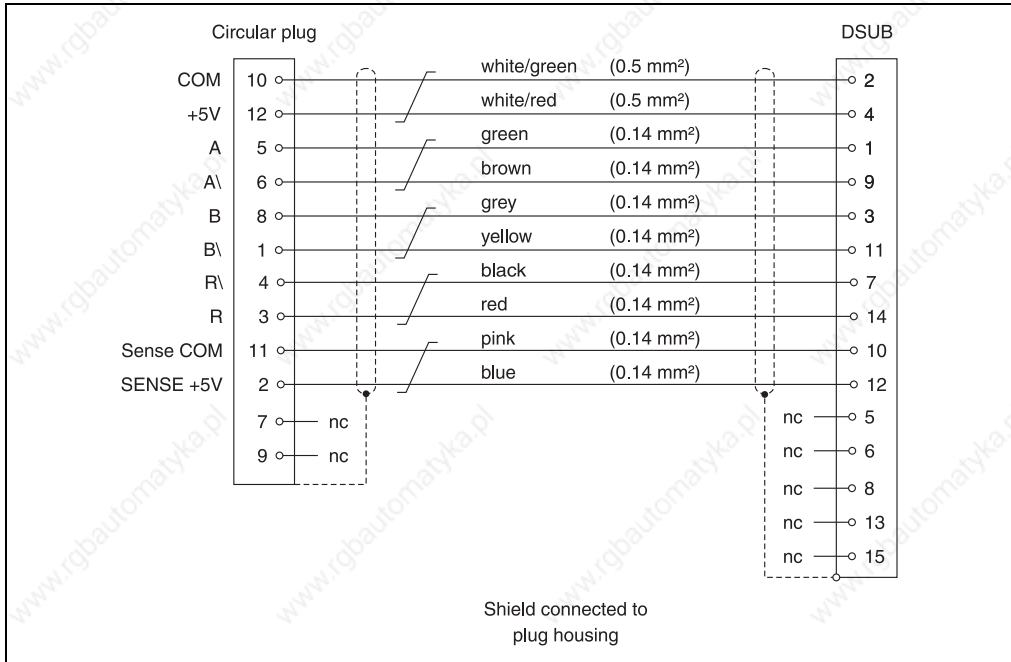


Figure 186: Cable schematic - 8BCS SinCos cable

12.6 8BCA expansion cable

12.6.1 Construction

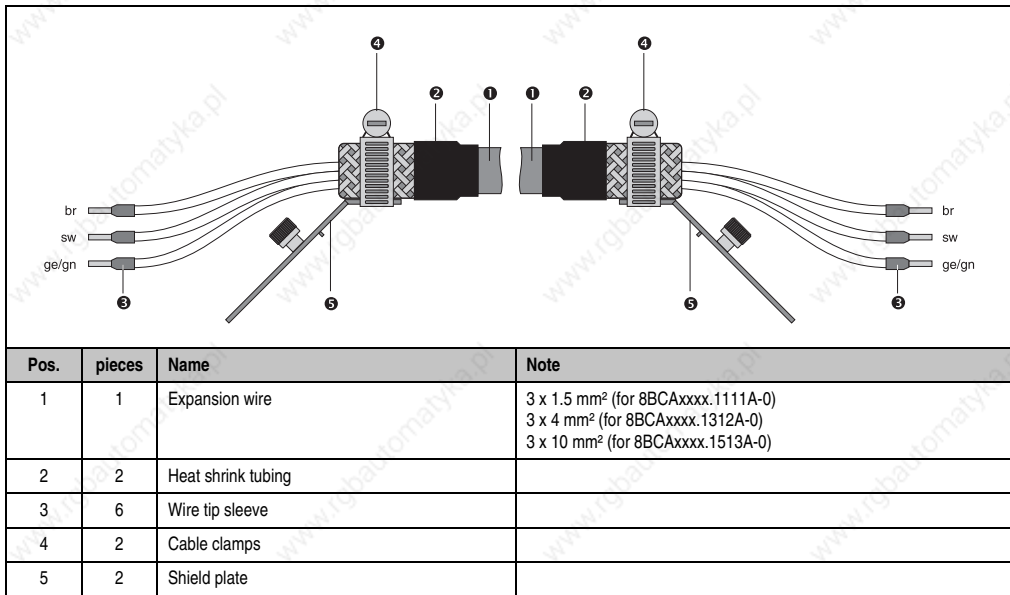


Table 313: Construction - 8BCA expansion cable

12.6.2 Cable schematic

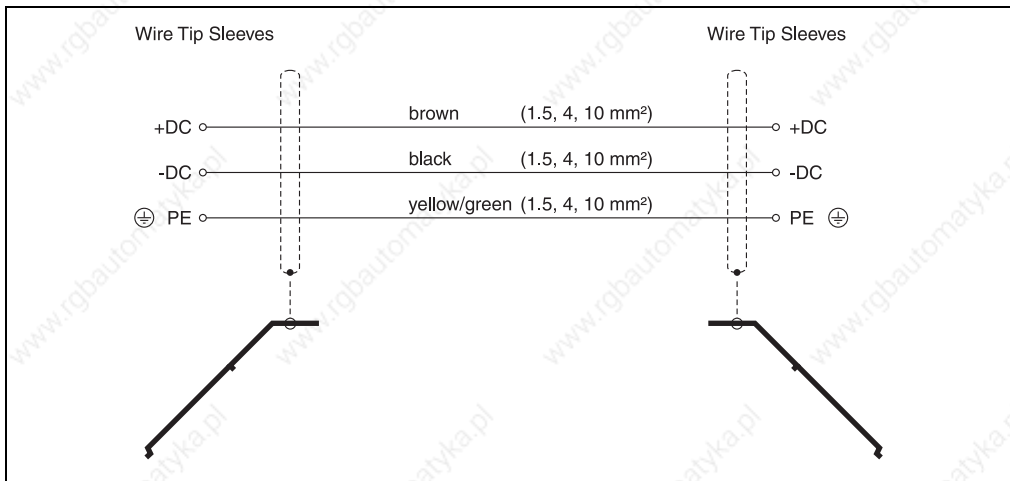


Figure 187: Cable schematic - 8BCA expansion cable

13. Fan modules

13.1 8B0M0040HFF0.000-1

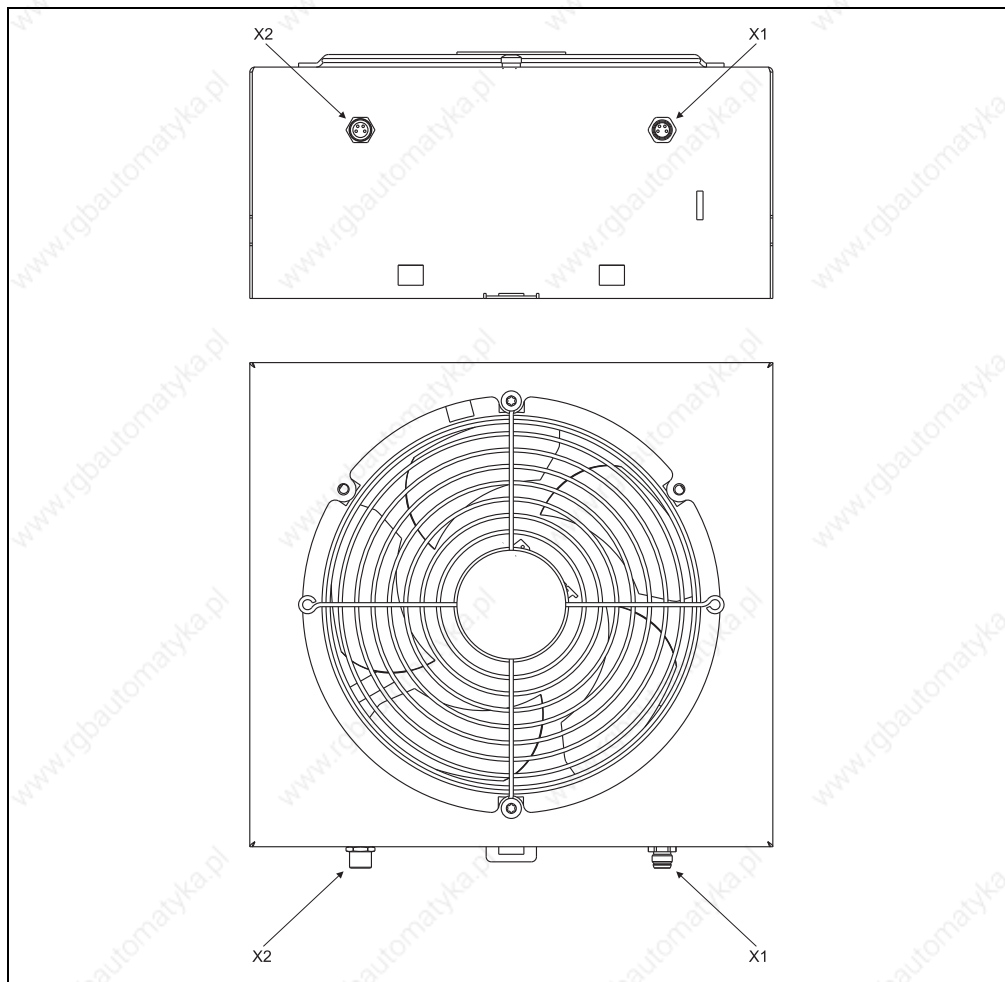


Figure 188: Overview of pin assignments - 8B0M0040HFF0.000-1

13.1.1 Pin assignments - X1 plug

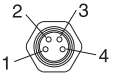
X1	Pin	Name	Function
	1	24V	Fan supply +24 VDC
	2	24V	Fan supply +24 VDC
	3	GND	Fan supply GND
	4	GND	Fan supply GND

Table 314: Pin assignments - X1 plug 8B0M0040HFF0.000-1

13.1.2 Pin assignments - X2 plug

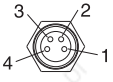
X2	Pin	Name	Function
	1	24V	Fan supply +24 VDC
	2	24V	Fan supply +24 VDC
	3	GND	Fan supply GND
	4	GND	Fan supply GND

Table 315: Pin assignments - X2 8B0M0040HFF0.000-1

Chapter 6 • Safety technology

1. Standard safety technology ("Wired safety technology")

Danger!

Especially in the area of safety technology, always consult the latest version of the User's Manual on the B&R homepage (www.br-automation.com) for the valid specifications. Specifications in previous versions are not necessarily up-to-date. Users should verify the correctness of the data before implementing any safety functions.

1.1 General information

ACOPOSmulti inverter modules use integrated safe pulse disabling for safe shutdown and to prevent unwanted startup. This is designed to meet the following safety classifications depending on the external circuit: ¹⁾

Criteria	Characteristic value depending on module width ¹⁾			
	1	2	4	8
Maximum safety category according to EN ISO 13849 or EN 954-1 ²⁾	KAT 4			
Maximum performance level acc. EN ISO 13849	PL e			
Maximum safety integrity level acc. IEC 62061	SIL 3			
Maximum safety integrity level acc. IEC 61508	SIL 3			
PFH (Probability of dangerous Failure per Hour)	$< 6 * 10^{-11}$	$< 8 * 10^{-11}$	$< 2 * 10^{-10}$	$< 4 * 10^{-10}$
FD (Probability of dangerous Failure on demand) dependent on the Proof Test interval (PT) with a PT of 10 years with a PT of 20 years	$< 5 * 10^{-6}$ $< 1 * 10^{-5}$	$< 7 * 10^{-6}$ $< 2 * 10^{-5}$	$< 1 * 10^{-5}$ $< 2 * 10^{-5}$	$< 4 * 10^{-5}$ $< 7 * 10^{-5}$
PT (Proof Test Interval) ³⁾	Max. 20 years			
DC (Diagnostic Coverage)	99 %			
MTTFd (Mean Time To Failure dangerous) ⁴⁾	2500 years			

Table 316: Safety classifications, criteria and characteristics for safe pulse disabling

1) ACOPOSmulti inverter modules have different module widths according to their performance class. Different components and/or switching elements are used depending on the performance class / module width, which has a direct effect on the characteristics of the safe pulse disabling. The module width is listed in the technical data for the respective ACOPOSmulti inverter module.

2) EN 954-1 is no longer valid and has been replaced by EN ISO 13849.

3) Corresponds to the service life of the module.

4) Values established by Apfeld, R.; Bömer, T.; Hauke, M.; Huelke, M.; Schaefer, M.: Practical experience with DIN EN ISO 13849-1. openautomation (2009) No. 6, p. 34-37 (www.dguv.de/ifa/de/pub/gri/pdf/2009_249.pdf).

1) A detailed explanation of the standards and safety functions can be found in chapter 7, "Standards and Certifications".

Safety technology • Standard safety technology ("Wired safety technology")

The following table provides an overview of the individual safety functions that can be implemented:

Label according to standard		Short description
EN 61800-5-2	EN 60204-1	
STO (Safe Torque Off)	Stop Category 0	Power supply cut off
SS1 (Safe Stop 1)	Stop Category 1	Introduction of active braking and activation of the STO function after a defined amount of time has expired
SS2 (Safe Stop 2)	Stop Category 2	Introduction of active braking and activation of the SOS function after a defined amount of time has expired
SLS (Safely Limited Speed)	---	Protection against exceeding a defined limit speed
SOS (Safe Operating Stop)	---	Protection against impermissible position deviation

Table 317: Overview of safety functions according to standard

Safe pulse disabling interrupts the supply to the motor by preventing the pulses to the IGBTs over two channels. In this way, a rotating field can no longer be created in synchronous and induction motors controlled by the ACOPOSmulti inverter modules.

Therefore, integrated safe pulse disabling meets the requirements for preventing unwanted startup in accordance to EN 1037 as well as the requirements in regard to Category 0 and 1 stop functions in accordance with EN 60204-1. Both stop functions require the supply to the machine drives to be switched off (immediately for Category 0 and after reaching standstill for Category 1). The requirements in regard to the safety functions STO, SS1, SS2, SLS and SOS are also met in accordance to EN 61800-5-2.

Subsequently, the nomenclature of EN 61800-5-2 (STO, SS1, SS2, SLS, SOS) will always be taken into consideration.

1.2 Principle - Implementing the safety function

Secure pulse disabling is obtained by removing the IGBT driver supply in the ACOPOSmulti inverter modules. Terminals X1 / Enable1 and X1 / COM (1) as well as X1 / Enable 2 and X1 / COM (3) are used to supply two integrated DC-DC converters with 24 VDC. The two DC-DC converters create the supply voltage for the IGBT driver from this voltage.

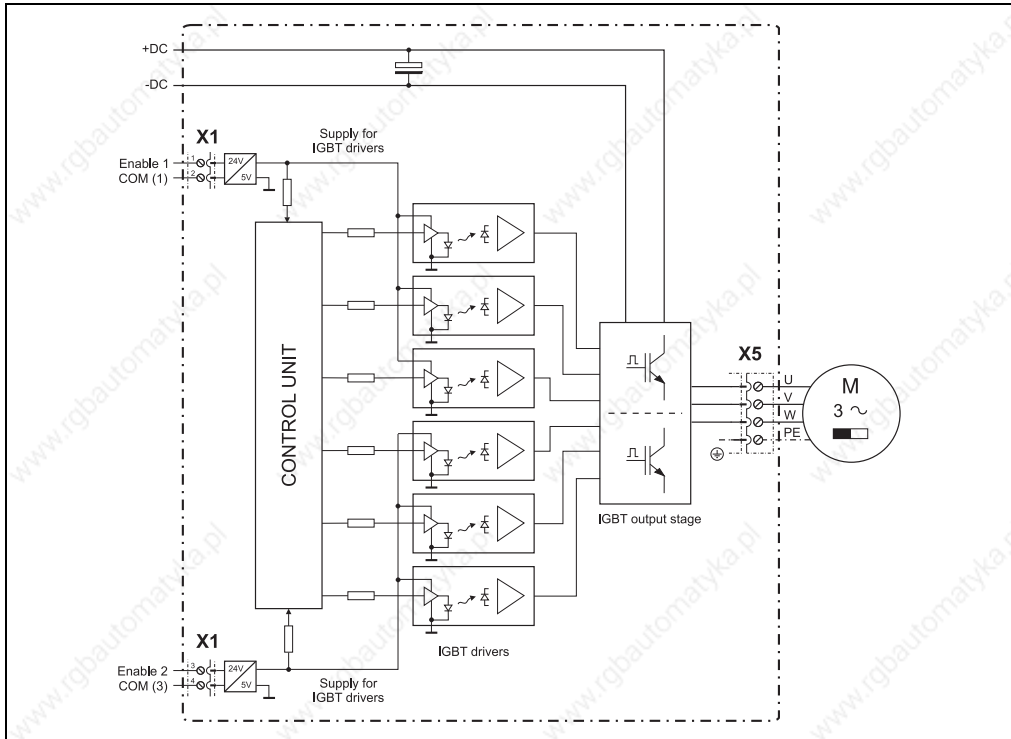


Figure 189: Block diagram of secure pulse disabling

If the 24 VDC voltage supply for one of the DC-DC converters is interrupted, the corresponding IGBT driver is also no longer supplied. It is then no longer possible to transfer the modulation pattern needed to generate the rotating field on the IGBT output stage. The supply of power to the motor is cut off.

1.2.1 Additional function

The control unit makes a query to check if the output voltage of the two DC-DC converters is present. If voltage is not present on the output of one of the two DC-DC converters, then generation of the modulation pattern is suppressed by the control unit.

Danger!

After activating safe pulse disabling using terminals X1 / Enable 1 and X1 / COM (1) or X1 / Enable 2 and X1 / COM (3), the motor is de-energized and therefore torque-free. If the motor was moving before activation of safe pulse disabling, it is only stopped by a safe operational brake (available under certain conditions) or from the friction of the entire system. Therefore, the motor is not able to hold hanging loads. Secure holding brakes must be used for this purpose.

Danger!

Keep in mind the turn-off times for the enable inputs, since this has a considerable effect on the response time of the safety functions and therefore the remaining distances and times. In order to calculate the total safety response time, the user must validate the lag-time over the entire system.

The turn-off times for the enable inputs can be found in the technical data for the respective ACOPOSmulti inverter module.

Danger!

Activation of safe pulse disabling via the terminals X1 / Enable1 and X1 / COM (1) or X1 / Enable 2 and X1 / COM (3) is not sufficient for achieving a voltage-free drive and therefore does not provide sufficient protection against electrical shock!

Danger!

Depending on the application, it is possible for the drive to startup again after deactivating safe pulse disabling.

Danger!

The brake controller integrated in the ACOPOS servo drives and the holding brake integrated in the B&R standard motors are sufficient for the maximum category B in accordance to EN ISO 13849-1.

Additional measures must be taken to achieve higher safety categories.

Danger!

The respective C-standards for the applications must be adhered to!

Information:

Take note that multiple errors in the IGBT bridge can cause a short forward movement. The maximum rotary angle φ of the forward movement on the motor shaft depends on the motor used. For permanently excited synchronous motors, $\varphi = 360^\circ/2p$ (for B&R standard motors, $p = 3$ and the angle is therefore 60°). For three-phase asynchronous motors, there is a relatively small angle of rotation (between 5° and 15°).

This short forward movement can be ruled out as error according to EN 954-1, chapter 7.2 among other things, due to the improbability that this would occur and due to general technical experience.

1.3 Enable input circuit in accordance with the required Safety Category / SIL / PL

In the example of the STO safety function, different circuit variations for the Enable input on ACOPOSmulti inverter modules are displayed according to the required Safety Category / SIL / PL.

Danger!

All errors (e.g. cross circuit) that are not detected can lead to a loss of safety functioning.

Suitable measures that justify a faulty connection for the error must be taken. In accordance with EN ISO 13849-2, appendix D.5, errors caused by short-circuit between any two conductors that are

- permanently wired and protected against external damage, e.g. via cable duct, armored conduit, or
- in different sheathed cables, or
- within an area for electrical equipment ¹⁾, or
- which are each individually protected via ground connection

can be ruled out. ²⁾

To achieve Safety Category 4 / SIL 3 / PL e, it must be ensured that a buildup of errors does not lead to a loss of safety functioning. Monitoring can be aborted after the third error if the likelihood that more errors will occur can be considered low.

To achieve Safety Category 3 / SIL 2 / PL d, it must be ensured that a single error does not lead to a loss of safety functioning.

1) This requires that the lines as well as the area for electrical equipment meet the respective requirements (see IEC 60204-1).

2) For more exclusions of errors, see EN ISO 13849-2, appendix D.5.

1.3.1 STO, Category 4 / SIL 3 / PL e (Variant A)

An Enable input on the ACOPOSmulti inverter module is supplied with +24 V via a switching contact of a safe E-stop switching device. The COM of the second Enable input on the ACOPOSmulti inverter module is supplied with 0 V via an additional switching contact of a safe E-stop switching device. When the S1 E-stop button is pressed, both switching contacts on the E-stop switching device are opened and the Enable input as well as the COM of the second Enable input are separated.

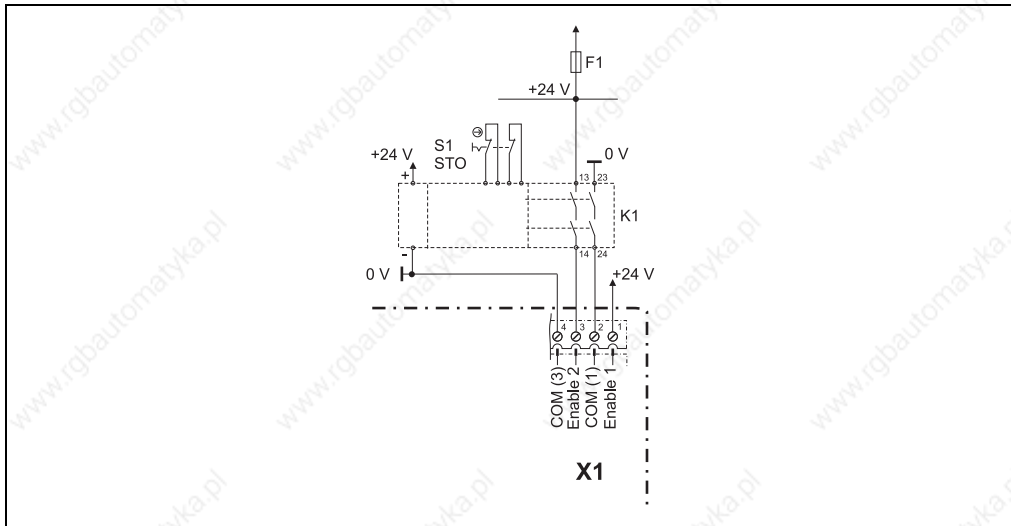


Figure 190: STO, Category 4 / SIL 3 / PL e (Variant A)

This circuit covers a majority of the wiring and isolation errors in the area of supply lines to the E-stop switching device and to the Enable inputs.

The following errors can occur in the external circuit: ¹⁾

Error	Error description	Effect	Safety function according to Category 4 / SIL 3 / PL e remains?
1	Interruption of the supply line to connection 13	Energy to the motor is cut off	Yes
2	Interruption of the supply line to connection 23	Energy to the motor is cut off	Yes
3	Short-circuit between connection 13 and 23	F1 fuse triggered immediately	Yes
4	Short-circuit between connection 13 and 0 V	F1 fuse triggered immediately	Yes

Table 318: List of possible errors

¹⁾ The connection numbers refer to the image 190 "STO, Category 4 / SIL 3 / PL e (Variant A)".

Error	Error description	Effect	Safety function according to Category 4 / SIL 3 / PL e remains?
5	Short-circuit between connection 23 and +24 V	F1 fuse triggered immediately	Yes
6	Short-circuit between connection 13 and 24	F1 fuse triggered by request from the safety function	Yes
7	Short-circuit between connection 23 and 14	F1 fuse triggered by request from the safety function	Yes
8	Short-circuit between connection 13 and 14	Unknown error	No, safety function relapse to Category 3 / SIL 2 / PL d
9	Short-circuit between connection 23 and 24	Unknown error	No, safety function relapse to Category 3 / SIL 2 / PL d
10	Interruption of the supply line to connection 14	Energy to the motor is cut off	Yes
11	Interruption of the supply line to connection 24	Energy to the motor is cut off	Yes
12	Short-circuit between connection 14 and 0 V	F1 fuse triggered by request from the safety function	Yes
13	Short-circuit between connection 24 and +24 V	F1 fuse triggered by request from the safety function	Yes
14	Short-circuit between connection 14 and +24 V	Unknown error	No, safety function relapse to Category 3 / SIL 2 / PL d
15	Short-circuit between connection 24 and +0 V	Unknown error	No, safety function relapse to Category 3 / SIL 2 / PL d
16	Short-circuit between connection 14 and 24	F1 fuse triggered by request from the safety function	Yes

Table 318: List of possible errors (cont.)

Danger!

The S1 switch displayed requires the use of a two-pin switching device (Category 4 / SIL 3 / PL e) with a positive opening contact according to EN 60947-5-1.

A two-pin switching device (Category 4 / SIL 3 / PL e) must be used for the displayed K1 relay.

The instructions in the switching device's user documentation must be followed!

The following errors according to table 318 "List of possible errors" must be eliminated by taking sufficient measures for the wiring (protected against short-circuit):

- Error 8
- Error 9
- Error 14
- Error 15

1.3.2 STO, Category 4 / SIL 3 / PL e (Variant B)

The two Enable inputs on the ACOPOSmulti inverter module are supplied via a safe digital output (Out1+, Out1-). If the safety function is requested, then the safe digital output separates the two Enable inputs.

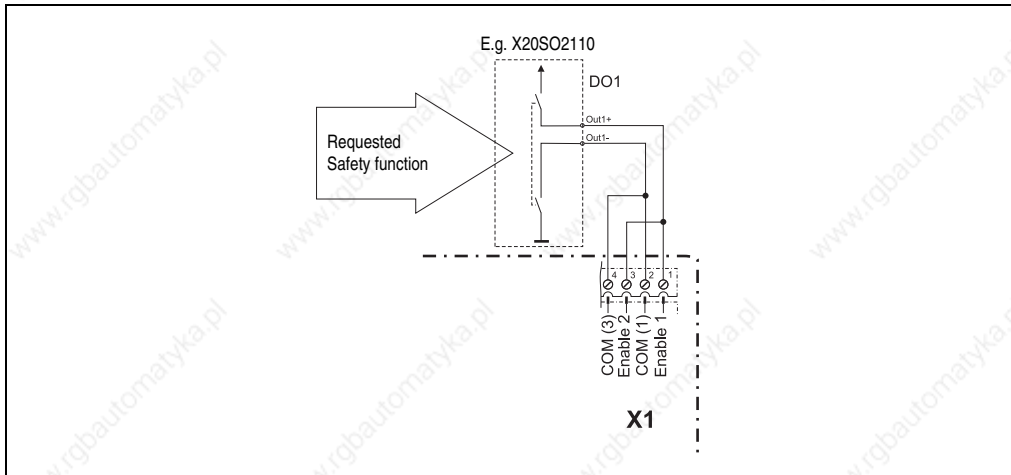


Figure 191: STO, Category 4 / SIL 3 / PL e (Variant B)

Errors in the external wiring do not have to be investigated because they are detected by the safe digital output.

Danger!

A safe digital output module with the Category 4 / SIL 3 / PL e must be used for the displayed DO1 digital output.

The instructions in the safe digital output module's user documentation must be followed!

1.3.3 STO, Category 3 / SIL 2 / PL d

By pressing an E-stop button, one or both Enable inputs on the ACOPOSmulti inverter module are separated by a switch from the +24 V supply, thereby cutting off the supply of power to the motor.

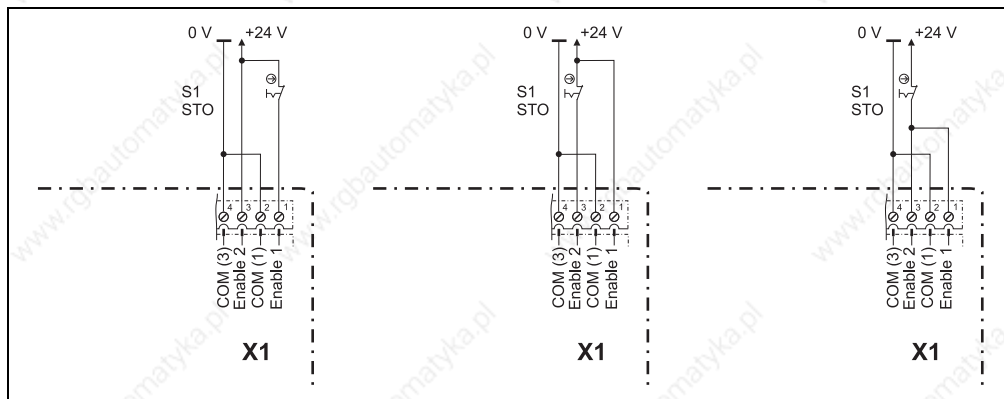


Figure 192: STO, Category 3 / SIL 2 / PL d

Danger!

If only one of the two enable inputs is isolated from the +24 V supply using a switch, suitable wiring measures must be taken to rule out a short-circuit between the connections X1 / Enable1 and X1 / Enable2 in order to guarantee the safety category!

Danger!

The S1 switch displayed requires the use of a one-pin switching device (Category 3 / SIL 2 / PL d) with a positive opening contact according to EN 60947-5-1.

The instructions in the switching device's user documentation must be followed!

1.4 Enable input circuits according to the required Safety Category / SIL / PL and functionality (STO, SS1, SS2, SLS, SOS)

The following illustrates exemplary wiring suggestions for the external circuit of the Enable inputs on ACOPOSmulti inverter modules. The examples vary by safety classification in accordance to EN 60204-1, ISO 13849 and EN 61800-5-2 and according to the safety function (STO, SS1, SS2, SLS, SOS).

Information:

The following wiring suggestions do not include a line contactor because it is not needed for compliance to the required Safety Category / SIL / PL.

1.4.1 STO, SLS, SOS - Safety Category 4 / SIL 3 / PL e

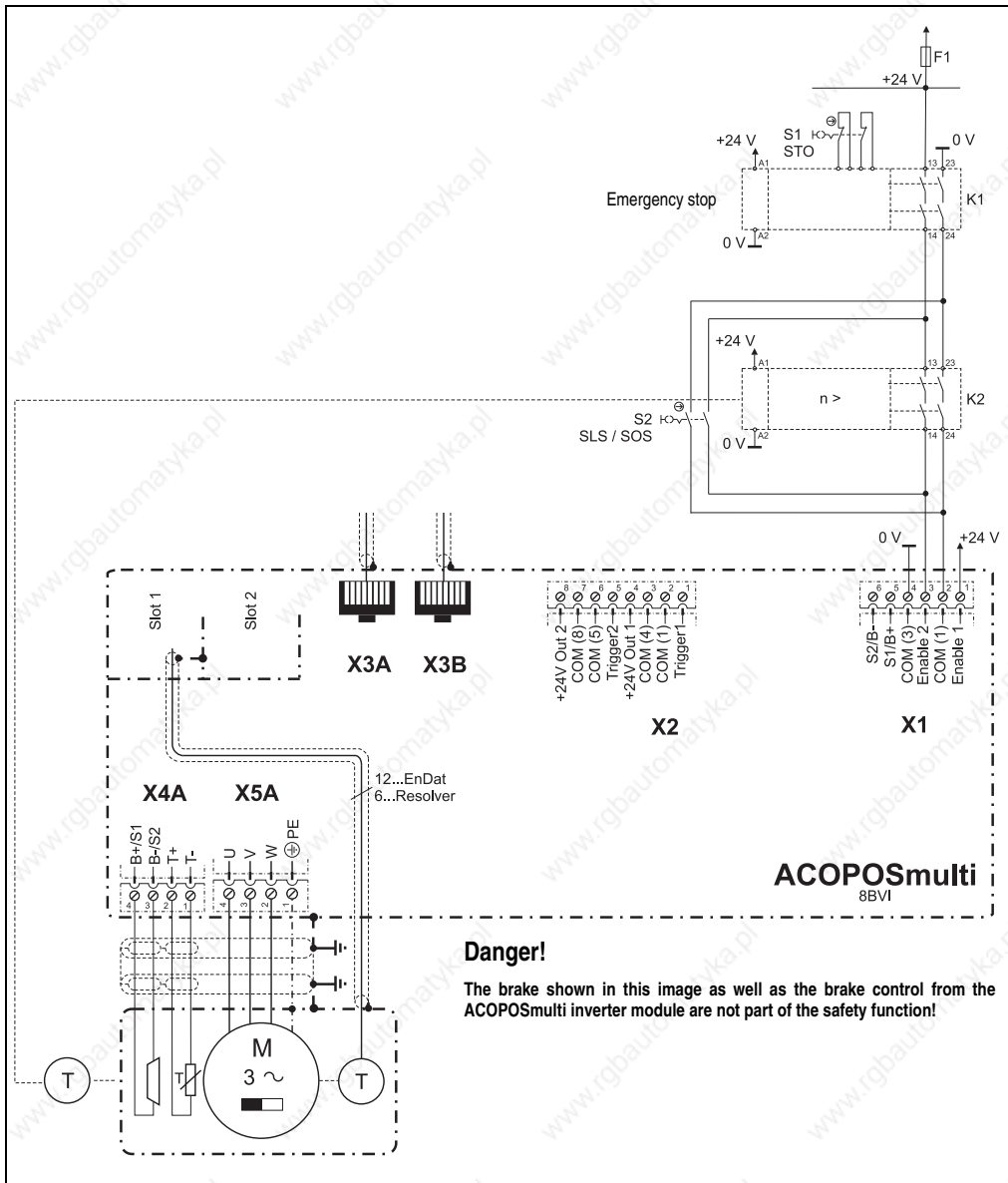


Figure 193: STO, SLS, SOS - Safety Category 4 / SIL 3 / PL e

Description

STO:

The switching contacts of the K1 E-stop switching device are released when the S1 E-stop button is pressed. Both Enable inputs on the ACOPOSmulti inverter module are separated. As a result, the supply of power to the motor is cut off.

This guarantees that the supply of power to the motor is immediately cut off.

Secure restart inhibit:

If you open and lock E-stop switch S1, unexpected startup is prevented.

SLS:

The SLS safety function is activated by opening the S2 switch. The switching contacts of the K2 rotation speed monitor are opened when the limit speed set on the rotation speed monitor is exceeded. Both Enable inputs on the ACOPOSmulti inverter module are separated. As a result, the supply of power to the motor is cut off.

This guarantees that the energy feed to the motor is immediately cut off when the limit speed set on the K2 rotation speed monitor is exceeded.

SOS:

The SOS safety function is activated by opening the S2 switch. The switching contacts of the K2 standstill monitor are opened when the standstill monitor is activated. Both Enable inputs on the ACOPOSmulti inverter module are separated. As a result, the supply of power to the motor is cut off.

This guarantees that the supply of power to the motor is immediately cut off when the K2 standstill monitor is activated.

Information about SLS and SOS:

The SLS safety function or the SOS safety function can be implemented depending on the function of the K2 switching device (rotation speed monitor or standstill monitor).

Danger!

The S1 and S2 switches displayed require the use of a two-pin switching device (Category 4 / SIL 3 / PL e) with a positive opening contact according to EN 60947-5-1. A two-pin E-stop switching device (Category 4 / SIL 3 / PL e) must be used for the displayed K1 and K2 relays.

The instructions in the switching device's user documentation must be followed!

1.4.2 SS1, SLS, SS2 - Safety Category 4 / SIL 3 / PL e (Variant A)

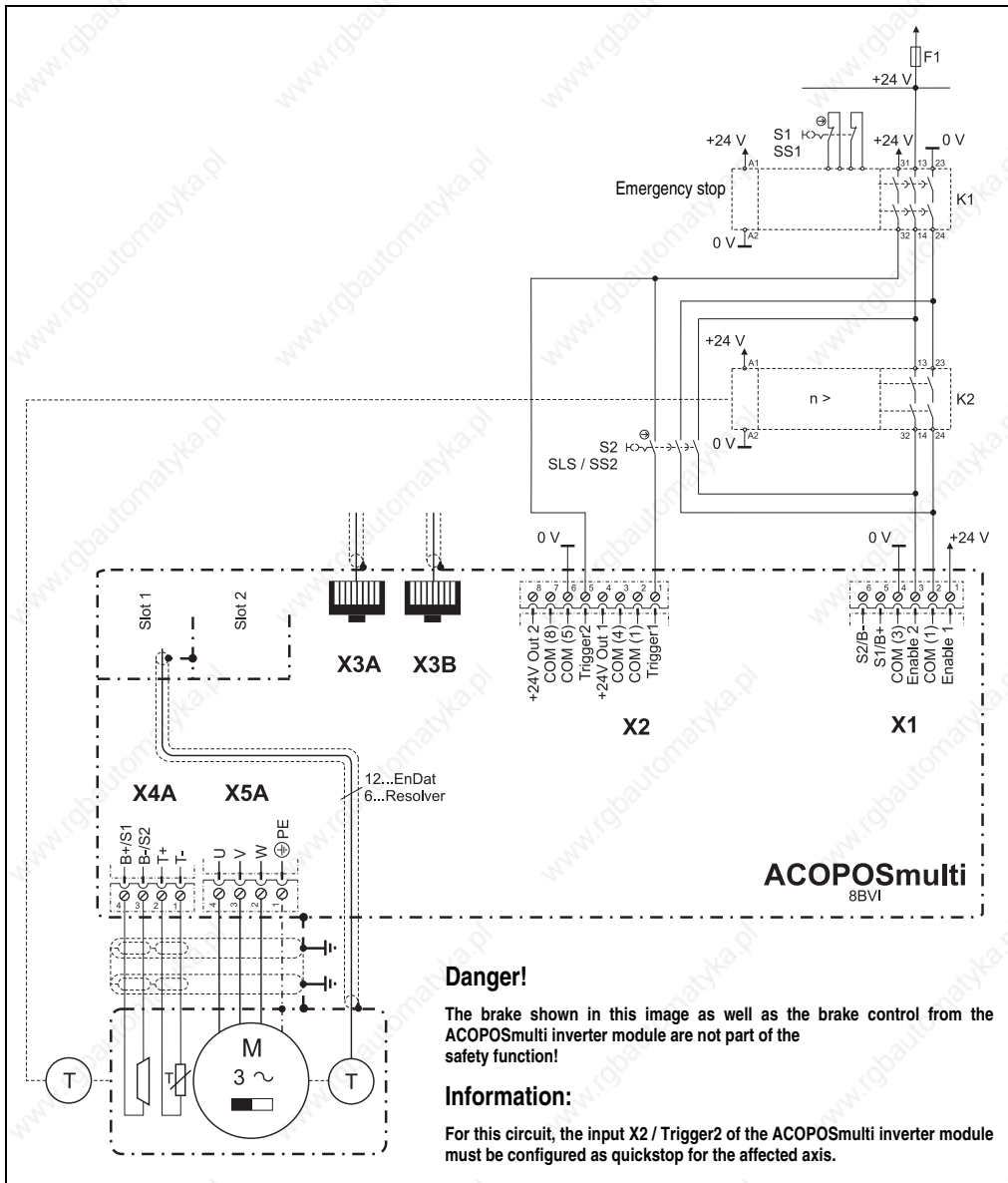


Figure 194: SS1, SLS, SS2 - Safety Category 4 / SIL 3 / PL e (Variant A)

Description

SS1:

When the S1 E-stop button is pressed, an active braking procedure is triggered via an immediate switching contact of the K1 E-stop switching device on the input X2 / Trigger2 of the ACOPOSmulti inverter module. The delayed switching contacts of the K1 E-stop switching device are released after a defined amount of time. Both Enable inputs on the ACOPOSmulti inverter module are separated. As a result, the supply of power to the motor is cut off.

This guarantees that the supply of power to the motor is cut off after a defined amount of time.

Secure restart inhibit:

If you open and lock E-stop switch S1, unexpected startup is prevented.

SLS:

Opening the switch S2 will activate the SLS safety function and trigger an active braking procedure on the input X2 / Trigger1 of the ACOPOSmulti inverter module. After a defined amount of time, speed monitoring will be activated on the speed monitor K2. If the limit speed is exceeded, then the enable inputs of the ACOPOSmulti inverter module are cleared via the immediate switching contacts of the speed monitor K2.

This guarantees that the supply of power to the motor is immediately cut off when the limit speed set on the rotation speed monitor K2 is exceeded.

SS2:

Opening the switch S2 will activate the SS2 safety function and trigger an active braking procedure on the input X2 / Trigger1 of the ACOPOSmulti inverter module. After a defined amount of time, standstill monitoring will be activated on the standstill monitor K2. If the tolerance limit is exceeded (standstill monitor K2 is activated), then the enable inputs of the ACOPOSmulti inverter module are cleared via the immediate switching contacts of the standstill monitor K2.

This guarantees that the supply of power to the motor is immediately cut off when the standstill monitor K2 is activated.

Information about SLS and SS2:

The SLS safety function or the SS2 safety function can be implemented depending on the function of the K2 switching device (rotation speed monitor or standstill monitor).

Danger!

The S1 and S2 switches displayed require the use of a two-pin switching device (Category 4 / SIL 3 / PL e) with a positive opening contact according to EN 60947-5-1. A two-pin E-stop switching device (Category 4 / SIL 3 / PL e) must be used for the displayed K1 and K2 relays.

The instructions in the switching device's user documentation must be followed!

1.4.3 SS1, SLS, SS2 - Safety Category 4 / SIL 3 / PL e (Variant B)

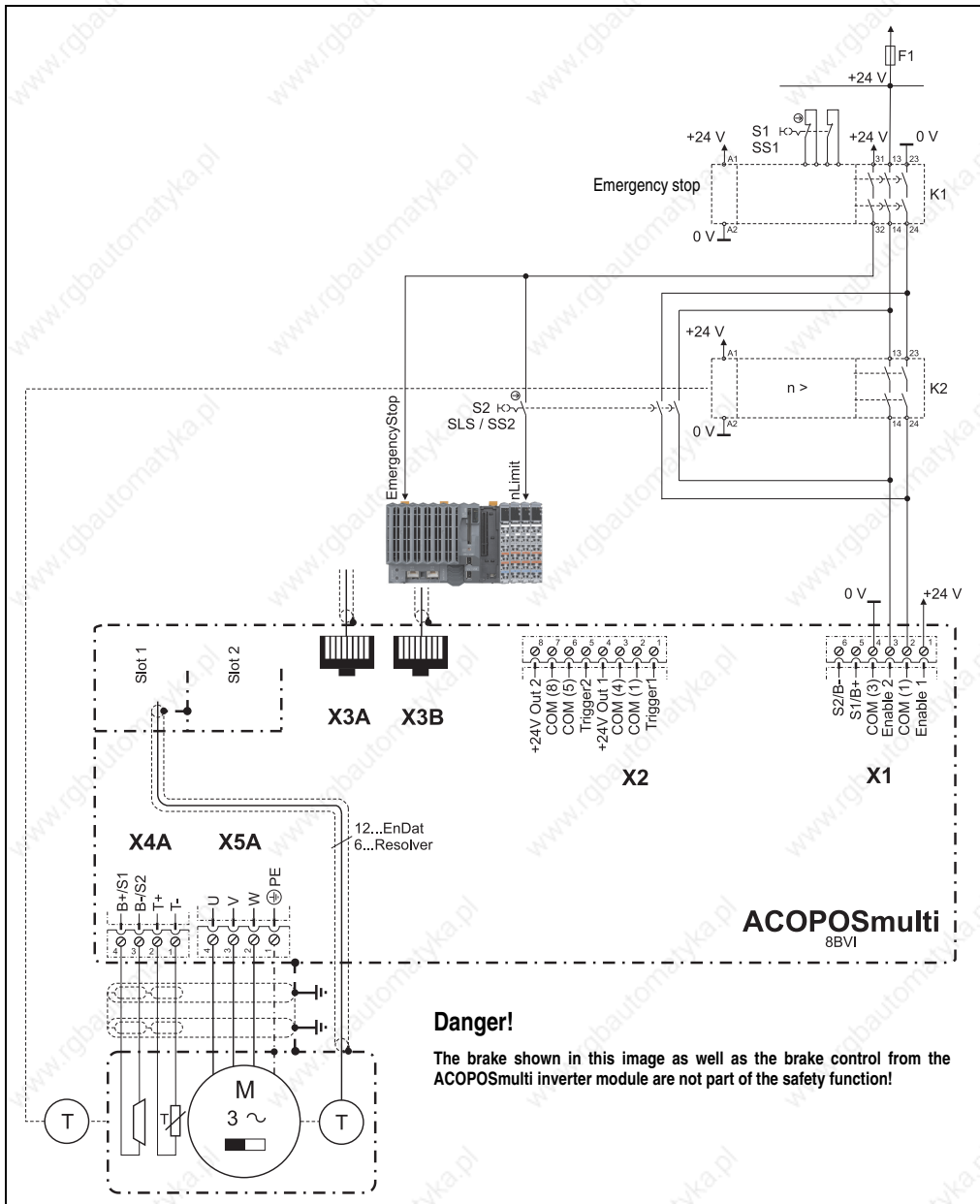


Figure 195: SS1, SLS, SS2 - Safety Category 4 / SIL 3 / PL e (Variant B)

Description

SS1:

After pressing the S1 E-stop button, an active braking procedure is triggered via the POWERLINK network via an immediate switching contact of the K1 E-stop switching device on the digital input "EmergencyStop" on the controller (see "Code example", on page 565). The delayed switching contacts of the K1 E-stop switching device are released after a defined amount of time. Both Enable inputs on the ACOPOSmulti inverter module are separated. As a result, the supply of power to the motor is cut off.

This guarantees that the supply of power to the motor is cut off after a defined amount of time.

Secure restart inhibit:

If you open and lock E-stop switch S1, unexpected startup is prevented.

SLS:

Opening the switch S2 will activate the safety function SLS and trigger an active braking procedure on the digital input "nLimit" on the controller via the POWERLINK network (see "Code example", on page 565). After a defined amount of time, speed monitoring will be activated on the speed monitor K2. If the limit speed is exceeded, then the enable inputs of the ACOPOSmulti inverter module are cleared via the immediate switching contacts of the speed monitor K2.

This guarantees that the supply of power to the motor is immediately cut off when the limit speed set on the rotation speed monitor K2 is exceeded.

SS2:

Opening the switch S2 will activate the safety function SS2 and trigger an active braking procedure on the digital input "nLimit" on the controller via the POWERLINK network (see "Code example", on page 565). After a defined amount of time, standstill monitoring will be activated on the standstill monitor K2. If the tolerance limit is exceeded (standstill monitor K2 is activated), then the enable inputs of the ACOPOSmulti inverter module are cleared via the immediate switching contacts of the standstill monitor K2.

This guarantees that the supply of power to the motor is immediately cut off when the standstill monitor K2 is activated.

Information:

The SLS safety function or the SS2 safety function can be implemented depending on the function of the K2 switching device (rotation speed monitor or standstill monitor).

Danger!

The S1 and S2 switches displayed require the use of a two-pin switching device (Category 4 / SIL 3 / PL e) with a positive opening contact according to EN 60947-5-1. A two-pin E-stop switching device (Category 4 / SIL 3 / PL e) must be used for the displayed K1 and K2 relays.

The instructions in the switching device's user documentation must be followed!

Code example

Placing the stop command via POWERLINK:

```

if ( ! stop_active )
{
  /* Movement stop not active: Test stop inputs */
  if ( EmergencyStop == ncLOW )
  {
    /* Activate movement stop with parameter set for "emergency stop" */
    stop_index = E_STOP_INDEX;
    step = MOV_STOP;
    stop_active = 1;
  }
  else if ( nLimit == ncLOW )
  {
    /* Activate movement stop with parameter set for "low
    speed" */
    stop_index = NLIMIT_INDEX;
    step = MOV_STOP;
    stop_active = 1;
  }
}
else
{
  /* Movement stop was activated */
  if ( EmergencyStop == ncHIGH && nLimit == ncHIGH
      && step!= W_MOVE_STOP)
  {
    /* Movement stop completed */
    stop_active = 0;
  }
}

```

```
switch (step)
{
    ...
    case MOV_STOP:
        /* Call NC action for movement stop */
        p_ax_dat->move.stop.index.command = stop_index;

        action_status = naction(ax_obj,ncMOVE,ncSTOP);
        if ( action_status == ncOK )
        {
            step = W_MOVE_STOP;
        }
        break;

    case W_MOVE_STOP:
        /* Wait for completion of movement stop */
        if (p_ax_dat->move.mode == ncOFF)
        {
            /* Movement stop completed */
            step = <NEXT_STEP>
        }
        break;
    ...
}
```

1.4.4 STO, SLS, SOS - Safety category 3 / SIL 2 / PL d

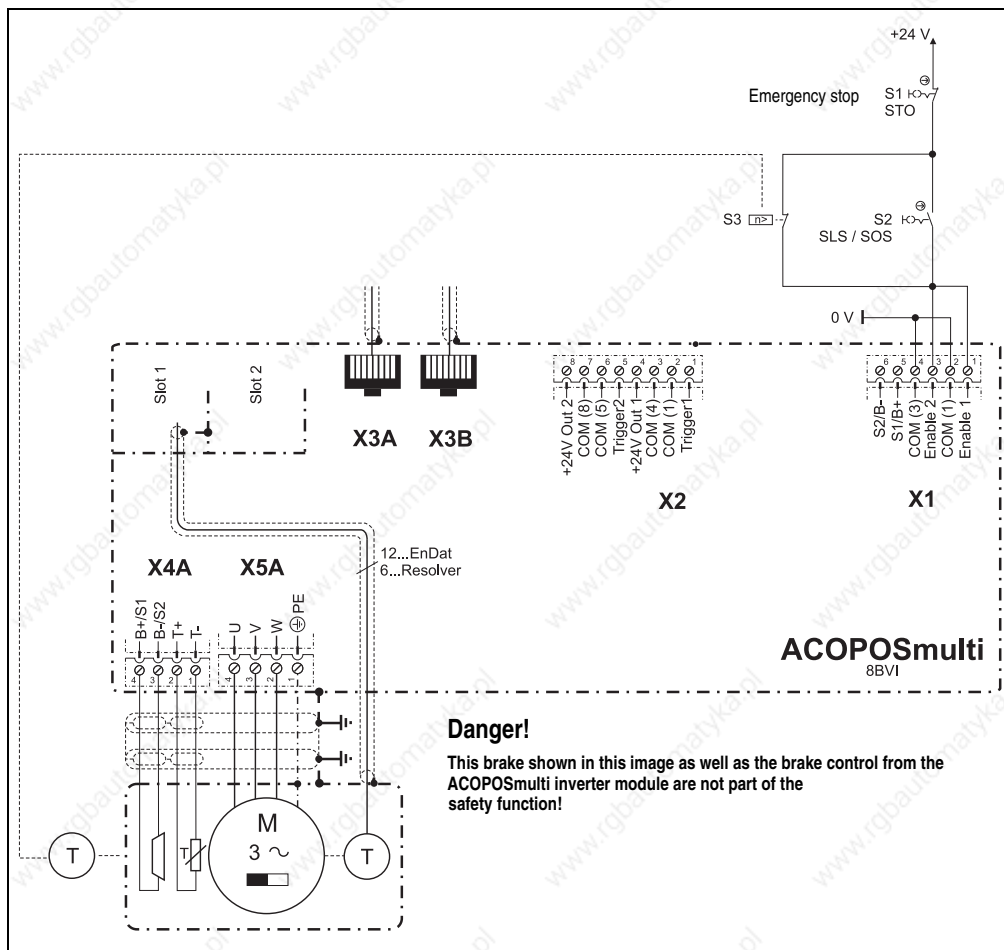


Figure 196: STO, SLS, SOS - Safety category 3 / SIL 2 / PL d

Description

STO:

Both Enable inputs on the ACOPOSmulti inverter module are separated by pressing the S1 E-stop button. As a result, the supply of power to the motor is cut off.

This guarantees that the supply of power to the motor is immediately cut off.

Secure restart inhibit:

If you open and lock E-stop switch S1, unexpected startup is prevented.

SLS:

The SLS safety function is activated by opening the S2 switch. The switching contact of the S3 rotation speed monitor is opened when the limit speed set on the rotation speed monitor is exceeded. Both Enable inputs on the ACOPOSmulti inverter module are separated. As a result, the supply of power to the motor is cut off.

This guarantees that the supply of power to the motor is immediately cut off when the limit speed set on the S3 rotation speed monitor is exceeded.

SOS:

The SOS safety function is activated by opening the S2 switch. The switching contact of the rotation speed monitor is opened when the S3 standstill monitor is activated. Both Enable inputs on the ACOPOSmulti inverter module are separated. As a result, the supply of power to the motor is cut off.

This guarantees that the supply of power to the motor is immediately cut off when the S3 standstill monitor is activated.

Information about SLS and SOS:

The SLS safety function or the SOS safety function can be implemented depending on the function of the S3 switching device (rotation speed monitor or standstill monitor).

Danger!

The S1 and S2 switches displayed require the use of a one-pin switching device (Category 3 / SIL 2 / PL d) with a positive opening contact according to EN 60947-5-1. A one-pin switching device (Category 3 / SIL 2 / PL d) must be used for the displayed S3 switching device.

The instructions in the switching device's user documentation must be followed!

1.4.5 SS1, SLS, SS2 - Safety Category 3 / SIL 2 / PL d (Variant A)

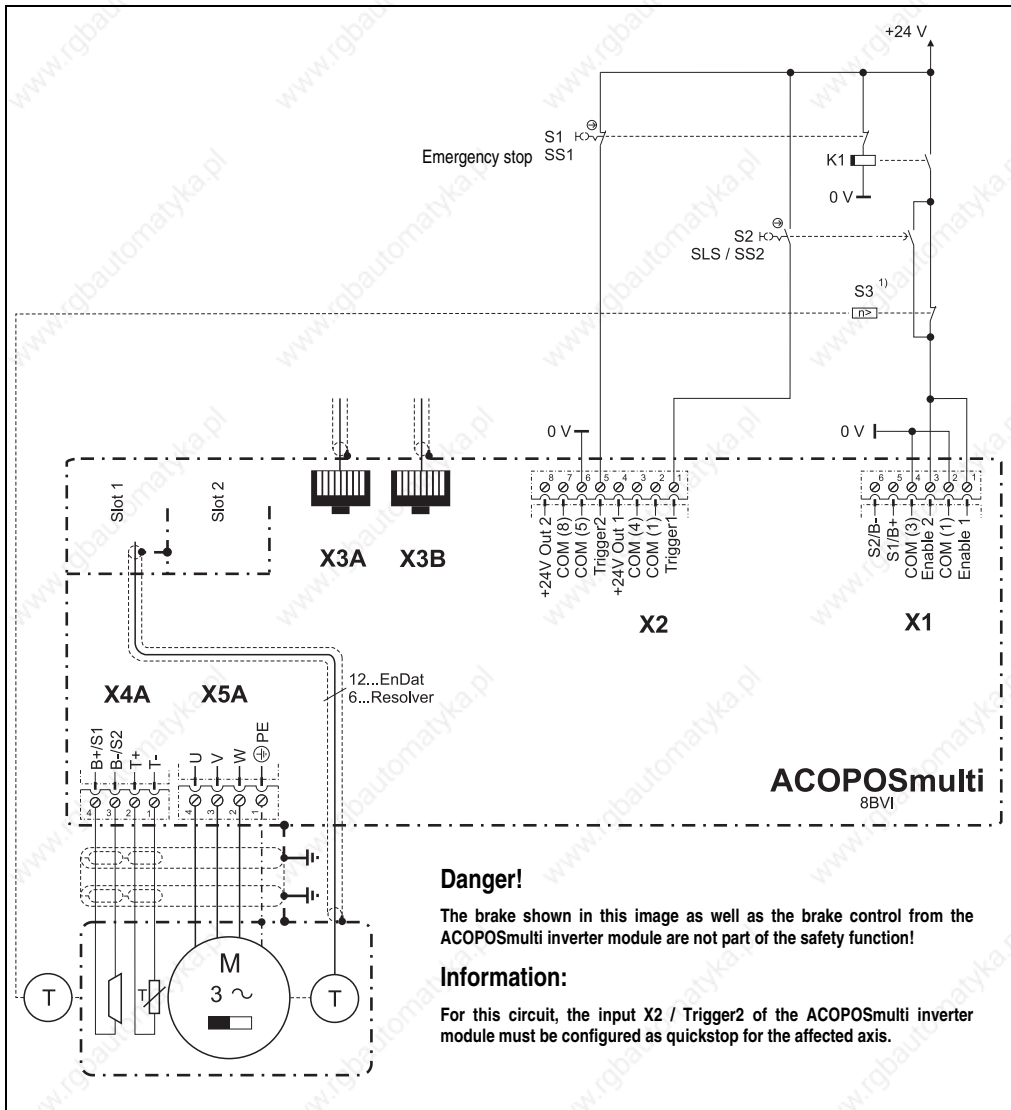


Figure 197: SS1, SLS, SS2 - Safety Category 3 / SIL 2 / PL d (Variant A)

Description

SS1:

Pressing e-stop switch S1 causes relay K2 to be released. As a result, an active braking procedure is triggered via the input X2 / Trigger2 of the ACOPOSmulti inverter module.

The K1 auxiliary relay with drop-out time is released after a defined amount of time. Both Enable inputs on the ACOPOSmulti inverter module are separated. As a result, the supply of power to the motor is cut off.

This guarantees that the supply of power to the motor is cut off after a defined amount of time.

Secure restart inhibit:

If you open and lock E-stop switch S1, unexpected startup is prevented.

SLS:

Opening the switch S2 will activate the SLS safety function and trigger an active braking procedure via the input X2 / Trigger1 of the ACOPOSmulti inverter module. After a defined amount of time, speed monitoring will be activated on the speed monitor S3. If the limit speed is exceeded, then the enable inputs of the ACOPOSmulti inverter module are cleared via the immediate switching contact of the speed monitor S3.

This guarantees that the supply of power to the motor is immediately cut off when the limit speed set on the rotation speed monitor S3 is exceeded.

SS2:

Opening the switch S2 will activate the SS2 safety function and trigger an active braking procedure via the input X2 / Trigger1 of the ACOPOSmulti inverter module. After a defined amount of time, standstill monitoring will be activated on the standstill monitor S3. If the tolerance limit is exceeded (standstill monitor S3 is activated), then the enable inputs of the ACOPOSmulti inverter module are cleared via the immediate switching contact of the standstill monitor S3.

This guarantees that the supply of power to the motor is immediately cut off when the standstill monitor S3 is activated.

Information about SLS and SS2:

The SLS safety function or the SS2 safety function can be implemented depending on the function of the S3 switching device (rotation speed monitor or standstill monitor).

Danger!

The S1 and S2 switches displayed require the use of a one-pin switching device (Category 3 / SIL 2 / PL d) with a positive opening contact according to EN 60947-5-1. A oneSafety Category switching device (Category 3 / SIL 2 / PL d) must be used for the displayed K1 relay and the S3 switching device.

The instructions in the switching device's user documentation must be followed!

1.4.6 SS1, SLS, SS2 - Safety Category 3 / SIL 2 / PL d (Variant B)

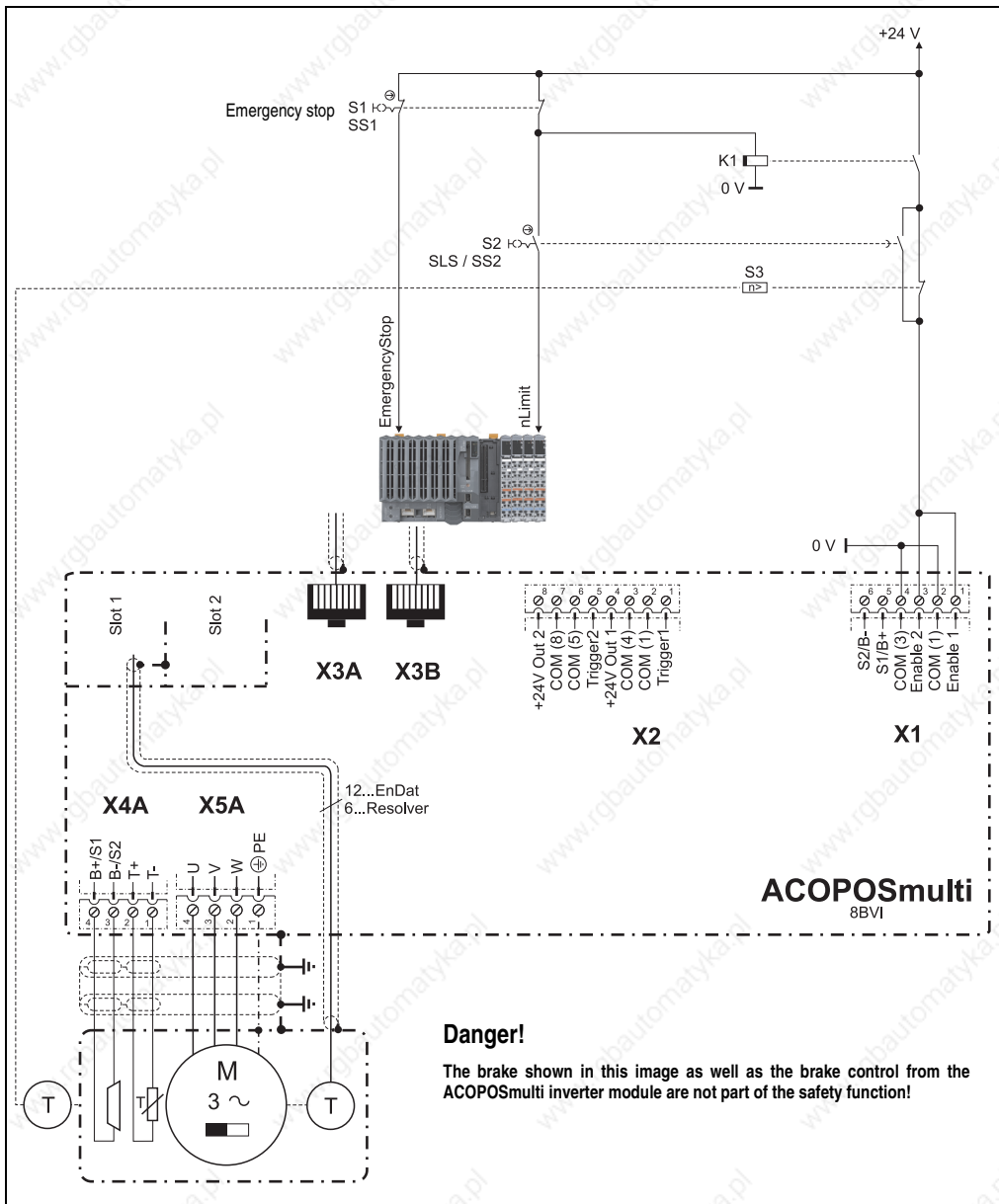


Figure 198: SS1, SLS, SS2 - Safety Category3 / SIL 2 / PL d (Variant B)

Description

SS1:

When the e-stop switch S1 is pressed, the "EmergencyStop" digital input on the controller triggers active braking (see "Code example", on page 574).

The K1 auxiliary relay with drop-out time is released after a defined amount of time. Both Enable inputs on the ACOPOSmulti inverter module are separated. As a result, the supply of power to the motor is cut off.

This guarantees that the supply of power to the motor is cut off after a defined amount of time.

Secure restart inhibit:

If you open and lock E-stop switch S1, unexpected startup is prevented.

SLS:

Opening the switch S2 will activate the safety function SLS and trigger an active braking procedure via the digital input "nLimit" on the controller (see "Code example", on page 574). After a defined amount of time, speed monitoring will be activated on the speed monitor S3. If the limit speed is exceeded, then the enable inputs of the ACOPOSmulti inverter module are cleared via the immediate switching contact of the speed gauge S3.

This guarantees that the supply of power to the motor is immediately cut off when the limit speed set on the rotation speed monitor S3 is exceeded.

SS2:

Opening the switch S2 will activate the safety function SS2 and trigger an active braking procedure via the digital input "nLimit" on the controller (see "Code example", on page 574). After a defined amount of time, standstill monitoring will be activated on the standstill monitor S3. If the tolerance limit is exceeded (standstill monitor S3 is activated), then the enable inputs of the ACOPOSmulti inverter module are cleared via the immediate switching contact of the standstill monitor S3.

This guarantees that the supply of power to the motor is immediately cut off when the standstill monitor S3 is activated.

Information about SLS and SS2:

The SLS safety function or the SS2 safety function can be implemented depending on the function of the S3 switching device (rotation speed monitor or standstill monitor).

Danger!

The S1 and S2 switches displayed require the use of two or one-pin switching devices (Category 3 / SIL 2 / PL d) with a positive opening contact according to EN 60947-5-1. A oneSafety Category switching device (Category 3 / SIL 2 / PL d) must be used for the displayed K1 relay and the S3 switching device.

The instructions in the switching device's user documentation must be followed!

Code example

Placing the stop command via POWERLINK:

```

if ( ! stop_active )
{
  /* Movement stop not active: Test stop inputs */
  if ( EmergencyStop == ncLOW )
  {
    /* Activate movement stop with parameter set for "emergency stop" */
    stop_index = E_STOP_INDEX;
    step = MOV_STOP;
    stop_active = 1;
  }
  else if ( nLimit == ncLOW )
  {
    /* Activate movement stop with parameter set for "low
    speed" */
    stop_index = NLIMIT_INDEX;
    step = MOV_STOP;
    stop_active = 1;
  }
}
else
{
  /* Movement stop was activated */
  if ( EmergencyStop == ncHIGH && nLimit == ncHIGH
      && step!= W_MOVE_STOP)
  {
    /* Movement stop completed */
    stop_active = 0;
  }
}

```

```
switch (step)
{
    ...
    case MOV_STOP:
        /* Call NC action for movement stop */
        p_ax_dat->move.stop.index.command = stop_index;

        action_status = naction(ax_obj,ncMOVE,ncSTOP);
        if ( action_status == ncOK )
        {
            step = W_MOVE_STOP;
        }
        break;

    case W_MOVE_STOP:
        /* Wait for completion of movement stop */
        if (p_ax_dat->move.mode == ncOFF)
        {
            /* Movement stop completed */
            step = <NEXT_STEP>
        }
        break;

    ...
}
```


Chapter 7 • Standards and certifications

1. Applicable European directives

- EMC directive 2004/108/CE
- Low-voltage directive 2006/95/CE
- Machine directive 2006/42/EG ¹⁾

2. Applicable standards

Standard	Description
IEC/EN 61800-2	Adjustable speed electrical power drive systems <ul style="list-style-type: none"> • Part 2: General requirements; Rating specifications for low voltage adjustable frequency AC power drive systems
IEC/EN 61800-3	Adjustable speed electrical power drive systems <ul style="list-style-type: none"> • Part 3: EMC requirements including specific test methods
IEC 61800-5-1	Electrical drive systems with adjustable speed <ul style="list-style-type: none"> • Part 5-1: Safety requirements - Electrical, thermal and power requirements (IEC 61800-5-1:2003)
EN 61800-5-2	Adjustable speed electrical power drive systems <ul style="list-style-type: none"> • Part 5-2: Safety requirements - Functional requirements
IEC/EN 61131-2	Programmable logic controllers <ul style="list-style-type: none"> • Part 2: Equipment requirements and tests
EN 60204-1	Safety of machinery - electrical equipment on machines <ul style="list-style-type: none"> • Part 1: General requirements
IEC 61508	Functional safety of electrical / electronic / programmable electronic safety-related systems
EN 50178-1	Electronic equipment for high voltage systems
EN 1037	Safety of machinery - Prevention of unexpected start-up
EN 954-1 ¹⁾	Safety of machinery - Safety-related parts of control systems <ul style="list-style-type: none"> • Part 1: General design principles
EN ISO 13849-1	Safety of machinery - Safety-related parts of control systems <ul style="list-style-type: none"> • Part 1: General design principles
EN 62061	Safety of machinery - Functional safety of safety-related electrical, electronic and programmable electronic control systems
UL 508C	Power conversion equipment

Table 319: Applicable standards for ACOPOSmulti servo drives

1) Replaced by EN ISO 13849-1.

1) This machine directive only applies to logic units for safety functions that are for the first time being placed on the market by B&R for sale or use.

Standards and certifications • Applicable standards

The limit values specified in the following section (3 "Environmental limits" to 6 "Other environmental limit values according to IEC 61800-2") are taken from the product standard EN 61800 (and IEC 61800) for servo drives in industrial environments (Category C3¹). Stricter test procedures and limit values are used during the type tests for ACOPOSmulti servo drives. Additional information is available from B&R.

1) Limit values from CISPR11, group 2, class A (second environment).

3. Environmental limits

3.1 Mechanical conditions according to EN 61800-2

3.1.1 Operation

IEC 60721-3-3, class 3M1	
	EN 61800-2
Vibration during operation $2 \leq f < 9$ Hz $9 \leq f < 200$ Hz	0.3 mm amplitude 1 m/s^2 acceleration

Table 320: Mechanical conditions during operation

3.1.2 Transport

IEC 60721-3-2, class 2M1	
	EN 61800-2
Vibration during transport ^{1) 2)} $2 \leq f < 9$ Hz $9 \leq f < 200$ Hz $200 \leq f < 500$ Hz	3.5 mm amplitude 10 m/s^2 acceleration 15 m/s^2 acceleration
Drop height in free fall ¹⁾ Weight < 100 kg	0.25 m

Table 321: Mechanical conditions during transport

1) Only valid for components in original packaging.

2) The values in table 320 "Mechanical conditions during operation", on page 579 apply to components that are not in their original packaging.

3.2 Climate conditions according to IEC 61800-2

3.2.1 Operation

IEC 60721-3-3, class 3K3	
	EN 61800-2
Ambient temperature during operation	5 to 40°C
Relative humidity during operation	5 - 85%, non-condensing

Table 322: Climate conditions during operation

3.2.2 Bearings

IEC 60721-3-1, class 1K4	
	EN 61800-2
Storage temperature	-25 to +55°C

Table 323: Climate conditions (temperature) during storage

IEC 60721-3-1, class 1K3	
	EN 61800-2
Relative humidity during storage	5 - 95%, non-condensing

Table 324: Climate conditions (humidity) during storage

3.2.3 Transport

IEC 60721-3-2, class 2K3	
	EN 61800-2
Transport temperature	-25 to +70°C
Relative humidity during transport	Max. 95% at +40°C

Table 325: Climate conditions during transport

4. Requirements for immunity to disturbances (EMC)

4.1 Evaluation criteria (performance criteria)

Criteria A Test object not influenced during test.

Criteria B Test object only temporarily influenced during test.

Criteria C The system does not reboot automatically (reset required).

4.2 Low frequency disturbances according to EN 61800-3

The following limit values are applicable for industrial environments (category C3). ¹⁾

4.2.1 Power mains harmonics and commutation notches / voltage distortions

IEC 61000-2-4, class 3		
	EN 61800-3	Performance criteria
Harmonics	THD = 10%	A
Short harmonics (< 15 s)	1.5x continuous level	B

Table 326: Limits for power mains harmonics

IEC 60146-1-1, class 3		
	EN 61800-3	Performance criteria
Commutation notches	Depth = 40%, Total area = 250% x degree	A

Table 327: Limit values for commutation notches / voltage distortions

4.2.2 Voltage changes, fluctuations, drops and short-term interruptions

IEC 61000-2-4, class 3		
	EN 61800-3	Performance criteria
Voltage changes and fluctuations	± 10%	A
Voltage changes and fluctuations (< 1 min)	+ 10% to - 15%	

Table 328: Limit values for voltage changes and fluctuations

IEC 61000-2-1		
	EN 61800-3	Performance criteria
Voltage dips and short-term interruptions	10% to 100%	C

Table 329: Limit values for voltage dips and short-term interruptions

1) Limit values from CISPR11, group 2, class A (second environment).

4.2.3 Asymmetric voltage und frequency changes

IEC 61000-2-4, class 3		
	EN 61800-3	Performance criteria
Asymmetric voltages	3% negative component	A
Frequency change and change rate	± 2%, 1%/s (+4%, 2%/s if the power supply is isolated from general power mains)	

Table 330: Limit values for asymmetric voltages and frequency changes

4.3 High frequency disturbances according to EN 61800-3

These immunity tests are valid for industry (category C3). ¹⁾

4.3.1 Electrostatic discharge

Tests according to EN 61000-4-2		
	EN 61800-3	Performance criteria
Contact discharge to powder-coated and bare metal housing parts	6 kV	B
Discharge through the air to plastic housing parts	8 kV	

Table 331: Limits for electrical discharge

4.3.2 Electromagnetic fields

Tests according to EN 61000-4-3		
	EN 61800-3	Performance criteria
Housing, completely wired	80 MHz - 1 GHz, 10 V/m, 80% amplitude modulation at 1 kHz	A

Table 332: Limits for electromagnetic fields

4.3.3 Burst

Tests according to EN 61000-4-4		
	EN 61800-3	Performance criteria
Power connection	2 kV, 1 min, direct coupling	B
Lines for measurement and control functions in the process environment	2 kV, 1 min	
Signal interfaces, other lines	1 kV, 1 min	

Table 333: Limits for burst

1) Limit values from CISPR11, group 2, class A (second environment).

4.3.4 Surge

Tests according to EN 61000-4-5		
	EN 61800-3	Performance criteria
Power connection	1 kV (2 Ω) ¹⁾ , DM, symmetrical 2 kV (12 Ω) ¹⁾ , CM, unsymmetrical	B

Table 334: Limits for surge

1) The impedance was added from EN 61000-4-5 because it is not defined in EN 61800-3.

4.3.5 High frequency conducted disturbances

Tests according to EN 61000-4-6		
	EN 61800-3	Performance criteria
Power connection	0.15 - 80 MHz, 10 V, 80% amplitude modulation at 1 kHz	A
Lines for measurement and control functions in the process environment		
Signal interfaces, other lines		

Table 335: Limits for conducted disturbances (radio frequency)

5. Requirements for emissions (EMC)

5.1 High frequency emissions according to EN 61800-3

These emission tests are valid for industry (category C3). ¹⁾

5.1.1 Conducted emissions on the power connections

Tests according to EN 55011			
Continuous current on motor	Frequency range [MHz]	Quasi-peak value	Average
$I \leq 100 \text{ A}$	$0.15 \leq f < 0.5$	100 dB (μV)	90 dB (μV)
	$0.5 \leq f < 5$	86 dB (μV)	76 dB (μV)
	$5 \leq f < 30$	90 dB (μV) Decreases with the logarithm of the frequency up to 70	80 dB (μV) Decreases with the logarithm of the frequency up to 60
$100 \text{ A} < I$	$0.15 \leq f < 0.5$	130 dB (μV)	120 dB (μV)
	$0.5 \leq f < 5$	125 dB (μV)	115 dB (μV)
	$5 \leq f < 30$	115 dB (μV)	105 dB (μV)

Table 336: Limits for conducted emissions on the power connections

5.1.2 Electromagnetic emissions

Tests according to EN 55011	
Frequency range [MHz]	Quasi-peak value
$30 \leq f \leq 230$	40 dB ($\mu\text{V}/\text{m}$), measured at distance of 30 m ¹⁾
$230 < f \leq 1000$	50 dB ($\mu\text{V}/\text{m}$), measured at distance of 30 m ¹⁾

Table 337: Limit values for electro-magnetic emissions

¹⁾ The limit values were increased by 10 dB ($\mu\text{V}/\text{m}$) when measuring from distances of 10 m.

¹⁾ Limit values from CISPR11, group 2, class A (second environment).

6. Other environmental limit values according to IEC 61800-2

EN 61800-2	
Degree of pollution according to IEC 61800-2, 4.1.2.1.	2 (non-conductive material)
Overvoltage cat. according to IEC 60364-4-443:1999	III
Protection according to IEC 60529	IP20
Reduction of the continuous current at installation altitudes over 500 m above sea level	10% per 1,000 m
Maximum installation altitude	4,000 m ¹⁾

Table 338: Additional environmental limits

1) Additional requirements are to be arranged with B&R.

7. International certifications

B&R products and services comply with applicable standards. They are international standards from organizations such as ISO, IEC and CENELEC, as well as national standards from organizations such as UL, CSA, FCC, VDE, ÖVE, etc. We give special consideration to the reliability of our products in an industrial environment.




Certifications	
USA and Canada 	All important B&R products are tested and listed by Underwriters Laboratories and checked quarterly by a UL inspector. This mark is valid for the USA and Canada and simplifies certification of your machines and systems in these areas.
Europe 	All harmonized EN standards for the applicable directives are met.
Russian Federation 	GOST-R certification is available for the export of all B&R ACOPOS servo drives to the Russian Federation.

Table 339: International Certifications

8. Standards & definitions for safety techniques

Stop Functions according to IEC 60204-1/2006 (electrical equipment for machines, part 1: general requirements)

The following three stop function categories exist:

Category	Description
0	Stop by immediately switching off the power to the machine drive elements (i.e. uncontrolled stop).
1	A controlled stop, the power to the machine drive elements remains on until the stop procedure is completed. The power is switched off after the stop is complete.
2	A controlled stop, the power to the machine drive elements is not switched off.

Table 340: Overview of stop function categories

The necessary stop functions must be determined based on a risk evaluation for the machine. Stop functions in category 0 and category 1 must be able to function regardless of the operating mode. A category 0 stop must have priority. Stop functions must have priority over assigned start functions. Resetting the stop function is not permitted to cause a dangerous state.

Emergency stops according to IEC 60204-1/2006 (electrical equipment for machines, part 1: general requirements)

The following requirements are valid for emergency stops in addition to the requirements for the stop functions:

- It must have priority over all other functions and operations in all operating modes.
- The power to the machine drive elements which can cause a dangerous state must be switched off as quickly as possible without creating other dangers.
- Resetting is not permitted to cause a restart.

Emergency stops must be category 0 or category 1 stop functions. The necessary stop function must be determined based on a risk evaluation for the machine.

For emergency stop function in stop category 0, only hard wired, electromechanical equipment can be used. Additionally, the function is not permitted to depend on electronic switching logic (hardware or software) or the transfer of commands via a communication network or data connection.

When using a category 1 stop function for the emergency stop function, it must be guaranteed that the power to the machine drive elements is completely switched off. These elements must be switched off using electromechanical equipment.

Performance Levels (PL) according to EN ISO 13849-1 (Safety of machinery – Safety-related parts of control systems, Part 1: General design principles)

The safety related parts of control systems must meet one or more of the requirements for five defined Performance Levels. The Performance Levels define the required behavior of safety related controller parts regarding their resistance to errors.

Performance Level (in accordance with EN ISO 13849-1)	Safety integrity level - SIL (in accordance with IEC 61508-2)	Short description	System behavior
a	---	Safety related parts must be designed and built so that they can meet the expected operational requirements. (No specific safety measures are implemented.)	Caution! An error can cause the safety function to fail.
b	1	Safety related parts must be designed and built so that only reliable components and safety principles are used. (e. g. preventing short circuits by using sufficient distances, reducing the probability of errors caused by using oversized components, defining the failure route - bias current fail-safe, etc.)	Caution! An error can cause the safety function to fail.
c	1	Safety related parts must be designed so that their safety functions are checked in suitable intervals by the machine controller. (e. g. automatic or manual check during start-up)	Caution! An error between checks can cause the safety function to fail. If the safety function fails, it will be recognized during the check.
d	2	Safety related parts must be designed so that individual errors do not cause the safety function to fail. Individual errors should - if possible - be recognized the next time (or before) the safety function is required.	Caution! The safety function remains active when an error occurs. Some, but not all errors are recognized. A buildup of errors can cause the safety function to fail.
e	3	Safety related parts must be designed so that individual errors do not cause the safety function to fail. Individual errors must be recognized the next time (or before) the safety function is required. If this type of recognition is not possible, a buildup of errors is not permitted to cause the safety function to fail.	Information: The safety function remains active when an error occurs. Errors are recognized in time to prevent the safety function from failing.

Table 341: Overview of Performance Levels (PL)

The suitable performance level must be selected separately for each drive system (or for each axis) based on a risk evaluation. This risk evaluation is a part of the total risk evaluation for the machine.

The following risk graph (according to EN ISO 13849-1, Appendix A) provides a simplified procedure for risk evaluation:

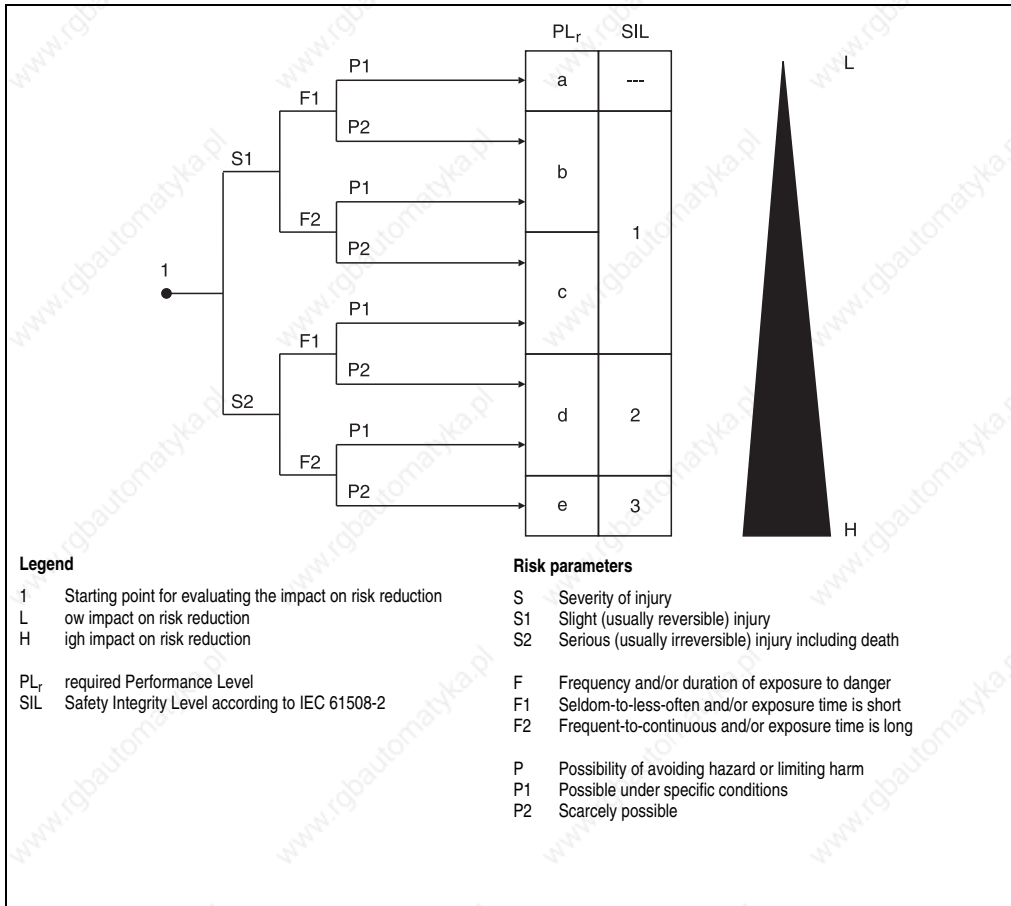


Figure 199: Risk graph for determining the PL_r for each safety function in accordance with EN ISO 13849-1, Appendix A

Begin at the starting point shown and follow the risk parameters S, F and P to the performance level to be used.

Restart inhibit according to EN 1037/04.96 (Safety of machinery - prevention of unexpected start-up)

Keeping a machine in an idle state when people are working in the danger zone is one of the most important requirements for safe operation of machines.

Starting refers to the transition of a machine or its parts from an idle state to moving state. Any start is unexpected if it is caused by:

- A start command sent because of a controller failure or because of external influences on the controller.
- A start command sent because of incorrect operation of a start element or another part of the machine.
- Restoration of power supply after an interruption.
- External/internal influences on parts of the machine.

To prevent unexpected starting of machines or parts of machines, power should be removed and dissipated. If this is not practical (e. g. frequent, short work in danger zone), other measures must be taken:

- Measures to prevent random start commands.
- Measures to prevent that random start commands cause unexpected starting.
- Measures to automatically stop dangerous parts of the machine before a dangerous situation can be caused by unexpected starting.

Figure 1:	Warning label on the ACOPOSmulti module.....	35
Figure 2:	Indicator groups for 8B0P power supply units.....	40
Figure 3:	Indicator groups for 8BVP power supply units	41
Figure 4:	Indicator groups for 8B0C auxiliary supply modules	43
Figure 5:	Indicator groups for 8BVI inverter modules (single-axis modules).....	44
Figure 6:	Indicator groups for 8BVI inverter modules (two-axis modules).....	45
Figure 7:	Indicator groups for 8BVE expansion modules	46
Figure 8:	Indicator groups for 8B0K capacitor modules	47
Figure 9:	Attaching modules.....	247
Figure 10:	Tightening the fastening screws.....	247
Figure 11:	Changing/inserting the backup battery.....	248
Figure 12:	Expansion module, installing the device fuses.....	250
Figure 13:	Expansion module - Cover plate closed.....	250
Figure 14:	Expansion module - Cover plate closed.....	251
Figure 15:	Expansion module - Cover plate removed	252
Figure 16:	Removing the fuse removal tool.....	252
Figure 17:	Using the fuse removal tool.....	253
Figure 18:	Lever out and remove the fuse.....	253
Figure 19:	Stripped cable end	257
Figure 20:	Cable ends with shielding mesh pulled back.....	257
Figure 21:	Pulling out the separately shielded signal lines.....	258
Figure 22:	Cable end without stranding elements	259
Figure 23:	Cable ends with shortened shielding mesh.....	259
Figure 24:	Attaching the shielding mesh	260
Figure 25:	Wire ends with wire tip sleeves	260
Figure 26:	Installation of shield components	261
Figure 27:	Shield set 8SCS002.0000-00.....	262
Figure 28:	Popping out the tab	262
Figure 29:	Installation of 8SCS002.0000-00.....	263
Figure 30:	Swivel range of the connector cover	264
Figure 31:	Dimension diagram and installation dimensions for 8B0F0300H000.000-1..	265
Figure 32:	Dimension diagram and installation dimensions for 8B0F0550H000.000-1..	266
Figure 33:	Dimensional diagram and installation dimensions for 8BVF0220H000.000-1, 8BVF0440H000.001-2.....	267
Figure 34:	Dimensional diagram and installation dimensions for 8BVF8800H000.000-1	268
Figure 35:	Dimensional diagram and installation dimensions for 8BVR0220H000.100-1	269
Figure 36:	Dimension diagram and installation dimensions for 8BVR0440H000.100-1.	270
Figure 37:	Dimension diagram and installation dimensions for 8BVR0880H000.100-1.	271
Figure 38:	Dimension diagram and installation dimensions - 8B0MnnnnHW00.000-1 ..	273
Figure 39:	Dimension diagram and installation dimensions for 8BxP0220HW00.000-1, 8BxP0440HW00.000-1.....	274
Figure 40:	Dimensional diagram and installation dimensions for 8BVP0880HW00.000-1...	275
Figure 41:	Dimension diagram and installation dimensions for 8B0C0160HW00.000-1, 8B0C0320HW00.000-1	276

Figure index

Figure 42:	Dimension diagram and installation dimensions for 8B0C0160HW00.001-1, 8B0C0320HW00.002-1, 8B0C0320HW00.00A-1 ..	277
Figure 43:	Dimension diagram and installation dimensions for 8BVI0014HWSx.000-1, 8BVI0028HWSx.000-1, 8BVI0055HWSx.000-1, 8BVI0110HWSx.000-1	278
Figure 44:	Dimension diagram and installation dimensions for 8BVI0014HWDx.000-1, 8BVI0028HWDx0.000-1, 8BVI0055HWDx.000-1 ...	279
Figure 45:	Dimension diagram and installation dimensions for 8BVI0220HWSx.000-1, 8BVI0440HWSx.000-1	280
Figure 46:	Dimension diagram and installation dimensions for 8BVI0220HWDx.000-1, 8BVI0220HWDx.000-1	281
Figure 47:	Dimension diagram installation dimensions for 8BVI0880HWSx.000-1	282
Figure 48:	Dimension diagram and installation dimensions - 8BVE0500HW00.000-1...	283
Figure 49:	Dimension diagram and installation dimensions for 8B0K1650HW00.000-1	284
Figure 50:	Dimension diagram and installation dimensions - 8B0MnnnnHC00.000-1 ...	285
Figure 51:	Dimension diagram and installation dimensions for 8BxP0220HC00.000-1, 8BxP0440HC00.000-1	286
Figure 52:	Dimension diagram and installation dimensions for 8BVP0880HC00.000-1	287
Figure 53:	Dimension diagram and installation dimensions for 8BVP1650HC00.000-1	288
Figure 54:	Dimensional diagram and installation dimensions for 8B0C0160HC00.000-1, 8B0C0320HC00.000-1	289
Figure 55:	Dimension diagram and installation dimensions for 8B0C0160HC00.001-1, 8B0C0320HC00.002-1, 8B0C0320HC00.00A-1	290
Figure 56:	Dimension diagram and installation dimensions for 8BVI0014HCSx.000-1, 8BVI0028HCSx.000-1, 8BVI0055HCSx.000-1, 8BVI0110HCSx.000-1	291
Figure 57:	Dimension diagram and installation dimensions for 8BVI0014HCDx.000-1, 8BVI0028HCDx.000-1, 8BVI0055HCDx.000-1	292
Figure 58:	Dimension diagram and installation dimensions for 8BVI0220HCSx.000-1, 8BVI0440HCSx.000-1	293
Figure 59:	Dimension diagram and installation dimensions for 8BVI0110HCDx.000-1, 8BVI0220HCDx.000-1	294
Figure 60:	Dimension diagram and installation dimensions for 8BVI0880HCSx.000-1..	295
Figure 61:	Dimension diagram and installation dimensions for 8BVI1650HCS0.000-1 .	296
Figure 62:	Dimension diagram and installation dimensions for 8BVE0500HC00.000-1	297
Figure 63:	Dimension diagram and installation dimensions for 8B0K1650HC00.000-1.	298
Figure 64:	Dimension diagram and installation dimensions for 8B0MnnnnHF00.000-1.	299
Figure 65:	Dimension diagram and installation dimensions for 8BxP0220HC00.000-1, 8BxP0440HC00.000-1	300
Figure 66:	Dimension diagram and installation dimensions for 8BVP0880HC00.000-1	301
Figure 67:	Dimension diagram and installation dimensions for 8BVP1650HC00.000-1	302
Figure 68:	Dimensional diagram and installation dimensions for 8B0C0160HC00.000-1, 8B0C0320HC00.000-1	304
Figure 69:	Dimension diagram and installation dimensions for 8B0C0160HC00.001-1, 8B0C0320HC00.002-1, 8B0C0320HC00.00A-1	305
Figure 70:	Dimension diagram and installation dimensions for 8BVI0014HCSx.000-1, 8BVI0028HCSx.000-1, 8BVI0055HCSx.000-1,	

	8BVI0110HCSx.000-1	306
Figure 71:	Dimension diagram and installation dimensions for 8BVI0014HCDx.000-1, 8BVI0028HCDx.000-1, 8BVI0055HCDx.000-1	307
Figure 72:	Dimension diagram and installation dimensions for 8BVI0220HCSx.000-1, 8BVI0440HCSx.000-1	308
Figure 73:	Dimension diagram and installation dimensions for 8BVI0110HCDx.000-1, 8BVI0220HCDx.000-1	309
Figure 74:	Dimension diagram and installation dimensions for 8BVI0880HCSx.000-1..	310
Figure 75:	Dimension diagram and installation dimensions for 8BVI1650HCS0.000-1 .	311
Figure 76:	Dimension diagram and installation dimensions for 8BVE0500HC00.000-1	313
Figure 77:	Dimension diagram and installation dimensions for 8B0K1650HC00.000-1.	314
Figure 78:	Dimension diagram for 8B0W0045H000.001-1, 8B0W0079H000.001-1	315
Figure 79:	Installation dimensions - 8B0W external braking resistors	316
Figure 80:	Dimension diagram and installation dimensions for 8B0M0040HFF0.000-1	317
Figure 81:	Function diagram of filter fans	318
Figure 82:	Function diagram of air/air heat exchangers	319
Figure 83:	Function diagram of air/water heat exchangers	320
Figure 84:	Placing a cooling aggregate on top of the switching cabinet.....	322
Figure 85:	Placing a cooling aggregate on the front of the switching cabinet	323
Figure 86:	Circuit diagram for ACOPOSmulti line filter, power mains connection.....	329
Figure 87:	Circuit diagram for ACOPOSmulti inverter modules, motor connection.....	336
Figure 88:	Circuit diagram 8B0P0xx0Hx00.00x-1, connection X5B (external braking resistor)	338
Figure 89:	Adding the movement and load profile for a sample application.....	340
Figure 90:	Example: Add movement and load profile.....	343
Figure 91:	Peak load capacity 8B0P0220Hx00.00x-1	345
Figure 92:	Peak load capacity 8B0P0440Hx00.00x-1	346
Figure 93:	Determining the peak load factor k.....	349
Figure 94:	Thermal equivalent circuit for the external braking resistor.....	351
Figure 95:	Schematic diagram of the cooling circuit (direct connection)	353
Figure 96:	Schematic diagram of the cooling circuit (water-water heat exchanger).....	355
Figure 97:	Schematic diagram of the cooling circuit (water-water heat exchanger).....	357
Figure 98:	Dew point temperature characteristic (installation altitude: 0 ... 500 m).....	362
Figure 99:	Basic selection of the cooling system.....	364
Figure 100:	Overview of ground/shield for ACOPOSmulti drive system (passive power supply).....	375
Figure 101:	Overview of ground/shield for ACOPOSmulti drive system (active power supply) 376	
Figure 102:	Ground connections and shield connections for 8B0F line filter	377
Figure 103:	Ground connections and shield connections for 8B0P power supply units...	378
Figure 104:	Ground connections and shield connections for 8BVF line filter	379
Figure 105:	Ground connections and shield connections for 8BVP power supply units ..	380
Figure 106:	Ground connections and shield connections for 8BVR regeneration chokes	381
Figure 107:	Ground connections and shield connections for 8B0C auxiliary supply modules 382	
Figure 108:	Ground connections and shield connections for 8BVI inverter modules.....	383
Figure 109:	Ground connections and shield connections for 8BVE expansion modules .	384

Figure index

Figure 110:	Use of the shield set 8SCS005.0000-00	385
Figure 111:	Cable shielding in DSUB housing	385
Figure 112:	Grounding the POWERLINK cable shielding	386
Figure 113:	Overview of pin assignments - 8B0F0330H000.000-1, 8B0F0550H000.000-1 .. 398	
Figure 114:	Input/output circuit diagram - 8B0F0300H000.000-1, 8B0F0550H000.000-1	400
Figure 115:	Overview of pin assignments - 8BVF0220H000.000-1, 8BVF0440H000.001-2.. 401	
Figure 116:	Input/output circuit diagram - 8BVF0220H000.000-1, 8BVF0440H000.001-2	404
Figure 117:	Overview of pin assignments - 8BVF0880H000.000-1	405
Figure 118:	Input/output circuit diagram - 8BVF0880H000.000-1	407
Figure 119:	Overview of pin assignments - 8BVR0220H000.100-1	408
Figure 120:	Input/output circuit diagram - 8BVR0220H000.100-1	409
Figure 121:	Overview of pin assignments - 8BVR0440H000.100-1	410
Figure 122:	Input/output circuit diagram - 8BVR0440H000.100-1	411
Figure 123:	Overview of pin assignments - 8BVR0880H000.100-1	412
Figure 124:	Input/output circuit diagram - 8BVR0880H000.100-1	413
Figure 125:	Overview of pin assignments - 8B0P0220Hx00.000-1, 8B0P0440Hx00.000-1 .. 414	
Figure 126:	Input/output circuit diagram - 8B0P0220Hx00.000-1, 8B0P0440Hx00.000-1	418
Figure 127:	Overview of pin assignments - 8BVP0220Hx00.000-1, 8BVP0440Hx00.000-1.. 420	
Figure 128:	Input/output diagram - 8BVP0220Hx00.000-1, 8BVP0440Hx00.000-1	425
Figure 129:	Overview of pin assignments - 8BVP0880Hx00.000-1	428
Figure 130:	Cable installation for power mains connection L1, L2, L3	431
Figure 131:	Cable installation connection PE (1 wire)	432
Figure 132:	Cable installation connection PE (3 wire)	432
Figure 133:	Input/output circuit diagram - 8BVP0880Hx00.000-1	433
Figure 134:	Overview of pin assignments - 8BVP1650HC00.000-1	436
Figure 135:	Cable installation for power mains connection L1, L2, L3	439
Figure 136:	Cable installation connection PE (1 wire)	440
Figure 137:	Cable installation connection PE (3 wire)	440
Figure 138:	Input/output circuit diagram - 8BVP1650HC00.000-1	441
Figure 139:	Overview of pin assignments - 8B0C0160Hx00.000-1, 8B0C0320Hx00.000-1 .. 444	
Figure 140:	Input/output circuit diagram - 8B0C0160Hx00.000-1, 8B0C0320Hx00.000-1	445
Figure 141:	Overview of pin assignments - 8B0C0160Hx00.001-1, 8B0C0320Hx00.002-1 .. 446	
Figure 142:	Input/output circuit diagram - 8B0C0160Hx00.001-1, 8B0C0320Hx00.002-1	448
Figure 143:	Overview of pin assignments - 8B0C0160HC00.A01-1	449
Figure 144:	Input/output circuit diagram - 8B0C0160HC00.A01-1	451
Figure 145:	Overview of pin assignments - 8B0C0320Hx00.00A-1	452

Figure 146:	Input/output circuit diagram - 8B0C0320Hx00.00A-1.....	454
Figure 147:	Overview of pin assignments 8BVI0014HxS0.000-1, 8BVI0028HxS0.000-1, 8BVI0055HxS0.000-1, 8BVI0110HxS0.000-1.....	455
Figure 148:	Input/output circuit diagram 8BVI0014HxS0.000-1, 8BVI0028HxS0.000-1, 8BVI0055HxS0.000-1, 8BVI0110HxS0.000-1.....	459
Figure 149:	Overview of pin assignments 8BVI0014HxD0.000-1, 8BVI0028HxD0.000-1, 8BVI0055HxD0.000-1	461
Figure 150:	Input/output circuit diagram - 8BVI0014HxD0.000-1, 8BVI0028HxD0.000-1, 8BVI0055HxD0.000-1	467
Figure 151:	Overview of pin assignments - 8BVI0220HxS0.000-1, 8BVI0440HxS0.000-1.... 471	475
Figure 152:	Input/output circuit diagram - 8BVI0220HxS0.000-1, 8BVI0440HxS0.000-1	475
Figure 153:	Overview of pin assignments - 8BVI0110HxD0.000-1, 8BVI0220HxD0.000-1 ... 477	483
Figure 154:	Input/output circuit diagram - 8BVI0110HxD0.000-1, 8BVI0220HxD0.000-1	483
Figure 155:	Overview of pin assignments - 8BVI0880HxS0.000-1	487
Figure 156:	Cable installation for motor connections U, V, W	491
Figure 157:	Cable installation connection PE (1 wire).....	492
Figure 158:	Cable installation connection PE (3 wire).....	492
Figure 159:	Input/output circuit diagram - 8BVI00880HxS0.000-1	493
Figure 160:	Overview of pin assignments - 8BVI1650HxS0.000-1	495
Figure 161:	Cable installation for motor connections U, V, W	499
Figure 162:	Cable installation connection PE (1 wire).....	500
Figure 163:	Cable installation connection PE (3 wire).....	500
Figure 164:	Input/output circuit diagram - 8BVI1650HxS0.000-1	501
Figure 165:	Overview of pin assignments - 8BVE0500Hx00.000-1	503
Figure 166:	Overview of pin assignments - 8B0W	506
Figure 167:	Input/output circuit diagram - EnDat 2.1 interface 8BAC0120.000-1	508
Figure 168:	Input/output circuit diagram - EnDat 2.2 interface 8BAC0120.001-2	510
Figure 169:	Input/output circuit diagram - HIPERFACE interface 8BAC0121.000-1	512
Figure 170:	Input/output circuit diagram - Resolver interface 8BAC0122.000-1	514
Figure 171:	Input/output circuit diagram - Incremental/SSI encoder interface 8BAC0123.000-1	516
Figure 172:	Connection example for cabled tracer pins with 5V supply and TTL output signals	517
Figure 173:	Input/output circuit diagram - Incremental encoder interface 8BAC0123.001-1.. 519	519
Figure 174:	Input/output circuit diagram - Incremental encoder interface 8BAC0123.002-1.. 522	522
Figure 175:	Connection example for cabled tracer pins with 24V supply and HTL output signals	523
Figure 176:	Connection example for cable-free (IR) tracer pins with 24V supply and HTL output signals	523
Figure 177:	Input/output circuit diagram - SinCos interface 8BAC0124.000-1.....	526
Figure 178:	Input/output circuit diagram - Digital I/O Interface 8BAC0130.000-1	528

Figure index

Figure 179:	Input/output circuit diagram - Digital Out interface 8BAC0130.001-1.....	530
Figure 180:	Input/output circuit diagram - Analog interface 8BAC0132.000-1	532
Figure 181:	Cable schematic - Motor cable 8BCMxxxx.1111A-0, 8BCMxxxx.1312A-0 ...	534
Figure 182:	Cable schematic - Motor cable 8BCMxxxx.1523A-0	536
Figure 183:	Cable schematic - 8BCE EnDat cable.....	538
Figure 184:	Cable schematic - 8BCF EnDat 2.2 cable.....	540
Figure 185:	Cable schematic - 8BCR resolver cables.....	542
Figure 186:	Cable schematic - 8BCS SinCos cable.....	544
Figure 187:	Cable schematic - 8BCA expansion cable	545
Figure 188:	Overview of pin assignments - 8BOM0040HFF0.000-1.....	546
Figure 189:	Block diagram of secure pulse disabling.....	550
Figure 190:	STO, Category 4 / SIL 3 / PL e (Variant A)	554
Figure 191:	STO, Category 4 / SIL 3 / PL e (Variant B)	556
Figure 192:	STO, Category 3 / SIL 2 / PL d.....	557
Figure 193:	STO, SLS, SOS - Safety Category 4 / SIL 3 / PL e.....	558
Figure 194:	SS1, SLS, SS2 - Safety Category 4 / SIL 3 / PL e (Variant A).....	560
Figure 195:	SS1, SLS, SS2 - Safety Category 4 / SIL 3 / PL e (Variant B).....	563
Figure 196:	STO, SLS, SOS - Safety category 3 / SIL 2 / PL d.....	567
Figure 197:	SS1, SLS, SS2 - Safety Category 3 / SIL 2 / PL d (Variant A).....	569
Figure 198:	SS1, SLS, SS2 - Safety Category 3 / SIL 2 / PL d (Variant B).....	572
Figure 199:	Risk graph for determining the PL _r for each safety function in accordance with EN ISO 13849-1, Appendix A.....	589

Table 1:	Manual history	21
Table 2:	Description of the safety notices used	31
Table 3:	Environmentally-friendly separation of materials.....	37
Table 4:	LED status - 8BVP power supply modules	40
Table 5:	LED status - 8BVP power supply modules	41
Table 6:	LED status - 8B0C auxiliary supply modules	43
Table 7:	LED status, 8BVI inverter modules (single-axis modules)	44
Table 8:	LED status, 8BVI inverter modules (two-axis modules)	45
Table 9:	Status LEDs - 8BVE expansion modules.....	46
Table 10:	Status LEDs - 8B0K capacitor modules	47
Table 11:	LED status RDY, RUN, ERR (8BVI, 8BVP, 8B0P).....	48
Table 12:	LED status - POWERLINK	48
Table 13:	LED status - Backup battery	49
Table 14:	Status changes when booting the operating system loader.....	49
Table 15:	Module overview - Line filter	50
Table 16:	Module overview - Regeneration chokes	50
Table 17:	Module overview - Mounting plates (wall mounting)	50
Table 18:	Module overview - Mounting plates (cold-plate mounting)	51
Table 19:	Module overview - Mounting plates (feed-through mounting)	52
Table 20:	Module overview - Power supply modules (wall mounting).....	53
Table 21:	Module overview - Power supply modules (cold-plate or feed-through mounting).. 53	
Table 22:	Module overview - Auxiliary supply modules (wall mounting)	53
Table 23:	Module overview - Auxiliary supply modules (cold-plate or feed-through mounting) 54	
Table 24:	Module overview - Single-axis modules, single-width (wall mounting).....	54
Table 25:	Module overview - Single-axis modules, single-width (cold-plate or feed-through mounting)	54
Table 26:	Module overview - Two-axis modules, double-width (wall mounting)	55
Table 27:	Module overview - Two-axis modules, double-width (cold-plate or feed-through mounting)	55
Table 28:	Module overview - Expansion modules (wall mounting)	55
Table 29:	Module overview - Expansion modules (cold-plate or feed-through mounting) ..	55
Table 30:	Module overview - Capacitor modules (wall mounting).....	56
Table 31:	Module overview - Capacitor modules (cold-plate or feed-through mounting)....	56
Table 32:	Module overview - Encoder modules	56
Table 33:	Module overview - IO modules.....	56
Table 34:	Order data - 8B0F passive line filters	57
Table 35:	Technical data - 8B0F passive line filters.....	58
Table 36:	Order data - 8BVF line filter	60
Table 37:	Required accessory - 8BVF line filters	60
Table 38:	Optional accessory - 8BVF line filters	60
Table 39:	Technical data - 8BVF line filters	61
Table 40:	Order data - 8BVR regeneration chokes.....	64
Table 41:	Technical data - 8BVR regeneration chokes.....	65
Table 42:	Order data - 8B0M mounting plates	67
Table 43:	Optional accessory - 8B0M mounting plates.....	68

Table index

Table 44:	Technical data - 8B0M mounting plates	68
Table 45:	Order data - 8B0P power supply modules	71
Table 46:	Required accessories - 8B0P power supply modules	71
Table 47:	Optional accessories - 8B0P power supply modules	71
Table 48:	Technical data - 8B0P power supply modules	72
Table 49:	Setting the POWERLINK station number.....	76
Table 50:	Order data - 8BVP power supply modules	77
Table 51:	Required accessories - 8BVP power supply modules.....	78
Table 52:	Optional accessories - 8BVP power supply modules.....	78
Table 53:	Technical data -8BVP power supply modules.....	80
Table 54:	Setting the POWERLINK station number.....	84
Table 55:	Order data - 8BVP power supply modules, 120kW.....	85
Table 56:	Required accessories - 8BVP power supply modules, 120kW	85
Table 57:	Optional accessories - 8BVP power supply modules.....	85
Table 58:	Technical data -8BVP power supply modules, 120kW	87
Table 59:	Setting the POWERLINK station number.....	91
Table 60:	Order data - 8B0C control supply units 400W.....	92
Table 61:	Required accessories for 8B0C auxiliary supply modules 400W.....	92
Table 62:	Optional accessories for auxiliary supply modules 8B0C 400W	93
Table 63:	Technical data - 8B0C control supply units 400W	93
Table 64:	Order data - 8B0C control supply units 800W.....	98
Table 65:	Required accessories for 8B0C auxiliary supply modules 800W	98
Table 66:	Optional accessories for 8B0C auxiliary supply units 800W	99
Table 67:	Technical data - 8B0C control supply units 800W	99
Table 68:	Order data - 8B0C 800W auxiliary supply module with 24V In	105
Table 69:	Required accessories - 8B0C 800W auxiliary supply module with 24V In	105
Table 70:	Optional accessories - 8B0C 800W auxiliary supply module with 24V In	105
Table 71:	Technical data - 8B0C 800W auxiliary supply modules with 24V In	106
Table 72:	Order data - 8BVI inverter modules 1.4kW ... 11kW (single-axis modules)	110
Table 73:	Required accessories for 8BVI inverter modules 1.4kW ... 11kW (single-axis modules)	110
Table 74:	Optional accessories for 8BVI inverter modules 1.4kW ... 11kW (single-axis modules)	110
Table 75:	Technical data - 8BVI inverter modules 1.4kW ... 11kW (single-axis modules)	112
Table 76:	Setting the POWERLINK station number.....	117
Table 77:	Order data - 8BVI inverter modules 1.4kW ... 5.5kW (two-axis modules).....	118
Table 78:	Required accessories for 8BVI inverter modules 1.4kW ... 5.5kW (two-axis modules)	118
Table 79:	Optional accessories for 8BVI inverter modules 1.4kW ... 5.5kW (two-axis modules)	119
Table 80:	Technical data - 8BVI inverter modules 1.4kW ... 5.5kW (two-axis modules)...	120
Table 81:	Setting the POWERLINK station number.....	125
Table 82:	Order data - 8BVI inverter modules, 16kW ... 32kW	126
Table 83:	Required accessory - 8BVI inverter modules, 16kW ... 32kW.....	126
Table 84:	Optional accessory - 8BVI inverter modules, 16kW ... 32kW.....	126
Table 85:	Technical data for inverter modules 16kW ... 32kW.....	128
Table 86:	Setting the POWERLINK station number.....	133

Table 87:	Order data - 8BVI inverter modules, 11kW ... 16kW (two-axis modules)	134
Table 88:	Required accessory - 8BVI inverter modules, 11kW ... 16kW (two-axis modules) .	134
Table 89:	Optional accessory - 8BVI inverter modules, 11kW ... 16kW (two-axis modules)...	134
Table 90:	Technical data - 8BVI inverter modules, 11kW ... 16kW (two-axis modules)....	136
Table 91:	Setting the POWERLINK station number.....	141
Table 92:	Order data - 8BVI inverter modules, 64kW	142
Table 93:	Required accessory - 8BVI inverter modules, 64kW.....	142
Table 94:	Optional accessory - 8BVI inverter modules, 64kW	142
Table 95:	Technical data - 8BVI inverter modules, 64kW	144
Table 96:	Setting the POWERLINK station number.....	149
Table 97:	Order data - 8BVI inverter modules, 120kW	150
Table 98:	Required accessory - 8BVI inverter modules, 120kW.....	150
Table 99:	Optional accessory - 8BVI inverter modules, 120kW	150
Table 100:	Technical data - 8BVI inverter modules, 120kW	152
Table 101:	Setting the POWERLINK station number.....	157
Table 102:	Order data - 8BVE expansion modules.....	158
Table 103:	Required accessories - 8BVE expansion modules	158
Table 104:	Optional accessories - 8BVE expansion modules	158
Table 105:	Technical data - 8BVE expansion modules	160
Table 106:	Order data - 8B0K capacitor modules	164
Table 107:	Optional accessory - 8B0K capacitor modules	164
Table 108:	Technical data - 8B0K capacitor modules.....	164
Table 109:	Order data - EnDat 2.1 plug-in module 8BAC0120.000-1.....	167
Table 110:	Optional accessory - EnDat 2.1 plug-in module 8BAC0120.000-1	167
Table 111:	Technical data - EnDat 2.1 plug-in module 8BAC0120.....	168
Table 112:	Order data - EnDat 2.2 plug-in module 8BAC0120.001-2.....	171
Table 113:	Required accessory - EnDat 2.2 plug-in module 8BAC0120.001-2	171
Table 114:	Technical data - EnDat 2.2 plug-in module 8BAC0120.001-2	172
Table 115:	Order data - HIPERFACE plug-in module 8BAC0121.000-1	175
Table 116:	Technical data - HIPERFACE plug-in module 8BAC0121	175
Table 117:	Order data - resolver plug-in module 8BAC0122	178
Table 118:	Optional accessory - resolver plug-in module 8BAC0122.....	179
Table 119:	Technical data - resolver plug-in module 8BAC0122.....	180
Table 120:	Monitoring functions during incremental encoder operation	183
Table 121:	Monitoring functions during SSI encoder operation	184
Table 122:	Monitoring functions during sensing device operation	184
Table 123:	Order data - Incremental/SSI encoder plug-in module 8BAC0123.000-1	185
Table 124:	Technical data - Incremental/SSI encoder plug-in module 8BAC0123.000-1 ...	185
Table 125:	Monitoring functions during incremental encoder operation	189
Table 126:	Order data - Incremental encoder plug-in module 8BAC0123.001-1	190
Table 127:	Technical data - Incremental encoder plug-in module 8BAC0123.001-1.....	190
Table 128:	Monitoring functions during incremental encoder operation	194
Table 129:	Monitoring functions during sensing device operation	195
Table 130:	Order data - Incremental encoder plug-in module 8BAC0123.002-1	195
Table 131:	Technical data - Incremental encoder plug-in module 8BAC0123.002-1.....	196

Table index

Table 132:	Order data - SinCos plug-in module 8BAC0124	198
Table 133:	Optional accessory - SinCos plug-in module 8BAC0124	199
Table 134:	Technical data - SinCos plug-in module 8BAC0124	199
Table 135:	Order data - Analog In plug-in module 8BAC0130.000-1	202
Table 136:	Required accessories for Analog In plug-in module 8BAC0130.000-1	202
Table 137:	Technical data - Analog In plug-in module 8BAC0130.000-1	203
Table 138:	Order data - Analog In plug-in module 8BAC0130.001-1	206
Table 139:	Required accessories for Analog In plug-in module 8BAC0130.001-1	206
Table 140:	Technical data - Analog In plug-in module 8BAC0130.001-1	207
Table 141:	Order data - Analog In plug-in module 8BAC0132.000-1	209
Table 142:	Required accessories for Analog In plug-in module 8BAC0132.000-1	209
Table 143:	Technical data - Analog In plug-in module 8BAC0132.000-1	210
Table 144:	Order data - 8B0W external braking resistors	212
Table 145:	Technical data - 8B0W external braking resistors	212
Table 146:	Order data - 8BCM motor cables, 1.5 mm ²	215
Table 147:	Technical data - 8BCM motor cables, 1.5 mm ²	215
Table 148:	Order data - 8BCM motor cables, 4 mm ²	217
Table 149:	Technical data - 8BCM motor cables, 4 mm ²	217
Table 150:	Order data - 8BCM 4 mm ² motor cables with motor plug, size 1.5	219
Table 151:	Technical data - 8BCM 4 mm ² motor cables with motor plug, size 1.5	219
Table 152:	Order data - 8BCM motor cables, 10 mm ²	221
Table 153:	Technical data - 8BCM motor cables, 10 mm ²	221
Table 154:	Order data - 8BCE EnDat cables	223
Table 155:	Technical data - 8BCE EnDat cables	223
Table 156:	Order data - 8BCF EnDat cables	225
Table 157:	Technical data - 8BCF EnDat 2.2 cables	225
Table 158:	Order data - 8BCR resolver cables	227
Table 159:	Technical data - 8BCR resolver cables	227
Table 160:	Order data - 8BCS SinCos cables	229
Table 161:	Technical data - 8BCS SinCos cables	229
Table 162:	Order data - 8BCA expansion cables, 1.5 mm ²	231
Table 163:	Technical data - 8BCA expansion cables, 1.5 mm ²	231
Table 164:	Order data - 8BCA expansion cables, 4 mm ²	233
Table 165:	Technical data - 8BCA expansion cables, 4 mm ²	233
Table 166:	Order data - 8BCA expansion cables, 10 mm ²	235
Table 167:	Technical data - 8BCA expansion cables, 10 mm ²	235
Table 168:	Order data - 8BPM motor plugs	238
Table 169:	Technical data - 8BPM motor plugs	239
Table 170:	Order data - 8BPE EnDat plugs	240
Table 171:	Technical data - EnDat plug 8BPE0001.0000-1	240
Table 172:	Order data - 8BPR resolver plugs	242
Table 173:	Technical data - 8BPR resolver plugs	242
Table 174:	Permissible mounting orientations for 8B0W external braking resistors	256
Table 175:	Impermissible mounting orientation for 8B0W external braking resistors	256
Table 176:	Selection of the protective ground conductor cross section	327
Table 177:	Protective ground conditions for ACOPOSmulti line filter 8BVF	328
Table 178:	Protective ground conditions for ACOPOSmulti power supply module 8BxP ...	328

Table 179:	Maximum current load v_{for} for PVC insulated three-phase cables or individual wires.	330
Table 180:	Tripping characteristics of the fuse for the power mains connection.....	331
Table 181:	Discharge capacitances C_D of ACOPOSmulti modules.....	333
Table 182:	Manufacturers of fault current protection devices that can be used.....	334
Table 183:	Checking if fault current protection devices can be used, Example 1	334
Table 184:	Checking if fault current protection devices can be used, Example 2	335
Table 185:	Maximum current load for special insulated three-phase cables	337
Table 186:	The location where the fuse for the external braking resistor connection is installed	339
Table 187:	Overview of 8B0W braking resistor data	341
Table 188:	Series and parallel connection of braking resistors.....	342
Table 189:	ParIDs for setting external braking resistor parameters	351
Table 190:	Overview of methods for removing impurities in the cooling medium	359
Table 191:	Hydrologic data	360
Table 192:	Electrochemical series, standard potential against hydrogen	361
Table 193:	Calculation of the effective switching cabinet surface A (DIN VDE 57 660 part 500 or IEC 890)	365
Table 194:	Determining the power loss in the switching cabinet	366
Table 195:	Compensation factor f depending on the switching cabinet's installation altitude ...	367
Table 196:	Determining the power loss in the switching cabinet	368
Table 197:	Determining the power loss in the switching cabinet	370
Table 198:	Determining the power loss in the switching cabinet	372
Table 199:	Terminal cross sections of the 8BVF line filter	392
Table 200:	Terminal cross sections of the 8BVR regeneration chokes.....	392
Table 201:	Clampable diameter ranges of 8B0P power supply modules.....	393
Table 202:	Terminal cross sections of the 8BVP power supply units.....	394
Table 203:	Terminal cross sections of the 8B0C auxiliary supply modules	395
Table 204:	Terminal cross sections of the 8BVI inverter modules	396
Table 205:	Terminal cross sections of the 8BVE expansion modules	397
Table 206:	Pin assignments - X1 plug 8B0F0300H000.000-1, 8B0F0550H000.000-1	399
Table 207:	Pin assignments - X2 plug 8B0F0300H000.000-1, 8B0F0550H000.000-1	399
Table 208:	Protective ground connection (PE) 8B0F0300H000.000-1, 8B0F0550H000.000-1	400
Table 209:	Pin assignments - X1 plug 8BVF0220H000.000-1, 8BVF0440H000.001-2	402
Table 210:	Pin assignments - X2 plug 8BVF0220H000.000-1, 8BVF0440H000.001-2	402
Table 211:	Pin assignments - X3 plug 8BVF0220H000.000-1, 8BVF0440H000.001-2	403
Table 212:	Additional protective ground connection (PE) 8BVF0220H000.000-1, 8BVF0440H000.001-2	403
Table 213:	Pin assignments - X1 8BVF0880H000.000-1	406
Table 214:	Pin assignments - X2 8BVF0880H000.000-1	406
Table 215:	Pin assignments - X3 plug 8BVF0880H000.000-1	406
Table 216:	Pin assignments - X1 plug 8B0P0220Hx00.000-1, 8B0P0440Hx00.000-1	415
Table 217:	Pin assignments - X3A, X3B plugs 8B0P0220Hx00.000-1, 8B0P0440Hx00.000-1	415
Table 218:	Pin assignments - X5A plug 8B0P0220Hx00.000-1, 8B0P0440Hx00.000-1	416

Table index

Table 219:	Pin assignments - X5B plug 8B0P0220Hx00.000-1, 8B0P0440Hx00.000-1	416
Table 220:	Additional protective ground connection (PE) 8B0P0220H000.000-1, 8B0P0440H000.000-1	417
Table 221:	Pin assignments - X1 plug 8BVP0220Hx00.000-1, 8BVP0440Hx00.000-1	421
Table 222:	Pin assignments - X2 plug 8BVP0220Hx00.000-1, 8BVP0440Hx00.000-1	421
Table 223:	Pin assignments - X3A, X3B plugs 8BVP0220Hx00.000-1, 8BVP0440Hx00.000-1 422	
Table 224:	Pin assignments - X4A plug 8BVP0220Hx00.000-1, 8BVP0440Hx00.000-1 ...	422
Table 225:	Pin assignments - X5A plug 8BVP0220Hx00.000-1, 8BVP0440Hx00.000-1 ...	423
Table 226:	Additional protective ground connection (PE) 8BVP0220H000.000-1, 8BVP0440H000.000-1	424
Table 227:	Pin assignments - X1 plug 8BVP0880Hx00.000-1	429
Table 228:	Pin assignments - X2 plug 8BVP0880Hx00.000-1	429
Table 229:	Pin assignments - X3A, X3B plugs 8BVP0880Hx00.000-1	430
Table 230:	Pin assignments - X4A plug 8BVP0880Hx00.000-1	430
Table 231:	Pin assignments - X5A plug 8BVP0880Hx00.000-1	431
Table 232:	Pin assignments - X1 plug 8BVP1650HC00.000-1	437
Table 233:	Pin assignments - X2 plug 8BVP1650HC00.000-1	437
Table 234:	Pin assignments - X3A, X3B plugs 8BVP1650HC00.000-1	438
Table 235:	Pin assignments - X4A plug 8BVP1650HC00.000-1	438
Table 236:	Pin assignments - Plug 8BVP1650HC00.000-1	439
Table 237:	Pin assignments - X1 plug 8B0C0160Hx00.000-1, 8B0C0320Hx00.000-1	445
Table 238:	Pin assignments - X1 plug 8B0C0160Hx00.001-1, 8B0C0320Hx00.002-1	447
Table 239:	Pin assignments - X2 plug 8B0C0160Hx00.001-1, 8B0C0320Hx00.002-1	447
Table 240:	Pin assignments - X3 plug 8B0C0160Hx00.001-1, 8B0C0320Hx00.002-1	447
Table 241:	Pin assignments - X1 plug 8B0C0160HC00.A01-1	450
Table 242:	Pin assignments - X2 plug 8B0C0160HC00.A01-1	450
Table 243:	Pin assignments - X3 plug 8B0C0160HC00.A01-1	450
Table 244:	Pin assignments - X1 plug 8B0C0320Hx00.00A-1	453
Table 245:	Pin assignments - X2 plug 8B0C0320Hx00.00A-1	453
Table 246:	Pin assignments - X3 plug 8B0C0320Hx00.00A-1	453
Table 247:	Pin assignments - X1 plug 8BVI0014HxS0.000-1, 8BVI0028HxS0.000-1, 8BVI0055HxS0.000-1, 8BVI0110HxS0.000-1	456
Table 248:	Pin assignments - X2 plug 8BVI0014HxS0.000-1, 8BVI0028HxS0.000-1, 8BVI0055HxS0.000-1, 8BVI0110HxS0.000-1	457
Table 249:	Pin assignments - X3A, X3B plugs 8BVI0014HxS0.000-1, 8BVI0028HxS0.000-1, 8BVI0055HxS0.000-1, 8BVI0110HxS0.000-1	457
Table 250:	Pin assignments - X4A plug 8BVI0014HxS0.000-1, 8BVI0028HxS0.000-1, 8BVI0055HxS0.000-1, 8BVI0110HxS0.000-1	458
Table 251:	Pin assignments - X5A plug 8BVI0014HxS0.000-1, 8BVI0028HxS0.000-1, 8BVI0055HxS0.000-1, 8BVI0110HxS0.000-1	458
Table 252:	Pin assignments - X1 plug	

Table 253:	8BVI0014HxD0.000-1, 8BVI0028HxD0.000-1, 8BVI0055HxD0.000-1 462 Pin assignments - X2 plug 8BVI0014HxD0.000-1, 8BVI0028HxD0.000-1, 8BVI0055HxD0.000-1 463
Table 254:	Pin assignments - X3A, X3B plugs 8BVI0014HxD0.000-1, 8BVI0028HxD0.000-1, 8BVI0055HxD0.000-1 463
Table 255:	Pin assignments - X4A plug 8BVI0014HxD0.000-1, 8BVI0028HxD0.000-1, 8BVI0055HxD0.000-1 464
Table 256:	Pin assignments - X4B plug 8BVI0014HxD0.000-1, 8BVI0028HxD0.000-1, 8BVI0055HxD0.000-1 465
Table 257:	Pin assignments - X5A plug 8BVI0014HxD0.000-1, 8BVI0028HxD0.000-1, 8BVI0055HxD0.000-1 466
Table 258:	Pin assignments - X5B plug 8BVI0014HxD0.000-1, 8BVI0028HxD0.000-1, 8BVI0055HxD0.000-1 466
Table 259:	Pin assignments - X1 plug 8BVI0220HxS0.000-1, 8BVI0440HxS0.000-1 472
Table 260:	Pin assignments - X2 plug 8BVI0220HxS0.000-1, 8BVI0440HxS0.000-1 473
Table 261:	Pin assignments - X3A, X3B plugs 8BVI0220HxS0.000-1, 8BVI0440HxS0.000-1. 473
Table 262:	Pin assignments - X4A plug 8BVI0220HxS0.000-1, 8BVI0440HxS0.000-1 474
Table 263:	Pin assignments - X5A plug 8BVI0220HxS0.000-1, 8BVI0440HxS0.000-1 474
Table 264:	Pin assignments - X1 plug 8BVI0110HxD0.000-1, 8BVI0220HxD0.000-1 478
Table 265:	Pin assignments - X2 plug 8BVI0110HxD0.000-1, 8BVI0220HxD0.000-1 479
Table 266:	Pin assignments - X3A, X3B plugs 8BVI0110HxD0.000-1, 8BVI0220HxD0.000-1. 479
Table 267:	Pin assignments - X4A plug 8BVI0110HxD0.000-1, 8BVI0220HxD0.000-1 480
Table 268:	Pin assignments - X4B plug 8BVI0110HxD0.000-1, 8BVI0220HxD0.000-1 481
Table 269:	Pin assignments - X5A plug 8BVI0110HxD0.000-1, 8BVI0220HxD0.000-1 482
Table 270:	Pin assignments - X5B plug 8BVI0110HxD0.000-1, 8BVI0220HxD0.000-1 482
Table 271:	Pin assignments - X1 plug 8BVI0880HxS0.000-1 488
Table 272:	Pin assignments - X2 plug 8BVI0880HxS0.000-1 489
Table 273:	Pin assignments - X3A, X3B plugs 8BVI0880HxS0.000-1 489
Table 274:	Pin assignments - X4A plug 8BVI0880HxS0.000-1 490
Table 275:	Pin assignments - X5A plug 8BVI0880HxS0.000-1 491
Table 276:	Pin assignments - X1 plug 8BVI1650HxS0.000-1 496
Table 277:	Pin assignments - X2 plug 8BVI1650HxS0.000-1 497
Table 278:	Pin assignments - X3A, X3B plugs 8BVI1650HxS0.000-1 497
Table 279:	Pin assignments - X4A plug 8BVI1650HxS0.000-1 498
Table 280:	Pin assignments - X5A plug 8BVI1650HxS0.000-1 499
Table 281:	Pin assignments - X2 plug 8BVE0500Hx00.000-1 504
Table 282:	Pin assignments - X3A plug 8BVE0500Hx00.000-1 504
Table 283:	Pin assignments - X3B plug 8BVE0500Hx00.000-1 504
Table 284:	Pin assignments - X4A plug 8BVE0500Hx00.000-1 505
Table 285:	Pin assignments - X4B plug 8BVE0500Hx00.000-1 505
Table 286:	Pin assignments - EnDat 2.1 interface 8BAC0120.000-1 507
Table 287:	Pin assignments - EnDat 2.2 interface 8BAC0120.001-2 509
Table 288:	Pin assignments - HIPERFACE interface 8BAC0121.000-1 511
Table 289:	Pin assignments - Resolver interface 8BAC0122.000-1 513
Table 290:	Pin assignments - Incremental/SSI encoder interface 8BAC0123.000-1 515

Table index

Table 291:	Pin assignments - Incremental encoder interface 8BAC0123.001-1.....	518
Table 292:	Possible configurations of the pull-up and pull-down resistances in the module	520
Table 293:	Configuration of wire break monitoring for encoders with push or pull outputs.	520
Table 294:	Pin assignments - Incremental encoder interface 8BAC0123.002-1.....	521
Table 295:	Possible configurations of the pull-up and pull-down resistances in the module	524
Table 296:	Configuration of wire break monitoring for encoders with push or pull outputs.	524
Table 297:	Pin assignments - SinCos interface 8BAC0124.000-1.....	525
Table 298:	Pin assignments - Digital I/O Interface 8BAC0130.000-1	527
Table 299:	Pin assignments - Digital Out Interface 8BAC0130.001-1	529
Table 300:	Pin assignments - Analog interface 8BAC0132.000-1	531
Table 301:	Construction - Motor cable 8BCMxxxx.1111A-0, 8BCMxxxx.1312A-0.....	533
Table 302:	Pin assignments - Motor cable 8BCMxxxx.1111A-0, 8BCMxxxx.1312A-0	533
Table 303:	Construction - Motor cable 8BCMxxxx.1523A-0	535
Table 304:	Pin assignments - Motor cable 8BCMxxxx.1523A-0	535
Table 305:	Construction - 8BCE EnDat cable.....	537
Table 306:	Pin assignments - 8BCE EnDat cable.....	537
Table 307:	Construction - 8BCF EnDat 2.2 cable	539
Table 308:	Pin assignments - 8BCF EnDat 2.2 cable.....	539
Table 309:	Construction - 8BCR resolver cables	541
Table 310:	Pin assignments - 8BCR resolver cables.....	541
Table 311:	Construction - 8BCS SinCos cable	543
Table 312:	Pin assignments - 8BCS SinCos cable	543
Table 313:	Construction - 8BCA expansion cable	545
Table 314:	Pin assignments - X1 plug 8B0M0040HFF0.000-1	547
Table 315:	Pin assignments - X2 8B0M0040HFF0.000-1	547
Table 316:	Safety classifications, criteria and characteristics for safe pulse disabling	548
Table 317:	Overview of safety functions according to standard.....	549
Table 318:	List of possible errors	554
Table 319:	Applicable standards for ACOPOSmulti servo drives	577
Table 320:	Mechanical conditions during operation.....	579
Table 321:	Mechanical conditions during transport.....	579
Table 322:	Climate conditions during operation.....	580
Table 323:	Climate conditions (temperature) during storage	580
Table 324:	Climate conditions (humidity) during storage	580
Table 325:	Climate conditions during transport.....	580
Table 326:	Limits for power mains harmonics.....	581
Table 327:	Limit values for commutation notches / voltage distortions.....	581
Table 328:	Limit values for voltage changes and fluctuations.....	581
Table 329:	Limit values for voltage dips and short-term interruptions.....	581
Table 330:	Limit values for asymmetric voltages and frequency changes	582
Table 331:	Limits for electrical discharge	582
Table 332:	Limits for electromagnetic fields.....	582
Table 333:	Limits for burst.....	582
Table 334:	Limits for surge.....	583
Table 335:	Limits for conducted disturbances (radio frequency)	583

Table 336:	Limits for conducted emissions on the power connections	584
Table 337:	Limit values for electro-magnetic emissions.....	584
Table 338:	Additional environmental limits.....	585
Table 339:	International Certifications.....	586
Table 340:	Overview of stop function categories	587
Table 341:	Overview of Performance Levels (PL)	588

Numbers

8B0F line filters	57
8B0K capacitor modules	164
8B0M mounting plates	67
8B0P power supply modules	71
Additional protective ground connection (PE)	417
8B0W braking resistors	212
8BCA expansion cable	
Cable schematic	545
Construction	545
8BCE EnDat cable	
Cable schematic	538
Construction	537
8BCF EnDat 2.2 cable	
Cable schematic	540
Construction	539
8BCM motor cable	
Assembly	257
Cable schematic	534, 536
Construction	533
8BCR resolver cable	
Construction	541
8BCS SinCos cables	
Cable schematic	544
Construction	543
8BVE expansion modules	158
Install device fuses	250
8BVF line filter	60
Additional protective ground connection (PE)	403
8BVI inverter modules	
Single-axis module, 8x width	150
Single-axis modules, double-width	126
Single-axis modules, quadruple width	142
Single-axis modules, single-width	110
Two-axis modules, double-width	134
Two-axis modules, single-width	118
8BVP power supply modules	77, 85
8BVP power supply units	
Additional protective ground connection (PE)	424
8BVR regeneration chokes	64

A

ACOPOSMulti	
Cables	
See Cables	
Dimensioning	325
Dimensions	264
Indicators	40
Installation	245, 373
Installation dimensions	264
Plugs	
see Connectors	
Wiring	373

B

Backup battery	
Change	248
Bearings	33
Braking resistor	338

C

Cables	
8BCM motor cable	215
Encoder Cables	
EnDat	223
Encoder cables	
EnDat 2.2	225
Resolvers	227
SinCos	229
Expansion cable	231
General information	214
Certifications	586
Clampable diameter ranges	392
Cold-plate	
Connection of supply and return lines	246
Cooling systems in switching cabinets	318

D

Danger warning	31
Dimensioning	
Braking resistor	338
Calculation basics	340
Example	343

Index

Motor connector	336	8BAC0130.000-1	204
Power mains connection	325	8BAC0130.001-1	208
Protective ground connection (PE) ...	327	8BAC0132.000-1	211
Discharge capacitance	333	ACOPOSmulti modules	40
E		Input/output circuit diagram	
Electromagnetic compatibility of the installation	373	8B0F0300H000.000-1	400
Encoder cables		8B0F0550H000.000-1	400
EnDat	223	8B0P0220H00.000-1	418
EnDat 2.2	225	8B0P0440H00.000-1	418
Resolvers	227	8BAC0120.000-1	508
SinCos	229	8BAC0120.001-2	510
Environmentally-friendly disposal	37	8BAC0121.000-1	512
ESD	32	8BAC0122.000-1	514
External braking resistor		8BAC0123.000-1	516
Location where the fuse is installed	339	8BAC0123.001-1	519
Thermal equivalent circuit	351	8BAC0123.002-1	522
		8BAC0124.000-1	526
F		8BAC0130.000-1	528
Fault current protection	332	8BAC0130.001-1	530
Functional safety		8BAC0132.000-1	532
Specifications	37	8BVF0220H000.000-1	404
		8BVF0440H000.000-1	404
G		8BVF0880H000.000-1	407
Guidelines	577	8BVI0014HxD0.000-1	467
Guidelines for ESD handling	33	8BVI0014HxS0.000-1	459
		8BVI0028HxD0.000-1	467
		8BVI0028HxS0.000-1	459
		8BVI0055HxD0.000-1	467
		8BVI0055HxS0.000-1	459
		8BVI0110HxD0.000-1	483
		8BVI0110HxS0.000-1	459
		8BVI0220HxD0.000-1	483
		8BVI0220HxS0.000-1	475
		8BVI0440HxS0.000-1	475
		8BVI0880HxS0.000-1	493
		8BVI1650HxS0.000-1	501
		8BVP0220H00.000-1	425
		8BVP0440H00.000-1	425
		8BVP0880Hx00.000-1	433
		8BVP1650Hx00.000-1	441
		8BVR0220H000.100-1	409
		8BVR0440H000.100-1	411
		8BVR0880H000.100-1	413
		Installation	34, 245, 373
		Installation dimensions	264
		Cold-plate installation	285
		Feed-through mounting	299
I			
Indicators	40		
8BAC0120.000-1	169		
8BAC0120.001-2	173		
8BAC0121.000-1	177		
8BAC0122.000-1	181		
8BAC0123.000-1	187		
8BAC0123.001-1	192		
8BAC0123.002-1	197		
8BAC0124.000-1	201		

Wall mounting	273
Isolation test	387

M

Manual history	21
Motor connector	336
Mounting guidelines	
8B0M mounting plates	245
8B0W braking resistors	255
8BVE expansion modules	250
ACOPOSmulti modules	247
General information	245
Shield component sets	262

O

Order data	
8B0C auxiliary supply modules 92, 98, 105	
8B0F line filters	57
8B0K capacitor modules	164
8B0M mounting plates	67
8B0P power supply modules	71
8B0W braking resistors	212
8BVE expansion modules	158
8BVF line filter	60
8BVI inverter modules	
Single-axis module, 8x width	150
Single-axis modules, double-width ...	126
Single-axis modules, quadruple width ...	142
Single-axis modules, single-width	110
Two-axis modules, double-width	134
Two-axis modules, single-width	118
8BVP power supply modules	77, 85
8BVR regeneration chokes	64
Cables	
8BCA expansion cable	231, 233, 235
8BCE EnDat cable	223
8BCF EnDat 2.2 cable	225
8BCM motor cable	215, 217, 219, 221
8BCR resolver cables	227
8BCS SinCos cables	229
Plug-in modules	
Analog In	209
Digital I/O	202

Digital Out	206
EnDat 2.1	167
EnDat 2.2	171
HIPERFACE	175
Incremental encoder	190, 195
Incremental encoders, SSI encoders	185
Resolvers	178
SinCos	198
Plugs	
8BPE EnDat plug	240
8BPM motor plug	238
8BPR resolver plugs	242

P

Performance Level	588
Pin assignments	
8B0C auxiliary supply modules	444
8B0F line filters	398
8B0P power supply modules	414
8BAC0120.000-1	507
8BAC0120.001-2	509
8BAC0121.000-1	511
8BAC0122.000-1	513
8BAC0123.000-1	515
8BAC0123.001-1	518
8BAC0123.002-1	521
8BAC0124.000-1	525
8BAC0130.000-1	527
8BAC0130.001-1	529
8BAC0132.000-1	531
8BCE EnDat cable	537
8BCF EnDat 2.2 cable	539
8BCM motor cable	533, 535
8BCR resolver cable	541
8BCS SinCos cables	543
8BVF line filter	401
8BVI inverter modules	
Single-axis module, 8x width	495
Single-axis modules, double-width ...	471
Single-axis modules, quadruple width ...	487
Single-axis modules, single-width	455
Two-axis modules, double-width	477
Two-axis modules, single-width	461
8BVP power supply units	420
Cables	533

Plug-in modules	
Analog In	209
Digital I/O	202
Digital Out	206
EnDat 2.1	166
EnDat 2.2	170
HIPERFACE	174
Incremental encoder	188, 193
Incremental/SSI encoder	182
Resolvers	178
SinCos	198
Plugs	
8BPE encoder plug	240
8BPM motor plug	238
8BPR resolver plugs	242
General information	237
Power mains connection	325
POWERLINK	
Setting the station node number	
8B0P power supply modules	76
8BVI inverter modules	117
8BVP power supply modules	84
Protective ground connection (PE)	400
R	
Resolverkabel 8BCR	
Kabelplan	542
Restart inhibit	587
Risk evaluation	589
S	
Safety notices	31
SCCR	326
Secure restart inhibit	587
Servo drives	
Bearings	33
Danger warning	31
Installation	34
Safety notices	31
Transport	33
Shield connection	377
Standards	577
Status LEDs	
8B0C auxiliary supply modules	43
8B0K capacitor modules	47
8B0P power supply modules	40
8BVE expansion modules	46
8BVI inverter modules	44
8BVP power supply modules	41
T	
Technical data	
8B0C auxiliary supply modules	
400 W	93
800 W	99
800 W with 24V In	106
8B0F line filters	58
8B0K capacitor modules	164
8B0M mounting plates	68
8B0P power supply modules	72
8B0W braking resistors	212
8BCA expansion cable	
1.5 mm ²	231
10 mm ²	235
4 mm ²	233
8BCE EnDat cable	223
8BCF EnDat 2.2 cable	225
8BCM motor cable	
1.5 mm ²	215
10 mm ²	221
4 mm ²	217, 219
8BCR resolver cables	227
8BCS SinCos cables	229
8BPE EnDat plug	240
8BPM motor plug	239
8BPR resolver plugs	242
8BVE expansion modules	160
8BVF line filter	61
8BVI inverter modules	
Single-axis module, 8x width	152
Single-axis modules, double-width ...	128
Single-axis modules, quadruple width ...	144
Single-axis modules, single-width	112
Two-axis modules, double-width	136
Two-axis modules, single-width	120
8BVP power supply modules	
2x width	80
4x width	80
8x width	87

8BVR regeneration chokes	65	8BVF line filter	392
Terminal cross sections		8BVI inverter modules	396
8BAC0130.000-1	527	8BVP power supply units	394
8BAC0130.001-1	529	8BVR regeneration chokes	392
8BAC0132.000-1	531	Thermal equivalent circuit	351
ACOPOSmulti modules	392	Transport	33
Terminal screw holding torque			
8B0C auxiliary supply modules	395	W	
8B0F line filters	399	Wiring	373
8B0P power supply modules	393	Overview	
8BAC0130.000-1	527	Active power supply	376
8BAC0130.001-1	529	Passive power supply	375
8BAC0132.000-1	531		
8BVE expansion modules	397		

8

8B0C0160HC00.000-1	92	8BCA01X5.1312A-0	233
8B0C0160HC00.001-1	92	8BCA01X5.1513A-0	235
8B0C0160HC00.A01-1	98	8BCE0005.1111A-0	223
8B0C0160HW00.000-1	92	8BCE0007.1111A-0	223
8B0C0160HW00.001-1	92	8BCE0010.1111A-0	223
8B0C0160HW00.A01-1	98	8BCE0015.1111A-0	223
8B0C0320HC00.000-1	98, 105	8BCE0020.1111A-0	223
8B0C0320HC00.002-1	98	8BCE0025.1111A-0	223
8B0C0320HW00.000-1	98, 105	8BCF0005.1221B-0	171, 225
8B0C0320HW00.002-1	98	8BCF0007.1221B-0	171, 225
8B0F0300H000.000-1	57	8BCF0010.1221B-0	171, 225
8B0F0550H000.000-1	57	8BCF0015.1221B-0	171, 225
8B0K1650HC00.000-1	164	8BCF0020.1221B-0	172, 225
8B0K1650HW00.000-1	164	8BCF0025.1221B-0	172, 225
8B0M0040HFF0.000-1	68	8BCM0005.1111A-0	215
8B0MnnnnHC00.000-1	67	8BCM0005.1312A-0	217
8B0MnnnnHF00.000-1	67	8BCM0005.1322A-0	219
8B0MnnnnHW00.000-1	67	8BCM0005.1523A-0	221
8B0P0220HC00.000-1	71	8BCM0007.1111A-0	215
8B0P0220HW00.000-1	71	8BCM0007.1312A-0	217
8B0P0440HC00.000-1	71	8BCM0007.1322A-0	219
8B0P0440HW00.000-1	71	8BCM0007.1523A-0	221
8B0W0045H000.001-1	212	8BCM0010.1111A-0	215
8B0W0079H000.001-1	212	8BCM0010.1312A-0	217
8BAC0120.000-178, 85, 110, 119, 126, 134, 142, 150, 167, 175		8BCM0010.1322A-0	219
8BAC0120.001-278, 85, 110, 119, 126, 134, 142, 150, 171		8BCM0010.1523A-0	221
8BAC0122.000-178, 85, 110, 119, 126, 134, 142, 150, 178, 185, 190		8BCM0015.1111A-0	215
8BAC0123.000-1	515	8BCM0015.1312A-0	217
8BAC0123.001-1	518	8BCM0015.1322A-0	219
8BAC0123.002-1	195, 521	8BCM0015.1523A-0	221
8BAC0124.000-178, 86, 110, 111, 119, 126, 127, 134, 135, 142, 143, 150, 151, 198, 209		8BCM0020.1111A-0	215
8BAC0130.000-1	202	8BCM0020.1312A-0	217
8BAC0130.001-1	206	8BCM0020.1322A-0	219
8BAC0132.000-1	527, 529, 531	8BCM0020.1523A-0	221
8BCA0003.1111A-0	231	8BCM0025.1111A-0	215
8BCA0003.1312A-0	233	8BCM0025.1312A-0	217
8BCA0003.1513A-0	235	8BCM0025.1322A-0	219
8BCA0005.1111A-0	231	8BCM0025.1523A-0	221
8BCA0005.1312A-0	233	8BCR0005.1111A-0	179, 227
8BCA0005.1513A-0	235	8BCR0007.1111A-0	179, 227
8BCA01X5.1111A-0	231	8BCR0010.1111A-0	179, 227
		8BCR0015.1111A-0	179, 227
		8BCR0020.1111A-0	179, 227
		8BCR0025.1111A-0	179, 227
		8BCS0005.1111A-0	199, 229
		8BCS0007.1111A-0	199, 229
		8BCS0010.1111A-0	199, 229

Model number index

8BCS0015.1111A-0.....	199, 229	8BVR0880H000.000-1	64
8BCS0020.1111A-0.....	199, 229	8BXF001.0000-00 ...	72, 79, 86, 93, 99, 105, 111, 119, 127, 135, 143, 151, 159, 164
8BCS0025.1111A-0.....	199, 229	8BXF002.0000-00	68
8BPE0001.0000-00	240	8BXS000.0000-00	158
8BPM0001.0000-00	238	8BXS001.0000-00	158
8BPM0002.0000-00	238	8BXS002.0000-00	158
8BPM0003.0000-00	238	8BXS003.0000-00	158
8BPR0001.0000-00	242	8BXS004.0000-00	158
8BVE0500HC00.000-1	158	8BZ0C016000.001-1A.....	92
8BVE0500HW00.000-1	158	8BZ0C032000.000-1	92
8BVF0220H000.000-1	60	8BZ0C032000.000-1A.....	98
8BVF0440H000.001-2	60	8BZ0C032000.002-1A.....	98
8BVF0880H000.001-1	60	8BZ0C032000.00A-1A	105
8BVI0014HCD0.000-1	118	8BZ0P044000.000-1A.....	71
8BVI0014HCS0.000-1	110	8BZVE050000.000-1A.....	158
8BVI0014HWD0.000-1	118	8BZVF044000.001-2A.....	60
8BVI0014HWS0.000-1	110	8BZVF088000.000-1A.....	60
8BVI0028HCD0.000-1	118	8BZVI0055D0.000-1A	118
8BVI0028HCS0.000-1	110	8BZVI0055S0.000-1A.....	110
8BVI0028HWD0.000-1	118	8BZVI0110D0.000-1A	134
8BVI0028HWS0.000-1	110	8BZVI0110S0.000-1A.....	110
8BVI0055HCD0.000-1	118	8BZVI0220S0.000-1A.....	126
8BVI0055HCS0.000-1	110	8BZVI0440S0.000-1A.....	126
8BVI0055HWD0.000-1	118	8BZVI1650S0.000-1A.....	142, 150
8BVI0055HWS0.000-1	110	8BZVP044000.000-1A.....	78
8BVI0110HCD0.000-1	134	8BZVP165000.000-1A.....	78, 85
8BVI0110HCS0.000-1	110	8SCS000.0000-00..	111, 119, 127, 135, 159
8BVI0110HWD0.000-1	134	8SCS001.0000-00.....	79, 86, 143, 151
8BVI0110HWS0.000-1	110	8SCS002.0000-0071, 79, 86, 111, 119, 127,	135, 143, 151
8BVI0220HCD0.000-1	134	8SCS003.0000-00.....	79, 86, 143, 151
8BVI0220HCS0.000-1	126	8SCS004.0000-00.....	79, 86, 143, 151
8BVI0220HWD0.000-1	134	8SCS005.0000-00....	79, 86, 111, 119, 127, 135,
8BVI0220HWS0.000-1	126	8SCS007.0000-00	72, 79, 127
8BVI0330HCS0.000-1	126	8SCS008.0000-00.....	72, 79, 127
8BVI0330HWS0.000-1	126	8SCS009.0000-00..	111, 119, 127, 135, 159
8BVI0440HCS0.000-1	126	8TB1110.20B-00	209
8BVI0440HWS0.000-1	126	8TB1110.20C-00	206
8BVI0880HCS0.000-1	142, 150	8TB1110.20D-00	202
8BVI0880HWS0.000-1	142	8TB1110.21B-00	209
8BVP0220HC00.000-1	77, 85	8TB1110.21C-00	206
8BVP0220HW00.000-1	77	8TB1110.21D-00	202
8BVP0440HC00.000-1	77	8TB2104.2010-00.....	93, 99, 105, 159
8BVP0440HW00.000-1	77	8TB2104.203F-00.....	120, 135
8BVP0880HC00.000-1	77	8TB2104.203L-00..	111, 120, 127, 128, 135,
8BVP0880HW00.000-1	77		
8BVR0220H000.100-1.....	64		
8BVR0440H000.100-1.....	64		

143, 151
 8TB2104.204A-00..... 78, 85
 8TB2106.2010-00....71, 78, 85, 93, 99, 105,
 111, 127, 143, 151
 8TB2108.2010-0078, 85, 111, 119, 127, 135,
 143, 151
 8TB2112.2010-00 119, 135
 8TB3102.201C-10 159
 8TB3102.203C-10 159
 8TB3104.201M-1093, 98, 99, 105

8TB3104.204G-00..... 111, 120, 136
 8TB3104.204K-00120, 136
 8TB4103.202A-00 71
 8TB4104.202L-10..... 71, 78

X

X67CA0P00.0002..... 68
 X67CA0P20.xxxx..... 68

MAACPM-ENG